



Publication Year	2011
Acceptance in OA @INAF	2023-01-24T13:13:38Z
Title	JUNO Jiram operations - interface control document
Authors	CICCHETTI, ANDREA; NOSCHESE, RAFFAELLA
Handle	http://hdl.handle.net/20.500.12386/33037

		Data 01/06/2011 Issue 5 Revision 0 Page 1 of 72
	JUNO/JIRAM	

JUNO

JIRAM Operations - Interface Control Document -

OLD CATALOGUE:

JIR-IFSI-UR-002-2010/ ISSUE 5 / REVISION 0

PREPARED by : A. Cicchetti, R. Noschese

CHECKED by : Claudio Pasqui

APPROVED by : A. Coradini, A. Adriani

		Data 01/06/2011 Issue 5 Revision 0 Page 2 of 72
	JUNO/JIRAM	

TABLE OF CONTENTS

1	PURPOSE OF THIS DOCUMENT	9
2	JIRAM INSTRUMENT DESCRIPTION	10
2.1	SCIENCE OBJECTIVES	11
3	JIRAM ATOMIC SEQUENCES DEFINITION	12
3.1	JIRAM POWER ON SEQUENCE	12
3.1.1	<i>Activity Description</i>	14
3.1.2	<i>SASF Sequence Implementation (Particular Case)</i>	14
3.2	JIRAM SW MAINTENANCE “DOWNLOAD MEMORY”	15
3.2.1	<i>Activity Description</i>	16
3.3	JIRAM SW MAINTENANCE “CHECK MEMORY”	17
3.3.1	<i>Activity Description</i>	18
3.4	JIRAM SW MAINTENANCE “UPLOAD MEMORY”	19
3.4.1	<i>Activity Description</i>	20
3.5	JIRAM GOES TO STANDBY	21
3.5.1	<i>Activity Description</i>	22
3.6	JIRAM GOES TO SAFE	23
3.6.1	<i>Activity Description</i>	24
3.7	JIRAM CALIBRATION SESSION	25
3.7.1	<i>Activity Description</i>	26
3.8	JIRAM SCIENCE SESSION.....	27
3.8.1	<i>Activity Description</i>	28
3.9	JIRAM UPLOAD SP PARAMETERS	29
3.9.1	<i>Activity Description</i>	30
3.10	JIRAM GET SP PARAMETERS	31
3.10.1	<i>Activity Description</i>	32
3.11	JIRAM RESTORE SP PARAMETER.....	33
3.11.1	<i>Activity Description</i>	34
3.12	JIRAM COMMAND MOTOR MODE (ONLY IN FLIGHT MODE)	35
3.12.1	<i>Activity Description</i>	36
3.13	JIRAM COMMAND CALIBRATION SOURCE (ONLY IN FLIGHT MODE)	37
3.13.1	<i>Activity Description</i>	38

3.14	JIRAM DETECTORS SETTABLE PARAMETER	39
3.14.1	Activity Description	40
3.15	JIRAM POWER OFF SEQUENCE	41
3.15.1	Activity Description	42
4	JIRAM EXAMPLE OF ROUTINE OBSERVATION	43
5	JIRAM TELE-COMMANDS IMPLEMENTATION ARCHITECTURE	44
5.1	JIRAM_TC_UPLOAD_MEM	44
5.1.1	Example of Load File	44
5.2	JIRAM_TC_DOWNLOAD_MEM	45
5.3	JIRAM_TC_CHECK_MEM	46
5.4	JIRAM_TC_EEPROM_LOAD	47
5.5	JIRAM_TC_CALIBRATION	48
5.6	JIRAM_TC_STANDBY	49
5.7	JIRAM_TC_SCI_PAR	50
5.8	JIRAM_TC_SET_PAR	52
5.9	JIRAM_TC_DET_PAR	53
5.10	JIRAM_TC_CAL_PAR	54
5.11	JIRAM_TC_GET_PAR	56
5.12	JIRAM_TC_DEF_PAR	57
5.13	JIRAM_TC_MOTOR	58
5.14	JIRAM_TC_CALIBSOURCE	59
5.15	JIRAM_TC_RESET	60
5.16	JIRAM_ERROR_LOG	61
5.17	JIRAM_TC_SAFE	61
5.18	JIRAM_TC_SCIENCE	62
5.19	JIRAM_TC_MAINTENANCE	62
5.20	TIME UPDATE	63
5.21	SC_ATTITUDE_AND_RATE	63
5.22	JRM_START_HS_REC	64
5.23	JRM_STOP_HS_REC	64
6	JIRAM RISKY “TELE-COMMANDS & SETTABLE PARAMETERS”	65
6.1	SP PARAMETERS TO BE CHECKED	65
6.2	TELE-COMMANDS TO BE CHECKED	67



Data 01/06/2011
Issue 5
Revision 0
Page 4 of 72

JUNO/JIRAM

ACRONYM & ABBREVIATION LIST

AD	Applicable Document
AI	Action Item
ASI	Agenzia Spaziale Italiana
CDR	Critical Design Review
C&DH	Command and Data Handling
CICD	Communication Interface Control Document
CIDL	Configuration Item Data List
EDAC	Error Detection And Correction
EGSE	Electrical Ground Support Equipment
EM	Electrical Model
ESA	European Space Agency
FM	Flight Model
FSW	Flight SW
GA	Galileo Avionica
HEX	Hexadecimal format
HK	Housekeeping
HW	Hardware
HSSL	High Speed Serial Link
IF	Interface
IR	Infrared
INAF	Istituto Nazionale di Astrofisica
ITAR	International Traffic in Arms Regulations
JSOC	Juno Science Operations Centre (at SwRI, Texas)
JPL	Jet Propulsion Laboratory
JIRAM	Jovian Infrared Auroral Mapper
LM	Lockheed Martin
LSSL	Low Speed Serial Link
NA	Not Applicable
NASA	National Aeronautics and Space Administration
PI	Principal Investigator
RD	Reference Document
RID	Review Item Discrepancy
SC	Spacecraft
SCR	SW Change Request
SDD	SW Design Document



Data 01/06/2011
Issue 5
Revision 0
Page 5 of 72

JUNO/JIRAM

SP	Settable Parameter
SRR	SW Requirements Review
SRD	SW Requirements Document
STR	String format
SUM	SW User Manual
SW	Software
TBD	To Be Defined
TBC	To Be Confirmed
TBW	To Be Written
TC	Tele-command
TM	Telemetry
UDEC	Unsigned Decimal format

		Data 01/06/2011 Issue 5 Revision 0 Page 6 of 72
	JUNO/JIRAM	

DISTRIBUTION LIST

Name	Name
A. CORADINI / INAF-IFSI	C. PASQUI / Galileo Avionica S.p.A
A. ADRIANI / INAF-IFSI	A. BINI / Galileo Avionica S.p.A
R. NOSCHESI / INAF-IFSI	M. LASTRI / Galileo Avionica S.p.A
	M. MUNOZ FERNANDEZ / JPL
	M. SCHELPEFFER / JPL
	A. HALE / JPL
	L. MORALES / JPL
	M. MERCADO / JPL
	M. THORNTON/JPL
	T. KOCH/JPL
	C. RASBACH / LM
	J. DELAVAN / LM
	O. BILLETT / LM

		Data 01/06/2011 Issue 5 Revision 0 Page 7 of 72
	JUNO/JIRAM	

DOCUMENT CHANGE LOG

Issue	Date	Pages/Paragraphs affected	Changes Description
Version 3	18-02-11	Pg. 12:13 (Paragraphs: 3.1, 3.1.1)	Updated JRM Power On Block
		Pg. 20:21 (Paragraphs: 3.5, 3.5.1)	Exchanged position of JIRAM_TC_SCI_PAR with JIRAM_TC_STANDBY
		Pg. 60:61 (Chapter 61)	Replaced the string PT with SP (settable parameters)
		Pg. 57 (Paragraph 5.13)	Corrected the Range field of the MOTOR_MIRRO_SPEED parameter
Version 4	03-05-11	Pg. 40 (Paragraph 3.15)	Updated Power Off Sequence
		Pg. 41 (Paragraph 3.15.1)	Updated Power Off Sequence description
		Pg. 43 (Paragraph 5.1)	Updated “jrm_start_add” Range
		Pg. 45 (Paragraph 5.3)	Corrected nomenclature of “jrm_check_size”
		Pg. 46 (Paragraph 5.4)	Updated Ranges of: jrm_eeprom_add; jrm_ram_add; jrm_start_add
		Pg. 47 (Paragraph 5.5)	Corrected nomenclature of “jrm_mode_cal”
		Pg. 49 (Paragraph 5.7)	Corrected nomenclature of “jrm_mode_sci”
		Pg. 51, Pg. 55 & Pg.56 (Paragraph 5.8, 5.11 & 5.12)	Updated Range of “jrm_sp_id”
		Pg. 52 (Paragraph 5.9)	Corrected nomenclature of “SP_I_Y_L_BAND”
Pg. 60 ÷ Pg. 63 (Paragraphs 5.16 : 5.23)	Added new Paragraphs, from 5.16 to 5.23		
Version 5	01-06-11	Pg. 40 (Paragraph 3.15)	Updated Diagram and Timing
		Pg. 41 (Paragraph 3.15.1)	Updated Activity Description
		Pg. 42 (Chapter 4)	Updated Diagram and Timing
Version 6		Pg 53	Corrected JIRAM_TC_DET_PAR

		Data 01/06/2011 Issue 5 Revision 0 Page 8 of 72
	JUNO/JIRAM	

APPLICABLE DOCUMENTS

The following documents at the latest issue in effect shall apply. These documents are herein referred as [AD-XX].

<i>Id</i>	<i>Document Number</i>	<i>Description</i>

REFERANCE DOCUMENTS

The following documents shall be used as reference background and support information. These documents are herein referred as [RD-XX].

<i>Id</i>	<i>Document Number</i>	<i>Description</i>
[RD-01]	JIRAM-GAF-IC-001	JIRAM-GAF-IC-001_rev6_CICD.pdf
[RD-02]	JIRAM-GAF-TN-027	JIRAM-GAF-TN-027_rev10.pdf
[RD-03]	JIRAM-GAF-RP-011	JIRAM-GAF-RP-011_rev0(CalibrationDataRecord).pdf
[RD-04]	From LM	JIRAM Commands, Parameters 6.0.1_01.xls
[RD-05]	JIRAM-GAF-RS-002	JIRAM-GAF-RS-002_rev7_SRD.pdf

		Data 01/06/2011 Issue 5 Revision 0 Page 9 of 72
	JUNO/JIRAM	

1 PURPOSE OF THIS DOCUMENT

The purpose of this document is to describe and formalize the structures and format of all the JIRAM commanding sequences, intended to be used for routine operations on Jupiter, at the earliest.

The format proposed in this document is compatible with the JPL system architecture. However, in some few cases, fully described and highlighted with the blue colour, it is necessary a restyle of the JPL system's configuration.

2 JIRAM INSTRUMENT DESCRIPTION

JIRAM is equipped with a single telescope that accommodates both an infrared camera and a spectrometer to facilitate a large observational flexibility in obtaining simultaneous images in the L and M bands with the spectral radiance over the central zone of the images. Moreover, JIRAM will be able to perform spectral imaging of the planet in the 2.0-5.0 μm interval of wavelengths with a spectral resolution better than 10 nm. Instrument design, modes, and observation strategy will be optimized for operations onboard a spinning satellite in polar orbit around Jupiter. The JIRAM heritage comes from Italian-made, visual-infrared imaging spectrometers dedicated to planetary exploration, such as VIMS-V on Cassini, VIRTIS on Rosetta and Venus Express, and VIR-MS on the Dawn mission.

JIRAM combines two data channels in one instrument: the **imager** and the **spectrometer**, which are housed in the same optical subsystem (fig. 1). The instrument is composed of the Optical Head (OH) and the Main Electronic (ME). The ME contains the electronics to drive the Focal Plane Arrays (FPAs) and compensating mirror, and perform the acquisition and conversion of the science and housekeeping data. It also manages the operation of the two channels, gathers data and housekeeping information from them, stores the data, performs data compression, and interfaces the instrument with the spacecraft.

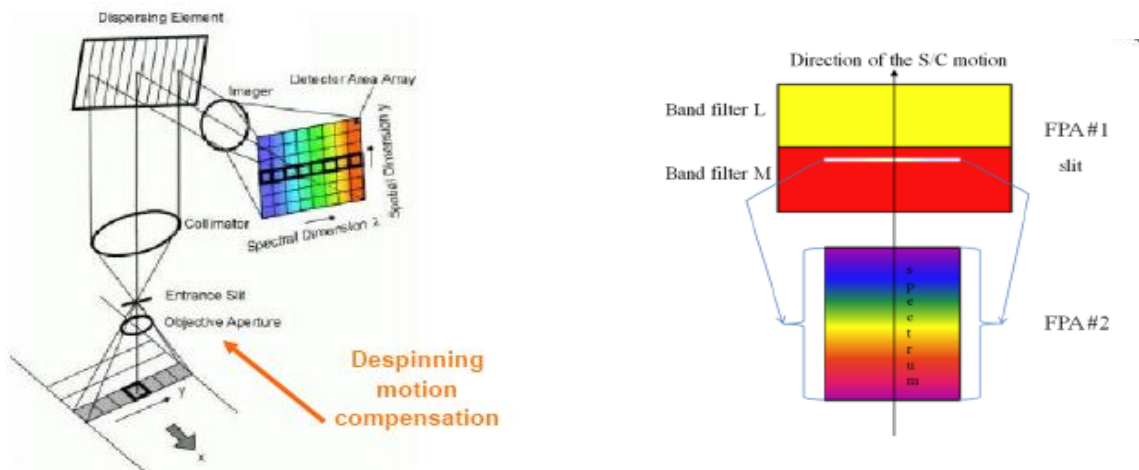

Fig. 1: the two FPAs

		Data 01/06/2011 Issue 5 Revision 0 Page 11 of 72
	JUNO/JIRAM	

2.1 SCIENCE OBJECTIVES

The Jovian InfraRed Auroral Mapper (JIRAM) will explore the dynamics and the chemistry of Jovian auroral regions by high contrast imaging and spectroscopy. It will also analyze the Jovian hot spots to determine their vertical structure and infer possible mechanisms for their formation. JIRAM will sound the Jovian meteorological layer to map moist convection and determine water abundance and other constituents at depths that correspond to several bars pressure.

3 JIRAM ATOMIC SEQUENCES DEFINITION

3.1 JIRAM POWER ON SEQUENCE

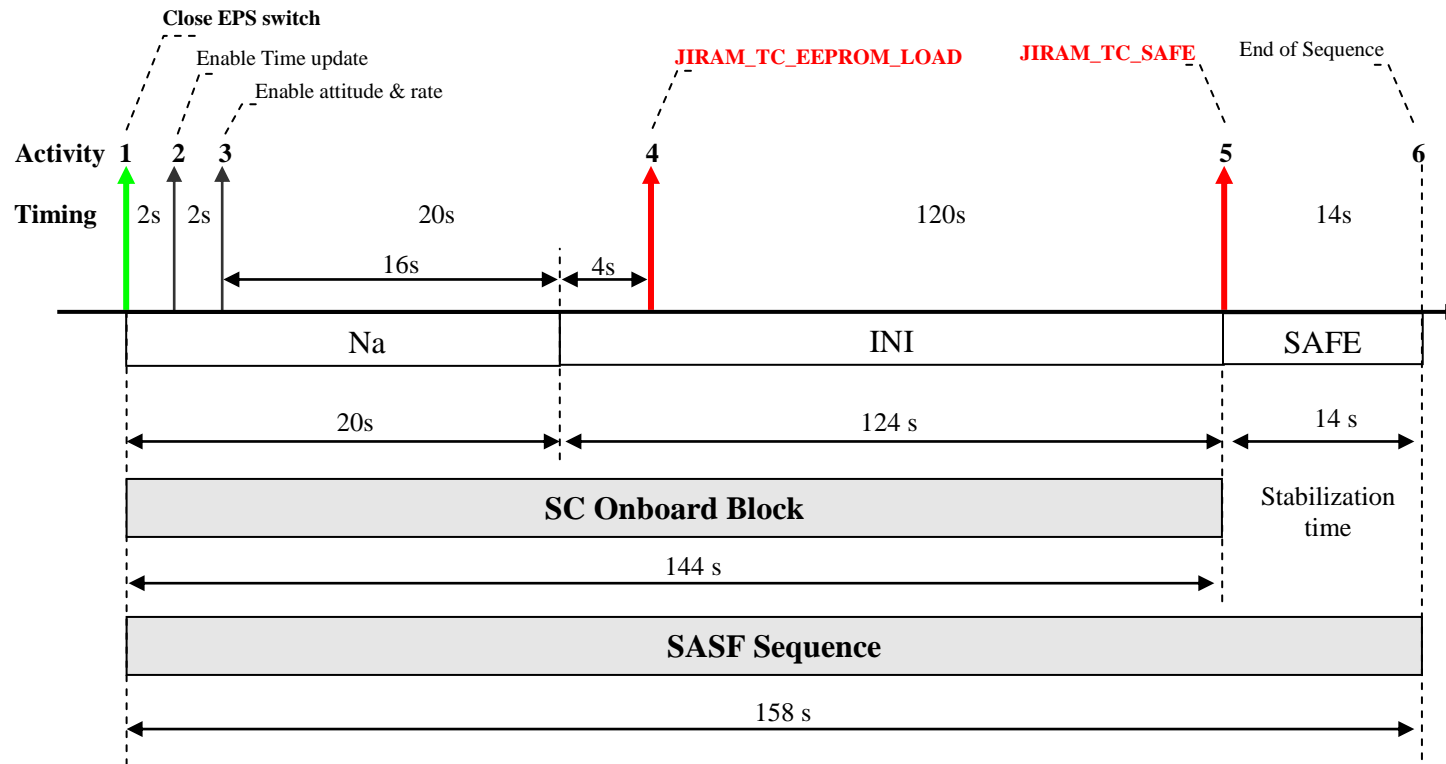

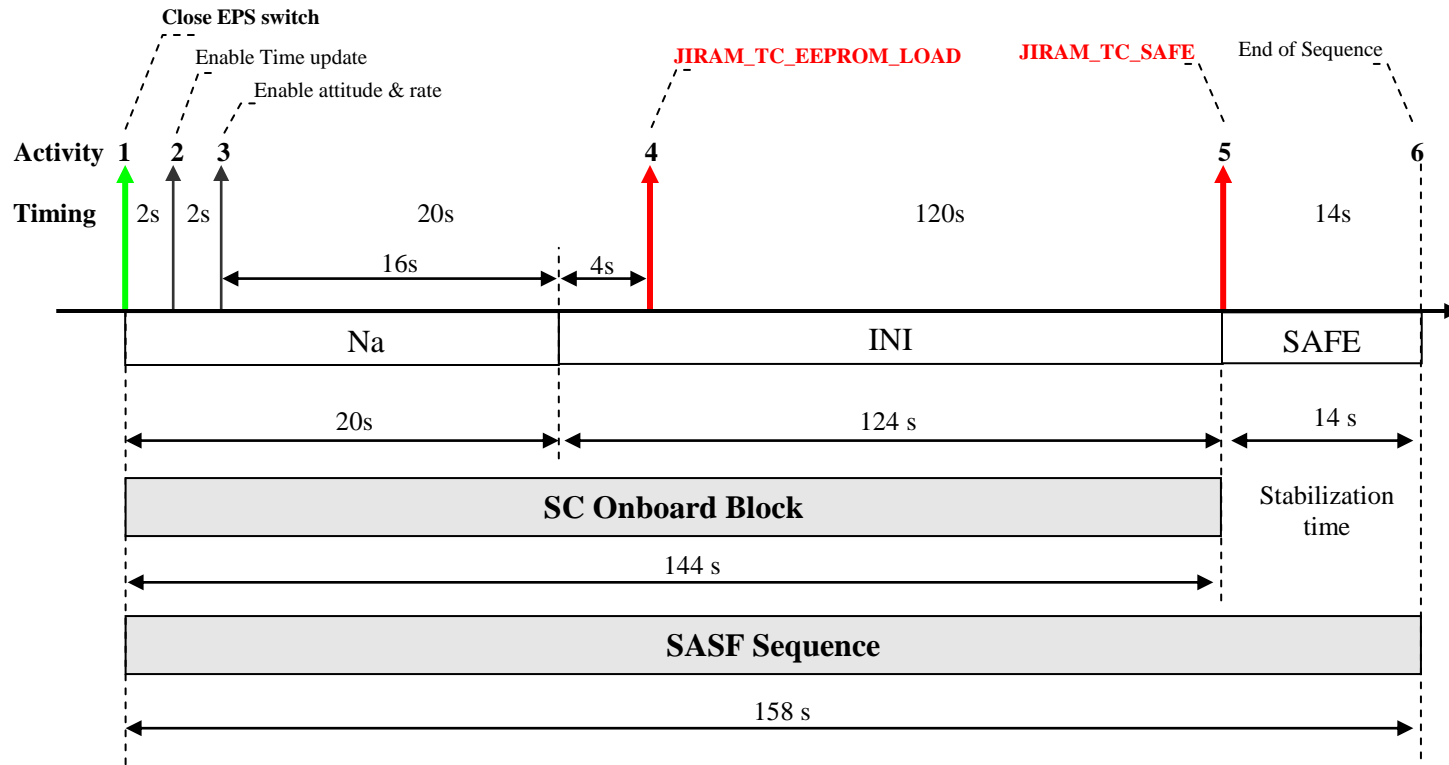

		Data 01/06/2011 Issue 5 Revision 0 Page 14 of 72
	JUNO/JIRAM	

3.1.1 ACTIVITY DESCRIPTION

Activity	Delay (delta time)	Description	Notes
1	Sequence Start	Close EPS switch	Apply Power to JIRAM.
2	2 seconds	Enable Time update	JIRAM after boot will wait for the first transaction (in order to select the active line) and it will begin to send packet TM_STATUS every 2 sec cycle. If in the first transaction there will be the SC time, the SC time will be used else JIRAM will use internal time (starting from 0). Anyway as soon the SC time will be received, JIRAM will synchronize itself with SC time.
3	2 seconds	Enable A&R data	The A&R timestamp will be different maximum 2 seconds from the Time Update datation.
4	20 seconds	JIRAM_TC_EEPROM_LOAD	JIRAM is in INI mode (PROM SW). The EEPROM load in RAM takes a long time (approx. 40 second for 3 attempts).
5	120 seconds	JIRAM_TC_SAFE	JIRAM enters in SAFE Mode (EEPROM SW).
6	14 seconds	SEQUENCE END	Needed time to be ready for next sequence

3.1.2 SASF SEQUENCE IMPLEMENTATION (PARTICULAR CASE)

The Power On Block has been entirely implemented at LM level. In the SASF file the Power On block is identified with the following code:

REQ_ENGINE_ID,\21\,RT_on_board_block(jiram_pwr_on)

The duration of the sequence is fixed to 158 seconds, as described in the previous paragraph.

3.2 JIRAM SW MAINTENANCE “DOWNLOAD MEMORY”

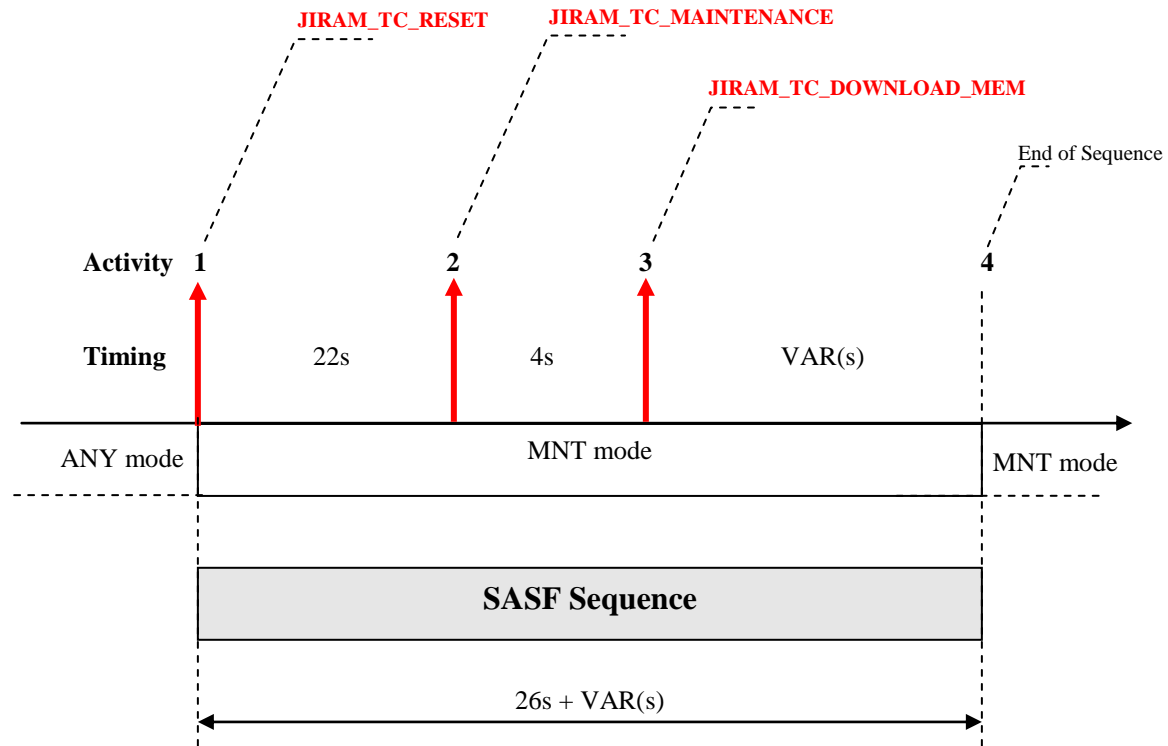

Legend

- Red arrow → JIRAM Tc, via SASF

		Data 01/06/2011 Issue 5 Revision 0 Page 16 of 72
	JUNO/JIRAM	

3.2.1 ACTIVITY DESCRIPTION

Activity	Delay (delta time)	Description	Notes
1	Start	JIRAM_TC_RESET	JIRAM enters INI mode (PROM SW)
2	22 seconds	JIRAM_TC_MAINTENANCE	JIRAM enters MNT mode (PROM SW)
3	4 seconds	JIRAM_TC_DOWNLOAD_MEM	The Memory Download time can be very long, depending on the number of locations to download (the maximum memory size JIRAM_TM_MEMDUMPmessage is 244 32-bits words).
4	N seconds	SEQUENCE END	Needed time to be ready for next sequence

3.3 JIRAM SW MAINTENANCE “CHECK MEMORY”

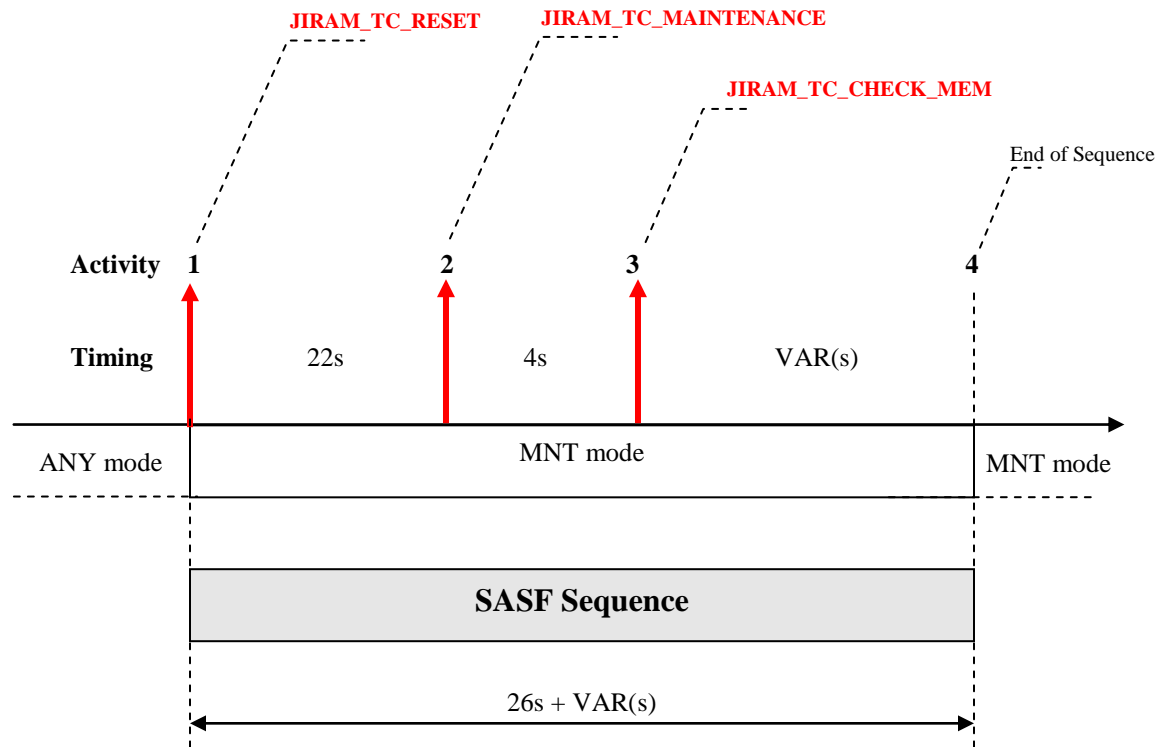

Legend

- Red arrow → JIRAM Tc, via SASF

		Data 01/06/2011 Issue 5 Revision 0 Page 18 of 72
	JUNO/JIRAM	

3.3.1 ACTIVITY DESCRIPTION

Activity	Delay (delta time)	Description	Notes
1	Start	JIRAM_TC_RESET	JIRAM enters INI mode (PROM SW)
2	22 seconds	JIRAM_TC_MAINTENANCE	JIRAM enters MNT mode (PROM SW)
3	4 seconds	JIRAM_TC_CHECK_MEM	The Memory check time can be very variable, depending on the number of memory locations to check.
4	Ns	SEQUENCE END	Needed time to be ready for next sequence

3.4 JIRAM SW MAINTENANCE “UPLOAD MEMORY”

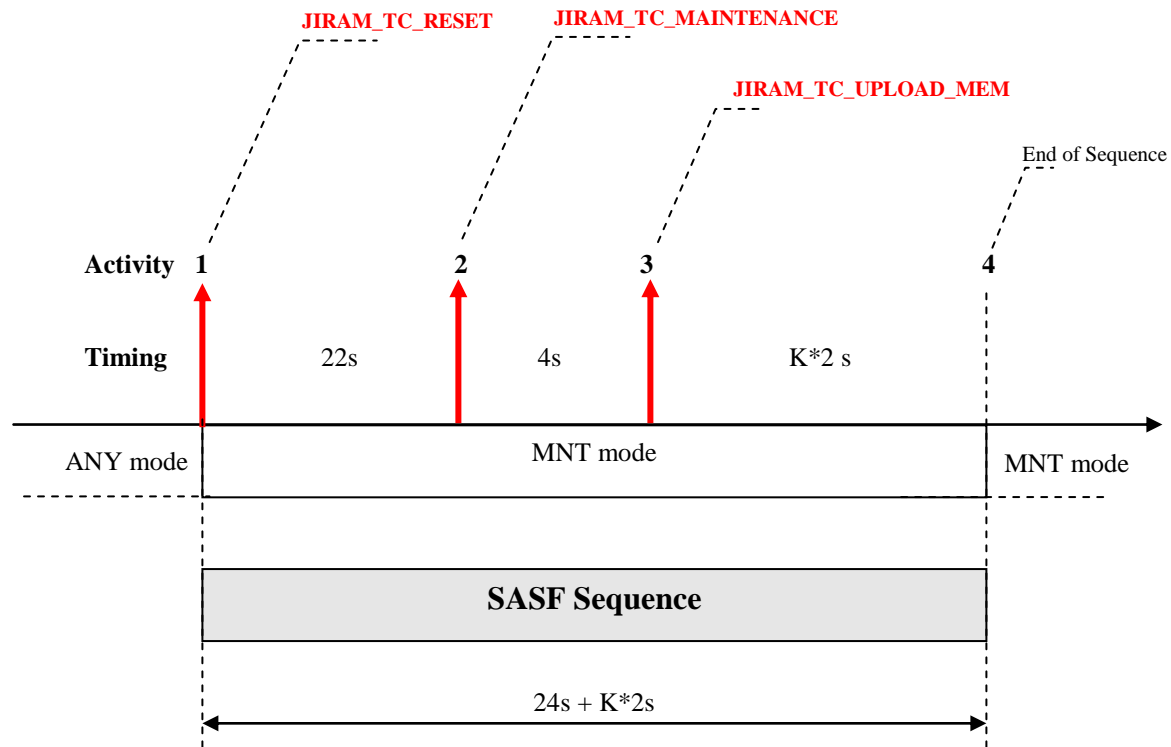

Legend

- Red arrow → JIRAM Tc, via SASF

		Data 01/06/2011 Issue 5 Revision 0 Page 20 of 72
	JUNO/JIRAM	

3.4.1 ACTIVITY DESCRIPTION

Activity	Delay (delta time)	Description	Notes
1	Start	JIRAM_TC_RESET	JIRAM enters INI mode (PROM SW)
2	22 seconds	JIRAM_TC_MAINTENANCE	JIRAM enters MNT mode (PROM SW)
3	4 seconds	JIRAM_TC_UPLOAD_MEM	The Memory Upload sequence can be built by many JIRAM_TC_UPLOAD_MEM, depending of the size of memory to upload (each command can upload 251 32-bit words)
4	K*2 seconds	SEQUENCE END	Needed time to be ready for next sequence

3.5 JIRAM GOES TO STANDBY

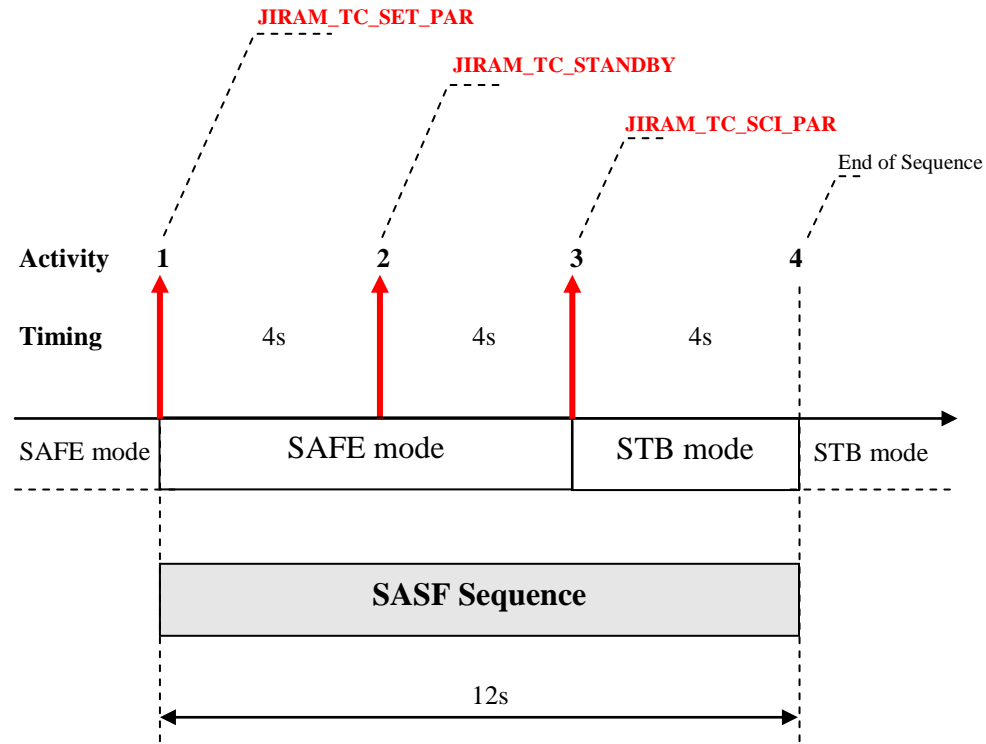

Legend

- Red arrow → JIRAM Tc, via SASF

		Data 01/06/2011 Issue 5 Revision 0 Page 22 of 72
	JUNO/JIRAM	

3.5.1 ACTIVITY DESCRIPTION

Activity	Delay (delta time)	Description	Notes
1	Start	JIRAM_TC_SET_PAR	Needed to reduce the generation of use of the TM_STATUS one each 10 seconds
2	4 seconds	JIRAM_TC_STANDBY	JIRAM enters in STB mode (EEPROM SW). <u>On ground the motor and the detectors must be set to OFF to preserve the hardware.</u>
3	4 seconds	JIRAM_TC_SCI_PAR	Needed to configure the use of SC Dynamics. ACQ_Duration is set while al the other values are at default value
4	4 seconds	SEQUENCE END	Needed time to be ready for next sequence

3.6 JIRAM GOES TO SAFE

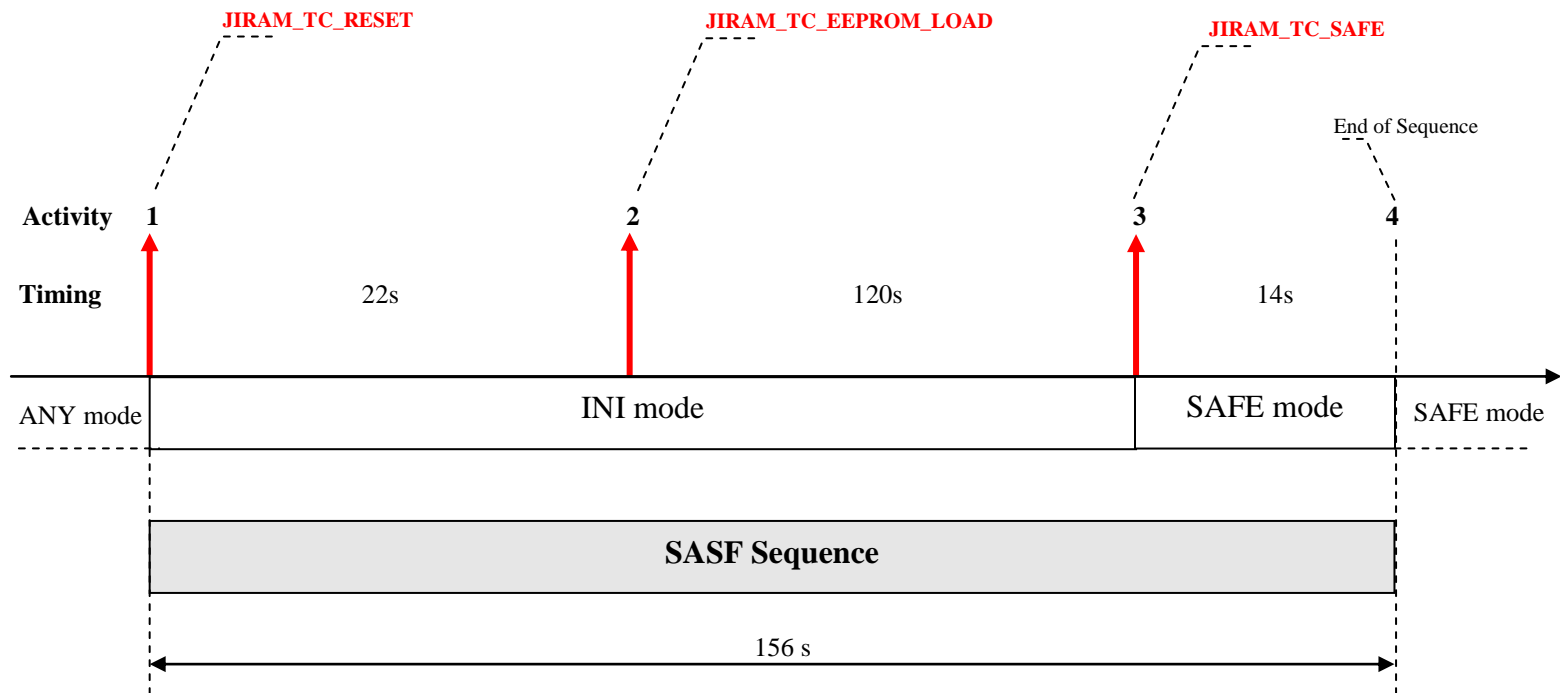

Legend

- Red arrow → JIRAM Tc, via SASF

		Data 01/06/2011 Issue 5 Revision 0 Page 24 of 72
	JUNO/JIRAM	

3.6.1 ACTIVITY DESCRIPTION

Activity	Delay (delta time)	Description	Notes
1	Start	JIRAM_TC_RESET	JIRAM enters INI mode (PROM SW)
2	22 seconds	JIRAM_TC_EEPROM_LOAD	The EEPROM load in RAM takes a long time (approx. 40 seconds).
3	120 seconds	JIRAM_TC_SAFE	JIRAM enters SAF mode (EEPROM SW)
4	14 seconds	SEQUENCE END	Needed time to be ready for next sequence

3.7 JIRAM CALIBRATION SESSION

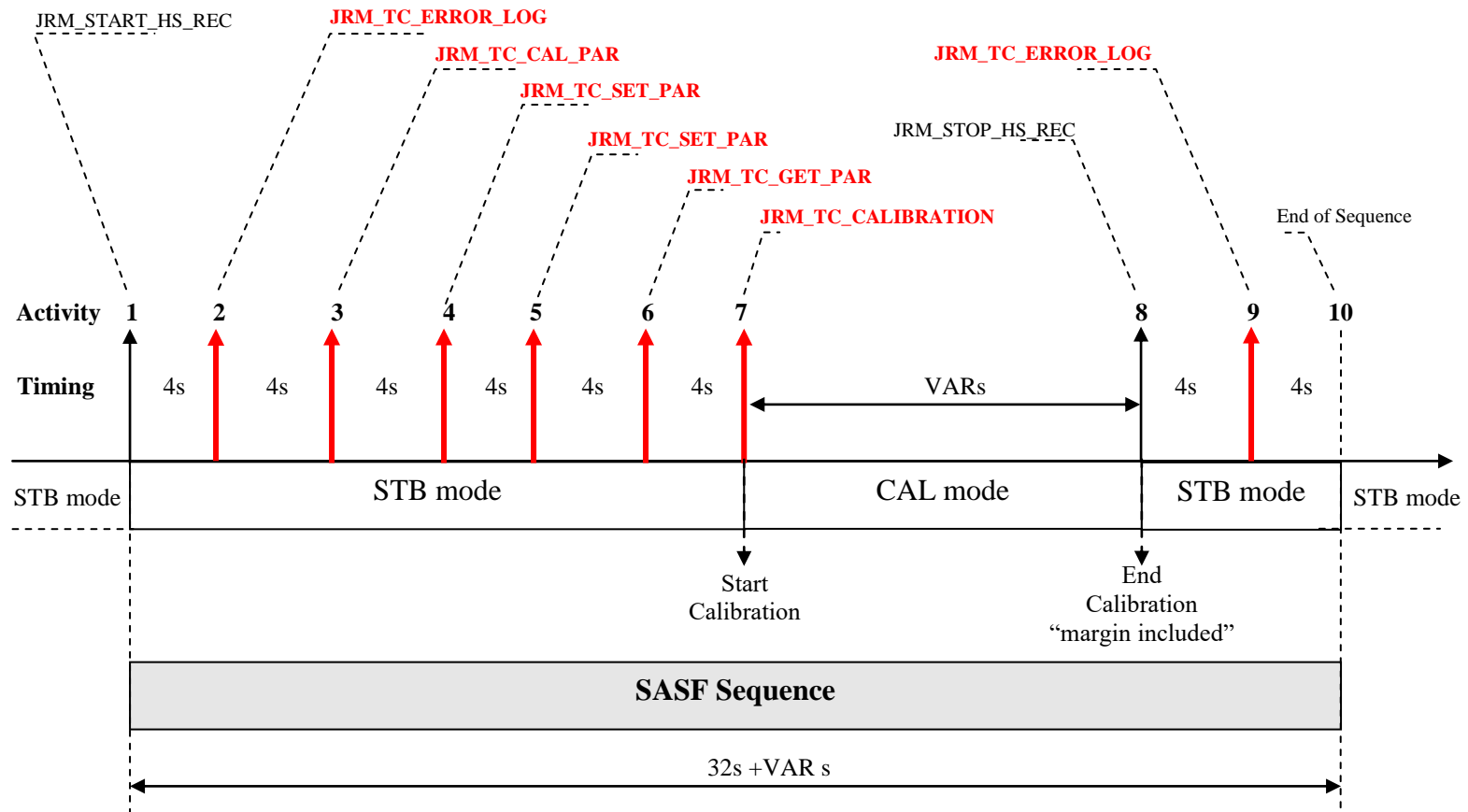

Legend

- Red arrow → JIRAM Tc, via SASF

		Data 01/06/2011 Issue 5 Revision 0 Page 26 of 72
	JUNO/JIRAM	

3.7.1 ACTIVITY DESCRIPTION

Activity	Delay (delta time)	Description	Notes
1	Start	JRM_START_HS_REC	Parameters if needed are to be defined by LM
2	4 seconds	JIRAM_TC_ERROR_LOG	
3	4 seconds	JIRAM_TC_CAL_PAR	
4	4 seconds	JIRAM_TC_SET_PAR	
5	4 seconds	JIRAM_TC_SET_PAR	
6	4 seconds	JIRAM_TC_GET_PAR	
7	4 seconds	JIRAM_TC_CALIBRATION	JIRAM enters in CAL mode (EEPROM SW). It can remain in CAL mode for a long time, depending on the params defined in JIRAM_TC_CAL_PAR or SP. After this time it autonomously returns in STB mode.
8	VAR seconds	JRM_STOP_HS_REC	
9	4 seconds	JIRAM_TC_ERROR_LOG	
10	4 seconds	SEQUENCE END	Needed time to be ready for next sequence

3.8 JIRAM SCIENCE SESSION

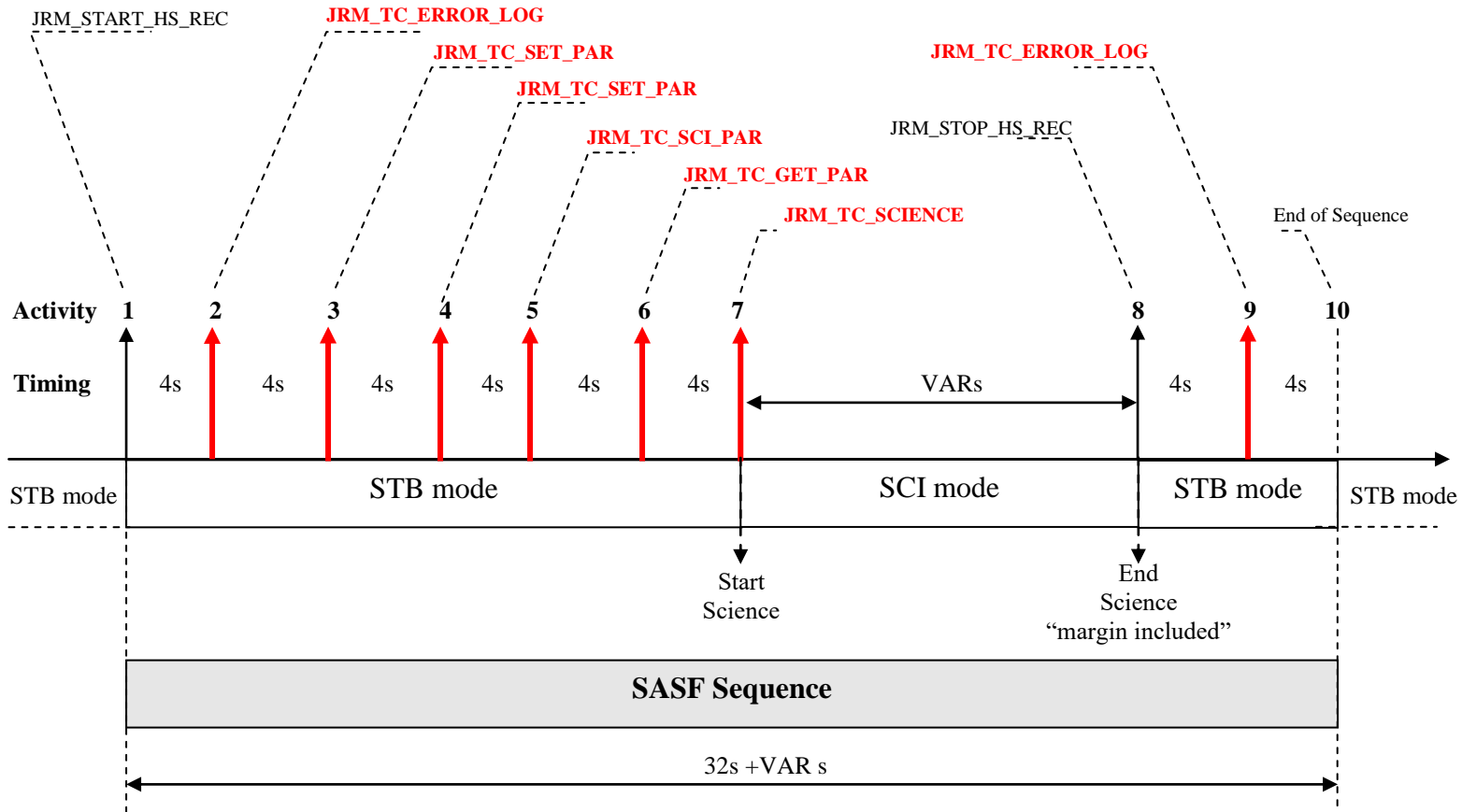

Legend

- Red arrow → JIRAM Tc, via SASF

		Data 01/06/2011 Issue 5 Revision 0 Page 28 of 72
	JUNO/JIRAM	

3.8.1 ACTIVITY DESCRIPTION

Activity	Delay (delta time)	Description	Notes
1	Start	JRM_START_HS_REC	Parameters if needed are to be defined by LM
2	4 seconds	JIRAM_TC_ERROR_LOG	
3	4 seconds	JIRAM_TC_SET_PAR	
4	4 seconds	JIRAM_TC_SET_PAR	
5		JIRAM_TC_SCI_PAR	
6	4 seconds	JIRAM_TC_GET_PAR	
7	VAR seconds	JIRAM_TC_SCIENCE	JIRAM enters in SCI mode (EEPROM SW). It can remain in SCI mode for a long time, depending on the params defined in JIRAM_TC_SCI_PAR or SP. After this time it autonomously returns in STB mode.
8	4 seconds	JRM_STOP_HS_REC	
9	4 seconds	JIRAM_TC_ERROR_LOG	
10	4 seconds	SEQUENCE END	Needed time to be ready for next sequence

3.9 JIRAM UPLOAD SP PARAMETERS

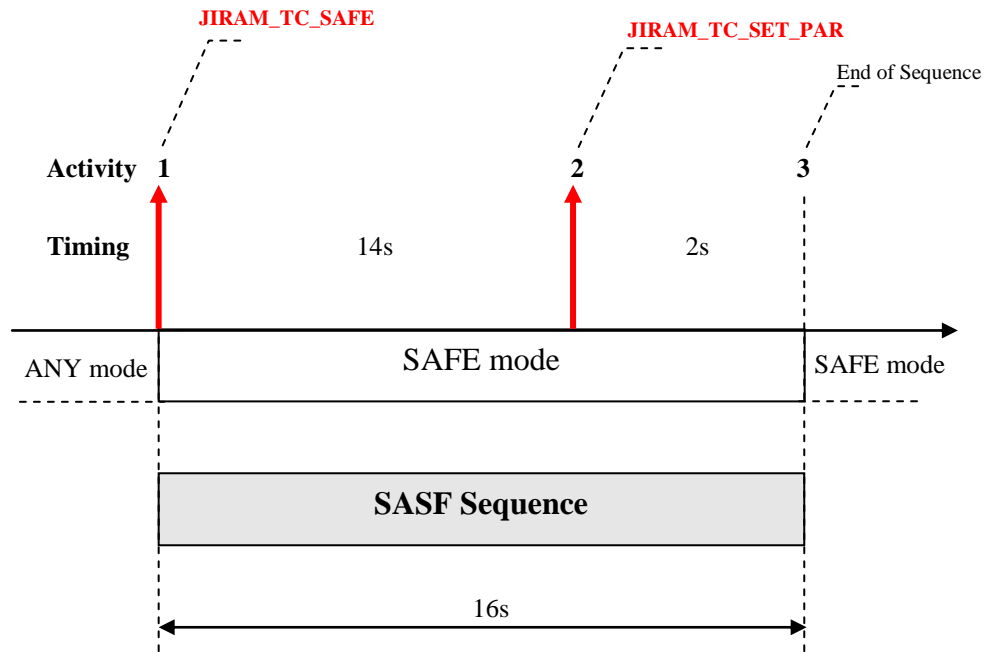

Legend

- Red arrow → JIRAM Tc, via SASF

		Data 01/06/2011 Issue 5 Revision 0 Page 30 of 72
	JUNO/JIRAM	

3.9.1 ACTIVITY DESCRIPTION

Activity	Delay (delta time)	Description	Notes
1	Start	JIRAM_TC_SAFE	JIRAM enters SAF mode (EEPROM SW)
2	14 seconds	JIRAM_TC_SET_PAR	
3	2 seconds	SEQUENCE END	Needed time to be ready for next sequence

3.10 JIRAM GET SP PARAMETERS

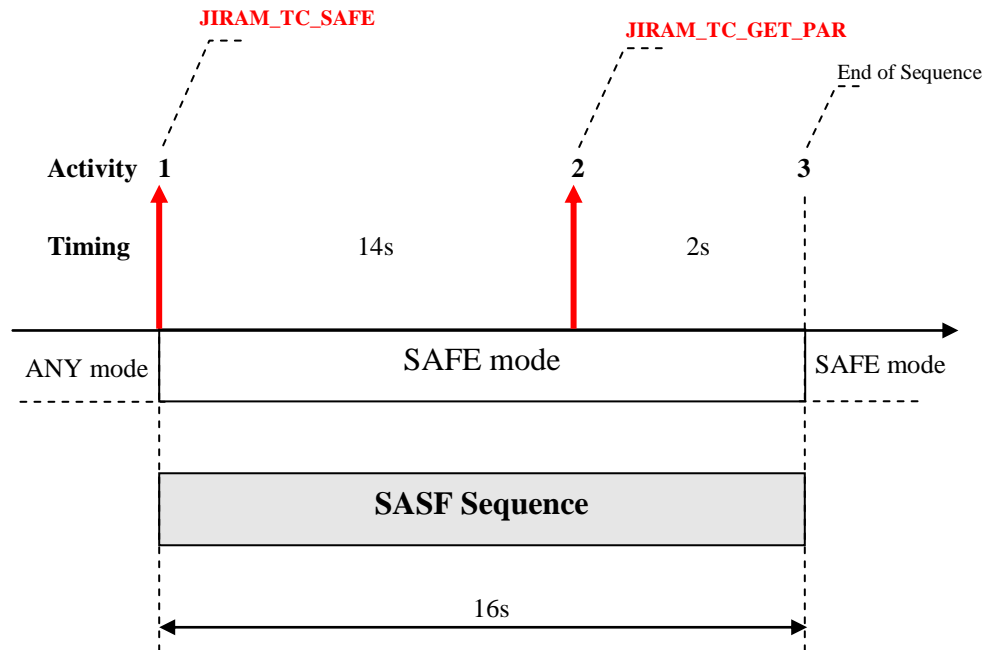

Legend

- Red arrow → JIRAM Tc, via SASF

		Data 01/06/2011 Issue 5 Revision 0 Page 32 of 72
	JUNO/JIRAM	

3.10.1 ACTIVITY DESCRIPTION

Activity	Delay (delta time)	Description	Notes
1	Start	JIRAM_TC_SAFE	JIRAM enters SAF mode (EEPROM SW)
2	14 seconds	JIRAM_TC_GET_PAR	
3	2 seconds	SEQUENCE END	Needed time to be ready for next sequence

3.11 JIRAM RESTORE SP PARAMETER

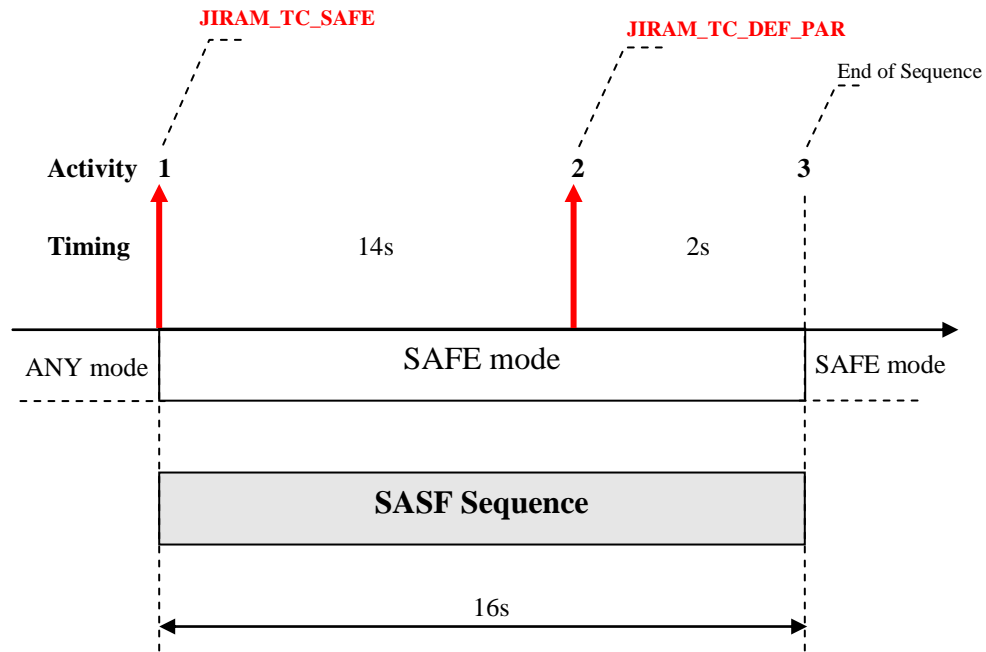

Legend

- Red arrow → JIRAM Tc, via SASF

		Data 01/06/2011 Issue 5 Revision 0 Page 34 of 72
	JUNO/JIRAM	

3.11.1 ACTIVITY DESCRIPTION

Activity	Delay (delta time)	Description	Notes
1	Start	JIRAM_TC_SAFE	JIRAM enters SAF mode (EEPROM SW)
2	14 seconds	JIRAM_TC_DEF_PAR	
3	2 seconds	SEQUENCE END	Needed time to be ready for next sequence

3.12 JIRAM COMMAND MOTOR MODE (ONLY IN FLIGHT MODE)

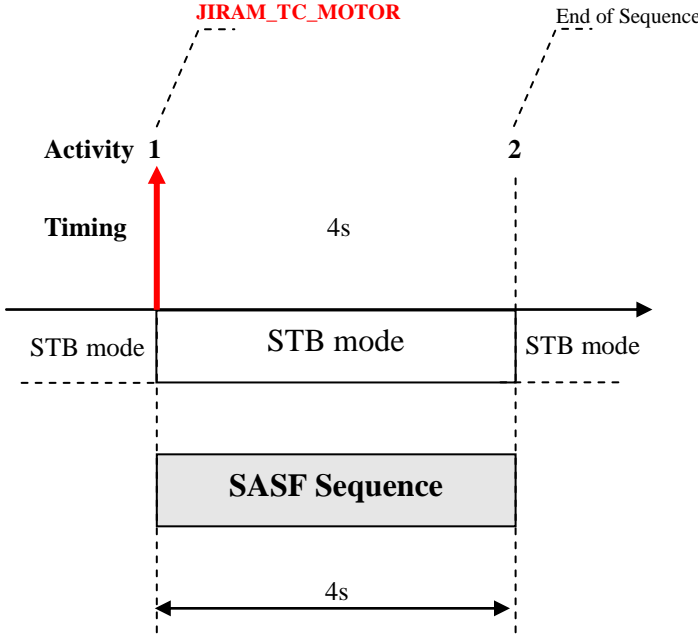

Legend

- Red arrow → JIRAM Tc, via SASF

		Data 01/06/2011 Issue 5 Revision 0 Page 36 of 72
	JUNO/JIRAM	

3.12.1 ACTIVITY DESCRIPTION

Activity	Delay (delta time)	Description	Notes
1	Start	JIRAM_TC_MOTOR	JIRAM enters SAF mode (EEPROM SW)
2	4 seconds	SEQUENCE END	Needed time to be ready for next sequence

3.13 JIRAM COMMAND CALIBRATION SOURCE (ONLY IN FLIGHT MODE)

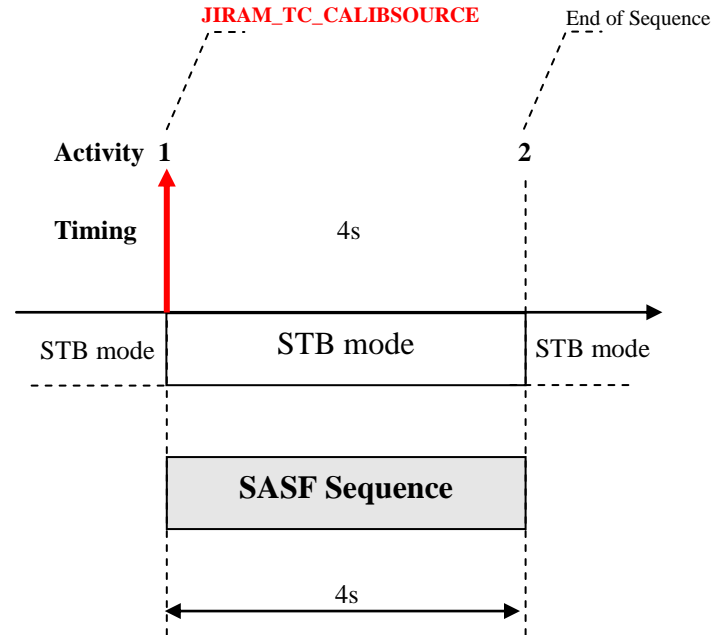

Legend

- Red arrow → JIRAM Tc, via SASF

		Data 01/06/2011 Issue 5 Revision 0 Page 38 of 72
	JUNO/JIRAM	

3.13.1 ACTIVITY DESCRIPTION

Activity	Delay (delta time)	Description	Notes
1	Start	JIRAM_TC_CALIBSOURCE	JIRAM enters SAF mode (EEPROM SW)
2	4 seconds	SEQUENCE END	Needed time to be ready for next sequence

3.14 JIRAM DETECTORS SETTABLE PARAMETER

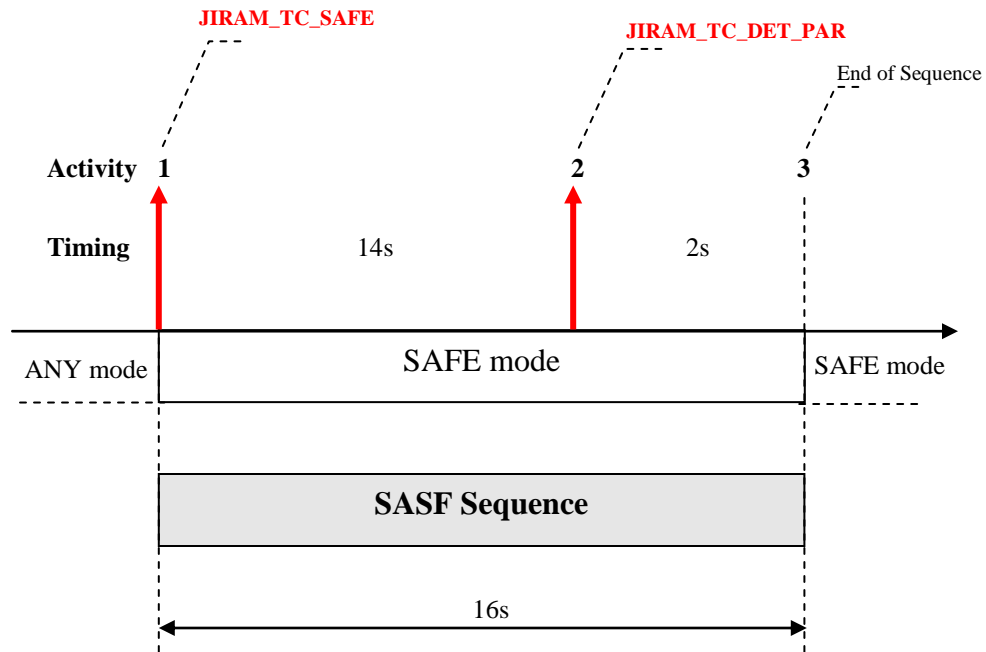

Legend

- Red arrow → JIRAM Tc, via SASF

		Data 01/06/2011 Issue 5 Revision 0 Page 40 of 72
	JUNO/JIRAM	

3.14.1 ACTIVITY DESCRIPTION

Activity	Delay (delta time)	Description	Notes
1	Start	JIRAM_TC_SAFE	JIRAM enters SAF mode (EEPROM SW)
2	14 seconds	JIRAM_TC_DET_PAR	
3	2 seconds	SEQUENCE END	Needed time to be ready for next sequence



3.15 JIRAM POWER OFF SEQUENCE

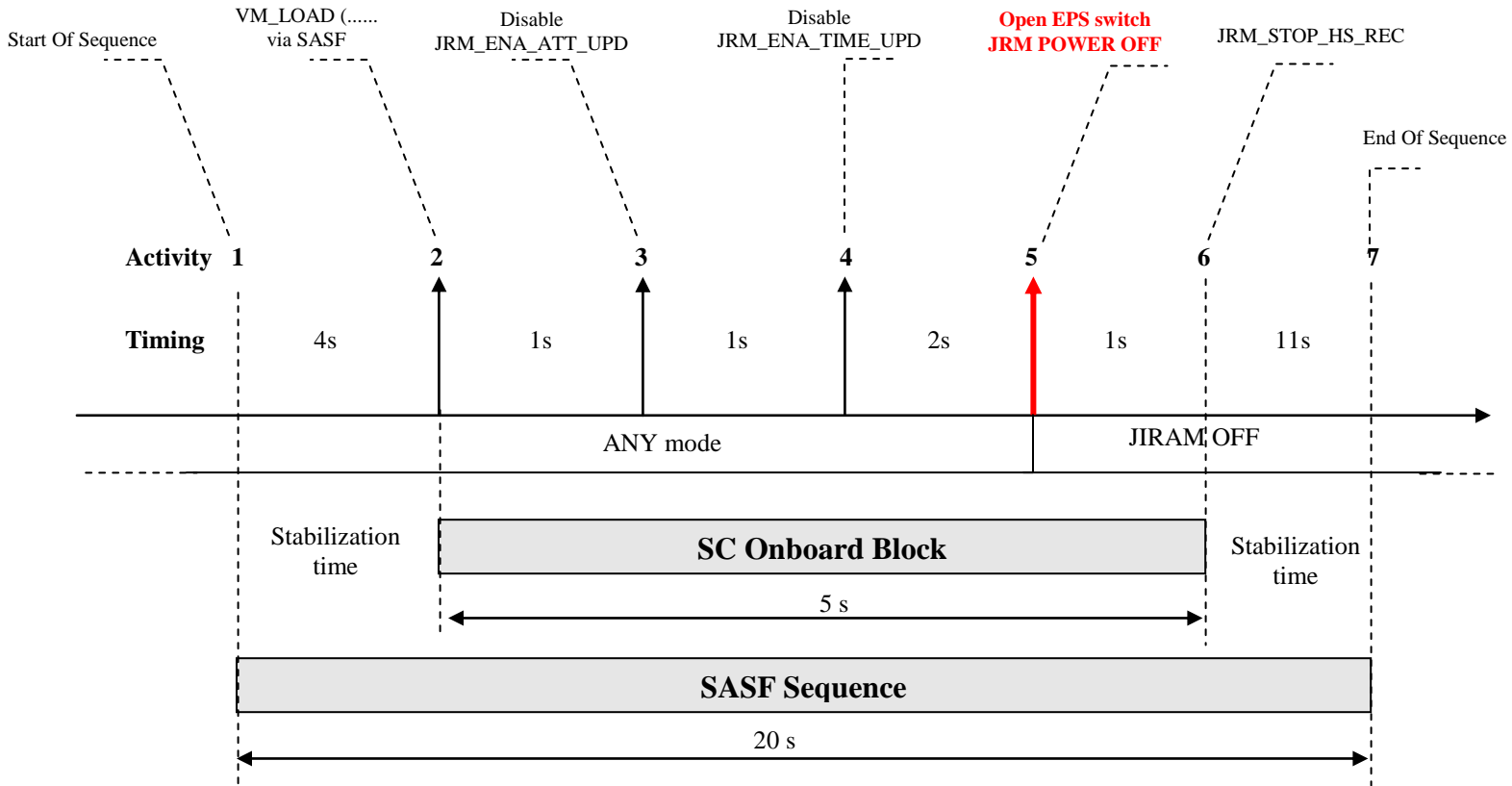

		Data 01/06/2011 Issue 5 Revision 0 Page 42 of 72
	JUNO/JIRAM	

3.15.1 ACTIVITY DESCRIPTION

Activity	Delay (delta time)	Description	Notes
1	Start	Start of Power Off sequence	
2	4 s	VM_LOAD via SASF	
3	1 s	Disable Attitude Data	
4	1s	Disable Time Update	
5	2s	Open EPS switch	
6	1s	Stop HS REC	
7	11s	SEQUENCE END	Needed time to be ready for next sequence

4 JIRAM EXAMPLE OF ROUTINE OBSERVATION

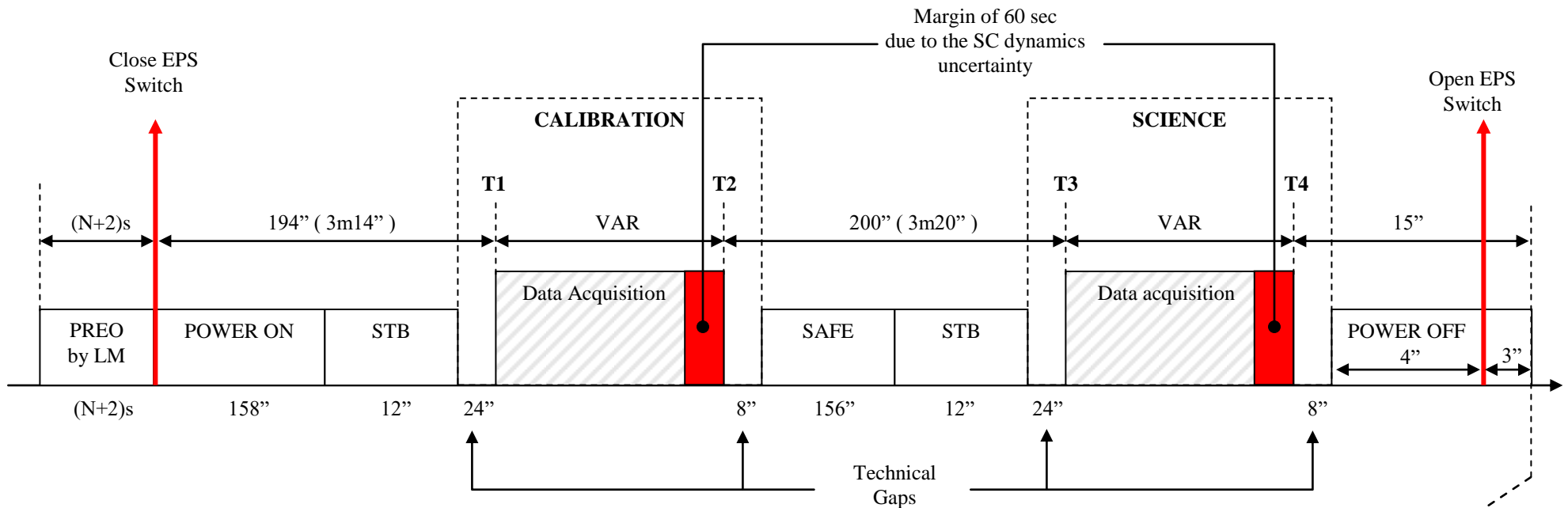

- T1 → Start of Calibration
- T2 → End of Calibration (margin included)
- T3 → Start of Science
- T4 → End of Science (margin included)

JIRAM is ready to start another timeline

5 JIRAM TELE-COMMANDS IMPLEMENTATION ARCHITECTURE

5.1 JIRAM_TC_UPLOAD_MEM

- JIRAM Team Name Convention = **JIRAM_TC_UPLOAD_MEM**
- JPL Name Convention = **JRM_LOAD_FILE**

JRM_LOAD_FILE loads the content of the specified file to the USV instrument beginning at the specified address.

JIRAM_TC_UPLOAD_MEM (JRM_UPLOAD_MEM)				
JRM Team, Tc's field Name Convention	JPL, Tc's field Name Convention	Type	Range	Raw Conversion
NA	jrm_file_path	STR	NA	
START_ADD	jrm_start_add	HEX	0x00000000	NA
			0xFFFFFFFF	NA
EEPROM_EDAC	jrm_eeprom_edac	STR	"DISABLE"	0 (Uint16)
			"ENABLE"	1 (Uint16)

5.1.1 EXAMPLE OF LOAD FILE

```

Offset (d) 00 02 04 06 08 10 12 14
00000000 A010 0000 2910 003C 81C5 2300 0100 0000
00000016 A148 0000 2D10 00C3 81C5 A348 A750 0000
00000032 AE10 2002 2D10 00C0 81C5 A054 A148 0000
00000048 AE10 2003 2D10 00C0 81C5 A054 A148 0000
00000064 AE10 2004 2D10 00C0 81C5 A054 A148 0000
00000080 A148 0000 2910 00C9 81C5 2244 0100 0000
00000096 A148 0000 2910 00C9 81C5 22A4 0100 0000
00000112 A148 0000 2D10 00C8 81C5 A1C4 A750 0000
00000128 AE10 2008 2D10 00C0 81C5 A054 A148 0000
00000144 AE10 2009 2D10 00C0 81C5 A054 A148 0000
00000160 AE10 200A 2D10 00C0 81C5 A054 A148 0000
00000176 AE10 200B 2D10 00C0 81C5 A054 A148 0000
00000192 AE10 200C 2D10 00C0 81C5 A054 A148 0000
00000208 AE10 200D 2D10 00C0 81C5 A054 A148 0000
00000224 AE10 200E 2D10 00C0 81C5 A054 A148 0000

```

5.2 *JIRAM_TC_DOWNLOAD_MEM*

- JIRAM Team Name Convention = **JIRAM_TC_DOWNLOAD_MEM**
- JPL Name Convention = **JRM_DOWNLOAD_MEM**

JIRAM_TC_DOWNLOAD_MEM (JRM_DOWNLOAD_MEM)				
JRM Team, Tc's field Name Convention	JPL, Tc's field Name Convention	Type	Range	Tc Field Raw Conversion
START_ADD	jrm_start_add	HEX	0X00000000	NA
			0xFFFFFFFF	NA
SIZE	jrm_dwnload_size	UDEC	0	NA
			4294967295	NA
EEPROM_EDAC	jrm_eeeprom_edac	STR	"DISABLE"	0 (Uint16)
			"ENABLE"	1 (Uint16)

5.3 *JIRAM_TC_CHECK_MEM*

- JIRAM Team Name Convention = **JIRAM_TC_CHECK_MEM**
- JPL Name Convention = **JRM_CHECK_MEM**

JIRAM_TC_CHECK_MEM (JRM_CHECK_MEM)				
JRM Team, Tc's field Name Convention	JPL, Tc's field Name Convention	Type	Range	Tc Field Raw Conversion
START_ADD	jrm_start_add	HEX	0X00000000 0XFFFFFFFF	NA NA
SIZE	jrm_check_size	UDEC	0 4294967295	NA NA
EEPROM_EDAC	jrm_eeprom_edac	STR	"DISABLE" "ENABLE"	0 (Uint16) 1 (Uint16)

5.4 JIRAM_TC_EEPROM_LOAD

- JIRAM Team Name Convention = **JIRAM_TC_EEPROM_LOAD**
- JPL Name Convention = **JRM_EEPROM_LOAD**

JIRAM_TC_EEPROM_LOAD(JRM_EEPROM_LOAD)				
JRM Team, Tc's field Name Convention	JPL, Tc's field Name Convention	Type	Range	Tc Field Raw Conversion
LOAD	jrm_load_type	STR	"USE_DEF_PARAMS"	0 (Uint16)
			"USE_PARAMS_IN_TC"	1 (Uint16)
EEPROM_EDAC	jrm_eeprom_edac	STR	"DISABLE"	0 (Uint16)
			"ENABLE"	1 (Uint16)
EEPROM_ADD	jrm_eeprom_add	HEX	0X00000000	NA
			0xFFFFFFFF	NA
RAM_ADD	jrm_ram_add	HEX	0X00000000	NA
			0xFFFFFFFF	NA
SIZE	jrm_xfer_size	UDEC	0	NA
			4294967295	NA
START_ADD	jrm_start_add	HEX	0X00000000	NA
			0xFFFFFFFF	NA



5.5 *JIRAM_TC_CALIBRATION*

- JIRAM Team Name Convention = **JIRAM_TC_CALIBRATION**
- JPL Name Convention = **JRM_CALIBRATION**

JIRAM_TC_CALIBRATION (JRM_CALIBRATION)				
JRM Team, Tc's field Name Convention	JPL, Tc's field Name Convention	Type	Range	Tc Field Raw Conversion
SUB_MODE	jrm_mode_cal	STR	"CAL_I0_S1"	01 (HEX)
			"CAL_I0_S2"	02 (HEX)
			"CAL_I0_S3"	03 (HEX)
			"CAL_I1_S0"	10 (HEX)
			"CAL_I1_S1"	11 (HEX)
			"CAL_I1_S2"	12 (HEX)
			"CAL_I1_S3"	13 (HEX)
			"CAL_I2_S0"	20 (HEX)
			"CAL_I2_S1"	21 (HEX)
			"CAL_I2_S2"	22 (HEX)
			"CAL_I2_S3"	23 (HEX)
			"CAL_I3_S0"	30 (HEX)
			"CAL_I3_S1"	31 (HEX)
			"CAL_I3_S2"	32 (HEX)
"CAL_I3_S3"	33 (HEX)			
EN_DIS_COMP	jrm_en_dis_comp	STR	"IEN_SEN"	0 (Enum)
			"IDIS_SEN"	1 (Enum)
			"IEN_SDIS"	2 (Enum)
			"IDIS_SDIS"	3 (Enum)
EN_DISABLE_SUB	jrm_en_dis_sub	STR	"DISABLE"	0 (Enum)
			"ENABLE"	1 (Enum)
NUM_CYCLE_PER_PHASE	jrm_num_cycles	UDEC	1	NA
			16	NA
LAMP_ID	jrm_lamp_id	STR	"LAMP_1"	0 (Enum)
			"LAMP_2"	1 (Enum)
			"BOTH_LAMPS"	2 (Enum)

5.6 JIRAM_TC_STANDBY

- JIRAM Team Name Convention = **JIRAM_TC_STANDBY**
- JPL Name Convention = **JRM_STANDBY**

JIRAM_TC_STANDBY (JRM_STANDBY)				
JRM Team, Tc's field Name Convention	JPL, Tc's field Name Convention	Type	Range	Tc Field Raw Conversion
I_IR_ON_OFF	jrm_i_ir_on_off	STR	"OFF"	0 (Enum)
			"ON"	1 (Enum)
			"AUTO"	2 (Enum)
S_IR_ON_OFF	jrm_s_ir_on_off	STR	"OFF"	0 (Enum)
			"ON"	1 (Enum)
			"AUTO"	2 (Enum)
M_MOTOR_ENABLE	jrm_motor_enab	STR	"OFF"	0 (Enum)
			"ON"	1 (Enum)

Note: On Ground the motor and the detectors must be set to OFF to preserve the hardware



5.7 JIRAM_TC_SCI_PAR

- JIRAM Team Name Convention = **JIRAM_TC_SCI_PAR**
- JPL Name Convention = **JRM_SCI_PAR**

JIRAM_TC_SCI_PAR (JRM_SCI_PAR)				
JRM Team, Tc's field Name Convention	JPL, Tc's field Name Convention	Type	Range	Tc Field Raw Conversion
SUB_MODE	jrm_mode_sci	STR	"SCI_I0_S0"	00 (HEX)
			"SCI_I0_S1"	01 (HEX)
			"SCI_I0_S2"	02 (HEX)
			"SCI_I0_S3"	03 (HEX)
			"SCI_I1_S0"	10 (HEX)
			"SCI_I1_S1"	11 (HEX)
			"SCI_I1_S2"	12 (HEX)
			"SCI_I1_S3"	13 (HEX)
			"SCI_I2_S0"	20 (HEX)
			"SCI_I2_S1"	21 (HEX)
			"SCI_I2_S2"	22 (HEX)
			"SCI_I2_S3"	23 (HEX)
			"SCI_I3_S0"	30 (HEX)
			"SCI_I3_S1"	31 (HEX)
"SCI_I3_S2"	32 (HEX)			
"SCI_I3_S3"	33 (HEX)			
SP_ACQ_N	jrm_acq_n	UDEC	1	NA
			65535	NA
SP_ACQ_REPETITION	jrm_acq_rep	UDEC	1	NA
			255	NA
SP_BKG_REPETITION	jrm_bkg_rep	UDEC	0	NA
			50	NA
SP_EN_DIS_COMP	jrm_en_dis_comp	STR	"IEN_SEN"	0 (Enum)
			"IDIS_SEN"	1 (Enum)
			"IEN_SDIS"	2 (Enum)
			"IDIS_SDIS"	3 (Enum)
SP_SCI_LINK	jrm_sci_link	STR	"HSSL"	0 (Enum)
			"LSSL"	1 (Enum)
SP_EN_DIS_SUB	jrm_en_dis_sub	STR	"DISABLE"	0 (Enum)
			"ENABLE"	1 (Enum)
SP_BKG_RN	jrm_bkg_rn	STR	"BKG"	0 (Enum)
			"RN"	1 (Enum)
			"DARK"	2 (Enum)



Data 01/06/2011
 Issue 5
 Revision 0
 Page 51 of 72

JUNO/JIRAM

JIRAM_TC_SCI_PAR (JRM_SCI_PAR)				
JRM Team, Tc's field Name Convention	JPL, Tc's field Name Convention	Type	Range	Tc Field Raw Conversion
SP_EN_DIS_DOUC_SCI	jrm_en_dis_dou	STR	"DISABLE"	0 (Enum)
			"ENABLE"	1 (Enum)
SP_ACQ_DURATION	jrm_acq_dur	UDEC	0	NA
			255	NA
SP_NADIR_DELTA	jrm_nadir_delta	UDEC	0	NA
			3186	NA
SP_I_EXP_1	jrm_i_exp1	UDEC	0	NA
			50000	NA
SP_S_EXP_1	jrm_s_exp1	UDEC	0	NA
			50000	NA
SP_I_GAIN_1	jrm_i_gain1	STR	"LOW"	0 (Enum)
			"HIGH"	1 (Enum)
SP_S_GAIN_1	jrm_s_gain1	STR	"LOW"	0 (Enum)
			"HIGH"	1 (Enum)
SP_M_MODE_1	jrm_motor_mode1	STR	"POINT"	0 (Enum)
			"SPIN"	1 (Enum)
SP_NADIR_OFFSET_1	jrm_nadr_offset1	SDEC	-57343	NA
			57343	NA
SP_I_EXP_2	jrm_i_exp2	UDEC	0	NA
			50000	NA
SP_S_EXP_2	jrm_s_exp2	UDEC	0	NA
			50000	NA
SP_I_GAIN_2	jrm_i_gain2	STR	"LOW"	0 (Enum)
			"HIGH"	1 (Enum)
SP_S_GAIN_2	jrm_s_gain2	STR	"LOW"	0 (Enum)
			"HIGH"	1 (Enum)
SP_M_MODE_2	jrm_motor_mode2	STR	"POINT"	0 (Enum)
			"SPIN"	1 (Enum)
SP_NADIR_OFFSET_2	jrm_nadr_offset2	SDEC	-57343	NA
			57343	NA
SP_SUMMED_SCIENCE	jrm_summed_sci	STR	"NO_SUMMED_SCI"	0 (Enum)
			"SUMMED_SCI"	1 (Enum)

		Data 01/06/2011 Issue 5 Revision 0 Page 52 of 72
	JUNO/JIRAM	

5.8 *JIRAM_TC_SET_PAR*

- JIRAM Team Name Convention = **JIRAM_TC_SET_PAR**
- JPL Name Convention = **JRM_SET_PAR**

JIRAM_TC_SET_PAR (JRM_SET_PAR)				
JRM Team, Tc's field Name Convention	JPL, Tc's field Name Convention	Type	Range	Tc Field Raw Conversion
SP_ID	jrm_sp_id	UDEC	0	NA
			65535	NA
SP_VAL	jrm_sp_value	UDEC	0	NA
			4294967295	NA

5.9 JIRAM_TC_DET_PAR

- JIRAM Team Name Convention = **JIRAM_TC_DET_PAR**
- JPL Name Convention = **JRM_DET_PAR**

JIRAM_TC_DET_PAR (JRM_DET_PAR)				
JRM Team, Tc's field Name Convention	JPL, Tc's field Name Convention	Type	Range	Tc Field Raw Conversion
SP_I_VDETADJ	jrm_sp_i_vdetadj	UDEC	0 4095	NA NA
SP_S_VDETADJ	jrm_sp_s_vdetadj	UDEC	0 4095	NA NA
SP_IR_STAB_TIME	jrm_sp_ir_stab_t	UDEC	0 500	NA NA
SP_I_DELAY	jrm_sp_i_delay	UDEC	0 65535	NA NA
SP_S_DELAY	jrm_sp_s_delay	UDEC	0 65535	NA NA
SP_I_X_L_BAND	jrm_sp_ixl_band	UDEC	0 6	NA NA
SP_I_Y_L_BAND	jrm_sp_iyl_band	UDEC	0 7	NA NA
SP_I_X_M_BAND	jrm_sp_ixm_band	UDEC	0 6	NA NA
SP_I_Y_M_BAND	jrm_sp_iym_band	UDEC	135 142	NA NA
SP_S_X_WIN	jrm_sp_s_x_win	UDEC	0 102	NA NA
SP_S_Y_WIN	jrm_sp_s_y_win	UDEC	0 14	NA NA

Note: The Parameter "SP_IR_SAFE_TEM" (jrm_sp_ir_safe_t) has been removed to prevent the hardware.

5.10 JIRAM_TC_CAL_PAR

- JIRAM Team Name Convention = **JIRAM_TC_CAL_PAR**
- JPL Name Convention = **JRM_CAL_PAR**

JIRAM_TC_CAL_PAR (JRM_CAL_PAR)				
JRM Team, Tc's field Name Convention	JPL, Tc's field Name Convention	Type	Range	Tc Field Raw Conversion
SP_I_GAIN1_LAMP1	jrm_sp_i_gn1lmp1	UDEC	0	NA
			15	NA
SP_I_GAIN2_LAMP1	jrm_sp_i_gn2lmp1	UDEC	0	NA
			15	NA
SP_I_GAIN1_LAMP2	jrm_sp_i_gn1lmp2	UDEC	0	NA
			15	NA
SP_I_GAIN2_LAMP2	jrm_sp_i_gn2lmp2	UDEC	0	NA
			15	NA
SP_T_EXPO_BACK_IMG	jrm_sp_tex_bkimg	UDEC	0	NA
			40000	NA
SP_T_EXPO_BACK_SPE	jrm_sp_tex_bkspe	UDEC	0	NA
			40000	NA
SP_T_EXPO_LAMP1_G1_IMG	jrm_sp_tex_l1g1i	UDEC	0	NA
			40000	NA
SP_T_EXPO_LAMP1_G1_SPE	jrm_sp_tex_l1g1s	UDEC	0	NA
			40000	NA
SP_T_EXPO_LAMP1_G2_IMG	jrm_sp_tex_l1g2i	UDEC	0	NA
			40000	NA
SP_T_EXPO_LAMP1_G2_SPE	jrm_sp_tex_l1g2s	UDEC	0	NA
			40000	NA
SP_T_EXPO_LAMP2_G1_IMG	jrm_sp_tex_l2g1i	UDEC	0	NA
			40000	NA
SP_T_EXPO_LAMP2_G1_SPE	jrm_sp_tex_l2g1s	UDEC	0	NA
			40000	NA
SP_T_EXPO_LAMP2_G2_IMG	jrm_sp_tex_l2g2i	UDEC	0	NA
			40000	NA
SP_T_EXPO_LAMP2_G2_SPE	jrm_sp_tex_l2g2s	UDEC	0	NA
			40000	NA
SP_T_STAB_LAMP1	jrm_sp_t_stblmp1	UDEC	0	NA
			300	NA



Data 01/06/2011
Issue 5
Revision 0
Page 55 of 72

JUNO/JIRAM

JIRAM_TC_CAL_PAR (JRM_CAL_PAR)

JRM Team, Tc's field Name Convention	JPL, Tc's field Name Convention	Type	Range	Tc Field Raw Conversion
SP_T_STAB_LAMP2	jrm_sp_t_stblmp2	UDEEC	0	NA
			300	NA
SP_POINT_POS_LAMP1	jrm_sp_pt_polmp1	UDEEC	0	NA
			8190	NA
SP_POINT_POS_LAMP2	jrm_sp_pt_polmp2	UDEEC	0	NA
			8190	NA

		Data 01/06/2011 Issue 5 Revision 0 Page 56 of 72
	JUNO/JIRAM	

5.11 JIRAM_TC_GET_PAR

- JIRAM Team Name Convention = **JIRAM_TC_GET_PAR**
- JPL Name Convention = **JRM_GET_PAR**

JIRAM_TC_GET_PAR (JRM_GET_PAR)				
JRM Team, Tc's field Name Convention	JPL, Tc's field Name Convention	Type	Range	Tc Field Raw Conversion
SP_ID	jrm_sp_id	UDEC	0	NA
			65535	NA

		Data 01/06/2011 Issue 5 Revision 0 Page 57 of 72
	JUNO/JIRAM	

5.12 JIRAM_TC_DEF_PAR

- JIRAM Team Name Convention = **JIRAM_TC_DEF_PAR**
- JPL Name Convention = **JRM_DEF_PAR**

JIRAM_TC_DEF_PAR (JRM_DEF_PAR)				
JRM Team, Tc's field Name Convention	JPL, Tc's field Name Convention	Type	Range	Tc Field Raw Conversion
SP_ID	jrm_sp_id	UDEC	0	NA
			65535	NA

5.13 JIRAM_TC_MOTOR

- JIRAM Team Name Convention = **JIRAM_TC_MOTOR**
- JPL Name Convention = **JRM_MOTOR**

JIRAM_TC_MOTOR (JRM_MOTOR)				
JRM Team, Tc's field Name Convention	JPL, Tc's field Name Convention	Type	Range	Tc Field Raw Conversion
MOTOR_MODE	jrm_motor_mode	STR	"DESPIN"	1 (Enum)
			"POINT"	2 (Enum)
MOTOR_START_PT_POSITION	jrm_mtr_st_pt_po	UDEC	0	NA
			8190	NA
MOTOR_MIRROR_SPEED	jrm_mirror_speed	UDEC	0	NA
			65535	NA
MOTOR_MIRROR_DIRECTION	jrm_mirror_dir	STR	"CLOCKWISE"	0 (Int16)
			"COUNTERCLOCKWISE"	1 (Int16)
MOTOR_SPIN_TIME	jrm_mtr_spn_time	UDEC	0	NA
			65535	NA

		Data 01/06/2011 Issue 5 Revision 0 Page 59 of 72
	JUNO/JIRAM	

5.14 JIRAM_TC_CALIBSOURCE

- JIRAM Team Name Convention = **JIRAM_TC_CALIBSOURCE**
- JPL Name Convention = **JRM_CALIBSOURCE**

JIRAM_TC_CALIBSOURCE (JRM_CALIBSOURCE)				
JRM Team, Tc's field Name Convention	JPL, Tc's field Name Convention	Type	Range	Tc Field Raw Conversion
ID_LAMP	jrm_lamp_id	STR	"LAMP_1"	0 (Enum)
			"LAMP_2"	1 (Enum)
			"BOTH_LAMPS"	2 (Enum)
ACTION	jrm_action	STR	"OFF"	0 (Enum)
			"ON"	1 (Enum)
CURRENT	jrm_current	STR	"CURRENT_01"	0 (Enum)
			"CURRENT_02"	1 (Enum)
			"CURRENT_03"	2 (Enum)
			"CURRENT_04"	3 (Enum)
			"CURRENT_05"	4 (Enum)
			"CURRENT_06"	5 (Enum)
			"CURRENT_07"	6 (Enum)
			"CURRENT_08"	7 (Enum)
			"CURRENT_09"	8 (Enum)
			"CURRENT_10"	9 (Enum)
			"CURRENT_11"	10 (Enum)
			"CURRENT_12"	11 (Enum)
			"CURRENT_13"	12 (Enum)
			"CURRENT_14"	13 (Enum)
			"CURRENT_15"	14 (Enum)
			"CURRENT_16"	15 (Enum)

		Data 01/06/2011 Issue 5 Revision 0 Page 60 of 72
	JUNO/JIRAM	

5.15 JIRAM_TC_RESET

- JIRAM Team Name Convention = **JIRAM_TC_RESET**
- JPL Name Convention = **JRM_RESET**

JIRAM_TC_RESET (JRM_RESET)				
JRM Team, Tc's field Name Convention	JPL, Tc's field Name Convention	Type	Range	Tc Field Raw Conversion
RESET_LEVEL	jrm_reset_level	STR	"HW_RESET"	0 (Uint16)
			"SW_RESET"	1 (Uint16)

5.16 JIRAM_ERROR_LOG

- JIRAM Team Name Convention = **JIRAM_TC_ERROR_LOG**
- JPL Name Convention = **JRM_ERROR_LOG**
- Note: Locked Tele-Command

JRM_ERROR_LOG				
JRM Team, Tc's field Name Convention	JPL, Tc's field Name Convention	Type	Range	Tc Field Raw Conversion
NA	NA	NA	NA	NA

5.17 JIRAM_TC_SAFE

- JIRAM Team Name Convention = **JIRAM_TC_SAFE**
- JPL Name Convention = **JRM_SAFE**
- Note: Locked Tele-Command

JIRAM_TC_SAFE (JRM_SAFE)				
JRM Team, Tc's field Name Convention	JPL, Tc's field Name Convention	Type	Range	Tc Field Raw Conversion
NA	NA	NA	NA	NA

		Data 01/06/2011 Issue 5 Revision 0 Page 62 of 72
	JUNO/JIRAM	

5.18 *JIRAM_TC_SCIENCE*

- JIRAM Team Name Convention = **JIRAM_TC_SCIENCE**
- JPL Name Convention = **JRM_SCIENCE**
- Note: Locked Tele-Command

JIRAM_TC_SCIENCE (JRM_SCIENCE)				
JRM Team, Tc's field Name Convention	JPL, Tc's field Name Convention	Type	Range	Tc Field Raw Conversion
NA	NA	NA	NA	NA

5.19 *JIRAM_TC_MAINTENANCE*

- JIRAM Team Name Convention = **JIRAM_TC_MAINTENANCE**
- JPL Name Convention = **JRM_MAINTENANCE**
- Note: Locked Tele-Command

JIRAM_TC_MAINTENANCE (JRM_MAINTENANCE)				
JRM Team, Tc's field Name Convention	JPL, Tc's field Name Convention	Type	Range	Tc Field Raw Conversion
NA	NA	NA	NA	NA

		Data 01/06/2011 Issue 5 Revision 0 Page 63 of 72
	JUNO/JIRAM	

5.20 TIME UPDATE

- JIRAM Team Name Convention = **TIME UPDATE**
- JPL Name Convention = **JRM_ENA_TIME_UPD**

TIME_UPDATE (JRM_ENA_TIME_UPD)				
JRM Team, Tc's field Name Convention	JPL, Tc's field Name Convention	Type	Range	Tc Field Raw Conversion
NA	jrm_disab_enab	STR	"DISABLE"	0 (Enum)
			"ENABLE"	1 (Enum)

5.21 SC_ATTITUDE_AND_RATE

- JIRAM Team Name Convention = **SC_ATTITUDE_AND_RATE**
- JPL Name Convention = **JRM_ENA_ATT_DATA**

SC_ATTITUDE_AND_RATE (JRM_ENA_ATT_DATA)				
JRM Team, Tc's field Name Convention	JPL, Tc's field Name Convention	Type	Range	Tc Field Raw Conversion
NA	jrm_disab_enab	STR	"DISABLE"	0 (Enum)
			"ENABLE"	1 (Enum)

5.22 *JRM_START_HS_REC*

- JIRAM Team Name Convention = **JRM_START_HS_REC**
- JPL Name Convention = **JRM_START_HS_REC**
- Note: Locked Tele-Command

JRM_START_HS_REC				
JRM Team, Tc's field Name Convention	JPL, Tc's field Name Convention	Type	Range	Tc Field Raw Conversion
NA	NA	NA	NA	NA

5.23 *JRM_STOP_HS_REC*

- JIRAM Team Name Convention = **JRM_STOP_HS_REC**
- JPL Name Convention = **JRM_STOP_HS_REC**
- Note: Locked Tele-Command

JRM_STOP_HS_REC				
JRM Team, Tc's field Name Convention	JPL, Tc's field Name Convention	Type	Range	Tc Field Raw Conversion
NA	NA	NA	NA	NA

		Data 01/06/2011 Issue 5 Revision 0 Page 65 of 72
	JUNO/JIRAM	

6 JIRAM RISKY “TELE-COMMANDS & SETTABLE PARAMETERS”

JIRAM team recommends to JPL/LM to check and therefore to generate a warning message if the following SP parameters or Tele-Commands are within the SASF file. This will preserve the instrument’s HW from unwanted operations that might be caused by human error.

6.1 SP PARAMETERS TO BE CHECKED

Id	PT Name	Description	Warning Message
24	NADIR_OFFSET_MEC	Offset between the SC Nadir and the JIRAM boresight	“ Warning PT parameter. PT_Code = 24”
46	SP_T_STAB_LAMP1	Stabilization time for the Lamp1	“ Warning PT parameter. PT_Code = 46”
47	SP_T_STAB_LAMP2	Stabilization time for the Lamp2	“ Warning PT parameter. PT_Code = 47”
48	SP_POINT_POS_LAMP1	Point position for the Lamp1	“ Warning PT parameter. PT_Code = 48”
49	SP_POINT_POS_LAMP2	Point position for the Lamp2	“ Warning PT parameter. PT_Code = 49”
50	SP_MAX_LAMP_TEMP	Maximum temperatures for the Lamps	“ Warning PT parameter. PT_Code = 50”
73	SP_IR_STAB_TIME	IR detectors stabilization time	“ Warning PT parameter. PT_Code = 73”
82	SP_T_READOUT	IR Readout time	“ Warning PT parameter. PT_Code = 82”
85	SP_IR_SAFE_TEMP	Max temperature to operate the IR	“ Warning PT parameter. PT_Code = 85”
86	SP_MOTOR_SAFE_TEMP	Max temperature to operate the Mirror Motor	“ Warning PT parameter. PT_Code = 86”
88	SP_MOTOR_ARM_ANGLE	Angle necessary to arm the motor	“ Warning PT parameter. PT_Code = 88”
89	SP_MOTOR_MAX_SPEED	Return to zero or pointing speed	“ Warning PT parameter. PT_Code = 89”
90	SP_MOTOR_STAB_TIME	Time to stabilize the position	“ Warning PT parameter. PT_Code = 90”
91	SP_MOTOR_DEFAULT_DIR	Motor default direction	“ Warning PT parameter. PT_Code = 91”
92	SP_MOTOR_BOSIGHT_POS	Boresight position	“ Warning PT parameter. PT_Code = 92”
93	SP_MOTOR_DARK_POS	Dark Position	“ Warning PT parameter. PT_Code = 93”



Data 01/06/2011
Issue 5
Revision 0
Page 66 of 72

JUNO/JIRAM

Id	SP Name	Description	Warning Message
94	SP_MOTOR_BKG_POS	Background position	“ Warning PT parameter. PT_Code = 94”
95	SP_MOTOR_ZERO_POS	Motor Zero Position	“ Warning PT parameter. PT_Code = 95”
100	SP_PROM_SW_VERSION	PROM SW version	“ Warning PT parameter. PT_Code = 100”
101	SP_EEPROM_SW_VERSION	EEPROM SW version	“ Warning PT parameter. PT_Code = 101”
102	SP_CR_ROW	reference row position	“ Warning PT parameter. PT_Code = 102”
103	SP_START_NOISY_BITS	noisy bit loop start	“ Warning PT parameter. PT_Code = 103”
104	SP_END_NOISY_BITS	noisy bit loop stop	“ Warning PT parameter. PT_Code = 104”
112	SP_DPU_OFF	The max DPU temperature to request a SAFE ME transaction	“ Warning PT parameter. PT_Code = 112”
113	SP_DPU_MIN_TEMP	Minimum temperature (at power on) of the DPU	“ Warning PT parameter. PT_Code = 113”
114	SP_MAX_DELTA_DPU_TEMP	The temperature rate between two sequent acquisitions.	“ Warning PT parameter. PT_Code = 114”
115	SP_DPU_MAX_TEMP	Max DPU valid temperature value fore the check.	“ Warning PT parameter. PT_Code = 115”
120	SP_SC_DYN_SPINRATE_MIN	Min spinrate accepted	“ Warning PT parameter. PT_Code = 120”
121	SP_SC_DYN_SPINRATE_MAX	Max spinrate accepted (SC round of 27 sec). It is a constant value	“ Warning PT parameter. PT_Code = 121”

		Data 01/06/2011 Issue 5 Revision 0 Page 67 of 72
	JUNO/JIRAM	

6.2 *TELE-COMMANDS TO BE CHECKED*

GA Nomenclature	JPL Nomenclature	Warning Message
JIRAM_TC_UPLOAD_MEM	JRM_LOAD_FILE	“ Warning Tc: JRM_UPLOAD_MEM”



7 JIRAM TECHNICAL CONSIDERATION

7.1 IMAGER FOCAL PLANES ARCHITECTURE

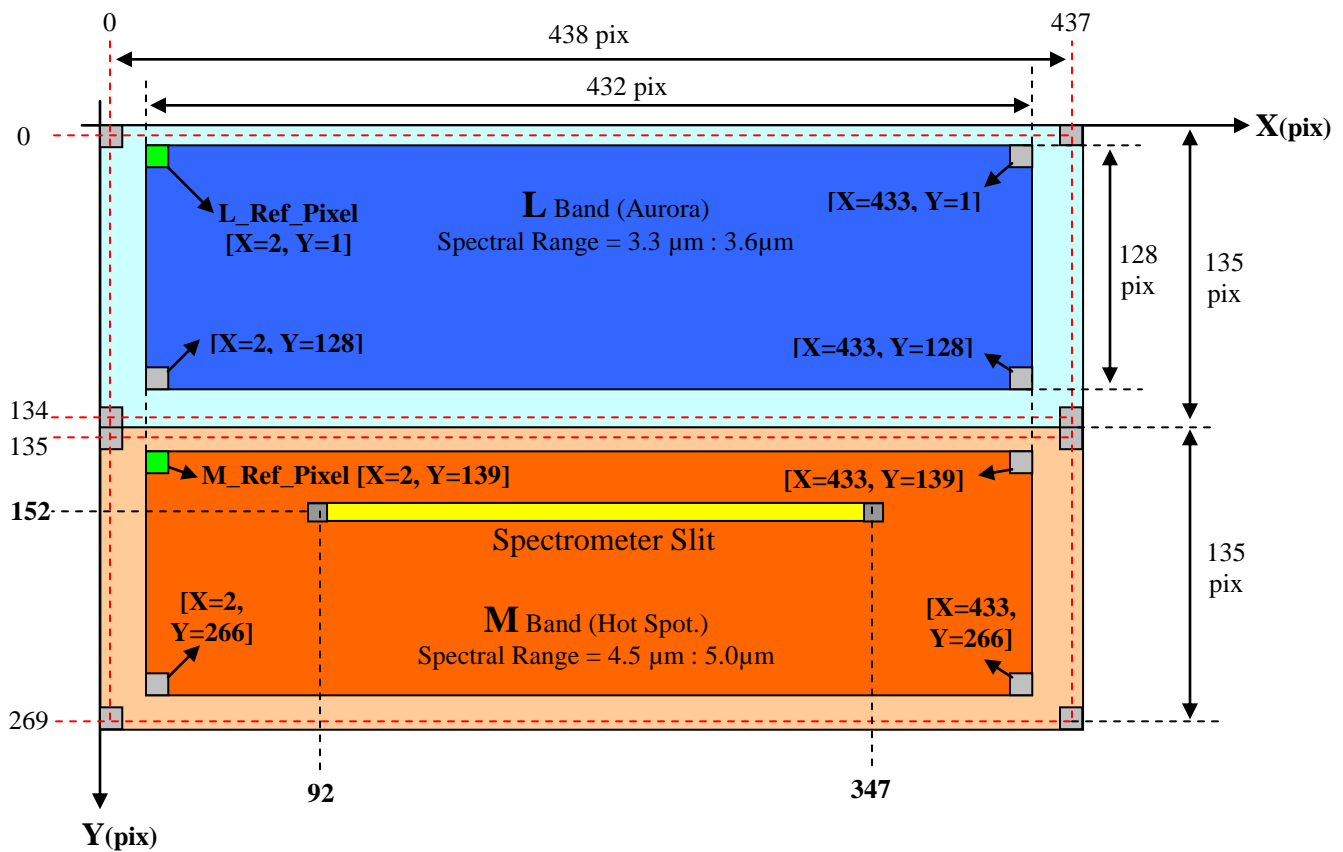

L_X_Ref_Pixel range → [0:6] pixels

L_Y_Ref_Pixel range → [0:7] pixels

M_X_Ref_Pixel range → [0:6] pixels

M_Y_Ref_Pixel range → [135:142] pixels

L_X_Ref_Pixel on board value = 2;

L_Y_Ref_Pixel on board value = 1;

M_X_Ref_Pixel on board value = 2;

M_Y_Ref_Pixel on board value = 139;



Data 01/06/2011
Issue 5
Revision 0
Page 69 of 72

JUNO/JIRAM

7.2 SPECTROMETER FOCAL PLANE ARCHITECTURE

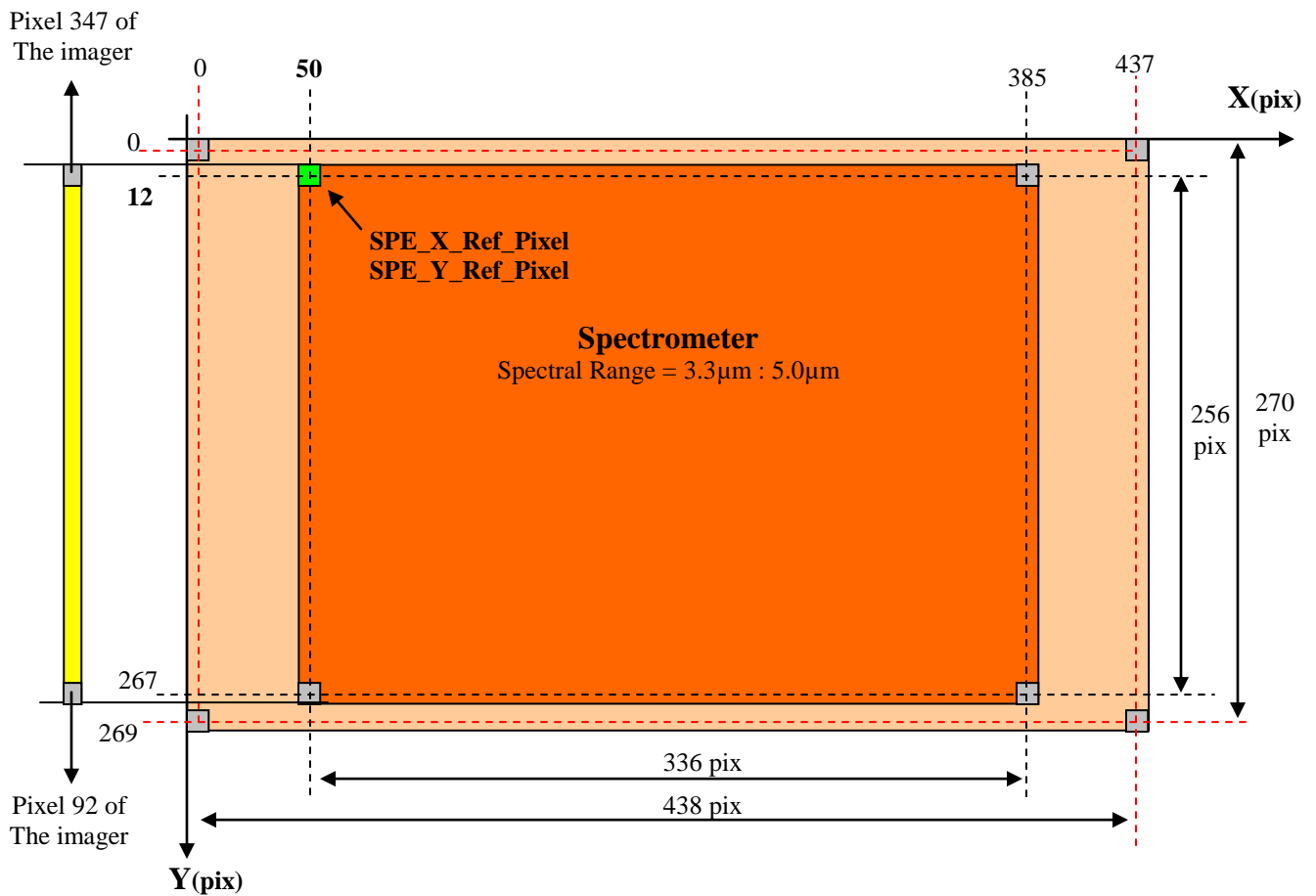

SPE_X_Ref_Pixel range → [0:102] pixels
SPE_X_Ref_Pixel range → [0:14] pixels

SPE_X_Ref_Pixel on board value = 50;
SPE_Y_Ref_Pixel on board value = 12;

7.3 JIRAM HEATER OPERATIONS

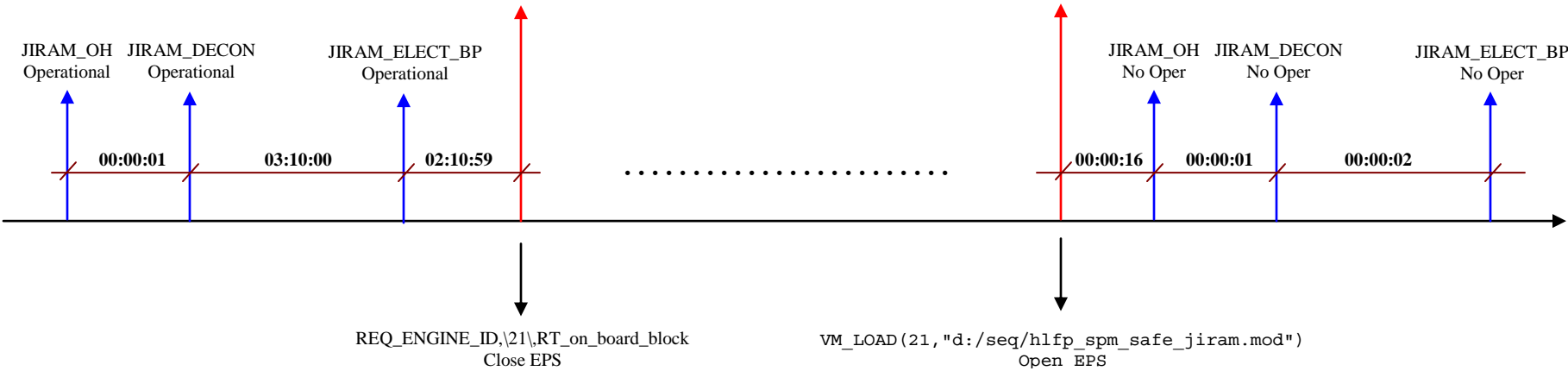



Data 01/06/2011
Issue 5
Revision 0
Page 71 of 72

JUNO/JIRAM



Data 01/06/2011
Issue 5
Revision 0
Page 72 of 72

JUNO/JIRAM