

2014

Downtown Providence Farmers Market Design

Lindsay Dansereau

Matthew Eckel

Kate Ford

Joanna Grocott

Tyler Harriott

See next page for additional authors

Follow this and additional works at: http://docs.rwu.edu/cpc_aud

 Part of the [Urban, Community and Regional Planning Commons](#)

Recommended Citation

Dansereau, Lindsay; Eckel, Matthew; Ford, Kate; Grocott, Joanna; Harriott, Tyler; Nelson, Zachary; O'Malley, Amanda; Palmer, Jessica; Sanchez, David; Schall, Eric; Thompson, Sarah; Piermarini, Anthony; Guastafeste, Lindsay; and Robinson, Arnold, "Downtown Providence Farmers Market Design" (2014). *Architecture and Urban Design*. Paper 14.
http://docs.rwu.edu/cpc_aud/14

This Document is brought to you for free and open access by the Community Partnerships Center at DOCS@RWU. It has been accepted for inclusion in Architecture and Urban Design by an authorized administrator of DOCS@RWU. For more information, please contact mwu@rwu.edu.

Authors

Lindsay Dansereau, Matthew Eckel, Kate Ford, Joanna Grocott, Tyler Harriott, Zachary Nelson, Amanda O'Malley, Jessica Palmer, David Sanchez, Eric Schall, Sarah Thompson, Anthony Piermarini, Lindsay Guastafeste, and Arnold Robinson



Downtown Providence Farmers Market Design

Community Partner:
The Providence Redevelopment Agency

Academic Partner:
The School of Architecture, Art
and Historic Preservation

Spring 2014



The Roger Williams University Community Partnerships Center

The Roger Williams University (RWU) Community Partnerships Center (CPC) provides project-based assistance to non-profit organizations, government agencies and low- and moderate-income communities in Rhode Island and Southeastern Massachusetts. Our mission is to undertake and complete projects that will benefit the local community while providing RWU students with experience in real-world projects that deepen their academic experiences.

CPC projects draw upon the skills and experience of students and faculty from RWU programs in areas such as:

- American Studies
- Architecture and Urban Design
- Business
- Community Development
- Education
- Engineering and Construction Management
- Environmental Science and Sustainability
- Finance

- Graphic Design
- Historic Preservation
- History
- Justice Studies
- Law
- Marketing and Communications
- Political Science
- Psychology
- Public Administration
- Public Relations
- Sustainable Studies
- Visual Arts and Digital Media
- Writing Studies

Community partnerships broaden and deepen the academic experiences of RWU students by allowing them to work on real-world projects, through curriculum-based and service-learning opportunities collaborating with non-profit and community leaders as they seek to achieve their missions. The services provided by the CPC would normally not be available to these organizations due to their cost and/or diverse needs.

CPC Project Disclaimer: The reader shall understand the following in regards to this project report:

1. The Project is being undertaken in the public interest.
2. The deliverables generated hereunder are intended to provide conceptual information only to assist design and planning and such are not intended, nor should they be used, for construction or other project implementation. Furthermore, professional and/or other services may be needed to ultimately implement the desired goals of the public in ownership of the project served.
3. The parties understand, agree and acknowledge that the deliverables being provided hereunder are being performed by students who are not licensed and/or otherwise certified as professionals. Neither RWU nor the CPC makes any warranties or guarantees ex-

pressed or implied, regarding the deliverables provided pursuant to this Agreement and the quality thereof, and Sponsor should not rely on the assistance as constituting professional advice. RWU, the CPC, the faculty mentor, and the students involved are not covered by professional liability insurance.

4. Neither RWU, the CPC, the faculty mentor, nor the students involved assume responsibility or liability for the deliverables provided hereunder or for any subsequent use by sponsor or other party and Sponsor agrees to indemnify and hold harmless RWU, the Center, the Faculty Mentor, and the Center's student against any and all claims arising out of Sponsor's utilization, sale, or transfer of deliverables provided under this Agreement.

Community Partnerships Center
Roger Williams University
One Old Ferry Road
Bristol, RI 02809
cpc@rwu.edu
<http://cpc.rwu.edu>



Kate Ford presents her design ideas to the Providence Redevelopment Agency Steering Committee.

Table of Contents

Introduction.....	4
Methodology.....	5
Site Analysis	6
Precedent Studies	7
Suggestions for Success.....	11
Design Options.....	12
Conclusion.....	48

Team Members: Lindsay Dansereau | Matthew Eckel | Kate Ford | Joanna Grocott | Tyler Harriott | Zachary Nelson | Amanda O'Malley | Jessica Palmer | David Sanchez | Eric Schall | Sarah Thompson
 Faculty: Visiting Architect Anthony Piermarini of Studio Luz in Boston
 ARCH 515 - Graduate Architectural Design Studio
 CPC Staff Researchers: Matthew Eckel | Lindsay Guastafeste

Thank you to the members of the Steering Committee at the Providence Redevelopment Agency for your guidance and support of this project:
 Angel Tavares – Mayor, The City of Providence | Don Gralnek – Executive Director | Sherry Griffith – Farm Fresh Rhode Island | Lucy Searl – Farm Fresh Rhode Island | Kenneth Levy – Johnson & Wales University | John Bowen – Johnson & Wales University | Cliff Wood – Providence Foundation | Kenneth Ayars – State of Rhode Island D.E.M | Jan Brodie – I - 195 Redevelopment District Commission | Arnold Robinson – Roger Williams University

Introduction

In the fall of 2013, The Providence Redevelopment Authority (PRA) applied to the Roger Williams University Center for Community Partnerships (RWU CPC) for a project to explore the programming, siting and design of a food center facility on land under the control of the I-195 Commission. The PRA application was selected, and the project was undertaken by the RWU School of Architecture Art and Historic Preservation.

Led by visiting faculty of Studio Luz Architects of Boston, MA, the Arch 515 Graduate Design Studio was a 15-week intensive investigation of ephemeral architecture and development of an urban food market for the City of Providence. The studio explored ideas as a partnership between the RWU CPC and key members of the Providence community devoted to bringing a market to the area.

Students had an opportunity to inform the future planning and design of a new urban market space, which may contribute to the revitalization of the downtown Providence area. Students met with a steering committee once a month to discuss the development of their proposals, engage with real community concerns and create new dialogue about food, city life and design. This committee was made up of prominent citizens, members of Farm Fresh and institutional representatives as well as state and city officials who have signifi-

cant influence in the development of the area. This committee served as a tremendous resource for the group with insights into the culture, market and political forces operating on any publicly sponsored venue. The goal of the studio was to study the viability of an open urban market for Providence as well as to explore architecture that is intended to be temporary, ephemeral and highly adaptive to changing programmatic constraints.

Studio Premise

Many cities are searching for ways to bring locally grown and organically produced food to areas where there is a lack of access to healthy alternatives. Urban marketplaces often become venues that can host a variety of farmers including produce, meats, poultry, fish, dairy, chocolates, baked goods, soaps, herbs, spices, arts and crafts, and household services. The studio challenge was to understand how these ephemeral and temporary markets may be injected into a community and thrive. How does one determine the most relevant and effective site for these civic and commercial endeavors? What impacts and effects do temporary buildings have on a community? Can they serve to foster community interaction and develop a sense of place? How does architecture and urban design engage with a growing “locavore” culture and its associated events?



Proposed market plaza perspective by Amanda O'Malley.

Methodology

Students met with the Providence Food Center Steering Committee each month throughout the semester for a total of five meetings. These meetings followed the progress of the studio and gave the committee a range of options and issues to explore in their evaluation of the project. The results of the studio are a combination of community and pedagogical goals, ensuring that the educational value of the studio was paramount. This insistence on intellectual rigor inspired the steering committee and moved the conversation to help realize the full potential for the project.

The studio was broken down into various phases of investigation culminating in well-developed proposals with full-scale mock-ups and installations at the RWU School of Architecture gallery.

Phase 1

Precedent Studies Students researched and cataloged markets of various forms and scales from around the world. The result is an interesting cross-section of market types that speak directly to the cultural and socio-economic roots of the region.

Phase 2

Site Mapping: Making Camp Students developed analytical maps that revealed the urban systems operating at the scale of the region and local urban environment. This macro/micro analysis allowed the group to evaluate sites with the greatest potential for development. There were initially four sites established by the steering committee, and, based on the student's

work, certain sites were eliminated and a new site added. Most parcels were provided by the I-95 Commission; however one was a City of Providence-owned parcel. Students produced master plan strategies for all of the sites given by the Providence Food Center Steering Committee in order to arrive at two preferred parcels.

Phase 3

Tectonics: Prototype Vendor Stand This is where students explored the logic of assemblies and architecture as a construction craft — to use a Kenneth Frampton reference. The studio researched material properties (how they behave, how are they detailed) as well as assembly processes for different constructs and then observed how the implied detail can motivate a response to program and site. Students designed prototype

vendor stands that could produce logical variations, i.e. be adaptable to various vendors and be aggregated into a larger holistic organization.

Artifact Deployment The results of the experiments with tectonics were scaled up, aggregated and recomposed into a larger architectural construction. This helped to define the programmatic agenda as well as organize the site. In conjunction with the development of a project thesis, students developed a full program document that further refined their understanding of the food market and the potential of the site(s) to support the nuances of the program. Students were encouraged to use combinations of parametric formal systems and ready-made components.

Proposed market section by Eric Schall.

Phase 4

Building Synthesis and Installation Design In this phase, students focused on a more holistic response to the city, the site, the program and their process. Each student designed a presentation that was to be considered an extension of the experience and construction logics of their design proposal. It is an installation that grounds itself in the conceptual and material realities of the design as proposed. The presentation integrated models, drawings, text and infographics relevant to the design. Elements of the market module and other systems were built full scale as part of the presentation.

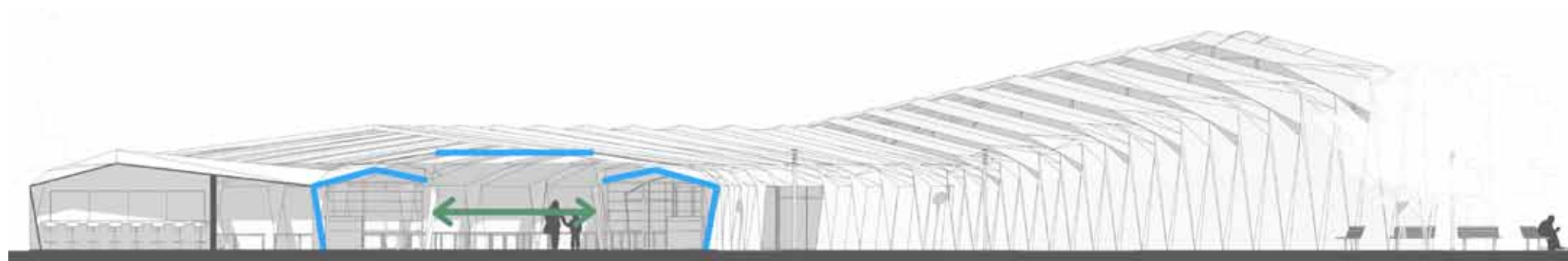

Site Analysis

The Providence Redevelopment Agency proposed four sites in downtown Providence. Each of the sites is currently owned by the Redevelopment Agency. Three of the sites fall within the I-195 Redevelopment District with the other located in the Capital Center area. Additional sites were also included as perspective areas of study along the I-195 corridor.



1. Map of site #9.
2. Map showing sites 1 through 4 as proposed by the Providence Redevelopment Agency.

Precedent Studies

The Pop-Up Market

Description: The pop-up market is generally organized by local groups with minimal municipal support. They are characterized as places where small vendors can set up a simple tent and display tables of goods. Pop-up markets are highly mobile with a small footprint. The vendors are expected to bring everything they need to the market; very little is provided by the organizers other than schedule and location. Some are augmented with local music, arts or events if space allows.

Scale: Small to extra-large (varies).

Hours: Varies

Avg. Vendor Stall: 10x10' or 10x30' if tailgate style market.

Site Conditions: Roadside, open green space, urban park, parking lot.

Shelter: Tents and canopies installed by vendors during hours of operation.

Infrastructure: Plug-in power from lamp posts, generators and vendor-provided power source or none. Portable toilets may be present.

Funding Structure: Vendor rent w/ supplemental public support.

Precedent Projects: Roslindale Village Farmers Market; Millarville Farmers Market; Chatham Borough Farmers Market; Coventry Regional Farmers Market; Lewiston Farmers Market; New Orleans Wine and Food Experience; Muscott Farmers Market; Union Square; Surfer's Paradise; Aquidneck; Mt. Hope Market; Colt State Park Market.

The Modular Market

Description: Modular markets are usually structured for flexibility and organization. Modules organize the floor plan, the structure or both. Modular units are usually deployed and customized by

vendors depending on their needs and based on climate, aesthetics or stall layout. Modular markets are adaptable to different sites and configurations within a big city or small town.

Scale: 1-20 vendors; small to medium.

Hours: Varies.

Avg. Vendor Stall: 10x10'

Site Conditions: Roadside, open green space, urban park, alleyways, parking lots, underutilized urban spaces. Sites are exploited for unique qualities and inspire the market display.

Shelter: Semi-permanent stalls that remain on site for vendors to use.

Infrastructure: Plug-in power from municipality or vendor-provided power source. Rare cases of portable toilets or public bathroom facilities.

Funding Structure: Vendor rent with public support.

Precedent Projects: Seine River Market Stalls; Greenmarket; Artist's Colony Market.



2



1



3

1. The Mount Hope Farmers Market in Bristol, RI, is held inside an existing barn during winter.

2. The summer Millarville Market in Alberta, Canada has more than 160 vendors.

3. Green Markets (movable) stalls in the Czech Republic.

The Destination Warehouse Market

Description: Destination warehouse markets utilize a structure as market shelter. These structures can be long span roofs, a collection of roof canopies or even old renovated buildings. Sometimes the buildings are pre-existing; other times they are built specifically to house a market. Destination warehouse markets range from semi-enclosed to completely enclosed, depending on



the type of structure. All utilities are on-site as part of the base of the building and are provided for both vendors and customers. These buildings are very flexible and allow for a multitude of vendors and events: there are upwards of 20 vendors who each rent their own individual stall/space. Since they are semi-enclosed or enclosed, they are open seven days a week, year-round. These markets are central to community life function.

Scale: 20+ vendors; medium to large.

Hours: 7 days a week



Avg. Vendor Stall: Range 10x10' - 20x20'

Site Conditions: Adjacent to parking or public transit; central to community.

Shelter: Long span roof, collection of roof canopies, semi-enclosed/enclosed, passive heating and cooling.

Infrastructure: All utilities are on on-site and provided for vendors as part of the base building.

Funding Structure: Vendor rents.

Precedent Projects: Torvehallerne Market; Delicious Orchard; Columbus Farmers Market; Pawtucket Wintertime Farmers Market; Mercato Centrale Di San Lorenzo; West Side Market; Mercato Alimentare Santambrogio; Kariakoo Market; Abergavenny Food Festival; Santa Caterina Market; Barceloneta; Great Market; Mercado de Picos.

The Production/Distribution Market

Description: This market means business. This is where commercial fishermen and other farmers sell

their products for wholesale prices to restaurants, grocery stores and other markets to the highest bidder. The markets are usually in industrial areas near major transportation networks and waterfronts within big warehouses where the product is displayed and bid on. The market operates 24/7 but business hours are usually only during the morning unless they also serve as a food market.

Scale: Large, wholesale vendors, local farm with retail area.

Hours: Normal business hours – 24 hrs/day.

Avg. Vendor Stall: N/A

Site Conditions: Industrial districts, waterfronts, proximity to shipping or freight train.

Shelter: Warehouse facility.

Infrastructure: Utilities on site.

Funding Structure: Wholesale.

Precedent Projects: Boston Flower Market; Johnson's Roadside Market.

The Franchise Market

Description: A franchise market is a chain of the same market with various locations all over the world. They typically have some theme that influences what they sell, whether it is organic products or a specific cultural food. Franchises are good because customers are familiar with the brand and know that the products are trustworthy.

Scale: Medium to large.

Hours: Generally 8 a.m.- 10 p.m.

Avg. Vendor Stall: N/A



1. Santa Caterina Market in Barcelona, Spain was once a convent and was refurbished in 2005.

2. Mercado de Picos in Puebla, Mexico has an iconic exterior design.

3. Marche Movenpick is a franchise market/restaurant with locations all over the world.

Site Conditions: Retail commercial spaces, urban or suburban.

Shelter: Permanent facility.

Infrastructure: All utilities on site.

Funding Structure: Structured by franchise corporation.

Precedent Projects: Eataly; Marche Movenpick.

The Industrial Hybrid Market

Description: This market essentially combines a marketplace with an existing or new industrial building. The hybrid created results in space that has daily retail sales and hours, as well as other goods available at other times. The industrial aspect typically acts as the anchor, as the market's activities help attract a different group of consumers at other business times. An example of this would be a seafood supply warehouse that also provides dining and entertainment as a nightlife destination.

Scale: Medium to large.

Hours: 24/7 seasonal.

Avg. Vendor Stall: Varies.

Site Conditions: Industrial districts, waterfront.

Shelter: Large complexes divided up by different vendors.



centers and other public facilities. These additional programmatic spaces help to support the public market. Residents and workers are likely to become regular market consumers. It is this sustainability that distinguishes the super hybrid market from other market types.

Scale: Extra large.

Hours: N/A

Avg. Vendor Stall: 10x10' - 10x20'

Site Conditions: Housed within or among other building types.

Shelter: Super hybrid markets are large permanent structures, which allow for the infrastructural support of the various programmatic functions of the building.

Infrastructure: On-site utilities.

Funding Structure: Tenant rent.

Precedent Projects: Rotterdam Market Hall.

Infrastructure: Large-scale industrial building containing market inside.

Funding Structure: Wholesale, retail.

Precedent Projects: Aquidneck Lobster Market/Lobster Bar; Tokyo Metro Central.

The Super Hybrid Market

Description: The super hybrid market is generally organized by a large group and typically requires municipal and/or private support. This market has a very large footprint, permanent vendors and is often combined with housing, offices, shopping



1. Newport, Rhode Island's Aquidneck Lobster Company is an example of the industrial hybrid market.

2. The new Rotterdam Market Hall in the Netherlands combines food, leisure, living and parking in one building.

The Bazaar Market

Description: A bazaar is a permanent enclosed marketplace or a street of shops where goods and services are exchanged or sold. The term *bazaar* is also sometimes used to refer to an open-air marketplace, a commercial quarter or the network of merchants and craftsmen who work in that area.

Scale: Large.

Hours: 6-7 days a week.

Avg. Vendor Stall: Varies.



Site Conditions: Located within cities, sometimes taking up entire neighborhoods.

Shelter: Small, street-side shops, large complexes divided up by different vendors or a combination of the two.

Infrastructure: All utilities are on-site and provided for vendors as a part of the base building. In some cases there may not be any utilities at all.

Funding Structure: Vendor rents.

Precedent Projects: Grand Bazaar; Chor Bazaar; Panjiayuan Jiuhuo Shichang; Khan el-Khalili Bazaar.



The Pavilion Market

Description: Pavilion markets typically consist of an open-walled building in which vendors purchase a space to sell their products. Visitors get the feeling of being under cover, while at the same time being outdoors. The scale is usually small to medium size, with the number of vendors inside varying. The markets can be open daily or once a week seasonally.

Scale: Small to medium.

Hours: Varies.

Avg. Vendor Stall: 10x10'

Site Conditions: Located within a city, not taking up much space. Almost like an icon within a city.

Shelter: Overhead roof canopy with open walls on all sides.

Infrastructure: Some plug-in power may be provided on site. In some cases, there are portable toilets or public bathroom facilities.

Funding Structure: Vendor rents.

Precedent Projects: Covington Farmers Market; Alemany Farmers Market; Putnam Saturday Farmers Market; Besiktas Fish Market.



1. Panjiayuan Jiuhuo Shichang in Beijing, China is a vast outdoor weekend market.
2. Khan El-Khalili Bazaar in Cairo, Egypt has been in constant use since the 14th century.
3. The pavilion-style Besiktas Fishmarket in Istanbul, Turkey.
4. Covington Farmers Market in Virginia is an open plaza beneath a covered structure.

Suggestions for a Successful Urban Market in Providence

After students completed the precedent study, they suggested that the Providence Redevelopment Agency consider the following when planning for the new urban market.

While there are many types of food markets, those that are open on a daily basis typically have a formal enclosure system. Unlike pop-up markets with vendor-supplied tents, these food halls are

within a more permanent structure. In order to adhere to RI Department of Health codes, refrigeration must be provided for vendors; this would require utility connections within vendor clusters. These markets may solely be used as a space to sell goods or be a hybrid allowing for events, retail or industrial/production function.

The location of the food market should have proximity to major functions of the city to attract the public. A market that is not currently located in a heavily traveled part of Providence should be iconic with enough public functions to entice consumers. As a commuter market, it would be ideal to have a connection to major roadways, public transportation and clusters of commercial buildings.

The Providence Food Market, open daily, should provide an enclosure system or covering to allow for operation year-round, relate to the urban fabric and be an icon linking Providence to local food production.



Section of proposed market with demonstration kitchen by Jessica Palmer.

Design Options

Lindsay Dansereau

Located on axis with Memorial Boulevard, parcel 4 has a total square footage of 47,157 sq. ft. This site is both highly visible and has high potential development value. In addition to its prime location on one of Providence's main roads, the parcel offers sweeping views to the Providence River. The proposed five-acre riverfront park abuts the site on the east. The planned City WALK path will cross



the new bridge providing a strong connection between parcels on both sides of the Providence River. The proposed street car route traveling down Memorial Boulevard will also provide a connection to the center of downtown Providence, as well as the Rhode Island Hospital district. A farmers market and food center on this parcel will serve as a vibrant public space for community connections and has the potential to become the first market street in the downtown area.

This project will serve college students, professionals and families. Guests have many choices when visiting the site: walking around the market and

bringing food home; attending a cooking demonstration, a lecture or concert; or relaxing and sitting down for a quick meal. A central demo-kitchen between Memorial Boulevard and the new pedestrian park will serve as an educational venue for Johnson & Wales University. This venue will become the major focal point on the site, attracting guests from both Memorial Boulevard and the park. The layout is intended to be easily accessible and will be adjacent to the market stalls.

Market stalls shall include prepared foods, arts and crafts, fruits and vegetables and seafood. The tiered layout of these market stalls incorporates a

raised floor system. Within this floor system there is the potential to provide heating and cooling. Vents within the floor can disperse air within the market stalls. The floor system and the stalls themselves are organized within a hexagon or honeycomb-shaped grid. Several of the stall walls will be movable while others will remain fixed. The movable walls will slide along a track hidden within the raised floor system. The movement of these walls is limited to one direction. This concept allows the plaza to be flexible. There are certain layouts that create many small spaces and others that create several small and large spaces for people to gather.

1. Site plan.

2. Perspective of market through the demo kitchen.

Program

Prepared Food Stalls

- 3,900 sq.ft.
- 5 stalls (780 sq.ft. each).
- 3 vendors each minimum.
- Lining the street with semi-permanent, prepared food stalls.

Arts and Crafts Stalls

- 2,600 sq.ft.
- 10 stalls (260 sq.ft. each).
- 1 vendor each minimum.
- Lining 30% of the park edge with arts and craft stalls.
- Walls can be customized to be shelves or flat walls to hold artwork. Small crafts and trinkets are showcased on the upper shelves.

Fruit and Vegetable Stalls

- 5,460 sq.ft.
- 21 stalls (260 sq.ft. each).
- 1 vendor each minimum.
- Lining 20% of the park edge and 20% of Memorial Boulevard with fruits and vegetables stalls.
- Walls have plenty of lower storage bins.



Seafood Stalls

- 4,160 sq.ft.
- 16 stalls (260 sq.ft. each).
- 1 vendor each minimum.
- Lining 30% of the park edge with seafood stalls.

Demo Kitchen and Auditorium

- 1,820 sq.ft.
- Central location between Memorial Boulevard and the park; area is intended to be easily accessible.

- Major focal point on the site; adjacent to the fruits and vegetables, seafood and prepared food stalls.

Services

- Square footage to be determined (based on occupancy load).
- Centrally located on the site; include restrooms, storage and loading dock.
- Restrooms and storage for tables and chairs are adjacent to the demo kitchen, seafood and prepared food stalls.

Flex-Dining Space

- 4,160 sq.ft.
- 4-8 seats per vendor.
- Adjacent/behind prepared food stalls.
- Shared walls have artwork displayed.
- May overlap with circulation.

Circulation/Open Space

- Approximately 23,860 sq.ft.

Gathering Area

- 1,040 sq.ft.
- Adjacent to Dorrance Street and the park; area intended to be a support space for the arts and crafts stalls; craft events held here.
- Focal point on the site (MUST be smaller than the demo kitchen/auditorium).

Parking, Transportation and Loading/Unloading

Although parking will be limited to food trucks and delivery vehicles, there are many places where guests can park off-site. Parking garages and outdoor parking lots are located within proximity to the parcel. There are two parking facilities that offer 24-hour parking.

Perspective of cafe seating area with market stalls in background.

The main access points to the site are the following:

- Memorial Boulevard (north or south) via car, bike, proposed street car, bus or walking.
- The proposed pedestrian bridge/park via bike or walking (reaches out to neighborhoods across the river).
- Ship Street via car, bike or walking.

The southernmost portion of the site has been designated as the drop-off zone. Ship Street lies perpendicular to the site, and the extension of this road as a drop-off area is a great choice. The ground will be covered with strong small gravel, which allows both pedestrians and trucks to use this space. Even a wheelchair and dolly will be able to travel smoothly on the gravel.

Enclosures, Mobility and Wayfinding

Market Stalls

The market is made up of moveable walls which can be customized per vendor's needs.

- These walls are made of wood and would be painted with a protective sealant to prevent rotting from the elements.
- The prepared food stalls that line the street can provide signage for pedestrians and cars passing by the site.

- Many of the walls are placed on sliders, but these sliders may be replaced with wheels (the degree of flexibility based on client, vendor and consumer needs).

Demo Kitchen

The demo kitchen serves as a monumental symbol for the farmers market itself — the roof can be seen from distances, attracting attention to the market. This infrastructure has the capability of being entirely enclosed. The fabric structure has arched entryways and openings, which can create an enclosed space or be zipped up when it is not in use.

Private Kitchen and Restrooms

The restrooms and private kitchen are the more permanent infrastructure, and these have the ability to serve as wayfinding markers on the site. The site is long, but the width of the site allows guests to appreciate the surroundings.

The Hexagon Grid

The diagonal provides a more interesting way of experiencing an open urban market.

- Circulation is not as direct. The diagonal adds a maze-like quality to the layout, which encourages people to wander throughout.

Floor plan showing hexagon grid structure of the market.

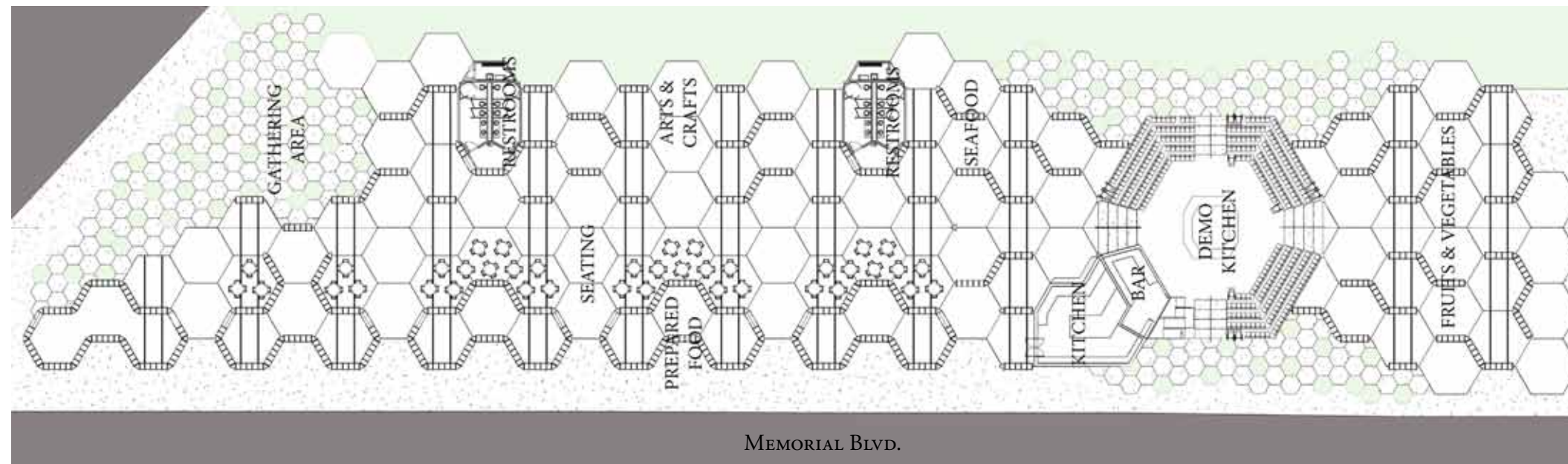

- This grid creates a path that is seen as a journey; it is not simply from point A to point B, but there are stops in-between.
- Market stall walls are placed on axis with the six sides of the hexagon. These walls can be transported to other sites and provide flexible layouts on all sites, however the walls would be most successful if they are used in conjunction with a hexagonal grid system, as this system allows for the above explained experience.

Mechanical

Heating and Cooling

- Vendors are encouraged to bring their own space heaters and fans to cool or heat their areas. Rentals could be an option.
- Heat will be used 3-4 months out of the year.
- Cooling will be used 1-2 months out of the year.

Plumbing (occupancy to be determined)

Toilets/Stalls

- One per 30 female occupants.
- One per 60 male occupants (50% urinals).
- 1/3 of stalls must be ADA-compliant.

Lavatories

- One per 100 occupants.

Drinking Fountains

- One per 100 occupants.

Materiality

Modules

Spacesaver Corporation, spacesaver.com

Membrane for the Roof Design

MDT-tex Membranes & Structures, mdt-tex.com

Raised Platform for Floors

Spacesaver Corporation, spacesaver.com

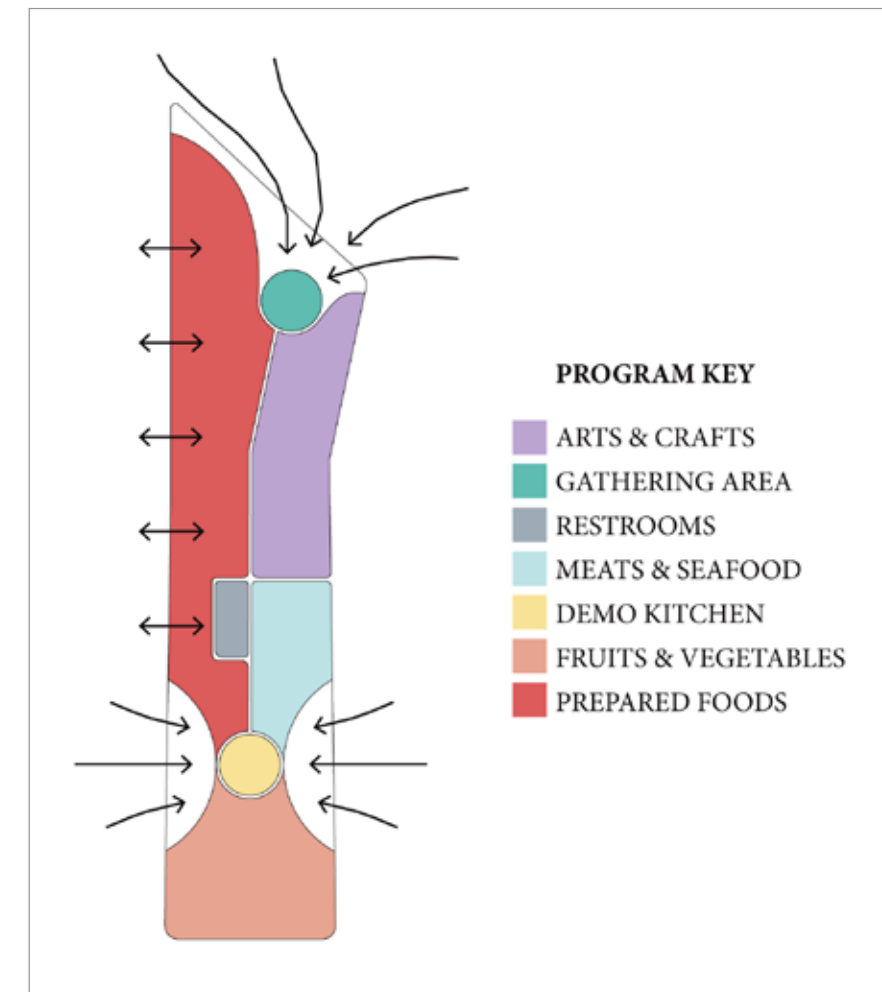

Program.

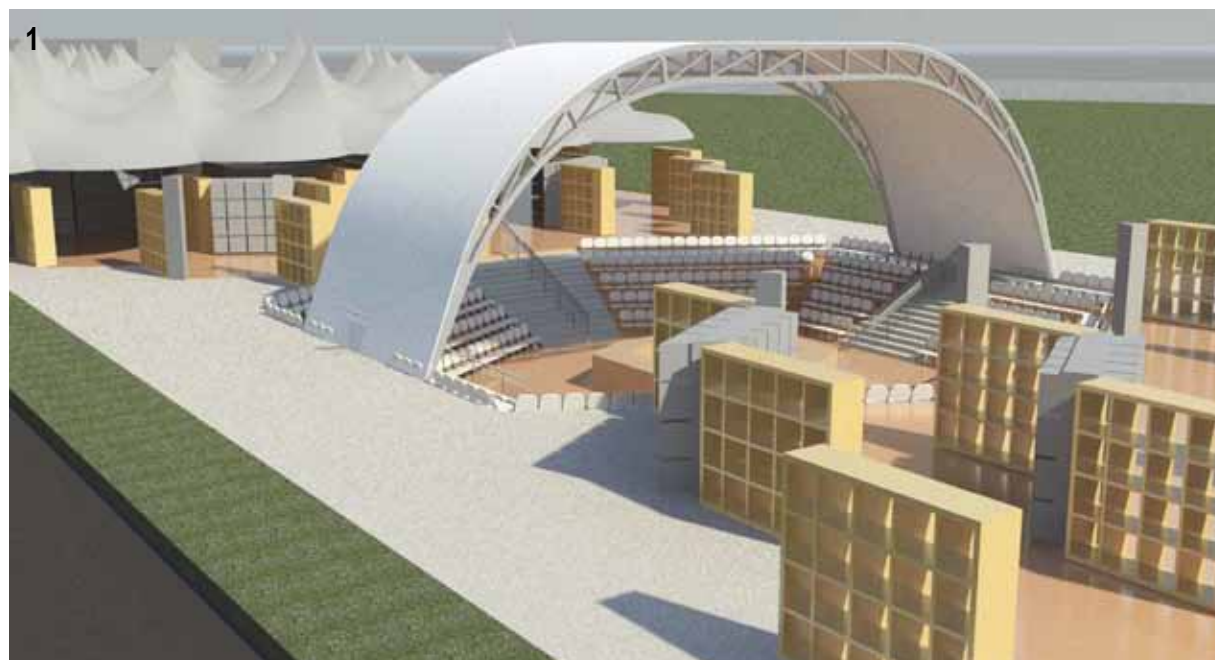

1. Market overview perspective.
2. Exterior market perspective from Memorial Boulevard.
3. Section through demo kitchen.

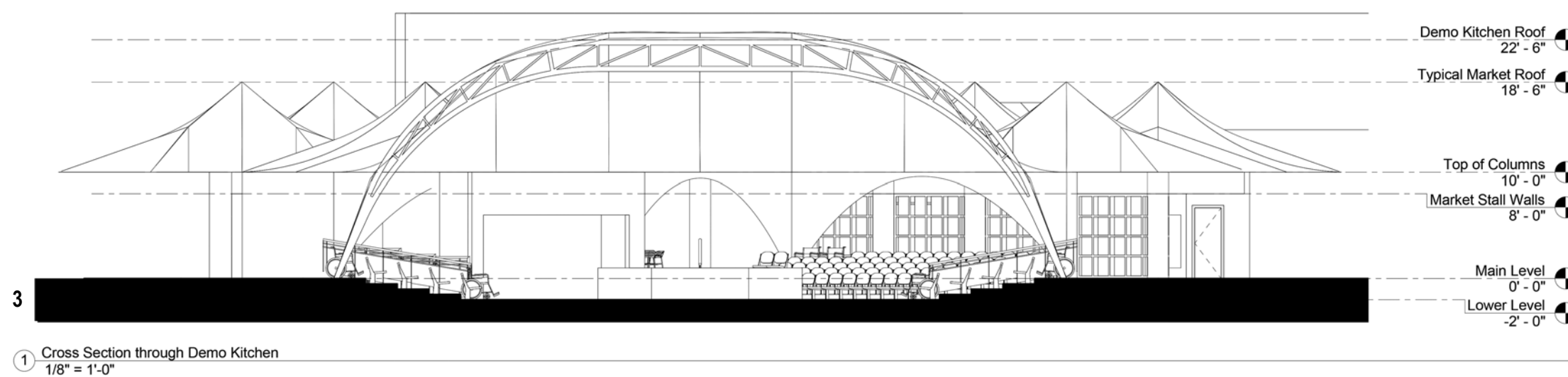

Design Options

Matthew Eckel

Site 9 is part of a large residential area of Providence near the exit 2 off-ramp for I-195. Many potential customers, especially nearby college students, would be interested in a market in this area.



The vision for this site is to create a place where people can come to the market any day of the week to pick up food, sit down for a meal, learn how to cook, see a lecture or concert, or enjoy a drink at the wine bar. The building should serve as a place where the community can be educated about the market process, from how everything is grown or made to how it is transported.

The architecture should be temporary, as well as easy to assemble and dismantle. Not in need of full enclosure, the market is to be more open with the market stalls conveying similar design ideals throughout. The event space, cafe and demo kitchen are required to have the ability to be fully enclosed in regards to walls on all sides with some sort of roof structure or material. Mechanical systems will not be needed; only access to electricity and water will be necessary.

Program

TOTAL: 26,572 sq. ft.

Market

- 16,844 sq. ft.
- To include section for fresh meat, poultry and seafood, fresh produce, prepared foods, retail/arts and crafts, and a flower shop. The temporary and mobile stalls will be allocated for the fresh produce and other vendors that will only be able to come to the market 2-3 times a week.

Event Space

- 4,424 sq. ft.
- To accommodate lectures, concerts, school events, workshops and plays.
- To accommodate flexible seating and outdoor seating, prepared foods and a wine bar.
- To accommodate kitchen and preparation areas as well as seating for 200-300 people.



1. Aerial perspective of market.
2. Perspective of demo kitchen.
3. Site plan.



Outdoor Dining

- 5,304 sq. ft.
- To accommodate seating and tables for the fish market and event space.

Outdoor Courtyard

- To accommodate food truck parking, pop-up tents for seasonal markets and seating.

Bathrooms

- **Accessibility:** All bathrooms to be ADA-compliant.
- **Toilets:** One per 30 female occupants; one per 60 male occupants.
- **Lavatories:** One per 100 occupants for each gender.
- **Drinking Fountains:** One per 100 occupants for each gender.

Storage/Service

- 500-700 sq. ft.
- To accommodate storage for temporary stalls, garbage disposal and for extra supplies from vendors.
- To provide easy access for trucks.

Food Truck Parking

- To accommodate food trucks as well as regular trucks in the front and back of the building.

1. Perspective of garden area.

2. Ground floor plan.

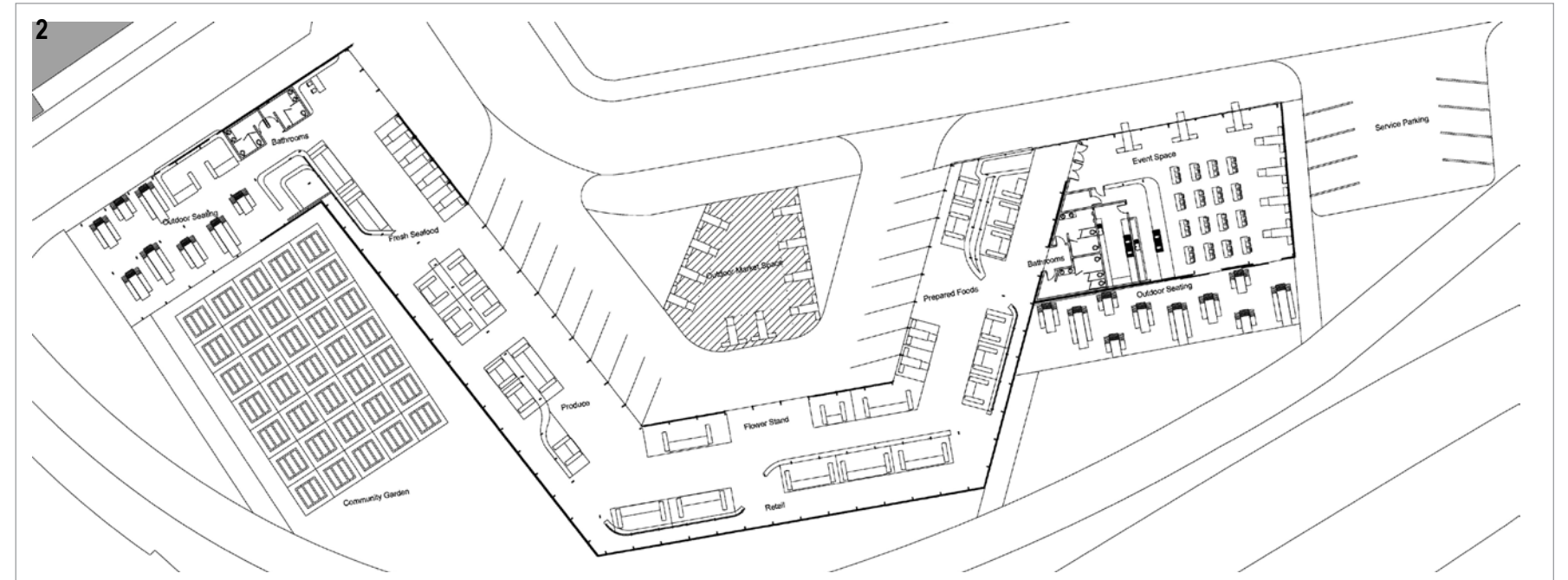

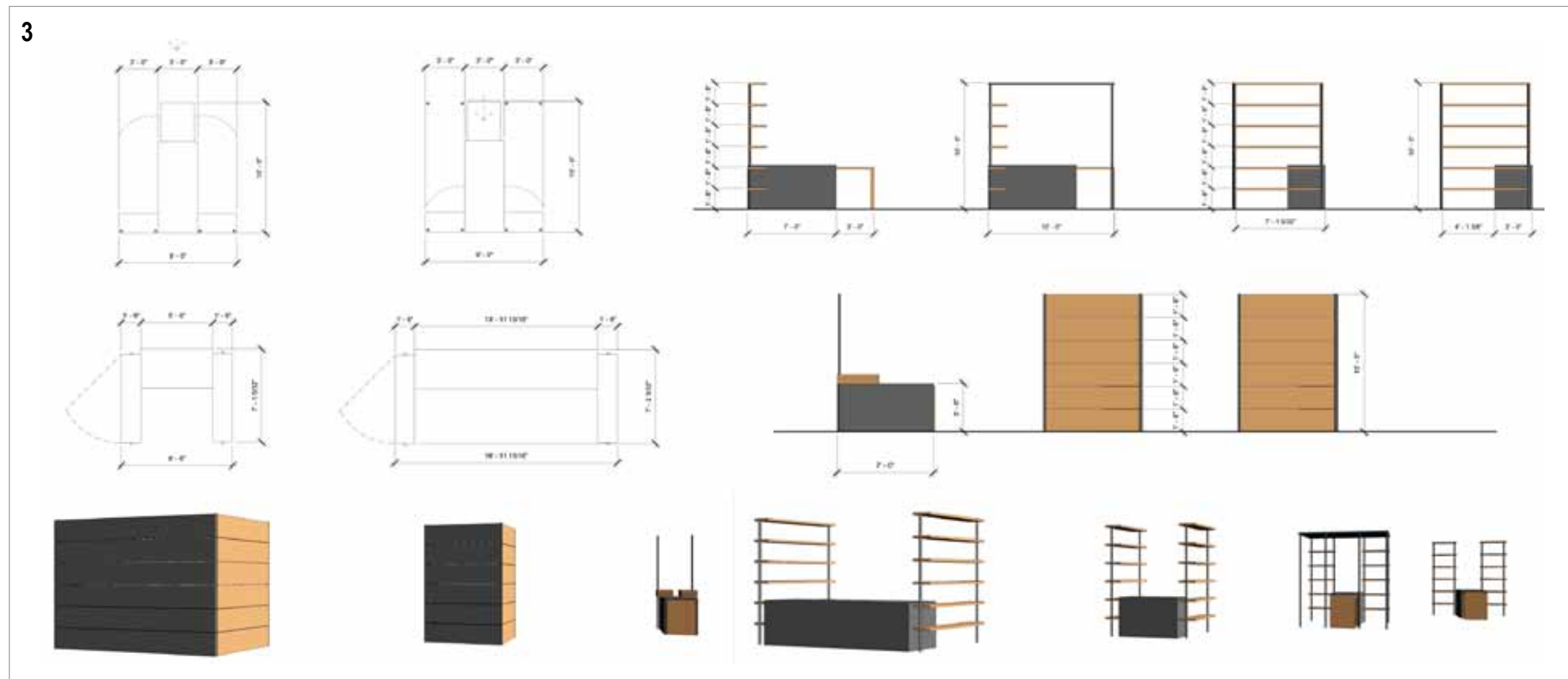

1. Perspective of market stalls.

2. Perspective of market entry.

3. Diagram of various vendor strategies in market stall configuration.

Design Options

Kate Ford

Parcel 9, located at Fox Point in Providence, is the most desirable site to create a temporary open urban market. At the edge of a major residential and college area, this site offers plenty of locals and tourists access to locally grown food and products. The bike path wraps around the site, creating foot traffic and a destination for people who are travel-

ing from the new pedestrian bridge up the river. Exit 2 off I-195 borders the site as do two parking lots, which allows easy access for people around the state to visit and shop at the market.

Through the combination of steel, wood and a green pergola system, my design transforms this

empty site into a dynamic temporary urban market. Because of the greenery, the market will have a different appearance every season. The plant chosen for the pergola will be profitable because it gives the opportunity for creating a product such as wine. This design is both versatile and flexible. If the demand for space changes in the future,

modules can be added or taken away. This is done through a steel grid that covers the whole site and a simple wood paneling facade that can be assembled and disassembled quickly.



1. Site plan.
2. Perspective of market interior with a living, green pergola system.

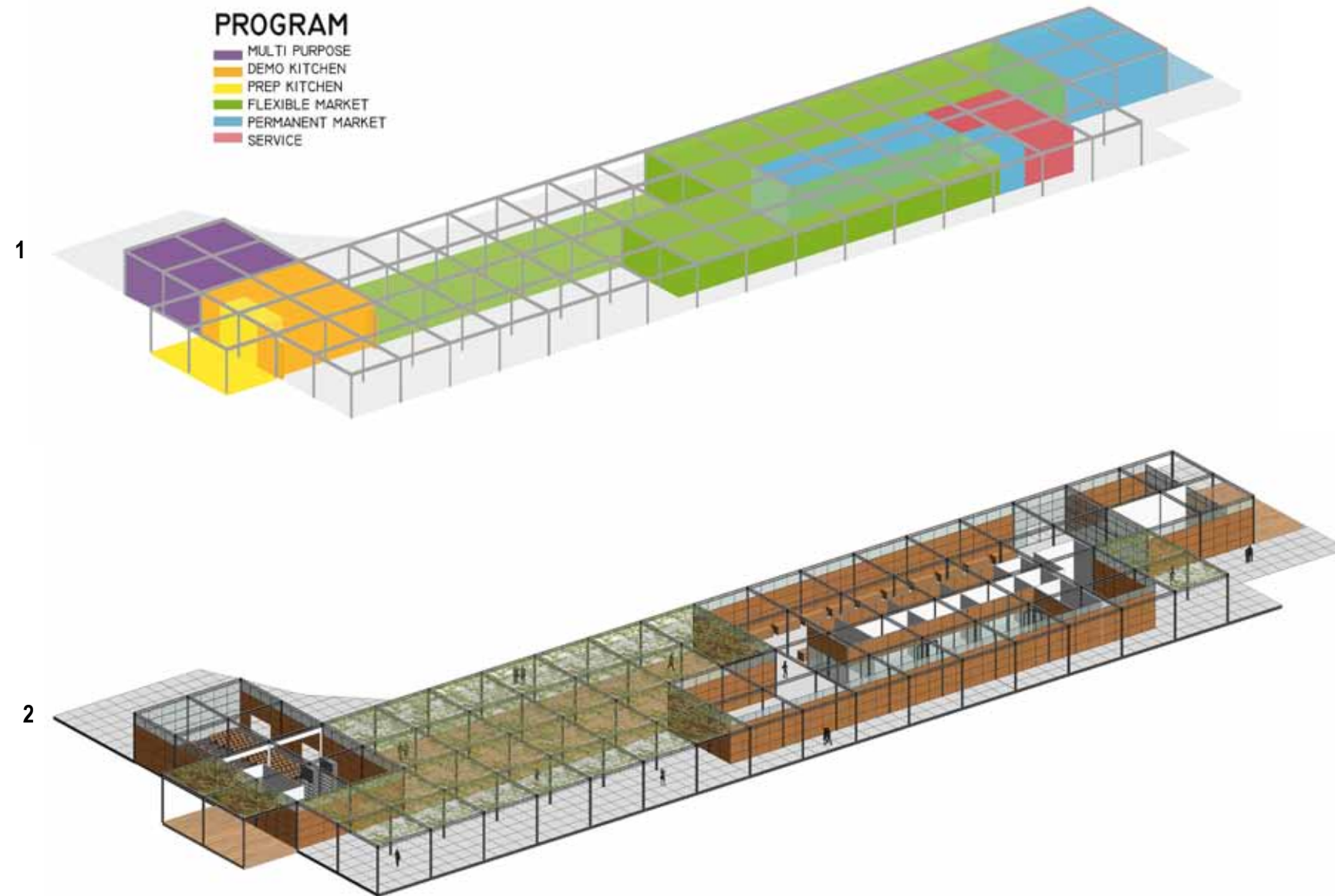

1. Program.

2. Axonometric diagram
of site.



1. Perspective from the bike path, which wraps around the market.

2. Perspective of flexible space used as a night bar.

3. Section.



Design Options

Joanna Grocott

Parcel 4, located on the corner of Dyer and Dorrance Street in Providence, is a 46,000 square-foot parcel and is part of the leftover land created with the re-routing of highway I-195. The



immediate infrastructure surrounding it includes Brown University Continuing Education, Warren Alpert Medical School of Brown University, Family Court and an assortment of businesses. Parcel 4 is about 700 feet offset from the Providence River.

The open market located on parcel 4 is a seven-day market. This market will become a destination space by having permanent vendors present 5-7 days every week and by having a focus on health and community support. The market will be able to bring in a large population on single days when the food market takes up the majority of the land.

To activate the space, the open area needs an iconic focus. This takes the form of an elevated walkway, which will provide river views and auditorium seating for any entertainment. Since most of the structures will be made of plywood sections, the lifespan of this market is only 3 - 4 years, and then most of the structures will need to be recycled or disabled.

Program

J&W Demonstration Kitchen

- 1,000 sq. ft.
- Enough space to present to a large seated audience as well as an intimate group.
- Large-scale kitchen.

Market

- 16,900 sq. ft.
- A combination of anchor and rotating vendors to bring people into the site.
- 54 stalls: 8,100 sq. ft.
- Multiple of 10'x10' with 10' for expansion and circulation.
- 5-7 day residents.

Prepared Takeout/Eating

- 1,200 sq. ft.
- Restaurant specializing in quick food for lunch crowd or take-home dinners for after work.

Coffee Shop

- 800 sq. ft.
- A study spot for area students.

Children Day Care

- 800 sq. ft.
- Convenient place for families who work in the surrounding area; the children can take advantage of play areas throughout the site.

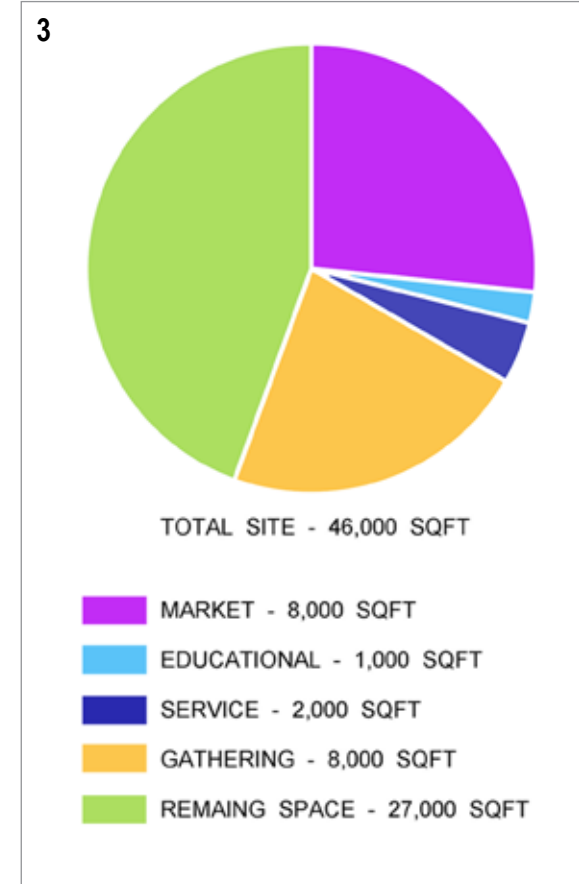

1. Site plan.
2. Aerial perspective of market.
3. Program.

Seafood

- 1,000 sq. ft.
- Place to sell fresh seafood.

Frozen Yogurt

- 800 sq. ft.
- Sweet and healthy place to bring in a later crowd.

Bakery

- 1,000 sq. ft.
- Fresh baked goods to draw people in.

Fitness

- 800 sq. ft.
- Exercise program to go along with eating healthy.
- Can hold yoga classes.

Multipurpose

- 3,000 sq. ft.
- Space to hold performances during the winter that would have taken place in the auditorium.
- Can house overflow of the market, a dance or other entertainment venue.



Perspective from elevated walkway.

Bathroom

- **Accessibility:** All bathrooms to be ADA-compliant.
- **Toilets:** One per 30 female occupants; one per 60 male occupants (50% urinals).
- **Lavatories:** One per 100 occupants.

Required Exterior Spaces

- **Elevated Walkway:** ADA pedestrian walkway elevated from the ground allows for views of the water and places for entertainment.

Circulation

- 6,160 sq. ft.
- Relaxation and viewing spaces: 1,000 sq. ft.
- Planters accompanying relaxed wooden seating and shading.

Café Seating

- 200 sq. ft.
- Three tables and 12 chairs fixed.

J&W Auditorium

- 2,000 sq. ft.
- Seats 300 people looking into the J&W demonstration kitchen.
- Also acts as exit ramp.

Large Auditorium

- 7,200 sq. ft.
- Seats 1,200 people looking onto a stage that can support music, performances and movies.
- Also acts as exit ramp.

Relax and Play

- 2,400 sq. ft.
- Area in between market stalls to allow for small gathering space, places for art, seating, and games.

Required Hardscaped

- **Vehicle Service:** Two separate areas to access both sides of the site with enough space for an average box truck.

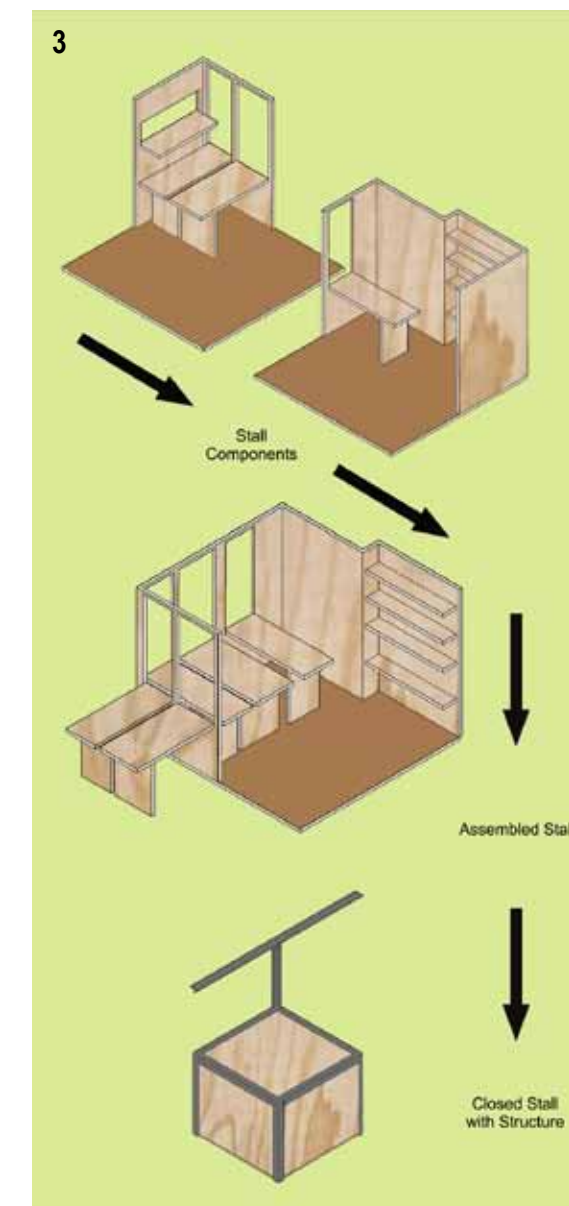

1. Section.
2. Perspective of market with view of river.
3. Diagram of flat pack stall made of plywood.

Design Options

Tyler Harriott

Located on site 2, parcel 27, the Providence temporary market will provide a place for residents and college students alike to get fresh produce and meats, cheeses, baked goods, plants and other freshly prepared foods. It will act as a place for

engagement between vendor and customer, where the purchaser knows where their food came from and that it is of the highest quality. A demonstration kitchen onsite acts as a covered space for cooking events and allows the public to learn how to cook a variety of dishes.

The site is located within walking distance of local colleges and several parking lots, so there only needs to be limited parking onsite. The site shall be designed to accommodate a connection to the Brown University area, becoming a stopping point for daily commuters.

Program - Interior Spaces

Total Built Area: 16,100 sq. ft. plus bathrooms and circulation.

Market Stalls

- 45 stalls
- 8,000 sq. ft. (including circulation between vendors).



1. Site plan.
2. Perspective of market interior with roof closed.

Demonstration Kitchen

- To allow space for produce, meats, cheeses, baked goods, freshly prepared foods and arts and crafts.
- The markets stalls measure 10'x10', which includes area for storage, cash exchange and product display.
- 2,400 sq. ft. (with gathering/multipurpose space).
- To allow 200-300 people to enjoy and partake in various cooking demonstrations, while also being a covered space for cooking displays and exhibitions.



Bathroom

- **Accessibility:** All bathrooms to be ADA-compliant.
- **Toilets:** One per 30 female occupants; one per 60 male occupants (50% urinals).
- **Lavatories:** One per 100 occupants for each gender.

Program - Exterior Spaces

Outdoor Gathering

- 2,100 sq. ft.
- To accommodate spaces for the public to eat and hang out throughout the day, while also allowing for events and gatherings to happen at different times of the year. This will act as a flex space, where many different events can happen within one area.

Circulation and Social Space

- 3,600 sq. ft.
- This is the residual space between the market vendors, where impromptu events and smaller vendors may set up.

Parking

- Off-Site.

1. Perspective from back of market with roof open.

2. Section.





1. Aerial perspective of market.

2. Terrace market perspective.



Design Options

Zachary Nelson

The temporary food market being proposed for site 2, parcel 27, in Providence will be a multi-use space for the diverse population of downtown Providence. Situated between Brown University’s medical buildings and Johnson & Wales University’s city campus and within walking distance of pedestrian-friendly Westminster and Weybosset Streets, parcel 27 is a prime location for successful integration into the urban fabric of the area.

The site itself is approximately 28,000 square feet located on a corner site of Richmond Street and Clifford Street.

The market will provide a space where residents, students and workers can buy fresh produce, meats, prepared foods and various goods. The forum-like space is designed to be useful for more than just a market. Other programmatic facilities

include a demo kitchen, which will be overseen by Johnson & Wales University, as well as a multi-use space capable of holding various events. The site is designed to allow for multiple access points on all sides. Terraces help define spaces and deal with the level change.

Program - Interior



1



2

1. Perspective of market exterior.

2. Site plan.

Market Stalls

- 48 stalls
- 4,800 sq. ft.
- These consist of 10’x10’ stalls, which are the point of sale between vendor and consumer. They allow for the display of products as well as shelter.

Demonstration Kitchen

- To allow for 200-300 people to enjoy and partake in various cooking demonstrations, while also being a covered space for cooking displays and exhibitions.
- To be integrated into the flexible space.

Bathroom

- **Accessibility:** All bathrooms to be ADA-compliant.
- **Toilets:** One per 30 female occupants; one per 60 male occupants (50% urinals).
- **Lavatories:** One per 100 occupants for each gender.

Pavilion

- 3,500 sq. ft.
- This is to be flexible space that can lend itself to an array of uses such as extra market space, demonstration space or event space. This should be adjacent to the demo kitchen as the gathering area for the demo classes.

Program - Exterior

Outdoor Gathering

- 3,500 sq. ft.
- To provide spaces for the public to utilize for different activities throughout the day, while also allowing for events and gatherings to happen at different times of the year.

Food Truck Space

- 1,200 sq. ft.

- This space is to accommodate the lines created by the food trucks. This space should be flexible by nature and create a buffer between food truck and market stall. There should be enough room for five trucks to park along the extension of Clifford Street.

Miscellaneous

- 600+ sq. ft.
- Space for impromptu gatherings and events or seating and dining areas.

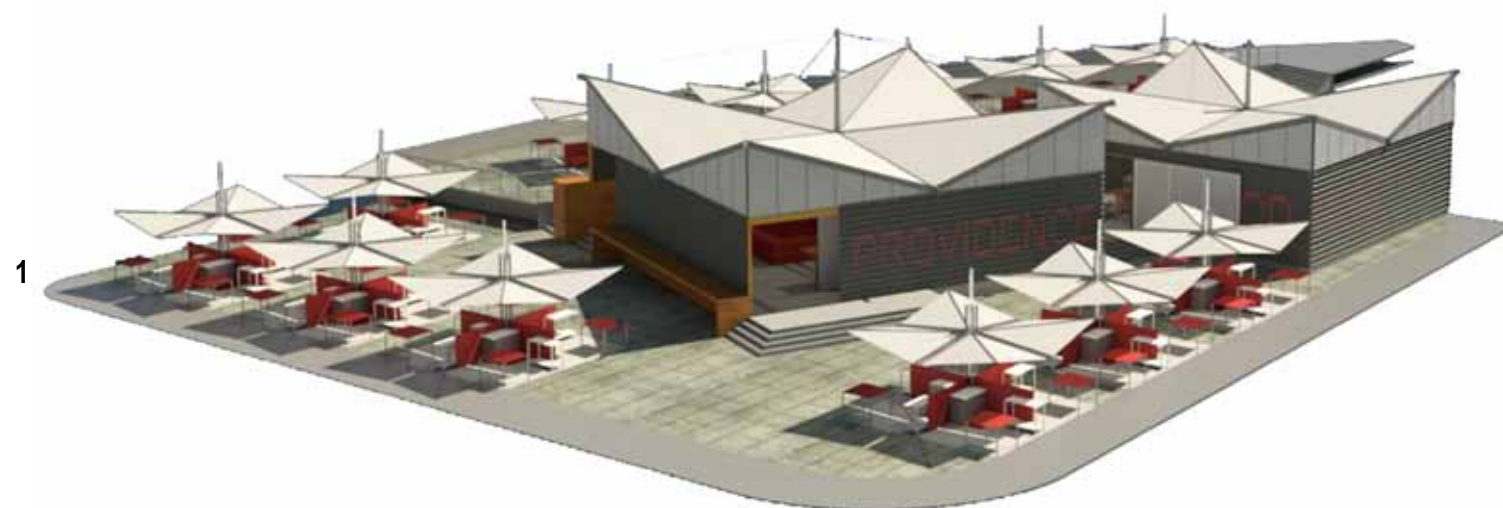

1. Axonometric view of the market when it's open.

2. Perspective of market interior.

3. Diagram of market stall.

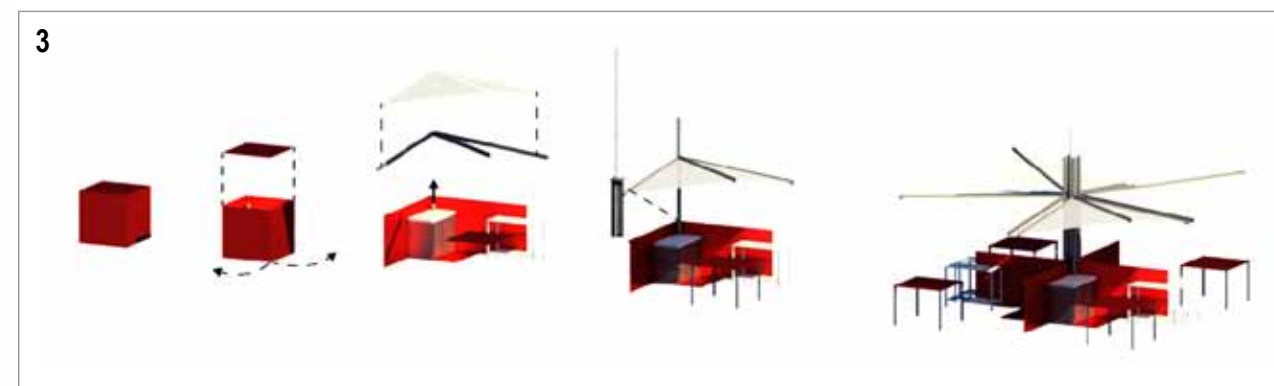

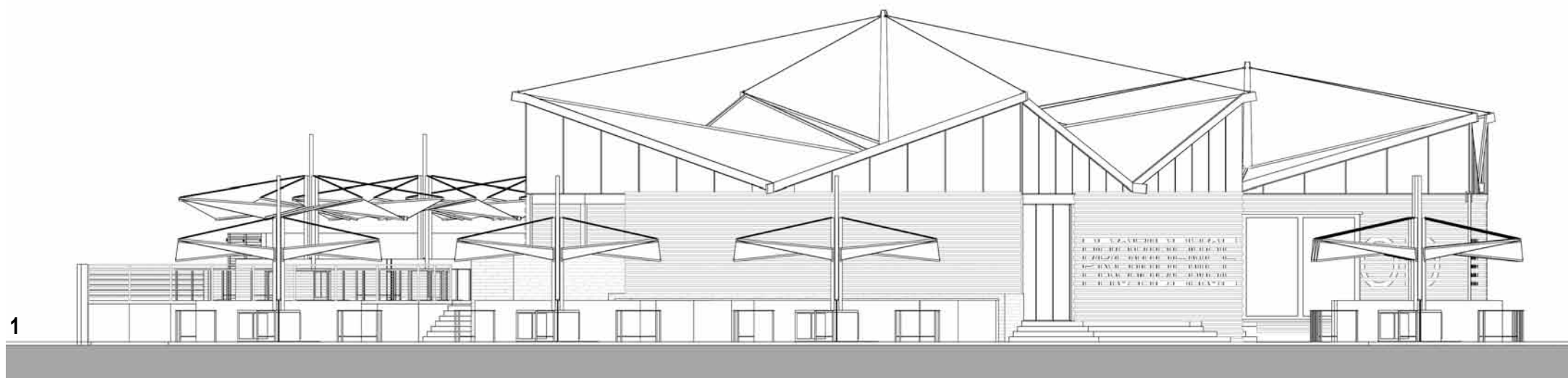

1. Section.

2. Perspective of demonstration area and flexible use space.

3. Site perspective.



Design Options

Amanda O'Malley

Site 1, parcel 12 — the Kennedy Plaza Urban Market — provides civic space and market space to attract the diverse demographic of downtown Providence. The market would provide lunch attractions for local workers, an evening grocery for residents and a space for specialized urban events like Waterfire and academic events linked to Brown University and RISD. Flexible civic space linked to the outdoors allows for concerts, art galleries, lectures and casual gathering space.

The urban market acts as a public park, capping Kennedy Plaza, providing more public space and encouraging the gathering and spontaneity associated with markets. Such a public park allows for new uses after its seven-year life span. Should the market choose to close, the structures and landscaping create a framework for urban gatherings and events without the market. The two forms on the site activate the space in between, encouraging interaction between market uses and gathering.

The market would include:

- Market space
- Multi-function space
- Demo kitchen
- Back of house space
- Storage
- Bathroom
- Outdoor flex space



1. Perspective of the plaza to be used as flexible civic space.

2. Perspective of the market space.

3. Site plan and program.

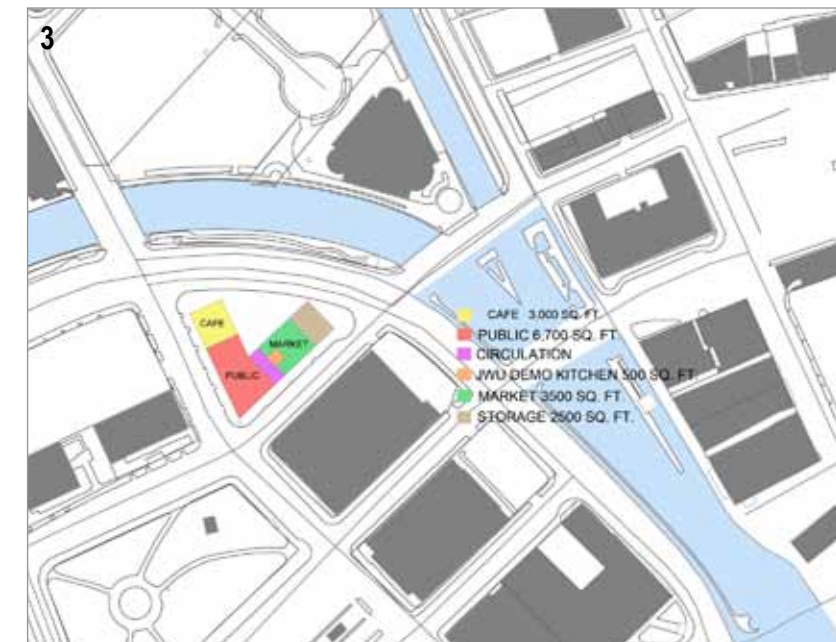

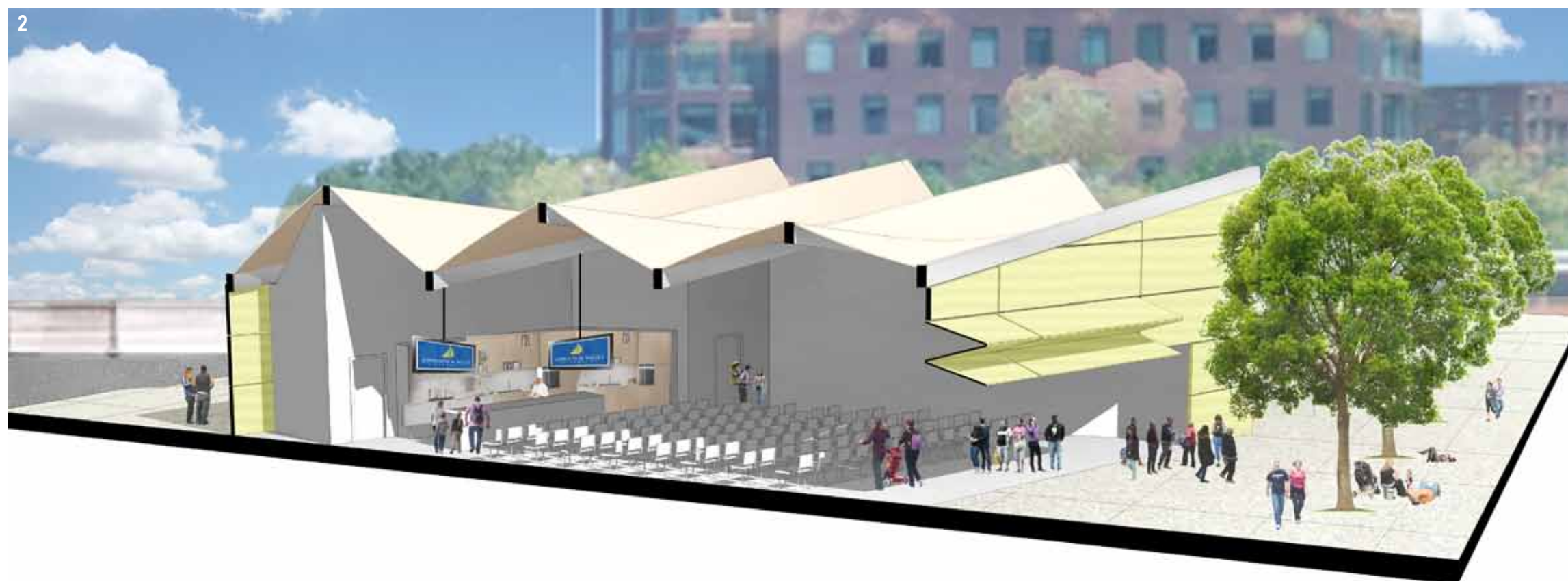
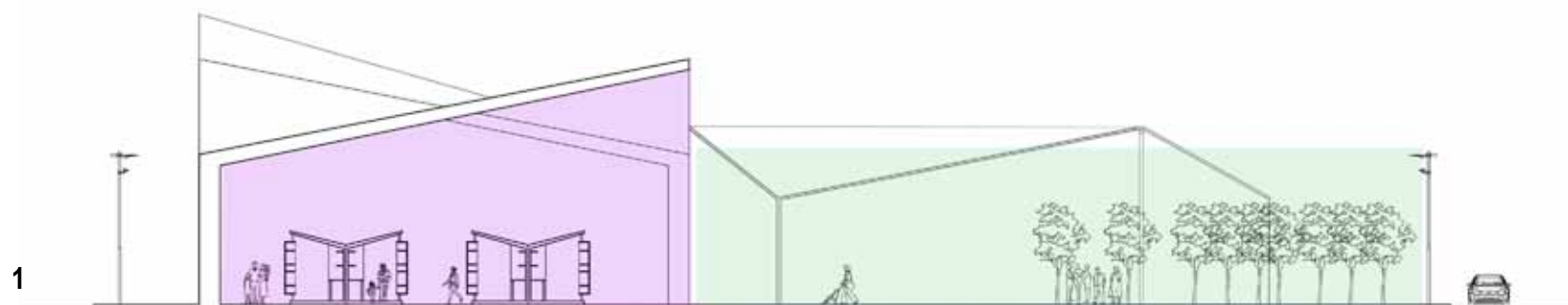

1. Section.

2. Perspective of civic space section with demo kitchen.



1. Section perspective.

2. Approach to the market
in Kennedy Plaza.

Design Options

Jessica Palmer

Fox Point Market is a community facility, which will serve as a market space that can accommodate commerce, civic life and cultural events in Providence. However, this space will have a limited life span of 3-4 years, and, therefore, must have a very light footprint while accommodating a changing program and harsh seasonal shifts.

Parcel 9, located in Providence, has been selected as the site for the open urban market. It is located in the dense residential East Side of Providence, known as the Fox Point district, and includes around 53,750 square feet of buildable area. Parcel 9 is bounded by the Providence and Seekonk rivers, Interstate 195, and the College Hill and Wayland neighborhoods. The site was selected for

its potential to generate foot traffic from residents, students and commuters in the area.

Fox Point Market consists of both covered module market stalls and an indoor flexible, multipurpose space. Shipping containers have been selected to create the modular market stall because of their temporary nature and low cost. Fox Point Market holds the street edge with a series of storefront stalls while it draws in consumers to the covered shopping area. With a few minor cuts and a fresh coat of paint, each container takes on its own persona, adding richness to the market. By using translucent roofing panels, the market is flooded with light, yet protected from the elements.

The covered market stalls become the building blocks of the flexible multipurpose space; this allows for anchor vendors to set up shop year-round, while lending itself to larger events or specialty markets. Also located indoors is the Johnson & Wales (JWU) demonstration kitchen, which (when not being utilized for shows by JWU) acts as food and bar service for a daily lunch crowd or customizable events. The open flexible space caters to both large and small audiences, maxing out at about 300 people. Whether being used for demonstrations, private events, food festivals or markets, Fox Point Market has the ability to accommodate their needs with enough storage and service for the ease of transitioning between uses.

Program - Interior

Shipping Containers

- 20' shipping containers: 160 sq. ft. each
- 40' shipping containers: 320 sq. ft. each
- The 20' shipping containers can accommodate either one or two vendors, while the 40' shipping containers can accommodate between



1. Exterior perspective of market front entry on Traverse Street.

2. Site plan.

one and four vendors depending on desired stall size, square footage and openings.

- 60% of the stalls should be 80-160 sq. ft.; 25% should be 160-240 sq. ft. and 15% should be 240-320 sq. ft.

Circulation Hardscape

- 5,150 sq. ft.
- Hardscape should be used not only for circulation, but for servicing stalls, display, shopping and gathering. Should be between 75-100% of the modular market stall square footage.

Entry Space

- 500 sq. ft.
- The main entrance should be accessible from both Traverse Street and the modular market, and should act as a filter into the multipurpose space.



Multipurpose Space

- 3,000 sq. ft.
- Must be flexible for banquette uses (tables and chairs), lecture layouts (chairs and stage) or exhibition purposes (stalls/stands). The space will also serve as a food market for daily programs.

Service and Storage

- 840 sq. ft.
- Must include storage for seating and vendors that is easily accessible from the flexible space. Also needs to be accessible for trucks to load and unload.

Demonstration Kitchen

- 815 sq. ft.
- Must service the multipurpose space for demonstrations and other events, as well as daily functions including food service.

Bathrooms

- **Accessibility:** All bathrooms to be ADA-compliant.

- **Toilets:** one per 30 female occupants; one per 60 male occupants (50% urinals).
- **Lavatories:** one per 100 occupants for each gender.
- **Drinking Fountains:** one per 100 occupants for each gender.
- **Service Sink:** one service sink per floor.

Utility Space

- Easily serviceable to all spaces.

Program - Exterior

On-Site Parking

- 5,300 sq. ft.
- Area for food trucks to park during certain hours as well as space for vendors to load, unload and park.

Off-Site Parking

- 5,300 sq. ft.
- Street parking as well as vacant parking lot located across Traverse Street.



Pop-Up Market

- 10,700 sq. ft.
- Area for a traditional pop-up farmers market to be used seasonally, which includes both grass and hardscape and truck access.

Community Park

- 21,000 sq. ft.
- This open space would be a destination for people using the bike path and could also include a separate area for a community garden.

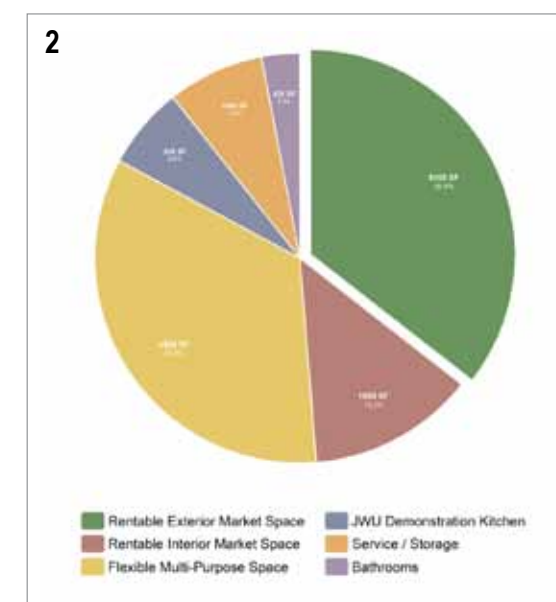

1. Perspective from parking lot.

2. Program.

Event Hardscape

- 4,375 sq. ft.
- The hardscape should allow the multipurpose space to open to the outside. It should also accommodate live music, weekend markets and daily outdoor seating.

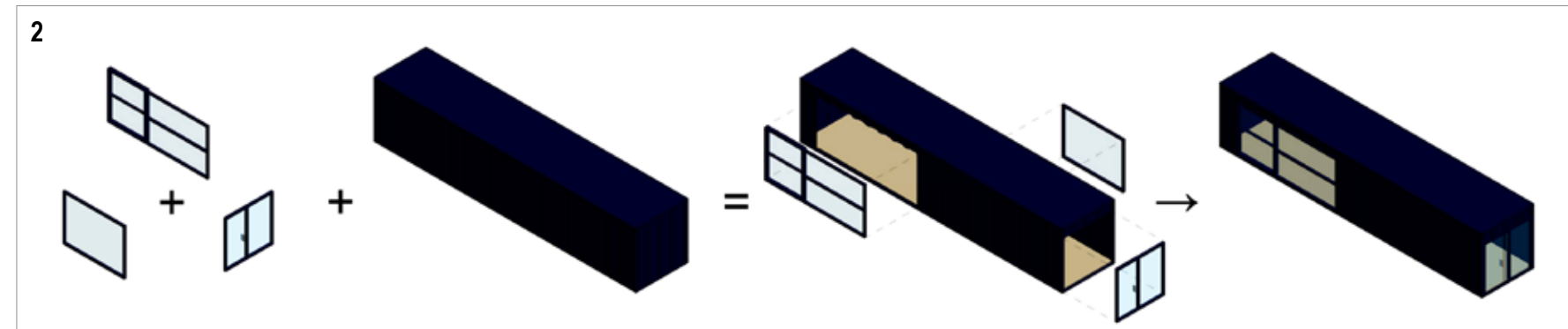

1. Aerial perspective of market.

2. Diagram of a storefront made from a 40' shipping container with adaptable doors and windows.

3. Perspective of demo kitchen.

Design Options

David Sanchez

Located near a residential area in Providence, parcel 9 is a convenient location for a temporary market due for several reasons: close proximity

dictated by the season of the year or potential events. The space within each container will serve as circulation and gathering spaces. Some in-be-



to the market will allow residents to travel to the market fast and conveniently; the site's visibility from I-195 allows the possibility of attracting travelers; and the market will offer a variety of products.

The site will introduce shipping containers as the main shelter for the different stalls. The layout of the stalls will have different configurations

tween spaces will be sheltered using a modular structure. The containers and the stall components will be deployed to contrast the market stalls at night. The market stalls will be stored in the storage section of the container and the containers will become pavilions, transforming and activating the site at night for different events or for the enjoyment of the public.



1. Section perspective.

2. Site plan.



1. Market perspective showing the use of shipping containers.

2. Nighttime rendering of market.

3. Perspective inside the market.



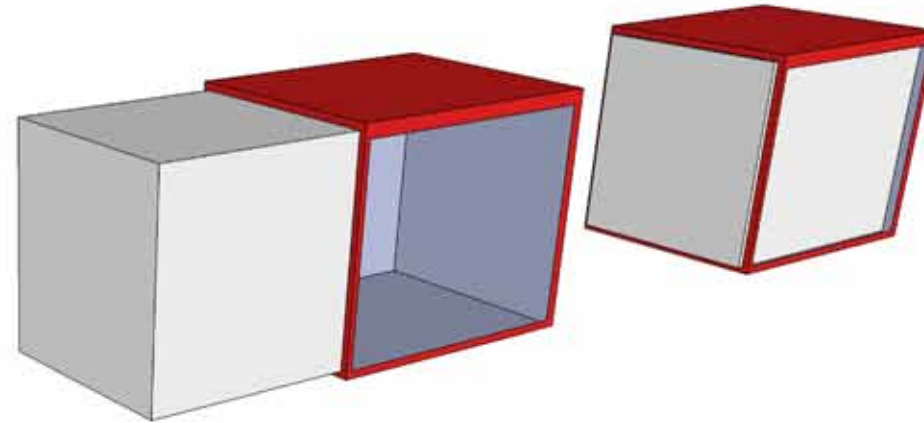
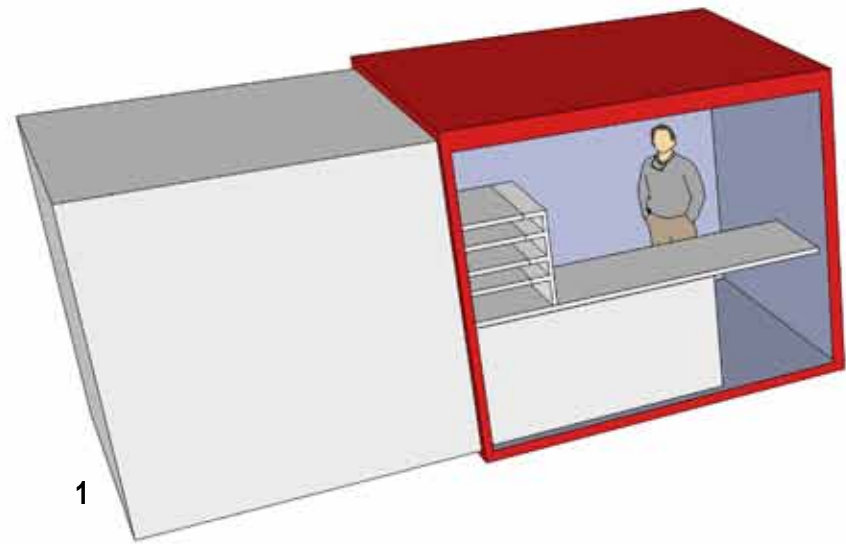

1. Configuration of a single container used for market stalls.

2. Perspective of market stalls.



Design Options

Eric Schall

This project explores an open urban market for the City of Providence on parcel 9 in the Fox Point area. The new market aims to revitalize the city and promote healthy living through fresh food and accessibility through the concept of a corrugated module that creates an iconic statement on the site. The building is an adaptable solution to a changing program and dense urban fabric with a program that includes: a Johnson & Wales demonstration kitchen, flexible event space, flexible outdoor market space, covered market space, a café, bathrooms and storage.



The market stalls are along the main spine of the building, providing an anchor for the rest of the building to fold out. The main event space is a continuation of the system, but proportionally changed for the hierarchy of the space and functions. The markets are connected to the event and café space through an outdoor flexible area, which can be used for pop-up markets, music events, florists fairs, arts and crafts fairs, or even an extension of the J&W demonstration kitchen. The bike path is connected to the proposed pedestrian bridge, and the market has a special bike entry and storage right off the existing path. The project provides iconic architecture for a dense urban area, fresh produce for locals and commuters, and a space for providence to host multiple events.

Program

Required Interior Spaces

Bathrooms:

- 624 sq. ft.
- **Accessibility:** All bathrooms to be ADA-compliant



1. Site plan.

2. Perspective of biker's entry from the bike path into the market.

- **Toilets:** One per 30 female occupants; one per 60 male occupants (50% urinals).
- **Lavatories:** One per 100 occupants for each gender.
- **Drinking Fountain:** One per 100 occupants for each gender.

Administrative Office:

- The office is to have a chair, workstation, private meeting area for four people and storage.

Utility Space:

- 5% of sq. ft.
- Centrally located and easily serviceable.

Example Interior Spaces

Gathering Space:

- 7,031 sq. ft.
- Must connect the main spaces directly and serve as a connection. This area collects all circulation from the various program pieces and disperses easily.

Cafe:

- 1,188 sq. ft.
- The café is for prepared foods and a coffee bar. There should be seating inside and potential outdoor seating. Can be linked to the demonstration kitchen.

- Requires dish wash area, refrigeration area, storage area, space for equipment, dry food storage, walk-in cooler, prep line, plating area, 15' cook line and workspace all related to the working kitchen.

Johnson & Wales Demo Kitchen:

- 2,375 sq. ft.
- There is a display place for the work of JWU that connects to outside. There should be seating inside and potential outdoor seating. Parts can an be linked to the café space.
- Requires dish wash area, refrigeration area, storage area, space for equipment, dry food storage, walk-in cooler, prep line, plating area, 15' cook line and workspace all related to the working kitchen.

Service:

- 2,225 sq. ft.
- Directly related to the kitchen and café with a loading area.
- There must be access to the exterior, with room for trucks to drop off and pick up. Truck drop-off and pick-up must be able to circulate around the market stalls and enclosed program.



Required Exterior Spaces:

Covered Market:

- 3,042 sq. ft.
- Modular system of market stalls in a row. Covered from elements, but still can be open.
- Must have connection to service for trucks to drop off and pick up.

Open Market:

- 1,488 sq. ft.
- Modular space for market vendors to pop up a workstation or tent that is open to all elements.
- A service entry or zone for trucks is needed.

Storage:

- Each vendor stall in the open and covered market will have a small storage area. Each program piece requires an area for storage. Storage areas can be combined with different program pieces.

1. Perspective of market stalls.

2. Perspective of flexible exterior space.

Parking:

- There is a parking lot across the site and parking along the surrounding streets. Parking on-site is for handicapped and emergency only.



Agriculture Roof and Community Garden:

- 6,232 sq. ft.
- Above the major program components, the community garden is intertwined with the green roof for the promotion and growing of local agriculture. There is seating around and through the garden.
- The roof is a level above the heavy foot traffic and dirty air, which helps the agriculture of the roof.

Flexible Event Space:

- Space that is covered and can be open to outside for expansion. Event space needs to be flexible for the program: seating for musical events, tables for art events, lectures, community workshops or a community festival.

Example Exterior Spaces:

Outdoor Hardscape Surface:

- To include seating area and places for trucks to unload.

Park:

- To include seating and paths with landscaping.



1. Perspective of market exterior.

2. Section.

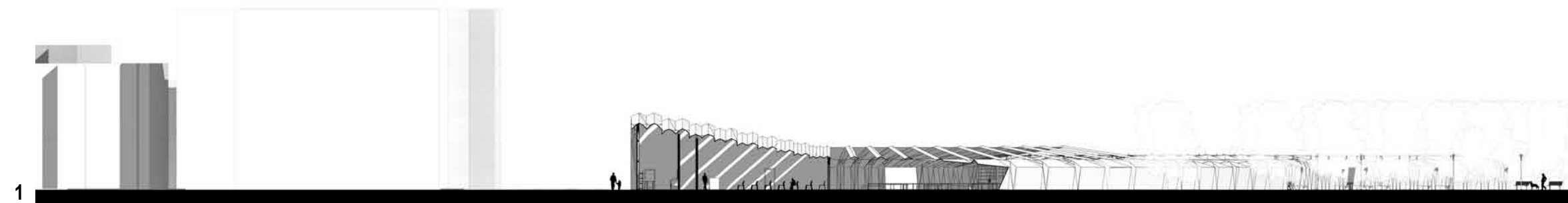

Design Options

Sarah Thompson

The modular pavilion is intended to act as a farmers market and educational facility located at site 3, parcel 4, bringing life back to the former I-95 ramp area of Providence. The food market will act as a starting point to develop Dorrance Street into a market street. This will improve the overall pedestrian quality by bringing more people to the area and setting up the possibility for physical improvement of the street and sidewalks. The modular pavilion will become an anchor to the activation of the street, making connections — through food and educational programs — between local students, vendors and the overall community.

The most important part of this proposed farmers market is that it be a temporary structure. It is to have a life of three to four years in its current location; afterwards, it could be disassembled and moved to another location where it can be reassembled. It can also be disassembled to be repurposed or completely recycled. Each structural system of the market is very light and easily erected, dismantled and transported for hassle-free reuse.



Program - Interior

Vendor Stalls (54)

- 100 sq. ft. each; total of 4,000 sq. ft.
- 54 stalls is the starting number, but there is a possibility of future expansion.
- Stall breakdown: meats (5), vegetables (5), fish (5), fruit (5), baked goods (3), cheese (3), specialty foods (3), beverages (3), herbs (2), dairy/eggs (1), spices (1), alcohol (2), flower shop (2).

Artisan Vendor Stalls (10)

- 120 sq. ft. each; total of 1200 sq. ft.
- To add to the idea of the market street and attract more types of people, a specific area will be designated for non-food vendors. They would sell crafts, fibers (wool and yarn), works of art (paintings, drawings), etc.

1. Western elevation.

2. Site plan.

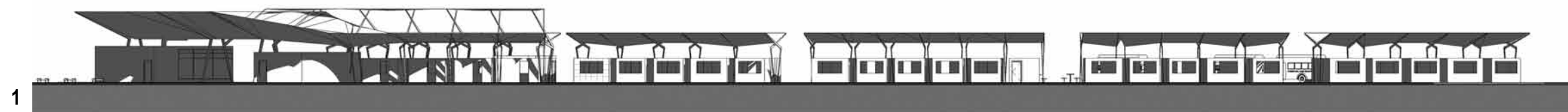

Local Eatery Stands (3)

- 120 sq. ft. each; total of 360 sq. ft.
- This will be for small local restaurants to showcase their food (pizza, cupcakes, etc.).

Buying Local Education Stand

- 120 sq. ft.

Demonstration Kitchen

- 1,000 sq. ft.; total seating up to 90 people (7 sq. ft. per person).
- 600 sq. ft. of seating (90 people) and 400 sq. ft. of demonstration area. This can be changed depending on the class size or the area needed for demonstration. Partitions can be added to make multiple smaller classrooms, and all chairs and furniture are movable.

Prepared Food Station

- 500 sq. ft.
- A small café-like area will serve pre-made food and select drinks.

Small Onsite Catering Function

- Total of 600 sq. ft. (including 120 sq. ft. of storage and 120 sq. ft. for a cooler).
- Small oven with ventilation
- Cook line: 12'

Bathrooms (2)

- **Accessibility:** All bathrooms are ADA-compliant
- **Toilets:** One per 30 females (2) and one per 60 males (2).
- **Lavatories:** One per 100 occupants (one men's and one women's).
- **Drinking fountain:** One per 100 occupants (two total).
- **Service Sink:** One per floor (one total).



Perspective of market exterior.

Program - Exterior

Gathering Area

- 3,000 sq. ft.
- This area can be used as an open, free-flowing space where people can convene or as an entertainment area (exhibitions, music, etc.) that can seat a maximum of 400 people (2400 sq. ft. total seating) with 600 sq. ft. of stage area.

Hardscape

- 1,000 sq. ft.
- This will be located near the prepared foods area to act as seating for people to eat.

Softscape

- 2,000 sq. ft.
- Area for playing, seating, etc. Possibly add a swing set to attract families with children.

Small Garden

- 200 sq. ft. of garden space with 100 sq. ft. of storage
- This can be used for teaching purposes — how to tend and maintain a garden for healthier and less expensive food. It can also be considered a community garden that would be maintained by vendors, local schools, Johnson & Wales, etc.

Service Areas (2)

- 1,800 sq. ft. each; total of 3,600 sq. ft.
- There are two service areas located at both ends of the site for easier access to all stalls.

Parking (20 spaces)

- 5,400 sq. ft.
- Parking will be for facilities only. There are many surrounding parking lots that can be used by customers and vendors.



1-2. Diagram of modular pavilion with customizable market boxes for vendors.

3. Perspective of market stalls.

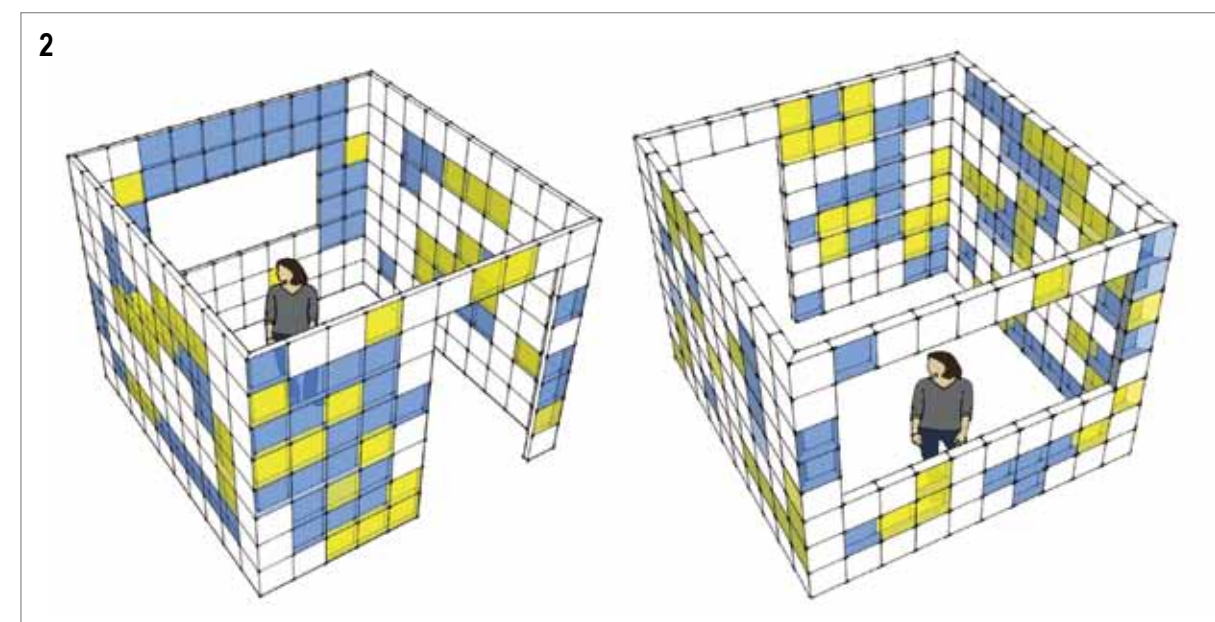
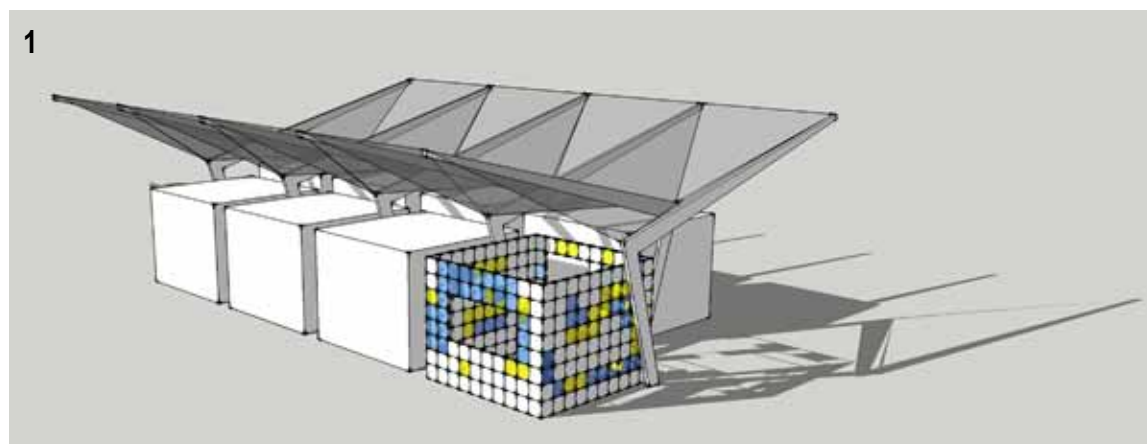



- 1. Section perspective.
- 2. Exterior perspective.
- 3. Aerial perspective of market.

Conclusion

At the conclusion of the semester, students introduced a broad range of proposals for consideration. Proposals incorporated ready-made shipping containers, lightweight tensile systems, reclaimed and repurposed wood products, CNC fabricated building components, urban agricultural systems and various new forms of infrastructure.

The Steering Committee was impressed and highly enthusiastic about the overall results. They felt that the studio demonstrated the potential of how a Providence market could be a transformative contribution to the development of the downtown area. There was no singular project identified, but rather recognition of a robust constellation of ideas, that on the whole created a deep conversation about the potential of architecture to bring together community.



Proposed market perspective by Joanna Grocott.

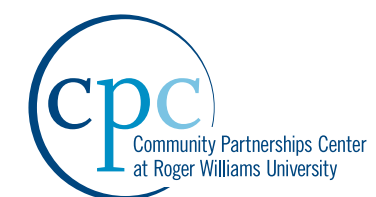

Roger Williams University
One Old Ferry Road
Bristol, Rhode Island 02809

cpc@rwu.edu
<http://cpc.rwu.edu>