

An Integrated Approach to Colorectal Anastomotic Leakage

吴舟桥 著

ISBN: 978-94-6299-024-1

An Integrated Approach to Colorectal Anastomotic Leakage

Thesis, Erasmus University

© Zhouqiao Wu

All rights reserved. No part of this publication may be reproduced, stored in a retrieval system, or transmitted, in any form or by any means, electronic, mechanical, photocopying, recording or otherwise, without prior permission of the author or the copyright-owning journals for previously published chapters.

Cover Design: Ken Lin

Layout Design: Fang Xia (476826900@qq.com)

Printed by: Ridderprint BV

The printing of this thesis has been supported by: Erasmus University Rotterdam; Department of Surgery, Erasmus MC; Department of Neuroscience, Erasmus MC; Olympus Nederland B.V.; Chipsoft; Covidien.

To my family

An Integrated Approach to Colorectal Anastomotic Leakage

Een integrale benadering van colorectale naadlekkage

Proefschrift

ter verkrijging van de graad van doctor aan de
Erasmus Universiteit Rotterdam
op gezag van de
rector magnificus

Prof.dr. H.A.P. Pols

en volgens besluit van het College voor Promoties.
De openbare verdediging zal plaatsvinden op

dinsdag 24 februari 2015 om 15:30 uur

Zhouqiao Wu
geboren te Suzhou (China)



Promotiecommissie

Promotor:

Prof.dr. J.F. Lange

Prof.dr. G.J. Kleinrensink

Overige leden:

Prof.dr. C.H.J. van Eijck

Prof.dr. M.J. Peppelenbosch

Prof.dr. H. Tilanus

Copromotor:

Prof.dr. J. Jeekel

Contents

Chapter 1: General Introduction: an Integrated Approach to Colorectal Anastomotic Leakage	1
PART I: RAT MODELS OF COLORECTAL ANASTOMOTIC LEAKAGE	11
Chapter 2: Colorectal Anastomotic Leakage Caused by Insufficient Suturing After Partial Colectomy: a New Experimental Model	13
Chapter 3: Summary of Rat Models Employed in the Thesis.....	31
PART II: PREVENTION OF COLORECTAL ANASTOMOTIC LEAKAGE WITH TISSUE ADHESIVES	41
Chapter 4: Sealants in Gastrointestinal Anastomosis: a Systematic Review	43
Chapter 5: Critical Analysis of Cyanoacrylate in Intestinal and Colorectal Anastomosis	69
Chapter 6: Mechanical Strength and Rheological Properties of Tissue Adhesives with Regard to Colorectal Anastomosis: an Ex Vivo Study	87
Chapter 7: Reducing Anastomotic Leakage by Reinforcement of Colorectal Anastomosis with Cyanoacrylate Glue	111
Chapter 8: The Prevention of Colorectal Anastomotic Leakage with Tissue Adhesives in a Contaminated Environment is Associated with the Presence of Anti-Inflammatory Macrophages.....	123
Chapter 9: Reducing Colorectal Anastomotic Leakage with Tissue Adhesive in Experimental Inflammatory Bowel Disease	145
PART III: EARLY DETECTION OF COLORECTAL ANASTOMOTIC LEAKAGE	171
Chapter 10: Prediction and Diagnosis of Colorectal Anastomotic Leakage: a Systematic Review of Literature	173
Chapter 11: Postoperative Blood Flow Measurement with Miniaturized Dynamic Light Scattering Predicts Gastrointestinal Anastomotic Healing	197
Chapter 12: General Discussion: New Perspectives to Investigate Colorectal Anastomotic Leakage.....	215
Chapter 13: Summary in English, Dutch and Chinese, Acknowledgements, List of Publications, Curriculum Vitae, PhD portfolio	227

Chapter 1:

General Introduction: an Integrated Approach to Colorectal Anastomotic Leakage

Colorectal anastomotic leakage (CAL) still remains a frequent and most dangerous complication after gastrointestinal surgery, occurring in 4-33% patients and contributing to one third of postoperative mortality [1]. CAL substantially prolongs hospital stay ? by one to two weeks - and greatly increases medical costs by as much as \$24,000 within the first period of hospitalization, thereby approximately tripling the expenditure relative to that of patients without CAL [2, 3].

Due to the high risk of postoperative mortality, substantial efforts have been made to investigate means of preventing and detecting CAL. In recent decades, however, even with substantial improvements in surgical technique, no clear decrease in CAL rate has been achieved [4, 5]. Much effort has been devoted to selecting patients with higher risks of CAL, and many risk factors have been identified, such as being male [6], smoking [7], alcohol abuse [7], obesity [8], a high American Society of Anesthesiologists (ASA) score [9], low level (e.g. rectal) anastomosis [10], tumor stage [6], urgent operation [9], increased blood loss [11], and prolonged duration of surgery [12] have been revealed. Previous studies by our research group also reported several novel risk factors including after-hours surgery [13], and long-term and preoperative administration of corticosteroids [14]. However, these risk factors seem to cover most patients and thus may have limited value in the preoperative selection of patients.

To conquer CAL, it seems that simply selecting patients with high risks may be of limited help, and that there is a more urgent need for effective strategies for preventing CAL and for its early detection. But before such strategies can be developed successfully, we must gain integrated insight into the etiology of CAL. To this end, this three-part thesis is committed to provide an integrated approach to CAL, and to extend current knowledge on its etiology, prevention, and detection.

PART I: Rat models of colorectal anastomotic leakage

There is an old Chinese saying that a handy tool makes a handy man (工欲善其事必先利其器). A major obstacle to CAL research is the continued lack of an essential tool: a standardized and handy experimental model of CAL. Although most studies on CAL over recent decades have used rodents, few of these animal models were validated before application [15]. Inevitably, the wide differences between these models have compromised the applicability of their results, partly explaining the lack of effective strategies for coping with CAL.

In earlier work, our research group validated the first mouse CAL model by deliberately using an insufficient number of sutures after colon transection, a process that resulted in a 40-50% CAL rate after seven days [16]. This model made it possible for future mouse studies to be conducted on the same basis. However, we soon noted that most rodent CAL studies have been performed in rat models as a mouse is usually too small to allow any further interventions beyond systematic pharmacological interventions [17]. In our battle against CAL, the undisputed top priority was therefore to validate a novel rat CAL model.

As most of the rat colon still healed sufficiently even when an insufficient number of sutures was applied, many early attempts were unsatisfactory [18, 19]. However, a disadvantage of performing insufficient anastomoses without colon resection but only with a transection is that it does not reveal the clinical condition where a colectomy rather than a transection is usually applied to resect the diseased segment [15]. To address this issue, we designed to validate a novel rat colorectal anastomotic leakage model (Chapter 2). While,

as in the mouse model, this rat CAL model was developed by performing insufficient anastomosis, we also performed a partial colectomy in this model in order to further mimic human colorectal surgery.

The CAL model was expected to increase the incidence of intra-luminal content leaking to the abdominal cavity and thus might result in a higher CAL rate. Several chapters in this thesis (i.e. Chapter 2 and Chapter 11) describe our use of this model to investigate CAL rates and mechanical strength, and also anastomotic infection and ischemia. Based on the CAL model, we further summarize several experimental CAL models in Chapter 3 by combining the rat colectomy model with various CAL risk factors including peritonitis, ischemia, and colitis [20, 21].

PART II: Prevention of CAL with tissue adhesives

The validation of animal CAL models allows further tests of innovations regarding the prevention of CAL, in which the application of tissue adhesive is an important aspect. Part II focuses on the prevention of CAL with these tissue adhesives.

Basically, a tissue adhesive-or in many cases so-called “glue” - forms bonds with its substrate ensuring that sufficient adhesion is generated by chemical bonds, or by physical bonds such as hydrogen bonds or van der Waals forces [22]. It is not difficult to understand the concept of applying tissue adhesives as anastomotic sealants, as the advantages are evident: tissue adhesives distribute forces throughout the anastomosis evenly and non-invasively, and the technique for applying tissue adhesive is simple and standardizable [23]. By using tissue adhesives as anastomotic sealants, surgeons may expect CAL to be reduced and its clinical symptoms to be ameliorated. Numerous attempts have been undertaken in this field. These are summarized in Chapter 4, which provides an up-to-date overview of the progress on this topic.

Most tissue adhesives are either glues, which connect various wound edges with the strong adhesives; or sealants, which cover a wound and protect it from the surrounding

environment. Nevertheless, one type of tissue adhesive, cyanoacrylates - being invented for industrial applications more than 60 years ago - has the features of both [24, 25]. Because of their great adhesiveness, some of their commercial derivatives are known as “crazy glue” or “instant glue”. They also provide a watertight sealing effect when applied topically for skin wounds [26, 27]. Although such properties make cyanoacrylates an ideal candidate for anastomotic sealants, the results of many early attempts were not conclusive [28-31]. We noted that the methodology of these studies varied widely, which may partly explain the inconsistency. To verify whether cyanoacrylates are promising tissue adhesives for preventing CAL, and whether the methodology influenced the outcomes of those studies, Chapter 5 summarizes the experimental studies on the application of cyanoacrylates in intestinal and colorectal anastomosis.

Our further investigations were facilitated by the results of the two reviews. One important finding was that the adhesiveness of glues is misunderstood in much of the previous literature, which evaluated mechanical strength of the adhesive-tissue bond immediately after sacrifice of the animal. Such methods do not provide information on mechanical strength directly after application, which takes place prior to adhesive bond degradation and healing effects. The direct adhesiveness of a tissue adhesive is extremely important for the sealing of a bowel anastomosis, since its strength is lowest directly after creation.

As the misuse of a mechanically weak sealant to repair or reinforce an insufficient anastomosis may provide minimal additional value. Chapter 6 reports a systematic analysis of ex-vivo tests with regard to 12 commercially available tissue adhesives directly after application. Based on the results in Chapter 6, we select several tissue adhesives for the subsequent studies (i.e. Chapter 7, 8, and 9).

Both the previous literature and data from Chapter 6 demonstrate that the cyanoacrylates have the greatest adhesiveness of all tissue-adhesive categories. They have been shown to provide polymerization quickly within one minute of application [32] and that it is strong enough to support a sutureless anastomosis [33]. Clinical data in pancreaticoduodenectomy also suggest that it is a promising sealant after primary anastomosis [34]. As these results suggest that cyanoacrylate is a promising alternative to supportive sutures in low colorectal anastomosis. Therefore Chapter 7 discusses our use of Dermabond, the cyanoacrylate with the highest adhesiveness, to replace the sutures and reinforce anastomosis mechanically according to the technique described by Gadiot et al.,

which was reported to reduce the CAL rate effectively [35].

The biological properties of the tissue adhesives have been investigated as well. Our systematic evaluation of tissue adhesives provided substantial data (unpublished data) that enabled us to identify three tissue adhesives (i.e. TissuCol®, fibrin glue; Histoacryl® Flex, cyanoacrylate; Duraseal®, Polyethylene glycol) that provoke the least foreign body reaction when applied to rat colon. We therefore choose them for the subsequent tests. Many studies have been performed with one or some of these glues under different circumstances and with promising results [17, 33, 36-38]. In Chapter 8 and 9, we tested all these glues under the same conditions, which allowed us to compare their biological properties. To evaluate the glues, we chose two risk factors of CAL, i.e. peritonitis and inflammatory bowel disease (IBD).

The first model we chose (Chapter 8) was the rat caecal ligation puncture (CLP) model, which mimics the peritonitis caused by fecal contamination [39, 40]. Performing primary anastomosis in such circumstances is extremely challenging and still causes substantial leakage: the 19.3% found in patients with perforated diverticulitis [41-44] is much higher than the leakage rate of approximately 9% after a low anterior resection for rectal cancer [1].

As in contaminated surgery, IBD patients also suffer a substantial risk of short and long-term surgical complications after operation with an overall complication rate approximating 30% to 40%. If the patient receives high doses steroids, the rates of infectious complications may further increase (e.g. 68%) [45, 46]. A major cause of the infectious complications (e.g. pelvic sepsis) is leakage at the sutured or stapled anastomotic site [45, 47]. Unlike an existing CLP model, there is no experimental model focused on the surgical treatment of IBD. In Chapter 9 we therefore wished to validate a novel surgical IBD model and test the three tissue adhesives in this model.

PART III: Early detection of colorectal anastomotic leakage

Although prevention of CAL is the ideal, most work on it is still at an experimental stage. In contrast, detection of CAL is an urgent clinical question remaining unsolved. To

date, CAL has usually been detected between day 5 and day 8, or even later after surgery [48], with more than 50% of the cases requiring reoperation [49, 50]. With the current strategy, many leakage cases are not detected until too late.

In most cases, conventional radiological examinations are still required to confirm the occurrence of CAL. However decision-making on radiological examinations still depends on the surgeon's awareness, which is based on clinical manifestations and laboratory tests, which are often abnormal after surgery both in CAL patients and in substantial uncomplicated recoveries [51]. This makes diagnosis of CAL is eventually challenging: delayed diagnosis remains common and has been ascribed to various causes [52]. In Chapter 10, as a basis for developing innovative techniques to prevent CAL, we summarize currently available evidence regarding its detection; our aim is to provide a systematic review of the predictive value of the diagnostic techniques for detecting CAL that are described in the current literature.

Investigation of its etiology demonstrates that anastomotic ischemia is one main cause of CAL [53-55]. One ideal condition for detecting CAL is therefore to provide real-time monitoring of the wound-healing process with a laser Doppler imaging device, flowmetry or other techniques, which may provide direct data on wound perfusion and indicate ischemia [53-57]. While tissue perfusion can be conveniently monitored in skin wounds, evaluation of anastomotic perfusion is not a simple task: so far, due to the large sizes of most devices, it is still confined to intraoperative measurement [58-60]. In Chapter 11, we report our first attempt to correlate postoperative anastomotic perfusion to anastomotic healing with a miniaturized perfusion device. If such correlation exists, the miniaturized size of the perfusion device may one day allow postoperative monitoring of the anastomotic healing in human patients.

As stated above, this thesis is intended to provide an integrated approach to CAL, and to extend current knowledge regarding its etiology, prevention, and detection. Though unable to conquer CAL, the data we describe and report in this thesis may provide some new perspectives on CAL, and thereby facilitate future studies. Our data appear to encourage a reconsideration of CAL mechanism. We propose that CAL mechanism consists three factors: communication, infection, and healing disturbances. Chapter 12 extensively discusses an integrated approach with regard to the prevention and detection of CAL with the three factors. Last but not least, the work of this thesis is summarized in Chapter 13.

REFERENCES

1. Snijders, H.S., et al., Meta-analysis of the risk for anastomotic leakage, the postoperative mortality caused by leakage in relation to the overall postoperative mortality. *Eur J Surg Oncol*, 2012. 38(11): p. 1013-9.
2. Hammond, J., et al., The Burden of Gastrointestinal Anastomotic Leaks: an Evaluation of Clinical and Economic Outcomes. *J Gastrointest Surg*, 2014.
3. Hashemi L, et al., Economic impact of anastomotic leaks in colectomy procedures in the USA: 2005-2009, in *SAGES 2012*. 2012: San Diego, CA, USA.
4. Shearer, R., et al., Have early postoperative complications from laparoscopic rectal cancer surgery improved over the past 20 years? *Colorectal Dis*, 2013. 15(10): p. 1211-26.
5. Shogan, B.D., et al., Do we really know why colorectal anastomoses leak? *Journal of Gastrointestinal Surgery*, 2013. 17(9): p. 1698-1707.
6. Eriksen, M.T., et al., Anastomotic leakage following routine mesorectal excision for rectal cancer in a national cohort of patients. *Colorectal Dis*, 2005. 7(1): p. 51-7.
7. S?rensen, L.T., et al., Smoking and alcohol abuse are major risk factors for anastomotic leakage in colorectal surgery. *British journal of surgery*, 1999. 86(7): p. 927-931.
8. Nickelsen, T.N., T. J?rgensen, and O. Kronborg, Lifestyle and 30-day complications to surgery for colorectal cancer. *Acta Oncologica*, 2005. 44(3): p. 218-223.
9. Choi, H.-K., W.-L. Law, and J.W.C. Ho, Leakage after resection and intraperitoneal anastomosis for colorectal malignancy: analysis of risk factors. *Diseases of the colon & rectum*, 2006. 49(11): p. 1719-1725.
10. Vignali, A., et al., Factors associated with the occurrence of leaks in stapled rectal anastomoses: a review of 1,014 patients. *Journal of the American College of Surgeons*, 1997. 185(2): p. 105-113.
11. Daams, F., et al., Local ischaemia does not influence anastomotic healing: an experimental study. *Eur Surg Res*, 2013. 50(1): p. 24-31.
12. Ho, Y.H. and M.A. Ashour, Techniques for colorectal anastomosis. *World J Gastroenterol*, 2010. 16(13): p. 1610-21.
13. Komen, N., et al., After-hours colorectal surgery: a risk factor for anastomotic leakage. *Int J Colorectal Dis*, 2009. 24(7): p. 789-95.
14. Slieker, J.C., et al., Long-term and perioperative corticosteroids in anastomotic leakage: a prospective study of 259 left-sided colorectal anastomoses. *Arch Surg*, 2012. 147(5): p. 447-52.
15. Pommergaard, H.C., et al., Choosing the best animal species to mimic clinical colon anastomotic leakage in humans: a qualitative systematic review. *Eur Surg Res*, 2011. 47(3): p. 173-81.
16. Komen, N., et al., Colorectal anastomotic leakage: a new experimental model. *J Surg Res*, 2009. 155(1): p. 7-12.
17. Slieker, J.C., et al., Prevention of leakage by sealing colon anastomosis: experimental study in a mouse model. *J Surg Res*, 2013. 184(2): p. 819-24.
18. van der Ham, A.C., et al., Transient protection of incomplete colonic anastomoses with fibrin sealant: an experimental study in the rat. *J Surg Res*, 1993. 55(3): p. 256-60.
19. van der Ham, A.C., et al., Healing of ischemic colonic anastomosis: fibrin sealant does not improve wound healing. *Dis Colon Rectum*, 1992. 35(9): p.884-91.
20. Menozzi, A., et al., Long-term study of TNBS-induced colitis in rats: focus on mast cells. *Inflamm Res*, 2006. 55(10): p. 416-22.
21. Wu, Z., et al. A rat model of anastomotic leakage created by insufficient sutures after partial colectomy. in

British journal of surgery. 2013: WILEY-BLACKWELL
111 RIVER ST, HOBOKEN 07030-5774, NJ USA.

22. Peppas, N.A., Surface, interfacial and molecular aspects of polymers bioadhesion on soft tissues. *Journal of Controlled Release*, 1985. 2: p. 257-275.

23. Vakalopoulos, K.A., et al., Tissue adhesives in gastrointestinal anastomosis: a systematic review. *J Surg Res*, 2013. 180(2): p. 290-300.

24. Coover HN, Joyner FB, and Sheerer NH, Chemistry and performance of a cyanoacrylate adhesive. *Spec Tech Pap*, 1959(5): p. 413-7.

25. Gennaro, A.R. and C.A.X. Moreira, Nonsuture colonic anastomosis. *DIS COLON RECTUM*, 1976. 19(3): p. 245-249.

26. Spotnitz, W.D. and S. Burks, Hemostats, sealants, and adhesives III: a new update as well as cost and regulatory considerations for components of the surgical toolbox. *Transfusion*, 2012.

27. Quinn, J.V., *Tissue adhesives in clinical medicine*. 2nd ed. 2005, Hamilton: BC Decker, Inc. vi, 183 p.

28. Paral, J., et al., Suture-Free Anastomosis of the Colon Experimental Comparison of Two Cyanoacrylate Adhesives. *J Gastrointest Surg*, 2011. 15(3): p. 451-459.

29. Tebala, G.D., et al., The use of cyanoacrylate tissue adhesive in high-risk intestinal anastomoses. *SURG TODAY*, 1995. 25(12): p. 1069-1072.

30. Weilbaecher, D.A., F.J. Mathieu, and I. Cohn, Jr., Nonsuture Intestinal Anastomosis. *AM J SURG*, 1964. 107: p. 353-60.

31. O'Neill, P., et al., Nonsuture intestinal anastomosis. *American Journal of Surgery*, 1962. 104: p. 761.

32. Spotnitz, W.D. and S. Burks, Hemostats, sealants, and adhesives III: a new update as well as cost and regulatory considerations for components of the surgical toolbox. *Transfusion*, 2012. 52(10): p. 2243-55.

33. Paral, J., et al., Suture-free anastomosis of the colon. Experimental comparison of two cyanoacrylate adhesives. *J Gastrointest Surg*, 2011. 15(3): p. 451-9.

34. Barakat, O., C.F. Ozaki, and R.P. Wood,

Topically Applied 2-Octyl Cyanoacrylate (Dermabond) for Prevention of Postoperative Pancreatic Fistula After Pancreaticoduodenectomy. *J Gastrointest Surg*, 2012.

35. Gadiot, R.P., et al., Reduction of anastomotic failure in laparoscopic colorectal surgery using antitraction sutures. *Surg Endosc*, 2011. 25(1): p. 68-71.

36. Silecchia, G., et al., The use of fibrin sealant to prevent major complications following laparoscopic gastric bypass: results of a multicenter, randomized trial. *Surg Endosc*, 2008. 22(11): p. 2492-7.

37. Vakalopoulos, K.A., et al., Tissue adhesives in gastrointestinal anastomosis: a systematic review. *J Surg Res*, 2013.

38. Wu, Z., et al., Critical analysis of cyanoacrylate in intestinal and colorectal anastomosis. *J Biomed Mater Res B Appl Biomater*, 2013.

39. Deerenberg, E.B., et al., Polyvinyl alcohol hydrogel decreases formation of adhesions in a rat model of peritonitis. *Surg Infect (Larchmt)*, 2012. 13(5): p. 321-5.

40. Deerenberg, E.B., et al., Experimental study on synthetic and biological mesh implantation in a contaminated environment. *Br J Surg*, 2012. 99(12): p. 1734-41.

41. Golub, R., et al., A multivariate analysis of factors contributing to leakage of intestinal anastomoses. *J Am Coll Surg*, 1997. 184(4): p. 364-72.

42. Tang, R., et al., Risk factors for surgical site infection after elective resection of the colon and rectum: a single-center prospective study of 2,809 consecutive patients. *Ann Surg*, 2001. 234(2): p. 181-9.

43. Leichtle, S.W., et al., Risk factors for anastomotic leakage after colectomy. *Dis Colon Rectum*, 2012. 55(5): p. 569-75.

44. Salem, L. and D.R. Flum, Primary anastomosis or Hartmann's procedure for patients with diverticular peritonitis? A systematic review. *Dis Colon Rectum*, 2004. 47(11): p. 1953-64.

45. Beddy, D., E.J. Dozois, and J.H. Pemberton, Perioperative complications in inflammatory bowel disease.

Inflamm Bowel Dis, 2011. 17(7): p. 1610-9.

46. Bach, S.P. and N.J. Mortensen, Revolution and evolution: 30 years of ileoanal pouch surgery. *Inflamm Bowel Dis*, 2006. 12(2): p. 131-45.
47. Gorgun, E. and F.H. Remzi, Complications of ileoanal pouches. *Clin Colon Rectal Surg*, 2004. 17(1): p. 43-55.
48. Hyman, N., et al., Anastomotic leaks after intestinal anastomosis: it's later than you think. *Ann Surg*, 2007. 245(2): p. 254-8.
49. Rahbari, N.N., et al., Definition and grading of anastomotic leakage following anterior resection of the rectum: a proposal by the International Study Group of Rectal Cancer. *Surgery*, 2010. 147(3): p. 339-51.
50. Cong, Z.J., et al., Systematic review of anastomotic leakage rate according to an international grading system following anterior resection for rectal cancer. *PLoS One*, 2013. 8(9): p. e75519.
51. Erb, L., N.H. Hyman, and T. Osler, Abnormal vital signs are common after bowel resection and do not predict anastomotic leak. *J Am Coll Surg*, 2014. 218(6): p. 1195-9.
52. Doeksen, A., et al., Factors determining delay in relaparotomy for anastomotic leakage after colorectal resection. *World J Gastroenterol*, 2007. 13(27): p. 3721-3725.
53. Law, W.I., et al., Risk factors for anastomotic leakage after low anterior resection with total mesorectal excision. *Am J Surg*, 2000. 179(2): p. 92-6.
54. Guo, S. and L.A. Dipietro, Factors affecting wound healing. *J Dent Res*, 2010. 89(3): p. 219-29.
55. Vignali, A., et al., Altered microperfusion at the rectal stump is predictive for rectal anastomotic leak. *Dis Colon Rectum*, 2000. 43(1): p. 76-82.
56. Wang, H., et al., Multimodal optical imaging can reveal changes in microcirculation and tissue oxygenation during skin wound healing. *Lasers in surgery and medicine*, 2014.
57. Núñez, S.C., et al., He[?]Ne laser effects on blood microcirculation during wound healing: A method of in vivo study through laser Doppler flowmetry. *Lasers in surgery and medicine*, 2004. 35(5): p. 363-368.
58. Boyle, N.H., et al., Intraoperative scanning laser Doppler flowmetry in the assessment of gastric tube perfusion during esophageal resection. *J Am Coll Surg*, 1999. 188(5): p. 498-502.
59. Karliczek, A., et al., Intraoperative assessment of microperfusion with visible light spectroscopy in esophageal and colorectal anastomoses. *Eur Surg Res*, 2008. 41(3): p. 303-11.
60. Daams, F., et al., Prediction and diagnosis of colorectal anastomotic leakage: A systematic review of literature. *World J Gastrointest Surg*, 2014. 6(2): p. 14-26.

PART I

**RAT MODELS OF COLORECTAL
ANASTOMOTIC LEAKAGE**

Chapter 2:

Colorectal Anastomotic Leakage Caused by Insufficient Suturing After Partial Colectomy: a New Experimental Model

Z. Wu, F. Daams, G.S.A. Boersema, K.A. Vakalopoulos, K.H. Lam, P.H. van der Horst, G-J. Kleinrensink, J. Jeekel, J. F. Lange

Surgical Infection, 2014 (published)

ABSTRACT

Background: Colorectal anastomotic leakage (CAL) is the most important complication after colorectal surgery, accounting for one third of postoperative death. To prevent it, abundant interventions have been tested on animal models, mostly on rats. However, few of them have been validated. We therefore aimed to develop a new, reproducible rat CAL model by creating the anastomosis with insufficient suturing after partial colectomy.

Methods: To establish which number of sutures would create an acceptable leakage rate (20% to 50%), partial colectomy in Wistar rats was performed, using 12-suture anastomosis in the control group and anastomosis with insufficient suturing in the case group, starting at five sutures. Seven days later, the rats were examined for the occurrence and severity of CAL, adhesion, and anastomotic bursting pressure. When the acceptable leakage rate was achieved, case and control series were both repeated twice.

Results: Sixty rats were included for data analysis. On day 7, 5-suture and 12-suture anastomosis induced respective leakage rates of 50% vs. 30%, 44.4% vs. 20%, and 50% vs. 20% in each series. Overall, the 5-suture group (48.3%) had a significantly higher CAL rate than the 12-suture group (23.3%, $p = 0.045$). It also had higher CAL severity and more adhesions (p for both < 0.05). Its bursting pressure (116.8 ± 58.9 mmHg) was significantly lower than the 12-suture group's (150.4 ± 50.3 mmHg; $p = 0.041$).

Conclusion: Anastomosis with five sutures after partial colectomy provides a new, feasible rat CAL model. Its future applications may help to improve the consistency of CAL studies.

INTRODUCTION

Colorectal anastomotic leakage (CAL), which occurs in between 8% and 20% of low colorectal anastomoses [1], is the most serious complication after colorectal surgery, causing one third of all postoperative mortality [2]. It represents a defect of the bowel wall at the anastomotic site, which leads to a communication between the intra- and extra-luminal compartments [3]. Due to the defect, non-sterile bowel content leaks into the abdominal or pelvic cavity, resulting in infection or even peritonitis. If not controlled in time, CAL may lead to sepsis, multiple-organ failure, and death [4].

In order to develop effective preventive and treatment strategies for CAL, a substantial number of interventions have been tested in different animal models[5], mostly rat models [6, 7]. However, colorectal anastomoses in previous rat studies were usually made after simple transection or short resection [8], this technique may not be comparable to the clinical situation as the portion of resected colonic segments is much higher in human colectomy. Similarly, although outcomes such as anastomotic bursting pressure (ABP), collagen content or hydroxyproline concentrations have also been used widely as primary outcome for CAL studies, the relevance of these endpoints to the clinical leakage is still in doubt [9, 10]. Outcomes directly targeting the occurrence or severity of CAL are still lacking.

In addition to these issues, another major concern in CAL research is the reproducibility of these rat models. For a standard CAL model, the reproducible leakage rate in different experiments is paramount. So far, however, no rat model with technical failure, the

important etiological factor of CAL, has been validated for its reproducibility.

To evaluate the feasibility of a rat CAL model based on technical failure, and to demonstrate its reproducibility, we therefore performed anastomoses after partial colectomy in a rat model that has a portion of resected colon comparable to human colectomy. We also implemented technical failure caused by insufficient suturing to increase the leakage rate, and used a scoring system to classify the CAL severity.

METHODS

Animals

Male Wistar rats, weight 250-350 grams, were purchased from a licensed breeder (Halan Laboratories, Boxmeer, the Netherlands). All rats were bred under specific pathogen-free conditions, and kept under standard laboratory conditions in individually ventilated cages. Standard rat chow and water were supplied ad libitum throughout the experiment. All experiments were performed according to a research protocol approved by the Ethical Committee on Animal Experimentation of Erasmus University Rotterdam.

Study design

According to the research goal, the experiments were divided into three series illustrated in figure 1. After test groups had been first performed to determine the proper leakage rate, two repeat-series would take place to demonstrate the model's reproducibility. In the test groups, standard anastomosis was constructed with 12 sutures in the control group, while insufficient anastomoses with 5 sutures were created in the first test-series. If an acceptable CAL rate of between 20% and 50% was achieved in the first test group on day 7, the repeat-series would start; if not, the number of sutures in the second test group would be reduced or increased, and the CAL rate would be determined again 7 days later. The repeat-series would only start if the acceptable CAL rate had been reached in the test groups. Otherwise, the experiment would have been terminated due to a poor feasibility. In the event, the control group and the case group (with proper number of sutures) were repeated twice in the subsequent two repeat-series, and data from all three series was analyzed. In

each group, 10 rats were used; animal numbers were corrected for non-CAL related death.

In this study, the primary outcome was anastomotic leakage occurrence (CAL rate); secondary outcomes were CAL score, Anastomotic Bursting Pressure (ABP), and adhesion formation.

Surgical technique

On day 0, the rat was anesthetized using 2% isoflurane / O₂ mask. After shaving, and disinfection (70% alcohol) of the abdomen, a laparotomy was performed through a 5 cm midline incision. After identification of the cecum, colon and mesenteric arteries including the colic branch of the ileocecolic artery, the right colic artery, the middle colic artery, and the left colic artery were ligated (Silkam 4/0, B. Braun, Germany) or coagulated (bipolar, Erbotom ICC 50, ERBE, Germany). The colonic segment between 1.0 cm aborally to the cecum and 0.5 cm above the caudal mesenteric artery was resected afterwards (supplementary materials, figure 2). To prevent fecal contamination, intraluminal feces at the two colon margins were removed. In order to guide the anastomosis construction, two long cotton swabs were introduced trans-anally through the distal colon, and then into the proximal colon end. Then a full thickness end-to-end anastomosis was created with one-layer inverting suturing (12 continuous sutures, or 5 interrupted sutures) with Dafilon 8/0 (B. Braun, Germany) with the microscope. The first suture was positioned at the mesenteric site, and then the other sutures were applied in an anti-clockwise sequence and spaced equally around the whole circumference. The inverting technique was used in all anastomoses to ensure the direct connection of the serosal layer of the two edges. After that, the remnant colon and cecum were repositioned to avoid distortion; the colon swabs were gently removed from the rat colon. Finally, the abdominal wall was closed in two layers with Safil 5/0 (B. Braun, Germany). Five mL saline was injected subcutaneously to prevent dehydration. Right after the operation animals were kept under heating lamps to prevent hypothermia. When fully awake they were returned to their stables.

Follow up and sacrificing

During follow up, the weight of all rats was noted. On day 7, the rats were anesthetized again, and re-laparotomy with a U-shaped incision was performed. The abdomen was first checked for signs of CAL (defined as either fecal peritonitis or abscess formation around the anastomosis). In order to assess the severity of CAL, a CAL grading system was developed.

CAL severity was graded as followed: 0 = no CAL, 1 = only abscess formation around the anastomosis, 2 = the presence of fecal peritonitis with or without abscess formation, and 4 = CAL-related death during follow up. Adhesion formation was also recorded using the Zühlke score [11] (table 1). Then anastomotic bursting pressure (ABP) was determined. The pressure of the first air leakage, shown as the first significant decrease in pressure value and maintain low pressure afterwards on pressure indicator, was considered to be the anastomotic bursting pressure and recorded. The bursting location was recorded as “at anastomosis” or “elsewhere”. In each rat, colonic samples were harvested for histological examinations. Finally, the rats were euthanized by heart puncture under anesthesia. Two observers performed all observations and evaluations for each rat during sacrificing.

To rule out any possible deleterious consequence of the ABP test on the colonic structure and thus negatively influence the histological evaluation, the ABP test was only performed in the test groups and the first repeat groups. In the second repeat groups, colon samples were directly harvested for histology.

Histology

The harvested anastomotic samples, which were 1.0 cm in length (0.5 cm from anastomosis to each end), were washed with phosphate-buffered saline, and then cut open longitudinally. Sections with anastomosis in the middle were submitted to standard processing for hematoxylin and eosin (HE) staining. Afterwards, sections were evaluated and scored using the Ehrlich and Hunt numerical scale as modified by Phillips et al. [12]. The scoring system evaluated 4 aspects: inflammatory cell infiltration, fibroblast activity, development of new blood vessels, and collagen deposition. All aspects were graded from 0 to 4 as follows: 0 = no evidence, 1 = occasional evidence, 2 = light scattering, 3 = abundant evidence, 4 = confluent cells or fibers. The samples were scored by two independent investigators (ZW and KL), who were blinded for the clinical findings.

Statistical analysis

Statistical analysis was performed with SPSS 20.0 (IBM Inc., Chicago, USA). Data are presented as mean \pm standard deviation (S.D.) or as median or as percentage. The Mann–Whitney test and Chi square test were used according to proper indications. All reported p values were two-sided; a p-value < 0.05 was considered to indicate statistical significance.

RESULTS

Overall Observation

The solid-line curves in figure 1 present the actual experimental procedures. Sixty-six rats were used in total, in which six non-CAL related deaths occurred: 1 internal bleeding, 1 ileus, 1 abdomen wound rupture, 1 overdosed anesthesia, 2 unknown reasons. 1 rat from the 5-suture group in the first repeat-series died on day 2 due to severe fecal peritonitis.

After colectomy, all rats had diarrhea, which usually lasted for 3 to 4 days postoperatively. All rats also lost weight, which was most significant on day 3 or 4, after which they started to gain weight again. The weight-loss trends in the 5- and 12-suture groups were similar. Rats with CAL had a more severe weight loss on day 3 than non-CAL rats.

Intra-abdominal observation

Anastomotic leakage was observed in all groups (supplementary materials figure 3). In the 5-suture group, leakage rate was 48.3% (14 out of 29), which on day 7 was significantly higher than the 23.3% (7 out of 30) in the 12-suture group ($p = 0.045$, Chi square test). In each series, the 5-suture anastomosis induced leakage rates of 50%, 44.4%, and 50% respectively, while the 12-suture anastomosis induced 30%, 20%, and 20% leakage rates (table 2). More severe CAL was found in 5-suture group, which had an average CAL score of 0.67. This was significantly higher than the average of 0.27 in the 12-suture group ($p = 0.027$, Mann-Whitney test, table 3).

The mean ABPs in each series were listed in table 3. In total, the ABP in the 5-suture group was significantly lower than that in the 12-suture group (116.8 ± 58.9 mmHg vs. 150.4 ± 50.3 mmHg, $p = 0.041$, Mann Whitney test). In the 5-suture group, 63.2% (12 / 19) of anastomoses burst at the site of the anastomosis during the ABP test, which was significantly higher than 5.3% (4 / 19) in the 12-suture group ($p = 0.020$, Chi square test). The ABP value in the rats with CAL (CAL rats) was significantly lower than the non-CAL rats (94.3 ± 62.3 mmHg vs. 154.0 ± 41.7 mmHg, $p = 0.004$, Mann-Whitney test). In

the CAL rats, 69.2% (9 / 13) of segments burst at the site of the anastomosis, which was significantly higher than the 28% (7 / 25) in the non-CAL rats' ($p = 0.020$, Chi square test).

Most adhesions were centralized around the anastomosis, and most of them showed an adhesion score of 3 (strong adhesions). Although the 5-suture group had significantly more adhesions around the anastomosis than the 12-suture group (average of 3.2 vs. 2.5, $p = 0.001$, Mann-Whitney test), but their severities were similar (average of 3.0 vs. 2.9, $p = 0.627$, Mann-Whitney test). Comparison of the CAL rats with the non-CAL rats showed a similar number of adhesions around the anastomosis (average number 3.1 vs. 2.7, $p = 0.135$, Mann-Whitney test), while the adhesion score was higher in the CAL rats (average of 3.1 vs. 2.8, $p = 0.045$, Mann-Whitney test). The rats with an adhesion score of 4 (very strong adhesions) all leaked during follow-up.

Histology

Well-healed wounds, adhesion formation, and abscess formation around anastomoses were all observed during the histological examination (supplementary materials, figure 4). Comparison of the colonic sections between the samples underwent the ABP test (groups of first test-series and first repeat-series) showed no obvious difference with those which did not (groups of second repeat-series). Occasionally, the intervals between cells were larger in the sections that underwent the ABP test, especially in the muscle layer; however, it did not interfere with the scoring process. As no statistical differences were found between samples in either the 12- or 5-suture groups, data were pooled for further comparisons.

In all groups, the medians of inflammatory cell infiltration, fibroblast activity, neoangiogenesis, and collagen deposition were 3, 3, 2, and 2, respectively (2 = light scattering, 3 = abundant evidence). With regard to all these parameters, these were no statistical significant differences either between the 5- and 12-suture groups or between the CAL and non-CAL groups.

DISCUSSION

Anastomotic leakage still remains the most serious complication after gastrointestinal

surgery. In this study, we created a rat CAL model by means of technical failure in combination with partial colectomy. The CAL rate significantly increased from 23.3% to 48.3% when insufficient suturing was applied, and so did the CAL score. The reproducibility of the model was evaluated by two repeat-series. Application of this model may help to achieve a better consistency in future studies.

Close resemblance to human disease greatly determines the quality of an animal model. In previous CAL experimental studies, colorectal anastomosis was usually made after simple colon transection or short length resection [7, 8]. In contrast, the resected segments were much longer in this study, which was meant to increase the surgical-trauma severity. Human subtotal colectomy has much higher severity of surgical trauma than minor operations reflected by increased stress hormone and inflammatory cytokines levels (such as interleukin-6) [13, 14], which are considered as predictors of anastomotic leakage [15, 16]. Higher levels of interleukin-6 after rat colectomy were also observed in our pilot study (data not shown). In addition, partial colectomy in our study caused more blood loss and severer weight loss after surgery when compared with our previous rat colon transection model [17]. Overall, the additional colon resection explains the higher leakage rate of 23.3% in our 12-suture group when compared with that in previous studies [17, 18].

The leakage rate in 12-suture group is comparable to the human leakage rate after low anterior resection, which varies between 8% and 20% [1, 2]. This makes it a good basic form for studies targeting other CAL risk factors. Influences of technical failure, ischemia, steroid administration or other risk factors might be very well evaluated in combination with it, more rat leakage studies could be, therefore, derived from the same base. In this study, an important etiology of CAL, technical failure, was applied. The reduction of sutures from 12 to 5 caused an increased leakage rate as high as 48.3% in the 5-suture group, proving technical failure as the main etiology in this group.

We chose the CAL rate as the main outcome which directly targets the clinical situation. Thus a clear definition of CAL is essential to assure the standardized evaluation of CAL. Our research group consistently defines CAL as either fecal peritonitis or abscess formation around the anastomosis [19]. This definition correlates with the clinical CAL definition that was proposed by the international study group of rectal cancer, in which not only any anastomotic defect, but also abscess formation close to the anastomosis is also considered as CAL [3]. Our CAL definition is also supported by the histological results

(supplementary materials, figure 4), in which abscesses with feces in the core were found both on top of the anastomosis and also close to it. As a supplementary to CAL occurrence, classification of CAL severity is of great importance. The CAL score system we developed differentiated CAL severity between the 5-suture and 12-suture groups. Its further implementation would help to obtain more integrated information of CAL.

Day 7 after surgery was used in our study for the outcome evaluation, which is consistent with the median postoperative day of clinical diagnosis of leakage [1]. This follow-up time also suits the outcome evaluation, as firm adhesion formation may obscure the evaluation of anastomosis in a longer term, especially after two weeks [20]. The combination of day 7 with a shorter follow-up time (i.e. day 3), on the other hand, may be suggested to future studies because it provides substantial information of the acute phase of anastomotic wound healing [21].

In most CAL studies, colonic samples were usually harvested for histology after the ABP test, thus the question remains whether ABP would affect the histological examination. In our study, it was possible to compare the histological manifestations of samples that underwent the ABP test to those that did not. The results support the feasibility of semi-quantitative evaluation of HE staining after ABP testing, which may be also applicable to other CAL studies.

On the basis of level 1b evidence [22], we chose single-layer inverted anastomoses and a continuous-suturing pattern in the 12-suture group. The biomechanical strength of continuous suturing was similar to that of 12-interrupted suturing in our previous study [17], while continuous suturing was much less time consuming. All the anastomoses in this study were performed with a microscope. Seemingly challenging though, we found junior researchers were able to master it quickly after a few practices, resulting in a similar leakage rate and bursting pressure between different researchers in our on-going studies (data not shown).

For future application of the CAL model, it is essential to state that the acceptable interval we chose (20% to 50%) is not absolute, although extreme leakage rates should be avoided because of their inevitable drawbacks. Extremely high rates are considered to be incomparable to the clinical situation, and may cause a too high mortality during follow up, while extremely low rates will not be cost-effective. In addition, when a certain

intervention is applied, usually both positive and negative effects are possible to occur. CAL experimental models with extreme leakage rates will probably obscure the global picture of certain interventions.

CONCLUSION

Colorectal anastomotic leakage due to technical failure was consistently integrated into a rat model by means of partial colectomy with five interrupted sutures. Application of this CAL experimental model may help to achieve a better consistency in future rat studies on CAL.

REFERENCES

1. Kingham, T.P. and H.L. Pachter, Colonic anastomotic leak: risk factors, diagnosis, and treatment. *J Am Coll Surg*, 2009. 208(2): p. 269-78.
2. Snijders, H.S., et al., Meta-analysis of the risk for anastomotic leakage, the postoperative mortality caused by leakage in relation to the overall postoperative mortality. *Eur J Surg Oncol*, 2012. 38(11): p. 1013-9.
3. Rahbari, N.N., et al., Definition and grading of anastomotic leakage following anterior resection of the rectum: a proposal by the International Study Group of Rectal Cancer. *Surgery*, 2010. 147(3): p. 339-51.
4. Komen, N., et al., Anastomotic leakage, the search for a reliable biomarker. A review of the literature. *Colorectal Dis*, 2008. 10(2): p. 109-15; discussion 115-7.
5. Wu, Z., et al., Reducing Anastomotic Leakage by Reinforcement of Colorectal Anastomosis with Cyanoacrylate Glue. *Eur Surg Res*, 2013. 50(3-4): p. 255-261.
6. Vakalopoulos, K.A., et al., Tissue adhesives in gastrointestinal anastomosis: a systematic review. *J Surg Res*, 2013. 180(2): p. 290-300.
7. Wu, Z., et al., Critical analysis of cyanoacrylate in intestinal and colorectal anastomosis. *J Biomed Mater Res B Appl Biomater*, 2013.
8. Pommergaard, H.C., et al., Choosing the best animal species to mimic clinical colon anastomotic leakage in humans: a qualitative systematic review. *Eur Surg Res*, 2011. 47(3): p. 173-81.
9. Mansson, P., et al., Anastomotic healing in the rat colon: comparison between a radiological method, breaking strength and bursting pressure. *Int J Colorectal Dis*, 2002. 17(6): p. 420-5.
10. Jiborn, H., J. Ahonen, and B. Zederfeldt, Healing of experimental colonic anastomoses. I. Bursting strength of the colon after left colon resection and anastomosis. *Am J Surg*, 1978. 136(5): p. 587-94.
11. Zuhlke, H.V., et al., [Pathophysiology and classification of adhesions]. *Langenbecks Arch Chir Suppl II Verh Dtsch Ges Chir*, 1990: p. 1009-16.
12. Phillips, J.D., et al., Effects of chronic corticosteroids and vitamin A on the healing of intestinal anastomoses. *Am J Surg*, 1992. 163(1): p. 71-7.
13. Chernow, B., et al., Hormonal responses to graded surgical stress. *Arch Intern Med*, 1987. 147(7): p. 1273-8.
14. Evans, C., et al., Impact of surgery on immunologic function: comparison between minimally invasive techniques and conventional laparotomy for surgical resection of colorectal tumors. *Am J Surg*, 2009. 197(2): p. 238-45.
15. Herwig, R., et al., Early identification of peritonitis by peritoneal cytokine measurement. *Dis Colon Rectum*, 2002. 45(4): p. 514-21.
16. Ugras, B., et al., Early prediction of anastomotic leakage after colorectal surgery by measuring peritoneal cytokines: prospective study. *Int J Surg*, 2008. 6(1): p. 28-35.
17. Sliker, J.C., et al., Effects of new anti-adhesion polyvinyl alcohol gel on healing of colon anastomoses in rats. *Surg Infect (Larchmt)*, 2012. 13(6): p. 396-400.
18. Kanellos, D., et al., Effect of 5-fluorouracil plus interferon on the integrity of colonic anastomoses covering with fibrin glue. *World J Surg*, 2007. 31(1): p. 186-91.
19. Komen, N., et al., Colorectal anastomotic leakage: a new experimental model. *J Surg Res*, 2009. 155(1): p. 7-12.
20. Deerenberg, E.B., et al., Polyvinyl alcohol hydrogel decreases formation of adhesions in a rat model of peritonitis. *Surg Infect (Larchmt)*, 2012. 13(5): p. 321-5.
21. de Hingh, I.H., et al., Colonic anastomotic strength and matrix metalloproteinase activity in an experimental model of bacterial peritonitis. *Br J Surg*, 2003. 90(8): p. 981-8.
22. Sliker, J.C., et al., Systematic review of the technique of colorectal anastomosis. *JAMA Surg*, 2013. 148(2): p. 190-201.

TABLES AND FIGURES

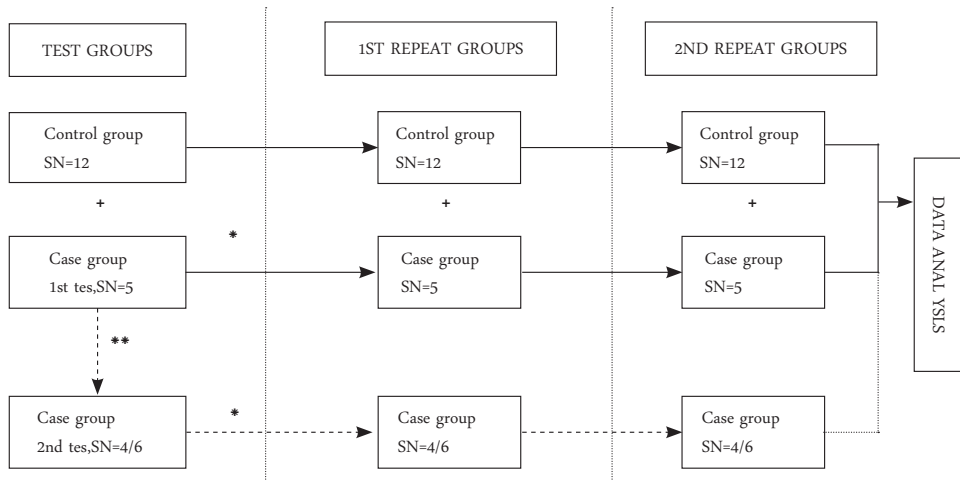

Figure 1. Flow chart of the study design. The study included three series of experiments: the test groups, the first repeat groups and the second repeat groups. The repeat groups were initiated only when an acceptable leakage rate (20% to 50%) had been achieved in the test groups. SN = suture number. * Acceptable CAL rate achieved. ** Acceptable CAL rate not achieved.

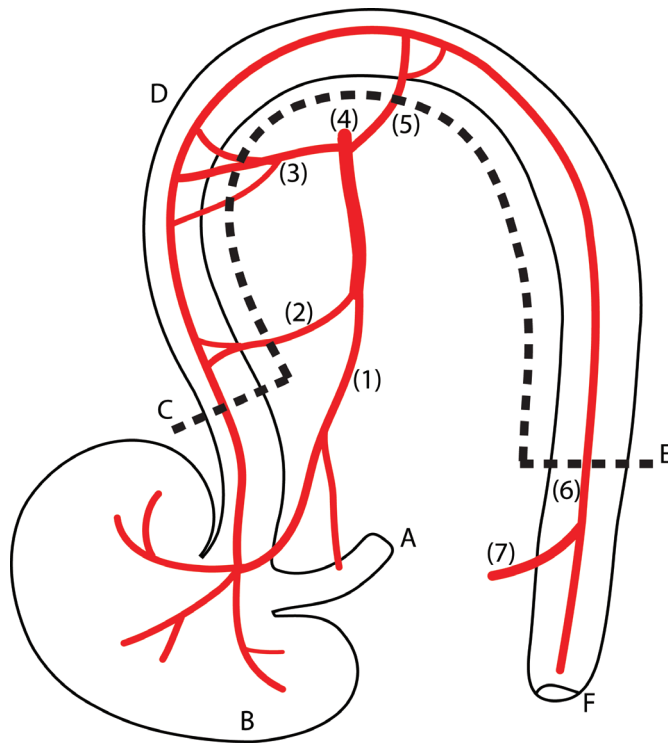

Figure 2. Schematic overview of artery distribution in rat colon; anterior view. (1). ileoceccocolic artery; (2). colic branch of ileoceccocolic artery; (3). right colic artery; (4). cranial mesenteric artery; (5). middle colic artery; (6). left colic artery; (7). caudal mesenteric artery. (A). terminal ileum; (B). caecum; (C). proximal cutting edge; (D). colon; (E). distal cutting edge; (F). anus.

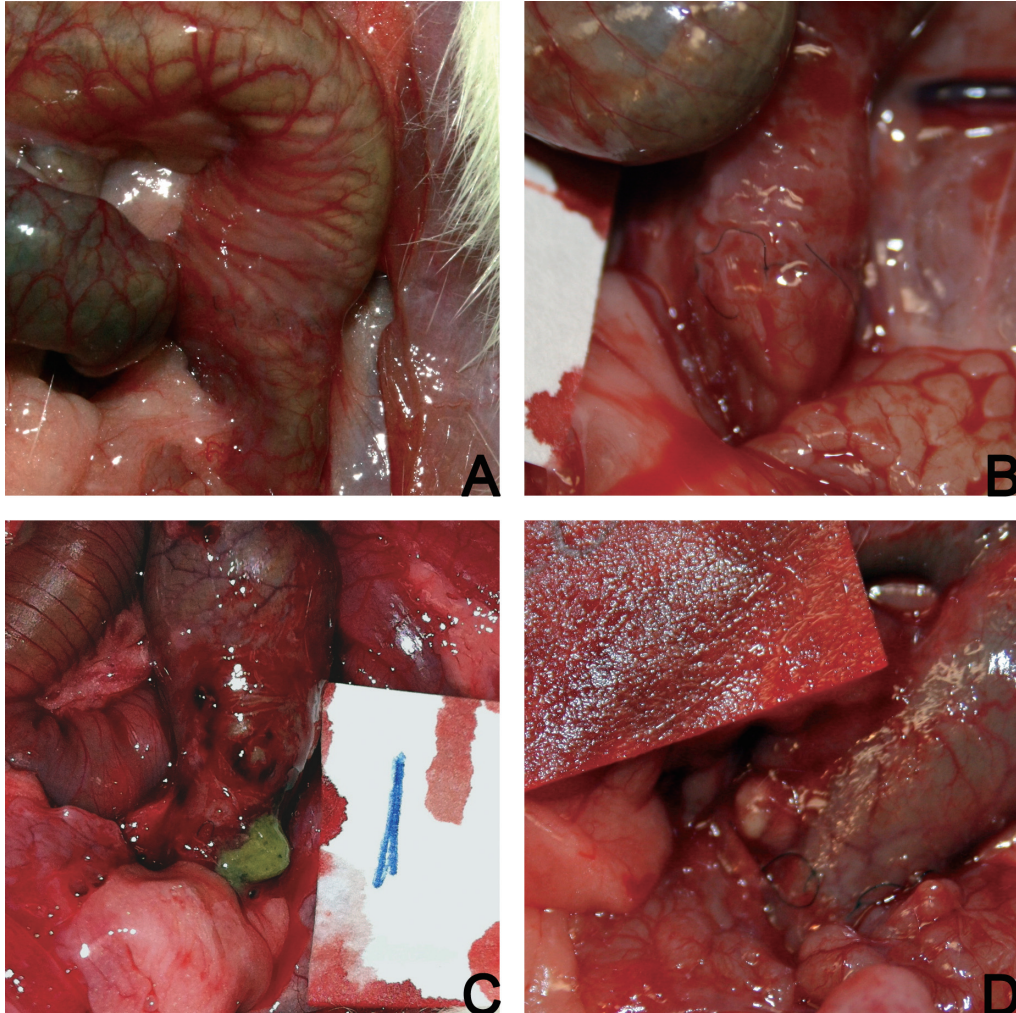

Figure 3: Clinical observation on day 7. A. Well healed anastomosis from 12-suture groups. The white marker shows an inverted suture line. B Good healing from 5-suture groups. The white marker shows an inverted suture line. C. Defect on the site of anastomosis. The white marker shows where feces leaked out during examination. D. Abscess on the site of anastomosis. The white marker shows an abscess.

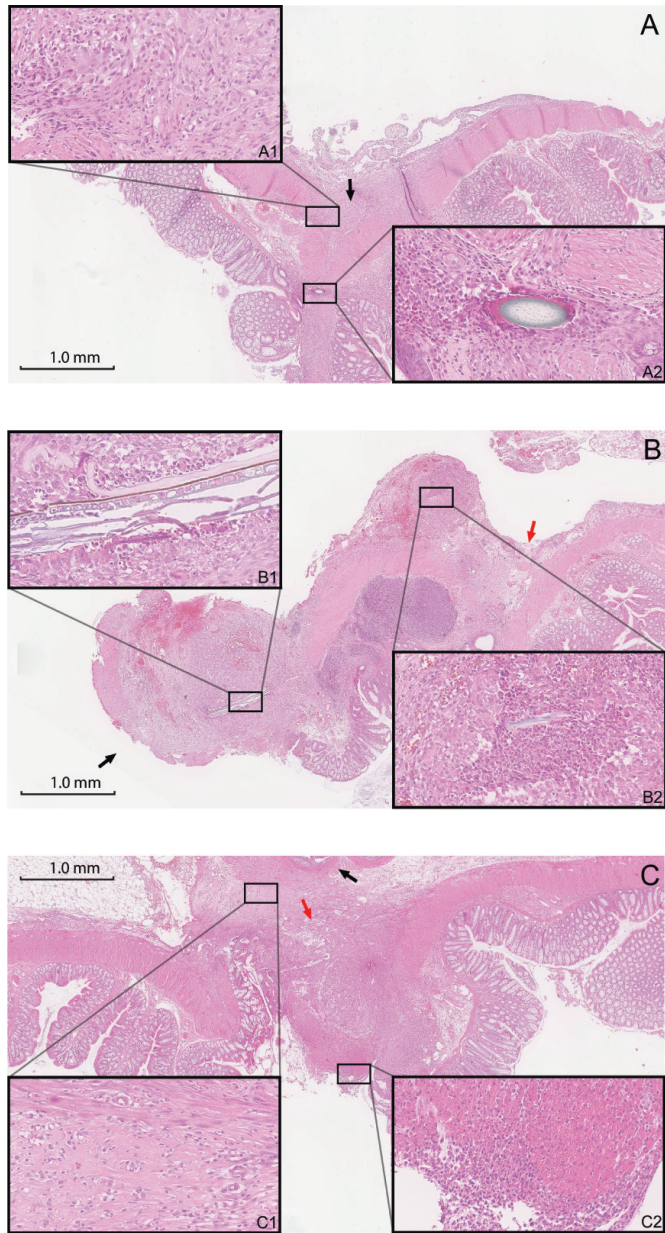

Figure 4. Histological observation of a well-healed anastomosis. The top side of the image represents the extra-luminal (peritoneal) side, and the bottom part of the image represents the intra-luminal side of the colon with mucosa.

A. Well healed anastomosis. The black arrow shows the firmly connected anastomotic site. Insert A.1: healing process indicated by an abundant number of fibroblasts; insert A.2: suture surrounded by foreign body multi-nucleated giant cells.

B. Anastomosis with leakage. The red arrow shows the site of the anastomotic connection demonstrating a lack of fibroblasts; the black arrow shows the site of abscess formation. Insert B.1 shows the abscess formation near the anastomotic site with feces (plant cells) in the center provoking an acute inflammatory response; insert B.2 shows the abscess formation at the site of anastomosis with feces (plant cells) in the center surrounded by an infiltrate of mainly neutrophilic granulocytes.

C. Anastomosis with adhesion. The red arrow shows a poorly connected anastomosis; the black arrow shows the site of adhesion formation. The insert C.1 shows the collagen formation due to the adhesion, note the sparse fibroblasts; insert C.2 shows the abscess formation under the anastomosis with necrosis and an acute inflammatory response.

Table 1. Scored Parameter for Adhesion (Zuhlke Score)

0	No adhesions
1	Filmy adhesions: easy to separate by blunt dissection; no vascularization
2	Stronger adhesions: blunt dissection possible but partly sharp dissection possible; beginning of vascularization
3	Strong adhesions: lysis possible but sharp dissection only; clear vascularization
4	Very strong adhesions: lysis possible by sharp dissection only (organ strongly attached with severe adhesions, and damage to organs hardly preventable)

Table 2. Colorectal Anastomotic Leakage (CAL) Rate and score between Groups on Day 7

	5-suture		12-suture	
	Leakage rate	Score	Leakage rate	Score
1st TEST	50.0% (5 / 10)	0.6	30.0% (3 / 10)	0.4
1st REPEAT	44.4% (4 / 9)*	0.8	20.0% (2 / 10)	0.2
2nd REPEAT	50.0% (5 / 10)	0.6	20.0% (2 / 10)	0.2
Total	48.3% (14 / 29)	0.67	23.3% (7 / 30)**	0.27#

Note: Data are presented as CAL rate (leakage number / total number), and mean leakage score. * One death of fecal peritonitis was not included on day 7 CAL rate. ** p = 0.045, Chi square test.# p = 0.027, Mann-Whitney test.

Table 3. Anastomotic Bursting Pressure between Groups

	5-suture groups	12-suture groups	P value
1st TEST	107.4 ± 51.6	152.6 ± 61.1	0.028*
1st REPEAT	127.2 ± 67.7	148.5 ± 41.7	0.483*
2nd REPEAT	-	-	-
Total	116.8 ± 58.9	150.4 ± 50.3	0.041*

Chapter 3:

Summary of Rat Models Employed in the Thesis

INTRODUCTION

This thesis focuses on the prevention and detection of colorectal anastomotic leakage (CAL), for which animal CAL models are undoubtedly essential. To date, most CAL animal studies are performed with rat models, while unfortunately many models represent substantial heterogeneity in their methodology, increasing the difficulty to compare results between different models[1-3]. In Chapter 2, we reported the standard rat colectomy model, which provides us a standardized basis for further development of CAL models. We combined this model with various risk factors of CAL and created several CAL models in different studies, which are described in Chapter 2, 8, 9, and 11 respectively. In those chapters, the CAL models are often compared with other interventional groups with preventive treatments. However, an overview of CAL models, though important, is not available. In this respect, this Chapter summarizes these CAL models in order to provide a better overview among those models.

METHODS

The perioperative daily care such as living conditions, food and water supply, and animal welfare was standard and is reported in each study respectively. The differences in the methods are mainly represented in the surgical techniques, which are summarized as follows:

Model 1: subtotal colectomy model

Detailed methods are described in Chapter 2. In summary, the rat was anesthetized and a laparotomy was performed through a midline incision. The mesenteric arteries including the colic branch of the ileocecolic artery, the right, middle, and left colic arteries were identified and ligated (Silkam 4/0, B. Braun, Germany). The colonic segment between 1.0 cm aborally to the cecum and 0.5 cm above the caudal mesenteric artery was resected (Figure 1). Then a full thickness inverted end-to-end anastomosis was created with one-layer inverting suturing (12 continuous sutures) with Dafilon 8/0 (B. Braun, Germany) with the microscope. Finally, the abdominal wall was closed.

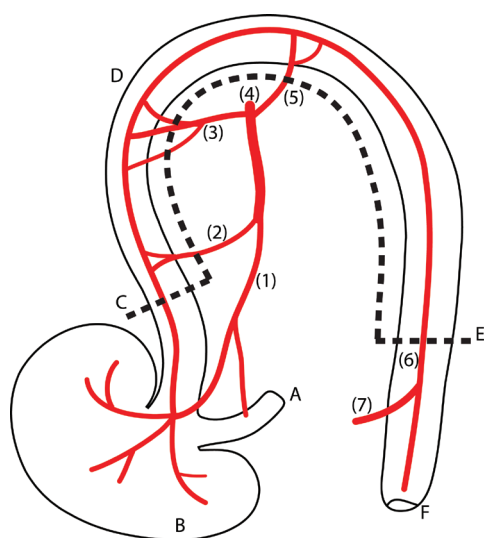

Figure 1. Schematic overview of artery distribution in rat colon; anterior view. (1) ileocecolic artery (2) colic branch of ileocecolic artery (3) right colic artery (4) cranial mesenteric artery (5) middle colic artery (6) left colic artery (7) caudal mesenteric artery. (A) terminal ileum (B) caecum (C) proximal cutting edge (D) colon (E) distal cutting edge (F) anus.

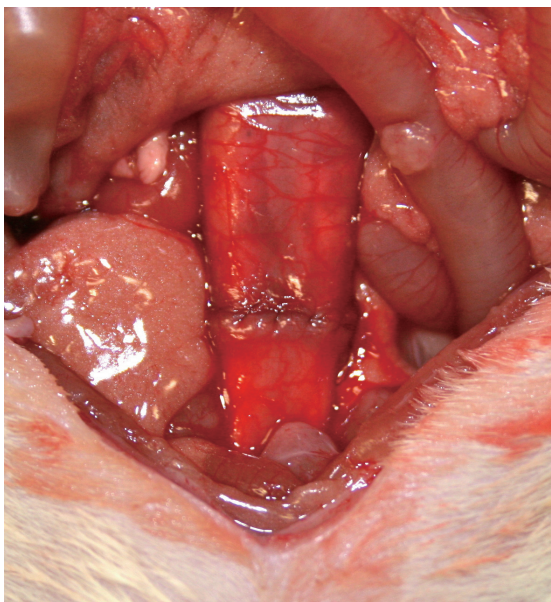

Figure 2. Inverted colorectal anastomosis in rats, using 12 sutures.

Model 2: subtotal colectomy with insufficiently sutured anastomosis

The methods are similar to the model 1, with the only difference that the anastomosis is constructed with five interrupted sutures instead of twelve continued sutures. The first suture was positioned at the mesenteric site, and then the other sutures were applied in an anti-clockwise sequence and spaced equally around the whole circumference. The following methods are the same as model 1.

Model 3: Subtotal colectomy with colitis

We developed the trinitrobenzene sulfonic acid (TNBS)-colitis-colectomy model by combining the TNBS colitis model with our previously validated rat colectomy model [4-5]. The detailed methods are described in Chapter 9. In summary, as shown in Figure 2: (1) seven days before the colectomy, a TNBS solution (10 mg diluted in 25% ethanol; 0.25 ml) is injected trans-anally with a plastic cannula, causing colon damage (d in Figure 2); (2) During colectomy, a major part of the colon (i.e. selected with dashed line and indicated with grey colour) is resected; (3) After colon resection, an end-to-end one-layer continuous anastomosis (red arrow) was constructed in an inverted fashion, with an identical technique compared with model 1. The rest of the procedures are same as compared with model 1 (Figure 2).

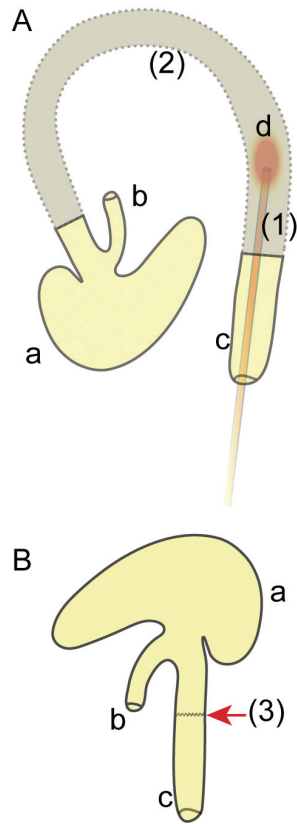

Figure 3: Schematic overview of rat colon and methodology employed for the trinitrobenzene sulfonic acid (TNBS)-colitis-colectomy model, anterior view. (A) Rat colon before colectomy (B) Rat colon after colectomy. Anatomy: a. caecum, b. terminal ileum, c. rectum and anus, d. colitis lesion (intraluminal).

Model 4: subtotal colectomy with ischemic anastomosis

The method is similar to model 1. However, during colectomy, the ileocolic artery and the left colic artery are both ligated, creating an ischemic anastomosis. Such procedure substantially decreases the blood supply to the cecum and both sites of the anastomosis. The following procedures are the same as compared with model 1.

Model 5: colorectal anastomosis in fecal contaminated environment

The detailed methods are described in Chapter 8. To induce peritonitis, the rat caecal ligation puncture (CLP) model was employed [6-7]. Twentyfour hours later, the rat was

anesthetized again. The abdomen was reopened and 6 mg/kg of gentamicin (Centrafarm, Etten-Leur, The Netherlands) was injected intramuscularly. The ligated caecum was resected, the abdominal cavity was rinsed with at least 20mL phosphate buffered saline (PBS; 37°C), and colorectal anastomosis was performed afterwards. Instead of a subtotal colectomy, a colon segment of 1 cm in length was resected approximately 3 cm proximally to the peritoneal reflection. An end-to-end one-layer continuous anastomosis was constructed in an inverted fashion (same as model 1) with Dafilon 8-0 (B. Braun, Melsungen, Germany). The other procedures are the same as compared with model 1.

RESULTS

We summarized the short-term (postoperative day 3) results of these five rat models in Table 1. The data and the corresponding ranges were estimated from the raw data from different studies performed by our research group (Chapter 2, 8, 9,11, unpublished data). These data are not absolute but to provide an overview of the differences between the models.

As is shown in Table 1, the perioperative mortality rate is low in the colectomy model, while in the leakage models (i.e. model 2-5) the rates are all higher. The highest mortality was observed in the ischemic anastomosis leakage model (model 4), in which a mortality rate of 25% was observed (unpublished data). In the leakage models, higher rates of anastomotic dehiscence were observed as well, which was found to be the highest in the insufficient anastomosis leakage model (model 2). Higher rates of anastomotic abscess formation, also with higher severity, have been observed in different studies in the leakage models. Often large abscesses were observed during postoperative examination.

An average anastomotic bursting pressure (ABP) of 80-100 mmHg has been constantly reported in different studies in the standard colectomy model (Chapter 2, 9, 11, unpublished data), while ABP was much lower in the leakage models. In addition to the impaired mechanical strength, lower anastomotic perfusion has been recorded in them as well.

Table 1. Summarized results of the colorectal leakage rat models.

Model name	Mortality rate (%)	Dehiscence rate (%)	Abscess rate (%)	Abscess severity	ABP	Perfusion
Standard rat colectomy model	<5	<10	20-40	Low	80-100	Normal
Insufficient anastomosis leakage model*	5-15	40-60	>90	High	10-40	Low
TNBS-colitis-colectomy model	5-15	10-30	>70	High	40-60	Low
Ischemic anastomosis leakage model*	15-30	30-50	>80	High	40-70	Low
Contaminated anastomosis leakage model	5-15	10-30	>90	High	10-40	N.T.

Note: * = unpublished data; N.T. = not tested; ABP = anastomotic bursting pressure; M1: macrophage subtype 1; M2: macrophage subtype 2.

DISCUSSION

This chapter summarizes all rat models we used in this thesis to provide an overview of them. These models targeting different risk factors of CAL respectively: with the standard colectomy model (model 1) as the basis, the insufficient anastomosis leakage model (model 2) focuses on anastomotic failure; the TNBS-colitis-colectomy model (model 3) represents a combination of model 1 and experimental colitis; the ischemic anastomosis leakage model (model 4) includes anastomotic ischemia into the colectomy model; the contaminated anastomosis leakage model (model 5), though not derived from the colectomy model, introduces bacterial peritonitis on the basis of a transection colon anastomosis.

The model two reported in this chapter and many other insufficient anastomosis leakage models are often challenged since surgeons would never construct an insufficient anastomosis on purpose [8]. However, the purpose of the artificial failure is to increase the incidence of communication between the intra- and extra-luminal compartments. The other risk factors included in the leakage models are all based on clinical evidence [1,9-13]. Our experimental data are in line with the clinical evidence, demonstrating a satisfactory representation of the current clinical issues by these models.

It is important to address that although varying risk factors have been introduced in these models respectively, similar characteristics of CAL are observed including low mechanical strength, anastomotic infection, and anastomotic ischemia. These similar CAL

manifestations caused by various factors suggest an integrated mechanism during the occurrence of CAL, which is discussed in detail in Chapter 12.

The advantages of using the standardized colectomy model (model 1) as a common basis in CAL research are evident. As is shown in our results, it provides clearer comparison. Not only in the leakage models, with a standard model as basis, results from different studies investigating various interventions may also be compared with each other. The standardized colectomy model has been repeated several times with consistent data (unpublished data). We therefore encourage further applications of the model as the conceptual basis for future studies on colorectal anastomotic leakage.

REFERENCES

1. Wu, Z., et al. Prevention of Anastomotic Leakage with Tissue Adhesives in Contaminated Environment. in *British journal of surgery*. 2013. WILEY-BLACKWELL 111 RIVER ST, HOBOKEN 07030-5774, NJ USA.
2. Vakalopoulos, K.A., et al., Tissue adhesives in gastrointestinal anastomosis: a systematic review. *J Surg Res*, 2013. 180(2): p. 290-300.
3. Wu, Z., et al., Critical analysis of cyanoacrylate in intestinal and colorectal anastomosis. *J Biomed Mater Res B Appl Biomater*, 2013.
4. Menozzi, A., et al., Long-term study of TNBS-induced colitis in rats: focus on mast cells. *Inflamm Res*, 2006. 55(10): p. 416-22.
5. Wu, Z., et al., Colorectal anastomotic leakage caused by insufficient suturing after partial colectomy: a new experimental model. *Surgical Infection*, 2014: p. Accepted article.
6. Deerenberg, E.B., et al., Polyvinyl alcohol hydrogel decreases formation of adhesions in a rat model of peritonitis. *Surg Infect (Larchmt)*, 2012. 13(5): p. 321-5.
7. Deerenberg, E.B., et al., Experimental study on synthetic and biological mesh implantation in a contaminated environment. *Br J Surg*, 2012. 99(12): p. 1734-41.
8. Pommergaard, H.C., et al., Choosing the best animal species to mimic clinical colon anastomotic leakage in humans: a qualitative systematic review. *Eur Surg Res*, 2011. 47(3): p. 173-81.
9. Golub, R., et al., A multivariate analysis of factors contributing to leakage of intestinal anastomoses. *J Am Coll Surg*, 1997. 184(4): p. 364-72.
10. Tang, R., et al., Risk factors for surgical site infection after elective resection of the colon and rectum: a single-center prospective study of 2,809 consecutive patients. *Ann Surg*, 2001. 234(2): p. 181-9.
11. Vignali, A., et al., Altered microperfusion at the rectal stump is predictive for rectal anastomotic leak. *Dis Colon Rectum*, 2000. 43(1): p. 76-82.
12. Hendriks, T. and W.J. Mastboom, Healing of experimental intestinal anastomoses. Parameters for repair. *Dis Colon Rectum*, 1990. 33(10): p. 891-901.
13. de Hingh, I.H., et al., Colonic anastomotic strength and matrix metalloproteinase activity in an experimental model of bacterial peritonitis. *Br J Surg*, 2003. 90(8): p. 981-8.
14. van der Ham, A.C., et al., Healing of ischemic colonic anastomosis: fibrin sealant does not improve wound healing. *Dis Colon Rectum*, 1992. 35(9): p. 884-91.
15. Komen, N., et al., High tie versus low tie in rectal surgery: comparison of anastomotic perfusion. *Int J Colorectal Dis*, 2011. 26(8): p. 1075-8.
16. Grommes, J., et al., Comparison of intestinal microcirculation and wound healing in a rat model. *J Invest Surg*, 2013. 26(1): p. 46-52.

PART II

PREVENTION OF COLORECTAL
ANASTOMOTIC LEAKAGE WITH
TISSUE ADHESIVES

Chapter 4:

Sealants in Gastrointestinal Anastomosis: a Systematic Review

K.A. Vakalopoulos, F. Daams, Z. Wu, L. Timmermans, J. Jeekel, J.F. Lange

Journal of Surgical Research, 2013 (published)

ABSTRACT

Introduction: Anastomotic leakage (AL) in gastrointestinal (GI) surgery remains a major problem. Although numerous studies on the role of tissue adhesives as GI anastomotic sealants have been undertaken, no clear overview has been presented. This systematic review aims to provide a clear overview of recent experimental and clinical research on the sealing of different levels of GI anastomosis with tissue adhesives.

Methods: MEDLINE and EMBASE databases were searched for clinical and experimental articles published after 2000. Articles were included only if these addressed a tissue adhesive applied around a GI anastomosis to prevent AL or decrease leakage related complications. Results were categorized according to level of anastomosis, category of tissue adhesive and level of evidence.

Results: In total 48 studies were included. 3 studies were included on esophageal anastomosis, 13 on gastric anastomosis, 4 on pancreatic anastomosis, 8 on small intestinal

anastomosis and 20 on colorectal anastomosis. 15 of the 48 studies were on humans.

Discussion: Research on Ileal and gastric/bariatric anastomosis reveals promising results of Fibrin Glue (FG) sealing for specific clinical indications. Sealing of pancreatico-enteric anastomosis does not seem useful for high-risk patients, however research in this field is limited. Ileal anastomotic sealing was promising in every included study and calls for clinical evaluation. For colorectal anastomoses sealing with FG sealing seems more positive than for cyanoacrylate. Further research should concentrate on the clinical evaluation of promising experimental results as well as on new types of tissue adhesives. This research field would benefit from a systematic experimental approach with comparable methodology.

INTRODUCTION

Each year millions of gastrointestinal (GI) anastomoses are created worldwide. Anastomotic leakage (AL) after the creation of a GI anastomosis remains an important complication in GI surgery. Despite years of research incidence of AL remains high, especially after esophageal and colorectal anastomosis [1-3]. AL is known to have a multifactorial etiology, mostly based on ischemia of the bowel endings and/or technical failure. Many risk factors are known, and can be categorized into patient related risk factors (i.e. co-morbidity, body mass index, drug use) and operative factors (i.e. surgeon's experience, after-hours surgery, anastomotic location and operating time) [2-4].

Tissue adhesives have been gaining popularity in various fields of surgical practice, especially in skin closure. There are various types of tissue adhesives, each with their own adhesive mechanisms and uses [5]. Basically, a tissue adhesive forms bonds with its substrate ensuring sufficient adhesion. These bonds can either be chemical, of which covalent bonds are the strongest, or physical, including hydrogen bonds or van der Waals forces [6]. Furthermore, the total strength of the glue bond depends on the balance between interaction within the tissue adhesive (cohesion) and between the tissue adhesive-substrate interface (adhesion). Tissue adhesives can either be glues: intended to independently connect various structures (i.e. wound edges), or sealants: used to cover and protect an anastomosis.

Except for external use, tissue adhesives can also be used intracorporeally; Various

tissue adhesives are being used in (cardio-)vascular surgery, plastic surgery and increasingly in surgery of the GI tract [7,8]. Tissue adhesives are promising tools for wound closure. They distribute forces throughout the wound more evenly and non-invasively than sutures and staples, are strong and flexible and do not interfere with the wound healing process. Also, the technique of tissue adhesive application to the wound is easy and standardizable, resulting in less variation in technique between surgeons.

By using tissue adhesives as sealants of GI anastomosis, enhancing standard anastomotic techniques, anastomotic leakage might be prevented or reduced and its clinical symptoms ameliorated. Numerous research projects have been undertaken to assess the applicability of available tissue adhesives in GI surgery; however no recent literature provides the surgical community with an up-to-date overview of the progress in this field.

This systematic review includes recent information on tissue adhesives with regard to all types of anastomotic configurations in the GI tract and provides a means to discover similarities and make comparisons between different levels of anastomoses. An overview is provided on all available clinical and experimental research concentrating on the use of tissue adhesives around the GI anastomosis, either as suture reinforcement or in sutureless closure, presented by level of anastomosis and category of tissue adhesive used.

We hypothesize that the use of tissue adhesives around a GI anastomosis is a viable concept in the prevention of anastomotic leakage and that sufficient evidence, especially clinically, has arisen during the past years to justify the implementation of several types of tissue adhesives for routine use.

METHODS

Search strategy

This systematic review was performed according to the PRISMA guidelines [9]. A literature search was performed including all relevant articles from the 1st of January 2000 until the 12th of May 2011. The search was performed in EMBASE and MEDLINE databases. Only English articles were included. Review articles and meta-analyses were excluded.

Study selection

Articles were included only if these addressed a tissue adhesive applied around a GI anastomosis to prevent AL or to decrease leakage related complications. The definition of tissue adhesive used for the purpose of this review was arbitrarily described as ‘any liquid or gellous substance capable of adhering directly to the outer gastrointestinal tissue surface, without the need for an extra matrix layer’. Studies on use of tissue adhesives with regard to the treatment of GI perforations and GI fistulas were excluded, as were studies using artificial matrix or patch mounted tissue adhesives in GI anastomosis.

The following data were extracted for the clinical studies:

First author and year of publication

Level of evidence (following the Centre of Evidence Based Medicine, University of Oxford)

Study design

Number of subjects

Location of anastomosis in gastrointestinal tract

Anastomotic technique

Tissue adhesive used and mode of application

Definition of outcome by the authors (AL, clinical AL, radiological AL, complication rate)

Results and statistical analysis

The following data were extracted for the experimental studies:

First author and year of publication

Study design

Number of animals per group

Anastomotic technique

Type of tissue adhesive used and mode of application

Species

Outcome parameters for anastomotic healing (AL, anastomotic bursting pressure (ABP), breaking strength, histology, or collagen-concentration)

Results and statistical analysis

The following search strategy was used:

((((anastom*[tw] OR Anastomosis, Surgical[mesh]) AND (Gastrointestinal Tract[mesh] OR gastrointest* OR gastric*[tw] OR intestin*[tw] OR colorect*[tw] OR colon[tw] OR rectum[tw] OR rectal[tw] OR esophag*[tw] OR oesophag*[tw] OR duoden*[tw])) OR Biliopancreatic Diversion*[tw] OR Esophagoplast*[tw] OR Esophagostom*[tw] OR Gastrectom*[tw] OR Gastroenterostomy[mesh] OR Gastroenterostom*[tw] OR Jejunioileal Bypass*[tw] OR Pancreaticoduodenectom*[tw] OR Pancreaticojejunostom*[tw]) AND (adhesive*[tw] OR seal*[tw] OR Glue*[tw] OR Gluing[tw] OR Tissue Adhesives[mesh]) AND (2000[pdat]:2011[pdat]) AND english[lang])

RESULTS

An overview of all types of tissue adhesives, as mentioned in the included articles, is provided in table 1. Results are summarized below according to level of GI anastomosis. Results are grouped by type of research (experimental or clinical) and by tissue adhesive category; tissue adhesive categories are only mentioned if they were used in at least one included study.

Tissue adhesives in esophageal surgery (table 2)

a) Experimental studies

Fibrin glue/ Cyanoacrylate

The role of sealing in esophageal surgery has been investigated experimentally by Yurtcu et al. 10. In this rabbit study three tissue adhesives, including fibrin glue (FG) and cyanoacrylate glue (CA), were applied on an esophago-gastric anastomosis. No AL was observed in any of the study groups and CA showed superior histological scores and higher bursting pressure when compared to the other groups.

b) Clinical studies

Fibrin glue

Two clinical trials have been conducted to study the use of FG in esophageal surgery in infants. Level 1b evidence is provided in a randomized controlled trial (RCT) performed by Upadhyaya et al. In this study the application of FG (Tisseel) to end-to-end esophagostomies for esophageal atresia was investigated 11. The Tisseel group showed significantly less leakage and strictures compared to the control group. A case-control study by Saldana et al. showed significant reduction of AL after FG sealing of 14 esophagectomies with colonic interposition 12. No clinical studies could be found on regular esophagectomies in adults.

Tissue adhesives in gastric/bariatric surgery (table 3)

No studies evaluating the use of tissue adhesives in patients undergoing gastrectomy were found.

a) Experimental studies

Fibrin glue

FG was evaluated in two studies. In a pig model of insufficient gastro-jejunostomy,

in which a defect was created in the anastomotic line, Bonanomi et al. and Nguyen et al. independently showed improvement of the AL rate (from 100% to 0 % and from 83% to 0%) after FG sealing when compared to unsealed controls 13-14 .

Cyanoacrylate

CA was tested in one study. Weiss et al. reported that sealing of the gastro-jejunal anastomosis in a rat model with cyanoacrylate was not inferior to an unsealed anastomosis, with regard to AL rate, stricture, peritonitis and mortality rate 15.

Other categories

In an ex-vivo pig study, Nandakumar et al. reported that the use of glutaraldehyde-albumin glue (BioGlue) to reinforce complete and incomplete circular stapled gastro-jejunosomies resulted in significantly increased anastomotic bursting pressure (ABP) when compared to an unsealed control group 16.

b) Clinical studies

Fibrin glue

Clinical evidence for the effectiveness of FG is derived from nine studies, including one level 1b RCT and six level 2b prospective cohort studies . Silecchia et al. performed the only RCT [17]. In this multicentre, prospective RCT FG was applied to both the gastrojejunal and jejunojejunal anastomoses during (laparoscopic) Roux-en-Y-Gastric Bypass ((L) RYGB). The differences in AL between the two groups (3/160 in control group and 1/160 in FG group) were not significant, however, the overall reoperation rate for specific early complications (AL, internal hernia and gastrojejunal anastomotic bleeding) was lower in the FG group ($p=0.016$). The incidence of major late complications was similar in both groups. Liu et al. found, in a nonrandomized case-control study that patients in which the gastro-jejunal anastomosis was sealed with FG after RYGB developed significantly less AL than the unsealed controls [18]. One prospective study by Efthimiou et al., in which 474 patients undergoing Laparoscopic Roux-en-Y Gastric Bypass received FG sealing of gastro-jejunal anastomosis and gastric staple line, showed no effect of sealing on the incidence of AL. However, they found that FG is associated with an increased clinical inflammatory response

mimicking AL [19]. Four observational uncontrolled studies showed low prevalence of AL after the use of FG in LRYGB (Sapala et al. 0% (0/738) [20], Cottam et al. 1.6% (2/126) [21], Raquel et al. 2% (2/100) [22], Nguyen et al. 0% (0/66) [14]). Retrospectively, Fullum et al. reported three leaks in 760 (.39%) LRYGB performed by a single surgeon using FG [23].

Other categories

One case report on the use of autologous platelet gel in 10 morbidly obese patients undergoing LRYGB reported positive effects of autologous platelet gel [24]. Contrast study on the first postoperative day showed no AL in any patient, and no AL was seen during the follow-up period (7 days).

Tissue adhesives for pancreatic anastomosis (table 4)

a) Experimental studies

Other categories

Argyra et al. performed a study on 10 pigs in which a sutureless pancreatico-jejunal anastomosis with polyethylene glycol glue (PEG) was created [25]. They concluded that the use of PEG was technically feasible, prevented AL and did not interfere with the wound healing process.

a) Clinical studies

Fibrin glue

Clinically, level 1b evidence was derived from Lillemoe et al. who presented a RCT with 124 patients undergoing pancreatico-duodenal resection in which the pancreatico-jejunosomy was sealed with FG [26]. In this study on high-risk patients (i.e. soft normal texture gland and a non-dilated pancreatic duct) FG did not reduce the incidence of pancreatic fistula, length of hospital stay, total complications or death. Oida et al. reported a prospective series of [26] patients undergoing pancreatico-duodenectomy and subsequent sealing of the pancreatico-gastrostomy with FG and round ligament [27]. In this study no leakage was seen in any patients.

Other categories

One retrospective case-control study on 64 patients in which the pancreatico-jejunosomy was sealed with glutaraldehyde-albumin glue (BioGlue) reported 12 leaks and subsequent fistula formation in the control group, and 13 in the BioGlue group. This difference was not statistically significant [28].

Tissue adhesives in small intestinal anastomosis (table 5)

a) Experimental studies

Fibrin glue

Li et al. performed two rat studies in which they combined FG with human derived growth hormone. They found that FG benefited anastomotic healing up to five days, and FG combined with growth hormone worked synergistically to improve anastomotic healing up to 14 days [29]. Wang et al. also reported that FG combined with growth hormone decreased AL and improved anastomotic healing in a pig model of traumatic shock [30]. Another study on canine jejunal anastomoses compared hemostatic and adhesive effects of two types of FG (Greenplast and Tisseel). One case of AL was apparent in the control group and none in the glue groups. It was reported that both glues had similar haemostatic and adhesive properties and may be useful as anastomotic sealants [31].

Cyanoacrylate

Elemen et al. used industrial grade cyanoacrylate (Pattex) for the creation of ileal anastomosis in a rat model [32]. In this study the glue caused less tissue damage and the glued anastomoses healed better than the controls. Another cyanoacrylate (Glubran 2) was evaluated by Ensäri et al. In this study jejunal anastomoses were sealed with Glubran 2 in 40 rats and ischemia reperfusion was induced prior to anastomosis creation [33]. The authors reported that Glubran 2 significantly increased ABP either with or without existence of ischemia/reperfusion and also increased adhesion formation around the anastomosis.

Other categories

In a study by Sweeney et al. PEG sealant (Focalseal-L) was tested in a rabbit model for incomplete ileal anastomosis [34]. According to this study an incomplete ileal anastomosis sealed with Focalseal-L was not inferior to a sutured anastomosis in terms of adhesion formation, stenosis and ABP.

b) Clinical studies

Fibrin glue

One clinical study was performed, a level 2b cohort study by Wang et al. in which patients with intra-abdominal sepsis underwent primary anastomosis and FG sealing [35]. They conclude that FG protected the primary anastomosis in patients with intra-abdominal sepsis, therefore preventing the need for stoma construction.

Tissue adhesives in colorectal anastomosis (table 6)

a) Experimental studies

Fibrin glue

In this field the majority of research has been performed on rats. Several authors performed a 1-2 cm resection and end-to-end anastomosis of the descending colon. Akgun et al. and Girgin et al. independently reported that FG sealing of the anastomosis significantly increased ABP after 3 and 7 days respectively, when compared with a control group [36-37]. In another study by Giuratrabocchetta et al. three different colonic anastomosis in each rabbit were randomized for sealing with FG or PEG sealant [38]. No differences were found between these adhesives and the control group, regarding ABP and AL, after 15 days. In the other included studies, anastomosis was performed at the level of the transverse colon. Kanellos et al. found that FG sealing resulted in significantly higher ABP compared to a control group, however no significant differences were found in AL rate or histopathology after 8 days [39]. In following studies by the same authors, FG protected anastomotic healing from the adverse effects of 5-fluorocil [40], interferon-alpha-2a [41] and leucovorin application [42]. Another study also showed that FG significantly increased ABP and also resulted in fewer adhesions, more fibroblast production and increased neovascularisation

[43]. Furthermore, two studies were included on the creation of a sutureless colonic anastomosis. In one study the tensile strength of the anastomosis was lower than the sutured anastomosis, and it caused stricture in 8.57% of cases. FG did, however, result in lower inflammation, minor edema, quick fibrous healing and did not result in any AL [44]. In another study, Tingstedt et al. compared three-suture ileocolic with sutureless FG anastomosis [45]. After three and five days, no differences were found in ABP or mortality rate.

Cyanoacrylate

In two rat studies a 1-cm resection was performed in the transverse colon followed by an end-to-end anastomosis. Bae et al. used Histoacryl Blue both as an anastomotic sealant and for sutureless anastomosis [46]. They found no AL in any groups, but reported that the use of CA resulted in significantly higher strictures, lower ABP and a strong inflammatory response. Kanellos et al. created sutureless anastomosis with Dermabond [47], reporting no difference in AL rate between controls and CA. Furthermore they found no significant differences for the amount of adhesions, ABP and wound healing scores. In three rat studies the anastomosis was created in the descending colon, following a 0.5-1 cm resection. Irkorucu et al. studied the effect of GluSeal as an anastomotic sealant and for sutureless anastomosis, following ischemia [48]. No significant differences were found in AL rate, and in the ischemia groups no differences were found in ABP. The CA groups had significantly less inflammatory cell presence and fibroblast infiltration in the granulation tissue than the controls. Histoacryl Blue was also evaluated in a similar model for sutureless anastomosis [49]. Authors found no effect on AL rate, but reported more stricture formation, adhesions and lower ABP, when compared to the control group. Glubran 2 was also evaluated in a clean- contaminated or bacterial peritonitis environment [50]. The authors concluded that Glubran 2 caused increased inflammatory reaction, necrosis and adhesion formation, especially in the bacterial peritonitis group. No differences in AL rate were reported between groups. Nursal et al. used Dermabond to seal a high-risk three suture anastomosis crushed by forceps [51]. The authors reported no differences in AL, but found that CA decreased ABP at 7 days. Also, both at 3 and 7 days an ongoing inflammatory reaction and more necrosis was seen in the CA group. Lastly, Paral et al. compared two types of CA (Glubran 2 and Dermabond) for the creation of sutureless sigmoidal anastomoses in a pig model [52]. They reported no AL in the Glubran 2 group, and two cases in the Dermabond group. Also, Dermabond was linked to higher foreign body reaction and more fibrosis of the anastomosis.

Other categories

Ustek et al. reported that the use of polydione-liposome (PVP-1) hydrogel around a (descending) colon anastomosis in the rat improved wound healing after 7 days, reflected by significantly higher ABP and hydroxyproline levels in the PVP-1 group [53]. Another study by Yol et al. compared the use of platelet rich plasma (PRP) or glutaraldehyde-albumin glue (BioGlue) around a 6 suture anastomosis [54]. The authors reported that PRP sealing resulted in significantly higher ABP and hydroxyproline levels when compared to the BioGlue and control groups, after 7 days. Furthermore, the BioGlue group showed higher infiltration of inflammatory cells, collagen and fibroblasts.

b) Clinical studies

Fibrin glue

In a prospective cohort study Huh et al. reported on 223 patients that underwent laparoscopic low anterior resection for rectal cancer, without the use of a defunctioning stoma [55]. Stapled anastomoses were created intracorporeally and one of two types of FG were applied around the anastomosis via a catheter. In this study the use of FG was not associated with a decrease in AL (5.8 % vs. 10.9%; $p=0.169$).

DISCUSSION

Anastomotic leakage remains an important complication in GI surgery. It is a significant cause of morbidity and mortality, necessitating redo operations and increasing length of hospital stay [56-57]. AL occurs in every level of GI surgery. In this review we have addressed recent tissue adhesive research for all levels of GI anastomosis.

Esophageal: the extraperitoneal anastomosis created in the esophagus is associated with a high incidence of AL, ranging from 10 % to 27% [58-59]. The factors involved include poor blood supply to the esophagus, the absence of a protective omentum and the

lack of a supporting serosal layer on the esophagus [12]. Animal research supports the use of sealing end-to-end esophageal anastomosis with CA or FG, however this finding is based on a single rabbit study. Two RCT's were included, which focused only on specific clinical problems (atresia and colon interposition in the infant), reporting positive results. No studies were found on adults or on oncological esophagectomies. Although the included RCT's showed that the use of FG reduced AL, conclusions may only be drawn for this small subset of clinical problems, revealing that sealing of esophageal anastomosis with FG may be helpful in esophageal atresia or colonic interposition in infants. Future research should focus on the use of FG sealing after (oncologic) esophagectomies or colon interposition in adults.

Gastric/bariatric: no studies evaluating the use of tissue adhesives with regard to gastrectomy were found. In bariatric surgery (laparoscopic) Roux-en-Y gastric bypass ((L)RYGB) staple line reinforcements and tissue adhesives are increasingly being used to protect from staple line dehiscence and bleeding [60]. RYGB dehiscence rates vary from 0.7% to 6% [13-14, 61-62]. In two large pig studies FG was used to cover a defect in the gastro-jejunal anastomosis and resulted in a dramatic decrease of AL. These pig studies were well performed and provide evidence of the positive effects of FG sealing in this field. Bioglue also proved useful in a single ex vivo study, however this was not repeated in an in vivo model. CA was evaluated in a single rat study, which deemed it non-inferior to conventional techniques. Of the nine included clinical studies on LRYGB, clinical evidence is derived from one large RCT that evaluated the effect of FG sealing. The authors of this study reported more AL in the control group, however this difference was not significant. They did report benefits of FG use with regard to the prevention of several early complications. This multicentre prospective trial was methodologically sound, however sample size was not sufficient to provide firm conclusions on statistical differences between endpoints. Furthermore, three large prospective cohorts provide inconclusive results on the use of FG sealing after RYGB, two reporting positive results on AL rate and the other reporting no differences when FG was applied. Interestingly the latter study also reported that FG was associated with an increased clinical inflammatory response mimicking AL, a finding not seen in the other studies. Several smaller series also found that FG sealing prevents AL. One case control study showed positive results on the use of FG, however in this study one surgeon performed all the FG operations and two other surgeons performed the controls. One pilot study on 10 patients deemed the use of PRP helpful, however it is questionable how much statistical power can be derived. Thus, most of the included studies

show that FG may protect the staple line from AL after LRYGB. However, the only RCT did not verify this but this may be due to the lack of statistical power. A new multicentre, prospective RCT may provide the answer.

Pancreatic: pancreatic leakage and subsequent fistula formation occurs in 5% to 25% of patients undergoing pancreatoco-digestive anastomosis, depending on etiology and definition used [63]. PEG use was promising in one well-performed pig study; however no clinical studies have been performed to assess PEG in humans. This may be a target for future research. One well-performed RCT concluded that the use of FG sealing of the pancreatoco-jejunal anastomosis did not provide any benefits. In this study only high-risk pancreatoco-jejunal anastomoses were included, which was judged by the surgeon. Although a higher rate of AL (postoperative fistula) was observed in the control group (24% vs 14%) there were no statistical differences between this or any other complications. A small prospective study on a similar 'high-risk' patient population reported that FG did reduce the AL rate to 0%. This was, however, a very small study which cannot provide as much evidence as the RCT. These studies have only focussed on patients known to have a high risk for AL; these patients had a soft texture gland. Considering the working mechanism of a tissue adhesive, that also relies on the texture of its substrate for a sufficient bond, it can be imagined that these high-risk patients may be less susceptible to a strong FG bond at the anastomotic site. Future research should focus on a broader spectrum of patients, not only high-risk patients, to test the hypothesis that FG can adhere better to a normal texture gland. Furthermore, a small retrospective case-control study showed more pancreatic fistulas when BioGlue was used around the pancreatic anastomosis. It seems that FG sealing does not provide benefits for patients with high-risk pancreatoco-enteric anastomosis. Research may, however, also focus on other subsets of patients in this field.

Small bowel: small bowel anastomosis is primarily performed after resection for inflammatory disease, after small bowel obstruction, abdominal trauma or as a part of bariatric surgery. In addition, another important indication for ileal anastomosis is closure of defunctioning loop ileostomy, which is associated with AL incidence of 3.0% [3]. Mostly experimental studies were found in this field. In three rat studies FG was used to seal a primary anastomosis either after formation of an intestinal fistula or in a leaking anastomosis model. It was observed that FG glue protects the anastomosis in both demanding environments, with effects apparent after day 5. Interestingly, it was reported that combining FG with growth hormone may enhance its protective effects. This may be a path

for future research. FG was also used in a pig model, showing that FG may be used to seal perforated bowel after an abdominal gunshot wound. Due to ease of application and speed, tissue adhesives may indeed be useful after major trauma or even in a battlefield setting, and future research should focus on this use. Furthermore, PEG was also used in a single rabbit study of insufficient anastomosis and was reported to improve wound healing. More studies should focus on PEG in this field to verify these findings. CA sealing proved positive in two large rat studies, both in ischemia/reperfusion as in a leaking anastomosis model. Only one human study was included, a small prospective study in which septic patients undergoing ileal resection were sealed with FG. Patients were also given human derived growth hormone and a relatively low rate of AL (8.3%) was seen. Although well performed, this study does not provide substantial clinical evidence and may be a target for future research, aiming at a large RCT. All included studies in this field showed positive results when tissue adhesives were used to protect the ileal anastomosis. Despite these promising results more clinical, especially level 1, studies are needed before these techniques can be recommended for clinical practice.

Colorectal: in colorectal surgery, the reported incidence of anastomotic leakage ranges from 5-25% with a mortality rate of up to 32% [2, 64]. This may be due to the anatomical positioning of the colorectum, which is partly located extraperitoneally, not being accessible to the sealing function of the greater omentum. Furthermore, ultralow anastomoses may be affected by their lack of perfusion, due to minimal and fragile arterial supply, and their subjection to high intraluminal pressures and peristaltic forces [65]. Along with other known risk factors such as male gender, obesity, smoking and anastomosis under tension, the colorectum is a fragile and precarious location for the creation of an anastomosis [2]. Until now, research has almost exclusively been performed in animals, and there is little variation in studied tissue adhesives. Of the numerous experimental studies, most were small rat studies either focusing on the use of FG or CA. Interestingly, all nine rat studies on FG showed decrease of AL. In these studies only Tisseel/Tissucol FG was used, and mostly sealing of a sufficient anastomosis was made. There were some notable differences between these studies, as some models consisted of a 1 or 2 cm resection and others only transection and anastomosis. Also, there were differences in sutures and numbers of sutures used, and in one study a sutureless anastomosis was created using FG which was not inferior to the control. CA sealing was also evaluated by experimental studies. Again, in six of the seven studies rat models were used and in none of the rat studies positive effects of CA use were

reported. In the only pig study included, two CA adhesives were compared, and a decrease in AL was only seen when Glubran 2 glue was used. One clinical study was included, a prospective study on 223 patients undergoing laparoscopic rectal surgery. The authors used two types of FG, with no systematic randomization for type of FG. Also, there was a large variation in the amount of FG used, varying from 1 to 2 mL, and the exact application technique was not described. Using little amounts of FG, laparoscopically applied through a catheter seems difficult, especially with regard to the posterior side of the anastomosis. This study found no benefit in the use of FG. A new level 1 study might shed light on the use of FG in this field. Concluding, the future of research in this field will entail a wider palette of tissue adhesives, and more uniformity in animal testing methodology. Only thereafter clinical studies may provide enough evidence for clinical use.

The field of tissue adhesives in surgery is relatively new and the adhesive market has changed substantially throughout the years. Due to improvements in surgical adhesive composition and characteristics, especially in the new millennium, we decided to only include studies that were published after 2000 in this review. More detailed information on the early period of adhesive research in GI surgery is addressed in several older reviews [5, 66].

Despite all the research that has been performed to date in the field of surgical adhesives it remains difficult to draw conclusions on the effects of the tested tissue adhesives on each level of GI anastomosis. The reason for this is that there is too much heterogeneity in experimental methods between research groups. Most authors use anastomotic bursting pressure (ABP) as a major endpoint, a test which in our opinion is useful as it reflects the strength of the intact anastomosis. Although popular, this test has however also been scrutinized and it has been said that ABP might not be correlated with the integrity of the anastomosis and clinical outcome [50, 67]. We have observed great differences in ABP test methods ranging from ABP on intact in-vivo colon with air insufflation, to the use of dyed saline on resected colon. Furthermore, when using a tissue adhesive it is imperative to provide details on its application; such as the amount used, layer thickness/width and the curing time. Only a minority of authors state the abovementioned parameters, which makes repetition of results difficult if not impossible. Also anastomotic technique should be further standardized to make results more comparable. Especially amount of sutures used for the sutured anastomosis vary greatly per animal model, and in the case of the sutureless (glued) anastomosis there were variations in the use of 'guide' sutures at the (anti)mesenteric edges. The most popular animal model for the creation of anastomosis is the rat. Within this model

there are great differences, with some authors ‘devitalizing’ the wound edges by selective devascularization or by crushing and others making a sufficient anastomosis, with variable amounts of sutures. Our recommendation would be to standardize methodology of this type of research, including the use of a standard animal model. FG and CA seem to be the most popular categories of tissue adhesives at the moment. Within these categories different formulations have produced contradicting results. In the case of CA the use of shorter chain lengths such as n-butyl-cyanoacrylate tend to implicate more tissue toxicity and tissue damage based on the degree of exothermic reaction. New CA’s are less histotoxic, and more flexible than older formulations. Differences between FG are seen in the use of antifibrinolytic agents (i.e. aprotinin), which has also been associated with adverse effects on (experimental) colonic healing as well as hypersensitivity reactions in humans [68-69]. We found no remarkable differences between outcomes of FG with/without aprotinin. For all levels of anastomosis we have seen that research has focused mostly on FG and CA. Clinical studies have almost exclusively been performed on FG, with the occasional exception of a biologically based tissue adhesive. It seems that surgeons are still wary of chemically based adhesives such as CA and PEG, despite positive reports from animal research. With the new generation of CA and other new adhesive formulations on the horizon, we may also see the first human applications.

In the future, we feel that research in this field should also provide a better perspective on the biomechanical mechanisms of adhesiveness for the different anastomotic locations. This may enable the development of tissue adhesives, custom made, for the various anatomical locations or, better yet, a ‘universal’ glue for use in various anastomotic locations. This will provide a better understanding of why certain tissue adhesives tend to be more effective than others, and may provide insight into the next steps of development of tissue adhesives for GI anastomosis.

CONCLUSION

The field of tissue adhesives is gaining ground in GI surgery. Despite years of research the ‘ideal’ tissue adhesive is yet to be found, however the benefits of using adhesives are becoming more apparent. The use of Fibrin Glue and Cyanoacrylate has been the main

focus of research for the sealing of GI anastomosis until now, especially in clinical research. Currently, it seems that FG may be an effective anastomotic sealant for specific types of esophageal and bariatric surgery; however, contrary to our hypothesis, recommendations for the general population are premature. Results for the sealing of pancreatic, ileal and colorectal anastomoses remain inconclusive and are mostly based on animal studies. Future research should concentrate on the evaluation of a wider palette of tissue adhesives, and more level 1 studies are needed to implement tissue adhesives on a larger scale. Current animal research on tissue adhesives may benefit from a more systematic approach, based on basic adhesiveness mechanisms and inventarisation of existing tissue adhesives. This interesting field is becoming increasingly popular in surgery, and this trend will continue in future research and in clinical practice.

REFERENCES

1. Bruce, J., et al., Systematic review of the definition and measurement of anastomotic leak after gastrointestinal surgery. *Br J Surg*, 2001. 88(9): p. 1157-68.
2. Kingham, T.P. and H.L. Pachter, Colonic anastomotic leak: risk factors, diagnosis, and treatment. *J Am Coll Surg*, 2009. 208(2): p. 269-78.
3. D'Haeninck, A., et al., Morbidity after closure of a defunctioning loop ileostomy. *Acta Chir Belg*, 2011. 111(3): p. 136-41.
4. Komen, N., et al., After-hours colorectal surgery: a risk factor for anastomotic leakage. *Int J Colorectal Dis*, 2009. 24(7): p. 789-95.
5. Reece, T.B., T.S. Maxey, and I.L. Kron, A prospectus on tissue adhesives. *Am J Surg*, 2001. 182(2 Suppl): p. 40S-44S.
6. Peppas, N.A., Surface, interfacial and molecular aspects of polymers bioadhesion on soft tissues. *Journal of Controlled Release*, 1985. 2: p. 257-275.
7. Hata, M., et al., Type A acute aortic dissection: immediate and mid-term results of emergency aortic replacement with the aid of gelatin resorcin formalin glue. *Ann Thorac Surg*, 2004. 78(3): p. 853-7; discussion 857.
8. Gosain, A.K., V.B. Lyon, and D.C. Plastic Surgery Educational Foundation, The current status of tissue glues: part II. For adhesion of soft tissues. *Plast Reconstr Surg*, 2002. 110(6): p. 1581-4.
9. Moher, D., et al., Preferred reporting items for systematic reviews and meta-analyses: the PRISMA statement. *J Clin Epidemiol*, 2009. 62(10): p. 1006-12.
10. Yurtcu, M., et al., The healing effects of tissue glues and healing agent locally applied on esophageal anastomoses. *Int J Pediatr Otorhinolaryngol*, 2010. 74(1): p. 43-6.
11. Upadhyaya, V.D., et al., Role of fibrin glue as a sealant to esophageal anastomosis in cases of congenital esophageal atresia with tracheoesophageal fistula. *World J Surg*, 2007. 31(12): p. 2412-2415.
12. Saldana-Cortes, J.A., et al., Role of fibrin glue in the prevention of cervical leakage and strictures after esophageal reconstruction of caustic injury. *World J Surg*, 2009. 33(5): p. 986-993.
13. Bonanomi, G., et al., Sealing effect of fibrin glue on the healing of gastrointestinal anastomoses: implications for the endoscopic treatment of leaks. *Surg Endosc*, 2004. 18(11): p. 1620-1624.
14. Nguyen, N.T., et al., The efficacy of fibrin sealant in prevention of anastomotic leak after laparoscopic gastric bypass. *J Surg Res*, 2004. 122(2): p. 218-224.
15. Weiss, M. and M. Haj, Gastrointestinal anastomosis with histoacryl glue in rats. *J Invest Surg*, 2001. 14(1): p. 13-9.
16. Nandakumar, G., et al., Surgical adhesive increases burst pressure and seals leaks in stapled gastrojejunostomy. *Surg Obes Relat Dis*, 2010. 6(5): p. 498-501.
17. Silecchia, G., et al., The use of fibrin sealant to prevent major complications following laparoscopic gastric bypass: results of a multicenter, randomized trial. *Surg Endosc*, 2008. 22(11): p. 2492-2497.
18. Liu, C.D., G.J. Glantz, and E.H. Livingston, Fibrin glue as a sealant for high-risk anastomosis in surgery for morbid obesity. *Obes Surg*, 2003. 13(1): p. 45-48.
19. Efthimiou, E., et al., Fibrin sealant associated with increased body temperature and leukocytosis after laparoscopic gastric bypass. *Surg Obes Relat Dis*, 2010. 6(1): p. 46-49.
20. Sapala, J.A., M.H. Wood, and M.P. Schuhknecht, Anastomotic leak prophylaxis using a vapor-heated fibrin sealant: report on 738 gastric bypass patients. *Obes Surg*, 2004. 14(1): p. 35-42.

21. Cottam, D., et al., Laparoscopic sleeve gastrectomy as an initial weight-loss procedure for high-risk patients with morbid obesity. *Surg Endosc*, 2006. 20(6): p. 859-63.
22. Raquel, S.S., et al., Staple line reinforcement with tissue glue sealant (Tissucol(registered trademark)) during the learning curve of laparoscopic bariatric surgery. *Obesity Surgery*, 2009. 19(8): p. 1045.
23. Fullum, T.M., K.J. Aluka, and P.L. Turner, Decreasing anastomotic and staple line leaks after laparoscopic Roux-en-Y gastric bypass. *Surg Endosc*, 2009. 23(6): p. 1403-1408.
24. Brady, C., et al., Use of autologous platelet gel in bariatric surgery. *Journal of Extra-Corporeal Technology*, 2006. 38(2): p. 161-164.
25. Argyra, E., et al., Sutureless pancreatojejunal anastomosis using an absorbable sealant: evaluation in a pig model. *J Surg Res*, 2009. 153(2): p. 282-286.
26. Lillemoe, K.D., et al., Does fibrin glue sealant decrease the rate of pancreatic fistula after pancreaticoduodenectomy? Results of a prospective randomized trial. *J Gastrointest Surg*, 2004. 8(7): p. 766-772; discussion 772-764.
27. Oida, T., et al., Toward zero pancreatic leakage after pancreaticoduodenectomy for soft pancreas in low-volume pancreatic surgery centers. *Hepatogastroenterology*, 2009. 56(91-92): p. 886-890.
28. Fisher, W.E., et al., Effect of BioGlue on the incidence of pancreatic fistula following pancreas resection. *J Gastrointest Surg*, 2008. 12(5): p. 882-890.
29. Li, Y., et al., Combination of fibrin glue with growth hormone augments healing of incomplete intestinal anastomoses in a rat model of intra-abdominal sepsis: a dynamic study. *J Invest Surg*, 2007. 20(5): p. 301-306.
30. Wang, P., et al., Effect of the combination of fibrin glue and growth hormone on intestinal anastomoses in a pig model of traumatic shock associated with peritonitis. *World J Surg*, 2009. 33(3): p. 567-576.
31. Park, W., et al., Comparison of two fibrin glues in anastomoses and skin closure. *J Vet Med A Physiol Pathol Clin Med*, 2002. 49(7): p. 385-389.
32. Elemen, L., et al., Is the use of cyanoacrylate in intestinal anastomosis a good and reliable alternative? *J Pediatr Surg*, 2009. 44(3): p. 581-586.
33. Ensari, C.O., et al., Effects of N-butyl-2-cyanoacrylate on high-level jejunojunostomy. *Eur Surg Res*, 2010. 44(1): p. 13-16.
34. Sweeney, T., et al., Intestinal anastomoses detected with a photopolymerized hydrogel. *Surgery*, 2002. 131(2): p. 185-189.
35. Wang, X., et al., Fibrin sealant prevents gastrointestinal anastomosis dehiscence in intra-abdominal sepsis. *Int Surg*, 2007. 92(1): p. 27-31.
36. Akgun, A., et al., Early effects of fibrin sealant on colonic anastomosis in rats: an experimental and case-control study. *Tech Coloproctol*, 2006. 10(3): p. 208-214.
37. Girgin, S., et al., Effect of a 50-Hz sinusoidal electromagnetic field on the integrity of experimental colonic anastomoses covered with fibrin glue. *Advances in Clinical and Experimental Medicine*, 2009. 18(1): p. 13-18.
38. Giuratrabocchetta, S., et al., Protection of intestinal anastomosis with biological glues: an experimental randomized controlled trial. *Tech Coloproctol*, 2011.
39. Kanellos, I., et al., Effects of the use of fibrin glue around the colonic anastomosis of the rat. *Tech Coloproctol*, 2003. 7(2): p. 82-84.
40. Kanellos, I., et al., Healing of colon anastomoses covered with fibrin glue after immediate postoperative intraperitoneal administration of 5-fluorouracil. *Dis Colon Rectum*, 2004. 47(4): p. 510-515.
41. Kanellos, D., et al., Effect of 5-fluorouracil plus interferon on the integrity of colonic anastomoses covering with fibrin glue. *World J Surg*, 2007. 31(1): p. 186-191.
42. Kanellos, I., et al., The healing of colon anastomosis covered with fibrin glue after early postoperative intraperitoneal chemotherapy. *Tech Coloproctol*, 2006. 10(2): p. 115-120.
43. Subhas, G., et al., Topical gentamicin does not provide any additional anastomotic strength when combined

with fibrin glue. *Am J Surg*, 2011. 201(3): p. 339-343.

44. Capitan Morales, L.C., et al., Experimental study of sutureless colorectal anastomosis. *Hepatogastroenterology*, 2000. 47(35): p. 1284-1290.

45. Tingstedt, B., et al., Effect of bioactive polypeptides on leaking large bowel anastomosis and intestines in the rat. *J Invest Surg*, 2007. 20(4): p. 229-235.

46. Bae, K.B., et al., Cyanoacrylate for colonic anastomosis; is it safe? *Int J Colorectal Dis*, 2010. 25(5): p. 601-606.

47. Kanellos, I., et al., Sutureless colonic anastomosis in the rat: a randomized controlled study. *Tech Coloproctol*, 2002. 6(3): p. 143-146.

48. Irkorucu, O., et al., Effect of 2-octyl-cyanoacrylate on ischemic anastomosis of the left colon. *J Invest Surg*, 2009. 22(3): p. 188-194.

49. Ozmen, M.M., et al., Histoacryl blue versus sutured left colonic anastomosis: experimental study. *ANZ J Surg*, 2004. 74(12): p. 1107-1100.

50. Kayaoglu, H.A., et al., Effect of n-butyl-2-cyanoacrylate on high-risk colonic anastomoses. *Kaohsiung J Med Sci*, 2009. 25(4): p. 177-183.

51. Nursal, T.Z., et al., The effect of tissue adhesive, octyl-cyanoacrylate, on the healing of experimental high-risk and normal colonic anastomoses. *Am J Surg*, 2004. 187(1): p. 28-32.

52. Paral, J., et al., Suture-free anastomosis of the colon experimental comparison of two cyanoacrylate adhesives. *J Gastrointest Surg*, 2011. 15(3): p. 451-459.

53. Ustek, S., et al., Effect of povidone-iodine liposome hydrogel on colonic anastomosis. *Eur Surg Res*, 2005. 37(4): p. 242-245.

54. Yol, S., et al., Effects of platelet rich plasma on colonic anastomosis. *J Surg Res*, 2008. 146(2): p. 190-194.

55. Huh, J.W., H.R. Kim, and Y.J. Kim, Anastomotic leakage after laparoscopic resection of rectal cancer: the impact of fibrin glue. *Am J Surg*, 2010. 199(4): p. 435-441.

56. Murrell, Z.A. and M.J. Stamos, Reoperation for anastomotic failure. *Clin Colon Rectal Surg*, 2006. 19(4): p.

213-6.

57. Nandakumar, G., S.L. Stein, and F. Michelassi, Anastomoses of the lower gastrointestinal tract. *Nat Rev Gastroenterol Hepatol*, 2009. 6(12): p. 709-16.

58. Kondra, J., et al., A change in clinical practice: a partially stapled cervical esophagogastric anastomosis reduces morbidity and improves functional outcome after esophagectomy for cancer. *Dis Esophagus*, 2008. 21(5): p. 422-9.

59. Cooke, D.T., et al., Analysis of cervical esophagogastric anastomotic leaks after transhiatal esophagectomy: risk factors, presentation, and detection. *Ann Thorac Surg*, 2009. 88(1): p. 177-84; discussion 184-5.

60. Chen, B., et al., Reinforcement does not necessarily reduce the rate of staple line leaks after sleeve gastrectomy. A review of the literature and clinical experiences. *Obes Surg*, 2009. 19(2): p. 166-72.

61. Schauer, P.R., et al., Outcomes after laparoscopic Roux-en-Y gastric bypass for morbid obesity. *Ann Surg*, 2000. 232(4): p. 515-29.

62. DeMaria, E.J., et al., Results of 281 consecutive total laparoscopic Roux-en-Y gastric bypasses to treat morbid obesity. *Ann Surg*, 2002. 235(5): p. 640-5; discussion 645-7.

63. Fischer, A., et al., Endoscopic management of pancreatic fistulas secondary to intraabdominal operation. *Surg Endosc*, 2004. 18(4): p. 706-8.

64. Choi, H.K., W.L. Law, and J.W. Ho, Leakage after resection and intraperitoneal anastomosis for colorectal malignancy: analysis of risk factors. *Dis Colon Rectum*, 2006. 49(11): p. 1719-25.

65. Komen, N., et al., High tie versus low tie in rectal surgery: comparison of anastomotic perfusion. *Int J Colorectal Dis*, 2011. 26(8): p. 1075-8.

66. Nordkild, P., A. Hjortrup, and J. Kjaergaard, Tissue adhesives and intestinal anastomosis. *Ann Chir Gynaecol*, 1986. 75(4): p. 205-8.

67. Kirkegaard, P., et al., Experimental nonsuture colonic anastomoses. *Am J Surg*, 1980. 139(2): p. 233-6.

68. Beierlein, W., et al., Forty years of clinical aprotinin use: a review of 124 hypersensitivity reactions. *Ann Thorac Surg*, 2005. 79(2): p. 741-8.
69. Young, H.L. and M.H. Wheeler, Effect of intravenous aprotinin (Trasylol) on the healing of experimental colonic anastomoses in the rabbit. *Eur Surg Res*, 1983. 15(1): p. 18-23.
70. Yurtcu, M., et al., The healing effects of tissue glues and healing agent locally applied on esophageal anastomoses. *Int J Pediatr Otorhinolaryngol*, 2010. 74(1): p. 43-46.
71. Weiss, M. and M. Haj, Gastrointestinal anastomosis with histoacryl glue in rats. *J Invest Surg*, 2001. 14(1): p. 13-19.
72. Silecchia, G., et al., Clinical evaluation of fibrin glue in the prevention of anastomotic leak and internal hernia after laparoscopic gastric bypass: preliminary results of a prospective, randomized multicenter trial. *Obes Surg*, 2006. 16(2): p. 125-131.
73. Li, Y., et al., Effect of the combination of fibrin glue and growth hormone on incomplete intestinal anastomoses in a rat model of intra-abdominal sepsis. *J Surg Res*, 2006. 131(1): p. 111-117.

FIGURES/ TABLES

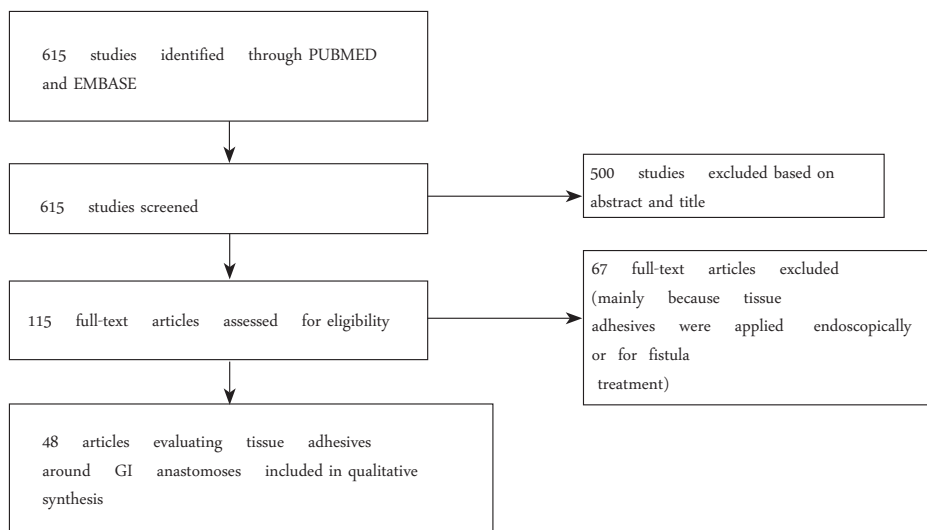

Figure 1: Study selection for relevant articles

Table 1: Available commercial tissue adhesives per category

Fibrin glues:

Manufacturer	Trade name	Composition
Ethicon (J&J, USA)	CROSSEEL (USA)/ Quixil (EU)	Fibrin glue, no aprotinin, with transhexamic acid
Baxter (USA)	Tisseel (USA)/ TissuCol (EU)	Fibrin glue, with aprotinin
Angiotech (USA)	Hemaseel APR	Fibrin glue, with aprotinin
CSL Surgery (USA)	Beriplast	Fibrin glue, with aprotinin
Guanzhou Bio Seal co (CHI)	Guanzhou Bio Seal	Fibrin glue, no aprotinin
Green cross P.D. co. (KOR)	Greenplast	Fibrin glue, with aprotinin

Cyanoacrylate glues:

Manufacturer	Trade name	Composition
Ethicon (J&J; USA)	Dermabond	2-octyl-cyanoacrylate
	Omnex	2-octyl-cyanoacrylate
B.Braun (GER)	Histoacryl Blue	n-butyl-2-cyanoacrylate
GEM Italia (IT)	Glubran 2	n-butyl-2-cyanoacrylate and methacryloxysulfolane
Adhezion medical (USA)	Surgiseal	2-octyl-cyanoacrylate
GluStitch Inc. (CAN)	GluSeal	2-octyl-cyanoacrylate
Henkel (GER)	Pattex	Ethyl-2-cyanoacrylate

Polyethylene glycol:

Manufacturer	Trade name	Composition
Covidien (FR)	Duraseal	Polyethylene glycol, trisiline amine and blue dye
	Duraseal Xact	Idem, with N-hydroxy succinimide
Baxter (USA)	Coseal	Polyethylene glycol, hydrogen chloride and sodium phosphate-sodium carbonate
Genzyme Biosurgery Inc. (USA)	Focalseal-L	Polyethylene glycol, acrylate-capped poly-L-lactide and polytrimethylene carbonate.

Other categories:

Manufacturer	Trade name	Composition
Cardial SA (FR)	GRF glue	Gelatin-resorcinol-formaldehyde glue
Geister GmbH (GER)	Gluetiss glue	Gelatin-resorcinol-glyoxal glue
Biomet (USA)	GPS system for PRP glue	Platelet rich plasma (PRP)
Cryolife (USA)	BioGlue	Glutaraldehyde-albumin glue
Mundipharma GmbH, (GER)	Polydione-liposome (PVP-1)	Elemental iodine and polyvinylpyrrolidone (polydione) + liposome hydrogel
Cohera medical Inc. (USA)	TissuGlu	Urethane adhesive (lysine derived)

*not marketed for medical use

Table 2: Synopsis of results: esophageal anastomosis

LOE*	Author / year	Model	N	Tissue adhesive	Methods	Outcome
-	Yurtcu / 2010	Rabbit	24	CA (Glubran 2) FG (Beriplast)	Esophageal anastomosis	+
1b	Upadhyaya / 2007 [11]	Clinical (RCT)	52	FG (Tisseel)	Esophageal anastomosis	+
3b	Saldana / 2009[12]	Clinical	38	FG (Quixil)	Colonic interposition	+

*LOE: level of evidence

Table 3: Synopsis of results: gastric/bariatric anastomosis

LOE	Author/ year	Model	N	Tissue adhesive	Methods	Outcome
-	Bonanomi / 2004 [13]	Pig	20	FG (Tisseel)	Gastrojejunal anastomosis	+
-	Nguyen / 2004 a*[14]	Pig	16	FG (Tisseel)	Gastrojejunal anastomosis	+
-	Weiss / 2011 [71]	Rat	64	CA (Histoacryl Blue)	Gastrojejunal anastomosis	+/-
-	Nandakumar / 2010 [16]	Pig	30	BioGlue	Gastrojejunal anastomosis	+
1b	Silecchia / 2006+2008 [17,72]	Clinical (RCT)	340	FG (Tisseel)	LRYGB**	+/-
3b	Liu / 2003 [18]	Clinical	480	FG (Tisseel)	RYGB	+
2b	Sapala / 2004 [20]	Clinical	738	FG (Hemaseel APR, Tisseel)	Gastrojejunal anastomosis	+
2b	Cottam / 2006 [21]	Clinical	126	FG (Tisseel)	Laparoscopic sleeve gastrectomy	+
2b	Raquel / 2009 [22]	Clinical	100	FG (Tissuocol)	LRYGB// Laparoscopic sleeve gastrectomy	+
2b	Fullum / 2009 [23]	Clinical	760	FG (not specified)	LRYGB	+
2b	Nguyen / 2004 b*[14]	Clinical	66	FG (Tisseel)	Gastrojejunal anastomosis	+
2b	Efthimiou / 2010 [19]	Clinical	474	FG (Tisseel)	LRYGP	-
4	Brady / 2006 [24]	Clinical	10	APG (autologous platelet gel)	Gastrojejunal anastomosis	+

*2 part publication, discussed separately.

** (L)RYGB: (laparoscopic) Roux-en-Y gastric bypass

Table 4: Synopsis of results: pancreatic anastomosis

LOE*	Author/ year	Model	N	Tissue adhesive	Methods	Outcome
-	Argyra / 2009 [25]	Pig	10	PEG (Focalseal L)	Pancreaticojejunal anastomosis	+
1b	Lillemoe / 2004 [26]	Clinical (RCT)	125	FG (Not specified)	Pancreatico-duodenectomy	+/-
4	Oida / 2009 [27]	Clinical	26	FG (not specified)	Pancreatico-duodenectomy	+
3b	Fisher / 2008 [28]	Clinical	64	BioGlue	Pancreatectomy	-

Table 5: Synopsis of results: small intestinal anastomosis

LOE*	Author/ year	Model	N	Tissue adhesive	Methods	Outcome
-	Li / 2006 [73]	Rat	360	FG (Guanzhou bio seal)	Ileal anastomosis	+
-	Li / 2007 [29]	Rat	300	FG (Guanzhou bio seal)	Ileal anastomosis;Incomplete	+
-	Wang / 2009 [30]	Pig	63	FG (Guanzhou bio seal)	Ileal anastomosis; gunshot wound model	+
-	Park / 2002 [31]	Dog	18	FG(Greenplast, Tisseel)	Jejunal anastomosis	+
-	Elemen / 2008 [32]	Rat	96	CA (Pattex)	Ileal anastomosis	+
-	Ensäri / 2010 [33]	Rat	40	CA (Glubran 2)	Jejunal anastomosis	+
-	Sweeney / 2002 [34]	Rabbit	24	PEG (Focalseal)	Ileal anastomosis	+
2b	Wang / 2007[35]	Clinical	48	FG (Guanzhou bio seal)	Ileal anastomosis	+

Table 6: Synopsis of results: colorectal anastomosis

LOE*	Author/ year	Model	N	Tissue adhesive	Colonic anastomosis	+
-	Akgun / 2006 [36]	Rat	38	FG (Tisseel)	Colonic anastomosis	+
-	Capitan Morales / 2000 [44]	Rat	105	FG (Tisseel)	Colonic anastomosis	+
-	Girgin / 2009 [37]	Rat	28	FG (Tisseel)	Colonic anastomosis	+
-	Subhas / 2011 [43]	Rat	70	FG (Tisseel)	Colonic anastomosis	+
-	Kanellos / 2003 [39]	Rat	36	FG (TissuCol)	Colonic anastomosis	+
-	Kanellos / 2004 [40]	Rat	64	FG (TissuCol)	Colonic anastomosis	+
-	Kanellos / 2007 [41]	Rat	60	FG (TissuCol)	Colonic anastomosis	+
-	Kanellos / 2006 [42]	Rat	60	FG (TissuCol)	Colonic anastomosis	+
-	Giuratrabocchetta / 2011 [38]	Rabbit	10	FG(TissuCol) PEG (CoSeal)	Colonic anastomosis	+/-
-	Tingstedt / 2007 [45]	Rat	132	FG (Tisseel)	Iliocolic anastomosis	-
-	Bae / 2010 [46]	Rat	60	CA (Histoacryl Blue)	Colonic anastomosis	-
-	Irkorucu / 2009 [48]	Rat	40	CA (GluSeal)	Colonic anastomosis	-
-	Kanellos / 2002 [47]	Rat	40	CA (Dermabond)	Colonic anastomosis	+/-
-	Kayaoglu / 2009 [50]	Rat	80	CA (Glubran 2)	Colonic anastomosis	-
-	Nursal / 2004 [51]	Rat	90	CA (Dermabond)	Colonic anastomosis	-
-	Ozmen / 2004 [49]	Rat	40	CA (Histoacryl Blue)	Colonic anastomosis	-
-	Paral / 2011 [52]	Pig	12	CA (Glubran 2) CA (Dermabond)	Colonic anastomosis	+ (Glubran2)
-	Ustek / 2005 [53]	Rat	70	Povidone-liposome (PVP-I)	Colonic anastomosis	+
-	Yol / 2008 [54]	Rat	30	BioGlue PRP (Autologous)	Colonic anastomosis	+ (PRP)
2b	Huh / 2010 [55]	Clinical	223	FG (TissuCol, Greenplast)	Rectal cancer surgery	+/-

Chapter 5:

Critical Analysis of Cyanoacrylate in Intestinal and Colorectal Anastomosis

Z. Wu, G.S.A. Boersema, K.A. Vakalopoulos, F. Daams, C.L. Sparreboom, G-J. Kleinrensink, J. Jeekel, J.F. Lange

Journal of Biomedical Materials Research Part B: Applied Biomaterials,
2014 (published)

ABSTRACT

Background: Although cyanoacrylate glue (CA) has been widely used in various kinds of medical applications, its application in gastrointestinal anastomosis remains limited, and outcomes of experimental studies have not been satisfactory. This systematic review summarizes research regarding CA application in intestinal and colorectal anastomosis, and correlates methodological aspects to experimental outcomes.

Methods: A systematic literature search was performed using Medline, Embase, Cochrane and Web-of-Science libraries. Articles were selected when CA was applied to intestinal or colorectal anastomoses. Included articles were categorized according to CA molecular structure; the method details in each study were extracted and analyzed.

Results: Twenty-two articles were included. More than half of the inclusions reported positive outcomes (7 articles) or neutral outcomes (8 articles). Analysis of the methods revealed that methodological details such as CA dosage, time of polymerization are not

consistently reported. Porcine studies, inverted anastomosis, and n-butyl-cyanoacrylate studies showed more positive outcomes; everted anastomosis, and oversized sutures may negatively influence the outcomes.

Conclusions: Due to the positive outcome from the porcine studies, application of CA in GI anastomosis still seems promising. To achieve a better consistency, more methodological details need to be provided in future studies. Optimizing the dosage of CA, choice of animal model, inverted anastomosis construction, and other method details may improve intestinal and colorectal anastomoses with CA application in future studies.

INTRODUCTION

Cyanoacrylate (CA) was invented more than 60 years ago for industrial applications [1, 2]. Famous for its strong adhesiveness, various commercial names such as “crazy glue” or “instant glue” are well known in daily life. Moreover, the strong adhesiveness of CA also made it an ideal candidate for replacement of conventional sutures in medical use, such as wound closure. In addition to a strong bond, a fully and evenly sealed anastomosis can be created with CA, avoiding excessive tissue approximation that can induce disturbances in the microcirculation [3, 4]. In 1998, the Food and Drug Administration (FDA) approved Dermabond (2-octyl-cyanoacrylate) for topical skin wound closure [5], which was the first FDA approved CA for medical use. Ever since then, more and more medical-use CA have appeared on the market for different indications [6, 7].

Except for skin wounds, the gastrointestinal anastomosis is another important type of wound closure. However, the use of CA in this field is still limited, and no clearly documented clinical attempts have been made so far. Though substantial experimental efforts have been made, the results of animal studies have not yet been encouraging. Some experimental studies reported anastomoses could be well constructed with CA [8, 9]; while others reported a mortality rate as high as 30-40% [10, 11]. Besides large variations in results, inconsistencies with regard to the methodology were also noticed in those experiments. As it has been demonstrated that the anastomotic technique used in clinical gastrointestinal surgery influences the outcomes, we hypothesized that the inconsistent

results of experimental studies are partly due to differences in their methods. Thus, the purpose of this systematic review is to summarize the experimental studies regarding CA application in intestinal and colorectal anastomosis, correlating the methodological details to the experimental outcomes.

METHODS

Search methods

This systematic review was performed according to the PRISMA (Preferred Items for Reporting of Systematic Reviews and Meta-Analyses) guidelines [12]. The systematic literature search was performed on the 5th of November 2012. The systematic search of literature was performed using the databases of Medline, Embase, Cochrane and Web-of-Science libraries. The same search strategy was used in all the databases. The search strategy encompasses the following:

(cyanoacrylate/de OR 'cyanoacrylate derivative'/de OR 'cyanoacrylic acid octyl ester'/de OR enbucrilate/de OR bucrilate/de OR 'poly (ethyl 2 cyanoacrylate)'/de OR (cyanoacryl* OR 'cyano acrylate' OR 'cyanoacrylic acid' OR 'octylcyano acrylate' OR enbucrilate* OR bucrilate* OR enbucrylate* OR bucrylate* OR butylcyanoacryl* OR fimomed OR histacryl OR histoacryl OR sicomet OR isobutylcyanoacrylat* OR ocrilate OR ocrilate OR octylcyanoacrylat* OR dermabond OR omnex OR glubran OR surgiseal OR floraseal OR 'derma flex qs' OR gluseal OR octyseal OR wormglu OR periacryl OR indermil OR liquiand OR xion):ab,ti) AND ('gastrointestinal surgery'/exp OR (('gastrointestinal tract'/exp OR 'digestive system'/exp) AND (surgery/exp OR (surg* OR operat* OR preoperat* OR postoperat* OR perioperat* OR intraoperat*):ab,ti)) OR (((gastr* OR digestiv* OR intestin* OR anal OR anus OR anorect* OR rect* OR bariatr* OR pancrea* OR stomach* OR antireflux* OR colon* OR colorect* OR bowel* OR duoden* OR esophag* OR oesophag*) NEAR/3 (surg* OR operat* OR postoperat* OR preoperat* OR perioperat* OR intraoperat* OR anastom* OR suture* OR adhesi* OR glue* OR sealant* OR hemosta* OR coat* OR lesion* OR wound* OR dehisc* OR disattach* OR attach*)) OR vagotom* OR colectom* OR gastrostom* OR stoma* OR appendectom*):ab,ti)

Study selection

Two independent researchers (Z.W. and G.B.) screened all the articles (the title and the abstract) in a standardized manner. Articles were included only if the CA glue was applied in an intestinal or colorectal anastomosis. The search was restricted to publications in English. Presentations, reviews and letters to editor were not included. All references from the selected articles were screened for further possible inclusions.

Data extraction

For all selected studies, a standard data extraction form was filled in, and the following data were extracted: year of publication, first author, subject (animal species), number of animals, glue (chemical name), glue (commercial name), usage (CA sutureless anastomosis / sealant), dosage, curing time, anastomotic material (additional material to create the anastomosis other than CA), suture material (chemical component), suture size, suturing technique, GI level, and outcome (positive / negative, judged according to conclusions of the articles).

RESULTS

A total number of 962 articles were found, from which 22 studies were included for final data analysis (Figure 1). Among these, seven articles had positive outcomes; eight had neutral outcomes; the others had negative outcomes. As is listed in Table 1, CA with different molecular structures produced by different manufacturers were used and tested. The included articles were divided according to the chemical structure of the CA used, and their chemical names (commercial names if applicable) were listed. Further subdivisions were made according to the use of CA with regard to anastomosis (sutureless anastomosis or sealant).

Methyl-cyanoacrylate (MCA)

Four studies were included that report the use of MCA [2, 10, 11, 13]. A sutureless

anastomosis was created in all of them, and none of these studies had positive outcomes (Table 2).

In 1962, O'Neill et al. used MCA (Eastman 910) to create a sutureless anastomosis in canines' small intestine or colon. In this model, a clamp was used to construct an everted anastomosis [11]. They found that most of the intestinal anastomoses (11 / 12) were satisfactory and no death occurred, but 28.6% (4 / 14) of canines died when CA anastomoses were created in the colon [11]. A similar clamp was also used by Weilbaecher et al., who performed the intestinal anastomosis with a greater number of canines. Mortality rate as high as 34% (34/101), and no advantage of MCA were found when compared with conventional suture methods [10]. A high mortality rate of 22% (8 / 35) was also found when Gennaro et al. used an intraluminal gelatin stent to create a colonic MCA anastomosis in a rat model [2]. Different from those experiments, Linn et al. reported a canine study [13], in which no anastomosis-related mortality occurred. Anastomoses with MCA had less inflammation than the conventional group, but stricture occurred in 40% of the anastomoses when a new invagination technique to construct the MCA anastomoses was used [13].

Ethyl-cyanoacrylate (ECA)

Only one study used ECA to create the CA sutureless anastomosis [3], and no study used MCA as an anastomotic sealant (Table 2).

In 2009, Elemen et al. used ECA (Pattex) to construct end-to-end, side-to-side, or side-to-end intestinal anastomoses in a rat model. No deaths occurred during follow up, and no differences in bursting pressure were found between the CA anastomosis and sutured anastomosis, while higher hydroxyproline levels (a parameter of anastomotic wound healing) and shorter operating time were found in the CA groups [3].

N-butyl-cyanoacrylate (NBCA)

Nine studies regarding NBCA were included [8, 9, 14-20] (Table 2). Among these, three studies focused on the sutureless anastomosis [8, 16, 17], three studies looked into NBCA sealant [9, 18, 20], and the other three tested both applications [14, 15, 19]. In the NBCA studies, all four large animal studies had positive results [8, 9, 14, 15], while of the other five rat studies, only one had positive outcomes [20].

Matsumoto et al. reported a comparison between CA in different molecular structures

(N-butyl-, Amyl-, Heptyl-cyanoacrylate) in a canine model of intestinal anastomosis. Only NBCA showed good wound healing without stenosis after four or twelve weeks [21]. Another comparison between NBCA (Glubran 2) and OCA (Dermabond) was performed in a porcine model [8]. The CA sutureless anastomoses were constructed in the colorectum with a modified stapling device, in which all the staples were taken out in advance. All the NBCA anastomoses were satisfactory, while two leakages occurred in the OCA group; NBCA was also superior to OCA regarding to the adhesion and stenosis severity [8]. Tebala et al. also tested NBCA with different suturing techniques in a porcine model [15]. They performed 11 different types of anastomosis. Good wound healing was observed in macroscopic, histological and angiographic examinations; foreign body reaction was even less in the sutureless anastomosis group than the sealant group [15]. Tebala et al. also created an insufficient anastomosis in a pig model by removing 1/5 of the sutures or staples from a normal anastomosis [9]. NBCA was then used to seal the defect. Anastomotic healing was sufficient, and no ileus occurred during the follow up [9].

Positive results of CA use were reported in a rat study by Ensari et al. [20]. In this study, the authors constructed an ischemic-reperfused intestinal anastomosis and used NBCA (Glubran 2) to reinforce it. Higher bursting pressures were found after the CA reinforcement with or without the initial ischemic intervention, while more adhesions were found in the CA groups [20]. Weiss et al. tested another NBCA (Histoacryl) and created gastrojejunal anastomoses in a rat model, comparing it with resorbable sutures. In this study, anastomotic healing regarding leakage rate, stricture, peritonitis, and mortality were similar between both groups. The only significant difference was a shorter operating time in the NBCA group [16]. Bae et al. tested the same glue in a rat model, in which they created NBCA (Histoacryl) reinforced anastomoses and the NBCA sutureless anastomoses in the rat colon. No leakage occurred in any of these groups, but more strictures, lower bursting pressure and more severe inflammation was found in the CA reinforced group and the CA sutureless group [19]. Similarly, a lower bursting pressure was also reported by Ozmen et al. in a CA sutureless colonic anastomosis with two holding sutures [17]. NBCA has also been tested in high-risk animal models. Kayaoglu et al. used 0.2 mL NBCA (Glubran 2) as sealant to reinforce the anastomosis in a fecally contaminated environment. Similar macroscopic wound healing and bursting pressure were found on day 3 and day 7 in both the CA group and the suture group; however, more inflammation and necrosis were found in the CA group [18].

Iso-butyl-cyanoacrylate (isoBCA)

Four studies regarding isoBCA were included [22-25], of which no study had positive results. Dating back to 1980, Kirkegaard et al. used isoBCA to create the sutureless anastomosis with a gelatin stent [25]. They found more stenosis and inflammation in the CA group, however these complications were significantly reduced when the CA anastomosis was covered with an omental tag [25].

High mortality was reported by all the other isoBCA studies. Stirling et al. used isoBCA to create the sutureless everted anastomosis, which resulted in a mortality rate of 27.0% (10/37) of canines [22]. In 1968, Hale et al. first used a rat model to compare the influence of isoBCA as sutureless anastomosis or as suture reinforcement. Twelve of 16 canines (75%) died in the sutureless anastomosis group, while conventional anastomoses or CA reinforced anastomoses were mostly satisfactory [23]. In 1971, Uroskie et al. used a canine model and performed two intestinal anastomoses in each animal, in which the distal anastomosis was sealed with isoBCA. Sixty percent (9/15) of the animals died during the follow-up due to anastomosis-related complications, mostly due to AL in the CA reinforced anastomoses [24].

2-octyl-cyanoacrylate (OCA)

Three studies on OCA were included [26-28]. None reported additional advantages in anastomotic healing when OCA was applied.

Kanellos et al. resected a segment of 1.0 cm in the rat transverse colon, and randomly chose OCA (Dermabond) or sutures to create the sutureless anastomosis. Similar leakage rates, bursting pressures and histological results were found between the CA and suture groups [26]. In 2009 Irkorucu et al. also used OCA (Gluseal) to seal or construct rat colonic anastomoses after inducing wound ischemia. Similar bursting pressure and hydroxyproline concentrations were found between groups, while more adhesions were found in the CA reinforced and the sutureless groups than the conventionally sutured groups [28]. However, in an ischemic anastomosis model by Nursal et al., the mechanical strength of the OCA (Dermabond) anastomosis was significantly lower on day 7 than the conventionally sutured groups; furthermore, a higher inflammatory response and necrosis were found in the OCA group [27].

Other

Galvao et al. used CA to assist a cuff apparatus to create an invaginated anastomosis on rat intestine. The chemical structure of the used CA was not described in this study, but satisfactory anastomoses were still found in both macroscopic and histological evaluations, the CA anastomosis also cost much less time. However, after one and three days, tissue lesions due to CA toxicity were observed [29].

METHOD DETAILS

As is shown in Table 2, methodological details of each included study were listed. These details mainly focused on the material and technique used for the anastomosis construction.

CA dosage and curing time

Of all 22 included studies, only four studies specified the amount of CA used in each anastomosis. One study used 1.0 mL CA to create the sutureless anastomosis in a pig model [8], obtaining positive outcomes. 0.5 mL and 0.2 mL CA were also used in three rat models for creating sutureless anastomoses or as an anastomotic sealant [18, 20, 27]. In these rat studies, only one reported positive conclusions [20].

Only eight studies listed the curing time after CA application, which varied from 10 seconds to 4 minutes [2, 10, 11, 16, 22, 24, 29].

Animal species

Three different animal species were used in the included studies. Most studies used animal was the rat (14 studies), and four of them had positive outcomes [3, 20, 25, 29]. Six canine studies were included. All of them were performed in the 1960's and 1970's, while only one had positive conclusions [14]. Only three porcine studies were included, all showing positive conclusions [8, 9, 15].

Anastomotic construction

Fourteen studies described or had figures demonstrating the anastomotic pattern such as inverted (serosa to serosa), everted (mucosa to mucosa) or invaginated (mucosa to serosa)

anastomosis. Six studies employed an inverted anastomosis [8, 9, 15, 16, 18, 24], among which three had positive outcomes [8, 9, 15]. Five studies used an everted anastomosis [2, 10, 11, 19, 22]; none of these had positive results. Three studies constructed an invaginated anastomosis [13, 14, 29], and two of them showed positive outcomes [14, 29].

Sutureless anastomosis constructed with CA was tested in 18 studies, of which five reported positive outcomes [3, 8, 14, 15, 29]. Different materials such as clamps, stents, modified staplers or holding sutures were used to approximate the two cutting edges, as is shown in Table 2. Within those materials, none of the studies that used an anastomotic clamp (3 studies [10, 11, 22]) showed positive outcomes. In the other studies which used holding sutures or a modified stapler to create CA anastomosis, mostly the canine and porcine studies (3/4) had positive results [8, 14, 15]. In the contrast, only one rat study (1/8) with holding sutures had positive results [3].

Nine studies tested CA as a sealant after construction of a primary anastomosis; among these, four reported positive results (two porcine studies [9, 15], one rat study [20]). Most of these studies used different suture materials (silk, polypropylene or glycolic acid) and varying suture techniques for the construction of the primary anastomosis. Except for materials, different suture sizes were tested as well. Two porcine studies used 3/0 sutures, both of these having positive outcomes [9, 15]. Five studies used 5/0 or 6/0 sutures, mostly in rat models [18, 19, 23, 24, 28], and none of them conclude positively. One rat study used 7/0 sutures, and it had positive outcomes [20].

Discussion

Substantial efforts have been made to test the feasibility, effect and safety of the use of CA in intestinal and colorectal anastomosis. Using CA as suture-replacement, early experiments in the 1960s and the 1970s failed to create a successful sutureless anastomosis [10, 30], some recent results, though promising, still vary from one to another. Previous opinions mainly put the blames on the chemical characteristics of CA [2, 7]. Indeed, intra-abdominal (actually intra-peritoneal) application of CA is distinct from its topical use such as skin wound closure, because intra-abdominally applied CA can only be absorbed,

metabolized, and degraded by the body instead of falling off by itself. However, this still does not explain everything, as most current available CA contain longer molecular chain, which are less toxic than short length CA [7]. Creating anastomoses with artificial materials not only requires a good mechanical strength, but should also induce a good physiological wound healing which eventually supports the bowel continuity and biomechanical strength by itself. All these influences indicate the importance to investigate methodological details in CA application, such as selection of CA molecular structure, dosage, animal model, and anastomotic technique. With this aim, this review summarizes the studies regarding application of CA in intestinal and colorectal anastomosis, linking the method details to the outcomes. We found that these studies contained great inconsistencies in the methods. Furthermore, some important factors and details in the methods might influence outcomes, which are discussed respectively below.

CA molecular structure

CA was tested as a potential suture replacement because of its strong adhesiveness, which makes it possible to seal a technically flawed anastomosis, and even to create a sutureless anastomosis. Our previous ex-vivo study showed that adhesiveness is similar among different types of CA, but is much stronger than that adhesive strength in other categories of tissue adhesives (unpublished data). When choosing CA for specific surgical applications, it is therefore more important to take other factors into account, such as tissue toxicity [31, 32].

In general, shorter chain CA monomers (i.e. methyl-cyanoacrylate) create significant amounts of heat during polymerization, and are known to degrade into toxic end-products, resulting in severe tissue reaction and inflammation, while longer chain-length CA is associated with more hydrophobic and bacteriostatic properties and less tissue toxicity [2, 7]. However, in intestinal and colorectal anastomoses, data from the studies that compared different CA seem to prefer in NBCA to other shorter or longer monomers [21, 27, 33]. Our results in this review also agree with this, as most CA studies with MCA, isoBCA or OCA had negative outcomes, and more than half of the NBCA studies reported positive ones [8, 9, 14, 15, 20]. Nevertheless, one must note that, with the current limited data, it is still too early to conclude which CA is the best for intestinal and colorectal anastomoses. The biological properties of CA are influenced not only by its molecule structure, but also by the additional components added into the adhesives. Developments in biochemistry may bring

further improvements in CA molecule structure for specific use as intestinal and colorectal anastomotic.

CA dosage

As well as the molecular structure, an important role in the tissue reaction of CA is also played by CA dosage. Unfortunately most studies did not provide details on this. One can imagine that an overdose of CA, comparable to a very high number of sutures or staples around the anastomosis, may lead to more side effects rather than a further increase in anastomotic strength. As CA is known to react exothermically during polymerization, CA overdose may cause direct tissue damage during polymerization, and increase adhesion formation, lengthening the long-term degradation time.

The currently available information is not enough to allow an analysis of the optimal amount of CA for intestinal and colorectal anastomosis in different animal models. According to the study of Paral et al., 1.0 mL of CA should be enough to construct a sutureless anastomosis in the porcine model [8]. Compared with the dosage for porcine anastomosis, 0.5 mL and 0.2 mL CA might be too much for rat anastomosis, as the rat colon is more than ten times smaller. Some clues on optimal CA dosage can be found from data in vascular surgery, where only 0.4 μ L CA was enough to create vessel anastomosis in rats [34]. While the manufacturers' original applicator can be directly used in porcine or other big animal models, a small syringe with a blunt needle is recommended in rodent models to ensure accurate CA application.

Animal model

Not only due to the poor outcomes from the previous literatures, but also because of ethical concerns, canine models might not be suitable for future CA studies. This review shows that all previous studies using porcine models had positive results, implying that this might be the best large animal model for future CA studies regarding to intestinal and colorectal anastomosis. This is also supported by the previous systematic review, which also found the porcine model to be superior to those with other animal species, as the pig's GI tract is much more similar to a human's than a rodents' [35]; this enables human-size surgical tools and human-dose CA to be used directly on porcine. However, the high costs of large animal models result in most animal studies on CA being performed on rat models. As stated earlier, most of the previous rat studies in this field were not a success. This is

most probably due to the small size of the rat. Almost all techniques, and also the material size and dosage will thus need to be specifically adjusted for rats.

Anastomotic technique

Construction of a successful anastomosis is not simply connecting two endings together and reaching a mechanical strength as high as possible. A good and safe physiological wound healing without complications (i.e. anastomotic leakage, adhesion, stenosis) is more important from a clinical perspective [36]. For anastomosis of the digestive tract, the inverted-suture technique has been demonstrated to lead to a sufficient biomechanical strength as well as a better wound healing than the everted pattern; invaginated anastomosis is hardly used in clinic due to higher risks to develop stenosis and other complications [36-39]. Outcomes from CA research also confirm this, as all the studies using everted anastomosis had negative results, while more than half of those using inverted anastomosis had positive outcomes [8, 9, 15]. Comparing data from the included studies, we recommend that an inverted-suturing technique should also be used in future CA studies.

Overall, the use of CA in intestinal and colorectal anastomosis has two functions: to construct a sutureless anastomosis, or to reinforce a primary anastomosis as an anastomotic sealant. For sutureless anastomosis, various materials have been used to approximate the two bowel endings before CA application. Among these materials, the modified circular stapler (in which the staples are removed prior to use) in large animal models might be a good option because the CA can easily be applied on the inverted anastomosis [33]. As a small stapler for rodents is lacking, the use of holding sutures was described in most of the rat studies. However, it does not yet seem to be satisfactory according to our results. One possible reason is that the holding sutures are not able to guarantee the inverted connection, thus creating an everted anastomosis that may complicate wound healing if CA is polymerized between the two wound edges. Also, instructions for topical usage of CA in skin wound closure indicate that the application of CA between the wound edges should be prohibited [7]. To ensure an inverted anastomosis, a special stent might be a good replacement for holding sutures, but more work on this is still required.

For the use of CA as a sealant, the suture material and its size are also important factors for a good anastomosis. Our data shows that 3/0 sutures, often used in human intestinal and colorectal anastomosis, are suitable for large animal models; 5/0 sutures

may be inappropriate for the rat intestinal and colorectal anastomosis, as no study reported positive outcomes with these. This may be due to the large size of the 5/0 sutures (diameter of absorbable 5/0 suture: 0.15-0.199 mm [40]) relative to that of the rat colon (thickness of adult male rats: around 0.6 mm [41]). The 3/0 sutures (0.30-0.349 mm [40]) are much smaller and lighter compared to the human colon (thickness: 2.6 mm [42]) or porcine colon. For rat intestinal and colorectal anastomosis, smaller size sutures such as 7/0 (0.07-0.099 mm [40]) or 8/0 (0.05-0.069 mm [40]) seemed to be proper while more evidence is still required.

Conclusion

In view of the positive outcomes of the large animal experiments, the application of CA in intestinal and colorectal anastomosis seems promising. However, the great inconsistency and lack of detailed information in the previous literature made comparison of methodology difficult. To achieve a better consistency, studies should provide more details in the methods. If the dosage of CA, the choice of animal model, inverted anastomosis construction, and other method details also are improved, future studies will achieve better intestinal and colorectal anastomoses with CA.

REFERENCES

1. Coover HN, Joyner FB, and Sheerer NH, Chemistry and performance of a cyanoacrylate adhesive. *Spec Tech Pap*, 1959(5): p. 413-7.
2. Gennaro, A.R. and C.A.X. Moreira, Nonsuture colonic anastomosis. *DIS COLON RECTUM*, 1976. 19(3): p. 245-249.
3. Elemen, L., et al., Is the use of cyanoacrylate in intestinal anastomosis a good and reliable alternative? *J Pediatr Surg*, 2009. 44(3): p. 581-586.
4. Daams, F., et al., Local Ischaemia Does Not Influence Anastomotic Healing: An Experimental Study. *EUR SURG RES*, 2013. 50(1): p. 24-31.
5. FDA(US). *DermaBond™ - P960052*. 1998; [Summary of safety and effectiveness data]. Available from: <http://www.accessdata.fda.gov/scripts/cdrh/cfdocs/cfTopic/pma/pma.cfm?num=P960052>.
6. Spotnitz, W.D. and S. Burks, Hemostats, sealants, and adhesives III: a new update as well as cost and regulatory considerations for components of the surgical toolbox. *Transfusion*, 2012.
7. Quinn, J.V., *Tissue adhesives in clinical medicine*. 2nd ed. 2005, Hamilton: BC Decker, Inc. vi, 183 p.
8. Paral, J., et al., Suture-Free Anastomosis of the Colon Experimental Comparison of Two Cyanoacrylate Adhesives. *J Gastrointest Surg*, 2011. 15(3): p. 451-459.
9. Tebala, G.D., et al., The use of cyanoacrylate tissue adhesive in high-risk intestinal anastomoses. *SURG TODAY*, 1995. 25(12): p. 1069-1072.
10. Weilbaecher, D.A., F.J. Mathieu, and I. Cohn, Jr., Nonsuture Intestinal Anastomosis. *AM J SURG*, 1964. 107: p. 353-60.
11. O'Neill, P., et al., Nonsuture intestinal anastomosis. *American Journal of Surgery*, 1962. 104: p. 761.
12. Moher, D., et al., Preferred reporting items for systematic reviews and meta-analyses: the PRISMA statement. *J Clin Epidemiol*, 2009. 62(10): p. 1006-12.
13. Linn, B.S., et al., Intestinal anastomosis by invagination and gluing. *AM J SURG*, 1966. 111(2): p. 197-9.
14. Matsumoto, T., et al., Intestinal anastomosis with n-butyl cyanoacrylate tissue adhesive. *Surgery*, 1967. 61(4): p. 567-572.
15. Tebala, G.D., et al., Polymeric glues in intestinal surgery. *EUR REV MED PHARMACOL SCI*, 1994. 16(1-2): p. 13-20.
16. Weiss, M. and M. Haj, Gastrointestinal anastomosis with histoacryl glue in rats. *J Invest Surg*, 2001. 14(1): p. 13-19.
17. Ozmen, M.M., et al., Histoacryl blue versus sutured left colonic anastomosis: Experimental study. *ANZ J Surg*, 2004. 74(12): p. 1107-1100.
18. Kayaoglu, H.A., et al., Effect of N-butyl-2-cyanoacrylate on high-risk colonic anastomoses. *Kaohsiung J Med Sci*, 2009. 25(4): p. 177-183.
19. Bae, K.B., et al., Cyanoacrylate for colonic anastomosis; is it safe? *Int J Colorectal Dis*, 2010. 25(5): p. 601-606.
20. Ensari, C.O., et al., Effects of N-butyl-2-cyanoacrylate on high-level jejunostomy. *Eur Surg Res*, 2010. 44(1): p. 13-16.
21. Matsumoto, T., et al., Intestinal anastomosis with n-butyl cyanoacrylate tissue adhesive. *Surgery*, 1967. 61(4): p. 567-72.
22. Stirling, C.T. and I. Cohn, Jr., Nonsuture Small Bowel Anastomosis: Experimental Study with Cyanoacrylate Monomer. *AM SURG*, 1965. 31: p. 587-589.
23. Hale, J. and H. Ellis, Isobutyl cyanoacrylate as a tissue adhesive. *BR J SURG*, 1968. 55(11): p. 850-852.
24. Uroskie, T.W., et al., Effects of isobutyl

- cyanoacrylate tissue adhesive on small bowel anastomosis in puppies. *Am Surg*, 1971. 37(7): p. 397-404.
25. Kirkegaard, P., A.B. Christensen, and J. Ibsen, Experimental nonsuture colonic anastomoses. *AM J SURG*, 1980. 139(2): p. 233-236.
26. Kanellos, I., et al., Sutureless colonic anastomosis in the rat: A randomized controlled study. *Tech Coloproctol*, 2002. 6(3): p. 143-146.
27. Nursal, T.Z., et al., The effect of tissue adhesive, octyl-cyanoacrylate, on the healing of experimental high-risk and normal colonic anastomoses. *Am J Surg*, 2004. 187(1): p. 28-32.
28. Irkorucu, O., et al., Effect of 2-octyl-cyanoacrylate on ischemic anastomosis of the left colon. *J Invest Surg*, 2009. 22(3): p. 188-194.
29. Galvao, F.H.F., T. Bacchella, and M.C. Machado, Cuff-glue sutureless microanastomosis. *Microsurgery*, 2007. 27(4): p. 271-276.
30. Weilbaecher, D.A., C.T. Stirling, and F.J. Mathieu, Nonsuture intestinal anastomosis. *Bull Soc Int Chir*, 1966. 25(2): p. 125-36.
31. Leggat, P.A., D.R. Smith, and U. Kedjarune, Surgical applications of cyanoacrylate adhesives: a review of toxicity. *ANZ J Surg*, 2007. 77(4): p. 209-13.
32. Leggat, P.A., U. Kedjarune, and D.R. Smith, Toxicity of cyanoacrylate adhesives and their occupational impacts for dental staff. *Ind Health*, 2004. 42(2): p. 207-11.
33. Paral, J., et al., Suture-free anastomosis of the colon. Experimental comparison of two cyanoacrylate adhesives. *J Gastrointest Surg*, 2011. 15(3): p. 451-9.
34. Wei, W., et al., Cyanoacrylate-assisted arterial anastomosis in rat small bowel transplantation. *Langenbecks Arch Surg*, 2010. 395(6): p. 727-35.
35. Pommergaard, H.C., et al., Choosing the best animal species to mimic clinical colon anastomotic leakage in humans: a qualitative systematic review. *Eur Surg Res*, 2011. 47(3): p. 173-81.
36. Sliker, J.C., et al., Systematic review of the technique of colorectal anastomosis. *JAMA Surg*, 2013. 148(2): p. 190-201.
37. Trueblood, H.W., et al., Wound healing in the colon: comparison of inverted and everted closures. *Surgery*, 1969. 65(6): p. 919-30.
38. Healey, J.E., Jr., C.M. McBride, and H.S. Gallager, Bowel anastomosis by inverting and everting techniques. An experimental study. *J Surg Res*, 1967. 7(7): p. 299-304.
39. Wu, Z., et al., Reducing Anastomotic Leakage by Reinforcement of Colorectal Anastomosis with Cyanoacrylate Glue. *Eur Surg Res*, 2013. 50(3-4): p. 255-261.
40. U.S.Pharmacopeia, USP Monographs: absorbable surgical suture. p. 2050.
41. Watters, D.A., et al., Mechanical properties of the rat colon: the effect of age, sex and different conditions of storage. *Q J Exp Physiol*, 1985. 70(1): p. 151-62.
42. Konovalov, D., [Morphometric characteristics of human colon wall as anatomic basis for microsurgical anastomoses]. *Morfologiya*, 2007. 131(1): p. 58-62.

Figures and tables

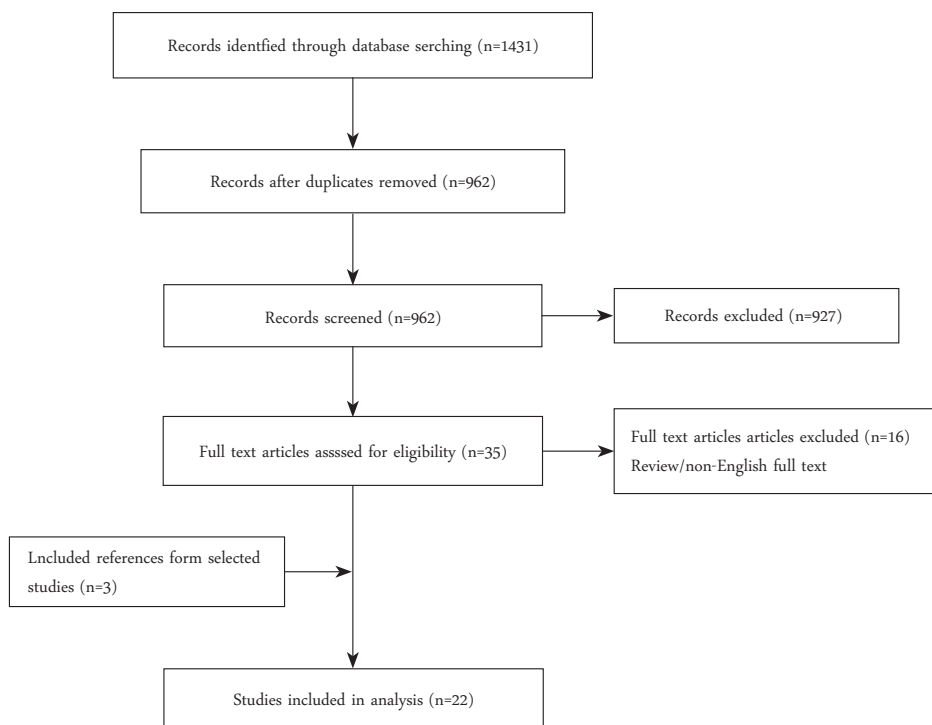

Figure 1. Study selection for relevant articles.

Table 1. Cyanoacrylate adhesives used in the included studies

Chemical structure	Abbreviation	Trade name	Manufacturer
Methyl-cyanoacrylate	MCA	910 Easterman	Ethicon (Somerville, New Jersey, USA)
Ethyl-cyanoacrylate	ECA	Pattex	Henkel (Dusseldorf, Germany)
N-butyl-cyanoacrylate	NBCA	Histoacryl (blue)	B. Braun (Melsungen, Germany)
		Glubran 2	GEM Italia (Via reggio, Italy)
2-octyl-cyanoacrylate	OCA	Dermabond	Ethicon (Norderstedt, USA)
		Gluseal	GluStitch, Inc (Delta, BC, Canada)

Table 2: Synopsis of results: cyanoacrylate application in intestinal and colorectal anastomosis

Year	Author	Subject	n	Glue (chemical name)	Glue (trade name)	Usage	Dosage	Curing time	Anastomotic material	Suture Material	Suture size	Anastomotic pattern	GI level	Outcome
1962	O'Neill [11]	Canine	26	MCA	910 Easterman	Anastomosis	NS	60s	Clamp	-	-	Evert	Intestine Colon	+/-
1964	Weilbaeher [10]	Canine	101	MCA	910 Easterman	Anastomosis	NS	3 min	Clamp	-	-	Evert	Intestine	-
1966	Linn [13]	Canine	30	MCA	910 Easterman	Anastomosis	NS	NS	Invaginate	-	-	Invaginate	Intestine	+/-
1976	Gennaro [2]	Rat	35	MCA	910 Easterman	Anastomosis	NS	10-20s	Gelatine stent	-	-	Evert*	Colon	-
2009	Elemen [3]	Rat	96	ECA	Pattex	Anastomosis	NS	NS	Holding suture	polyglactin 910	5/0	NS	Intestine	+
2011	Paral [8]	Porcine	12	NBCA OCA	Glubran 2 Dermabond	Anastomosis	1.0ml		Modified stapler	-	-	Invert	Colon	+ BCA +/- OCA
2001	Weiss [16]	Rat	64	NBCA	Histoacryl	Anastomosis	NS	3-4 min	Holding suture	Vicryl sutures	6/0	Invert	Stomach-jejunal	+/-
2004	Ozmen [17]	Rat	40	NBCA	Histoacryl	Anastomosis	NS	NS	Holding suture	Polypropylene	5/0	NS	Colon	-
1995	Tebala [9]	Porcine	10	NBCA	NS	Sealant	NS	NS	Suture Stapler	Silk suture	3/0	Invert	Intestine Colon	+
2009	Kayaoglu [18]	Rat	80	NBCA	Glubran 2	Sealant	0.2 ml	NS	Suture	glycolic acid	5/0	Invert	Colon	-
2010	Ensari [20]	Rat	40	NBCA	Glubran 2	Sealant	0.2 ml		Suture	polypropylene	7/0	NS	Intestine	+
1967	Matsumoto [14]	Canine	70	NBCA, ACA, HCA	NS	Anastomosis Sealant	NS	NS	nvaginate	NS	NS	Invaginate	Intestine	+ BCA - Others
2010	Bae [19]	Rat	60	NBCA	Histoacryl	Anastomosis Sealant	NS	NS	Suture	polypropylene	5/0	Evert*	Colon	-
1994	Tebala [15]	Porcine/ Rat	55/30	NBCA	NS	Anastomosis Sealant	NS	NS	11 kinds of anastomosis	silk suture	3/0	Invert	Intestine Colon	+
1965	Stirling [22]	Canine	37	isoBCA	NS	Anastomosis	NS	2-3 min	Clamp	-	-	Evert	Intestine	+/-
1980	Kirkegaard [25]	Rat	60	isoBCA	NS	Anastomosis	NS	NS	Stent	-	-	NS	Colon	+/-
1968	Hale [23]	Rat	66	isoBCA	NS	Anastomosis Sealant	NS	60s	Holding suture	silk suture	5/0	NS	Intestine Colon	+/-
1971	Uroskie [24]	Canine	15	isoBCA	NS	Sealant	NS	3-4 min	Suture	silk suture	5/0	Invert	Intestine	-
2002	Kanellos [26]	Rat	40	OCA	Dermabond	Anastomosis	NS	NS	Holding suture	polypropylene	6/0	NS	Colon	+/-
2004	Nursal [27]	Rat	90	OCA	Dermabond	Anastomosis	0.5 ml	NS	Holding suture	polypropylene	7/0	NS	Colon	-
2009	Irkorucu [28]	Rat	40	OCA	Gluseal	Anastomosis Sealant	NS	NS	Holding suture / Suture	polypropylene	6/0	NS	Colon	-
2007	Galvao [29]	Rat	18	NS	NS	Anastomosis	NS	2-4 min	Cuff	-	-	Invaginate	Intestine	+

* Shown on the picture; Abbreviation of different cyanoacrylate is specified on table 1. NS = not specified

Chapter 6:

Mechanical Strength and Rheological Properties of Tissue Adhesives with Regard to Colorectal Anastomosis: an Ex Vivo Study

K.A. Vakalopoulos, Z. Wu, L.F. Kroese, G-J. Kleinrensink, J. Jeekel, R. Vendamme, D. Dodou, J.F. Lange

Annals of Surgery, 2014 (published)

Abstract

Objective: To compare mechanical strength and rheology of existing tissue adhesives in a clinically relevant test setup with regard to colorectal anastomosis.

Background: Little is known on the mechanical strength of tissue adhesives directly after application. Furthermore, rheological profiling may be important in understanding mechanical performance and explaining differences between adhesives. This study provides new data on the mechanical strength and rheology of a comprehensive list of tissue adhesives with regard to colorectal adhesiveness.

Materials and methods: Twelve surgical tissue adhesives were included: 4 cyanoacrylates (CA), 2 fibrin glues (FG), 3 polyethylene glycol adhesives (PEG) and 3 albumin based adhesives (AB). Tubular rat colonic segments were glued together. Tensile (T), shear (S) and peel (P) strength were measured. Shear storage (G') and shear loss (G'')

moduli were also evaluated.

Results: CA adhesives were stronger than AB ($T: p = .017$; $S: p = .064$; $P: p = .000$), which, in turn, were stronger than PEG ($T: p = .000$; $S: p = .000$; $P: p = .018$). PEG were stronger than FG for shear ($p = .013$) and comparable for tensile and peel strength ($p > .05$). Within-group variation was smallest for CA. Mechanical strength correlated strongly between performed tests. Rheological properties (G' and G'') correlated strongly with mechanical strength for all adhesives combined.

Conclusion: CA are the strongest and most homogenous group in terms of mechanical strength. Hydrogels (FG, AB) are heterogeneous, with lower mechanical strength than CA. FG are mechanically the weakest adhesives. Rheological profiles correlate to mechanical strength and may be useful for predicting mechanical performance.

Introduction

The field of tissue adhesives is gaining popularity in modern-day medicine. Tissue adhesives have become commonplace in several fields of medicine including dural repair, endoscopic fistula repair (cardio)vascular surgery [1-4] and mesh fixation [5]. In the field of gastrointestinal (GI) surgery, recent research has reported using tissue adhesives to seal or create GI anastomoses to decrease anastomotic leakage (AL) rates, which are known to be high in this field [6]. These experiments, mostly on animal models, provide insight into the effectiveness of tissue adhesives on surgical complication rates, particularly AL [7].

Tissue adhesives work by forming a mechanical seal around an anastomosis, thus protecting it from leakage of intraluminal contents and ameliorating effects of AL. Before curing, all adhesives are low-viscosity liquids that can efficiently flow into the pores of, in this case, biological tissue. Following the polymerisation phase, the cohesiveness of the adhesive increases, and the interface between the adhesive and the tissue is altered mechanically (i.e., by interlocking of the adhesive with the porous tissue surface), physically and/or chemically. Overall, the strength of the cured adhesive joint is the result of a balance between the cohesiveness of the adhesive and its adhesiveness to the tissue.

Tissue adhesives can be divided into categories based on their composition. Cyanoacrylate adhesives (CA), also known as ‘superglues’, are synthetic adhesives,

which contain cyanoacrylate monomers that polymerize after contact with water. Polymerization results in an exothermic reaction, the rate of which depends on the length of the cyanoacrylate monomers: the shorter the chain length, the more spontaneous the polymerization. CA are known to be strong but rigid and have been reported to induce tissue toxicity intracorporeally [8,9]. Modern-day CA are becoming less histotoxic and more flexible [10]. Another well-known group of tissue adhesives is fibrin glues (FG). These two-component adhesives consist of concentrated fibrinogen and thrombin, simulating the final stage of the clotting cascade. FG form a flexible, mildly strong, adhesive bond. Some FG preparations use antifibrinolytics such as aprotinin to delay degradation time. FG are used as surgical hemostats, for the sealing of colostomies and in skin graft procedures [3,8]. Polyethylene glycol (PEG) sealants are multi-component preparations containing PEG combined with polymerization agents that form a hydrogel, resulting in a watertight tissue bond. PEG sealants have been approved for use in the sealing of spinal dura, with good clinical results [11]. Furthermore, gelatin-formaldehyde-resorcinol (GRF) adhesives are two-component synthetic adhesives containing a mixture of gelatin and resorcinol that is polymerized when a small amount of formaldehyde or glutaraldehyde is added. Despite concerns about tissue necrosis due to formaldehyde use, GRF is widely used for aortic dissection repair [2]. In the same adhesive category and currently in use for the same clinical field, albumin-based adhesives are gaining popularity with good results, without concerns of formaldehyde-induced toxicity [12,13].

The mechanical strength of a tissue adhesive is an important parameter in its overall effectiveness as an anastomotic sealant. In *in vivo* studies, mechanical strength testing of the adhesive-tissue bond takes directly following sacrifice of the animal. However useful as a quantitative measure of anastomotic strength, these methods do not provide information on mechanical strength directly after application, that is, prior to adhesive bond degradation and healing effects. This information is, in fact, important for the sealing of a bowel anastomosis, as its strength is lowest directly after creation, when wound-healing mechanisms have not yet started to provide intrinsic anastomotic strength. Directly after construction, anastomotic strength thus relies entirely upon the used sutures or staples. Hence, one may postulate that the anastomosis is most prone to technical failure directly after its creation, and that this is when the added value of an anastomotic seal is most apparent. Therefore, the post-application adhesive strength of a tissue adhesive is an important parameter in the evaluation of a tissue adhesive as an anastomotic sealant.

Methodology is also a concern in the field of tissue adhesives. In *in vivo* studies large differences exist in the choice of animal model, experimental endpoints and adhesive strength testing methods (cf. anastomotic bursting pressure vs. tensile strength tests). In *ex vivo* studies various adhesive strength-testing methods exist, using various tissue substrates, tissue preparation methods, curing times and testing protocols. Overall, these differences make the comparison of mechanical strength data between studies and a proper evaluation of the effectiveness of tested tissue adhesives problematic [7]. This lack of consensus may also be a factor leading to the relatively low number of clinical studies in this research field.

Besides the mechanical strength of a tissue adhesive it is also important to look into its rheological profile. The rheological profile of a viscoelastic material can be defined by dynamic mechanical analysis and can be described by two moduli: the shear storage modulus G' and the shear loss modulus G'' . These parameters provide information on the cohesion (strength of adhesive-adhesive bonds) and adhesion (strength of bonds between adhesive and tissue), and should ideally be balanced as not to create an adhesive which is either too elastic or too brittle, which may result in suboptimal adhesive strength. Understanding the rheology of a tissue adhesive can provide insight into its cohesive response when under mechanical stress, which is important in understanding its clinical effectiveness, as recently shown by Serrero et al. [14].

In the current study we have adapted existing guidelines of industrial adhesive testing for use with *ex vivo* rat colon to determine the mechanical adhesive strength of existing tissue adhesives, as a fundamental step in their evaluation as colorectal anastomotic sealants. Furthermore, rheological profiling of each tissue adhesive was undertaken and the correlations between the rheological properties and the mechanical strength of the adhesives were calculated. All tissue adhesives were tested following the same testing protocol, ensuring fair comparison of results.

Materials and Methods

Tissue adhesives

Twelve tissue adhesives were selected from each of the previously described tissue

adhesive categories. A synopsis of the included adhesives can be found in Table 1. These adhesives were considered to be representative of the modern day commercially available tissue adhesives in surgical practice. Next to the 12 tissue adhesives, an industrial CA (Pattex Super Glue, Henkel, Germany) was used for comparative purposes. Tissue adhesives were purchased or provided for the purposes of this study. Companies providing the adhesives had no influence in the testing, results or conclusions of this study.

Adhesive substrate

Our objective was to develop a clinically relevant model for the testing of surgical tissue adhesives, in which the adhesive bond strength to colonic serosa could be tested without confounding factors such as suturing or anastomotic technique. We therefore chose to use intact tubular colonic segments to preserve the normal geometry and residual stresses of the colon [15]. Colonic segments were obtained from male Wistar rats (250-350 g), which were sacrificed for the purposes of other projects within our research group and in which the bowels were not disturbed. Approval for the study was received from the Erasmus University Medical Center (Rotterdam, the Netherlands), and guidelines for safe and hygienic tissue handling were followed. Directly following sacrifice, the full colon of the rat was resected and the mesocolon removed. After the bowel contents were flushed using a syringe and tap water, the colon was placed in Ringer's lactate solution and cooled to 5-10 °C pending mechanical testing. All tests were performed within 24 hours after resection.

Sample preparation

Directly prior to the experiments the resected colon was cut into 2-cm long segments using surgical scissors. Per test, 2 segments were needed. A custom-made 4-mm wide U-shaped pin was inserted intraluminally into each colonic segment. Each colonic segment was ligated on both ends of the pin, outside of the gluing area, to prevent the colon from sliding during testing.

Tissue adhesive application

Adhesive application took place according to the manufacturers' guidelines. Two of the abovementioned pins (around which the colonic segments were placed) were each fixed onto a custom-made cylindrical holder with sunken screws and the colonic segments were glued while approximated, creating a tension-free adhesive bond. Curing time varied

according to the manufacturer's guidelines. The test setup is shown in Figure 1. In order to simulate intra-abdominal curing conditions, curing of the adhesive took place in an incubator that was kept at 37° Celsius with a humidity level of >95%. Two semi-cylindrical shaped supports were used to lock the testing cylinders with the glued segments in position during curing and transportation from the incubator to the materials testing machine. These supports were removed as soon as the test setup was fixed to the testing machine, prior to mechanical testing.

Mechanical testing

To simulate the mechanical forces that a colonic tissue adhesive may encounter, we selected three mechanical tests: tensile, shear and peel testing. Tensile and shear testing simulate contractile peristaltic waves, constricting the colon and pulling on the adhesive layer, and the effects of external viscera moving across the adhesive layer. Peel testing was considered to simulate the 'weak point' of a tissue adhesive, when pull is exerted on the outer edge of the adhesive bond. These three tests also form the basis for the testing of tissue adhesives in the testing protocols of the American Society for Testing and Materials (ASTM) standards [16-18]. For the purposes of our study these ASTM standards were adapted for use with tubular colonic segments. Each test is illustrated in Figure 2. All tests were performed using an industrial static materials testing machine (Zwick, UK, type 1484/ Testometric, UK, type AX M250-2.5kN). Tests were performed with a 20 N load cell, at a testing speed of 10 mm/min. Computer-based analysis software was used to record all tester data in real-time. For each tissue adhesive, tensile, shear and peeling strength were measured. Each test was performed 7 times.

Rheological testing

Rheological profiles were monitored at 37.5°C with an AR 2000 rheometer (TA Instruments) in parallel plate geometry. The liquid (uncured) adhesive samples were first placed on the rheometer plate (8 mm diameter and 0.5 mm gap) and left to cure at 25°C until a stable value of G' was reached. To prevent evaporation of water during the curing stage, silicon oil was applied around the sample (oil was removed before starting the frequency sweep to prevent influencing the measurement). Angular frequency sweep measurements were then performed in dynamic mode within the viscoelastic regime of the adhesives (i.e., with G' and G'' independent of strain) with a strain of 0.01 and frequencies ranging from 0.1

to 100 rad/s. All rheological tests were performed three times.

Measure of solid content

A given weight of liquid adhesive was left to cure at room temperature overnight. The cured amount was then placed in an oven at 70°C for 3 hours and the residual weight was measured. Solid content of the adhesive was obtained from the ratio of the residual weight divided by the initial sample weight.

Data analysis

A paired t-test was used to compare adhesive categories with each other with respect to their tensile, shear and peel strength, and a one-way analysis of variance (ANOVA) with a post-hoc Tukey-Kramer test was conducted to compare adhesives within categories. Pearson correlations were calculated between the tensile and shear, tensile and peel, and shear and peel data of all tested adhesives. Pearson correlations were also calculated between the rheological properties G' and G'' versus each of the three mechanical strength tests. A p-value of .05 or less was chosen to define statistical significance. All data analyses were performed in MATLAB (Version R2010b, The MathWorks, Inc., Natick, MA, USA).

RESULTS

Mechanical testing

First, mechanical strength between categories of adhesives was compared. Cyanoacrylates (CA) showed the highest mechanical strength, stronger than the albumin-based adhesives (AB) in tensile ($t(20) = 2.61$, $p = .017$) and peel ($t(19) = 4.24$, $p = .000$) testing. CA also tended to be stronger than AB in shearing, although this result did not reach statistical significance ($t(19) = 1.97$, $p = .064$). The AB group was significantly stronger than the polyethylene glycol adhesive group (PEG) in all three mechanical tests (T: $t(17) = -4.01$, $p = .000$; S: $t(15) = -6.13$, $p = .000$; P: $t(18) = -2.60$, $p = .018$). Differences in mechanical strength between PEG and FG were small, and significant differences were only seen in the shear test, where PEG were superior to FG ($t(11) = 2.95$, $p = .013$). An overview of these results is provided in Figure 2.

Second, mechanical strength within each adhesive category was analyzed for each mechanical test (Figure 3). Within CA, the largest variation in mechanical strength of different glues was found for the tensile strength test, where Histoacryl Flex tended to be inferior to Omnex ($p = .054$). However, the difference between the 4 CA's did not reach significance ($F(3,24) = 2.60, p = .076$). Compared to tensile strength, shear and peel strength showed less variation between CA adhesives (S: $F(2,23) = 1.22; p = .325$; P: $F(2,23) = 1.09; p = .372$). AB were found to be rather heterogeneous in terms of adhesive strength ($F(2,22) = 5.61, p = .011$; P: $F(2,18) = 6.23, p = .009$). Specifically, GRF resulted in significantly lower tensile and peeling strength compared to Covabond ($p = .010$ and $p = .007$, respectively). PEG showed the largest variation of all categories in all three mechanical tests (T: $F(2,15) = 5.17; p = .020$; S: $F(2,14) = 5.29, p = .020$; P: $F(2,17) = 32.68, p < .001$). Duraseal yielded lower tensile strength than CoSeal ($p = 0.019$), whereas Duraseal Xact produced lower shear than CoSeal ($p = .015$) and lower peel from both Duraseal and CoSeal (both $p = .000$). Among FG, the only significant difference was found in the tensile test results, for which Tissucol yielded higher strength than Evicel ($t(6) = -3.19, p = .019$). Lastly, we found that the results in all three tests correlated strongly with each other (T vs. S: $r = .504, p = .000$; T vs. P: $r = .578, p = .000$), as shown in Figure 4.

Pattex adhesive, used to compare tissue adhesives to industrial 'super glue' yielded lower adhesive strength than the other tissue CA (T: mean= 1.57, standard deviation= 0.49, N= 7; S: mean= 1.68, standard deviation= 0.43, N= 7; P: mean= 0.31, standard deviation= 0.14, N= 7).

Rheological testing

The highest values of G' and G'' over the entire frequency range were obtained for Pattex (industrial ethyl cyanoacrylate (ECA) based adhesive), indicating that this glue possesses the highest cohesiveness of all the CA specimens. Moreover, the high G' value (around 2×10^8 Pa) and the low slope of the $G'=f(\omega)$ curve both indicate that Pattex is a rigid material at 37.5°C . Among the tissue adhesives, the rheological profiles of the CA Histoacryl Flex and Dermabond, respectively formulated from the monomers n-butyl cyanoacrylate (nBCA) and 2-octyl cyanoacrylate (2OCA), are both characterised by lower values of G' and G'' and a higher slope for $G'=f(\omega)$, indicating higher flexibility as compared to Pattex. Rheological profiles of CA are shown in Figure 5a.

The rheological behaviour of PEG (Fig. 5b) is characterised by lower values of G' and G'' (from 1×10^5 Pa to 1×10^6 Pa) compared to CA, which is indicative of a low network concentration. Indeed, the solid content of Duraseal was found to be 9.9%, which means that this gel contains 90.1% water. Although the solid content of the FG Evicel was similar to the PEG-based Duraseal (9.8% vs. 9.9%), Evicel exhibited higher values of G' and G'' , indicating that it is more cohesive than Duraseal (Figure 5b).

The rheological behavior of the AB group (GRF, Bioglue and Covabond) is shown in Figure 5c. The solid content of these adhesives was intermediate between those of CA and PEG, with values of 49.6, 40.1 and 38.3 for GRF, Covabond and Bioglue, respectively. GRF exhibited intermediate G' between 1×10^6 Pa to 1×10^7 Pa. Bioglue and Covabond both displayed G' values in the same range as CA, which suggests that these adhesives are highly cohesive despite their moderate solid contents. Lastly, we also performed a correlation analysis between rheological profiles and mechanical tests of each tissue adhesive. Strong and significant correlations between both G' and G'' moduli and all three mechanical tests were found (Figure 6; T: $r_{G'} = .711$; $r_{G''} = .716$; S: $r_{G'} = .715$; $r_{G''} = .771$; P: $r_{G'} = .637$; $r_{G''} = .692$).

Discussion

Tissue adhesives are gaining popularity in various fields of medicine. Except for their use as successful skin closure devices, tissue adhesives are also increasingly being used inside the human body for a number of indications [4,5,19]. Sealing of colonic anastomosis with tissue adhesives has been pointed out as a promising technique to prevent anastomotic leakage, however, *in vivo* studies have provided ambiguous results on its effectiveness [7]. This may be due to the interexperimental differences in animal models, testing protocol and adhesive application. *Ex vivo* adhesive testing may provide a clear view of differences in the comparative mechanical performance between adhesives, and may act as a platform for initial selection of tissue adhesives to be applied in subsequent *in vivo* testing. To date, data of *ex vivo* testing of tissue adhesives are scarce. Several authors report on the use of tissue adhesives in *ex vivo* models representing intracorporeal use. Shazly et al. used rat duodenum for the testing of the adhesive strength of their PEG: Dextran glue [20]. In their model a full thickness puncture wound was created using a needle, and was then sealed off

with the adhesive before burst pressure analysis was performed. In another study, Sidle et al. evaluated the tensile strength of BioGlue in a model using periosteum from human cadavers [21]. Azadani et al. compared the mechanical strength of several fibrin glues and BioGlue on human and porcine aortic grafts [22]. In another study by Kull, the tensile, shear and peel strength of Glubran 2 and TissuCol were evaluated [23] by using segments of fresh, shaven porcine skin as the biologic substrate and performing tests according to the ASTM guidelines for the testing of tissue adhesives. To date, no experiments have reported using tubular colonic segments for the testing of tissue adhesives.

In our study we evaluated the mechanical strength and rheological properties of a comprehensive list of surgical tissue adhesives from each tissue adhesive category, using the same experimental configuration and testing protocol, thereby overcoming the abovementioned limitation of heterogeneous testing protocols. Moreover, by using tubular colonic segments we were able to test the adhesives in a clinically relevant setting by applying the adhesive only on the serosal surface of the bowel, the target site for its eventual clinical use while leaving the mechanical properties of the colon intact.

Mechanical test setup

Peristalsis of the colon is a complex process consisting of various types of contractions. Individual phasic contractions occur spontaneously, and organized motor complexes assist in the propulsion of bowel contents. The effects of peristalsis consist of kneading of fecal material by circular muscle contraction and propulsion via longitudinal muscle activity [24]. A bowel anastomosis is thus subjected to mechanical forces in various directions. Next to peristaltic forces, external forces may play a role such as in the case of adhesion formation to other viscera, and the direct adhesive effect of the tissue adhesive to other viscera. These forces can be simplified into 3 mechanical planes, i.e. forces acting to the plane of the anastomosis, forces parallel to the plane of the anastomosis, and peeling forces. To simulate these forces in our test setup, we therefore chose to test tensile strength, shear strength and peel strength. To our knowledge this is the first study in which fresh, circular bowel segments were used and in which an adhesive was applied only on the serosal surface of each segment. Our test-setup can, therefore, enable surgical adhesive application in the same manner as it would be done peri-operatively, while keeping the biomechanical characteristics of the colon intact.

Mechanical testing

In this study, CA were the strongest tissue adhesive group in terms of adhesive strength. This group was also easy to use due to easy application procedures and quick curing time. Furthermore, when comparing the outcomes of the mechanical tests between CA, no significant differences were found. This points out that despite differences in composition and/or additives (Table 1), the group of CA were the most homogeneous group in terms of adhesive performance.

AB adhesives were characterized by diverse chemical compositions, resulting in larger differences in mechanical strength than in the case of CA. Significant differences were observed between AB for both tensile and peel tests. Of these, the albumin-based adhesives Covabond and Bioglue exhibited similar mechanical strength, whereas the gelatin-based GRF resulted in lower adhesive strength for tensile and shear tests. In this group, it was found difficult to provide a precise adhesive application for GRF and the correct amount of formaldehyde hardener, as also previously acknowledged [25]. To ensure reproducible and correct application, we used the application procedure described previously by Nishimori in which formaldehyde was applied using an insulin needle [26].

Adhesive strength testing yielded that PEG and FG are similar to each other. PEG adhesives differed significantly from each other in all mechanical tests. In this group, Coseal resulted in the highest adhesive strength while Duraseal and Duraseal Xact yielded large differences between tests. Duraseal Xact showed higher strength in the tensile strength test, but Duraseal seemed to be stronger in shear and peel testing. The difference between Duraseal and Duraseal Xact is the additive N-hydroxy succinimide in Duraseal Xact, used to prevent swelling in this adhesive. This additive may account for the differences in adhesive strength. Among FG, Tissucol and Evicel adhesives provided similar results for shear and peel strength, whereas Tissucol was stronger in terms of tensile strength. This may be due to the aprotinin additive in Tissucol, which is added to delay degradation time. In this study we observed low mechanical strength of FG. Previous research wherein FG was used reported that FG created a very strong bond [27]. A possible explanation for this finding is that the presence of blood or intraperitoneal fluid further strengthens the tissue-adhesive bond, while being aided by the physiological action of fibrin.

We also observed that the three mechanical tests strongly correlated with each other. Based on this information, one may postulate that, if the purpose of an analysis is to compare *ex vivo* two or more adhesive formulations, using one of the three mechanical tests may suffice, thereby enabling considerable savings in material and time resources.

When comparing mechanical strength between adhesive groups (using the adhesive categories described previously) we observed that CA were the strongest tissue adhesives, followed by AB, PEG and FG. Generally, the tensile and shear strength tests resulted in the highest adhesive forces, and were mostly not significantly different to one another. Peel strength for all groups showed much lower mechanical strength in all adhesive samples, in line with previous research on tissue adhesives [23].

Rheological testing

Rheological testing of tissue adhesives is standard practice in the development phase of any industrial tissue adhesive. However, rheological data for commercialized tissue adhesives are not currently publicly available. Rheological analysis was performed to provide information on the degree of cohesiveness, and in turn, flexibility of the tested tissue adhesive. Higher values of G' and G'' , and a low slope of the $G'=f(\omega)$ curve are indicative of high cohesiveness and a rigid/brittle adhesive. When comparing the various categories of tissue adhesives, we observed that CA resulted in the highest cohesiveness and were therefore generally the least flexible tissue adhesives. AB were more flexible than CA, whereas the most flexible adhesives were found in the PEG and FG groups, which showed comparable rheological results.

Between CA, some differences were found in rheological profiles. Pattex, which was included for comparative purposes, representing non-tissue oriented CA, was the most rigid adhesive. Within the tissue CA, Glubran 2 and Omnex provided the least flexible rheological profiles, while Histoacryl Flex and Dermabond were the most flexible adhesives, yielding rheological profiles comparable to the BA. The increased flexibility of nBCA-based (Histoacryl) and 2OCA-based (Dermabond) adhesives as compared to the ECA-based adhesive likely stems from the plasticizing effect of the alkyl side-groups constituting the polymer backbone. This effect is especially pronounced for the longer octyl side-groups, as indicated by the lowest values of G' and G'' at high frequencies for the Dermabond adhesive. In the AB group, Covabond and Bioglue were relatively rigid, both displaying

G' values in the same range as CA, which suggest that these adhesives are highly cohesive despite their moderate solid contents. Moreover, these two adhesives had a very similar rheological profile, indicating that the albumin/aldehyde base which both Covabond and Bioglue share, is a determinant factor of their rheological profile. In the same adhesive category, GRF showed low G' and G'' indicating low cohesiveness and more flexibility. As stated above, the lowest G' and G'' were observed for PEG and FG. While these categories differed significantly in mechanical strength, they share very similar rheological profiles, and are very flexible adhesives. In this group, it was noteworthy that Duraseal Xact was the most flexible adhesive sample, while its composition is similar to the Duraseal adhesive. Interestingly, although the solid content of the FG Evicel was almost similar to the PEG-based Duraseal (9.8% compared to 9.9%), Evicel appeared to be much more cohesive. This observation suggests that the fibre-like supra-molecular architecture of FG creates a stiffer structure as compared to the more flexible network of interconnected PEG chains in PEG adhesive. Rheological results are interesting due to the implications for their target use. Keeping the rheological profiles in mind one may predict which tissue adhesive is the best choice for the desired use. This information may aid a surgeon to decide which adhesive is most suitable for the targeted indication.

When used in our mechanical test setup, CA polymerized within seconds after coming into contact with fluid, but polymerisation between the two plates of the rheometer took considerably longer. This was true for all the CA except for Omnex, which integrates a polymerisation catalyst in the applicator and cures within a few minutes even in a "dry" environment. Furthermore, it should be noted that the rheological profiling of the PEG group was the most difficult in our experimental set-up, because of the very low grip of the hydrogels on the plates, the low modulus of the cured gels and the fast evaporation of water. Nevertheless, satisfactory results could be obtained in each case.

Rheology and mechanical testing

Both storage and loss modulus (the two moduli defining rheological profile of adhesive) were significantly correlated with each of the three mechanical tests. This finding indicates that the rheological characteristics of an adhesive can, in turn, predict its mechanical strength. As rheological tests are easily performed only requiring several drops of an adhesive, this technique may be promising in the future evaluation of tissue adhesives. Another interesting finding comes from the rheological profile of the Pattex

adhesive. Despite the highest values of G' and G'' , Pattex provided relatively low results in mechanical strength. This indicates that, in general, a tissue adhesive's mechanical strength may rely upon an 'optimum range' of G' and G'' which may not necessarily be the highest value of G'/G'' , in line with previous research on tissue adhesive rheology [14].

Study limitations

In this study we attempted to create intra-abdominal circumstances as closely as possible, simulating a physiologic environment for adhesive application. An *ex vivo* approach was chosen to be able to systematically test each tissue adhesive in a reproducible fashion and enable comparisons without confounding factors resulting from surgical intervention or wound healing. Naturally, *ex vivo* testing is clinically less relevant than *in vivo* testing, as the structural integrity of the bowel wall starts to degrade directly after resection. This problem was partly overcome by cooling the tissue in a preservation solution. Rat colon has been previously used by many researchers in the testing of tissue adhesives, and was therefore chosen as the substrate in this study. Another practical problem we encountered was that the application procedure was difficult as most applicators are non-interchangeable and meant for use in human colon, which, of course, is larger than the rat colon. Lastly, in this study we only observed the mechanical strength and rheology of *ex vivo* colonic segments, which does not provide information on the effects of the body's healing process on the adhesive, and also the effects of the adhesive on the tissue. This aspect should be examined in future studies.

Conclusion

In this study we have provided information on the adhesive strength and rheological characteristics of a comprehensive list of tissue adhesives spanning across all present-day adhesive categories. Modern-day cyanoacrylates are the strongest in terms of mechanical strength and form a homogeneous group based on rheological endpoints. Of the albumin-based adhesives, Covabond and Bioglue adhesives were also strong and showed rheological profiles similar to that of cyanoacrylates. From the polyethylene glycol group, Duraseal Xact and Coseal seemed to be promising in terms of mechanical strength. Fibrin glues

showed the lowest adhesive strength, with Tissucol providing slightly better results. The mechanical test results correlated to each other, implying that the choice of one single test contains sufficient information to evaluate the mechanical strength of a tissue adhesive. Importantly, in this study a standardized testing protocol was used enabling us to compare results between tissue adhesives in a methodologically appropriate manner. Rheological profiling of tissue adhesives aided in explaining differences in mechanical strength and in understanding the behavior of tissue adhesives. Furthermore, the rheological profiles of the tissue adhesives were significantly correlated to their mechanical strength, making it possible to predict mechanical strength by examining rheological endpoints. It could be recommended that the combination of mechanical and rheological data should become part of a standard testing protocol in future studies with tissue adhesives.

REFERENCES

1. Rousou, J.A., Use of fibrin sealants in cardiovascular surgery: a systematic review. *J Card Surg*, 2013. 28(3): p. 238-47.
2. Shiono, M., Surgery for acute aortic dissection using gelatin-resorcin-formalin glue: perspective from 10 years of follow-up at a single center. *J Artif Organs*, 2008. 11(1): p. 19-23.
3. Spotnitz, W.D., Fibrin sealant: past, present, and future: a brief review. *World J Surg*, 2010. 34(4): p. 632-4.
4. Ryou, M., Thompson C.C., Tissue Adhesives: A Review. *Techniques in gastrointestinal endoscopy*, 2006. 8: p. 33-37.
5. de Goede, B., et al., Meta-analysis of glue versus sutured mesh fixation for Lichtenstein inguinal hernia repair. *Br J Surg*, 2013. 100(6): p. 735-42.
6. Kingham, T.P. and H.L. Pachter, Colonic anastomotic leak: risk factors, diagnosis, and treatment. *J Am Coll Surg*, 2009. 208(2): p. 269-78.
7. Vakalopoulos, K.A., et al., Tissue adhesives in gastrointestinal anastomosis: a systematic review. *J Surg Res*, 2013. 180(2): p. 290-300.
8. Spotnitz, W.D. and S. Burks, State-of-the-art review: Hemostats, sealants, and adhesives II: Update as well as how and when to use the components of the surgical toolbox. *Clin Appl Thromb Hemost*, 2010. 16(5): p. 497-514.
9. Bae, K.B., et al., Cyanoacrylate for colonic anastomosis; is it safe? *Int J Colorectal Dis*, 2010. 25(5): p. 601-6.
10. Paral, J., et al., Suture-free anastomosis of the colon. Experimental comparison of two cyanoacrylate adhesives. *J Gastrointest Surg*, 2011. 15(3): p. 451-9.
11. Fransen, P., Reduction of postoperative pain after lumbar microdiscectomy with DuraSeal Xact Adhesion Barrier and Sealant System. *Spine J*, 2010. 10(9): p. 751-61.
12. Passage, J., et al., Bioglue: a review of the use of this new surgical adhesive in thoracic surgery. *ANZ J Surg*, 2005. 75(5): p. 315-8.
13. Reece, T.B., T.S. Maxey, and I.L. Kron, A prospectus on tissue adhesives. *Am J Surg*, 2001. 182(2 Suppl): p. 40S-44S.
14. Serrero, A., et al., Polysaccharide-based adhesive for biomedical applications: correlation between rheological behavior and adhesion. *Biomacromolecules*, 2011. 12(5): p. 1556-66.
15. Fung, Y.C., What principle governs the stress distribution in living organs? In: Fung, Y.C., Fukada, E., Junjian, *Biomechanics in China, Japan and USA*. Science, Beijing, China, pp. 1-13. . 1983.
16. ASTM Standard F2255-05, 2010: Standard Test Method for Strength Properties of Tissue Adhesives in Lap-Shear by Tension Loading. ASTM International, West Conshohocken, PA, 2010. DOI:10.1520/F2255-05R10(www.astm.org).
17. ASTM Standard F2256-05, 2010: Standard Test Method for Strength Properties of Tissue Adhesives in T-Peel by Tension Loading. ASTM International, West Conshohocken, PA 2010. DOI:10.1520/F2256-05R10.(www.astm.org.).
18. ASTM Standard F2258-05: Standard Test Method for Strength Properties of Tissue Adhesives in Tension. ASTM International, West Conshohocken, PA, 2010. DOI:10.1520/F2258-05R10.(www.astm.org).
19. Beam, J.W., Tissue adhesives for simple traumatic lacerations. *J Athl Train*, 2008. 43(2): p. 222-4.
20. Shazly, T.M., et al., Viscoelastic adhesive mechanics of aldehyde-mediated soft tissue sealants. *Biomaterials*, 2008. 29(35): p. 4584-91.

21. Sidle, D.M. and C.S. Maas, Determination of shear strength of periosteum attached to bone with BioGlue Surgical Adhesive. *Arch Facial Plast Surg*, 2008. 10(5): p. 316-20.
22. Azadani, A.N., et al., Mechanical properties of surgical glues used in aortic root replacement. *Ann Thorac Surg*, 2009. 87(4): p. 1154-60.
23. Kull, S., et al., Glubran2 surgical glue: in vitro evaluation of adhesive and mechanical properties. *J Surg Res*, 2009. 157(1): p. e15-21.
24. Sarna, S.K., Colonic motor activity. *Surg Clin North Am*, 1993. 73(6): p. 1201-23.
25. Isoda, S., et al., In vitro study of the optimum volume ratio of activator to adhesive in gelatin-resorcin-formalin glue. *Gen Thorac Cardiovasc Surg*, 2011. 59(5): p. 326-8.
26. Nishimori, H., A. Hata, and S. Sasaguri, Optimal application of gelatin-resorcin-formaldehyde glue with special reference to the quality of mixing. *Ann Thorac Surg*, 2000. 69(4): p. 1299.
27. Kanellos, I., et al., Effects of the use of fibrin glue around the colonic anastomosis of the rat. *Tech Coloproctol*, 2003. 7(2): p. 82-4.

Tables/ Figures

Table 1: Included tissue adhesives.

Adhesive category	Commercial name	Company	Composition
Cyanoacrylates	Histoacryl Flex	B.Braun (Tübingen, Germany)	n-butyl-2-cyanoacrylate
	Glubran 2	GEM Italia (Viareggio, Italy)	n-butyl-2-cyanoacrylate and methacryloxysulfolane
	Omnex	Ethicon (J&J, Bridgewater, NJ, USA)	2-octyl-cyanoacrylate and butyl lactoyl cyanoacrylate
	Dermabond	Ethicon (J&J, Bridgewater, NJ, USA)	2-octyl-cyanoacrylate
Albumin based adhesives	Biogluce	Cryolife (Kennesaw, GA, USA)	Glutaraldehyde-albumin glue
	Covabond	Covalent medical inc. (Ann Arbor, MI, USA)	Albumin, aldehyde cross linker
	GRF	Cardial SA (St. Etienne, France)	Gelatin-resorcinol-formaldehyde glue
Polyethylene glycol adhesives	Duraseal Xact	Covidien (Mansfield, MA, USA)	Polyethylene glycol, trisiline amine, blue dye, N-hydroxy succinimide
	Coseal	Baxter (Deerfield, IL, USA)	Polyethylene glycol, hydrogen chloride and sodium phosphate-sodium carbonate
	Duraseal	Covidien (Mansfield, MA, USA)	Polyethylene glycol, trisiline amine and blue dye
Fibrin glues	Tissucol	Baxter (Deerfield, IL, USA)	Fibrin glue, with aprotinin
	Evicel	Ethicon (J&J, Bridgewater, NJ, USA)	Fibrin glue, without aprotinin

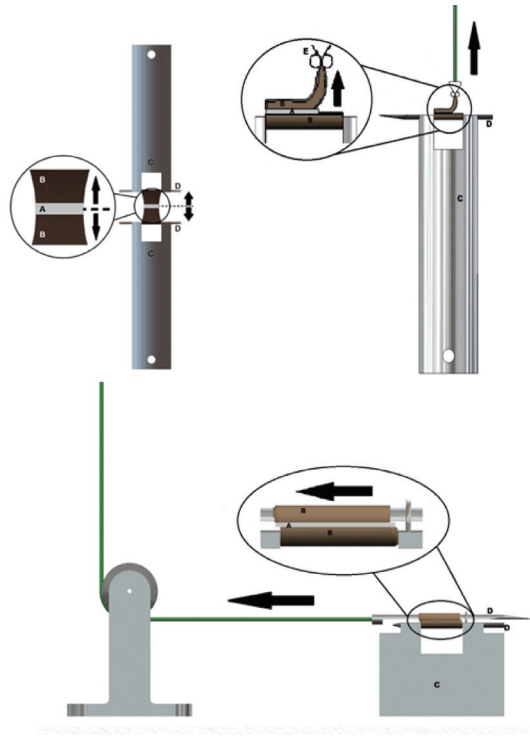
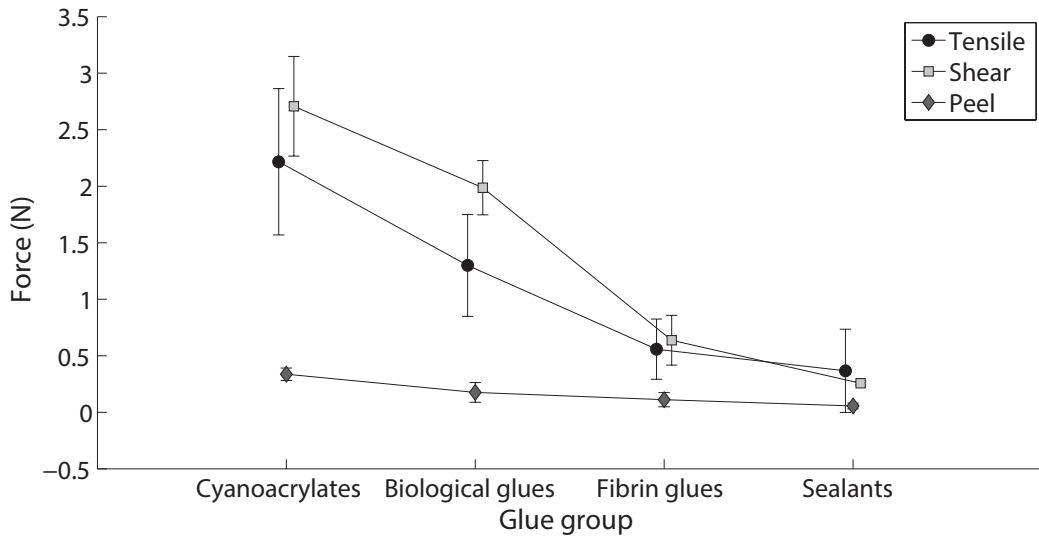

Figure 1: Experimental configuration, per test type. Arrows define direction of motion.

a: Tensile strength test. Legend: A: Glue. B: Colon segments. C: Cylinder. D: Colonic pin.

b: Peel strength test. Legend: A: Glue. B: Colon segments. C: Cylinder. D: Colonic pin. E: Clamp.

c: Shear strength test. Legend: A: Glue. B: Colon segment. C: Fixation device. D: Colonic pin.



Adhesive category	Tensile strength	Shear strength	Peel strength
CA vs AB	$t_{20} = 2.61$ ($P = 0.017$)	$t_{19} = 1.97$ ($P = 0.064$)	$t_{19} = 4.24$ ($P < 0.001$)
AB vs PEG	$t_{17} = -4.01$ ($P < 0.001$)	$t_{15} = -6.13$ ($P < 0.001$)	$t_{18} = -2.60$ ($P = 0.018$)
PEG vs FG	$t_{11} = 0.55$ ($P = 0.596$)	$t_{11} = 2.95$ ($P = 0.013$)	$t_{11} = 0.705$ ($P = 0.496$)

Figure 2: Mechanical adhesive strength between adhesive categories. Results of statistical analysis are shown in the table. CA: Cyanoacrylate. AB: Albumin based adhesives. PEG: Polyethylene glycol adhesives. FG: Fibrin glues.

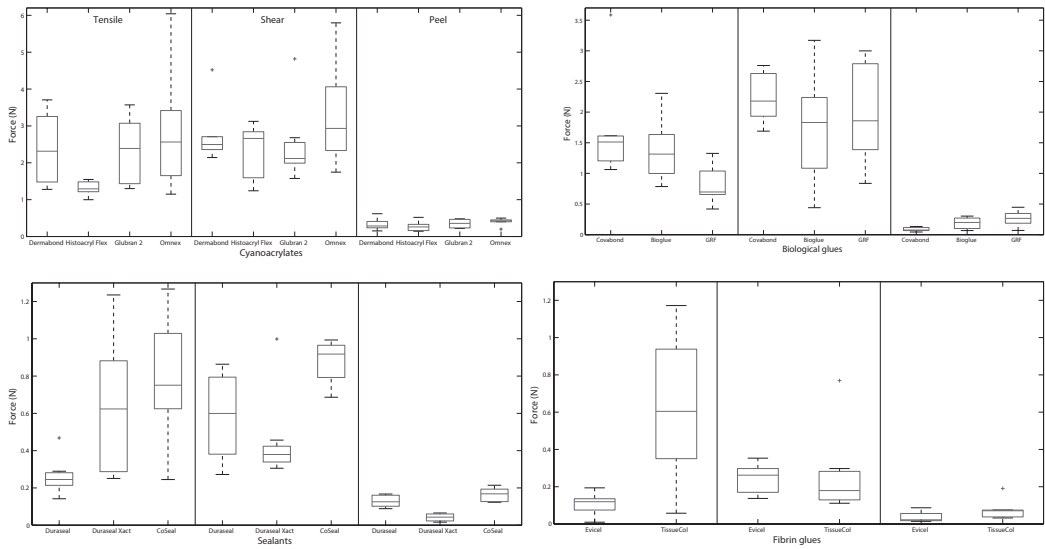

Adhesive categories	Tensile strength	Shear strength	Peel strength
CA	$F_{3,24} = 2.60$ ($P = 0.076$)	$F_{3,23} = 1.22$ ($P = 0.325$)	$F_{3,23} = 1.09$ ($P = 0.372$)
AB	$F_{2,22} = 5.61$ ($P = 0.011$)	$F_{2,19} = 0.74$ ($P = 0.491$)	$F_{2,18} = 6.23$ ($P = 0.009$)
PEG	$F_{2,15} = 5.17$ ($P = 0.020$)	$F_{2,14} = 5.29$ ($P = 0.020$)	$F_{2,17} = 32.68$ ($P = 0.001$)
FG	$t_6 = -3.19$ ($P = 0.019$)	$t_6 = -0.303$ ($P = 0.773$)	$t_6 = -1.53$ ($P = 0.176$)

Figure 3: Overview of tensile, shear and peel strength within each adhesive category; a) Cyanoacrylates, b) Albumin based adhesives, c) Sealants, d) Fibrin glues. Results of statistical analysis are shown in the table. CA: Cyanoacrylate. AB: Albumin based adhesives. PEG: Polyethylene glycol adhesives. FG: Fibrin glues.

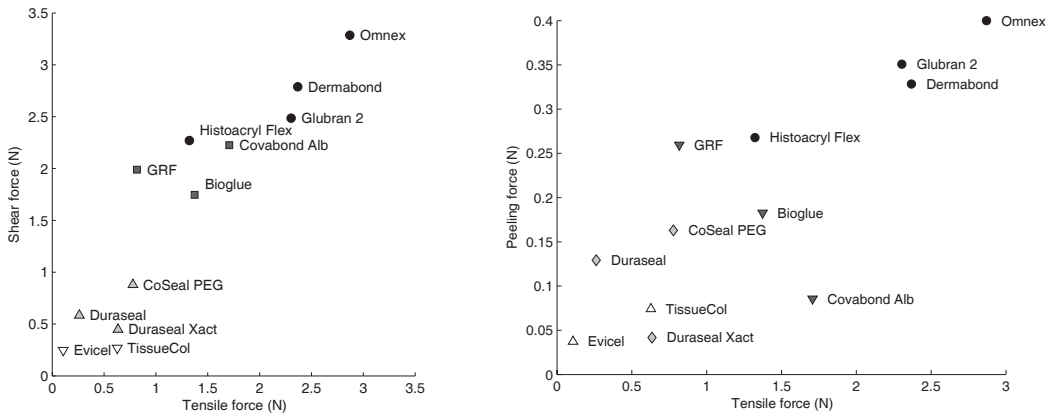

Figure 4: Correlation analyses. a) tensile strength test vs shear test; correlation coefficient $r = 0.504$ ($P < 0.001$). b) tensile strength vs peel test; $r = 0.578$ ($P < 0.001$).

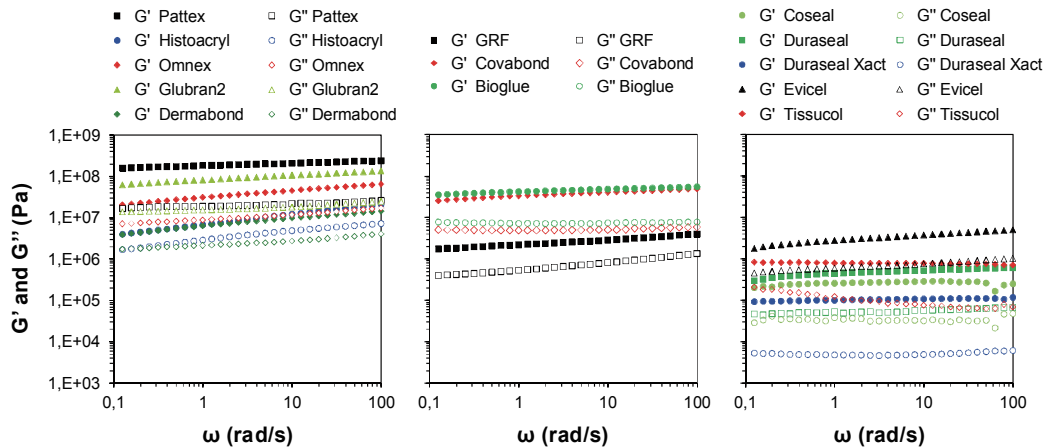

Figure 5. Frequency (ω) dependency of the real (G') and imaginary (G'') shear modulus components for: a) Pattex, Histoacryl, Omnex, Glubran and Dermabond. b) GRF, Covabond and Bioglue. c) Coseal, Duraseal, Duraseal Xact, EviceI and Tissucol.

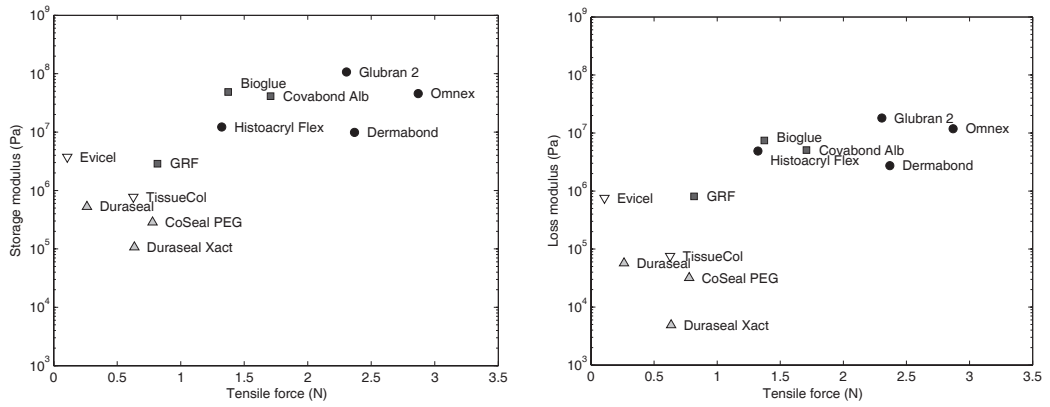

Figure 6: Correlation analysis between rheological results and tensile strength test. a) Storage modulus vs tensile strength; correlation coefficient $r = 0.711$ ($P < 0.001$). b) Loss modulus vs tensile strength; $r = 0.716$ ($P < 0.001$).

Chapter 7:

Reducing Anastomotic Leakage by Reinforcement of Colorectal Anastomosis with Cyanoacrylate Glue

Z. Wu, K.A. Vakalopoulos, L.F. Kroese, G.S.A. Boersema,
G-J. Kleinrensink, J. Jeekel, J.F. Lange

European Surgical Research, 2013 (published)

ABSTRACT

Introduction: Technical failure of sutured or stapled anastomoses may lead to anastomotic leakage (AL), which is one of the most important complications after colorectal surgery. Cyanoacrylate glue (CA) provides strong mechanical attachment, making it a good candidate for suture reinforcement. This study aimed to demonstrate that CA is the most important factor in the strength of a sealed colorectal anastomosis, in both normal and insufficient anastomoses.

Methods: Ex-vivo porcine colorectal segments were resected. A one-layer continuous anastomosis or an insufficient 6 interrupted-suture anastomosis was created, and the baseline anastomotic bursting pressure (ABP) was measured. The primary anastomosis was then reinforced either by CA or with 4 additional interrupted sutures, further inverting the anastomosis. After reinforcement a second ABP test was performed.

Results: Thirty-two segments were used. Reinforcing the anastomosis by CA

significantly increased ABP in both normal and insufficient anastomosis when compared to the primary anastomosis ($p < 0.05$ for all groups); no significant difference in ABP was found between normal and insufficient anastomosis groups after CA reinforcement. Anastomotic reinforcement with CA was not inferior to the reinforcement with sutures in both normal and insufficient anastomoses, and had significant less ABP variances in normal anastomosis groups ($p = 0.042$).

Conclusion: Reinforcing a colorectal anastomosis with CA increases its mechanical strength in both normal and technically insufficient situations, which may contribute to the reduction of anastomotic leakage. CA is promising for anastomotic reinforcement based on mechanical improvement of the anastomosis and in-vivo studies are needed to evaluate its biological effects.

INTRODUCTION

Anastomotic leakage (AL) is one of the most important complications in gastrointestinal (GI) surgery. Especially in ultra-low colorectal anastomosis, a higher rate of leakage has been observed, which varies from 8% to 20% [1] and leads to a mortality as high as 33% [2]. The etiology of AL is still not yet fully understood. Several mechanisms and risk factors are known to contribute to its occurrence [3-5]. Of these, the most important are considered to be technical failure and ischemia [6].

In order to reduce the incidence of AL, substantial surgical techniques have been tested [7, 8]. One recent research from Gadiot et al. indicated that supportive sutures of laparoscopic left-sided anastomosis might significantly reduced AL rate [9]. In this technique, three interrupted supportive sutures were circumferentially placed parallelly to the primary anastomosis. They offered sufficient additional strength to protect the primary anastomosis from mechanical stress, thus preventing the occurrence of AL. However, hand-sewn suturing for low-level colorectal surgery is technically challenging and hence requires a longer learning curve, which may slow its further implementation in clinical practice.

Cyanoacrylate glue is now becoming increasingly popular in surgery for different indications [10]. It has been shown to provide strong mechanical attachment and polymerize

quickly within 30 to 60 seconds after application [11]. Clinical practice showed promising results on the use of CA as a sealant after primary anastomosis in pancreaticoduodenectomy [12]; experimental studies also used CA to create sutureless colorectal anastomoses [13]. These results suggested that CA seemed to be a promising alternative to supportive sutures in low colorectal anastomosis.

In this study, we used CA to reinforce normal and insufficient colorectal anastomoses in an ex-vivo porcine model. We aimed to demonstrate that CA is the most important factor and is responsible for the anastomotic strength of an invertedly reinforced anastomosis, regardless of the primary anastomosis being normal or insufficient.

METHODS

Animals

Distal colon segments of 10-15 cm in length were resected from male Yorkshire pigs (6 months old, 90-100 kg) from a local slaughterhouse, directly after euthanasia by CO₂ overdose. The specimens were flushed using tap water and preserved in a phosphate-buffer solution, and then immediately transported to the laboratory in the medical center. All experiments were then performed within 6 hours after euthanasia.

Primary anastomosis

The experimental methodology is depicted in figure 1. During the first part of the experiment a primary anastomosis was constructed in an end-to-end, inverting way using synthetic suture (3/0 Vicryl, Ethicon, J&J, USA). In the normal anastomosis group (NG), a continuous one-layer anastomosis was created. Bite size was 5 mm from the colonic edge and subsequent sutures were placed at 5 mm intervals. In the insufficient anastomosis group (IG), six equidistant interrupted sutures were placed equally around the circumference with 5 mm bite size. After that, the first anastomotic bursting pressure (ABP) test was performed.

Anastomotic reinforcement

The anastomosis was subsequently reinforced with either CA or sutures. In the suture-

reinforced groups, the anastomosis was reinforced with four supportive sutures (3/0 Vicryl, Ethicon, J&J, USA). These supportive sutures were placed equidistantly around the anastomosis, further inverting the primary anastomosis. Sutures were placed submucosally at 5 mm of either side of the primary anastomosis, and the bite size was also 8 to 10 mm.

In the CA-reinforced groups, 2-octyl-cyanoacrylate glue (Dermabond, Ethicon, J&J, USA) was used to reinforce the anastomosis. One capsule (0.5 mL) of Dermabond was used to form a continuous glue bond around each primary anastomosis. The CA was applied on one side of the primary anastomosis, 10 to 15 mm in length along the anastomosis and 5 mm in width; then forceps were used to approximate two serosal edges, which further inverted the anastomosis for 5 mm (the width of CA). This procedure was repeated several times until the whole primary anastomosis was reinforced. The schematic overview is depicted in figure 2. After CA application, a waiting time of five minutes was set to ensure full polymerization.

After reinforcement with either CA or sutures, the second ABP test was performed again following the below described protocol.

Anastomotic bursting pressure test

An air-infusing probe was introduced into the proximal end of the colonic segment. Both bowel ends were then ligated to ensure an airtight compartment. The specimen was submerged in a tank filled with tap water and air was infused through the probe at a rate of 99 ml/hour via an automatic syringe pump (Perfusor Secura, B. Braun, DL). The setup was connected to a digital pressure indicator (DPI 101, Druck, Leicester, UK). Two researchers observed the anastomosis for signs of anastomotic leakage (i.e. air bubbles from the anastomosis). The pressure at the time of the first leakage of air was defined as the anastomotic bursting pressure (ABP) and noted.

Statistical analysis

Data were shown in the form of mean \pm standard deviation (S.D.). Statistical analysis was performed using SPSS 17.0 (SPSS, Chicago, IL, USA). Data were analyzed using Wilcoxon Signed ranks, Mann-Whitney, and nonparametric Levene's tests according to proper indications. A p-value of 0.05 or less was chosen to define statistical significance.

RESULTS

Overall, 32 colon specimens were used. Sixteen of them were used for the creation of a one layer continuous anastomosis: the normal anastomosis group (NG). The NG was divided into two groups of eight specimens; in one group the anastomoses were reinforced with cyanoacrylate glue (NGG), and in the other group the anastomoses were reinforced with four supportive sutures (NGS). The other 16 specimens were used to create an insufficient six-suture anastomosis: the insufficient anastomosis group (IG). Again, two groups of eight specimens were made, one with reinforcement of CA (IGG) and the other with sutures (IGS).

All the anastomoses burst at the anastomotic site during the ABP test. As is shown in figure 3, the mean ABP of the primary anastomosis was significantly higher in NG (32.5 ± 14.7 mmHg) than in IG (12.5 ± 5.0 mmHg, $p = 0.000$, Mann-Whitney test); the respective ABP in NGG, NGS, IGG and IGS groups were 48.2 ± 13.0 mmHg, 65.1 ± 27.6 mmHg, 39.0 ± 9.9 mmHg and 57.6 ± 18.8 mmHg. Reinforcing the primary anastomosis with CA significantly increased ABP in both normal and insufficient anastomosis groups (NGG / NG, $p = 0.012$; IGG / IG, $p = 0.012$, Wilcoxon Signed Ranks Test); no significant difference in ABP was found between normal and insufficient anastomosis groups after CA reinforcement (NGG / IGG, $p = 0.161$, Mann-Whitney test). Similar results were also found in suture-reinforced groups.

The CA-reinforced anastomoses had similar ABP values to the suture-reinforced anastomoses in normal anastomosis groups (NGG / NGS, $p = 0.195$, Mann-Whitney test), while the ABP variances were significantly less in CA-reinforced group (NGG / NGS, $p = 0.042$, nonparametric Levene's test). Similar ABP between CA- and suture-reinforced anastomoses also was found in the insufficient anastomosis groups, including similar ABP variances (IGG / IGS, $p = 0.065$, Mann-Whitney test; $p = 0.248$, nonparametric Levene's test).

The ABP of the insufficient anastomoses reinforced with CA was higher (but not significant) than that of the normal anastomosis group (IGG / NG, $p = 0.136$, Mann-Whitney test).

DISCUSSION

Despite many years of research and countless technical alterations, leakage remains a major problem after creation of a colorectal anastomosis. Previous studies revealed that the strength of skin closure with CA approximates that of closure with 5/0 sutures [11]. In concordance with this finding, we found that with a limited amount (0.5 mL), CA reinforcement significantly increased the anastomotic bursting pressure in both normal and insufficient colorectal anastomoses with less variance, and it was not inferior to the suture reinforcement. Even in the insufficient anastomoses, CA reinforcement still provided good anastomotic strength, which was slightly higher than the standard one-layer sutures, although this difference was non-significant. These results indicate that strong anastomotic strength could be guaranteed after CA application regardless of the strength of the primary anastomosis. Furthermore, this strength comes into effect immediately after its application around the anastomosis, which may contribute to the prevention of AL caused by technical failure.

Previous clinical work introduced the concept of inverted suture reinforcement in colorectal anastomosis to prevent the occurrence of AL [9]. This concept was quite promising because of the significant reduction of AL rate, yet suture reinforcement does have several shortcomings in practice. Firstly, the technique of sub-mucosal suturing may be difficult to perform, especially in ultra-low anastomoses. Its strength relies on the skill of the surgeon, which may vary according to experience, and has been known to affect the incidence of leakage [14]. Secondly, due to individual variations between patients, it may also be challenging to decide how many sutures are needed and how to space them equidistantly, especially if an extra suture is needed to ensure the full inversion. Lastly, creating a second layer of reinforcement sutures is a time consuming process, which was already addressed previously in the comparison of single- and double-layer colorectal anastomosis [15]. In our current experimental setup, we found these problems might be overcome with the use of CA. Firstly, CA reinforcement significantly reduced ABP variances when compared with the suture reinforcement, indicating that CA application was more standardized. Also, different from interrupted sutures, CA provided an equally

distributed seal around the whole circumference of the anastomosis. Lastly, CA application was easier and faster than hand-suture technique, and it might be further improved if a specific applicator would be developed in the future.

Cyanoacrylate use in gastrointestinal surgery is still limited. Although its application in sealing vascular [16] and pancreaticoduodenal [12] anastomosis showed promising results, CA reinforcement of a primary anastomosis has not been widely accepted in intestinal or colorectal surgery. Most comments on CA reinforcement focus on its negative biological effects such as an increased tissue reaction, which may counteract its mechanical effects [17, 18]. Certainly, CA's biological characteristics determine the late outcomes such as tissue reaction and wound healing after its application; however technical aspects during application also influence these outcomes.

When comparing experimental methods among different studies, some technical differences, which might partly explain the inconsistent results between those studies, were noticed. For instance, the amount of CA used in our porcine model was 0.5 mL per anastomosis, while in other rat studies 0.2 mL or 0.5 mL of CA was applied [18, 19]. Furthermore, most other studies did not specify the CA amount they used. Comparing the size of a porcine colon with a rat colon, one can imagine that the required CA amount is much smaller in the latter. Only 0.4 μ L (0.0004 mL) CA was enough to create a vessel anastomosis in a previous rat model [20]. In our previous work, we found that 0.02 mL CA was already enough to seal a primary anastomosis in a rat model, leading to a sufficient clinical and histological healing (unpublished data from our group). Conversely, overdose of CA may lead to more side effects, such as increased inflammatory response and adhesion formation [21], rather than a further increase in bursting pressure. Besides CA dosage, inversion of a gastrointestinal anastomosis has been considered as a key factor in anastomotic healing [22], and was also essential to the reinforcement technique discussed in this study. Some previous studies reported a leakage rate of 34% in everting CA sealed anastomoses [23, 24]; while in another study, no leakage and good wound healing was found when a modified circular stapler was used to create inverted anastomoses sealed with CA [13]. These aspects and other technical details of CA's application should also be taken into consideration for AL studies. For that, ex-vivo tests prior to in-vivo models might help to determine the least possible CA amount, the best suturing technique, and other details to achieve a strong and immediate anastomotic strength. Afterwards, the biological effects can be evaluated in in-vivo models.

Due to our current experimental test setup, there are still some limitations in our study. First, as mentioned above, the method of CA application in this study, though easy, is still not yet practical for widespread clinical implementation; instruments for CA's application, especially in laparoscopy, are needed. Also, surgical staplers are widely used in GI anastomosis now. Inclusion of CA reinforcement after stapling would further improve the integrity and clinical relevance of this experiment. Lastly, we used ex-vivo porcine segments because they were easily available and inexpensive, but the non-vital period up to 6 hours, though relatively short, might still influence the colon's biomechanical properties. In-vivo tests will be necessary to minimize those effects and, furthermore, to determine the biological effects of CA reinforcement.

CONCLUSION

In conclusion, Cyanoacrylate reinforcement increased the bursting pressure of colorectal anastomoses in both normal and technically insufficient anastomoses; as hypothesized, a reinforced anastomosis derived most of its biomechanical strength from CA reinforcement, regardless of the primary anastomotic configuration. The use of CA as a supportive agent may contribute to the reduction of AL and is promising for suture replacement, while in-vivo studies are needed for further implementation.

REFERENCES

1. Kingham, T.P. and H.L. Pachter, Colonic anastomotic leak: risk factors, diagnosis, and treatment. *J Am Coll Surg*, 2009. 208(2): p. 269-78.
2. Suturing or stapling in gastrointestinal surgery: a prospective randomized study. West of Scotland and Highland Anastomosis Study Group. *Br J Surg*, 1991. 78(3): p. 337-41.
3. Bertelsen, C.A., et al., Anastomotic leakage after anterior resection for rectal cancer: risk factors. *Colorectal Dis*, 2010. 12(1): p. 37-43.
4. Taflampas, P., M. Christodoulakis, and D.D. Tsiftsis, Anastomotic leakage after low anterior resection for rectal cancer: facts, obscurity, and fiction. *Surg Today*, 2009. 39(3): p. 183-8.
5. Komen, N., et al., Calcium score: a new risk factor for colorectal anastomotic leakage. *Am J Surg*, 2011. 201(6): p. 759-65.
6. Buunen, M., et al., Level of arterial ligation in total mesorectal excision (TME): an anatomical study. *Int J Colorectal Dis*, 2009. 24(11): p. 1317-20.
7. Van Deurzen, D.F., G.H. Mannaerts, and J.F. Lange, Technique for instant stapling of the sigmoid mesentery and mesorectum in laparoscopic colorectal surgery. *Surg Endosc*, 2006. 20(11): p. 1778-9.
8. Ho, Y.H. and M.A. Ashour, Techniques for colorectal anastomosis. *World J Gastroenterol*, 2010. 16(13): p. 1610-21.
9. Gadiot, R.P., et al., Reduction of anastomotic failure in laparoscopic colorectal surgery using antitraction sutures. *Surg Endosc*, 2011. 25(1): p. 68-71.
10. Leggat, P.A., D.R. Smith, and U. Kedjarune, Surgical applications of cyanoacrylate adhesives: a review of toxicity. *ANZ J Surg*, 2007. 77(4): p. 209-13.
11. Spotnitz, W.D. and S. Burks, Hemostats, sealants, and adhesives III: a new update as well as cost and regulatory considerations for components of the surgical toolbox. *Transfusion*, 2012. 52(10): p. 2243-55.
12. Barakat, O., C.F. Ozaki, and R.P. Wood, Topically Applied 2-Octyl Cyanoacrylate (Dermabond) for Prevention of Postoperative Pancreatic Fistula After Pancreaticoduodenectomy. *J Gastrointest Surg*, 2012.
13. Paral, J., et al., Suture-free anastomosis of the colon. Experimental comparison of two cyanoacrylate adhesives. *J Gastrointest Surg*, 2011. 15(3): p. 451-9.
14. Boccola, M.A., et al., Reducing anastomotic leakage in oncologic colorectal surgery: an evidence-based review. *Anticancer Res*, 2010. 30(2): p. 601-7.
15. Sajid, M.S., M.R. Siddiqui, and M.K. Baig, Single layer versus double layer suture anastomosis of the gastrointestinal tract. *Cochrane Database Syst Rev*, 2012. 1: p. CD005477.
16. Akhtar, M.S., Use of cyanoacrylate compounds in vascular anastomosis. *J Plast Reconstr Aesthet Surg*, 2010. 63(6): p. 1063-4.
17. Irkorucu, O., et al., Effect of 2-octyl-cyanoacrylate on ischemic anastomosis of the left colon. *J Invest Surg*, 2009. 22(3): p. 188-94.
18. Nursal, T.Z., et al., The effect of tissue adhesive, octyl-cyanoacrylate, on the healing of experimental high-risk and normal colonic anastomoses. *Am J Surg*, 2004. 187(1): p. 28-32.
19. Kayaoglu, H.A., et al., Effect of n-butyl-2-cyanoacrylate on high-risk colonic anastomoses. *Kaohsiung J Med Sci*, 2009. 25(4): p. 177-83.
20. Wei, W., et al., Cyanoacrylate-assisted arterial anastomosis in rat small bowel transplantation. *Langenbecks Arch Surg*, 2010. 395(6): p. 727-35.
21. Bae, K.B., et al., Cyanoacrylate for colonic anastomosis; is it safe? *Int J Colorectal Dis*, 2010. 25(5): p. 601-6.
22. Trueblood, H.W., et al., Wound healing in the colon: comparison of inverted and everted closures. *Surgery*, 1969. 65(6): p. 919-30.
23. Weilbaecher, D.A., F.J. Mathieu, and I. Cohn, Jr., Nonsuture Intestinal Anastomosis. *Am J Surg*, 1964. 107: p. 353-60.
24. Weilbaecher, D.A., C.T. Stirling, and F.J. Mathieu, Nonsuture intestinal anastomosis. *Bull Soc Int Chir*, 1966. 25(2): p. 125-36.

FIGURE LEGEND

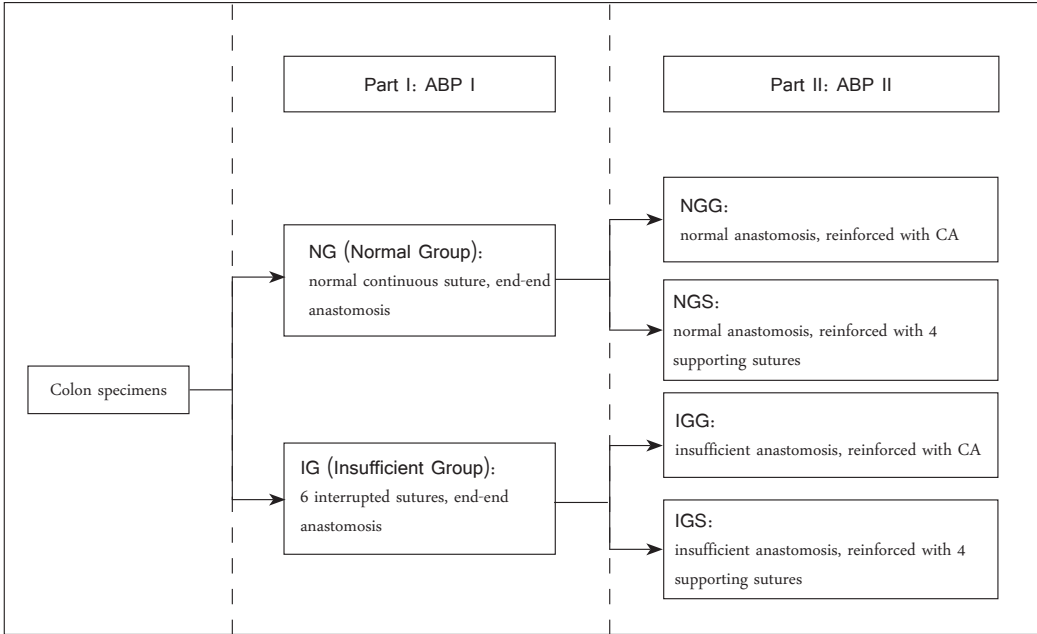

Figure 1. Flow chart of methodology

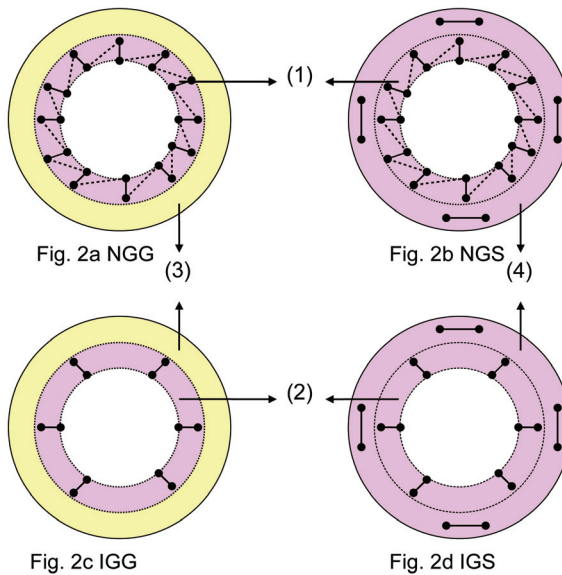

Figure 2. Cross-sectional view of anastomoses with reinforcement (Schematic). Primary anastomoses: (1) Normal one layer continuous sutures, (2) Insufficient 6 sutures; Reinforcement: (3) CA reinforcement ; (4) Suture reinforcement.

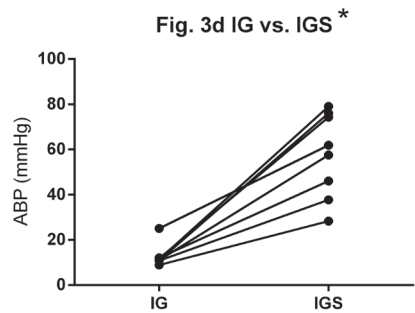
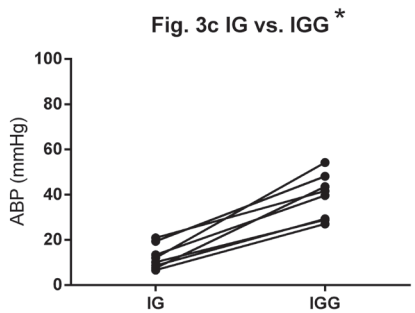
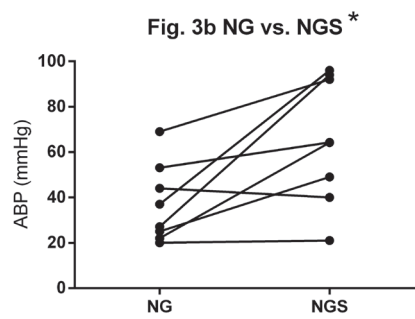
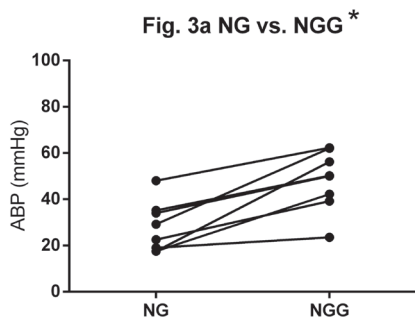

Figure 3. ABP (mmHg) before and after reinforcement. 3a. Normal anastomosis before and after CA reinforcement (27.9 ± 10.8 mmHg vs. 48.2 ± 13.0 mmHg, $p = 0.012$); 3b. Normal anastomosis before and after suture reinforcement (37.2 ± 17.3 mmHg vs. 65.1 ± 27.6 mmHg, $p = 0.025$); 3c. Insufficient anastomosis before and after CA reinforcement (12.3 ± 5.3 mmHg vs. 39.0 ± 9.9 mmHg, $p = 0.012$); 3d. Insufficient anastomosis before and after suture reinforcement (12.7 ± 5.0 mmHg vs. 57.6 ± 18.8 mmHg, $p = 0.012$). * $p < 0.05$ (Wilcoxon Signed Ranks Test).

The Prevention of Colorectal Anastomotic Leakage with Tissue Adhesives in a Contaminated Environment is Associated with the Presence of Anti-Inflammatory Macrophages

Z. Wu, K.A. Vakalopoulos, G.S.A. Boersema, L.F. Kroese, K.H. Lam, P. H van der Horst, I.M. Mulder, Y.M. Bastiaansen-Jenniskens, G-J. Kleinrensink, J. Jeekel, J.F. Lange

ABSTRACT

Background: Colorectal anastomoses created in a contaminated environment result in a high leakage rate. This study investigated whether using anastomotic sealants (TissuCol®, Histoacryl® Flex, and Duraseal®) prevents leakage in a rat peritonitis model.

Study Design: Sixty-seven Wistar rats were divided into control and experimental groups (TissuCol-, Histoacryl-, and Duraseal-group). Peritonitis was induced one day before surgery with the caecal ligation puncture model. On day 0, colonic anastomosis was constructed with sutures and then sealed with no adhesive (control group) or one select adhesive (experimental groups). Bursting pressure, abscess formation and adhesion severity were evaluated on day 3 or day 14. Hematoxylin and eosin staining and immunohistochemical staining for CD4, CD8, CD206 and iNOS were performed.

Results: On day 3 bursting pressures of the TissuCol-group (120.1 ± 25.3 mmHg), Histoacryl-group (117.3 ± 20.2 mmHg), and Duraseal-group (123.6 ± 35.4 mmHg) were

significantly higher than the control-group (24.4 ± 31.7 mmHg, $p < 0.001$). Abscesses around the anastomosis were found in the control-group (6/7) and Duraseal-group (2/9), but not in the TissuCol-group or Histoacryl-group. A higher number of CD206+ cells (M2-macrophages), a lower number of iNOS+ cells (M1-macrophages), a higher M2/M1 index, and a higher CD4+/CD8+ index were seen at the anastomotic site in all experimental groups compared with the control group on day 3. On day 14 abscesses were only found in the control group. Adhesion severity in the Duraseal-group was significantly lower than that in the control group ($p = 0.001$).

Conclusions: Anastomotic sealing using TissuCol®, Histoacryl® Flex, or Duraseal® seems to be an effective and safe option to prevent leakage in contaminated colorectal surgery. The presence of large numbers of anti-inflammatory macrophages seems to be involved in preventing the leakage.

INTRODUCTION

Under certain conditions such as abdominal trauma or perforation in diverticulitis and colorectal carcinoma, emergency surgery is initiated in order to repair bowel defects in a contaminated environment. Instead of a Hartmann's procedure for perforated diverticulitis, primary anastomosis has become a well-accepted intervention in selected patients [1-4], resulting in similar or even better clinical outcomes regarding postoperative mortality and complication rates than Hartmann's procedure [1, 5, 6]. However, performing primary anastomosis in a contaminated environment is challenging and still causes substantial leakage [7-9], especially in urgent situations. Patients with perforated diverticulitis who underwent primary anastomosis alone suffered a leakage rate of 19.3% [10], which is much higher than the leakage rate of approximately 9% following a low anterior resection for rectal cancer [11].

Intra-abdominal sepsis induces nitric oxide production at the anastomotic site, which activates substantial inflammatory responses and subsequently impairs the collagen synthesis thereby delaying anastomotic healing [12, 13]. Macrophages are one of the main factors in the inflammatory response, and based on their behavior this response is either pro-

inflammatory (M1) impairing wound healing or anti-inflammatory (M2) promoting wound healing; other immune cells such as T lymphocytes, though not fully understood, were also reported to be involved in the response [14]. Interestingly, the deleterious influence of inflammation is localized on the anastomosis and does not affect new collagen synthesis in the uninjured colon, where the biological barrier is intact [12]. This suggests that using a tissue adhesive or sealant as an artificial barrier to obstruct contact between intra-abdominal pathogens and anastomosis may reduce the deleterious effects of inflammation, thus preventing anastomotic leakage. Among different tissue adhesive compounds, fibrin glue and cyanoacrylate glue have been substantially investigated in both experimental and clinical studies with promising results [15-17]. Other sealants, such as polyethylene glycol glue, also had satisfactory results as an adhesion barrier system [18]. These tissue adhesives have been tested in different environments [17, 19, 20], however knowledge regarding their influence on anastomotic healing in a contaminated environment is still limited. We therefore conducted an experiment under conditions of peritonitis induced by the rat caecal ligation puncture (CLP) model that has been used in previous studies [21, 22]. Colonic anastomoses were constructed and sealed with select tissue adhesives. This study aimed to investigate the influence of the select tissue adhesives on anastomotic healing, and to determine whether they are safe and effective solutions to prevent anastomotic leakage under contaminated conditions.

METHODS

Animals

Male Wistar rats, weighing 250-350 grams, were purchased from a licensed breeder (Harlan Laboratories, Boxmeer, the Netherlands). All rats were bred under specific pathogen-free conditions, and kept under standard laboratory conditions. Standard rat chow and water were supplied ad libitum. The research protocols of all experiments were approved by the Ethical Committee on Animal Experimentation of Erasmus University Rotterdam.

Peritonitis model

To induce peritonitis, the rat caecal ligation puncture (CLP) model was used [21, 22]. In brief, rats were anaesthetized with isoflurane/oxygen inhalation, and the abdomen was opened through a midline incision. Then, the caecum was ligated distally to the ileocecal valve with a non-absorbable nylon suture (Ethilon 4-0, Ethicon, Somerville, USA), maintaining the continuity of the bowel. The distal caecum was punctured once with an 18-gauge needle, and was gently compressed until feces were extruded. The abdomen was closed with two layers of running sutures (Safil 5-0, B Braun, Melsungen, Germany). Wellness of all rats was evaluated during the follow-up, and animal with severely compromised wellness (i.e. ceased food intake, circulatory or respiratory difficulty, severe weight loss, severely abnormal locomotion) would be euthanized and examined prematurely for humane endpoint.

Surgical technique and follow up

hours later, the rat was anesthetized again. The abdomen was reopened, and a culture swab was taken to confirm peritonitis. After that, 6 mg/kg of gentamicin (Centrafarm, Etten-Leur, The Netherlands) was injected intramuscularly. The ligated caecum was resected, the abdominal cavity was rinsed with at least 20mL phosphate buffered saline (PBS, 37°C), and colorectal anastomosis was performed afterwards. A colon segment of 1 cm in length was resected approximately 3 cm proximally to the peritoneal reflection. An end-to-end one-layer continuous anastomosis was constructed in an inverted fashion with Dafilon 8-0 (B. Braun, Melsungen, Germany). One researcher (ZW) performed all anastomoses under microscopic vision enhancement. Following that, one tissue adhesive was selected and applied at two parts: at the descending colon around the anastomosis as a sealant (distal segment), and 1 cm in length at the beginning of the ascending colon (proximal segment). The tissue adhesives were prepared according to the instruction manuals. Because all tissue adhesive were designed for human patient with much larger amount of adhesive than the amount we applied on rats, one tissue adhesive was randomly chosen on the operation day and reused within the manual-instructed time period until reaching the planned group size. If necessary, a blunt needle was used to guide an accurate adhesive application around the anastomosis. The average amount of applied tissue adhesive is listed in Table 1. According to the applied tissue adhesive, rats were divided into the control group, TissuCol-group,

Histoacryl-group, and Duraseal-group. To ensure full polymerization of tissue adhesives after application, we allowed the adhesives to set for five minutes before closing the abdomen with a running suture (Safil 5-0, B Braun, Melsungen, Germany).

On postoperative day (POD) 3 or POD14, rats were anesthetized again and re-laparotomy with a U-shape incision was performed. The abdomen was examined for manifestations of abscess formation, anastomotic dehiscence, and adhesions. Adhesion severity was recorded using the Zühlke score [23]. Bursting pressure was determined afterwards, and the bursting location was noted. The samples from the distal and proximal segments were harvested for histological examination, then the rat was euthanized.

Histology and immunohistochemistry

All the harvested segments were fixed overnight in 4% buffered formaldehyde and embedded in paraffin. The distal samples were cut longitudinally and the proximal samples were cut transversely, both in a depth of 5 micrometers. Hematoxylin and eosin (HE) staining was performed in all samples.

Three parameters including inflammatory cell infiltration, fibroblast activity, and collagen deposition at the anastomotic site were evaluated for all the HE stained distal samples. For each parameter a ranking was made for all the slides with the following strategy: first, one researcher (ZW) and one pathologist (KL) performed a blind evaluation of each slide under a microscope using the Ehrlich and Hunt numerical scale as modified by Phillips et al. [24]. After scoring, a ranking was made within the slides having the same score by cross-comparing the slides. Then the slides on the margin of each score were compared and adjusted again (e.g. compare highest ranked ones with score 1 with lowest ranked ones with score 2). Finally all the ranked slides were consecutively rearranged (sorted from the lowest to highest rank) and minor modifications were made if necessary.

Immunohistochemical staining for CD4 (T helper cells), CD8 (T suppressor cells), CD20 (B lymphocytes), iNOS (M1-macrophages), and CD206 (M2-macrophages) was performed on distal samples. The slides were first deparaffinized and boiled in Tris/EDTA pH 9.0 for 15 min. Endogenous peroxidase activity was blocked with 1.5% H₂O₂ in PBS for 10 min. Slides were blocked for 30 min with a 5% non-fat dry milk in PBS solution. The primary antibody of CD4 (1:100, Emelca Bioscience, Breda, Netherlands), CD8 (1:200, AbD Serotec, Kidlington, UK), CD20 (1:100, Emelca Bioscience, Breda, Netherlands), CD206 (1:400, Abcam plc,

Cambridge, UK), or iNOS (1:1600, Abcam plc, Cambridge, UK) was applied respectively, and the slides were incubated overnight at 4°C. On the second day the slides were washed with PBS, and subsequently incubated with Envision secondary rabbit-anti-mouse or rabbit-anti-rabbit antibody (DAKO, Glostrup, Denmark) for 30 min. Diaminobenzidine (DAKO, Glostrup, Denmark) was used for visualization of antigen-antibody reactivity. Finally all slides were counterstained with hematoxylin, dehydrated and mounted.

A blinded investigator using a microscope under 40x10 magnification counted the positive cell amount of each staining. For the anastomotic site, three fields were selected: one on each cutting edge, the other one on the interface. For the serosa-glue site, three fields were also chosen at the interface of the tissue adhesive and adjacent tissue; in the control group, three fields were chosen at the interface of adhesion and adjacent tissue. The number of positive cells for each staining was counted, and the average of the three fields was used for analysis. An M2/M1 index was calculated with the equitation blew. A natural logarithm was used to adjust the data from exponential distribution into linear distribution. A similar equitation was also used for the CD4/CD8 index.

Statistical analysis

Statistical analysis was performed with SPSS 21.0 (IBM software, USA). Data were presented as mean (S.D.) or percentage. The one-way analysis of variance was performed with the Kruskal Wallis Test or Chi-square Test, and a p-value < 0.05 was considered to indicate statistical significance. In multiple comparisons, α was corrected with the number of comparisons with the following formula: $\alpha' = \alpha / N$ ($\alpha = 0.05$, $N =$ number of comparisons). When a significant difference was reached in the Kruskal Wallis Tests, multiple comparisons were made between the control group and each corresponding tissue adhesive the Mann-Whitney U Tests or Chi-square Tests in this study, so $N = 3$ was chosen for correction. Only a p'-value < 0.017 (0.05/3) was considered to indicate statistical significance in the multiple comparisons. All reported p-values were two-sided.

RESULTS

A total number of 67 rats were used in the experiment and seven rats (10.4%) died

during follow-up. Six deaths occurred on the day of the operation due to septicemia, but no anastomotic related complications were observed during autopsy. One rat had bloody stools after its operation and died on POD3, with its autopsy showing abscess formation on the anastomosis. There was no statistical difference in mortality rate between groups (Table 1).

After induction of fecal peritonitis with CLP model, all rats manifested septic symptoms such as compromised activities, nasal/ocular exudates, fluffy hair, diarrhea and weight loss, but no rat was prematurely euthanized for humane endpoint. On the operation day, weight loss were seen in all rats with an average of 10 to 12 grams in each group; no significant difference was found between groups. Abdominal fecal peritonitis were observed in all rats, manifesting as existence of ascites with fecal content. Abdominal culture tests of the ascites further confirmed bacterial contamination with Gram-positive (e.g. Enterococcus, Staphylococcus) and Gram-negative (e.g. Escherichia coli, Proteus) flora.

Intra-abdominal observations

On POD3, anastomotic dehiscence occurred in 28.6% (2/7) of rats in the control group, but not in other groups. Abscesses on the anastomosis was found in 85.7% (6/7) of rats in the control group, 22.2% (2/9) of rats in the Duraseal-group, but not in the TissuCol-group or Histoacryl-group, and it was significantly different between groups ($p < 0.0001$). On POD14, abscess formation on the anastomosis were found in one rat from the control group whereas none was found in the other groups.

The bursting pressure in the control group was 24.4 ± 31.7 mmHg. This was significantly lower than that in the TissuCol-group (120.1 ± 25.3 mmHg, $p = 0.001$), Histoacryl-group (117.3 ± 20.2 mmHg, $p = 0.001$), and Duraseal-group (123.6 ± 35.4 mmHg, $p = 0.001$, Figure 1). In the control group, 85.7% of the segments burst at the anastomotic line during the test, while the rates in the other groups differed between 28.6% (Histoacryl-group) and 50% (TissuCol-group). On POD14, most anastomotic segments did not burst at the site of the anastomosis in the ABP tests.

Anastomotic adhesion formation was found in all rats. On POD3, the number of adhesions was significantly different between groups ($p = 0.012$). An average adhesion number of 3.7 was found in the control group, which was significantly higher than the TissuCol-group (average: 1.8; $p = 0.004$) and Histoacryl-group (average: 1.9; $p = 0.015$), but not significantly higher than the Duraseal-group (average: 2.8). Most rats were scored 2

in the Zühlke score (blunt dissection possible but partly sharp dissection possible; beginning of vascularization), and no difference was found between groups. In contrast, on POD14, the number of adhesions was similar between groups (average varied between 1.4 and 1.7), while their severity significantly differed ($p = 0.004$). The lowest adhesion score was found in the Duraseal-group (average of 1.3; firm adhesion, easy to separate by blunt dissection; no vascularization). It was significantly lower than the control group ($p = 0.001$), which had an average severity of 3.1 (lysis possible but sharp dissection only, clear vascularization).

Histology and immunohistochemistry

Anastomotic site

All the distal-segment slides showed an acute inflammatory response at the anastomotic site on POD3. The inflammatory cell infiltration was highest in the control group, which was significantly higher than that in the Histoacryl-group ($p = 0.009$). Lower fibroblast activity and collagen deposition was seen in the control group compared with the experimental groups, but their differences were not statistically significant (Figure 2). A lower number of CD206+ cells (M2) and a higher number of iNOS+ cells (M1) were seen in the control group, and the M2/M1 index for the control group was also statistically significantly lower than all the tissue adhesive groups respectively ($p = 0.002$; Figure 3). A significant correlation was found between the ABP value and the M2/M1 index ($R = 0.682$; $p < 0.0001$). Similar changes were also seen in the CD4+ cells (T helper cells), CD8+ cells (T suppressor cells), and CD4+/CD8+ index (Figure 4), although only the difference between the control group and the TissuCol-group regarding CD8+ cells was statistically significant.

On POD14 most slides demonstrated sufficient wound healing on the anastomosis, showing as re-continuity of mucosal and muscle layers, less inflammatory cell infiltration and higher collagen deposition. There was no significant difference in fibroblast activity and collagen deposition between the control group and the adhesive groups. A higher number of iNOS+ cells (M1) and a lower M2/M1 index was seen in the control group compared with the tissue adhesive groups (Figure 3).

Serosa-glue interface

On POD3, similar numbers of iNOS+ cells and CD206+ cells were seen at the serosa-glue interface. The M2/M1 index, though higher in the tissue adhesive groups, was not

significantly different between groups. On POD14, a significant higher M2/M1 index was observed in the Histoacryl-group compared with the control group at the serosa-glue interface (Figure 5).

Proximal samples

In proximal samples, except for a minimal number of inflammatory cells, evidence of an inflammatory response was not seen in the control group. Similar to the distal samples, a moderate reaction was seen at the serosa-glue interface in the TissuCol-group, Histoacryl-group and Duraseal-group on POD3, which manifested as macrophage infiltration around the tissue adhesive, without interrupting the continuity of the mucosal, sub-mucosal and muscle layers of the colon. On POD14, the foreign body reaction in the TissuCol-group was observed to have significantly reduced, and the glue was not observed (neither macroscopically nor microscopically) in 75% (6/8) of the rats. The reaction in the Histoacryl-group and Duraseal-group was still moderate.

DISCUSSION

Performing anastomosis in a contaminated environment results in a high leakage rate of colorectal anastomosis and poor clinical outcomes, threatening patient's safety. To investigate whether using tissue-adhesive sealants prevents leakage in a contaminated environment, we constructed colorectal anastomoses under fecal contamination using the rat CLP model. All three chosen tissue adhesives increased the biomechanical strength of anastomosis in the short term, without increasing the risk on adhesion formation in the long term. The increased presence of anti-inflammatory macrophages (M2) and the decrease of the presence of pro-inflammatory (M1) macrophages is associated with increased biomechanical strength and most likely contributed to the positive effect of the tissue adhesives. These results support the further application of these tissue adhesives in a contaminated environment.

In this study, bacterial peritonitis induced with the CLP model caused high mortality, intra-abdominal abscess formation, anastomotic dehiscence, and low bursting pressures in the control group rats on POD3. These results are in line with previous studies [22,25,26].

In comparison, we found that under sterile conditions colonic anastomotic bursting pressure approximated an average of 80-90 mmHg (unpublished data). Lipopolysaccharide (LPS) from intra-abdominal bacteria triggers the classical activation of macrophages (M1), secreting nitric oxide, proinflammatory cytokines (i.e. tumor necrosis factor (TNF)- α , interleukin (IL)-12), subsequently enhancing cell-mediated immunity [27]. Although the exact mechanisms of nitric oxide in anastomotic healing is not yet determined, previous studies found that sepsis-induced nitric oxide production subsequently impaired collagen synthesis and thus delayed colonic anastomotic healing in the early phases [12,13]. Accumulation of nitric oxide also causes apoptosis of neutrophils [28], manifesting as abscess formation. These histological changes were also observed in the control group, and more importantly correlation between the M2/M1 index and the bursting pressure was also found on POD3. These data demonstrate that bacterial peritonitis impaired anastomotic healing in the short term in our CLP model and that macrophages play a role in this process.

We also observed that tissue adhesives reduced abscess formation and increased the bursting pressure in the short term. These positive influences on wound healing are unlikely to be completely determined by the sealant adhesiveness. We previously evaluated the adhesiveness of twelve commercially available tissue adhesives in an ex-vivo rat colon model [29]. According to that study, only cyanoacrylate (including Histoacryl® Flex) had a strong adhesiveness that may instantly increase anastomotic strength. In contrast, all tested fibrin and PEG glues (including TissuCol® and Duraseal®) had very limited adhesiveness, which might hardly give additional strength to the anastomosis [29,30]. However, as is shown in our results, both TissuCol® and Duraseal® significantly increased the bursting pressure on POD3, indicating involvement of other mechanisms.

Activation of macrophages is critical in the acute phase of wound healing. In the early phase, the wound strength mainly comes from the sutures and type III collagen produced by fibroblasts [31]. The fibrogenesis by fibroblasts is enhanced by alternatively activated macrophages (M2), while the classical activation of macrophages (M1) has negative influence on collagen deposition [27, 32]. In addition to the actual cell count, the M2/M1 index is also a representative parameter for macrophage function in tissue reaction [33, 34]. Our data showed a lower number of M1, a higher number of M2, and a higher M2/M1 index in the tissue adhesive groups in the short term. The data suggest an alteration in the macrophage activation. We hypothesized that the tissue adhesive might isolate the contact between the anastomosis and intra-abdominal bacteria, and thus prevented the

endotoxin-induced proinflammatory responses. This was further supported by the results of the Duraseal-group. In that group, a similar amount of iNOS+ cells as in the control group was found at the serosa-glue site (macroscopically presenting as abscess formation), but the anastomotic site was protected from this deleterious environment by the adhesive sealant, and far fewer iNOS+ cells were seen around the anastomosis, probably contributing to the high bursting pressure on POD3.

T lymphocytes also play an important role in the wound healing process. Previous studies reported that accumulation of CD8+ cells had a negative influence on collagen deposition and thus impairing early phase wound healing [35], which was also seen in our data accordingly. After exposure to LPS, type I interferon (IFN- α , β) produced by antigen-presenting cells activates CD8+ cells (T suppressor lymphocytes) [36], which trigger the apoptosis process of the infected somatic cells via the caspase cascade. The involvement of CD4+ cells (T helper cells) in wound healing is complicated. T helper 1 cells are involved in cellular immunity, and enhance iNOS production in macrophages [37]. T helper 2 lymphocytes and mast cells, however, produce IL-4 and other cytokines, which stimulates fibroblasts to produce extracellular matrix proteins, fibronectin, and collagen [38]. Although we did not further differentiate between the subpopulations of T helper cells, in a previous study on thermal injury, a decrease in CD4+/CD8+ ratio could only be found in infected wounds but not in the wounds without infection [14, 39]. A similar phenomenon was only seen in our control group which had a contaminated anastomotic wound. These data are in line with the observation in macrophage activation, and they further elucidate that applying the tissue adhesives prevents localized infection on the anastomosis and thus activates an alternative inflammatory response.

Previous studies found that the protective effect of tissue adhesive on the anastomosis was temporary, mainly in the short term [20, 40, 41]. De Hingh et al. reported that biomechanical strength of anastomoses is most vulnerable on POD3, and then gradually recovers in the CLP model [26]. Other studies showed that the strength at the anastomosis was higher than the intact colon in the long term, when the bursting location was not at the anastomotic site [25, 42]. Similar changes in bursting pressure and inflammatory cells were also seen in our data. Such phenomena are consistent with clinical observations, as most clinical anastomotic leakages occur within the first seven postoperative days, especially after contaminated procedures [25, 43]. In this regard tissue adhesives are required to provide effective protection during the first critical days after surgery prior to a long-lasting

protection. Our results showed application of select tissue adhesives assists wound healing during the crucial period.

Increasing the anastomotic strength in the short term, it is also important that the applied tissue adhesives do not cause other adverse events in the long term. Among those events, adhesion formation and foreign body reaction are the most concerning ones for intra-abdominal application of biomaterials [19, 20]. Our data showed that the tissue adhesives used did not increase adhesion formation. The foreign body reaction after adhesive application were moderate in all tissue adhesive groups, which were also shown in the M2/M1 index in the long term.

Among the select tissue adhesives, fibrin glue has been known as inert [41, 44, 45], and polyethylene glycol glue has been used as an adhesion barrier [18]. A moderate foreign body reaction and adhesion formation after application of the cyanoacrylate glue, however, was not expected because it was reported to increase inflammatory reactions, necrosis and adhesion formation in normal or high-risk conditions [46-48]. The inconsistency between previous cyanoacrylate studies and our data can be explained by several reasons. First, our amount of cyanoacrylate, 0.02 mL, was much smaller than that in the previous studies [20, 46], and thus fewer adverse events could be expected. In addition, most cyanoacrylate studies with positive results used n-butyl-cyanoacrylate, which causes a less inflammatory response and tissue toxicity than other cyanoacrylate molecules [20]. Therefore Histoacryl® Flex was also used in this study which is made of n-butyl-cyanoacrylate. These differences, though small, might significantly influence outcomes.

In conclusion, the application of the select tissue adhesives (i.e. TissuCol®, Histoacryl® Flex, and Duraseal®) increased anastomotic strength in the short term without increasing the long-term risk for adhesion formation. The alternative activation of macrophages and T cells most likely mediated these positive effects. Our results support the further application of anastomotic sealants in contaminated colorectal surgery.

REFERENCES

1. Demetriades D, Murray JA, Chan L, et al. Penetrating colon injuries requiring resection: diversion or primary anastomosis? An AAST prospective multicenter study. *J Trauma*. 2001 May;50(5):765-75.
2. Nelson R, Singer M. Primary repair for penetrating colon injuries. *Cochrane Database Syst Rev*. 2003(3):CD002247.
3. Constantinides VA, Heriot A, Remzi F, et al. Operative strategies for diverticular peritonitis: a decision analysis between primary resection and anastomosis versus Hartmann's procedures. *Ann Surg*. 2007 Jan;245(1):94-103.
4. Kamwendo NY, Modiba MC, Matlala NS, Becker PJ. Randomized clinical trial to determine if delay from time of penetrating colonic injury precludes primary repair. *Br J Surg*. 2002 Aug;89(8):993-8.
5. Constantinides VA, Tekkis PP, Athanasiou T, et al. Primary resection with anastomosis vs. Hartmann's procedure in nonelective surgery for acute colonic diverticulitis: a systematic review. *Dis Colon Rectum*. 2006 Jul;49(7):966-81.
6. Hudolin T, Hudolin I. The role of primary repair for colonic injuries in wartime. *Br J Surg*. 2005 May;92(5):643-7.
7. Golub R, Golub RW, Cantu R, Jr., Stein HD. A multivariate analysis of factors contributing to leakage of intestinal anastomoses. *J Am Coll Surg*. 1997 Apr;184(4):364-72.
8. Tang R, Chen HH, Wang YL, et al. Risk factors for surgical site infection after elective resection of the colon and rectum: a single-center prospective study of 2,809 consecutive patients. *Ann Surg*. 2001 Aug;234(2):181-9.
9. Leichter SW, Mouawad NJ, Welch KB, Lampman RM, Cleary RK. Risk factors for anastomotic leakage after colectomy. *Dis Colon Rectum*. 2012 May;55(5):569-75.
10. Salem L, Flum DR. Primary anastomosis or Hartmann's procedure for patients with diverticular peritonitis? A systematic review. *Dis Colon Rectum*. 2004 Nov;47(11):1953-64.
11. Snijders HS, Wouters MW, van Leersum NJ, et al. Meta-analysis of the risk for anastomotic leakage, the postoperative mortality caused by leakage in relation to the overall postoperative mortality. *Eur J Surg Oncol*. 2012 Nov;38(11):1013-9.
12. Ahrendt GM, Tantry US, Barbul A. Intra-abdominal sepsis impairs colonic reparative collagen synthesis. *Am J Surg*. 1996 Jan;171(1):102-7; discussion 7-8.
13. Thornton FJ, Ahrendt GM, Schaffer MR, Tantry US, Barbul A. Sepsis impairs anastomotic collagen gene expression and synthesis: a possible role for nitric oxide. *J Surg Res*. 1997 Apr;69(1):81-6.
14. Schaffer M, Barbul A. Lymphocyte function in wound healing and following injury. *Br J Surg*. 1998 Apr;85(4):444-60.
15. Paral J, Subrt Z, Lochman P, et al. Suture-free anastomosis of the colon. Experimental comparison of two cyanoacrylate adhesives. *J Gastrointest Surg*. 2011 Mar;15(3):451-9.
16. Silecchia G, Boru CE, Mouiel J, et al. The use of fibrin sealant to prevent major complications following laparoscopic gastric bypass: results of a multicenter, randomized trial. *Surg Endosc*. 2008 Nov;22(11):2492-7.
17. Slieker JC, Vakalopoulos KA, Komen NA, Jeekel J, Lange JF. Prevention of leakage by sealing colon anastomosis: experimental study in a mouse model. *J Surg Res*. 2013 Oct;184(2):819-24.
18. Preul MC, Campbell PK, Garlick DS, Spetzler RF. Application of a new hydrogel dural sealant that reduces epidural adhesion formation: evaluation in a large

animal laminectomy model. *J Neurosurg Spine*. 2010 Apr;12(4):381-90.

19. Vakalopoulos KA, Daams F, Wu Z, et al. Tissue adhesives in gastrointestinal anastomosis: a systematic review. *J Surg Res*. 2013 Jan 16.

20. Wu Z, Boersema GS, Vakalopoulos KA, et al. Critical analysis of cyanoacrylate in intestinal and colorectal anastomosis. *J Biomed Mater Res B Appl Biomater*. 2013 Oct 24.

21. Deerenberg EB, Mulder IM, Ditzel M, et al. Polyvinyl alcohol hydrogel decreases formation of adhesions in a rat model of peritonitis. *Surg Infect (Larchmt)*. 2012 Oct;13(5):321-5.

22. Deerenberg EB, Mulder IM, Grotenhuis N, Ditzel M, Jeekel J, Lange JF. Experimental study on synthetic and biological mesh implantation in a contaminated environment. *Br J Surg*. 2012 Dec;99(12):1734-41.

23. Zuhlke HV, Lorenz EM, Straub EM, Savvas V. [Pathophysiology and classification of adhesions]. *Langenbecks Arch Chir Suppl II Verh Dtsch Ges Chir*. 1990:1009-16.

24. Phillips JD, Kim CS, Fonkalsrud EW, Zeng H, Dindar H. Effects of chronic corticosteroids and vitamin A on the healing of intestinal anastomoses. *Am J Surg*. 1992 Jan;163(1):71-7.

25. Hendriks T, Mastboom WJ. Healing of experimental intestinal anastomoses. Parameters for repair. *Dis Colon Rectum*. 1990 Oct;33(10):891-901.

26. de Hingh IH, de Man BM, Lomme RM, van Goor H, Hendriks T. Colonic anastomotic strength and matrix metalloproteinase activity in an experimental model of bacterial peritonitis. *Br J Surg*. 2003 Aug;90(8):981-8.

27. Chawla A. Control of macrophage activation and function by PPARs. *Circ Res*. 2010 May 28;106(10):1559-69.

28. Dal Secco D, Paron JA, de Oliveira SH, Ferreira SH, Silva JS, Cunha Fde Q. Neutrophil migration in inflammation: nitric oxide inhibits rolling, adhesion and induces apoptosis. *Nitric Oxide*. 2003 Nov;9(3):153-64.

29. Vakalopoulos KA, Wu Z, Kroese L, et al.

Mechanical Strength and Rheological Properties of Tissue Adhesives With Regard to Colorectal Anastomosis: An Ex vivo Study. *Annals of surgery*. 2014.

30. Wu Z, Vakalopoulos KA, Kroese LF, et al. Reducing Anastomotic Leakage by Reinforcement of Colorectal Anastomosis with Cyanoacrylate Glue. *Eur Surg Res*. 2013 May 31;50(3-4):255-61.

31. Brasken P, Lehto M, Renvall S. Fibronectin, laminin, and collagen types I, III, IV and V in the healing rat colon anastomosis. *Ann Chir Gynaecol*. 1990;79(2):65-71.

32. Gratchev A, Guillot P, Hakiy N, et al. Alternatively activated macrophages differentially express fibronectin and its splice variants and the extracellular matrix protein beta1G-H3. *Scand J Immunol*. 2001 Apr;53(4):386-92.

33. Brown BN, Londono R, Tottey S, et al. Macrophage phenotype as a predictor of constructive remodeling following the implantation of biologically derived surgical mesh materials. *Acta Biomater*. 2012 Mar;8(3):978-87.

34. Kou PM, Babensee JE. Macrophage and dendritic cell phenotypic diversity in the context of biomaterials. *J Biomed Mater Res A*. 2011 Jan;96(1):239-60.

35. Schneider DF, Palmer JL, Tulley JM, et al. A novel role for NKT cells in cutaneous wound repair. *J Surg Res*. 2011 Jun 15;168(2):325-33 e1.

36. Tough DF, Sun S, Sprent J. T cell stimulation in vivo by lipopolysaccharide (LPS). *J Exp Med*. 1997 Jun 16;185(12):2089-94.

37. Park JE, Barbul A. Understanding the role of immune regulation in wound healing. *Am J Surg*. 2004 May;187(5A):11S-6S.

38. Postlethwaite AE, Holness MA, Katai H, Raghov R. Human fibroblasts synthesize elevated levels of extracellular matrix proteins in response to interleukin 4. *J Clin Invest*. 1992 Oct;90(4):1479-85.

39. Burleson DG, Mason AD, Jr., Pruitt BA, Jr. Lymphoid subpopulation changes after thermal injury and thermal injury with infection in an experimental model. *Ann*

Surg. 1988 Feb;207(2):208-12.

40. van der Ham AC, Kort WJ, Weijma IM, Jeekel H. Transient protection of incomplete colonic anastomoses with fibrin sealant: an experimental study in the rat. *J Surg Res.* 1993 Sep;55(3):256-60.

41. van der Ham AC, Kort WJ, Weijma IM, van den Ingh HF, Jeekel H. Effect of antibiotics in fibrin sealant on healing colonic anastomoses in the rat. *Br J Surg.* 1992 Jun;79(6):525-8.

42. Mansson P, Zhang XW, Jeppsson B, Thorlaciuss H. Anastomotic healing in the rat colon: comparison between a radiological method, breaking strength and bursting pressure. *Int J Colorectal Dis.* 2002 Nov;17(6):420-5.

43. Bonanomi G, Prince JM, McSteen F, Schauer PR, Hamad GG. Sealing effect of fibrin glue on the healing of gastrointestinal anastomoses: implications for the endoscopic treatment of leaks. *Surg Endosc.* 2004 Nov;18(11):1620-4.

44. Kanellos I, Christoforidis E, Kanellos D,

Pramateftakis MG, Sakkas L, Betsis D. The healing of colon anastomosis covered with fibrin glue after early postoperative intraperitoneal chemotherapy. *Tech Coloproctol.* 2006 Jul;10(2):115-20.

45. Wang P, Wang J, Zhang W, Li Y, Li J. Effect of the combination of fibrin glue and growth hormone on intestinal anastomoses in a pig model of traumatic shock associated with peritonitis. *World J Surg.* 2009 Mar;33(3):567-76.

46. Kayaoglu HA, Ersoy OF, Ozkan N, Celik A, Filiz NO. Effect of n-butyl-2-cyanoacrylate on high-risk colonic anastomoses. *Kaohsiung J Med Sci.* 2009 Apr;25(4):177-83.

47. Nursal TZ, Anarat R, Bircan S, Yildirim S, Tarim A, Haberal M. The effect of tissue adhesive, octyl-cyanoacrylate, on the healing of experimental high-risk and normal colonic anastomoses. *Am J Surg.* 2004;187(1):28-32.

48. Kirkegaard P, Christensen AB, Ibsen J. Experimental nonsuture colonic anastomoses. *AM J SURG.* 1980;139(2):233-6.

LEGENDS OF FIGURES

Table 1. Chemical components and postoperative mortality

	Chemical components	Manufacturer	Amount per anastomosis (mL)	Number of animals	Postoperative deaths
Control	-	-	-	17	3
TissuCol®	Fibrin glue, with aprotinin	Baxter, (Deerfield, USA)	0.1	16	0
Histoacryl® Flex	n-butyl-2-cyanoacrylate	B. Braun, (Melsungen, Germany)	0.02	17	3
Duraseal®	Polyethylene glycol	Covidien, (Mansfield, USA)	0.1	17	1
Total	-	-	-	67	7

Note: Overall mortality 7 / 67 = 10.4%.

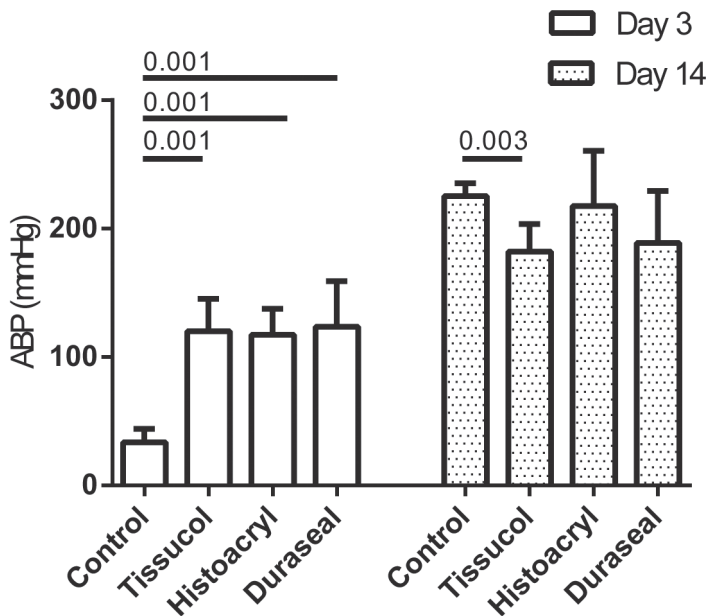

Figure 1. Comparison of anastomotic bursting pressures (ABP) on postoperative day (POD) 3 and 14. Values are mean (S.E.M.). The On POD3, overall comparison, $p = 0.001$, Kruskal-Wallis Test. On POD14, overall comparison, $p = 0.039$, Kruskal-Wallis Test. The p values of Mann-Whitney pairwise comparisons are illustrated in the figure when relevant.

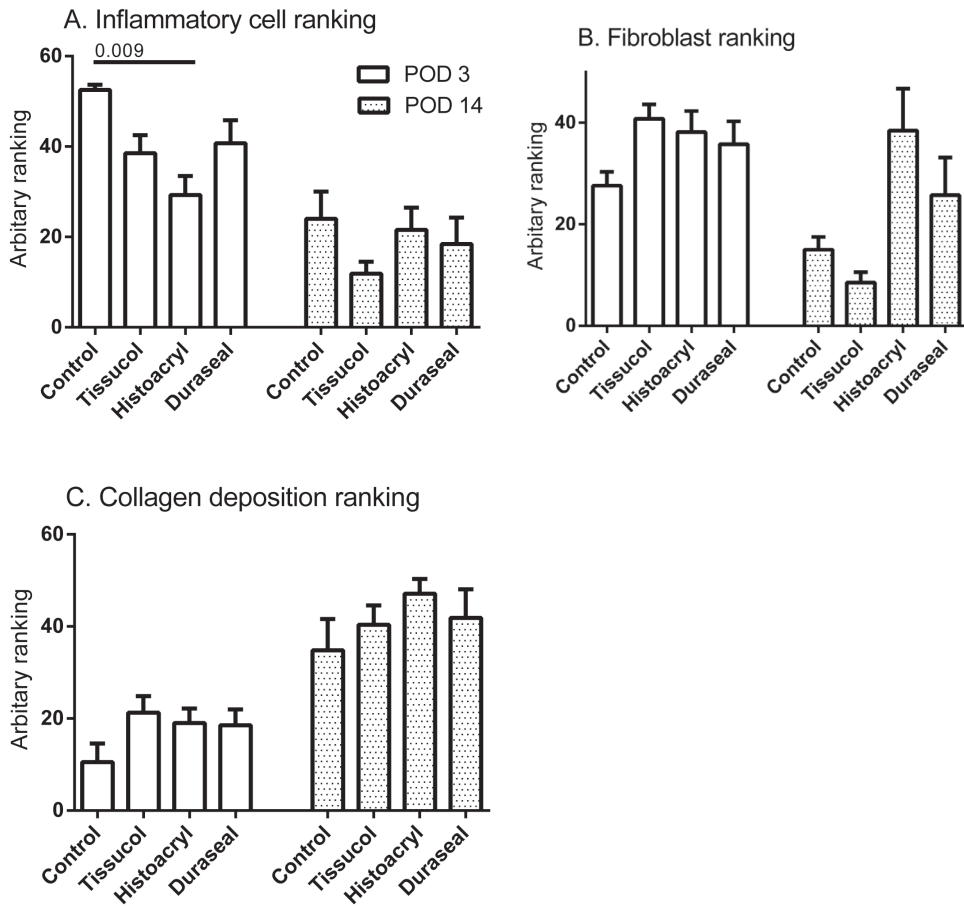

Figure 2. Comparison of histological parameters on postoperative day (POD) 3 and 14. Values are mean ranking (S.E.M.). On POD3, overall comparison of inflammatory cell infiltration ranking (2.A) yielded a $p = 0.003$ with the Kruskal-Wallis Test. Overall comparisons resulted a $p > 0.05$ in the other parameters, Kruskal-Wallis Test. The p values of Mann-Whitney pairwise comparisons are illustrated in the figure when relevant.

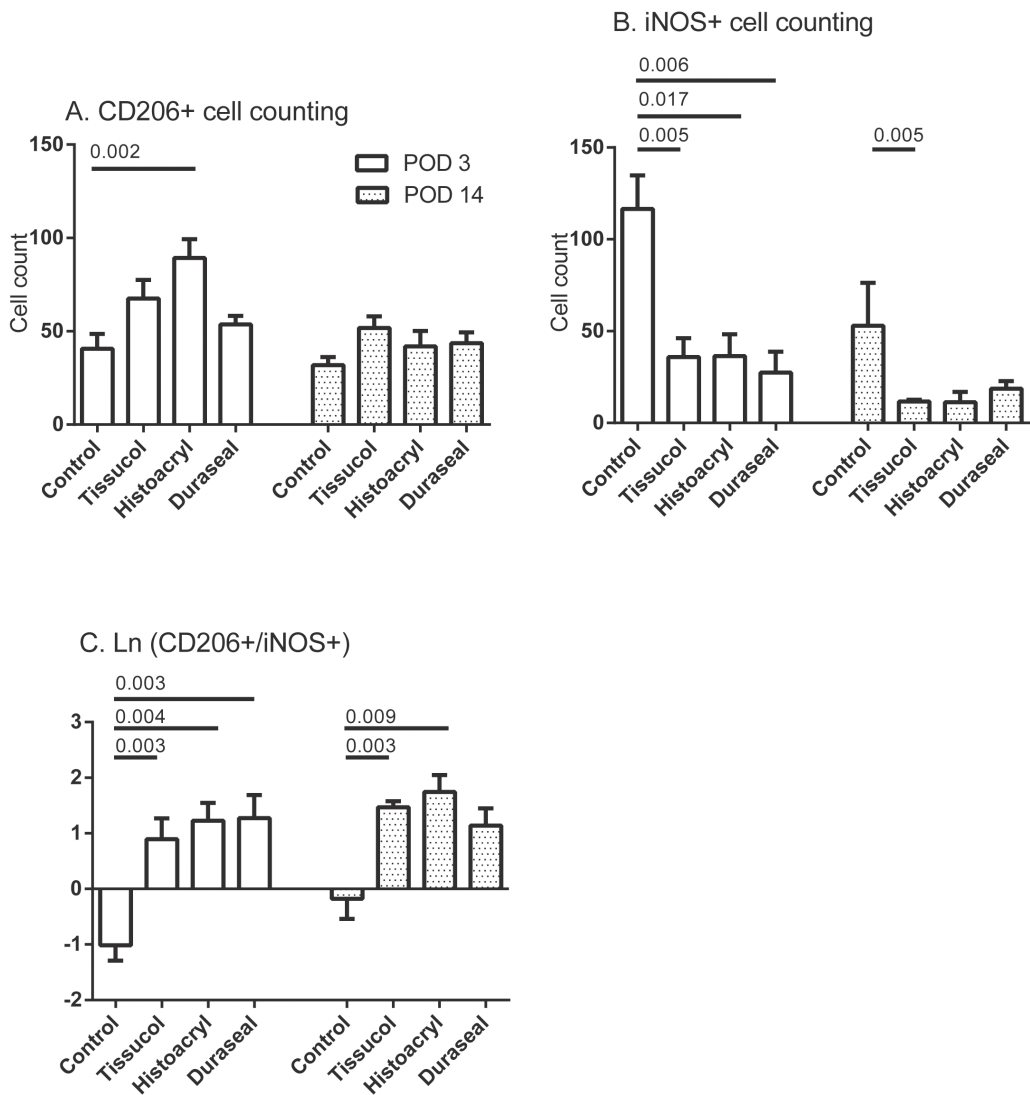

Figure 3. Comparison of macrophage subtype (i.e. M2 and M1) amount at anastomotic site on postoperative day (POD) 3 and 14. Values are mean of cell count (S.E.M.). On POD3, overall comparison of M2 (3.A), $p = 0.003$; M1 (3.B), $p = 0.011$; M2/M1, (3.C) $p = 0.002$, Kruskal-Wallis Test. On POD14, overall comparison of M2 (3.A), $p > 0.05$; M1 (3.B), $p = 0.016$; M2/M1, (3.C) $p = 0.010$, Kruskal-Wallis Test. The p values of Mann-Whitney pairwise comparisons are illustrated in the figure when relevant.

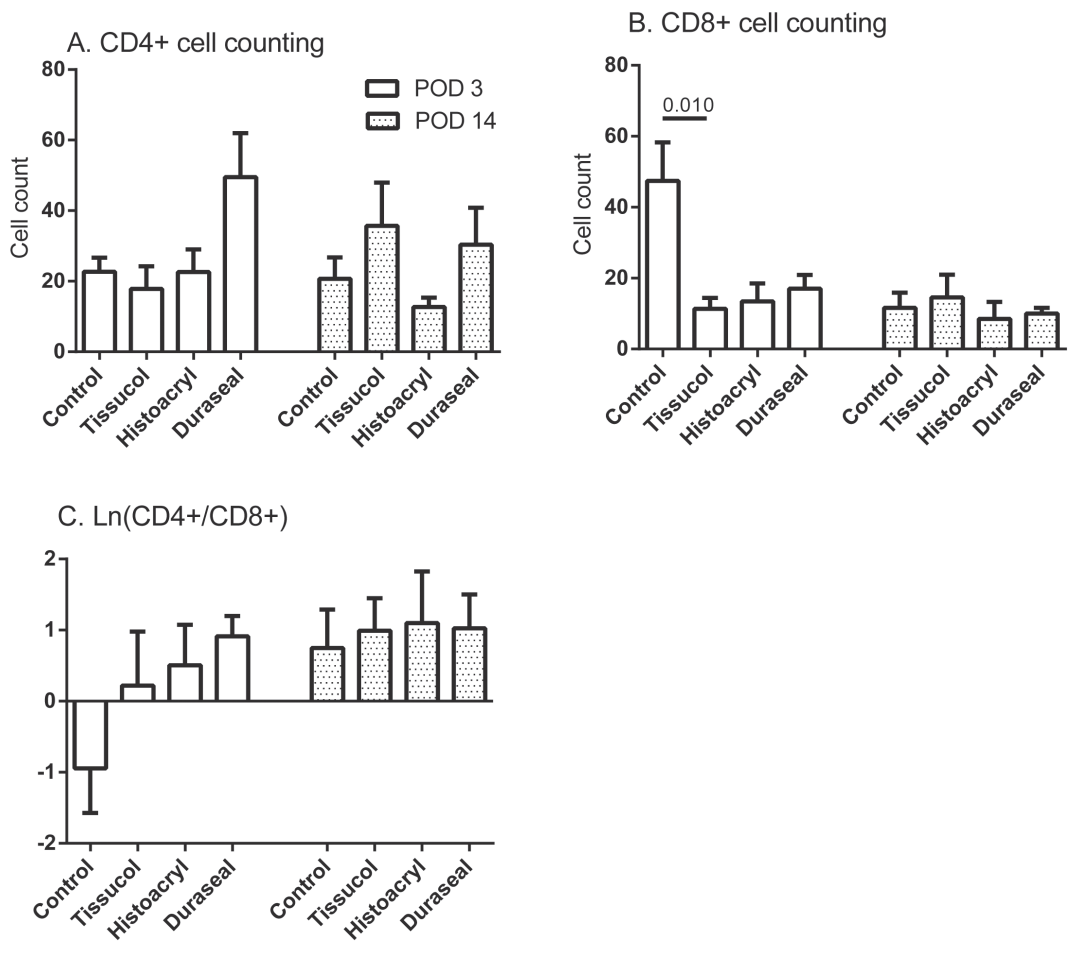

Figure 4. Comparison of T lymphocyte amount at anastomotic site on postoperative day (POD) 3 and 14. Values are mean of cell count (S.E.M.). On POD3, overall comparison of CD4+ (4.A), $p = 0.042$; CD8+ (4.B), $p = 0.027$; CD4+/CD8+, $p > 0.05$ (4.C), Kruskal-Wallis Test. Overall comparisons on POD14 all resulted a $p > 0.05$, Kruskal-Wallis Test. The p values of Mann-Whitney pairwise comparisons are illustrated in the figure.

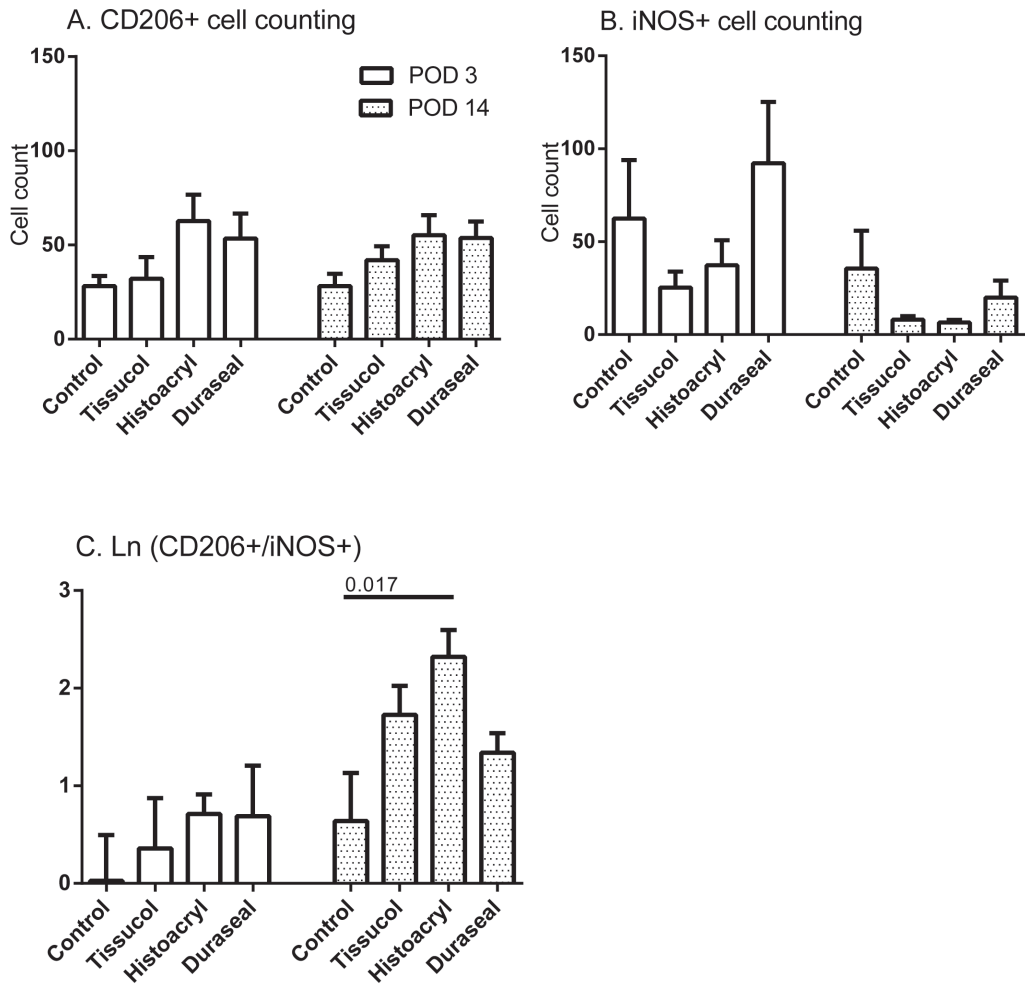

Figure 5. Comparison of macrophage subtype (i.e. M2 and M1) amount at serosa-adhesive site on postoperative day (POD) 3 and 14. Values are mean of cell count (S.E.M.). Despite overall comparison of M2/M1 on POD14 (5.C) yielded a $p = 0.036$, all the other overall comparisons on POD3 or 14 resulted a $p > 0.05$, Kruskal-Wallis Test. The p values of Mann-Whitney pairwise comparisons are illustrated in the figure.

Chapter 9:

Reducing Colorectal Anastomotic Leakage with Tissue Adhesive in Experimental Inflammatory Bowel Disease

Z. Wu, G.S.A. Boersema, L.F. Kroese, D. Taha, S. Vennix,
Y.M. Bastiaansen-Jenniskens, K.H. Lam, G-J. Kleinrensink, J.
Jeekel, M.P. Peppelenbosch, J.F. Lange

Inflammatory Bowel Diseases, 2014 (accepted)

ABSTRACT

Background: Anastomotic leakage after gastrointestinal surgery remains a challenging clinical problem. This study aimed to investigate the effectiveness of TissuCol[®] (fibrin-glue), Histoacryl[®] Flex (n-butyl-2-cyanoacrylate), and Duraseal[®] (polyethylene-glycol) on colorectal anastomotic healing during experimental colitis.

Methods: We first performed colectomy seven days after 10mg trinitrobenzene sulfonic acid (TNBS)-induced colitis to validate a rat TNBS-colitis-colectomy (TCC) model. Subsequently, this TCC model was used in 73 Wistar rats divided into a colitis-group (CG, no adhesive), a TissuCol-group (TG), a Histoacryl-group (HG), and a Duraseal-group (DG). Anastomotic sealant was applied with one adhesive after constructing an end-to-end hand-sewn anastomosis. Clinical manifestations, anastomotic bursting pressure (ABP), and immunohistochemistry of macrophage type-one (M1) and type-two (M2) was performed on postoperative-day (POD)-3 and POD7.

Results: TNBS caused mucosal and sub-mucosal colon damage and compromised anastomotic healing (i.e. abscess formation and low ABP). On POD3, higher severity of abscesses was seen in CG. Average ABP was 53.2 ± 35.5 mmHg in CG, which was significantly lower than HG (134.4 ± 27.5 mmHg) and DG (95.1 ± 54.3 mmHg) but not TG (83.4 ± 46.7 mmHg). Furthermore, a significantly higher M2/M1 index was found in HG. On POD7, abscesses were only seen in CG (6/9) but not in other groups; HG had the lowest severity of adhesion.

Conclusion: We describe the first surgical IBD model by performing colectomy in rats with TNBS-induced colitis, which causes intra-abdominal abscess formation and compromises anastomotic healing. Anastomotic sealing with Histoacryl® Flex prevents these complications in this model. Alternative activation of macrophages seems to be involved in its influence on anastomotic healing.

INTRODUCTION

Inflammatory Bowel Disease (IBD) is a chronic relapsing disorder, and significantly impairs patient's quality of life. Although oral and parenteral therapies are the mainstays in the management of IBD, surgical treatment is still required in case of unsuccessful medical management or occurrence of severe complications. Approximately 20-30% of patients with chronic ulcerative colitis (UC) ultimately require surgical treatment, and 30% of them need a total colectomy within five years after diagnosis [1, 2, 3].

Despite a residual chance for relapse, these patients still suffer substantial risk of short- and long-term surgical complications after operation. After surgical intervention such as ileal-pouch-anal anastomosis, an overall complication rate approximating 30% to 40% in IBD patients has been reported. The patients have even higher rates of complications, especially the infectious ones (68%) when receiving high doses steroids [3, 4]. A major course of the infectious complications (e.g. pelvic sepsis) is leakage at the sutured or stapled anastomotic site [3, 5]. Therefore, preventing anastomotic leakage is a major objective in the request for preventing postoperative complications. Unfortunately, however, effective strategies are still lacking to date.

Using tissue adhesives as an artificial barrier at the anastomotic site seems to be a promising avenue for combating anastomotic leakage rates [6]. Previously, we evaluated the mechanical strength and biological reaction of tissue adhesive in rat models and showed that several tissue adhesives (i.e. TissuCol®, Histoacryl® Flex, and Duraseal®) effectively prevented leakage in contaminated conditions [7, 8]. However, the potential applicability of these results in the setting of inflammatory bowel disease is obscure at best and further investigation in this regard is urgently needed before human testing can commence.

In the microbiologically contaminated environment of the inflamed intestine, prevention of colorectal anastomotic leakage critically depends on skewing the ratio between pro-inflammatory macrophages (M1) and regulatory macrophages (M2) [7]. In addition, macrophages also play an important role in IBD pathology per se, but their exact role remains controversial. Though not fully understood, it has been reported that nitric oxide (NO) production through inducible nitric oxide synthase (iNOS) by M1 macrophages, perpetuates chronic inflammation [9]. Conversely, accumulation of M2 macrophages has been reported to reduce the severity of IBD [10]. In view of their principal and antagonistic roles in anastomotic healing, further investigation as to strategies to increase the M2 component and to decrease the M1 component of the macrophage compartment is of evident importance to devise rational clinical strategies for furthering anastomotic healing in IBD patients.

Although many IBD models have been established and contributed greatly to mechanistic insight in IBD as well as to potential treatment [11, 12, 13, 14, 15], a model focused on the surgical treatment of this disease is conspicuously lacking. To this end in this study we developed a novel surgical IBD model by combining the rat colectomy model with the trinitrobenzene sulfonic acid (TNBS) induced colitis model to study these questions [16, 17]. Colonic anastomoses were constructed in rats with colitis and sealed with one selected tissue adhesive. Clinical manifestations, anastomotic healing, and the ratio of M2- and M1-macrophages using immunohistochemistry were evaluated after surgery to determine the effect of the adhesives. The results show that tissue adhesives and especially Histoacryl® Flex improves outcome, which open the way for human trials testing this adhesive in the surgical treatment of IBD patients.

METHODS

Animals

Male Wistar rats, weighing 300-350 grams, were purchased from a licensed breeder (Harlan Laboratories, Boxmeer, the Netherlands). The rats were bred under specific pathogen-free conditions and kept in individually ventilated cages. The study was performed according to a research protocol approved by the Ethical Committee on Animal Experimentation of Erasmus University Rotterdam.

Establishing a novel rat TNBS-colitis-colectomy (TCC) model

We developed the TCC model by combining the TNBS colitis model with our previously validated rat colectomy model [16, 18].

The rats were fasted for one day before TNBS-colitis induction to ensure a generally empty colon. On the day of colitis induction, the rats were anaesthetized with isoflurane/oxygen inhalation, and a plastic cannula (7.5 cm in length) was inserted trans-anally into the rat colon. TNBS solution (10 mg diluted in 25% ethanol, 0.25 ml; TNBS group, 5 rats) or 25% ethanol (0.25 ml; control group, 10 rats) was injected respectively. The rats were put in a head-down position for 5 minutes and then returned to the cages with free access to food and water.

Seven days later, a partial colectomy was performed in all rats according to our previously published method and conditions (Figure 1) [18], resecting the major part of the colon distal to the caecum. Subsequently, an end-to-end one-layer continuous anastomosis was constructed in an inverted fashion with Dafilon 8-0 (B. Braun, Melsungen, Germany). One trained researcher (ZW) performed all anastomoses under microscope. After closing the abdominal wall, 5 mL saline was subcutaneously injected to prevent dehydration. TNBS-caused colon damage was evaluated during surgery; functional, macroscopic and histological changes regarding anastomotic healing were evaluated on postoperative day (POD)-3.

Evaluating tissue adhesives in the rat TCC model

Evaluation of tissue adhesives in the rat TCC model was performed according to procedures essentially similar as those described above for development and validation of this model. Seventy-three rats with TNBS-colitis were used in this experiment.

Following anastomosis construction, one selected tissue adhesive was applied around the anastomosis as a sealant. The tissue adhesive was prepared according to the instruction manual. According to the applied tissue adhesive, rats were divided into the colitis group (no adhesive applied), TissuCol group, Histoacryl group, and Duraseal group. A blunt needle was used to guide adhesive application when necessary. A standard amount tissue adhesive was applied as in our previously published study and listed in Table 1[7]. After application, a five-minute curing time was allowed to ensure full polymerization of the adhesive. The colitis group, which serves as the non-adhesive negative control, was alternatingly operated between the tissue adhesive groups in order to rule out any systematic bias. TNBS-induced colon damage was also evaluated during surgery; functional, macroscopic and histological changes regarding anastomotic healing were evaluated on POD3 and POD7.

Evaluation of colon damage

During the colectomy, the rat colon was carefully examined for signs of adhesions to adjacent organs and other pathological changes. Immediately after resection the resected colon was opened longitudinally and flushed with PBS solution. One blinded researcher (SV) weighted and measured the length of the resected colon, and a colon weight ratio was calculated (i.e. colon weight/length ratio, g/cm). Subsequently, the colon sample was scored according to the system described by Monozzi et al. (see Supplemental Digital Content, Table S1.a) [16]. H&E staining of the colon damage specimens was performed. The slides were scored according to the histological scoring system which was used by Monozzi et al. (see Supplemental Digital Content, Table S1.b) [16].

Evaluation of intra-abdominal manifestations and histology

On POD3 or POD7, rats were anesthetized and the abdomen was examined for manifestations including intra-abdominal abscess formation, anastomotic dehiscence and adhesion. Abscess severity was scored according to the previously described abscess score,

which was further adapted for its use in this rat model [19, 20] (see Supplemental Digital Content, Table S2). Adhesion severity was recorded according to the Zühlke score [21]. Anastomotic bursting pressure (ABP) was determined after macroscopic observation with the previously described method [7, 18].

H&E stained slides of the anastomotic area of the slides were scored using the Ehrlich and Hunt numerical scale as modified by Phillips et al. [21]. One pathologist (KL) and one researcher evaluated all the slides in a fully randomized order. Immunohistochemical staining for CD206 as a marker for M2 macrophages and iNOS as a marker for M1 macrophages was performed on anastomotic samples employing the same method described in our previous study [7]. The primary antibody against CD206 (1:400, Abcam plc, Cambridge, UK) or iNOS (1:1600, Abcam plc, Cambridge, UK) was applied. To determine the positive cell count on each slide, eight fields were selected on each slide using a microscope with an imaging system (Olympus DP25, Japan), under 20x10 magnification (2560x1960 pixels). Five fields were selected at the anastomotic site and three fields were selected at the serosa-adhesive site, the interface of the tissue adhesive and adjacent tissue (see Supplemental Digital Content, Figure S1.). In the groups without tissue adhesive application, the latter three fields were chosen at interface of serosa and adjacent tissue (anastomotic adhesion). Following the randomization of the slide number with a computer program, the number of positive cells for each field was counted with ImageJ (National Institutes of Health, USA). The average number of the five fields (i.e. macrophage at anastomotic site) and the three fields (i.e. macrophage at serosa-adhesive site) was used for analysis respectively. An M2/M1 index, using the natural logarithm to adjust the data to normal distribution, was calculated according to the following equation.

Statistical analysis

Data of the validation experiment were first analysed separately to validate the TCC model, but were thereafter pooled with the other data for final analysis to improve statistical power. Statistical analysis was performed employing SPSS 21.0 (IBM software, USA). Data were presented as mean \pm standard deviation (S.D.) unless stated otherwise. To detect differences in the variance between groups, Levene's test was used. The one-way analysis of variance was performed with the Kruskal-Wallis Test (for non-parametric parameters) or one-way ANOVA (for normal distributed parameters), and a p-value < 0.05 was considered to indicate statistical significance. For post-hoc comparisons, the Fisher's least significant

difference (LSD) test was used for normal distributed parameter. In pairwise comparisons, the Mann-Whitney U test was used. Comparisons were made between the colitis control group and each of the tissue adhesive groups, not between the tissue adhesive groups. All reported p values are two-sided.

RESULTS

Validation of the TNBS-colitis colectomy (TCC) model

We set out to establish a model that would allow us to investigate the effects of different tissue adhesives in an IBD-relevant context. To this end we decided to combine TNBS colitis with colectomy in experimental rodents. For validating this approach a total number of 15 rats were employed, 10 rats allotted to a control group, whereas 5 other ones were subjected to TNBS treatment. Seven days after TNBS administration, colon hyperemia and ulceration were clearly evident in the TNBS group, resulting in an average gross colon damage score of 2.6 ± 1.1 , which was significantly higher than the score of 0.4 ± 0.5 in the control group ($p = 0.002$). The resected colon weight ratio was 0.13 ± 0.04 g/cm in the TNBS group, which was higher but not significantly different from the control group (0.11 ± 0.01 g/cm).

On POD3, one rat from the TNBS group had anastomotic dehiscence. An average bursting pressure of 47.0 ± 34.3 mmHg was observed in the TNBS group, which was lower than that in the control group (84.0 ± 34.9 mmHg, $p = 0.129$). We concluded that our novel TCC model would allow us to test the influence of tissue adhesives in an IBD-relevant setting.

TNBS-Colitis damage evaluation

A total number of 73 rats were used for evaluating the influence of tissue adhesives on anastomotic healing. Of these experimental animals, 9.6% (7/73) died within 24 hours after surgery, with no difference being evident between groups in this respect. Autopsy showed that all deaths were due to acute complications (e.g. bleeding, anaesthesia) other than anastomotic leakage and thus these animals were excluded from further analysis.

Comparisons of the colitis rats from the validation experiment with the ones from

the tissue adhesive experiment resulted in satisfactory similarity with regard to the colon damage and anastomotic healing (see Supplemental Digital Content, Figure S2), allowing the data to be pooled together (named colitis group) for further analysis.

Seven days after TNBS-colitis induction, colon damage such as hyperaemia, ulceration and adhesion formation was seen in all colitis rats (Figure 2). The average gross colon damage score of each group varied between 2.0 to 3.0, with no significant difference between groups; the resected colon weight/length ratio was not different between the groups as well (see Supplemental Digital Content, Figure S2), suggesting that application of tissue adhesives is not associated with any systematic experimental bias per se.

Compared to the normal rats (i.e. the control group), the resected colon weight/length ratio, and macroscopic damage score of the colitis rats was significantly higher ($p < 0.001$ respectively; Figure 2.). Inflammatory cell infiltration, mucosal and sub-mucosal damage, and poor regeneration were seen in colitis rats during histological evaluation, resulting in an average histological damage score of 5.9 ± 2.6 , which was significantly higher than an average of 3.0 ± 1.9 in the normal rats ($p = 0.002$; Figure 2.).

Postoperative intra-abdominal evaluation

On POD3, 73.7% of colitis rats (28/38) displayed intra-abdominal abscess formation but no significant difference between the groups was noted. Most abscesses were formed near the anastomotic site, and higher severity of abscess formation was seen in the colitis group, but this did not reach statistical significance in the overall comparison between the groups. Significantly different adhesion severity was observed ($p = 0.021$; Figure 3.). Though not significant, higher severity of adhesion formation was seen in the colitis group and the TissuCol group.

An average bursting pressure of 53.2 ± 35.5 mmHg was seen in the colitis group on POD3, which was significantly lower than the control group (84.0 ± 34.9 mmHg, $p = 0.027$) and the Histoacryl group (134.4 ± 27.5 mmHg, $p < 0.001$), and lower than the Duraseal group with marginal significance (95.1 ± 54.3 mmHg, $p = 0.049$) but not the TissuCol group (83.4 ± 46.7 mmHg, $p = 0.12$; Figure 4.).

On POD7, intra-abdominal abscess formation was found in 66.7% rats of the colitis group (6/9) but not in any other group ($p = 0.002$; Figure 3). Most rats had anastomotic

adhesions that were strong or firm adhesions based on the Zühlke score. The highest adhesion score was found in the colitis group (3.4 ± 0.5), which was significantly higher than that observed in the Histoacryl group (2.7 ± 0.5 ; $p = 0.033$) but not different from the other two groups (Figure 3).

On POD7, the highest bursting pressure was observed in Histoacryl group (213.3 ± 20.1 mmHg), but it was not significantly higher than the control, Duraseal, or TissuCol group (160.6 ± 90.2 mmHg, 195.0 ± 43.4 mmHg, 203.8 ± 23.1 mmHg; $p > 0.05$). The intra-experimental group variation of the ABP in the colitis group was significant larger from the TissuCol group ($p = 0.031$) and Histoacryl group ($p = 0.032$).

Histological evaluation

H&E scores were similar between groups with no significant difference, and acute inflammation was seen on H&E stained slides on POD3 in all groups (see Supplemental Digital Content, Figure S3). The number of CD206+ cells (indicating M2-macrophages) at the anastomotic site was similar between groups on POD3, while a higher number of iNOS+ cells (indicating M1 macrophages) were seen in the colitis group. The M2/M1 index was significantly different between groups on POD3 ($p = 0.016$), and a higher M2/M1 index was found in the control group and Histoacryl group (Figure 5). At serosa-adhesive interface, a significantly higher number CD206+ cells was found in the Histoacryl group; similar numbers of iNOS+ cells were seen in all the colitis rats on POD3, which were all higher than the control group. The M2/M1 index was similar between the colitis rats, which were all lower in average than the control group.

Histology with H&E staining revealed less inflammatory cell infiltration, more fibroblasts and more collagen deposition at the anastomotic site on POD7 than those on POD3 (see Supplemental Digital Content, Figure S3). The number of iNOS+ cells was significantly reduced compared to that on POD3, without difference between groups. A higher M2/M1 index as compared to the earlier time points was also found in each experimental group, but no difference between the groups was detected. Pooling the M2/M1 index data of POD7 with those of POD3, a significant correlation was found between the ABP value and the M2/M1 index (R square = 0.105; $p = 0.004$). At serosa-adhesive interface, similar numbers of CD206+ cells and iNOS+ cells, and similar M2/M1 indexes were observed between the groups (Figure 5).

DISCUSSION

Surgical treatment is required in many IBD patients, and with limited preventive strategies, substantial severe short-term postoperative complications still occur. In this study, we developed a novel experimental surgical IBD model (i.e. the TNBS-colitis-colectomy model: TCC model) and investigated the influence of three tissue adhesives on anastomotic healing in this model. Among the selected adhesives, especially Histoacryl® Flex significantly increased the biomechanical strength of anastomosis, and reduced accumulation of pro-inflammatory macrophages at the anastomotic site.

The rodent TNBS-colitis model has been widely used for IBD research and has appropriate visual, histological and also gene-expressional changes resembling those observed in human ulcerative colitis [16, 22, 23, 24]. Our gross observations and histological results are in line with the previous data with consistent colon damage in the colitis rats. Although we did not perform subtotal colectomy or ileal pouch-anal anastomosis in the rat model, performing partial colectomy on basis of the colitis model also allows us to resect most part of the diseased segment [17], which is also the clinical purpose of surgical intervention in IBD patients. Our data demonstrate that the presence of colitis compromises surgical outcomes with main features including lower ABP, higher intra-abdominal abscess and adhesion severity, which are in agreement with clinical findings in IBD patients. Accumulation of M1 macrophages at the anastomotic site is likely to play a role in the impaired anastomotic healing process in the colitis group. We base this statement on two observations: first, compromised ABP and higher number of M1-macrophage was observed in the colitis group as compared with the control group; second, the significant increase of ABP in the Histoacryl group was accompanied with a lower number of M1 macrophages and a higher M2/M1 index at anastomotic site. It is well known that IBD has a chronic and recurrent course with mucosal damage and over-recruitment of inflammatory cells. The M1 macrophages at anastomotic site in our TCC model may have been accumulated due to both colitis and anastomotic healing. Unfortunately, our results do not allow us to determine the origin of M1-macrophage at the anastomotic site in the TCC model and further investigation in this respect is needed.

The mechanism as to how tissue adhesive may act in preventing anastomotic leakage is not yet fully understood. We observed lower severity of abscess formation on POD3 and full clearance of intra-abdominal abscesses in the tissue adhesive groups on POD7. These data indicate tissue adhesives may act in this model through prevention of intra-abdominal abscess formation and correspond to earlier data from our laboratory, albeit that this previous study was not performed in an IBD-relevant context [7]. The most obvious cause of the prevention of such abscesses is a sealing effect blocking intra-luminal content from leaking into the abdominal cavity. Among our selected tissue adhesives, compositions of Duraseal, a synthetic hydrogel (i.e. polyethylene glycol and trilysine), provided us the possibility to evaluate the effect of a pure watertight anastomotic sealant. It has no component influencing the wound healing process [6]. These data further suggest that the sealing effect observed in our study may not entirely depend on the mechanical strength of tissue adhesives.

The pathogenic differences of IBD from other disease are important factors influencing the effectiveness of tissue adhesives. It has been reported that fibrin glue used as a non-surgical treatment of anal fistula failed to reach satisfactory outcomes in IBD patients [25]. In line with this, our data also suggest that in the context of colitis these mechanically weak sealants with or without wound-healing components are less effective when compared with the cyanoacrylate. This is mainly based on two observations in our study. First, although the average was higher, ABP of 40 mmHg or lower on POD3 was still observed in both the TissuCol and Duraseal groups, while ABP in the Histoacryl group were all higher than 90 mmHg. Moreover, the M2/M1 index of the TissuCol and Duraseal groups on POD3 still demonstrated an inflammatory rather than an anti-inflammatory status as observed in the control and Histoacryl group. The M2/M1 index at the serosa-adhesive site also indicates an acute foreign body reaction, especially in the Duraseal group. These data may also partly explain the unsatisfactory clinical results of fibrin glue application.

In addition to a watertight sealing effect, the strength of Histoacryl® Flex is much higher than the other selected adhesives, providing sufficient additional mechanical strength to a primary anastomosis regardless of its original configuration (i.e. sufficient, insufficient or even sutureless anastomosis) [17, 26, 27]. Such reinforcement may further provide a firm contact between the cutting edges, creating an ideal environment for anastomotic healing. Moreover, more M2 macrophages were observed at serosa-adhesive interface in the Histoacryl group, which are known to foster regenerative responses through connective

tissue inducing characteristics including the stimulation of collagen production [28, 29]. It is not an easy task to further verify whether strong adhesiveness of Histoacryl® Flex is the main mechanism of preventing leakage, because modification of the adhesiveness of cyanoacrylate may also change its biological properties. However, from a practical point of view, our data, together with the evidence from other animal studies, have revealed the effectiveness and safety of n-butyl-cyanoacrylate as an anastomotic sealant [30]. It seems to be a promising adjuvant in a surgeon's toolbox.

We recognize that one main limitation of the TCC model is that it only partially mimics human IBD pathology. In addition, most of the diseased colon segment was resected in during colectomy, which may limit the severity of the inflammatory response in long-term after surgery. We therefore chose POD7 (14 days after colitis induction) but not any longer as our second follow-up time. This limitation probably explains the high ABP values in all the groups on POD7. Nevertheless, significant variations were still observed in the colitis group. Different from increasing the bursting pressure on POD3, the selected tissue adhesive seemed to prevent the failure of wound healing on POD7. It is known that application of cyanoacrylate provides an immediate reinforcement with much reduced ABP variation [17]. The increase of ABP was accompanied with a decrease in M1 macrophages in all groups. Combining the short- and long-term data revealed a significant correlation between the M2/M1 index and ABP, which is in line that timely switching of the macrophages from the M1 to the M2 phenotype is important to enhance anastomotic healing.

The use of anastomotic sealant is only one strategy to prevent postoperative complications and results may further improve when combined with other interventions. Especially pharmacological treatments are of great importance in current IBD medical regime, also in a post-operative setting. We think that the model introduced in the present study might aid efforts to understand the influence of pharmacological therapy (e.g. anti-TNF- α , anti-IL-6) on postoperative complications in IBD patients and help understanding the factors governing impaired wound healing process. Investigations addressing this possibility are currently underway in our laboratory.

CONCLUSION

In conclusion, we describe here a novel surgical IBD model by performing colectomy in rats with TNBS-induced colitis, which causes substantial intra-abdominal abscess formation, compromises anastomotic healing. We also demonstrate that application of the selected tissue adhesives, especially Histoacryl® Flex, has a favourable effect to the colorectal anastomotic healing and prevents postoperative complications in the this model. Timely switching of the macrophages from M1 to M2 phenotype seems to be associated with less complications during the early phases of anastomotic healing.

REFERENCES

1. Loftus, E.V., Jr., Clinical epidemiology of inflammatory bowel disease: Incidence, prevalence, and environmental influences. *Gastroenterology*, 2004. 126(6): p. 1504-17.
2. Aratari, A., et al., Colectomy rate in acute severe ulcerative colitis in the infliximab era. *Dig Liver Dis*, 2008. 40(10): p. 821-6.
3. Beddy, D., E.J. Dozois, and J.H. Pemberton, Perioperative complications in inflammatory bowel disease. *Inflamm Bowel Dis*, 2011. 17(7): p. 1610-9.
4. Bach, S.P. and N.J. Mortensen, Revolution and evolution: 30 years of ileoanal pouch surgery. *Inflamm Bowel Dis*, 2006. 12(2): p. 131-45.
5. Gorgun, E. and F.H. Remzi, Complications of ileoanal pouches. *Clin Colon Rectal Surg*, 2004. 17(1): p. 43-55.
6. Vakalopoulos, K.A., et al., Tissue adhesives in gastrointestinal anastomosis: a systematic review. *Journal of Surgical Research*, 2013. 180(2): p. 290-300.
7. Wu, Z., et al., The prevention of colorectal anastomotic leakage with tissue adhesives in a contaminated environment is associated with the presence of anti-inflammatory macrophages. *International Journal of Colorectal Disease*, 2014: p. 1-10.
8. Vakalopoulos, K.A., et al., Mechanical Strength and Rheological Properties of Tissue Adhesives With Regard to Colorectal Anastomosis: An Ex vivo Study. *Ann Surg*, 2014.
9. Kolios, G., V. Valatas, and S.G. Ward, Nitric oxide in inflammatory bowel disease: a universal messenger in an unsolved puzzle. *Immunology*, 2004. 113(4): p. 427-437.
10. Steinbach, E.C. and S.E. Plevy, The role of macrophages and dendritic cells in the initiation of inflammation in IBD. *Inflamm Bowel Dis*, 2014. 20(1): p. 166-75.
11. Bailon, E., et al., DNFB-DNS hapten-induced colitis in mice should not be considered a model of inflammatory bowel disease. *Inflamm Bowel Dis*, 2011. 17(10): p. 2087-101.
12. Peran, L., et al., A comparative study of the preventative effects exerted by three probiotics, *Bifidobacterium lactis*, *Lactobacillus casei* and *Lactobacillus acidophilus*, in the TNBS model of rat colitis. *J Appl Microbiol*, 2007. 103(4): p. 836-44.
13. Fritz, T., et al., Crohn's disease: NOD2, autophagy and ER stress converge. *Gut*, 2011. 60(11): p. 1580-8.
14. Bauer, C., et al., Protective and aggravating effects of Nlrp3 inflammasome activation in IBD models: influence of genetic and environmental factors. *Dig Dis*, 2012. 30 Suppl 1: p. 82-90.
15. te Velde, A.A., M.I. Verstege, and D.W. Hommes, Critical appraisal of the current practice in murine TNBS-induced colitis. *Inflamm Bowel Dis*, 2006. 12(10): p. 995-9.
16. Menozzi, A., et al., Long-term study of TNBS-induced colitis in rats: focus on mast cells. *Inflamm Res*, 2006. 55(10): p. 416-22.
17. Wu, Z., et al. A rat model of anastomotic leakage created by insufficient sutures after partial colectomy. in *British journal of surgery*. 2013: WILEY-BLACKWELL 111 RIVER ST, HOBOKEN 07030-5774, NJ USA.
18. Wu, Z., et al., Colorectal anastomotic leakage caused by insufficient suturing after partial colectomy: a new experimental model. *Surgical Infection*, 2014: p. Accepted article.
19. IRodgers, K., et al., Angiotensin II increases host resistance to peritonitis. *Clin Diagn Lab Immunol*, 2000. 7(4): p. 635-40.
20. Verco, S.J.S., et al., Development of a novel glucose polymer solution (icodextrin) for adhesion prevention: pre-clinical studies. *Human Reproduction*, 2000.

15(8): p. 1764-1772.

21. Zuhlke, H.V., et al., [Pathophysiology and classification of adhesions]. *Langenbecks Arch Chir Suppl II Verh Dtsch Ges Chir*, 1990: p. 1009-16.

22. Brenna, O., et al., Relevance of TNBS-colitis in rats: a methodological study with endoscopic, histologic and Transcriptomic [corrected] characterization and correlation to IBD. *PLoS One*, 2013. 8(1): p. e54543.

23. Huang, Z., et al., miR-141 Regulates colonic leukocytic trafficking by targeting CXCL12beta during murine colitis and human Crohn's disease. *Gut*, 2014. 63(8): p. 1247-57.

24. Law, I.K., et al., Neurotensin-regulated miR-133alpha is involved in proinflammatory signalling in human colonic epithelial cells and in experimental colitis. *Gut*, 2014.

25. Bordeianou, L., Bad news on glues: fibrin glue success rates in the treatment of anal fistulas. *Inflamm*

Bowel Dis, 2008. 14(1): p. 134-5.

26. Paral, J., et al., Glued versus stapled anastomosis of the colon: An experimental study to determine comparative resistance to intraluminal pressure. *Asian Journal of Surgery*, 2014.

27. Vakalopoulos, K.A., et al., Mechanical Strength and Rheological Properties of Tissue Adhesives With Regard to Colorectal Anastomosis: An Ex vivo Study. *Annals of surgery*, 2014.

28. Lucas, T., et al., Differential roles of macrophages in diverse phases of skin repair. *J Immunol*, 2010. 184(7): p. 3964-77.

29. Badylak, S.F., et al., Macrophage phenotype as a determinant of biologic scaffold remodeling. *Tissue Eng Part A*, 2008. 14(11): p. 1835-42.

30. Wu, Z., et al., Critical analysis of cyanoacrylate in intestinal and colorectal anastomosis. *Journal of Biomedical Materials Research Part B: Applied Biomaterials*, 2013.

LEGENDS TO THE FIGURES

Table 1. Chemical components and dosage of the selected tissue adhesives employed in the study.

Commercial name	Chemical components	Manufacturer	Adhesive dosage per anastomosis (mL)
TissuCol®	Fibrin glue, with aprotinin	Baxter, (Deerfield, USA)	0.1
Histoacryl® Flex	n-butyl-2-cyanoacrylate	B. Braun, (Melsungen, Germany)	0.02
Duraseal®	Polyethylene glycol	Covidien, (Mansfield, USA)	0.1

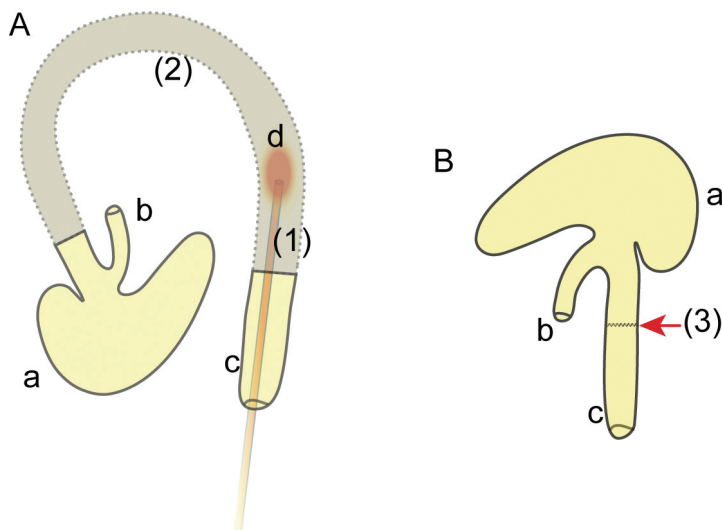

Figure 1. Schematic overview of the rat colon and the methodology employed for the trinitrobenzene sulfonic acid (TNBS)-colitis-colectomy model, anterior view. (A) Rat colon before colectomy. (B) Rat colon after colectomy. Anatomy: a. caecum, b. terminal ileum, c. rectum and anus, d. colitis lesion (intra-luminal). Procedure: (1) Seven days before the colectomy, a TNBS solution (10 mg diluted in 25% ethanol, 0.25 ml) is injected trans-anally with a plastic cannula and this causes colon damage (d); (2) During colectomy, a major part of the colon (i.e. selected with dashed line and indicated with grey colour) is resected; (3) After colon resection, an end-to-end one-layer continuous anastomosis (red arrow) was constructed in an inverted fashion.

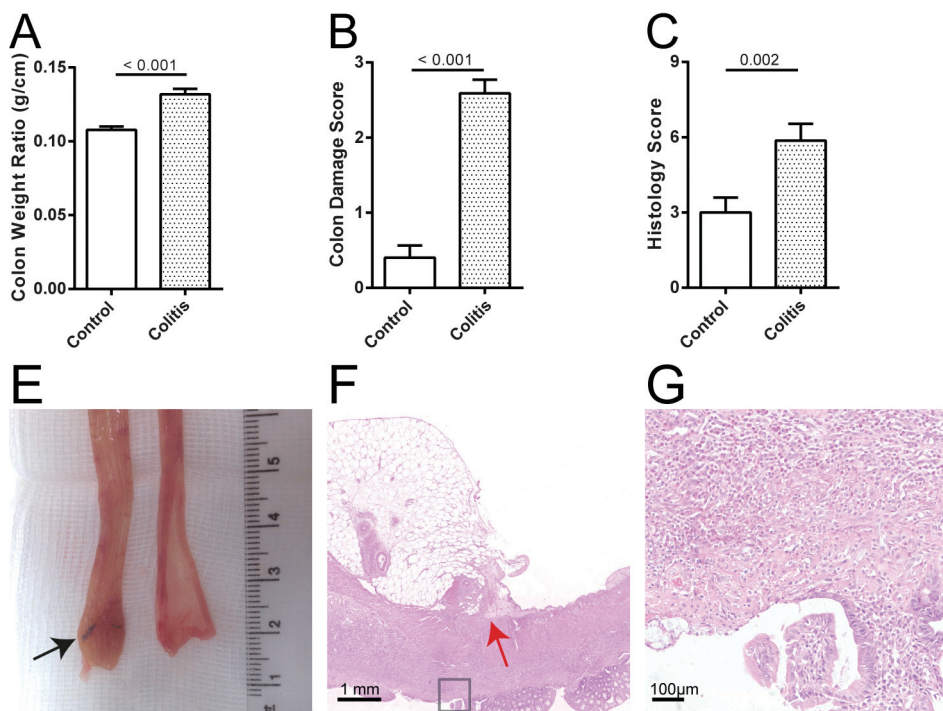

Figure 2. Comparison of the colonic damage between control rats and rats with trinitrobenzene sulfonic acid (TNBS)-induced colitis. In the control rats, 0.25 ml of 25% ethanol was trans-anally injected, n = 10; in the colitis rats, 0.25 ml of 10 mg TNBS diluted in 25% ethanol, n = 78 in A and B, n = 15 in C. (A) Resected colon weight ratio (i.e. wet weight over segment length). (B) Gross colonic damage score. (C) Histology score of colon damage. Values are mean (\pm S.E.M.). The p values of Mann-Whitney analysis of statistical significance between the groups are provided as well. (D) Compared to the normal rat colon (on the right), a colitic colon (on the left) manifests wall thickening, ulceration, and necrosis (black arrow) as is illustrated with the intra-luminal view of the rat colon sample. (E) Histological manifestation of TNBS colitis. The top part of the figure represents the extra-colon side, and the bottom side image represents the intra-colon side. The selected area is enlarged and illustrated in F. Normal structure of colon mucosa and sub-mucosa is destroyed, and substantial inflammatory infiltration and adhesion (red arrow) is seen instead.

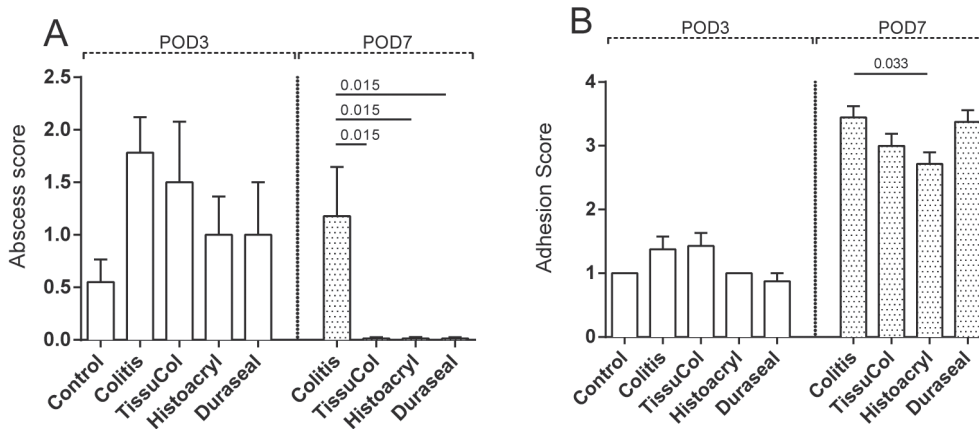

Figure 3. Comparison of abscess and adhesion severity on postoperative day (POD)-3 and POD7 between the various experimental groups employed in this study. (A) Overall comparison of abscess severity yielded a $p > 0.05$ on POD3 but a $p < 0.001$ on POD7 as determined using the Kruskal-Wallis test. On POD7, abscess formation was only observed in the colitis group, which yielded significantly higher abscess severity compared to the other groups on POD7. (B) Overall comparison of adhesion formation resulted in $p = 0.021$ on POD3 and $p = 0.040$ on POD7 when analyzed with the Kruskal-Wallis test. The Histoacryl group had significantly lower anastomotic adhesion severity than the colitis group. The figure also provides the p values of Mann-Whitney pairwise comparisons between the colitis group and other groups when relevant. Values are mean (\pm S.E.M.), $n = 16$ in the colitis group on POD3, $n = 7-10$ in the other groups.

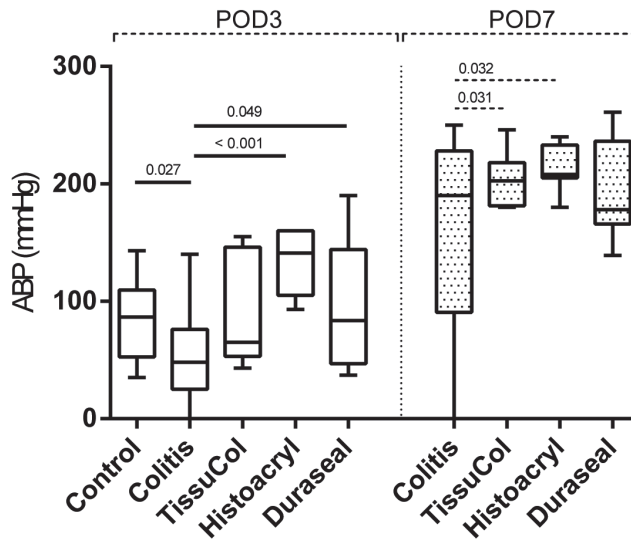

Figure 4. Comparison of anastomotic bursting pressure (ABP) on postoperative day (POD)-3 and POD7 between the various experimental groups employed in this study. Values are bars and whiskers (min to max, middle line at median); $n = 15$ in the colitis group on POD3; $n = 7-10$ in the other groups. On POD3, overall comparison, $p = 0.002$, Kruskal-Wallis Test. The control group and the Histoacryl group yielded significantly higher ABP compared to the colitis group. The p values of Mann-Whitney pairwise analysis are provided as well. On POD7, an overall comparison yielded a $p > 0.05$ as determined with the Kruskal-Wallis test. The TissuCol group and Histoacryl group showed significantly less variation in ABP when compared to the colitis group. The p values, as determined with Levene's test, are provided and were indicated with a dashed line.

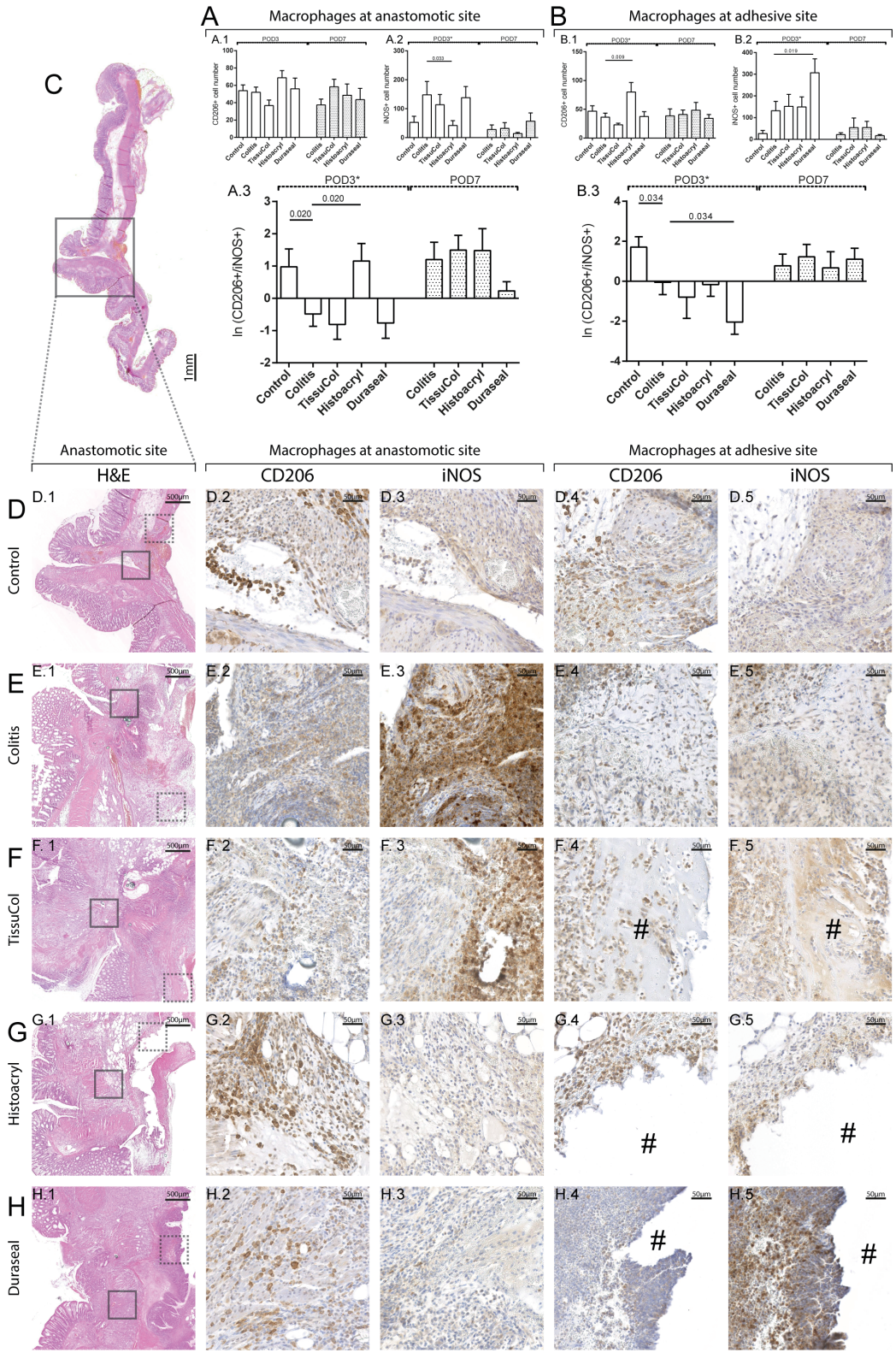

Figure 5. Comparison of macrophage amount at the anastomotic site and the serosal-adhesive site on postoperative day (POD)-3 and POD7 between the various experimental groups employed in this study. The comparisons were listed in A and B, and illustrated in C-H. Values are the means (S.E.M) of cell counts, n = 16 in the colitis group on POD3, n = 7-10 in the other groups. (A) Comparison of macrophage amount at the anastomotic site. (B) Comparison of macrophage amount at the adhesive site. A.1 and B.1 illustrates comparison of regulatory M2-macrophage (indicated as CD206+) amount; A.2 and B.2 illustrates comparison of inflammatory M1-macrophages (indicated as inducible nitric oxide synthase positive, iNOS+) amount; A.3 and B.3 illustrates comparison of M2/M1 index, i.e. $\ln(\text{CD206+}/\text{iNOS+})$. * indicates $p < 0.05$ in the overall comparison using the Kruskal-Wallis Test. The p values of Mann-Whitney pairwise comparisons between the colitis group and other groups were also provided when relevant. (C) Histological observation of an H&E stained anastomosis from the control group. The right side of the image represents the extra-luminal side, and the left side represents the intra-luminal side of the colon. The selected area indicates the anastomotic area which were also chosen in one rat from each group respectively on POD3. The chosen anastomoses are listed in the Column 1 in D-H. (D-H) Immunohistochemistry staining of CD206 and iNOS at the anastomotic site and the adhesive site. In each row, column 1 illustrates the H&E stained anastomotic area of the selected sample. The selected area with solid line indicates the anastomotic area which is enlarged and illustrated in column 2 and 3 for representation of the CD206+ and iNOS+ cells respectively. The selected area with dashed line indicates the adhesive area which is enlarged and illustrated in column 4 and 5 for representation of the CD206+ and iNOS+ cells respectively. # indicates area where the adhesive is present (i.e. in the TissuCol group) or existed but dissolved during staining (i.e. in the Histoacryl group and Duraseal group).

SUPPLEMENTARY DATA

Table S1.a Scoring methodology employed for assessing macroscopic morphology of colon damage

Feature graded	Grade	Description
Hyperemia	0	None
	1	Mild
	2	Severe
Ulceration/necrosis	0	None
	1	Damage <1 cm length
	2	Damage >1 cm and <2 cm length
	3	Damage >2 cm and <3 cm length
	4	Damage >3 cm length
Adhesions	0	None
	1	Presence of adhesions

Reference: Menozzi A, Pozzoli C, Poli E, et al. Long-term study of TNBS-induced colitis in rats: focus on mast cells. *Inflamm Res* 2006;55:416-22.

Table S1.b Scoring methodology employed for assessing histological morphology of colon damage

Score	Description
0	no abscess
0.5	one small abscess
1	several small abscesses
2	one medium abscess
3	one large or several medium abscesses
4	one very large or several large abscesses

Reference:

Rodgers K, Xiong S, Espinoza T, et al. Angiotensin II increases host resistance to peritonitis. *Clinical and diagnostic laboratory immunology* 2000;7:635-40.

Verco SJS, Peers EM, Brown CB, et al. Development of a novel glucose polymer solution (icodextrin) for adhesion prevention: pre-clinical studies. *Human Reproduction* 2000;15:1764-72.

Table S2.b Specification of the abscess scoring system for application in the rat model

Abscess size	Specification	Diameter
small abscess	< 1mm	< 1mm
medium abscess	> 1mm, < half of normal rat colon width	approximately 1-3mm
large abscesses	> half, < normal colon width	approximately 3-5 mm
very large abscesses	> normal colon width	approximately > 5 mm, usually with pus

Table S3. Comparison of clinical manifestations between colitis rats from the validation experiment and from the tissue adhesive experiment

	Colitis rats from the validation experiment (n=5)	Colitis rats from the tissue adhesive experiment (n listed)	P value
Colon weight ratio (g/cm)	0.13±0.04	0.14±0.04 (n=73)	0.744
Gross colon damage score	2.6±1.1	2.6±1.6 (n=73)	0.854
Abscess score	1.4±1.7	2.0±1.2 (n=11)	0.420
Adhesion score	1.4±0.5	1.4±0.9 (n=11)	0.547
ABP (mmHg)	47.0±34.3	56.3±37.5 (n=10)	0.883

Note: Values are mean (±S.D.). Colon weight ratio and gross colon damage score were evaluated during the colectomy, so all the colitis rats were included in analysis. Abscess score, adhesion score and anastomotic bursting pressure (ABP) were determined on POD3 in the validation experiment, so 11 rats from the tissue adhesive experiment, i.e. short-term negative control, were included in the analysis.

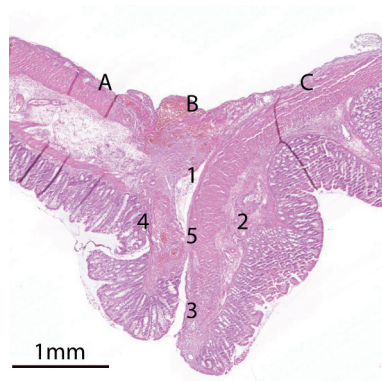

Figure S1. Methodology for field selection in cell quantification. The figure illustrates an H&E stained anastomosis from the control group on POD3. The top side of the image represents the extra-luminal side, and the bottom side represents the intra-luminal side of the colon. At the anastomotic site, five fields were selected in the indicated areas (1 to 5); at the serosa-adhesive site, three fields were also chosen at the interface of the tissue adhesive and adjacent tissue in the above-indicated areas (A to C). In each area, the field is selected at a random position. In the control and colitis group, three fields at the serosa-adhesive site were chosen at the interface of adhesion and adjacent tissue.

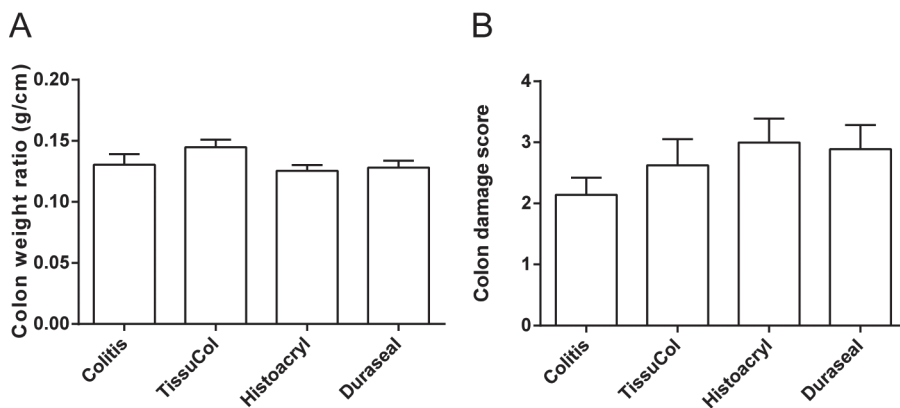

Figure S2. Comparison of colon weight ratio and colon damage between the colitis rats in different groups. Values are mean (\pm S.E.M.). (A) Resected colon weight ratio (i.e. wet weight over segment length). (B) Gross colon damage score. The p values of overall comparisons were > 0.05 , $n = 28$ in the colitis group, $n = 16-18$ in the other groups.

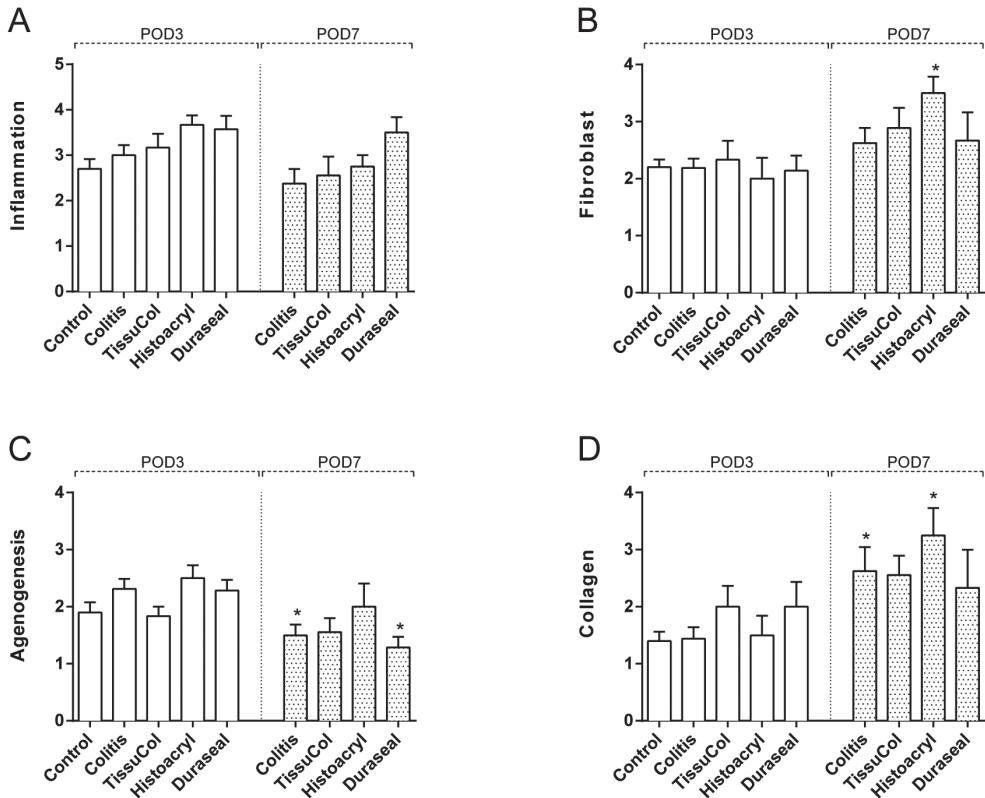

Figure S3. Histological evaluation of anastomotic healing on postoperative day (POD)-3 and POD7. Values are mean (\pm S.E.M.). (A) Inflammatory cell infiltration; (B) Fibroblast activity; (C) Angiogenesis; (D) Collagen deposition. The p values of overall comparisons were all > 0.05 , Kruskal-Wallis Test; $n = 15$ in the colitis group on POD3, $n = 6-9$ in the other groups. * Indicates $p < 0.05$ compared with the same treatment group on POD3, using the Mann-Whitney test.

PART III:

EARLY DETECTION OF COLORECTAL
ANASTOMOTIC LEAKAGE

Chapter 10:

Prediction and Diagnosis of Colorectal Anastomotic Leakage: a Systematic Review of Literature

F. Daams, Z. Wu, Max J. Lahaye, J. Jeekel, J.F. Lange

World Journal of Gastrointestinal Surgery, 2014 (published)

Abstract

Introduction: Although many studies have focused on the preoperative risk factors of anastomotic leakage after colorectal surgery (CAL), postoperative delay in diagnosis is common and harmful. This review provides a systematic overview of all available literature on diagnostic tools used for CAL.

Methods: A systematic search of literature was undertaken using Medline, Embase, Cochrane and Web-of-Science libraries. Articles were selected when a diagnostic or prediction tool for CAL was described and tested. Two reviewers separately assessed the eligibility and level of evidence of the papers.

Results: 69 Articles were selected (clinical methods: 11, laboratory tests: 12, drain fluid analysis: 12, intraoperative techniques: 22, radiology: 16). Clinical scoring leads to early awareness of probability of CAL and reduces delay of diagnosis. CRP measurement at POD 3-4 is helpful. CAL patients are characterized by elevated cytokine levels in drain

fluid in the very early postoperative phase in CAL patients. Intraoperative testing using the air leak test allows intraoperative repair of the anastomosis. Routine contrast enema is not recommended. If CAL is clinically suspected, rectal contrast-CT is recommended by a few studies. In many studies a “no-test” control group was lacking, furthermore no golden standard for AL is available. These two factors contributed to a relatively low level of evidence in the majority of the papers.

Conclusion: This paper provides a systematic overview of literature on the available tools for diagnosing CAL. The study shows that colorectal surgery patients could benefit from some diagnostic interventions that can easily be performed in daily postoperative care.

Introduction

Anastomotic leakage is the most frequent major adverse event after colorectal surgery and remains a large burden for patients and surgeons¹. Despite evolutions in stapling techniques and operation modalities, incidence of anastomotic leakage after colorectal surgery (CAL) has not decreased over the last decade [1,2]. In the abundant literature on CAL, figures on incidence vary widely, most probably because many studies did not apply the unequivocal definition of CAL that has been available since 2010 [3,4]. Clinical signs of CAL before the fifth postoperative day (POD) are uncommon, and most studies described a mean POD of 8 days for CAL to become clinically apparent. However, some studies even show that CAL is diagnosed at mean POD 12 [5,6]. Short-term morbidity and mortality, as well as detrimental long-term effects, such as permanent stoma, might be reduced if CAL is detected and treated in an early phase [7]. Many studies have focused on preoperative risk factors, such as age, sex, neoadjuvant therapy, emergency surgery and distance to the anal verge, and should enable an estimation of risk of postoperative CAL [8-11]. Despite this caution, delay in diagnosis is common and has been described to be caused by false negative radiological investigation and intervening weekends [12]. This study was designed to provide colorectal surgeons with a systematic review of the predictive value of the diagnostic techniques for detection of CAL that are currently described in literature.

Methods

Search methods

A systematic search of literature was undertaken using Medline, Embase, Cochrane and Web-of-Science libraries. No limitations for year of publication were applied. Search terms were: anastomosis, leakage, dehiscence, colorectal, rectum, resection, anterior resection, diagnosis, sensitivity, specificity, prediction, forecasting, monitoring. The search was restricted to publications in English and French. Full search syntax is shown in Addendum and was carried out lastly on 15 October 2012. All references in eligible articles were screened for additional publications. Articles were retrieved according to the Preferred Items for Reporting of Systematic Reviews and Meta-Analyses (PRISMA) guidelines.

Study selection

Articles were selected if a diagnostic tool or prediction model for CAL was described and tested, preferably using a reference. Furthermore, definition of CAL was required. If an article described more than one diagnostic tool, it was included for all the tools that were addressed, with the exception of the technique serving as reference / golden standard.

Studies were excluded if they reported on risk prediction of other complications than CAL. The included anastomosis were ileo-colic, colo-colic, colorectal and colo-anal. Total colectomy with ileal pouch anal anastomosis was excluded since etiology, diagnosis and treatment are very different from the types of anastomosis mentioned before. Moreover, studies on risk factors for CAL and randomized trials studying treatment modalities were excluded, as were presentations, experimental studies, narrative reviews and letters to the editor.

Data extraction

For all eligible studies, a standard data extraction form was filled in and the following data were extracted: study design, number of patients, percentage of clinically important CAL, diagnostic tool and main results. If published, sensitivity, specificity, positive predictive value and negative predictive value were noted, or, if possible, calculated. If stated, the POD of CAL diagnosis was recorded. Furthermore, two authors (F.D., Z.W.) separately determined the level of evidence for validation studies according to the Levels

of Evidence 2011 from the Centre for Evidence Based Medicine. In case of inconsistencies, agreement was accomplished by discussion.

RESULTS

The abstracts of a total of 859 articles were screened separately by 2 authors (F.D., Z.W.) for eligibility. Of these article, 771 were excluded, either for being written in a different language than French and English (n = 25), or for description of preoperative risk factors for CAL (n = 90), or due to irrelevance (n = 308), or because they described a patient cohort or randomized trial or experimental studies, or for other reasons than early detection of CAL (n = 348). This resulted in 88 articles, 18 of which were excluded after full text examination, either for being a narrative review (n = 3), or abstract (n = 11), or due to irrelevance (n = 4).

The remaining 70 articles were included and subdivided into 5 groups, according to type of method used. Two studies were included in two different groups, some studies related to more than one diagnostic tool from one category.

1) Clinical methods: Eleven articles focused on clinical methods, such as the value of physical examination (n = 1), the correlation between clinical symptoms and CAL (n = 5), the application of CAL risk scores (n = 2) or the direct postoperative prediction of the risk of CAL by the surgeon (n = 3)

2) Laboratory tests: Twelve articles related to the correlation between CAL and postoperative levels of cytokines (n = 1), C-reactive protein (CRP, n = 10) or coagulation parameters (n = 1).

3) Drain fluid analysis: Twelve articles related to diagnosis of CAL by analysing peritoneal drain fluid, in one case using two different methods in one study. The articles focussed on macroscopic findings of drain production (n = 2) or on drain fluid analysis of cytokine levels (n = 6), lipopolysaccharides levels (n = 1) or lysozym levels (n = 1). One article addressed the topic of intramucosal pH-measurement, and two articles focused on microdialysis of the peritoneal cavity.

4) Intra-operative techniques: Twenty-three articles investigated the correlation

between preoperative assessment of the anastomosis and CAL, using one or more of the following techniques: air/methylene blue leak test (ALT, n = 13), intraoperative endoscopy (IOE, n = 4), Doppler ultrasound (n = 2), tissue oxygen tension measurement (n = 1), intraoperative inspection of marginal artery bleeding (n = 1), laser fluorescence angiography (LFA, n = 1) and near infra-red/visible light spectroscopy (n = 2).

5) Radiology: Sixteen studies evaluated the accuracy of one or more of the following radiological techniques in detecting CAL: computer tomography (CT, n = 7), water-soluble contrast enema (WSCE, n = 11) and plain X-ray (n = 2).

1) Clinical methods

Table 1 gives an overview of the main results of the eleven included studies. Three studies described direct postoperative CAL risk prediction by the surgeon. Two studies described direct postoperative assessment by the surgeon as valuable [13] [14]. Karliczek et al. prospectively studied subjective assessment of the risk of CAL by the surgeon directly after surgery[15]. Low predictive values were found, with a sensitivity of 62% and a specificity of 52% for low rectal anastomosis.

Five studies analysed the postoperative clinical course of patients with CAL in comparison to patients with an uncomplicated course. Two retrospective studies noted that occurrence of respiratory and neurological disorders often precede CAL after colonic surgery (odd's ratio 2.8 and 5.3 respectively) [16,17]. One prospective study noted that cardiac disorders preceded CAL in 40% of 22 patients with CAL [18]. A small study reported no differences in heart rate variability between patients with and without CAL [19]. In a prospective study by Nesbakken et al., the postoperative assessment of the patient by the surgeon was reported to have high specificity and low sensitivity (91% and 50% respectively) [20]. Tang et al. investigated the value of digital rectal examination (DRE) in assessing CAL before stoma closure, and found a sensitivity of 98,4% [21].

Two Dutch authors developed and applied leakage scores for the detection of CAL. One risk score prospectively combined preoperative and intraoperative items and yielded a twofold higher score in patients with CAL than in patients without CAL[22]. For postoperative clinical course assessment, a standardized leakage score was developed by den

Dulk et al[23] attributing points to certain clinical factors, nutritional status and biochemic findings, thus identifying high risk patients. It facilitated the diagnosis of CAL at POD 6, as opposed to POD 8 in a historical control group.

2) Laboratory tests

Twelve studies investigated the correlation between postoperative levels of CRP and CAL as shown in table 2. Six of them were included in a meta-analysis of 1832 patients by Warschkow et al. [24], which did not focus solely on CAL but on all postoperative infectious complications. In all studies, CRP-levels were elevated several days before the diagnosis of CAL was established. Slotwinski and colleagues reported higher levels of soluble-TNF-receptor at POD 1 in patients who developed CAL after colorectal surgery[25]. Iversen et al. studied levels of markers of coagulation and fibrinolysis in patients with CAL showed elevated levels 5-6 PODs before clinical onset of CAL compared to patients without leakage.

3) Drain fluid analysis

Table 3 shows twelve studies on drain fluid analysis. Six out of twelve studies investigated cytokine levels after colorectal surgery, mainly focussing on IL-6, IL-10 and TNF- α . In 4 of these studies, patients after colorectal surgery who developed CAL at POD 5-20 had elevated cytokine levels from POD 1 onwards [26-29]. One study reported the same phenomenon, but the onset of increased cytokine levels was POD 3 [30]. Another study did not find a relation between CAL and levels of IL-6 and TNF- α [31]. In two studies describing the technique of microdialysis, local signs of ischemia were measured before CAL became clinically apparent in some patients, although both studies also describe patients with CAL who showed no preceding abnormal microdialysis values [28,32]. Macroscopic changes in drain production were examined by Tsujinaka et al. [33]. Of 21 patients with CAL, 15 had previous changes in drain content, while other clinical signs were not obvious. Likewise, Eckmann et al. found that 80% patients that developed CAL after rectum resection had changes in drain fluid aspect [34]. In a small study, intraperitoneal levels of lipopolysaccharides were elevated from POD 3 in patients with CAL, while CAL was only clinically evident at mean POD 6,7⁴⁰. By contrast, lysozyme activity was not

correlated with clinical CAL in another small study [35,36].

4) Intra-operative techniques

Table 4 demonstrates the studies on intraoperative techniques to detect CAL. Eleven studies on peroperative leak tests were evaluated [37-7]. Although these tests facilitate intraoperative repair of the anastomosis or creation of faecal diversion in case of air leakage or methylene blue leakage, postoperative leakage rates were not reduced to 0%. A study by Beard, reported on 18 intraoperative anastomotic corrections, leading to CAL in 3 patients in the “test”-group, compared to 10 patients with CAL in the “no test”-group. As with the air leak test, colonoscopy, performed in 6 studies, led to intraoperative correction of the anastomosis for reasons of leakage and bleeding [46,48-52]. All studies reported low incidences of CAL, although no study compared intraoperative colonoscopy to no intraoperative control. Two studies comparing routine intraoperative colonoscopy to selective use of this technique showed no benefit of routine application of this technique [50,52]. For assessing local anastomotic blood flow, multiple techniques have been described. Ambrosetti et al. studied the use of Doppler intraoperatively at the site of the anastomosis, enabling correction of the anastomosis in 10 of 200 patients, leading to CAL in 2 (1%) [53]. Vignali et al. found that reduced microperfusion at the rectal stump, during creation of a colorectal anastomosis, measured by laser Doppler increased the risk of CAL⁵⁹. In a study by Kudzus et al. intraoperative laser fluorescence angiography (LFA) led to 28 intraoperative corrections, an absolute reintervention rate of 4% and reduced hospital stay⁶⁰. Hirano et al. studied the application of near infrared spectroscopy of the anastomosis. In their small study, perianastomotic StO₂ < 60 mmHg was measured in patients who developed CAL [54]. In a similar study by Karliczek, using visible light spectroscopy, changes in perianastomotic pO₂ before and after creation of the anastomosis had a significant correlation with CAL [55]. One study showed that reduced pO₂ in perianastomotic tissue was predictive for CAL, although cut-off values for routine clinical application were lacking [56,57].

5) Radiology

Sixteen studies evaluated several imaging modalities for the detection of CAL. Seven studies in this review used computer tomography (CT) for the detection of CAL^{20,67,68,73,75,77,78}.

A prospective study by Nesbakken et al. reported a 94% accuracy for 5 patients with CAL out of 56 patients who had received rectum resection[20]. Similarly, Eckman et al. concluded that CT detected 29 of 30 leaks in a group of 305 patients after stapled rectum resection, although no data were presented on the specificity of the technique[58]. Gouya et al. even reported an excellent 100% sensitivity and specificity. However CT will only show leakage of intraluminal contrast at the site of the CAL in 10% of the patients⁶⁷. Improved results are achieved with the detection of associated features such like pericolic/pelvic fluid collections⁷⁸. Presacral abnormalities, commonly described as caused by leakage, were found in 70% of the patients without clinical anastomotic leakage⁶⁸.

Eleven studies investigated the value of the water-soluble contrast enema in determining CAL, mostly after rectum resection, both in the postoperative phase and before closure of deviating ileostomy [20,59-68]. All studies described a high degree, in one case even up to 41% [65], of asymptomatic radiological leakage that resolved without therapeutical intervention. In addition, no study performed contrast enemas in the very early postoperative phase (< POD 5) due to the potential risk of complications so that, when performed at POD 7-8, a clinical leakage concurred with radiological leakage [69]. For these reasons, most studies concluded that routine application of WSCE at POD 7-8 did not contribute to clinical decision-making or to early detection. In the presence of clinical signs suggestive for CAL, a study by Nesbakken described an accuracy of 93% for WSCE in the detection of CAL [20]. Doeksen et al. reported a high specificity and positive predictive value of 94% and 91% respectively, with an interobserver variability of 14% [60].

Two studies investigated the value of plain X-ray. One of these studies reported that increase of subdiaphragmatic free air after POD5 increased the likelihood of CAL[70]. The other study, by Williams et al., reported that the finding of staple line disruption on plain X-ray was suggestive for CAL [69].

Discussion

In this paper, all available evidence on the diagnostic tools for detection of CAL was systematically reviewed, according to the guidelines of the Oxford Centre of evidence based

medicine. Diagnostic techniques were appraised for their ability to predict or detect clinically relevant CAL, since this is relevant in daily care for patients directly after colorectal surgery. Early intervention in abdominal sepsis is essential as is shown by the Surviving Sepsis Campaign, emphasizing on source identification and surgical control when possible⁷⁸.

Many studies report data on asymptomatic or radiological CAL. However, these data were not included in this review, since asymptomatic CAL, if detected, will be left untreated as a rule. Furthermore, it has a poor correlation with clinically relevant CAL. Theoretically, asymptomatic CAL might prove to be important if the oncologic outcome is studied, since equivocal literature is available showing a higher percentage of local recurrence after CAL [71-73]. To this date, however, the role of asymptomatic CAL in local recurrence is unknown.

All eligible studies were separately evaluated by two investigators, and a level of evidence was assigned to each of them. Overall, the level of evidence was considered low. This was due to factors that coincide with the problem of CAL. First, in the field of the diagnosis of CAL, no definition of CAL is available, nor is a golden standard[3]. Such a golden standard cannot even be found in relaparotomy during which faecal discharge at the site of the anastomosis is established, since many patients are treated for CAL without direct visualization of the anastomosis during reoperation. Secondly, a major cause of the low level of evidence is the fact that many studies lack a non-test group. Finally, guidelines to determine the level of evidence differ between diagnostic studies and their therapeutic counterparts. Publication bias and reporting bias in particular were estimated to be low, since the primary search yielded many studies with negative results and small numbers of subjects.

Much research has been done on the early detection of leakage after ileoanal pouch reconstruction following total colectomy for inflammatory bowel disease. These studies were excluded from this review, since they comprise more extensive surgery, different types of leakage, other types of pouch failure and different therapy modalities.

1) Clinical methods

Clinical factors are objective and easily available for risk prediction. A few problems, however, occur if surgeons rely solely on clinical factors. First, the influence of individual factors is not exactly known. Secondly, by the time signs of septicaemia occur; patients

will be in a worse clinical state at the onset of an often prolonged and onerous therapeutic course. Subjective prognosis of leakage at the moment of finishing the anastomosis was proven to have a limited prognostic value[15]. Objective measurements might be of greater prognostic value, as shown by the Colon Leakage Score, in which the presence of objective risk factors leads to a higher score representing a higher chance of CAL[22]. This leakage score was based on previously identified risk factors and to our knowledge is the first to translate all available literature on risk factors for CAL into an instrument that can easily be implemented in daily practice. In a cohort of 233 patients, using a historical control group of 1066 patients, den Dulk et al. developed a similar score system for postoperative clinical evaluation of the colorectal patient. When a high score is found, computer tomography using rectal contrast is warranted. Although this promising method has shown to reduce delay in diagnosis, no information was provided on the prognostic value of this risk score, nor did the study mention the number of CT-scans and concomitant negative results. In a study on tracking of surgical site infections (SSI), van Ramshorst et al. found that protocolled tracking yields a higher reported incidence of SSI than self-reported detection[74]. We believe that this finding could be applied to the protocolled detection of CAL as described above, as it contributes to increased awareness and early detection.

Little is known about the value of physical examination in relation to CAL, except that digital rectal examination has at least the same prognostic value for low anastomosis as contrast enema prior to stoma reversal.

2) Laboratory tests

Many investigators have studied the behaviour of CRP during the subclinical phase of CAL. CRP has the capacity to rise quickly after the onset of an inflammatory stimulus, reaching its highest serum level within 48 hours. Since it has a short halftime of around 19 hours, a drop in CRP corresponds well with the removal of the stimulus. Most studies investigating CRP used cut-off values of around 120 – 190 mg/L at POD 3-4, and all studies in this review showed a reasonable predictive value of CRP for CAL. Drawbacks of all studies described in this review is that the number of included patients per study is rather small and that none of these studies provide a protocol that structurally describes the postoperative clinical examination, the clinical state of the patients during postoperative follow-up and the

type of CAL (i.e. faecal peritonitis, juxta-anastomotic abscess, rectovaginal fistula). Despite these drawbacks, we believe that these studies have indeed shown that measurement of CRP is of great importance in detecting CAL in the preclinical phase.

Other laboratory tests like coagulation factors and cytokines show a correlation with occurrence of CAL, but they have been studied sparsely. Since no parameters for their predictive value can be calculated from the available data, there is no basis for incorporating them in the standard postoperative lab tests.

3) Drain fluid analysis

In this review, the results for cytokine levels in peritoneal drain fluid, as biomarkers for local infection, seem promising. In most studies cytokine levels were elevated from POD 1 in patients with CAL compared to patients without CAL. This finding suggests an early onset of local infection in patients with CAL, or at least a more prominent postoperative reaction in this group. It is hypothesised that cytokines are directly elevated postoperatively and will normalise unless infectious complications occur. Most frequently investigated cytokines are interleukin (IL)-1, 6, 10 and tumour necrosis factor- α (TNF- α).

Although routine drainage after colorectal surgery does not seem to prevent CAL and is omitted in enhanced recovery programs, two studies showed that changes of drain production occur frequently and before clinical symptoms. These interesting findings might justify the routine placement of a drain for the first postoperative days as an indicator for CAL.

Two studies on intraperitoneal microdialysis show, by retrospectively analysing of peritoneal microdialysis samples, that CAL was preceded by changes in local lactate/pyruvate ratio. Although these findings are promising, patient numbers were too low to compute predictive values and cut-off values. Future research should elucidate if prospective, real-time analysis actually leads to early detection and determine whether this technique is cost effective.

For intramucosal pH monitoring, as a measure for mucosal hypoperfusion and subsequent hypoxia, data are limited but promising. The same holds for measurement of lipopolysaccharides, integral components of normal gut flora, and measurements of lysozym

in drain fluid, since the studies investigating these biomarkers did neither lead neither to confirmation of these techniques nor to a re-evaluation.

4) Intra-operative techniques

Except for one, all studies evaluating the air / methylene blue leak test (ALT) confirm the importance of this simple intervention. Although not completely eliminating the occurrence of CAL, ALT allows intraoperative revision of the anastomosis, is easy to perform and has a high negative predictive value. Understandably, no studies have been performed that relate a positive ALT without intraoperative repair to CAL. All valuable studies, those that use a no-test control group, show a lower percentage of CAL in the group in which ALT was performed; in two out of four papers this difference was significant.

Intraoperative endoscopy (IOE) can, apart from direct visualisation of CAL, be of diagnostic and therapeutical importance if the location of the tumour or of additional lesions is unknown or if anastomotic bleeding occurs. More recently, the routine application of IOE has been studied in comparison to selective IOE. No favourable results in occurrence of CAL were described for routinely performed IOE compared to selective IOE. Apart from the mentioned benefits of IOE, no data are available on the superiority of IOE compared to ALT for intraoperative diagnosis of anastomotic dehiscence. Thus, ALT seems to be favourable to IOE since it is faster, easier and cheaper.

Some authors have attempted to relate anastomotic perfusion parameters to anastomotic leakage. Except for one, all studies are case controlled without reference and have not been repeated. It has not led to clear cut-off values for any of these techniques that seem not very practical in daily current practice. At least one cohort study with a good reference is needed before clinical implementation.

5) Radiology

As far as CT with rectal contrast is concerned, only 7 studies could be included. These studies showed large differences in methodology and lacked generally applied definitions. These differences between several studies, especially in CT criteria for CAL, resulted in

equivocal results. Intestinal contrast leakage is not regularly depicted with CT in patients with CAL. However CT can accurately depict the associated features of anastomotic leakage such like pericolic/pelvic fluid collections and free air. When these additional criteria were used the accuracy improved dramatically with accuracies varying from 80-100%^{20,75,77}.

All six studies that were performed on the subject of WSCE over the last two decades concluded that there is no place for routine application of WSCE. In these studies, WSCE did not have a consistently high positive predictive value, and other techniques, such as digital rectal examination in low rectal anastomosis, appeared to provide at least equal results. Furthermore due to the potential risk of complications no study performed contrast enemas in the very early postoperative phase. This means that, when performed at POD 7-8, clinical CAL concurred with radiological leakage[69]. In addition, radiologic signs of CAL do not correlate with clinical CAL and frequently do not require any form of treatment. Another drawback of WSCE is that the rectally administered contrast has been diluted and there may be not enough remaining pressure to induce contrast leakage in more proximal anastomoses⁷³.

Two older studies describe how plain X-rays can be used in assessment of intra-abdominal free air and staple line integrity in the diagnosis of CAL^{75,78}. Although sometimes helpful, modern techniques offer the surgeon much more detailed information on the extend of CAL compared to plain X-rays.

CONCLUSION

Many studies have been performed in the field of diagnosis of CAL. Many lack a no-test control group and reference; therefore the general level of evidence is relatively low. The air leak test is recommended for intraoperative assessment of CAL. When a leakage score system is used intraoperatively, peroperative preventive measures can be taken. When using a clinical algorithm postoperatively, delay in diagnosis of CAL might be reduced. CRP measurement should be part of postoperative laboratory routine at least at POD 3 and 4, since due to a high negative predictive value patients with an uncomplicated course can be identified. Cytokine measurement among other measurements of peritoneal drain fluid

is promising and could justify the routine placement of a juxta-anastomotic drain, while peritoneal microdialysis might develop as minimally invasive peritoneal “smart”-drain. When clinical signs are present, CT with rectal contrast is recommended. CT cannot only to detect CAL but also can be used as a therapeutic instrument for percutaneous drainage of a pericolic/pelvic abscess. We believe that this review reaffirms the importance of early detection of colorectal anastomotic leakage and that it offers colorectal surgeons an overview on easily applicable diagnostic tools to improve early detection.

REFERENCES

1. Alves, A., et al., Management of anastomotic leakage after nondiverted large bowel resection. *J Am Coll Surg*, 1999. 189(6): p. 554-9.
2. Platell, C., et al., The incidence of anastomotic leaks in patients undergoing colorectal surgery. *Colorectal Dis*, 2007. 9(1): p. 71-9.
3. Bruce, J., et al., Systematic review of the definition and measurement of anastomotic leak after gastrointestinal surgery. *Br J Surg*, 2001. 88(9): p. 1157-68.
4. Rahbari, N.N., et al., Definition and grading of anastomotic leakage following anterior resection of the rectum: a proposal by the International Study Group of Rectal Cancer. *Surgery*, 2010. 147(3): p. 339-51.
5. Hyman, N., et al., Anastomotic leaks after intestinal anastomosis: it's later than you think. *Ann Surg*, 2007. 245(2): p. 254-8.
6. Komen, N., et al., After-hours colorectal surgery: a risk factor for anastomotic leakage. *Int J Colorectal Dis*, 2009. 24(7): p. 789-95.
7. Macarthur, D.C., S.J. Nixon, and R.J. Aitken, Avoidable deaths still occur after large bowel surgery. *Scottish Audit of Surgical Mortality, Royal College of Surgeons of Edinburgh. Br J Surg*, 1998. 85(1): p. 80-3.
8. Canelas, A., et al., Risk factors associated to anastomotic leakage in laparoscopic colorectal surgery. *Colorectal Dis*, 2010. 12: p. 37.
9. Isbister, W.H., Study populations and casemix: influence on analysis of postoperative outcomes. *Aust N Z J Surg*, 2000. 70(4): p. 279-284.
10. Lai, R., et al., Risk factors for anastomotic leakage following anterior resection for colorectal cancer: the effect of epidural analgesia on occurrence. *Int J Colorectal Dis*, 2012: p. 1-8.
11. Warschkow, R., et al., Risk factors for anastomotic leakage after rectal cancer resection and reconstruction with colectostomy. a retrospective study with bootstrap analysis. *Ann Surg Oncol*, 2011. 18(10): p. 2772-2782.
12. Doeksen, A., et al., Factors determining delay in relaparotomy for anastomotic leakage after colorectal resection. *World J Gastroenterol*, 2007. 13(27): p. 3721-3725.
13. Pettigrew, R.A. and G.L. Hill, Indicators of surgical risk and clinical judgement. *BR J SURG*, 1986. 73(1): p. 47-51.
14. Makela, J.T., H. Kiviniemi, and S. Laitinen, Risk factors for anastomotic leakage after left-sided colorectal resection with rectal anastomosis. *DIS COLON RECTUM*, 2003. 46(5): p. 653-60.
15. Karliczek, A., et al., Surgeons lack predictive accuracy for anastomotic leakage in gastrointestinal surgery. *Int J Colorectal Dis*, 2009. 24(5): p. 569-576.
16. Bellows, C.F., et al., Early predictors of anastomotic leaks after colectomy. *Tech Coloproctol*, 2009. 13(1): p. 41-47.
17. Ghariani, B., H. Houissa, and F. Sebai, Early diagnosis of anastomotic dehiscence after colonic surgery. *Tunis Med*, 2011. 89(2): p. 174-178.
18. Sutton, C.D., et al., Colo-rectal anastomotic leakage often masquerades as a cardiac complication. *Colorectal Dis*, 2004. 6(1): p. 21-2.
19. Haase, O., et al., Reduction of heart rate variability after colorectal resections. *Langenbeck's Arch Surg*, 2012. 397(5): p. 793-799.
20. Nesbakken, A., et al., Anastomotic leak following mesorectal excision for rectal cancer: True incidence and diagnostic challenges. *Colorectal Dis*, 2005. 7(6): p. 576-581.
21. Tang, C.L. and F. Seow-Choen, Digital rectal examination compares favourably with conventional water-soluble contrast enema in the assessment of anastomotic

- healing after low rectal excision: a cohort study. *INT J COLORECTAL DIS*, 2005. 20(3): p. 262-6.
22. Dekker, J.W.T., et al., Predicting the risk of anastomotic leakage in left-sided colorectal surgery using a colon leakage score. *J Surg Res*, 2011. 166(1): p. e27-34.
 23. den Dulk, M., et al., Improved diagnosis and treatment of anastomotic leakage after colorectal surgery. *Eur J Surg Oncol*, 2009. 35(4): p. 420-426.
 24. Warschkow, R., et al., Safe and early discharge after colorectal surgery due to C-reactive protein: a diagnostic meta-analysis of 1832 patients. *Ann Surg*, 2012. 256(2): p. 245-50.
 25. Slotwinski, R., et al., The soluble tumor necrosis factor receptor I is an early predictor of local infective complications after colorectal surgery. *J Clin Immunol*, 2002. 22(5): p. 289-96.
 26. Fouda, E., et al., Early detection of anastomotic leakage after elective low anterior resection. *J Gastrointest Surg*, 2011. 15(1): p. 137-44.
 27. Ugras, B., et al., Early prediction of anastomotic leakage after colorectal surgery by measuring peritoneal cytokines: Prospective study. *Int J Surg*, 2008. 6(1): p. 28-35.
 28. Matthiessen, P., et al., Is early detection of anastomotic leakage possible by intraperitoneal microdialysis and intraperitoneal cytokines after anterior resection of the rectum for cancer? *Dis Colon Rectum*, 2007. 50(11): p. 1918-1927.
 29. Herwig, R., et al., Early identification of peritonitis by peritoneal cytokine measurement. *Dis Colon Rectum*, 2002. 45(4): p. 514-521.
 30. Yamamoto, T., et al., Peritoneal cytokines as early markers of peritonitis following surgery for colorectal carcinoma: A prospective study. *Cytokine*, 2011. 53(2): p. 239-242.
 31. Bertram, P., et al., Peritoneal release of TNFalpha and IL-6 after elective colorectal surgery and anastomotic leakage. *J Invest Surg*, 2003. 16(2): p. 65-9.
 32. Ellebaek Pedersen, M., et al., Peritoneal microdialysis. Early diagnosis of anastomotic leakage after low anterior resection for rectosigmoid cancer. *Scand J Surg*, 2009. 98(3): p. 148-154.
 33. Tsujinaka, S., et al., Pelvic drainage for anterior resection revisited: Use of drains in anastomotic leaks. *ANZ J Surg*, 2008. 78(6): p. 461-465.
 34. Eckmann, C., et al., Therapeutic strategy for anastomotic leakage following low anterior resection. *Viszeralchirurgie*, 2005. 40(1): p. 17-21.
 35. Junger, W., et al., Early detection of anastomotic leaks after colorectal surgery by measuring endotoxin in the drainage fluid. *Hepatogastroenterology*, 1996. 43(12): p. 1523-9.
 36. Miller, K., E. Arrer, and C. Leitner, Early detection of anastomotic leaks after low anterior resection of the rectum. *DIS COLON RECTUM*, 1996. 39(10): p. 1081-1085.
 37. Beard, J.D., et al., Intraoperative air testing of colorectal anastomoses: a prospective, randomized trial. *BR J SURG*, 1990. 77(10): p. 1095-7.
 38. Davies, A.H., et al., Intra-operative air testing: an audit on rectal anastomosis. *Ann R Coll Surg Engl*, 1988. 70(6): p. 345-7.
 39. Dixon, A.R. and J.T. Holmes, Colorectal anastomotic integrity after anterior resection: is there a role for intraoperative testing? *J R Coll Surg Edinb*, 1991. 36(1): p. 35-6.
 40. Gilbert, J.M. and J.E. Trapnell, Intraoperative testing of the integrity of left-sided colorectal anastomoses: a technique of value to the surgeon in training. *Ann R Coll Surg Engl*, 1988. 70(3): p. 158-60.
 41. Lazorthes, F. and P. Chiotassol, Stapled colorectal anastomoses: peroperative integrity of the anastomosis and risk of postoperative leakage. *INT J COLORECTAL DIS*, 1986. 1(2): p. 96-8.
 42. Ricciardi, R., et al., Anastomotic leak testing after colorectal resection: what are the data? *Arch Surg*, 2009. 144(5): p. 407-11; discussion 411-2.
 43. Schmidt, O., S. Merkel, and W. Hohenberger, Anastomotic leakage after low rectal stapler anastomosis: significance of intraoperative anastomotic testing. *Eur J*

Surg Oncol, 2003. 29(3): p. 239-43.

44. Wheeler, J.M. and J.M. Gilbert, Controlled intraoperative water testing of left-sided colorectal anastomoses: are ileostomies avoidable? *Ann R Coll Surg Engl*, 1999. 81(2): p. 105-8.

45. Yalin, R., et al., Importance of testing stapled rectal anastomoses with air. *Eur J Surg*, 1993. 159(1): p. 49-51.

46. Ishihara, S., T. Watanabe, and H. Nagawa, Intraoperative colonoscopy for stapled anastomosis in colorectal surgery. *Surg Today*, 2008. 38(11): p. 1063-5.

47. Smith, S., et al., The efficacy of intraoperative methylene blue enemas to assess the integrity of a colonic anastomosis. *BMC Surg*, 2007. 7.

48. Griffith, C.D. and J.D. Hardcastle, Intraoperative testing of anastomotic integrity after stapled anterior resection for cancer. *J R Coll Surg Edinb*, 1990. 35(2): p. 106-8.

49. Lanthaler, M., et al., Intraoperative colonoscopy for anastomosis assessment in laparoscopically assisted left-sided colon resection: Is it worthwhile? *J Laparosc Adv Surg Techn*, 2008. 18(1): p. 27-31.

50. Li, V.K., et al., Use of routine intraoperative endoscopy in elective laparoscopic colorectal surgery: can it further avoid anastomotic failure? *Surg Endosc*, 2009. 23(11): p. 2459-2465.

51. Sakanoue, Y., et al., Intraoperative colonoscopy. *Surg Endosc*, 1993. 7(2): p. 84-7.

52. Shamiyeh, A., et al., Intraoperative endoscopy for the assessment of circular-stapled anastomosis in laparoscopic colon surgery. *Surg Laparoscopy Endosc Percutaneous Tech*, 2012. 22(1): p. 65-67.

53. Ambrosetti, P., et al., Left-sided colon and colorectal anastomoses: Doppler ultrasound as an aid to assess bowel vascularization. A prospective evaluation of 200 consecutive elective cases. *INT J COLORECTAL DIS*, 1994. 9(4): p. 211-214.

54. Hirano, Y., et al., Tissue oxygen saturation during colorectal surgery measured by near-infrared spectroscopy: pilot study to predict anastomotic complications. *WORLD J SURG*, 2006. 30(3): p. 457-461.

55. Karliczek, A., et al., Intraoperative assessment of microperfusion with visible light spectroscopy for prediction of anastomotic leakage in colorectal anastomoses. *Scand J Gastroenterol*, 2009. 44: p. 24.

56. Shandall, A., R. Lowndes, and H.L. Young, Colonic anastomotic healing and oxygen tension. *BR J SURG*, 1985. 72(8): p. 606-9.

57. Sheridan, W.G., R.H. Lowndes, and H.L. Young, Tissue oxygen tension as a predictor of colonic anastomotic healing. *DIS COLON RECTUM*, 1987. 30(11): p. 867-71.

58. Eckmann, C., et al., Anastomotic leakage following low anterior resection: results of a standardized diagnostic and therapeutic approach. *Int J Colorectal Dis*, 2004. 19(2): p. 128-33.

59. Akyol, A.M., et al., Early postoperative contrast radiology in the assessment of colorectal anastomotic integrity. *INT J COLORECTAL DIS*, 1992. 7(3): p. 141-143.

60. Doeksen, A., et al., Radiological evaluation of colorectal anastomoses. *Int J Colorectal Dis*, 2008. 23(9): p. 863-868.

61. DuBrow, R.A., C.L. David, and S.A. Curley, Anastomotic leaks after low anterior resection for rectal carcinoma: Evaluation with CT and barium enema. *AM J ROENTGENOL*, 1995. 165(3): p. 567-571.

62. Haynes, I.G., et al., Water-soluble contrast enema after colonic anastomosis. *LANCET*, 1986. 1(8482): p. 675-6.

63. Hoffmann, J., et al., Clinical value of water-soluble contrast enema in assessing the integrity of left colonic anastomoses. *J R COLL SURG EDINBURGH*, 1988. 33(1): p. 23-24.

64. Kalady, M.F., et al., Routine contrast imaging of low pelvic anastomosis prior to closure of defunctioning ileostomy: Is it necessary? *J Gastrointest Surg*, 2008. 12(7): p. 1227-1231.

65. Markham, N.I., R.A. Greatorex, and W.G. Everett, The value and significance of the limited barium enema examination following restorative resection for carcinoma of the rectum. *Ann R Coll Surg Engl*, 1987.

69(3): p. 116-8.

66. Nicksa, G.A., et al., Anastomotic leaks: What is the best diagnostic imaging study? *Dis Colon Rectum*, 2007. 50(2): p. 197-203.

67. Severini, A., et al., Diagnostic and interventional radiology in the post-operative period and follow-up of patients after rectal resection with coloanal anastomosis. *Eur Radiol*, 2000. 10(7): p. 1101-5.

68. Gouya, H., et al., CT antegrade colonography to assess proctectomy and temporary diverting ileostomy complications before early ileostomy takedown in patients with low rectal endometriosis. *Am J Roentgenol*, 2012. 198(1): p. 98-105.

69. Williams, C.E., et al., Over-utilisation of radiography in the assessment of stapled colonic anastomoses. *Eur J Radiol*, 1991. 12(1): p. 35-7.

70. Tang, C.L., et al., Postoperative intra-abdominal free gas after open colorectal resection. *Dis Colon Rectum*,

2000. 43(8): p. 1116-1120.

71. Law, W.L., et al., Anastomotic leakage is associated with poor long-term outcome in patients after curative colorectal resection for malignancy. *J Gastrointest Surg*, 2007. 11(1): p. 8-15.

72. Merkel, S., et al., Locoregional recurrence in patients with anastomotic leakage after anterior resection for rectal carcinoma. *Colorectal Dis*, 2001. 3(3): p. 154-60.

73. den Dulk, M., et al., Multicentre analysis of oncological and survival outcomes following anastomotic leakage after rectal cancer surgery. *Br J Surg*, 2009. 96(9): p. 1066-75.

74. van Ramshorst G, V.G., den Hartog D, Hop W, Jeekel J, Hovius S, Lange J, A prospective comparative study of methods in surgical site infection tracking in abdominal surgery patients: tracking by surgeons is a poor indicator of gold standard measured incidence of surgical site infections. *Surgical Infections*, 2012.

Figures and Tables

Figure 1 Preferred items for reporting of systematic reviews and meta-analyses-chart for included articles. (Two articles could be included in two subgroups.)

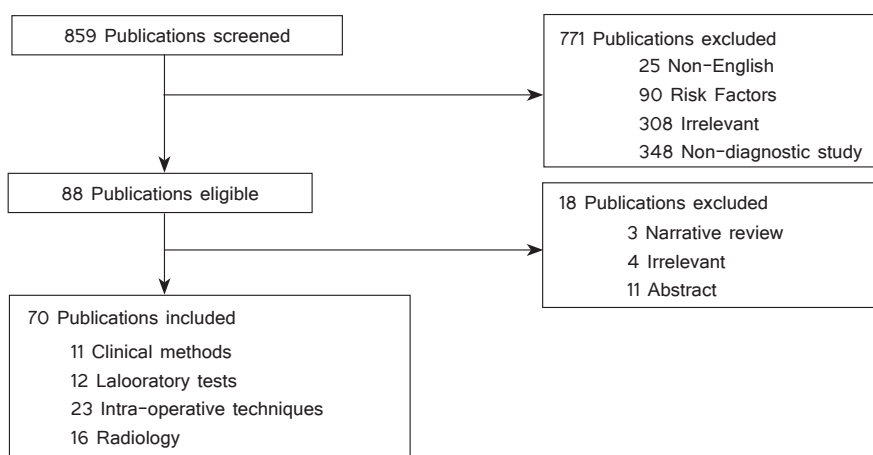

Table 1. Clinical methods.

no	authorrefnr	type of study	loc	N (CAL / non-CAL)	colorectal/rectum	stapled / handsewn anastomosis	study subject / tool	se	sp	PPV	NPV	ROC	main outcome	
1	Dekker ²²	pro	3b	10 / 121	colorectal	?	leakage score	-	-	-	-	0.95	Odds ratio 1,74 for leakage score predictive of CAL	
2	den Dulk ²³	pro	2b	21 / 223	colorectal	both	leakage score	-	-	-	-	-	Delay of treatment reduced from 4 days to 1.5 days	
3	Sutton ¹⁸	pro	3b	22 / 398	colorectal	?	clinical symptoms	0.33	0.97	0.59	0.93	-	Over 40% of patients with cardiac event has CAL	
4	Haase ¹⁹	pro	4	3 / 40	colorectal	?	clinical symptoms	-	-	-	-	-	No difference in heart rate variability between CAL and non-CAL	
5	Ghariani ¹⁷	retro	3b	23 / 314	colon	?	clinical symptoms	-	-	-	-	-	Respiratory, neurological disorders and bloating precipitate CAL	
6	Bellows ¹⁶	retro	3b	25 / 311	colorectal	?	clinical symptoms	respiratory symptoms	0.52	0.84	0.22	0.95	-	Respiratory, neurological disorders and abdominal pain and distension precipitate CAL
							neurology symptoms	0.24	0.97	0.4	0.94	-		
							abdominal pain and distension	0.52	0.83	0.21	0.95	-		
7	Nesbakken ²⁰	pro	3b	5 / 56	rectum	?	clinical symptoms	daily assessment by surgeon	0.5	0.89	0.5	0.89	-	50% of CAL is silent
8	Tang ²¹	pro	3b	10 / 195	rectum	both	digital rectal examination		0.98	-	-	-	-	As valuable as WSCE before stoma closure

Continued

no	authorrefnr	type of study	loe	N (CAL / non-CAL)	colorectal/ rectum	stapled / handsewn anastomosis	study subject / tool		se	sp	PPV	NPV	ROC	main outcome
9	Pettigrew ¹³	pro	3b	28 / 113	colorectal and general	?	risk prediction by surgeon		0.38	0.91	0.56	0.82		Highest predictive value for postop surg assessment
10	Makela ¹⁴	retro	3b	44 / 88	rectum	both	risk prediction by surgeon		-	-	-	-	-	In 86% of pts with >3 risk factors CAL occurs
11	Karliczek ¹⁵	pro	3b	26 / 191	colorectal	?	risk prediction by surgeon	high anastomosis	0.38	0.46	-	-	-	Low predictive value for prediction of CAL by surgeon
								low anastomosis	0.62	0.52	-	-	-	

Pro: prospective, retro: retrospective, leo: level of evidence, CAL: colorectal anastomotic leakage, se: sensitivity, sp: specificity, PPV: positive predictive value, NPV: negative predictive value, ROC: receiver-operating characteristic curve, WSCE: water soluble contrast enema

Table 2. Laboratory tests.

no	authorrefnr	type of study	loe	N (CAL / non-CAL)	colorectal / rectum	stapled / handsewn anastomosis	study subject / tool	cut-off value	se	sp	PPV	NPV	ROC	main outcome	onset CAL (POD)
1	Slotwinski ²⁹	pro	3b	2 / 16	colorectal	?	sTNF-R1, IL-1RA/-6/-8/-10, CRP	-	-	-	-	-	-	TNF higher at POD 1 in CAL	?
2	Iversen ³⁰	pro	3b	17 / 34*	colorectal	both	s-Fibrin, TAT-complex, PT-fl/-2	-	-	-	-	-	-	PT-fl/-2, TAT-complex, s-Fibrin higher at POD 1/2 in CAL	7
3	Woeste ²⁵	retro	3b	26 / 342	colorectal	both	CRP	-	-	-	-	-	-	CRP higher from POD 3 to POD 7 in CAL	8,7
4	Warschkow ²⁴	meta	3a	? / 1832	colorectal	both	CRP	135 mg/L at POD 4	0.68	0.83	0.56	0.89	-	CRP < 135mg/L at POD 4 discharge is safe	?
5	Kornerin ²⁴	retro	3b#	18 / 231	colorectal	both	CRP	190 mg/L at POD 3	0.82	0.73	-	-	0.82	Persisting elevation of CRP is indicative for CAL	8
6	Mackayin ²⁴	pro	3b#	5 / 160	colorectal	?	CRP	145 mg/L at POD 4	0.85	0.86	0.61	0.96	-	CRP > 145mg/L at POD 4 is highly predictive for CAL	?
7	Ortegain ²⁴	pro	3b#	21 / 133	colorectal	both	CRP	125 mg/L at POD 4	0.82	0.96	-	-	-	CRP > 125mg/L at POD 4 discharge is not safe	6
8	Welschin ²⁴	pro	3b#	22 / 96*	rectum	staples	CRP	140 mg/L at POD 3	0.80\$	0.81\$	0.86\$	-	-	Persisting elevation of CRP is indicative for CAL	8
9	Warschkowin ²⁴	retro	3b#	89 / 1115	colorectal	?	CRP	143 mg/L at POD 4	0.75	0.71	0.19	0.97	-	Use CRP as screening at POD 4	9
10	Platt ²⁶	pro	3b	26 / 454	colorectal	both	CRP	190mg/L at POD 3	0.77\$	0.80\$	-	-	0.89\$	CRP at POD 3 is useful for predicting CAL	6-8
11	Matthiessen ²⁷	pro	3b	9 / 33	rectum	?	CRP	-	-	-	-	-	-	CRP higher from POD 2 in CAL	8
12	Almeida ²⁸	retro	3b	24 / 149	colorectal	?	CRP	140 mg/L at POD 3	0.78	0.86	-	-	-	CRP sign higher from POD 2 in CAL	7

*: selected groups, \$: all complications, #: included in meta-analysis. Pro: prospective, retro: retrospective, meta: meta-analysis, l o e: level of evidence, CAL: colorectal anastomotic leakage, TNF: Tumour necrosis factor, IL: Interleukin, CRP: C-reactive protein, TAT: thrombin-antithrombin complexes, PT: prothrombin, POD: postoperative day, se: sensitivity, sp: specificity, PPV: positive predictive value, NPV: negative predictive value, ROC: receiver-operating characteristic curve.

Table 3. Drain fluid analysis.

no	authorrefnr	type of study	l o e	N (CAL / non-CAL)	colorectal / rectum	stapled / handsewn anastomosis	study subject / tool	main outcome	onset CAL (POD)
1	Bertram ³⁶	pro	4	3 / 28	colorectal	?	cytokines	No correlation between IL-6, TNF-alpha and CAL	5.3
2	Herwig ³⁴	pro	3b	12 / 24	colorectal	?	cytokines	IL-6 and TNF-alpha elevated from POD 1 in CAL	5.8
3	Yamamoto ³⁵	pro	3b	7 / 90	colorectal	stapled	cytokines	IL-1beta, IL-6, TNF-alpha elevated from POD 3 in CAL	5-8
4	Ugras ³²	pro	3b	4 / 34	colorectal	both	cytokines	IL-6, IL-10, TNF-alpha elevated from POD 1 in CAL	6
5	Fouda ³¹	pro	3b	8 / 56	rectum	both	cytokines	IL-6, IL-10 elevated from POD 1 in CAL, TNF-alpha elevated from POD 2 in CAL	6
6	Mattiessen ³³	pro	3b	7 / 23	rectum	?	microdialysis, cytokines	L/P-ratio elevated at POD 5/6 in CAL; IL-6, IL-10, TNF-alpha elevated from POD 1 in CAL	early CAL: 6 late CAL: 20
7	Ellebaek ³⁷	pro	3b	4 / 50	colorectal	?	microdialysis	Mean L/P-ratio higher in CAL,	early CAL: 5-10 late CAL: 20
8	Tsujinaka ³⁸	pro	3b	21 / 196	rectum	both	drainproduction	15 / 21 Patients with CAL had changes in drain content	7
9	Eckmann ³⁹	retro	3b	30 / 306	rectum	stapled	drainproduction	80% Of leakages were indicated by drain, 40% of which prior to clinical symptoms	?
10	Millan ⁴⁰	pro	3b	6 / 90	colorectal	stapled	intramucosal pH	Intramucosal pH < 7.28 on POD1 increases risk of CAL 22 fold	?
11	Junger ⁴¹	pro	3b	3 / 22	colorectal	both, biodegradable ring	LPS	Excretion of LPS and LPS concentration is higher at POD 3 in CAL	6,7
12	Miller ⁴²	pro	2B	2 / 42	rectum	stapled	lysozym activity	No correlation between lysozyme activity and CAL	?

Pro: prospective, retro: retrospective, l o e: level of evidence, CAL: colorectal anastomotic leakage, LPS: lipopolysaccharides, IL: Interleukin, TNF: Tumour necrosis factor, POD: postoperative day.

Table 4. Intra-operative techniques.

no	authorrefnr	type of study	l o e / non -CAL	N (CAL / non -CAL)	colorectal / rectum	stapled / handsewn anastomosis	test	test performed	test +	intra-operative correction	CAL test +	test -	CAL test -	test not performed	CAL test not performed	main outcome
1	Beard ⁴³	pro	1b	13 / 145	colorectal	both	ALT	73	18	18	3	55	0	70	10	ALT and peroperative repair reduce risk of AL
2	Davies ⁴⁴	pro	3b	4 / 33	rectum	?	ALT	33	6	6	1	27	3	-	-	LT helpful to reduce leakage rate
3	Dixon ⁴⁵	retro	3b	2 / 202	rectum	both	ALT	119	5	5	0	114	0	-	-	Leaks were avoided
4	Gilbert ⁴⁶	retro	3b	1 / 21	colorectal	handsewn	ALT	21	5	5	1	16	0	-	-	ALT facilitates IOR
5	Lazorthes ⁴⁷	pro	3b	3 / 82	colorectal	stapled, doughnut complete 68	ALT	68	0	0	0	68	3	-	-	High NPV for ALT
						stapled, doughnut incomplete 14		14	4	4	0	10	0	-	-	
6	Ricciardi ⁴⁸	retro	3b	48 / 998	colorectal	both	ALT	825	65	65	5	760	29	173	14	ALT for leftsided anastomosis
7	Schmidt ⁴⁹	pro	3b	68 / 933	rectum	both	ALT	260	47	42	5	213	22	36	4	Risk of AL is unrelated to ALT
8	Wheeler ⁵⁰	pro	4	7 / 102	colorectal	?	ALT	99	21	21	2	85	2	-	-	LT facilitates IOR
9	Yalin ⁵¹	po	3b	1 / 23	colo-rectal	stapled	ALT	21	5	5	1	16	0	-	-	LT facilitates IOR
10	Griffith ⁵⁴	pro	4	2 / 60	colorectal	stapled	ALT	60	11	11	0	49	2	-	-	ALT facilitates IOR
11	Sakanoue ⁵⁷	pro	3b	4 / 70	rectum	?	ALT	35	2	2	0	33	0	35	4	Useful for intraoperative decision making
12	Smith ⁵³	pro	4	7 / 229	colon	both	ALT	229	16	16	0	213	7	-	-	After IOR no CAL occurred
13	Lanthaler ⁵⁵	pro	3b	6 / 122	colorectal	stapled	IOE	73	5	5	0	68	4	49	2	ALT prevents early leak
14	Li ³⁶	pro	3b	2 / 244	rectum	stapled	IOE	107	11	11	0	96	0	137, 30 IOC*	2/137, 1/30	Routine IOE and selective IOE equal results
15	Shamiyeh ⁵⁸	pro	3b	7 / 253	rectum	stapled	IOE	85	2	2	0	83	1	253	4	Routine IOE does not reduce CAL
16	Ishihara ⁵²	pro	4	1 / 73	rectum	stapled	IOE and ALT	73	4	4	0	69	1	-	-	ALT recommended
17	Ambrosetti ⁵⁹	pro	4	2 / 200	colorectal	both	doppler ultrasound									Doppler facilitates IOR
18	Vignali ⁶⁰	pro	3b	8 / 55	colorectal	stapled	laser doppler	-	-	-	-	-	-	-	-	Reduction in microperfusion increases risk of CAL
19	Kudszus ⁶¹	retro	3b	22 / 402	colorectal	both	LFA	201	28	28	8	-	-	201	15	LFA reduces reoperation rate for AL, most prominent in handsewn
20	Hirano ⁶²	pro	4	1 / 20	colorectal	?	near infrared spectroscopy									StO2 < 60% in CAL

Continued

no	authorrefnr	type of study	l o e	N (CAL / non-CAL)	colorectal / rectum	stapled / handsewn anastomosis	test	test per- formed	test +	intra- operative correction	CAL test +	test -	CAL test -	test not per- formed	CAL test not per- formed	main outcome
21	Novell ⁶⁴	pro	3b	275	colorectal	both	Observation of marginal artery bleeding									Pulsatile flow: lower incidence CAL
22	Sheridan ⁶⁵	pro	3b	5 / 50	colon	?	tissue pO2 measurement									Reduced anastomotic pO2 predictive CAL
23	Karliczek ⁶³	pro	3b	14 / 77	colorectal	?	visible light spectroscopy									pO2 could predict CAL

Table 5. Radiology.

no	authorrefnr	type of study	l o e	N (CAL / non-CAL)	colorectal / rectum	stapled / handsewn anastomosis	study tool	se	sp	PPV	NPV	main outcome
1	Eckmann ⁷⁷	retro	3b	30 / 306	rectum	stapled	CT	-	-	-	-	29 of 30 CAL detected by CT
2	Power ⁷⁸	retro	3b	17 / 50	colorectal	?	CT	0.3	0.9	0.58	0.74	Peri-anastomotic located fluid containing air found in CAL
3	Gouya ⁷⁵	retro	3b	10 / 195	rectum	?	CT	-	-	1	1	CT has role in predicting CAL
4	Dubrow ⁶⁸	retro	3b	35 / 75	rectum	?	CT	-	-	-	-	30% of pts with CAL have presacral abnormalities
5	Nicksa ⁷³	retro	4	36 CAL	rectum	?	CT	0.12	-	-	-	Low percentage true positives
6	Doeksen ⁶⁷	retro	3b	68 / 429	colorectal	?	CT	0.54	0.78	0.68	0.66	Interobserver variability 10%
7	Nesbakken ²⁰	pro	3b	5 / 56	rectum	?	CT	0.57	1	-	-	94% accuracy of CT for detection of CAL
8	Severini ⁷⁴	retro	3b	12 / 175	rectum	?	WSCE	-	-	-	-	2 CAL out of 78 positive WSCE, low predictive value
9	Hoffmann ⁷⁰	retro	3b	5 / 51	colorectal	both	WSCE	0.2	0.85	0.13	0.91	WSCE not recommended for routine use
10	Markham ⁷²	retro	3b	1 / 136	rectum	handsewn	WSCE	1	0.57	0.02	1	WSCE no contribution to surgical management
11	Kalady ⁷¹	retro	3b	8 / 211	rectum	?	WSCE	0.88	1	1	0.99	WSCE does not provide additional information
12	Akyol ⁶⁶	pro	3b	12 / 233	colorectal	both	WSCE	0.52	0.87	0.3	0.94	WSCE provides little useful clinical information
13	Haynes ⁶⁹	retro	3b	14 / 117	colorectal	both	WSCE	0.71	0.86	0.42	0.96	WSCE not recommended for routine use
14	Gouya ⁷⁵	retro	3b	10 / 195	rectum	?	WSCE	-	-	1	0.98	WSCE is recommended for routine use
15	Nicksa ⁷³	retro	4	36 CAL	rectum	?	WSCE	0.88	-	-	-	WSCE superior to CT
16	Doeksen ⁶⁷	retro	3b	68 / 429	colorectal	?	WSCE	0.68	0.94	0.91	0.76	Interobserver variability 13%
17	Nesbakken ²⁰	pro	3b	5 / 56	rectum	?	WSCE	0.6	1	-	-	93% accuracy of WSCE for detection of CAL
18	Williams ⁷⁶	retro	4	10 / 31	rectum	stapled	X-ray	0.9	1	1	0.95	Stapleline dehiscence in 9/10 patients with CAL
19	Tang ⁷⁹	pro	4	2 / 64	colorectal	?	X-ray	-	-	-	-	Increase free air after POD 5 higher chance CAL

Pro: prospective, retro: retrospective, meta: meta-analysis, leo: level of evidence, CAL: colorectal anastomotic leakage, CT: computer tomography, WSCE: water-soluble contrast enema, se: sensitivity, sp: specificity, PPV: positive predictive value, NPV: negative predictive value, POD: postoperative day.

Chapter 11:

Postoperative Blood Flow Measurement with Miniaturized Dynamic Light Scattering Predicts Gastrointestinal Anastomotic Healing

Z. Wu, G.S.A. Boersema, D. Taha, I. Fine, G.J. Kleinrensink, J. Jeekel, J.F. Lange

Submitted

ABSTRACT

Introduction: Perioperative bowel perfusion (i.e. local-hemodynamic index, LHI) was measured with a miniaturized Dynamic Light Scattering (mDLS) device, aiming to determine whether anastomotic perfusion correlates with the anastomotic healing process, and whether LHI measurement assists detection of anastomotic leakage (AL) in gastrointestinal surgery.

Methods: A partial colectomy was performed in 21 male Wistar rats. Colonic and anastomotic LHI were recorded during operation. On postoperative day (POD)-3, the rats were examined for AL manifestations. Anastomotic LHI was recorded before determining anastomotic bursting pressure (ABP). The postoperative LHI measurements were repeated in another 15 rats with experimental colitis. Clinical manifestations and anastomotic LHI were also determined on POD3. Diagnostic value of LHI measurement was analyzed with the combined data from both experiments.

Results: Intraoperative LHI measurement showed no correlation with the ABP on POD3. Postoperative anastomotic LHI on POD3 was significantly correlated with ABP in the normal rats ($R^2=0.52$, $p<0.001$) and in the colitis rats ($R^2=0.63$, $p=0.0012$). Anastomotic LHI on POD3 had high accuracy for identifying ABP < 50 mmHg (AUC=0.86, SE=0.065, $p<0.001$). A cut-off point of 1236 yielded a sensitivity of 100% and a specificity of 65%. On POD3, rats with LHI<1236 had significantly higher dehiscence rate (40% vs. 0%), more weight loss, higher abscess severity and lower ABP ($p<0.05$ respectively); worse anastomotic inflammation and collagen deposition were also found in the histological examination.

Conclusion: Our data suggest that postoperative evaluation of anastomotic microcirculation with the mDLS device assists the detection of anastomotic leakage in gastrointestinal surgery.

INTRODUCTION

Despite successful resection of the primary disease, an uncomplicated healing process after construction of an anastomosis is crucial after gastrointestinal surgery. Failure in anastomotic healing results in anastomotic leakage (AL), which is a fearful short-term complication attributing to one third of all postoperative mortality after colorectal surgery [1]. When AL strikes, non-sterile intra-luminal content leaks into the abdominal or pelvic cavity, which causes infection or peritonitis and may incur sepsis, multiple-organ failure, and even death if not detected and treated in time [2]. Due to these catastrophic outcomes, early detection of AL is therefore the paramount guiding timely intervention.

Conventionally, surgeons select patients suspicious of AL for radiological examinations based on abnormal postoperative manifestations. But those “abnormal” manifestations (e.g. fever, leukocytosis, tachycardia, tachypnea) are remarkably common after abdominal surgery, occurring in substantial uncomplicated recoveries [3]. To date AL is usually detected between day 5 and day 8 or even later after surgery [4], and more than half of the detected leakages require reoperation [5, 6]. The unsatisfactory status quo continuously alerts surgeons that many leakage cases are not detected until too late with the current strategy.

Similar to other types of wounds, one direct consequence of an anastomotic wound is

tissue ischemia, which has been considered as a risk factor of AL [7-9]. In skin wounds, tissue perfusion can be conveniently revealed by repeatedly evaluating or even real-time monitoring with a laser Doppler imaging device, flowmetry or other techniques [10, 11]. Unfortunately, evaluation of anastomotic perfusion is not a simple task, and so far is still confined to intraoperative measurement due to large sizes of most devices [12-14]. Monitoring of postoperative anastomotic circulation is not feasible unless a much smaller device is available, which patients may carry during hospitalization or even afterwards.

Recent development in laser technology introduces a novel miniaturized Dynamic Light Scattering (mDLS) device, which may carry out postoperative evaluation of anastomotic microcirculation. However, whether the perfusion data correlate with anastomotic healing remains a fundamental question to be justified prior to its further application. To this end, this study is designed to determine whether blood flow measurement with the mDLS device may aid to the diagnosis of failed anastomotic healing. Perioperative local hemodynamic index (LHI) was recorded during rat colectomy, and analyzed afterwards to determine its diagnostic value.

METHODS

Male Wistar rats were purchased from a licensed breeder (Harlan Laboratories, Boxmeer, the Netherlands). All rats were bred under specific pathogen-free conditions. Rat chow and water were supplied ad libitum. The Ethical Committee on Animal Experimentation of Erasmus University Rotterdam approved the protocol.

LHI monitoring device and data extraction

The Local Hemodynamic Indexes (LHI) were measured with a miniaturized Dynamic Light Scattering (mDLS) device (Elfor, Elfi-Tech Ltd.). The device consists of three parts: an mDLS sensor, a data-collecting device, and a data-analyzing system (i.e. real-time monitoring software). The mDLS sensor consists of a vertical cavity surface emitting laser and an optoelectronic detection system, and is linked to a data-collecting device via flexible wires. When measuring, one can choose to send the recorded data directly to the computer program via blue tooth or USB link for real-time monitoring. At the same time, the data are also saved on an SD card, which can be analyzed afterwards (Fig. 1).

This device measures LHI with laser-speckle analysis of moving red blood cells (RBC) [15]. The measurement is based on time-dependent analysis of the scattered coherent light from an ensemble of moving RBC, and can be used for an assessment of local blood shear rate and blood flow [15]. Based on the estimated blood shear rate contributions into the overall signal, different blood flow components into the measured laser speckle signal can also be extracted respectively. In this study, the data with a frequency between 1-5 kHz, which represent RBC movement in capillaries and yield the most relevance of tissue perfusion, were analyzed [16, 17]. A detailed description of the algorithm of LHI measurement and calculation was provided in the supplementary data.

In this study, we measured LHI on different time points during the rat colectomy (Fig. 2). Blinded measurements (i.e. measuring without real-time monitoring) were employed in order to ensure the highest objectiveness. During each measurement, the sensor was covered with a sterile transparent plastic bag to prevent contamination. Afterwards, the raw data were uploaded and converted into hemodynamic indexes (1-5kHz) with the off-line software. The median value of each LHI measurement was used for statistical analysis.

Evaluation of a correlation between LHI and anastomotic healing

The rats were anesthetized with an isoflurane/O₂ mask. Partial colectomy was performed according to the methods described in our previous study [18]. The baseline LHI data of the ascending and descending colon were first recorded at the site of the intended cutting edges (Fig. 2). Subsequently the major part of the colon was resected, followed by a full thickness end-to-end anastomosis (i.e. continuous suture with 12 stitches) with DaFilon 8/0 (B. Braun, Germany) under the microscope. Then the LHI of the upper and lower anastomotic edges were measured. After the LHI measurement on top of the anastomosis (Fig. 2), the abdominal wall was closed.

Because a standard colectomy yields a relatively low rate of AL [18], we employed an insufficiently sutured anastomosis in three rats to achieve a higher rate of AL according to the developed leakage model. In those rats, five interrupted stitches were performed instead of 12 stitches to construct a technically insufficient anastomosis, while the other procedures remained the same as the aforementioned partial colectomy.

Postoperative LHI measurements in a colitis-colectomy model

To confirm the applicability of the device, postoperative anastomotic LHI was repeated in rats with colitis. Colitis was induced by trans-anal injection of 0.25mL 2,4,6-trinitrobenzenesulfonic acid (TNBS, 10mg diluted in 25% ethanol) under anesthesia according to the previously published TNBS-colitis model [19]. One week later, colectomy was performed with the aforementioned technique, and the anastomosis was constructed with a continuous suture with 12 stitches.

Follow up and postoperative evaluation

The rat abdomen was examined on postoperative day (POD)-3. We first checked signs of anastomotic leakage including abscess formation and anastomotic dehiscence. The abscess severity was determined by an abscess scoring system [20, 21] and adhesion formation was evaluated using the Zühlke score [22], anastomotic LHI having been determined with the device. Anastomotic bursting pressure (ABP) was determined after the measurement using the methods described in our previous study [18]. The anastomotic segment was harvested, and stained with hematoxylin and eosin (HE). The slides were scored using the Ehrlich and Hunt numerical scale as modified by Phillips et al. [20].

Statistical analysis

Statistical analysis was performed with GraphPad Prism 6.0 (GraphPad Software, Inc. CA, USA). Data are presented as mean \pm standard deviation (S.D.), unless stated otherwise. The Mann-Whitney test, t-test, Pearson correlation test, and ROC analysis were employed. All reported p values were two-sided; a p-value < 0.05 was considered to indicate statistical significance.

RESULTS

Perioperative LHI and anastomotic healing in normal rats

Twenty-one rats (450-550 grams) were employed. Weight loss and diarrhea after operation were observed in all rats. Two deaths occurred after surgery with no signs of AL

during autopsy.

The baseline LHI was similar between the ascending and descending colon. Although LHI changes were observed during colectomy, average LHI remained stable at both cutting edges. Similar LHI to the baseline was found at the anastomotic site after construction ($p > 0.05$). None of the intraoperative LHI measurements showed a significant correlation with ABP on POD3 (Fig. 3).

The correlation between postoperative LHI and ABP on POD3 yielded statistical significance ($R^2 = 0.52$, $p < 0.001$). Further linear regression analysis showed that $Y = 0.044 * X + 1.0$ (Y stands for ABP; X stands for anastomotic LHI on POD3, Fig. 4).

Validating the LHI measurements in a colitis-colectomy model

Based on the results of the previous experiment, postoperative LHI measurements were repeated in 15 rats with colitis after colectomy. One death occurred after surgery, and no sign of AL was observed during autopsy. Similarly, LHI on POD3 yielded a significant correlation with ABP in the colitic rats after colectomy ($R^2 = 0.63$, $p = 0.0012$). Further linear regression analysis showed that $Y = 0.088 * X - 22.22$, $p = 0.0012$, (Y stands for ABP; X stands for LHI; Fig. 4).

Diagnostic value of postoperative LHI measurement

Combining the data from the two experiments, we still observed a significant correlation between LHI and ABP (Fig. 4). Moreover we found the postoperative LHI showed high accuracy in detecting failed anastomotic healing. Based on our previous rat experiments, $ABP < 50$ mmHg was set to determine if an anastomosis was mechanically insufficient [23]. As is shown in Figure 4, anastomotic LHI on POD3 had high accuracy for identifying $ABP < 50$ mmHg. AUC was (0.86, SE = 0.065, 95%CI = 0.74 to 0.99, $p < 0.001$). Further analysis showed that a cutting-off point of 1236 yielded a sensitivity of 100% (95%CI = 77-100%) and a specificity of 65% (95%CI = 28-86%), a positive predictive value (PPV) of 70%, a negative predictive value (NPV) of 100%, and an accuracy of 81%.

To enable comparisons between rats with sufficient/insufficient anastomotic LHI on POD3, the rats were further assigned into two groups based on perfusion. Rats with a higher anastomotic LHI than the cutting off point (i.e. 1236) were assigned into a sufficient perfusion group (SPG, $n = 11$) including 10 normal rats and 1 colitis rat, while the other rats were

divided into an insufficient perfusion group (IPG, n = 20) including 5 normal rats with the 12-suture anastomosis, all 3 normal rats with the 5-suture anastomosis, and 12 colitis rats.

In total, 8 animals had an anastomotic dehiscence, all from IPG. Significantly higher weight loss (39.8 ± 11.4 gram vs. 29.3 ± 16.9 gram, $p = 0.048$) and higher abscess score (2.3 ± 1.4 vs. 1.2 ± 0.8 , $p = 0.034$) was found in IPG as well when compared to SPG (Figure 4). An average bursting pressure of 38.2 ± 26.4 mmHg was seen in IPG, which was significantly lower than that in SPG (98.7 ± 34.0 mmHg, $p < 0.001$, Figure 4). In histological evaluation, IPG showed a significantly worse status of inflammatory infiltration and collagen deposition ($p < 0.05$ respectively).

DISCUSSION

Evaluation of anastomotic perfusion may be a reliable strategy to reveal the wound healing status and to detect anastomotic leakage after gastrointestinal surgery. In this study, we demonstrated a correlation between LHI and anastomotic healing in a rat colectomy model with a novel mDLS device, and further validated it in a surgical IBD model, exploring its diagnostic value. These data encourage further investigation of the device in detecting AL in gastrointestinal surgery.

Though recognizing the importance of tissue perfusion in anastomotic healing, few strategies exist to assist surgeons objectively determining anastomotic perfusion once the laparotomy is closed. Several early attempts from the previous literature suggest that an elevation of indirect parameters (e.g. pH, lactate, and pyruvate) might indicate occurrence of AL [2, 14, 24]. Direct correlation between anastomotic perfusion and its healing process has not yet been established. In this study, such a correlation were observed in both experiments regardless of the primary disease, which, in combination with the ROC analysis, provided direct evidence regarding the diagnostic value of the LHI measurements. In addition to the satisfactory diagnostic value for identifying mechanically weak anastomoses, poorer clinical manifestations including anastomotic dehiscence and abscess formation were found in the rats. Such differences were in line with the histological findings revealing worse inflammation and collagen deposition in the rats with insufficient anastomotic perfusion.

Our data, in correspondence with the previous literature, confirm the crucial role of tissue perfusion in the process of anastomotic healing.

Different from postoperative measurements, many clinical trials have suggested a clinical value of the intraoperative perfusion measurement in detecting anastomotic ischemia [9, 12, 13, 25]. However, the limitation of such methods is clearly illustrated by our data. The LHI data of the three rats with insufficient sutures demonstrate that bowel ischemia may not exist during operation under circumstances when AL is caused by certain intra-operative factors, let alone postoperative ones. Nevertheless, our data do not oppose the any further application of intra-operative evaluation because rather than a standardized rat model without preoperative risk factors, substantial risk factors resulting from patient-related comorbidities (e.g. uncontrolled diabetes, smoking, atherosclerotic calcification) may cause bowel hypoxemia before the operation, which are probably detectable with the intraoperative perfusion measurement [26-28]. Moreover, our on-going studies revealed certain pre- or intra-operative risk factors also influenced LHI changes during surgery (unpublished data). Further investigations with comprehensive analysis in this regard are still in request.

The application of postoperative perfusion measurement consists at least two directions. One evident lead is represented by objectively evaluating bowel perfusion during the examination or re-intervention in patients suspicious of AL. Such application is in great need because in many cases bowel ischemia is not detectable by naked eyes during re-operation [24]. Moreover, our study also showed that mechanically insufficient anastomoses were not always accompanied by anastomotic abscess formation or dehiscence. Perfusion measurement may aid to a better surgical plan based on a real-time bowel perfusion level and speculate the mechanical strength of a suspicious anastomosis in circumstances when clinical manifestations remain inconclusive. These measurements can be implemented in combination with a laparoscopic approach due to the miniaturized size of the device. It can also be applied in combination with endoscopy for postoperative examination, as mucosal and serosal blood flow measurements are linear correlated [29].

Another avenue is postoperative real-time monitoring of anastomotic perfusion. The main strength of this mDLS device, its miniaturized size, enables such possibility, but it remains technically challenging. How to place it properly near the anastomosis and how to retreat it are still major questions to be verified. Combining the perfusion sensor with an intra-abdominal drainage or with intra-gastrointestinal tube might be a promising strategy

[30], and further investigation in this regard is still required with large animal models. Although difficult with the current technique, this remains a promising approach in the future. Doctors may implement real-time monitoring in patients with Bluetooth and data processing software, alarming them when an early stage AL occurs.

In addition to the technological development of the medical device, further investigation should also focus on LHI data mining. The DLS system has been developed for decades for various clinical indications [15, 31]. The device in our study has been previously tested in human subjects at different clinical conditions for assessment of capillary skin flow, RBC-endothelial interaction and pulse wave hemodynamic characteristics [31]. We analyzed the data with a frequency between 1-5 kHz in the current study, which is considered as the best representative of tissue perfusion [16, 17]. Substantial data shall be further extracted to investigate the microcirculation with other characteristics. Integrating the data from different frequencies may reveal not only the hemodynamic characteristics but also the tissue oxygenation level, providing a comprehensive picture of the tissue environment. Investigations addressing these regards are currently underway in our research team.

CONCLUSION

In conclusion, our data suggest that postoperative blood flow evaluation with an mDLS device at the anastomotic site provides useful information regarding anastomotic healing, and may facilitate detection of anastomotic leakage in gastrointestinal surgery.

REFERENCES

1. Snijders, H.S., et al., Meta-analysis of the risk for anastomotic leakage, the postoperative mortality caused by leakage in relation to the overall postoperative mortality. *Eur J Surg Oncol*, 2012. 38(11): p. 1013-9.
2. Komen, N., et al., Anastomotic leakage, the search for a reliable biomarker. A review of the literature. *Colorectal Dis*, 2008. 10(2): p. 109-15; discussion 115-7.
3. Erb, L., N.H. Hyman, and T. Osler, Abnormal vital signs are common after bowel resection and do not predict anastomotic leak. *J Am Coll Surg*, 2014. 218(6): p. 1195-9.
4. Hyman, N., et al., Anastomotic leaks after intestinal anastomosis: it's later than you think. *Ann Surg*, 2007. 245(2): p. 254-8.
5. Rahbari, N.N., et al., Definition and grading of anastomotic leakage following anterior resection of the rectum: a proposal by the International Study Group of Rectal Cancer. *Surgery*, 2010. 147(3): p. 339-51.
6. Cong, Z.J., et al., Systematic review of anastomotic leakage rate according to an international grading system following anterior resection for rectal cancer. *PLoS One*, 2013. 8(9): p. e75519.
7. Law, W.I., et al., Risk factors for anastomotic leakage after low anterior resection with total mesorectal excision. *Am J Surg*, 2000. 179(2): p. 92-6.
8. Guo, S. and L.A. Dipietro, Factors affecting wound healing. *J Dent Res*, 2010. 89(3): p. 219-29.
9. Vignali, A., et al., Altered microperfusion at the rectal stump is predictive for rectal anastomotic leak. *Dis Colon Rectum*, 2000. 43(1): p. 76-82.
10. Wang, H., et al., Multimodal optical imaging can reveal changes in microcirculation and tissue oxygenation during skin wound healing. *Lasers in surgery and medicine*, 2014.
11. Núñez, S.C., et al., He-Ne laser effects on blood microcirculation during wound healing: A method of in vivo study through laser Doppler flowmetry. *Lasers in surgery and medicine*, 2004. 35(5): p. 363-368.
12. Boyle, N.H., et al., Intraoperative scanning laser Doppler flowmetry in the assessment of gastric tube perfusion during esophageal resection. *J Am Coll Surg*, 1999. 188(5): p. 498-502.
13. Karliczek, A., et al., Intraoperative assessment of microperfusion with visible light spectroscopy in esophageal and colorectal anastomoses. *Eur Surg Res*, 2008. 41(3): p. 303-11.
14. Daams, F., et al., Prediction and diagnosis of colorectal anastomotic leakage: A systematic review of literature. *World J Gastrointest Surg*, 2014. 6(2): p. 14-26.
15. Fine, I., et al., A non-invasive method for the assessment of hemostasis in vivo by using dynamic light scattering. *Laser Physics*, 2012. 22(2): p. 469-475.
16. Hathcock, J.J., Flow effects on coagulation and thrombosis. *Arteriosclerosis, thrombosis, and vascular biology*, 2006. 26(8): p. 1729-1737.
17. Papaioannou, T.G. and C. Stefanadis, Vascular wall shear stress: basic principles and methods. *Hellenic J Cardiol*, 2005. 46(1): p. 9-15.
18. Wu, Z., et al. A rat model of anastomotic leakage created by insufficient sutures after partial colectomy. in *British journal of surgery*. 2013: WILEY-BLACKWELL 111 RIVER ST, HOBOKEN 07030-5774, NJ USA.
19. Menozzi, A., et al., Long-term study of TNBS-induced colitis in rats: focus on mast cells. *Inflamm Res*, 2006. 55(10): p. 416-22.
20. Rodgers, K., et al., Angiotensin II increases host resistance to peritonitis. *Clin Diagn Lab Immunol*, 2000. 7(4): p. 635-40.
21. Verco, S.J.S., et al., Development of a novel

- glucose polymer solution (icodextrin) for adhesion prevention: pre-clinical studies. *Human Reproduction*, 2000. 15(8): p. 1764-1772.
22. Zuhlke, H.V., et al., [Pathophysiology and classification of adhesions]. *Langenbecks Arch Chir Suppl II Verh Dtsch Ges Chir*, 1990: p. 1009-16.
23. Wu, Z., et al., The prevention of colorectal anastomotic leakage with tissue adhesives in a contaminated environment is associated with the presence of anti-inflammatory macrophages. *International journal of colorectal disease*, 2014: p. 1-10.
24. Daams, F., et al., Identification of anastomotic leakage after colorectal surgery using microdialysis of the peritoneal cavity. *Techniques in coloproctology*, 2014. 18(1): p. 65-71.
25. Komen, N., et al., High tie versus low tie in rectal surgery: comparison of anastomotic perfusion. *Int J Colorectal Dis*, 2011. 26(8): p. 1075-8.
26. Tateishi, S., S. Arima, and K. Futami, Assessment of blood flow in the small intestine by laser Doppler flowmetry: comparison of healthy small intestine and small intestine in Crohn's disease. *J Gastroenterol*, 1997. 32(4): p. 457-63.
27. Wilson, S.B., P.E. Jennings, and J.J. Belch, Detection of microvascular impairment in type I diabetics by laser Doppler flowmetry. *Clin Physiol*, 1992. 12(2): p. 195-208.
28. Komen, N., et al., Calcium score: a new risk factor for colorectal anastomotic leakage. *Am J Surg*, 2011. 201(6): p. 759-65.
29. Tateishi, S., S. Arima, and K. Futami, Assessment of blood flow in the small intestine by laser Doppler flowmetry: comparison of healthy small intestine and small intestine in Crohn's disease. *Journal of gastroenterology*, 1997. 32(4): p. 457-463.
30. Millan, M., et al., Early prediction of anastomotic leak in colorectal cancer surgery by intramucosal pH. *Dis Colon Rectum*, 2006. 49(5): p. 595-601.
31. Fine, I. and A. Kaminsky. Speckle-based measurement of the light scattering by red blood cells in vivo. in *SPIE BiOS. 2011: International Society for Optics and Photonics*.

LEGEND TO FIGURES

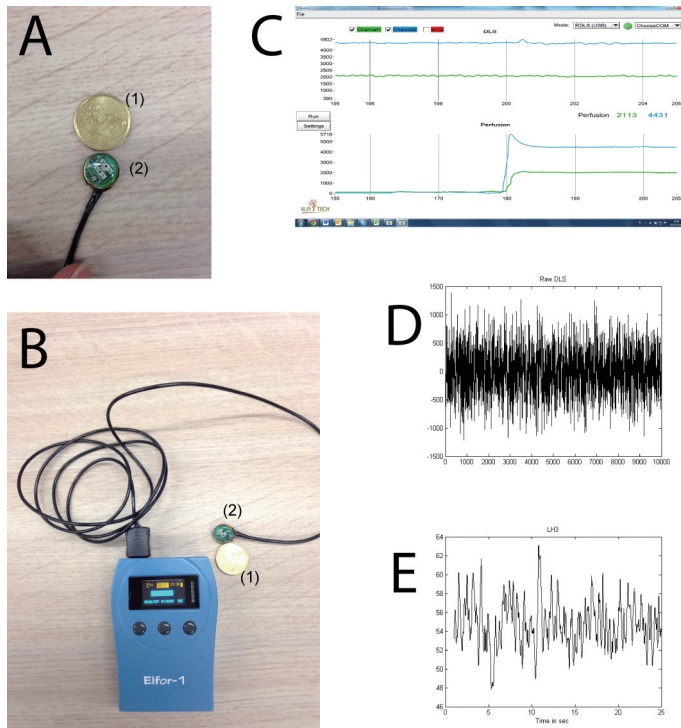

Figure 1. The miniaturized Dynamic Light Scattering (mDLS) device, software interface and local hemodynamic index (LHI) data. (A) The mDLS sensor, (1) 10 cent euro coin, (2) the sensor, size: 10mm*10mm*1mm. (B) The mDLS device, size: 8cm*5cm*1.5cm. (C) Interface of the real-time monitoring software. (D) Raw LHI data recorded by the device. (E) LHI data extracted from raw data, 1-5kHz.

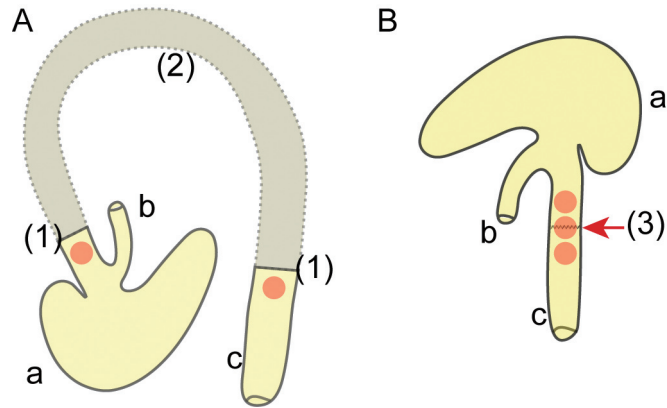

Figure 2. Schematic overview of the rat colon and the locations of perfusion measurement, anterior view. (A) Before colectomy. (B) After colectomy. Anatomy: a. caecum, b. terminal ileum, c. rectum and anus. Procedure: (1) The baseline local-hemodynamic index (LHI) is first measured before colectomy at the intended cutting edges (i.e. indicated with orange spots); (2) A major part of the colon (i.e. indicated with grey colour) is resected; (3) The anastomosis (red arrow) is constructed and the LHI is measured again. Adapted from Wu et al. (2014) with permission.

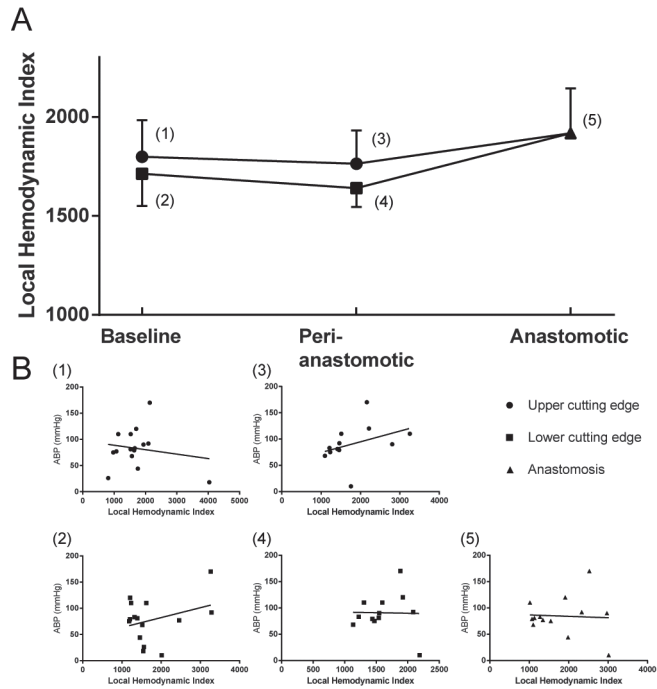

Figure 3. Local hemodynamic index (LHI) during colectomy and correlations between intraoperative LHI and the anastomotic bursting pressure (ABP) in normal rats. Only rats with the 12-suture anastomosis were included, $n = 12-15$; three rats with the 5-suture anastomosis were excluded for analysis. (A) The baseline LHI was similar between the intended upper and lower cutting edges, which remained stable during the operation; similar LHI to the baseline was found at the anastomotic site ($p > 0.05$ respectively), values are mean (\pm S.E.), paired Mann-Whitney test. (B) None of the intraoperative LHI showed a significant correlation with ABP ($p > 0.05$ respectively).

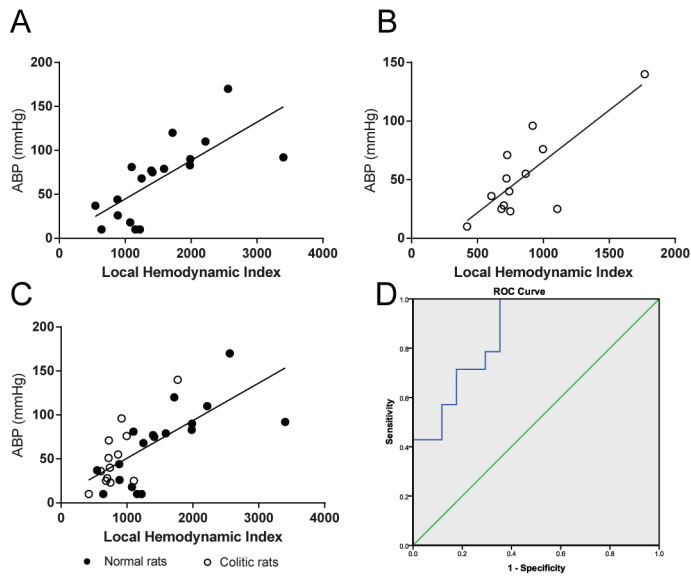

Figure 4. Correlation between the postoperative local hemodynamic index (LHI) and the anastomotic bursting pressure (ABP) on postoperative day (POD) 3. The X-axis is the anastomotic LHI on POD 3. The Y-axis is the ABP on POD 3. (A) In the normal rats, the linear regression analysis showed that $Y = 0.044 * X + 1.0$, $R^2 = 0.52$, $p < 0.001$, $n = 18$. (B) In the colitis rats, $Y = 0.088 * X - 22.22$, $R^2 = 0.63$, $p = 0.0012$, $n = 13$. (C) The correlation between the LHI and ABP remained significant when data of the normal and colitic rats were combined, $Y = 0.043 * X + 8.04$, $R^2 = 0.49$, $p < 0.001$, $n = 31$. (D) ROC analysis showed LHI on POD3 had high accuracy for identifying ABP < 50 mmHg. Area under curve (AUC) = 0.86, S.E. = 0.065, 95%CI = 0.74 to 0.99, $p < 0.001$, $n = 31$.

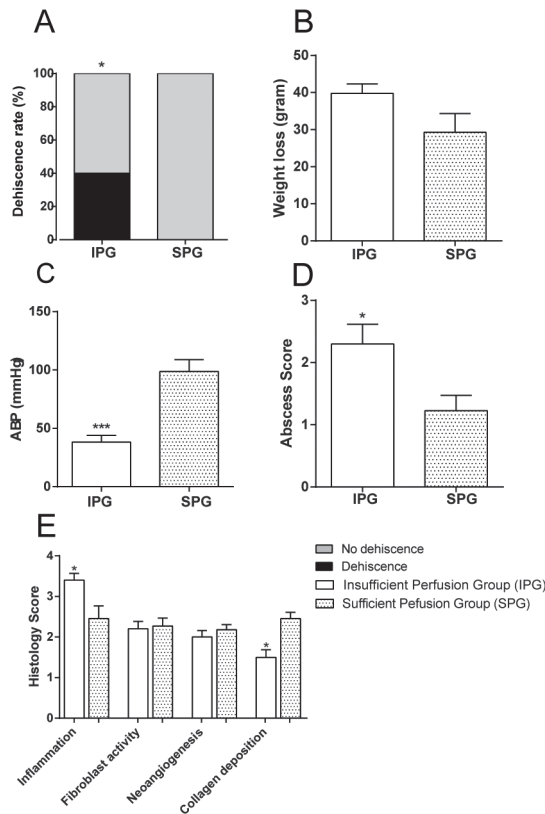

Figure 5. Comparison of clinical and histological outcomes between the insufficient perfusion group (IPG, n = 20) and the sufficient perfusion group (SPG, n = 11). (A) Anastomotic dehiscence rate was 40% (8/20) in IPG and 0% (0/11) in SPG, $p = 0.028$, Chi-square test. (B) Comparison of weight loss yielded a $p = 0.048$, t test. (C) Comparison of anastomotic bursting pressure (ABP) resulted in $p < 0.001$, Mann-Whitney test. (D) A significantly higher abscess score was found in IPG than that in SPG, $p = 0.034$, Mann-Whitney test. (E) In histological evaluations, the IPG showed a significantly worse status of inflammatory infiltration and collagen deposition, $p < 0.05$ respectively, Mann-Whitney test. * indicates $p < 0.05$, *** indicates $p < 0.001$. In (B-E) values are mean (\pm S.E.).

Chapter 12:

General Discussion: New Perspectives to Investigate Colorectal Anastomotic Leakage

Colorectal anastomotic leakage (CAL) remains the most dangerous complication after surgery. Komen et al. reported a CAL rate of 8.7% from 739 patients operated in Erasmus Medical Center, with a mortality rate of 14.1%¹. Surgeons all recognize the possible tragic outcomes following CAL, and many have encountered this complication in some in their clinical practice.

To date, we still don't understand the mechanisms underlying the etiology of CAL in detail. In many previous studies, CAL is attributed to technical failure or ischemia^{2, 3}. However, arguments may be raised against surgical failure because most anastomoses would be checked for configuration or tested (e.g. the air leak test) after construction to rule out a technically failed anastomosis³. Especially nowadays with wide application of stapler devices, one would expect a higher level of standardization in colorectal anastomoses. Moreover, anastomoses constructed with electrical welding tools also seem to heal sufficiently, while the welding technique itself is known to create ischemia⁴. In our own observations derived from this thesis, we also found that anastomoses with numerous numbers of sutures, though causing substantial localized ischemia, did not increase the CAL rate⁵. Moreover, in many other circumstances such as contaminated surgery and perioperative use of corticosteroids, neither technical failure nor ischemia may explain the direct cause of a higher CAL rate, suggesting that other factors are also involved⁶⁻¹⁰.

Our study group has been focusing on diagnostic and preventive strategies of CAL in both clinical and experimental studies. In this thesis, we reported nine studies with regard to CAL prevention and detection. Integration of the previous literature and our experiments may bring some innovative perspectives to understand this vital postoperative complication, and may help unveil the corresponding prevention or treatment strategies.

Most animal models introduce one risk factor of CAL for methodological purposes, which is also applicable in the models described in this thesis. Each of the studies mainly targets one factor. For example, the CAL model described in Chapter 2 and the ex-vivo porcine colon model (Chapter 7) focused on increasing possibility of communication between the intestinal lumen and peritoneal cavity; the peritonitis model in Chapter 8 only induced anastomotic infection into a mechanically sufficient anastomosis; the surgical IBD model (Chapter 9) was derived from the standard colectomy model in Chapter 2 with one healing disturbance (experimental colitis caused by TNBS, i.e. trinitrobenzene sulfonic acid).

Importantly, although varying risk factors have been introduced in these models respectively, similar characteristics of CAL are observed, which can be mainly categorized into: communication, infection, and healing disturbances. Communication stands for the classic definition of CAL: “communication between the intra- and extra-luminal compartments of the anastomotic bowel” 11. Infection stands for bacterial infection at the anastomotic site. Healing disturbances represent pathological factors that may cause delay in anastomotic healing. In our studies, communication (e.g. macroscopic anastomotic dehiscence or microscopic leakage) was seen in many rats regardless of the original anastomosis being sufficient or not (Chapter 2, 8 and 9). Anastomotic infection, usually shown as anastomotic abscess or peritonitis, was also seen in rats without pre-operative or intra-operative contamination (Chapter 2, 9). Healing disturbances such as anastomotic ischemia were recorded in rats with CAL regardless of the existence of preoperative anastomotic ischemia. These observations suggest that for each of the three factors, it may be the main cause leading to the other two; yet it may also be the result of the other factor(s).

1.1 New perspectives to understand the CAL animal models

The above-mentioned perspectives may assist future investigations on CAL from an

integrated point of view.

Classical models of CAL are usually based on mechanical failure 12. Our research group validated the first mouse CAL model by performing insufficient sutures in colon anastomosis 13 and reported the first rat CAL model in Chapter 2. As mentioned, such models have been challenged because a surgeon consciously making an insufficient anastomosis is inconceivable in a clinical setting. However, the artificial mechanical failure is designed to increase the incidence of communication between the intra- and extra-luminal compartments in those models, which further causes anastomotic infection or fecal peritonitis. It is known that severe infection also significantly reduces organ perfusion 14, which may further worsen the healing process of the anastomosis, resulting in CAL.

Substantial clinical and experimental data of anastomoses created in a contaminated environment indicate that anastomosis that created under contamination also causes CAL 2, 8, 9, 15-17. The Cecum-ligation-puncture (CLP) model has been frequently employed to create bacterial peritonitis in rodents; combined with colorectal anastomosis, this model represents contaminated colorectal surgery 16, 17. As reported in Chapter 8, infection of a mechanically sufficient anastomotic site causes abscess formation and even anastomotic dehiscence. In the CLP model, bacterial endotoxins activate the inflammatory response and cause infiltration of inflammatory cells, including type 1 macrophages, which produce nitric oxide by inducible nitric oxide synthase (iNOS). This overexpression of iNOS is associated with a decrease in collagen deposition 18, 19, which eventually causes a delay in wound healing and subsequent communication between intra- and extra-luminal bowel compartments.

One well recognized healing disturbance is represented by anastomotic ischemia. Blood flow reduction at the rectal stump is associated with an increased risk of CAL 2. In animal models, ligation of mesenteric arteries causes anastomotic ischemia and compromised anastomotic healing 20. Clinical data also demonstrate that surgical techniques also influence bowel perfusion 21. In addition to that, another frequently described healing disturbance is compromised collagen formation at the anastomotic site, which is indicated as a lower level of hydroxyproline 20 or lower collagen I/III ratio 22. Such delay in collagen synthesis, especially in the early postoperative phase, may increase the possibility of communication via microscopic leaks, causing infection and CAL. This explains that anastomotic dehiscence may be observed during follow-up in those who had sufficient but

ischemic anastomosis (unpublished data).

1.2 Future perspectives of CAL models

Standardized CAL models derived from the same conceptual basis (i.e. the colectomy model) are important for future studies to increase similarity and comparability between studies. Based on our data, we believe the colectomy model as described in Chapter 2 (i.e. control group) is one good basis for such a purpose. In the current thesis, we derived two CAL models from it by combining different CAL risk factors with the colectomy model. The first derivative is the insufficient anastomosis model, which is known to cause CAL by increasing the incidence of communication between the intra- and extra-luminal compartments; the second derivative is the surgical inflammatory bowel disease (IBD) model reported in Chapter 9, which resulted in higher CAL rate following the healing disturbances, i.e. bowel inflammation and ischemia caused by colitis. Both derivative CAL models resulted in compromised anastomotic healing in the disease groups with very constant and reproducible data in the control group. Other risk factors may be further combined with the colectomy model.

Due to the fact that the three important factors (i.e. communication, infection, and healing disturbances) all play an important role in the occurrence of CAL, we recommend including outcome evaluations covering all three factors in the future studies. The observation and evaluation of communication or infection are relatively easy compared to healing disturbances. Healing disturbances cover a multitude of situations and primary diseases; however, a good and direct parameter representing healing disturbances is not yet available. As is described in Chapter 11, anastomotic perfusion may be a valuable direct parameter. In Chapter 8 and 9, we also investigated the involvement of macrophage subtypes in the anastomotic healing process. Both parameters (i.e. anastomotic perfusion and macrophage index) showed significant correlations with the anastomotic healing process. However, our current data cannot confirm which of these parameters is the most useful for monitoring healing disturbances. Further investigations should also focus in this aspect, exploring the molecular mechanisms of CAL, which may further identify the ideal parameters for healing disturbances.

2.1 New perspectives to prevent CAL

In Part II we investigated tissue adhesives for the prevention of CAL., which is only

one of the strategies in the prevention of CAL. Nevertheless, our studies have shown that application of the selected tissue adhesives (TissuCol®, Histoacryl® Flex, and Duraseal®) as anastomotic sealants integrates various favorable effects rather than simply providing additional strength.

In Chapter 8, we found that in addition to the sealants with strong adhesiveness (e.g. Histoacryl® Flex), application of anastomotic sealant known to have little adhesive strength (TissuCol® and Duraseal®) still prevented anastomotic infection in contaminated surgeries and thus reduced the occurrence of AL 15. This suggests that the sealing effect plays an important role in the effect of adhesives in prevention of anastomotic infection caused by fecal peritonitis. Such beneficial influence is mediated by alternatively active macrophages: less M1-macrophages and more M2-macrophages were seen at the anastomotic site. Nitro oxide produced by M1-macrophages is known to impair collagen deposition and delay wound healing. So it seems that application of tissue adhesives also attenuates the healing disturbance due to the accumulation of M1-macrophages.

Similar results were also observed in the surgical IBD model in Chapter 9. The rates of postoperative infectious complications may reach as high as 68% when IBD patients receive high doses steroids 23, 24. A major course of the infectious complications (e.g. pelvic sepsis) is leakage at the sutured or stapled anastomotic site 23, 25. In Chapter 9 therefore, we validated a novel surgical IBD model by combining the classical TNBS-colitis model with our colectomy model, enabling future research to study the influence of different treatments on postoperative complication in IBD cases. Instead of systematical treatments targeting healing disturbances (in this case: IBD), we continued on another strategy in this model: application of the selected tissue adhesives as anastomotic sealants. As was shown in the results, we found the aforementioned three selected adhesives all showed a beneficial effect on anastomotic healing in the colitis model although none of them had any known pharmacological effect on IBD. However, among the selected adhesives, only Histoacryl® Flex showed significant protective effect on anastomotic healing.

In summary, in PART II we evaluated the mechanical properties of the tissue adhesives, and tested them in different circumstances. In addition to their evident indications (e.g. strong adhesiveness of cyanoacrylate to reinforce an insufficient anastomosis; sealing effect of the selected tissue adhesives to protect anastomotic infection), we also found that using these tissue adhesives in an IBD environment also improves anastomotic healing. The

data from PART II suggest that prevention targeting on one factor (not necessary the main etiological factor) may contribute to the prevention of CAL, which may lead to innovative strategies in the prevention of CAL in the future.

2.2 Future perspectives to prevent CAL

We reported a series of studies regarding prevention of CAL with the tissue adhesives in Part II. Our data support further application, especially Histoacryl® Flex, for CAL prevention. Before clinical application, further tests in a porcine model should be performed to evaluate technical details. Because of the minimal foreign body response and satisfactory effect observed in our studies (Chapter 8, 9 and unpublished data), case series studies regarding clinical application of Histoacryl® Flex may be attempted after these porcine studies. Patients with higher risks of developing CAL (e.g. contaminated urgent surgery) should be considered for such application. Special focus should be directed at the technique of application of the adhesive: in the clinical situation a substantial part of the anastomosis cannot easily be approached because of mesentery, pelvic position or both. Innovations for a convenient applicator are in great need to this end.

Other preventive strategies may also be investigated with our CAL models. One important field regarding prevention of postoperative complications in IBD patients has not yet been explored due to lacking of animal models. The novel surgical IBD model developed by our research group and described in Chapter 3 and 9 may greatly assist research focusing on perioperative pharmacological regimes in IBD patients. In general, we believe many strategies targeting the three etiological factors can be tested in the animal models.

3.1 New perspectives regarding detection of AL

The detection of CAL starts directly after construction of anastomoses. Air leak tests have been widely used worldwide to detect mechanically failed anastomosis. Lavage is used in contaminated surgeries, and surgeons also ensure clearance of visible anastomotic contamination before closing the abdomen. However, with current strategies, many CAL are not detected until clinical symptoms become apparent 26, 27.

In many cases nowadays, the diagnosis of AL is based on CT or trans-anal contrast test, or the combination of the two. However, the greatest concern is that a decision of a

radiological examination depends on the surgeon's awareness. Postoperatively, clinical manifestations are evaluated and recorded on a daily basis in clinical practice, so are laboratory tests. Surgeons are aware that when the clinical situation becomes worse, actions or even reoperation are required. However, the literature provided us with limited data regarding the prediction of CAL with regard to a trend of clinical manifestations. In our systematic review (Chapter 10), we found one main concern in diagnosing CAL is that most clinical strategies regarding anastomotic leakage detection focus on the actual value of different tests at individual time points rather than their dynamic change over time 28. Most studies compared the actual value of different parameters of CAL patients with those without CAL. Many of them found that abnormal lab test results or vital signs are common after colorectal surgery and lack satisfactory predicting value 29.

However, such conclusions may not reveal the full picture of postoperative manifestations. The change pattern or trend of those manifestations has been shown to be more informative than the actual data. We noticed that one study from den Dulk and colleagues took repeated evaluation into account, finding satisfactory results 30. Many investigations focused on early biomarkers of anastomotic infection. However, much improvement can still be made. For example, the most frequent used systematic parameters for infection are white blood cell count or C-reactive protein, which are routinely tested. However, these parameters are mostly systematic parameters for inflammation, while CAL is usually localized at an early stage, explaining for the limited predictive value for early detection of CAL 28. Similar problems also occurs with CRP as many studies have pointed out the CRP level has more value for exclusion CAL than selecting CAL patients. Several studies have pointed out that the accuracy of peritoneal cytokine analysis showed much better and earlier predicting value in CAL diagnosis. For example, intra-abdominal evaluation of inflammatory parameters such as IL-6 and TNF- α showed promising results, which were increased earlier than the occurrence of clinical signs 31.

Anastomotic ischemia is another good target for detecting CAL. In Chapter 11, we found satisfactory results in detecting CAL with anastomotic perfusion measurements with the miniaturized device in the rat CAL models. Our previous study also showed that microdialysis technique targeting ischemic parameters (e.g. lactate, pyruvate, glucose and glycerol) assists in the detection of CAL. With ongoing technological development, anastomotic blood flow and lactate levels can be continuously monitored. A similar strategy was also used in peritoneal microdialysis with satisfactory results 32. In Chapter 11, we

used the miniaturized laser flowmetry device, which can provide a real-time measurement of perfusion around the anastomosis. Combination of different intra-peritoneal markers and their trends may provide useful information regarding early signs of CAL.

3.2 Future perspectives to detect CAL

Development of medical technology may bring a revolution in detection of CAL. Our research suggests two main directions for further development of early CAL diagnosis, both requiring further integration of the current approaches. One of these directions is data mining. The systematic review in Chapter 10 clearly demonstrates that the current way of interpreting clinical data (e.g. clinical signs, symptoms, and laboratory tests) is not sufficient to detect early signs of CAL. Innovative computing algorithms (e.g. artificial neural network) has been greatly developed in the recent years and showed inspiring results in detecting appendicitis or other diseases 33, which may also facilitate the detection of CAL in this regard. Before prospective cohorts, re-exploration of the existing database (e.g. data from Dutch institute for clinical auditing, DICA) may already provide useful information regarding conventional clinical signs and lab tests. Such work will require a large database as well as substantial expertise in data analysis and statistical techniques. Multidisciplinary collaboration should be encouraged in these studies.

The other direction is to focus on localized early changes in CAL occurrence. Further investigation on intra-peritoneal fluid may be helpful. But due to the fact that postoperative abdominal drainage is now being used in substantially less colorectal patients, other alternative strategies are still needed. In one previous study, we tested the technique of peritoneal microdialysis. Though useful, it seems such intervention is still not ideal because application and maintenance of the device may still cause additional discomfort to the patients. One solution might be intra-luminal implementation of microchips with multichannel measurements. The principle of such a strategy has been demonstrated, but the actual prototype and eventual product still awaits technological development.

Battles against human diseases are always arduous, which require dedication of many generations of researchers. Although we remain unable to provide one ideal strategy or strategies to conquer CAL at the end of this thesis, several achievements haven been scored. We validated a novel rat colectomy model and derived several rat CAL models by

combining varying risk factors respectively. These models are believed to facilitate the future CAL research, providing more concise and standardized results. We systematically evaluated mechanical properties of the tissue adhesives and tested them in different circumstances including the CAL models, in which Histoacryl® Flex yielded inspiring outcomes and seems to be ready for early clinical attempts. We summarized the clinical strategies regarding the detection of CAL, and demonstrated the feasibility of detecting early CAL by monitoring postoperative anastomotic perfusion with a miniaturized flowmetry device. Last but not least, we propose three factors (i.e. communication between intra- and extra-luminal compartment, anastomotic infection, and healing disturbances) based on our observation, which seem to be actively involved in the occurrence of CAL in a synergistic manner. This innovative perspective may help the future studies to gain insight in an integrated manner during battling against CAL. On behalf of myself, and all the co-authors and people that contributed to the work included in this thesis, we believe our efforts will be paid off and patients will benefit from our work in the near future.

REFERENCES

1. Komen N, Dijk JW, Lalmahomed Z, Klop K, Hop W, Kleinrensink GJ, Jeekel H, Ruud Schouten W, Lange JF. After-hours colorectal surgery: a risk factor for anastomotic leakage. *Int J Colorectal Dis* 2009;24(7): 789-795.
2. Vignali A, Gianotti L, Braga M, Radaelli G, Malvezzi L, Di Carlo V. Altered microperfusion at the rectal stump is predictive for rectal anastomotic leak. *Dis Colon Rectum* 2000;43(1): 76-82.
3. Ricciardi R, Roberts PL, Marcello PW, Hall JF, Read TE, Schoetz DJ. Anastomotic leak testing after colorectal resection: what are the data? *Arch Surg* 2009;144(5): 407-411; discussion 411-402.
4. Ho YH, Ashour MA. Techniques for colorectal anastomosis. *World J Gastroenterol* 2010;16(13): 1610-1621.
5. Daams F, Monkhorst K, van den Broek J, Sliker JC, Jeekel J, Lange JF. Local ischaemia does not influence anastomotic healing: an experimental study. *Eur Surg Res* 2013;50(1): 24-31.
6. Konishi T, Watanabe T, Kishimoto J, Nagawa H. Risk factors for anastomotic leakage after surgery for colorectal cancer: results of prospective surveillance. *Journal of the American College of Surgeons* 2006;202(3): 439-444.
7. Sliker JC, Komen N, Mannaerts GH, Karsten TM, Willemsen P, Murawska M, Jeekel J, Lange JF. Long-term and perioperative corticosteroids in anastomotic leakage: a prospective study of 259 left-sided colorectal anastomoses. *Archives of Surgery* 2012;147(5): 447-452.
8. Golub R, Golub RW, Cantu R, Jr., Stein HD. A multivariate analysis of factors contributing to leakage of intestinal anastomoses. *J Am Coll Surg* 1997;184(4): 364-372.
9. Tang R, Chen HH, Wang YL, Changchien CR, Chen JS, Hsu KC, Chiang JM, Wang JY. Risk factors for surgical site infection after elective resection of the colon and rectum: a single-center prospective study of 2,809 consecutive patients. *Ann Surg* 2001;234(2): 181-189.
10. Leichtle SW, Mouawad NJ, Welch KB, Lampman RM, Cleary RK. Risk factors for anastomotic leakage after colectomy. *Dis Colon Rectum* 2012;55(5): 569-575.
11. Rahbari NN, Weitz J, Hohenberger W, Heald RJ, Moran B, Ulrich A, Holm T, Wong WD, Tiret E, Moriya Y, Laurberg S, den Dulk M, van de Velde C, Buchler MW. Definition and grading of anastomotic leakage following anterior resection of the rectum: a proposal by the International Study Group of Rectal Cancer. *Surgery* 2010;147(3): 339-351.
12. Pommergaard HC, Rosenberg J, Schumacher-Petersen C, Achiam MP. Choosing the best animal species to mimic clinical colon anastomotic leakage in humans: a qualitative systematic review. *Eur Surg Res* 2011;47(3): 173-181.
13. Komen N, van der Wal HC, Ditzel M, Kleinrensink GJ, Jeekel H, Lange JF. Colorectal anastomotic leakage: a new experimental model. *J Surg Res* 2009;155(1): 7-12.
14. Bone RC. Sepsis, the sepsis syndrome, multi-organ failure: a plea for comparable definitions. *Annals of internal medicine* 1991;114(4): 332-333.
15. Wu Z, Vakalopoulos KA, Boersema GSA, Jeekel J, Lange JF. Prevention of Anastomotic Leakage with Tissue Adhesives in Contaminated Environment. In: *British journal of surgery*; 2013: WILEY-BLACKWELL 111 RIVER ST, HOBOKEN 07030-5774, NJ USA; 2013. p. 5-5.
16. Hendriks T, Mastboom WJ. Healing of experimental intestinal anastomoses. Parameters for repair. *Dis Colon Rectum* 1990;33(10): 891-901.
17. de Hingh IH, de Man BM, Lomme RM, van Goor H, Hendriks T. Colonic anastomotic strength and matrix metalloproteinase activity in an experimental model of

bacterial peritonitis. *Br J Surg* 2003;90(8): 981-988.

18. Ahrendt GM, Tantry US, Barbul A. Intra-abdominal sepsis impairs colonic reparative collagen synthesis. *Am J Surg* 1996;171(1): 102-107; discussion 107-108.

19. Thornton FJ, Ahrendt GM, Schaffer MR, Tantry US, Barbul A. Sepsis impairs anastomotic collagen gene expression and synthesis: a possible role for nitric oxide. *J Surg Res* 1997;69(1): 81-86.

20. van der Ham AC, Kort WJ, Weijma IM, van den Ingh HF, Jeekel H. Healing of ischemic colonic anastomosis: fibrin sealant does not improve wound healing. *Dis Colon Rectum* 1992;35(9): 884-891.

21. Komen N, Sliker J, de Kort P, de Wilt JH, van der Harst E, Coene PP, Gosselink MP, Tetteroo G, de Graaf E, van Beek T, den Toom R, van Bockel W, Verhoef C, Lange JF. High tie versus low tie in rectal surgery: comparison of anastomotic perfusion. *Int J Colorectal Dis* 2011;26(8): 1075-1078.

22. Grommes J, Binnebosel M, Klink CD, von Trotha KT, Schleimer K, Jacobs MJ, Neumann UP, Krones CJ. Comparison of intestinal microcirculation and wound healing in a rat model. *J Invest Surg* 2013;26(1): 46-52.

23. Beddy D, Dozois EJ, Pemberton JH. Perioperative complications in inflammatory bowel disease. *Inflamm Bowel Dis* 2011;17(7): 1610-1619.

24. Bach SP, Mortensen NJ. Revolution and evolution: 30 years of ileoanal pouch surgery. *Inflamm Bowel Dis* 2006;12(2): 131-145.

25. Gorgun E, Remzi FH. Complications of ileoanal pouches. *Clin Colon Rectal Surg* 2004;17(1): 43-55.

26. Daams F, Luyer M, Lange JF. Colorectal anastomotic leakage: aspects of prevention, detection and treatment. *World J Gastroenterol* 2013;19(15): 2293-2297.

27. Cong ZJ, Hu LH, Bian ZQ, Ye GY, Yu MH, Gao YH, Li ZS, Yu ED, Zhong M. Systematic review of anastomotic leakage rate according to an international grading system following anterior resection for rectal cancer. *PLoS One* 2013;8(9): e75519.

28. Daams F, Wu Z, Lahaye MJ, Jeekel J, Lange JF. Prediction and diagnosis of colorectal anastomotic leakage: A systematic review of literature. *World J Gastrointest Surg* 2014;6(2): 14-26.

29. Wu Z, Freek D, Lange J. Do normal clinical signs and laboratory tests exclude anastomotic leakage? *Journal of the American College of Surgeons* 2014;219(1): 164.

30. den Dulk M, Noter SL, Hendriks ER, Brouwers MAM, van der Vlies CH, Oostenbroek RJ, Menon AG, Steup W-H, van de Velde CJH. Improved diagnosis and treatment of anastomotic leakage after colorectal surgery. *European Journal of Surgical Oncology (EJSO)* 2009;35(4): 420-426.

31. Komen N, de Bruin RW, Kleinrensink GJ, Jeekel J, Lange JF. Anastomotic leakage, the search for a reliable biomarker. A review of the literature. *Colorectal disease : the official journal of the Association of Coloproctology of Great Britain and Ireland* 2008;10(2): 109-115; discussion 115-107.

32. Daams F, Wu Z, Cakir H, Karsten TM, Lange JF. Identification of anastomotic leakage after colorectal surgery using microdialysis of the peritoneal cavity. *Techniques in Coloproctology* 2013: 1-7.

33. Prabhudesai SG, Gould S, Rekhraj S, Tekkis PP, Glazer G, Ziprin P. Artificial neural networks: useful aid in diagnosing acute appendicitis. *World J Surg* 2008;32(2): 305-309; discussion 310-301.

Chapter 13:

Summary in English, Dutch and Chinese

Acknowledgements

List of Publications

Curriculum Vitae

PhD Portfolio

SUMMARY

Colorectal anastomotic leakage (CAL) remains one of the most dangerous complications after gastrointestinal surgery. In this thesis we described 11 studies with regard to the etiology, prevention and detection of CAL.

In **PART I**, we validated a novel rat CAL model by performing an insufficient anastomosis after partial colectomy. Moreover we describe several models derived from the colectomy model.

In **Chapter 2**, we described the rat colectomy model, implementing a 12-suture anastomosis and the first rat CAL model by constructing an insufficient anastomosis (i.e. 5-suture anastomosis). Anastomotic dehiscence, anastomotic abscess and peritonitis were seen in both groups (i.e. 12-suture groups and 5-suture groups), but with significantly higher rate in the insufficient anastomosis group (40-50%) and higher severity as well.

In **Chapter 3**, we summarized the rat models that are used in the subsequent studies in this thesis. In addition to the insufficient anastomosis model, we also introduced an anastomosis model in which the anastomosis is created in a contaminated environment and developed one surgical IBD model. Outcomes from these models demonstrate the three CAL factors that are discussed in Chapter 12 (i.e. communication of intestinal lumen and peritoneal cavity, anastomotic infection and healing disorder) all exist during the occurrence of CAL.

Knowing those three factors, we continued our studies with tissue adhesives in **PART II**.

In **Chapter 4**, we systematically summarized the literature focusing on prevention of CAL with tissue adhesives. The results demonstrated that though numerous studies have been performed, a systematic evaluation of tissue adhesives for the prevention of CAL was still lacking.

In **Chapter 5**, we focused on the studies with regard to CAL prevention with cyanoacrylate glue. The systematic review of the methods employed in those studies indicated that substantial heterogeneity and methodological bias exists in the experimental studies regarding tissue adhesives. Therefore, we performed a series of studies regarding prevention of CAL with tissue adhesives in **Chapter 6, 7, 8 and 9**.

In **Chapter 6**, we evaluated the adhesiveness and rheology of 12 commercially available tissue adhesives. Our results showed that sealants including fibrin and polyethylene glycol glues had very limited mechanical adhesiveness in our ex-vivo model. In that study, cyanoacrylate showed the strongest adhesiveness and satisfactory rheological properties.

In **Chapter 7, 8 and 9**, we tested tissue adhesives in different CAL models targeting on the three etiological factors respectively.

In **Chapter 7**, the insufficient anastomoses were constructed in ex-vivo porcine colon segments, after which the cyanoacrylate glue, i.e. Dermabond, was applied to externally reinforce the anastomoses. The results demonstrated that cyanoacrylate glue was strong enough to reinforce a mechanically insufficient anastomosis. Based on those data, we further applied cyanoacrylate in a mechanically insufficient anastomosis. Significantly increased anastomotic strength with little variation in mechanical strength was seen in anastomoses

with Dermabond reinforcement.

In **Chapter 8**, we performed a colorectal anastomosis in a fecal peritonitis model and applied three select adhesives on the anastomosis as sealant. Different from the previous study, all the anastomoses in this study were mechanically sufficient. The main etiology causing CAL in the model is anastomotic infection caused by peritonitis. As hypothesized, anastomotic dehiscence and compromised anastomotic strength were also observed in the rats with peritonitis. In this model, all three adhesives prevented occurrence of CAL regardless of their adhesiveness. A sealing effect (i.e. preventing contact between intraperitoneal bacteria and the anastomosis) played the main role in prevention of CAL in this model.

With the promising data from **Chapter 8**, we continued our study with their application in Chapter 9, in which we used these adhesives in a surgical IBD model. Different from the previous models, pathological changes of IBD caused both colon inflammation and bowel ischemia, which impairs the anastomotic healing process and causes substantial postoperative complications. In this study, we found that although all the select adhesives yielded a favorable effect on CAL prevention, only Histoacryl Flex (a cyanoacrylate glue) showed significant improvement when compared with the control group. Integrating the results from three studies, our current results encourage further application of Histoacryl Flex in the prevention of CAL.

In **PART III**, we focused on early detection of CAL.

In **Chapter 10**, we summarized the current strategies regarding diagnosis of CAL. Our data showed that current routine methods still not yet have satisfactory results in predicting or early detecting CAL. However, due to the fact that occurrence of CAL is a dynamic process, new strategies such as real-time monitoring of drain fluid products seem to be effective in early diagnosis of CAL. Parameters indicating anastomotic ischemia and infection may manifest earlier changes than radiological signs of anastomotic dehiscence.

In **Chapter 11**, we measured intra and postoperative anastomotic perfusion in the rat colectomy model and demonstrated that anastomoses with normal intraoperative perfusion may still incur ischemia after surgery. Satisfactory results in detecting CAL with a

postoperative perfusion-monitoring device were determined.

In **Chapter 12**, we discussed our work and proposed three factors (i.e. communication of intestinal lumen and peritoneal cavity, anastomotic infection and healing disorder) that are interactively involved in the CAL mechanism. Based on the work described in the thesis, we proposed new perspectives with an integrated approach for investigating its etiology, prevention and detection.

Samenvatting

Naadlekkage (NL) van de anastomose blijft één van de gevaarlijkste complicaties na colorectale chirurgie. In dit proefschrift worden 11 studies naar de etiologie, preventie en detectie van NL beschreven.

In **DEEL 1**, wordt het eerste naadlekkage model in de rat gevalideerd. Daarnaast worden de verschillende rat modellen beschreven die vanuit dit model verder ontwikkeld zijn.

In **hoofdstuk 2**, wordt het naadlekkage model van de rat beschreven. In dit model komt NL tot stand door het aanleggen van een insufficiënte anastomose na een partiële colectomie. Naad-dehiscentie, naad-abcessen en peritonitis werden in zowel de 12 hechtingen groep als de 5 hechtingen groep gezien, maar NL werd significant vaker in de insufficiënte anastomose groep gezien.

In **hoofdstuk 3**, geven we een overzicht van de experimentele onderzoeksmodellen die gebruikt zijn voor de studies in dit proefschrift. Naast het naadlekkage model, zijn ook het

anastomose model in een gecontamineerd milieu en het chirurgische IBD model ontwikkeld. In deze modellen komen de NL symptomen naar voren die aanwezig zijn bij het ontstaan van of gedurende naadlekkage. Zoals genoemd in de discussie laat de uitkomst van deze modellen zien dat we te maken hebben met drie NL factoren die allen aanwezig zijn bij het ontstaan van NL: verbinding tussen de intraluminale darm en het abdomen, infectie van de anastomose en verslechterde wondgenezing.

In **DEEL 2** hebben we de kennis van deze drie risicofactoren voor het ontstaan van naadlekkage gebruikt en ons gefocust op het gebruik van verschillende weefsellijmen ter preventie van naadlekkage.

In **hoofdstuk 4** geven we een overzicht van de literatuur met betrekking tot preventie van NL met weefsellijmen. Uit de resultaten van dit onderzoek bleek dat er wel een aantal studies zijn uitgevoerd met weefslijm en preventie van naadlekkage, maar dat een systematische evaluatie en systematische aanpak van de uitvoering van deze studies ontbrak.

In **hoofdstuk 5**, geven we een weergave van het gebruik van cyanoacrylaatlijm in colorectale anastomoses. Deze studie laat zien dat er een grote variëteit is in de methode van het gebruik van de verschillende lijmen in verschillende diermodellen. Daarom hebben we een serie studies (hoofdstuk 6, 7, 8 en 9) verricht naar de preventie van NL met verschillende soorten weefsellijmen.

In **hoofdstuk 6**, hebben we de reologie en adhesiveness (adhesiviteit van de lijm) van 12 commercieel verkrijgbare lijmen met elkaar vergeleken. Hieruit bleek dat sealants zoals fibrine lijm en polyethyleen glycol (PEG) lijmen een zeer beperkte adhesiveness hebben, en dus maar een beperkte mechanische kracht aankunnen. In tegenstelling tot deze lijmen, liet cyanoacrylaatlijm een sterke adhesiveness zien met voldoende reologische eigenschappen.

In **hoofdstuk 7, 8, en 9** zijn verschillende weefsellijmen getest in naadlekkage diermodellen. Hierbij hebben we ons gericht op de etiologische factoren voor het ontstaan van NL: insufficiënte anastomose, gecontamineerd milieu en IBD.

In **hoofdstuk 7**, hebben we in een ex-vivo model insufficiënte colon-anastomosen aangelegd en vervolgens Dermabond (een cyanoacrylaatlijm) aangebracht om de anastomose te versterken. De resultaten lieten zien dat deze cyanoacrylaatlijm sterk genoeg was om een mechanisch insufficiënte anastomose te versterken.

In **hoofdstuk 8**, hebben we een colon-anastomose in een experimenteel peritonitis model aangelegd. Drie weefsellijmen zijn uitgekozen op basis van de eerdere studies. Deze lijmen zijn circulair op de anastomose aangebracht. Alle anastomosen waren voldoende aangelegd en de voornaamste reden voor het verkrijgen van NL in dit model werd dus veroorzaakt door infectie van de anastomose door het gecontamineerde milieu. Zoals we in onze hypothese hadden verwacht, zagen we vaker een naad-dehiscentie en een verminderde sterkte van de naad in het peritonitis model. Echter, alle drie de lijmgroepen lieten geen NL zien. Alleen afdichting (sealing) van de anastomose ter voorkoming van onder andere contact met bacteriën intraluminaal met de anastomose bleek een belangrijke rol te spelen in de preventie van NL in dit model.

Deze veelbelovende data uit hoofdstuk 8, heeft geleid tot een vervolgstudie. In hoofdstuk 9, presenteren we een studie waarin we dezelfde lijmen gebruiken ter preventie van NL maar dan in een chirurgisch IBD (inflammatory bowel disease) model. De pathologische veranderingen die IBD met zich meebrengt veroorzaakt ontstekingen maar ook darmischemie. Klinisch gezien lopen patiënten met IBD een hoger risico op het ontwikkelen van abscessen en NL na darmoperaties. Ook uit deze studie bleek dat alle lijmen een beschermend effect hadden tegen NL. Echter, alleen Histoacryl Flex liet significante verbetering zien in vergelijking tot de controle groep. De resultaten van deze drie studies sporen zeker aan tot verder onderzoek naar de applicatie van Histoacryl Flex ter preventie van NL.

In **DEEL 3** hebben we ons gefocust op de vroege detectie van NL.

In **hoofdstuk 10**, hebben we de huidige methodes ten aanzien van het stellen van de diagnose naadlekkage samengevat. Deze studie laat zien dat er tot op heden nog geen bevredigende methoden zijn om het ontstaan van NL te voorspellen of vroegtijdig te diagnosticeren. Het ontstaan van NL is een dynamisch proces en daarom lijken nieuwe strategieën zoals ‘real-time monitoring’ van bijvoorbeeld drainvocht effectief voor het vroegtijdig diagnosticeren van NL. Parameters die een indicatie kunnen zijn voor ischemie of infectie van de anastomose komen mogelijk eerder tot uiting dan bijvoorbeeld met beeldvorming.

In **hoofdstuk 11**, hebben we in een rat model de perfusie van de anastomose gedurende darmoperaties gemeten en ook postoperatief; hieruit bleek dat er mogelijk sprake is van

een ischemische anastomose kort na de operatie wat leidt tot NL terwijl dit gedurende de operatie niet aan het licht komt.

In **hoofdstuk 12**, bespreken we alle studies en geven we drie factoren aan die betrokken zijn bij het ontstaan van NL (verbinding tussen de intraluminale darm en het abdomen, infectie van de anastomose en verslechterde wondgenezing). Op basis van de in dit proefschrift beschreven studies geven we nieuwe inzichten in NL etiologie, preventie en detectie.

中文概要

手术后吻合口瘘仍然是结直肠外科术后最危险的并发症之一。本论著共分为三部分，探讨了有关于吻合口瘘的病因、预防及检测。

第一部分中，我们首先介绍了由我们研究组所建立的结直肠术后吻合口瘘的大鼠模型以及在本论著中所使用的其他结直肠术后吻合口瘘的大鼠模型。

在第二章中，我们介绍了标准大鼠结肠切除模型以及不充分肠吻合模型。吻合口开裂，吻合口周脓肿，以及腹膜炎在两个模型中都能被观察到，但与标准肠切除模型相比，不充分肠吻合模型的术后吻合口瘘的发生率高达40–50%。

在第三章中，我们简要介绍了本论著中所涵盖的若干大鼠肠吻合口瘘模型。除了上述不充分肠吻合模型之外，我们同样也介绍了污染吻合口模型、缺血吻合口模型以及我们研究组所首次验证的炎症性肠病吻合口模型。从这些模型中我们发现包括**肠管内外沟通，吻合口感染，以及愈合障碍**等三个因素对吻合口瘘的发生有着重要影响，共同参与了瘘的发生机制。

在掌握了这些结直肠术后吻合口瘘的大鼠模型的基础上，我们开展了利用生物胶来预防肠吻合口瘘的系列研究。

在第四章中，我们对利用生物胶来预防肠吻合口瘘的研究进行了系统综述。我们从中发现：这方面的研究缺乏系统性，不同方法学上的差异使得不同研究的结果很难进行类比。

在第五章中，我们综述了有关氰基丙烯酸盐粘合剂在肠外科应用的相关研究。我们之所以选择氰基丙烯酸盐粘合剂是因其强力粘合能力足以替代缝线或吻合器。从综述中我们发现不同研究在方法学上同样存在很大的不一致，从而引入了大量偏差。总结第四第五章的研究结果，我们研究组在后续进行的研究中采用了更为系统的实验设计方案。

在第六章中，我们系统地分析了12中不同生物胶的粘合力以及流变学特性。我们发现包括纤维蛋白胶及高分子聚乙二醇在内的很多生物粘合剂实际上仅有这非常有限的粘合能力，而只有氰基丙烯酸盐粘合剂拥有强力粘合能力足以加固吻合口。

在第七章中，我们在离体猪结直肠上测试了氰基丙烯酸盐粘合剂（多抹棒）的吻合口加固能力。我们发现多抹棒生物胶在生物力学上完全能够替代缝合线以达到更加优良的加固效果。

在第八章中，我们在污染吻合口大鼠模型中测试了三种生物胶的生物学特性。与之前很多研究所不同的是，该模型中我们使用了充分吻合，因而在该模型中腹腔粪污染为吻合口瘘发生的主要原因。我们发现尽管术中充分吻合，但术后吻合口开裂和吻合口强度下降都能在该模型中被观测到。我们还发现该模型中所挑选的三种生物胶，无论其本身生物强度高，都有效的预防了吻合口瘘的发生。其中起主导作用的可能为生物胶的密封效应而非力学加固效应。

在第八章结果的基础上，我们进一步在炎症性肠病的外科模型中测试了这三种生物胶。该模型的致病因素与上一个研究不同，肠段的病理学改变导致了炎症反应及肠缺血，从而增加了吻合口愈合难度。在这个研究中，尽管我们发现这三种生物胶对吻合口愈合都有有利影响，但仅有Histoacryl Flex（一种氰基丙烯酸盐粘合剂）具有统计学显著的促进作用，其能够显著的减少该模型中吻合口瘘及其他并发症的发生。

在第三部分中，我们的研究集中于吻合口瘘的早期检测。

在第十章中，我们总结了目前临床所使用的吻合口瘘检测手段。我们发现目前临床常规的吻合口瘘检测或预测方法尚难令人满意。由于吻合口瘘的发生是一个动态过程，吻合口局部的指标变化（例如吻合口缺血）要比常规影像学或血清学变化更早出现。包括实时监测等新检测手段或许能够实现更为有效的早期诊断。

在第十一章中，我们在我们的大鼠肠切除模型中测量了吻合口灌注并证明了术后吻合口缺血同样可能发生在术中灌注正常的情况下。与此同时，我们也发现通过监测术后吻合口灌注，我们能够较为准确地估计吻合口的生物力学强度，并早期诊断吻合口瘘。

在第十二章中，我们讨论了本论著的研究成果并提出了**肠管内外沟通，吻合口感染，以及愈合障碍**等三个因素在内的结直肠吻合口瘘整体发生机制。通过对这三因素更为深入的认识，我们能够更进一步提出对结直肠吻合口瘘的整体应对策略。

ACKNOWLEDGEMENTS

First of all, I would like to thank my wife, Ken Lin, who not only supported my PhD fellowship in the Netherlands, but also travelled eight thousand kilometers in person to marry me. More importantly, Ken, you are an excellent cook. You prepared so much delicious Chinese and Western food as well, saving me from endless patate and kaposalon. Now you have dived into the healthcare industry as a consultant, providing your expertise in the reform of the Chinese healthcare system. I sincerely appreciate your courage and spirit inherited from Peking University. I look forward to the future, with confidence and ambition, and with your company.

I would like to thank my parents. Although Chinese don't often say the three words to parents, today I will speak out loud: I love you! Ever since 2005 when I started my medical school, I lived far away from parents (sometimes 1300 KM, sometimes 8000 KM). I have not been serving well as a son, spending too little time with you. So your understanding gives me the best support to dive into my career. Also because of this, I would like to thank all my relatives in China, especially my cousins (许舟, 王舟操, 李也纳) who have been taking great care of my parents. Teaching my mom to use iPhone is certainly a great achievement! Also, probably one of you guys still needs to translate this paragraph into Chinese for my parents, great thanks!

I sincerely thank my promoters Prof. Lange and Prof. Klenrensink, my co-promoter Prof. Jeekel, and supervisor Dr. Menon.

Dear Prof. Lange, you supported me for my whole PhD fellowship. In my first year here, you told me to discuss and to challenge professors like all Dutch do, when Eva was asking you to revise her manuscript. I hope I have been doing it in a good way. Probably I have been raising many strange ideas and questions, but you never prohibited me from

testing my thoughts in a scientific way. Some of them succeeded in publications, but some might not. Most publications in thesis originated from our discussions and innovative thoughts, which would not be possible without your continuous support.

Dear Prof. Kleinrensink, our first official discussion started with great coffee in your office. You continuously helped me with my work, and sometimes even found us the “cool” place (4 degree centigrade, where the human corps are stored) to perform our cool research. Our topics of discussions are certainly not limited in science but many times in music and other culture. Your optimism was always encouraging when we confronted the challenges during the research.

Dear Prof. Jeekel, your connections to China and your confidence of the country and her people eventually brought me to the Netherlands. I sincerely appreciate this chance and I hope my performance here may bring many more outstanding Chinese researchers to REPAIR and to EMC. Your generosity and enthusiasm have always been stimulating me during my whole PhD fellowship. Such attitudes have brought us many more connections, collaborations and successes in our research.

Dear Dr. Menon, our first meeting was in the operating room. Your expertise in clinical practice have substantially facilitated our clinical research. Within a comparably short period of collaboration, we have already finished several studies and published some of them. In Chinese we have a saying that goes “regret we did not meet sooner”. I think it is perfectly applicable to us.

I would like to thank Chinese Scholarship Council for supporting my PhD fellowship. I believe this ambitious project (CSC program) will certainly bring the prosperity and strength to China in the future. Many thanks to EUCC and Mrs. Tseng for the great help during my stay in the Netherands. Many thanks to EUCC and Mrs. Tseng for the great help during my stay in the Netherlands. My sincere appreciation also goes to Peking University. You led me into medicine, built up my view of life and values, and most importantly, you introduced Ken Lin into my life. You certainly deserve all my appreciation.

Konstantinos and Simone, my dear guards (paranimfen)! It is fascinating that all the time that we spent together in the labs simply results in several lines on our publication list. Of course, different from the study data, our chat and discussions in the labs were mostly not recorded, but they were undoubtedly crucial to our scientific work because they brought perfect mood to the researchers. Our work will make an impact in the scientific world for

sure, but it is much more than that. You guys helped me so much outside the labs as well. Life in Holland is not always easy; nevertheless, it feels great because I'm sure there are several peoples that I can call when I have questions in my life in this country. In addition to the scientific work, you also serve great as paraninfen; it feels much safer with guards aside to fight for a PhD certificate!

Dear all REPAIR members, you guys are all great!

Pieter, thank you so much for picking me up at Rotterdam Centraal Station, and hosting me my first night in Holland.

Eva, or so-called Maximum, you certainly know exactly how important a ring is for a successful proposal. Thank you so much for helping me find the right one.

Ruth, thank you for your super fast and efficient translation for the Coolsingel funding, which brought us some euros in one afternoon.

Marianne, all of our discussions are great fun! You are able to spread happiness to all the people around you, that is so nice! Wish to see you soon and continue our talk.

Lucas, thank you for helping me to find the support for the thesis. Your thesis is one great example for me!

Barry, thank you for helping me distinguishing smoking (roken) from smoking (clothes). I think we all agree that next time we enjoy cigars only in the open air, right?

Irene, thank you so much for your generous contribution and detailed explanation of the rat models.

Joost, thanks a lot for inviting me to the iSpace. Also, you are doing a fantastic job in organizing the skireis. It is such a pity that I cannot join this time.

An, thank you for having exactly the same birthday! It saves quite some expenditure in Keokela but still brings perfect birthday gifts, oh yeah! (Hmmm, why am I saying this?)

Sandra, your critical revisions of my manuscripts are really impressive! Thanks a lot! Good luck with your great manuscripts!

Surgeon Freek Daams, we've made some pieces of manuscripts together during off-

work time right? I sincerely appreciate your great contributions to those studies! But more importantly, thanks a lot for teaching me how to boil pasta properly. I think you learned it from Silvia, so please bring my appreciations to her as well.

I would like to thank all the people that helped me so much during my research. All my works are impossible to be finished without your expertise. Dimitra, Paul, King Lam, Yvonne, Han and Wichor, thanks so much for your continuous help with my research. Many thanks to Prof. Peppelenbosch, your participation in the IBD study certainly put substantial weight on its scientific significance!

I would like to thank the students that I supervised, or actually helped me: Leonard, Adem, Diman and Cloe. You've done great work (and lots of work) for the research, great thanks! It is my great pleasure to know you guys. Special thanks go to Cloe for the preparation for my PhD dissertation arrangement, and most importantly, the par-tay.

I would like to thank the department of experimental surgery. Ron thanks so much for your help. I look forward to our future collaborations and co-authored publications. Franny, keep up with the House of Cards series, and Game of Thrones books! Sander, Tanja, Sushi, Stef, Joren, Sandra and Wendy, I cherish the time we spent together (though mostly in the office or lab, LOL).

David, I think you probably do not know how I appreciate you for your generous help. I am always a bit nervous when I sent you my writings because I know they were far away from perfect. But you can always polish them and find all my Chinglish or Dungleish mistakes. I will continue doing my best.

I would like sincerely thank Yiding Zhuang and Na Mi, the new parents of XiaoQiao, the most lovely Siamese cat. You guys provide the best food and most love to the cat. I also would like to thank MiTuan and MiQiu (two other cats), who play with XiaoQiao, share food with (sometimes steal food from) her. I would love to thank Yiding Zhuang again, because every time we meet, drink and talk, we really have the very best time! Although we are really different in many ways, I cherish our friendship as one of the best.

在我出国学习的这几年中，除了科研之外，业余时间也写了一些科普作品。我由衷感谢八爪网，松鼠会，果壳网，东方早报等科普团体及媒体。感谢Kiwi长期以来对我的无私帮助。感谢潇汲、Gery、螺丝、Fujia等松鼠会成员在科普和生活上

对我的帮助。除了科普之外我们在欧洲的聚会令人难忘，非常期待与你们在英国再次相见！

感谢在荷兰陪我度过三年多美好时光的小伙伴们。海波、宝月、毛庆皓、小娜、蔡蕊、天时、白冠男、化宇、施婷、志超、刘凡、温贝、展明、莹莹、朱玉、陈勇、魁魁、持恒、潇磊、丹莉、海燕、长斌、黄玲、若皓、高雅、高文、孙伟、平臻、吴斌、小鲁、若愚、静静、凯音、世豪、于雪、耗子、张步春、卜妍、麦伦、周围、萌萌、孔令天、小白、裴炜、马允、朱麟、安琪。那一次次聚餐，一次次狼人杀，一次次出游是多么令人难忘。千言万语一句话：没玩够啊！特别感谢凯撒莲在我答辩期间给予我的巨大帮助。

感谢北大、北医的好友们：青光眼乐队的筒子们Q、曹轲、刘婧、刘梦媛、石磊、谭磊、东来，我这就回北京啦！以及05级五班的同学们，我要回来给你们抄病历并且找你们会诊啦！感谢北医三院赵旻暉大夫、积水潭医院刘亚奇大夫，希望回到北京我们还能一起玩音乐（虽然经常是被玩）。允先，非常希望能够早日来台湾与你重聚！

感谢中科院孙中生教授、邢雪荣教授、301医院张靖研究员在我国内研究时对我的悉心指导。感谢北医三院付卫大夫在我出国前对我的巨大帮助！

重新回到国内进入临床得到了很多人的帮助，感谢北医三院李颜、汪恒老师，北医教育处周宇菲老师以及北京肿瘤医院教育处的各位老师。感谢北京肿瘤医院季加孚院长、李子禹主任接受我进入外科团队继续临床工作！特别感谢薛侃医生在我回国进科等各方面给予的巨大帮助，我们北京再会！

Last but not least, I also would like Muse, Coldplay, Jay Charles, Running Man and other music or entertaining programs that companied me during the endless writing of my thesis. Thought not receiving any support from it, I still want to thank NS for its bright windows, which have captured so many nice views during my writing on the train.

CURRICULUM VITAE

Zhouqiao Wu was born in Suzhou, Jiangsu Province, China, on 17th November 1986. In 2004, he plucked the silver in the National Biology Competition in China, and was thereby admitted to Peking University. He started medical training in 2005 and conducted his clinical rotation in Peking University Third Hospital. During his medical training, he also participated the research in Institute of Psychology, Chinese Academy of Sciences, and was granted a research fund for Undergraduates. In 2011, soon after he obtained his medical degree and started his surgical training, he was awarded with a national grant, the “China Scholarship Council Grant”, with which he conducted his Ph.D. fellowship in the REPAIR research group at the department of surgery, Erasmus University Medical Center Rotterdam, the Netherlands, under supervision by Prof. J.F. Lange, Prof. G.J. Kleinrensink, and Prof. J. Jeekel. During this three and half years, he conducted different studies on etiology, detection and prevention of postoperative complications including colorectal anastomotic leakage and postoperative ileus; some of the works are included in this thesis.

In 2015, he will start his surgical training at Beijing Cancer Hospital led by Prof. Jiafu Ji in Beijing, China.

个人简历

姓名：吴舟桥

性别：男

出生年月：1986年11月

教育经历

2005—2011	医学八年制	北京大学医学部	北京 中国
2011—2015	外科博士	伊拉斯姆斯大学医学中心	鹿特丹 荷兰

专业经历

2015—	外科住院医	北京大学肿瘤医院	北京 中国
2011—2015	博士研究生	伊拉斯姆斯大学医学中心外科	鹿特丹 荷兰
2009—2011	实习医生，住院医	北京大学第三医院	北京 中国
2008—2011	实习研究生	中科院心理所	北京 中国

科研方向

- 术后并发症，特别是针对胃肠道术后肠梗阻及肠吻合口瘘的病因、诊断及预防
- 患者术后恢复及预后改善
- 生物胶及其他生物材料的理化性能研究

其他学术工作

第三届国际生物医学工程及生物技术大会特约审稿人，《英国外科学杂志》等知名外科杂志审稿人；中国知网CNKI质检专家

学生辅导

已辅导4名外科研究实习生，以及1名神经科学硕士生

社会任职

2011至今	科普作者，专栏作者
2012至今	科学松鼠会成员

已发表超过100篇科普文章，收录于4本科普书籍以及各类知名网络媒体、报纸、杂志等各类大众媒体。作品被收录于《中国科普年鉴》等多本科普书籍中。

PUBLICATIONS

Wu Z*, Menon A et al. Is routine air leak test with selected intraoperative flexible sigmoidoscopy sufficient to prevent colorectal anastomotic leakage, *Colorectal Disease*, In press, (2014)

Wu Z*, Boersema GS et al. Reducing colorectal anastomotic leakage with tissue adhesive in experimental inflammatory bowel disease, *IBD*, In press (2014)

Wu Z*, Boersema GS et al. Clinical Endpoint, Early Detection and Differential Diagnosis of Postoperative Ileus: a Systematic Review of Literature. *European Surgical Research*. (2014)

Wu Z*, Vakalopoulos KA et al. The prevention of colorectal anastomotic leakage with tissue adhesives in a contaminated environment is associated with the presence of anti-inflammatory macrophages. *International Journal of Colorectal Disease*. (2014)

Wu Z*, Boersema GS et al. Nicotine gum chewing: a Novel Strategy to Shorten Duration of Postoperative Ileus via Vagus Nerve Activation. *Medical Hypotheses*. (2014)

Wu Z*, Daams F et al. Do normal vital signs exclude anastomotic leakage? *Journal of the American College of Surgeons*. (2014)

Vakalopoulos KA, **Wu Z** et al. Mechanical strength and rheological properties of tissue adhesives with regard to colorectal anastomosis: an ex vivo study. *Annals of Surgery*. (2014)

Wu Z*, Daams F et al. Colorectal anastomotic leakage caused by insufficient suturing after partial colectomy: a new experimental model. *Surgical Infection*. (2014)

Daams F, **Wu Z** et al. Prediction and diagnosis of colorectal anastomotic leakage: A systematic review of literature. *World Journal of Gastrointestinal Surgery*. (2014)

Wu Z*, Vakalopoulos KA et al. Reducing anastomotic leakage by reinforcement of colorectal anastomosis with cyanoacrylate glue. *European Surgical Research*. (2013)

Wu Z*, Boersema GS et al. Critical analysis of cyanoacrylate in intestinal and colorectal anastomosis. *Journal of Biomedical Material Research B Applied Biomaterial*.

(2013)

Vakalopoulos KA, Daams F, **Wu Z** et al. Tissue adhesives in gastrointestinal anastomosis: a systematic review. *Journal of Surgical Research*. (2013)

Daams F, **Wu Z** et al. Identification of anastomotic leakage after colorectal surgery using microdialysis of the peritoneal cavity. *Tech Coloproctol*. (2013)

Zhang J., **Wu Z** et al. Deficiency of antinociception and excessive grooming induced by acute immobilization stress in Per1 mutant mice. *PLoS One*. (2011)

Wu Z, Zhang J et al. The Relation between Neurobiological Changes and Analgesia Caused by Restraint Stress, *Neuroanatomy (in Chinese)*. (2010)

Submissions

Wu Z*, Boersema GS et al. Postoperative Blood Flow Measurement Detects Anastomotic Leakage.

Wu Z*, Boersema GS et al. Improving colorectal anastomotic healing by hyperbaric oxygen therapy.

Wu Z* et al. Prediction of colorectal anastomotic leakage by intra-abdominal drainage analysis: a meta-analysis.

Wu Z* et al. Detection of colorectal anastomotic leakage by air-leak test, is it useful: a meta-analysis.

Vakalopoulos KA, **Wu Z** et al. Clinical effects, mechanical strength and immunohistopathological analysis of existing tissue adhesives with regard to colorectal anastomosis: an in-vivo study.

Daams F, van den Broek F, **Wu Z** et al. The importance of inversion during creation of colorectal anastomosis.

PRESENTATIONS

Z. Wu (2012), Reducing anastomotic leakage by reinforcement of colorectal anastomosis with cyanoacrylate glue, Oral presentation at 47th ESSR, Lille, France

Z. Wu (2013), Prevention of anastomotic leakage with tissue adhesives in a contaminated environment, Oral presentation at 100th ASGBI, Glasgow, Great Britain

Z. Wu (2013), Colorectal anastomotic leakage caused by insufficient suturing after partial colectomy: a new experimental model, Poster presentation at 100th ASGBI, Glasgow, Great Britain

Z. Wu (2013), Prevention of anastomotic leakage with tissue adhesives in a contaminated environment, Oral presentation at 48th ESSR, Istanbul, Turkey

Z. Wu (2013), Colorectal anastomotic leakage caused by insufficient suturing after partial colectomy: a new experimental model, Oral presentation at 48th ESSR, Istanbul, Turkey

Z. Wu (2014), Partial colectomy in colitis induced with trinitrobenzene sulfonic acid: a new experimental model to study surgical treatment of IBD, Poster presentation at Tripartite Colorectal Meeting, Birmingham, Great Britain

Z. Wu (2014), Reducing Anastomotic Leakage with Tissue Adhesive in a Rat Trinitrobenzene Sulfonic Acid (TNBS) Induced Colitis Model, Poster presentation at Tripartite Colorectal Meeting, Birmingham, Great Britain

Z. Wu (2014), Early detection and differential diagnosis of postoperative ileus: a systematic review of literature, Poster presentation at Tripartite Colorectal Meeting, Birmingham, Great Britain

Z. Wu (2014), Reducing colorectal anastomotic leakage with tissue adhesive in experimental inflammatory bowel disease. Poster presentation at European Colorectal Congress, Munich, Germany

PHD Porfolio

Name PhD fellow: Zhouqiao Wu

Department of Surgery, Erasmus University Medical Center

PhD period: 01-Sep-2011 to 24-Feb-2014

Promotors:

Prof.dr. J.F. Lange

Prof.dr. G.J. Kleinrensink

Co-promotor:

Prof.dr. J. Jeekel

PhD Training	Year	Workload
General courses		
Animal Experiments (art. 9)	2012	3
Scientific Writing	2012	2
Survival analysis	2013	1
Photoshop illustrator CS	2014	0.5
Conferences		
SEOHS (1 oral presentations;2 poster presentations)	2014	2.5
ESSR (3 oral presentations)	2012-2013	5
ASGBI (1 oral presentation; 4 poster presentations)	2013-2014	5
ECC (1 poster presentation)	2013-2014	2.5
RICH congress	2012-2014	1
Teaching		
Medical interns (4 keuzonderzoekers)	2012-2014	8
Master thesis	2012-2013	2