

1-1-2012

Throughput analysis and bottleneck management of production lines

Hatice Ucar
Wayne State University,

Follow this and additional works at: http://digitalcommons.wayne.edu/oa_dissertations

Recommended Citation

Ucar, Hatice, "Throughput analysis and bottleneck management of production lines" (2012). *Wayne State University Dissertations*. Paper 482.

This Open Access Dissertation is brought to you for free and open access by DigitalCommons@WayneState. It has been accepted for inclusion in Wayne State University Dissertations by an authorized administrator of DigitalCommons@WayneState.

**THROUGHPUT ANALYSIS AND BOTTLENECK MANAGEMENT OF
PRODUCTION LINES**

by

HATICE UCAR

DISSERTATION

Submitted to the Graduate School

of Wayne State University,

Detroit, Michigan

in partial fulfillment of the requirements

for the degree of

DOCTOR OF PHILOSOPHY

2012

MAJOR: INDUSTRIAL ENGINEERING

Approved by:

Advisor

Date

Co-Advisor

Date

DEDICATION

To My Family...

ACKNOWLEDGMENTS

I need to thank many people who directly or indirectly helped me with the research presented in this dissertation. I offer my sincere appreciation and gratitude to all of those who I mention here or not. These words are not enough to represent their contributions but an attempt to thank them all.

First of all, I cannot enough express my gratitude to my advisors Dr. Ratna Babu Chinnam and Dr. Alper Murat. Their original ideas, perfectionism, enthusiasm and the confidence they have shown in me, have not only directly contributed to the work presented in this dissertation, but have also meant a lot to me personally. I am forever grateful to both of them and feel very lucky to have such great mentors.

I express my sincere appreciation to the committee members, Dr. Darin Ellis, Dr. Leslie Monplaisir, and Dr. Gene Coffman. I sincerely believe that their valuable inputs to this research make it diverse and successful.

Special thanks go to Dr. Kenneth Chelst and Dr. Thomas Edwards, the “Mathematics Instruction using Decision Science and Engineering Tools” (MINDSET) project leaders, for being excellent examples as supervisors during my assistantship to them. My doctoral study at WSU was partially funded through this project by National Science Foundation.

I would like to extend my sincerest thanks to Joe Lapres who was the director of “Bottleneck Identification and Throughput Management at Dearborn Truck Plant” project. A part of this work was funded by Ford Motor Company through this project.

I would also like to thank all the members of the Department for making study a pleasure in such friendly work environment.

I am more than grateful to my family and I would especially like to thank my parents for always giving me their unconditional support. I can only hope that I made them proud to complete this far away from home yet rewarding journey. I hope that I can manage to become such a good parent as them.

I could not have finished this dissertation without the support of my husband Ali who has been with me all the time during these years of research. No words could thank him enough for his support and constant encouragements.

Finally, a big thanks to my daughter Betul who was born during my study and brought joy to our family.

Thank You!

TABLE OF CONTENTS

Dedication.....	ii
Acknowledgments.....	iii
List of Tables.....	viii
List of Figures.....	xi
CHAPTER I: INTRODUCTION.....	1
1. Motivation.....	1
2. Approach.....	2
3. Research Objectives.....	3
2. Research Scope.....	3
4. Organization of the Dissertation.....	5
CHAPTER II: ANTICIPATIVE PLANT-LEVEL MAINTENANCE DECISION	
SUPPORT SYSTEM.....	7
1. Introduction.....	7
2. Literature Review.....	13
3. Anticipative Plant-level Maintenance Decision Support System (APMDSS) .	17
<i>3.1. Bottleneck Simulator.....</i>	<i>19</i>
<i>3.2. Maintenance Time Window Anticipator.....</i>	<i>21</i>
<i>3.3. Machine Degradation Modeling.....</i>	<i>22</i>
4. Industrial Case Study.....	23
5. Simulation Analysis and Results.....	26
<i>5.1. Impact of Initial Conditions on Productivity and Bottleneck Patterns.....</i>	<i>27</i>

5.2. Corrective Maintenance Prioritization	34
5.3. Preventive Maintenance Prioritization	37
5.4. Combined CM, PM, and OM Prioritization in Model Mix Setting.....	41
6. Conclusions and Future Research	46
CHAPTER III: THROUGHPUT ANALYSIS OF A PRODUCTION SYSTEM WITH TWO DETERIORATING MACHINES AND A FINITE BUFFER.....	48
1. Introduction	48
2. Literature Survey	50
3. Model Description	51
4. Performance Measures.....	53
5. Solution Methodology	55
5.1. Analysis of Internal Equations	55
5.2. Analysis of Boundary Equations.....	65
6. Experimental Study	77
7. Conclusions	79
CHAPTER IV: A HYBRID AGGREGATION-DECOMPOSITION ALGORITHM FOR PERFORMANCE EVALUATION OF UNRELIABLE PRODUCTION LINES WITH FINITE BUFFERS.....	81
1. Introduction	81
2. Literature Review	84
3. Model Description and Assumptions	86
4. Performance Measures.....	88
5. Hybrid Aggregation-Decomposition Method.....	89

5.1. Bottleneck Identification	89
5.2. Aggregation of Non-Bottleneck Machines	91
5.3. Decomposition of the Virtual Line	95
6. Experimental Study	99
6.1. Experimental Setting I: Cases 1-5	100
6.2. Experimental Setting II: Cases 6-10	102
6.3. Experimental Setting III: Cases 11-15	104
7. Conclusions	106
CHAPTER V: CONCLUSIONS & FUTURE RESEARCH.....	108
Future Work.....	109
Appendices	110
<i>Chapter II : Appendix 1</i>	110
<i>Chapter II : Appendix 2</i>	115
<i>Chapter III : Appendix 1</i>	119
References.....	123
Abstract.....	131
Autobiographical Statement.....	134

LIST OF TABLES

Table 1 : Distribution Parameters of the Stations in minutes	24
Table 2 : Parameters of the Conveyors	25
Table 3 : Impact of Initial Ages on Overall Bottleneck Patterns.....	31
Table 4 : Impact of Initial Failures on Overall Bottleneck Patterns	32
Table 5 : Impact of Initial Buffers on Overall Bottleneck Patterns	33
Table 6 : Age Groups (based on time elapsed in working state since last PM, in minutes).....	35
Table 7 : Experimental Setting with Different Initial Failures (0: operational, 1: broken)	35
Table 8 : Superiority % of APMDSS compared to FCFS in CM Prioritization.....	36
Table 9 : Superiority % of APMDSS compared to PMDSS in CM Prioritization	36
Table 10 : Superiority % of APMDSS compared to FCFS in CM Prioritization.....	37
Table 11 : Superiority % of APMDSS compared to PMDSS in CM Prioritization	37
Table 12 : Experimental Setting with Different Age Groups	38
Table 13 : RLT Values, †: The stations with failure alarms.....	38
Table 14 : Superiority % of APMDSS compared to Other Methods in PM Prioritization	40
Table 15 : Throughput Improvement % in Two-PM-Slot Case vs. One-PM-Slot Case	40
Table 16 : Superiority % of APMDSS compared to Other Methods in PM Prioritization	41
Table 17 : Experimental Setting for OM Prioritization, †: The stations with failure alarms	42

Table 18 : Superiority % of APMDSS based CM and PM over Others	42
Table 19 : Hourly Buffer Averages	43
Table 20 : "At Least 50% Full Buffer" Probabilities	43
Table 21 : "At Least 25% Full Buffer" Probabilities.....	44
Table 22 : Estimated Opportunity Windows with 50% Safety Level	45
Table 23 : Estimated Opportunity Windows with 25% Safety Level	45
Table 24 : Estimated Opportunity Windows without Safety Buffer	45
Table 1 : Experiment 1 with First Set of Cases	78
Table 2 : Experiment 1 with Second Set of Cases	78
Table 3 Experiment 2 with First Set of Cases	79
Table 1 : States of a Two -Machine Line Segment	92
Table 2 : Level of Aggregation while Bottlenecks are at the Beginning.....	100
Table 3 : Experimental Setting I: Cases 1-5.....	101
Table 4 : Comparison of Methods while Bottlenecks are at the Beginning	102
Table 5 : Level of Aggregation while Bottlenecks are in the Middle	103
Table 6 : Experimental Setting II: Cases 6-10.....	103
Table 7 : Comparison of Methods while Bottlenecks are in the Middle	104
Table 8 : Level of Aggregation while Bottlenecks are at the End	104
Table 9 : Experimental Setting III: Cases 11-15.....	105
Table 10 : Comparison of Methods while Bottlenecks are at the End	106

Table 1 : Impact of Model Mix on JPH and Overall Bottleneck Patterns 116

Table 2 : Impact of Model Mix on JPH and Overall Bottleneck Patterns (continued)
..... 117

Table 3 : Impact of Model Mix on JPH and Overall Bottleneck Patterns (continued)
..... 118

LIST OF FIGURES

Figure 1 : North American History of Total Hours per Vehicle (Harbour Report, 2008)	8
Figure 2 : 2007-2008 Production Performance of the Body Shop.....	9
Figure 3 : Framework for APMDSS.....	18
Figure 4 : Active and Inactive States of a Machine (Roser et al., 2001).....	19
Figure 5 : Front Structure Lines in the Body Shop	23
Figure 6 : Impact of Initial Machine Ages on JPH under Different Initial Failure and Buffer Conditions	28
Figure 7 : Impact of Initial Machine Failures on JPH under Different Initial Age and Buffer Conditions	28
Figure 8 : Impact of Initial Buffer Levels on JPH under Different Initial Failure and Age Conditions.....	28
Figure 1 : Two-Machine Line.....	49
Figure 2 : State Transitions of Machine 1 and Machine 2	52
Figure 3 : Operational and Non-operational States of Machine 2	54
Figure 1 : k-Machine Production Line	82
Figure 2 : Decomposition of a k-Machine Line	83
Figure 3 : Aggregation of a k-Machine Line	84
Figure 4 : Active and Inactive States of a Machine (Roser et al., 2001).....	90
Figure 5 : Aggregation around the Bottleneck Machines	92
Figure 6 : State Transition Graph.....	93
Figure 7 : Decomposition of the Virtual Line	96

Figure 1 : Impact of Initial Machine Ages on Bottleneck Status of LHA1 under Different Initial Conditions	110
Figure 2 : Impact of Initial Machine Ages on Bottleneck Status of Dash under Different Initial Conditions	110
Figure 3 : Impact of Initial Machine Failures on Bottleneck Status of LHA1 under Different Initial Conditions	111
Figure 4 : Impact of Initial Machine Failures on Bottleneck Status of Dash under Different Initial Conditions	111
Figure 5 : Impact of Initial Buffer Levels on Bottleneck Status of LHA1 under Different Initial Conditions.....	111
Figure 6 : Impact of Initial Buffer Levels on Bottleneck Status of Dash under Different Initial Conditions.....	112
Figure 7 : Impact of Initial Machine Ages on Bottleneck Status of LHA2 under Different Initial Conditions	112
Figure 8 : Impact of Initial Machine Ages on Bottleneck Status of RHA3 under Different Initial Conditions	112
Figure 9 : Impact of Initial Machine Ages on Bottleneck Status of Sta40 under Different Initial Conditions	113
Figure 10 : Impact of Initial Machine Failures on Bottleneck Status of LHA2 under Different Initial Conditions	113
Figure 11 : Impact of Initial Machine Failures on Bottleneck Status of RHA3 under Different Initial Conditions	113
Figure 12 : Impact of Initial Machine Failures on Bottleneck Status of Sta40 under Different Initial Conditions	114
Figure 13 : Impact of Initial Buffer Levels on Bottleneck Status of LHA2 under Different Initial Conditions	114
Figure 14 : Impact of Initial Buffer Levels on Bottleneck Status of RHA3 under Different Initial Conditions	114

Figure 15 : Impact of Initial Buffer Levels on Bottleneck Status of Sta40 under
Different Initial Conditions 114

CHAPTER I: INTRODUCTION

1. Motivation

Arrival of foreign cars to the US market in the late 80s, as a result of globalization, forced auto manufacturers to improve their manufacturing excellence to stay competitive in the business environment. For instance, General Motors has started a throughput prediction and improvement project, which spanned a period of almost 20 years of implementation on its production lines in the late 1980s. Both analytical and simulation models were developed for estimating throughput performance, identifying bottlenecks, and optimizing buffer allocation in the simple and complex systems. They reported savings of over \$2.1 billion from 30 assembly plants, 10 countries over several years, and won the Franz Edelman Prize for applying operations research techniques into throughput improvement (Alden et al., 2006). There are additional such examples in the literature(e.g., Patchong et al., 2003; Pfeil et al., 2000).

The 2008 Harbour Report describes the labor productivity of the six auto manufacturers in North America (Harbour Report, 2008). According to the report, the Detroit Three (GM, Ford, and Chrysler) are closing the gap with their Asian rivals through productivity improvements, but there is still room for improvement. These success stories motivate our study.

We were also approached by a US auto manufacturer to develop tools for estimating and improving throughput performance of production facilities. In order to

develop a better understanding for the issues, we made several visits to one of their assembly plants in Southeast Michigan. Even though the plant was running mornings and nights, it was experiencing throughput difficulties. It was falling behind the daily production targets many times due to unexpected machine breakdowns.

2. Approach

Maintenance operations should not be thought of separately while making productivity related decisions. In that regard, we decided to develop a strategic decision support system from which the maintenance and the production managers could benefit; it is a bottleneck-based decision support system called anticipative plant-level maintenance decision support system (APMDSS), which prioritizes the corrective, preventive, and opportunistic maintenance tasks based on the anticipated bottleneck ranks of the upcoming shift.

It is proven that the bottleneck-driven approaches are the best for throughput prediction and improvement (Bukchin, 1998), which is another motivation for us. Even though automotive plants are very complex systems with highly interrelated machinery and dealing with the problems is complicated, bottlenecks gave us the opportunity to focus on key areas of the facility. We use bottleneck-based approach both in the development of a decision support system for maintenance management and throughput prediction of long production lines.

We developed both simulation-based models and analytical models in our study. Simulation gave us the opportunity to model the complexity of the automotive plants and plant dynamics and make more detailed analysis. On the other hand, analytic models provide fast performance estimates, which are important for setting

up realistic system objectives, assessing the financial impact of production line reconfigurations, etc. With this motivation, we developed two analytic models: Former is an exact formula for measuring the throughput of a two-deteriorating machine system, which can be used as a building block for longer production lines. Latter is an approximate formula for measuring the performance of longer production lines.

3. Research Objectives

Our objective in broad terms is to develop methods for throughput prediction and improvement. For the purpose of throughput improvement, we want to develop a decision support system that enables maintenance supervisors to handle the complexity of maintenance operations and make maintenance related decisions.

Another objective is to improve the accuracy and the speed of throughput prediction. We add some details to the existing throughput prediction methods such as machine degradation, incomplete repair, and preventive maintenance in order to meet the objective of having accurate performance measures. We engage the two main throughput prediction approaches with an objective of improving the efficiency of the throughput prediction of long production lines.

2. Research Scope

We developed three models in the dissertation. The first model is a simulation-based plant-level maintenance decision support system, which consists of four modules: 1) look-ahead bottleneck analyzer, 2) maintenance time window anticipator, 3) machine degradation calculator, and 4) maintenance optimizer. The look-ahead bottleneck analyzer anticipates the bottlenecks of the upcoming shift by exploiting the

initial condition information, i.e., machine ages, operational status of machines, buffer levels, and model mix of that shift. The maintenance time window anticipator anticipates the buffer accumulations throughout the production lines so as to find out the potential time windows for opportunistic maintenance. This will assure that all tools and spare parts are prepared for preventive maintenance ahead of time. The machine degradation calculator estimates the levels of machine degradations using a statistical model. Finally, the maintenance optimizer generates a maintenance schedule which gives guidance on the corrective and preventive maintenance priorities and the right times to perform preventive maintenance. The decision support system is mainly developed for automotive assembly lines.

In the model, corrective maintenance is carried out whenever a machine failure occurs. In case of simultaneous breakdowns, they are repaired in the order of their bottleneck ranking. Preventive maintenance is done on machines with failure alarms at lunch breaks or opportunistic times. Buffers are assumed to be reliable.

The second model provides an exact analytical formula for the throughput prediction of two-machine production lines, which consist of two deteriorating machines and a finite buffer. The machines may fail with some probability while processing parts. Raw materials enter the system; they are processed on the first machine and transferred to the second machine passing through the buffer, and then leave the system.

In the model, the machines degrade with usage and the reliability behavior of each machine changes depending on the machine's health condition. Failed machines are either perfectly or imperfectly repaired and degraded machines can be

maintained. Unlike the literature, this model accounts for machine health degradation. The machine deterioration is common in industry because the performance of the machines degrades over time with usage due to wear out. This method can be used as a building block for the analysis of longer lines with deteriorating machines and finite buffers.

Finally, the third model is a hybrid aggregation-decomposition method, which is also for throughput prediction. It approximates the throughput of serial production lines. The production line consists of k machines (M_1, M_2, \dots, M_k) and $k - 1$ buffers $(B_1, B_2, \dots, B_{k-1})$. The machines may fail with some probability while processing parts; buffers are reliable. A part enters from outside the system to M_1 and it moves to B_1 after it is processed, then it enters M_2 and it moves to B_2 after it is processed, and so forth until it leaves the system from M_k .

Aggregation and decomposition methods have been proposed in the literature for modeling throughput of production lines. In an attempt to improve computational efficiency, we marry these two methods. The new method selectively aggregates the parts of the production line based on the location of bottleneck machines.

4. Organization of the Dissertation

The dissertation is organized as follows. In Chapter 2, we present a decision support system, which gives guidance to the maintenance supervisors on making corrective and preventive maintenance related decisions for the upcoming production shift. Chapter 3 proposes an exact analytical formula for predicting the throughput of a two-deteriorating machine and a finite buffer production line. We offer a hybrid aggregation-decomposition algorithm that approximates the throughput of longer

production lines in Chapter 4. Finally, we conclude the study and propose directions for future research in Chapter 5.

CHAPTER II: ANTICIPATIVE PLANT-LEVEL MAINTENANCE DECISION SUPPORT SYSTEM

Abstract – Global competition and increasing customer expectations have forced automobile manufacturers to improve their operations. Maintenance, being one of the most critical components of the automotive industry, has a direct impact on the improvement of the overall production performance. In this paper, we introduce an anticipative plant-level maintenance decision support system (APMDSS), which gives guidance on the corrective and preventive maintenance priorities and operational preventive maintenance schedule based on the equipment bottleneck ranks with the objective of improving daily plant throughput. APMDSS anticipates the plant dynamics (i.e., bottlenecks, hourly buffer levels, and machine health) of the upcoming shift by using initial state information such as machine ages, operational status of machines, buffer levels, and scheduled production model mix. We evaluated the performance of APMDSS using real data from an automotive body shop, which is experiencing routine throughput difficulties due to frequent machine breakdowns. The results are compared with other methods from the literature and found to be superior in many settings.

1. Introduction

With the arrival of foreign cars to the US market in the late 80s as a result of globalization, auto manufacturers started seeking ways to improve their

manufacturing excellence to remain competitive in the business environment (Alden et al., 2006; Patchong et al., 2003; Pfeil et al., 2000). The most recent publicly available 2008 Harbour Report describes the labor productivity of the six auto manufacturers in North America (Figure 1). According to the report, the Detroit Three (GM, Ford, and Chrysler) are closing the gap with their Asian rivals through productivity improvements. Even though the difference has disappeared recently, there is still gap in terms of labor and capital cost.

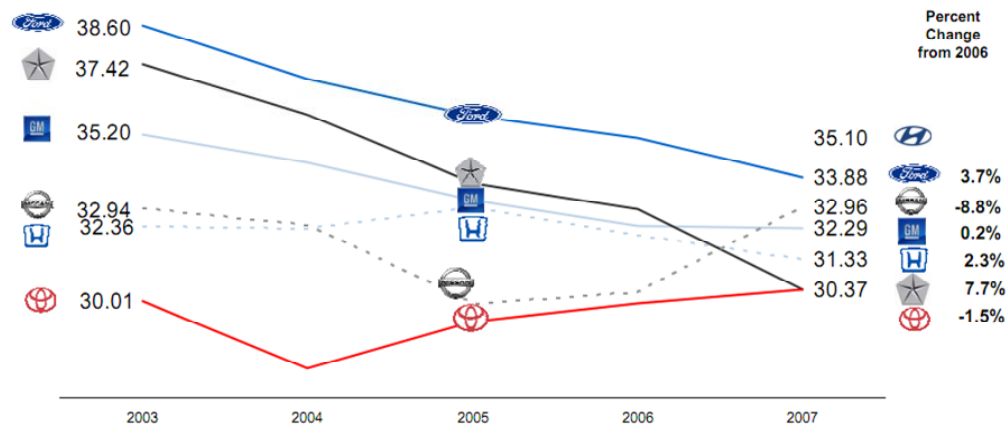

Figure 1 : North American History of Total Hours per Vehicle (Harbour Report, 2008)

While making productivity related decisions, maintenance operations should not be thought of separately; maintenance is essential for the well-being of production systems. Not surprisingly, maintenance costs constitute 15% to 70% of total production costs (Salonen and Deleryd, 2011). Without a good maintenance plan, the production system will be down for long periods due to frequent machine breakdowns and overdue repairs. On the other hand, on-time repair and maintenance increase the availability and the reliability of the machines, which in turn improves the production performance of the whole plant. Therefore, maintenance

tasks must be prioritized systematically to benefit from the scarce maintenance resources more efficiently.

Our research was initiated at the request of a US automotive manufacturer in an attempt to improve productivity. Following that, we had several visits to one of their automotive stamping, body shop, and final assembly plants. Even though it was running three 8-hour shifts per day, it was experiencing severe throughput difficulties in the Body Shop*. It was falling behind the daily production targets many times due to frequent unexpected machine breakdowns. Figure 2 illustrates the yearly, monthly, weekly, and daily shortfalls. There are major fluctuations in day-to-day productivity.

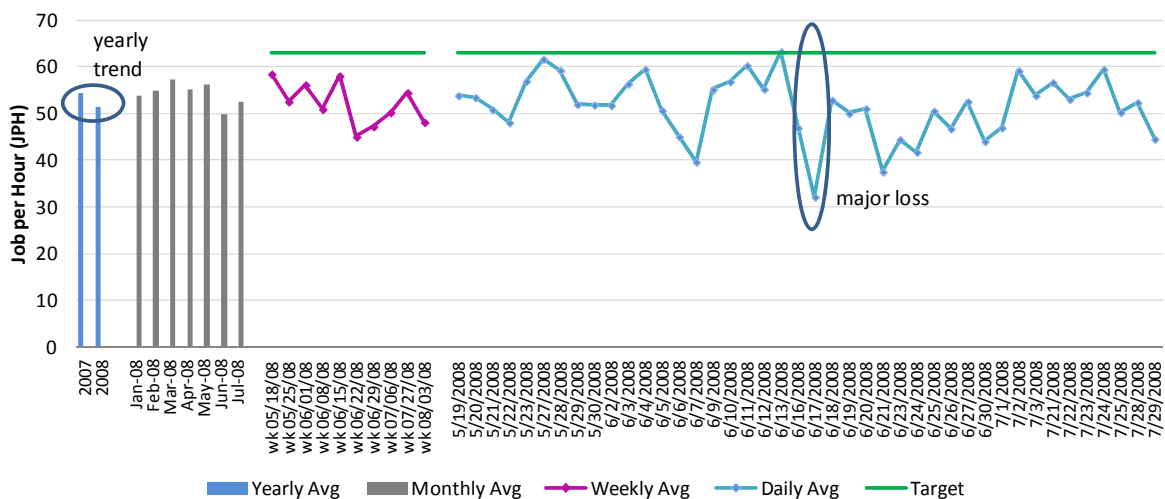

Figure 2 : 2007-2008 Production Performance of the Body Shop

The plant management was aware of the root cause of the problem and gave more privileges to the maintenance manager on production related decisions. Now, the maintenance manager did not only have technical responsibilities but also more

* Body shops are the most upstream process in a typical assembly plant (The other shops are the paint shop and the final assembly). Many stamped metals are assembled through various welding operations to build up the body of a vehicle, called the Body-in-White.

strategic responsibilities. It was also important that the maintenance manager had good communication skills since he had to create a center of attention among the maintenance and the production staff. In reality, even though the daily reports for machine breakdowns and downtime were generated by the existing Factory Information System[†] (FIS), as a tradition, the repair and the maintenance activities were mostly carried out based on worker complaints or the consent of the production supervisors and the maintenance technicians rather than the maintenance schedules provided by the maintenance department. Automotive plants are very complex systems with highly automated and complex machinery and material handling systems. Body-shops are well-recognized as having the most complexity among OEM production facilities. Obviously, there was an immediate need for a strategic decision support from which the maintenance and the production manager could benefit.

The random maintenance policies such as first-come-first-served (FCFS), complaint, or consent based policies, which are highly used in practice, may lead to huge production losses. The threat increases as the bottleneck machines wait longer in the work order list. It is proven that devoting special attention on the bottlenecks in case of simultaneously failed machines, results in higher system throughput. When such situations are encountered, bottleneck identification ensures timely response. With this in mind, we developed a bottleneck based decision support system called anticipative plant-level maintenance decision support system (APMDSS), which

[†] FIS is an information technology that monitors and archives asset operating attributes (cycling, blocking, starving, and down times) and fault conditions. It is mainly used for data management, representation, and report generation.

prioritizes the corrective, preventive, and opportunistic maintenance[‡] tasks with the objective of improving the production throughput.

The APMDSS consists of four modules: 1) look-ahead bottleneck analyzer, 2) maintenance time window anticipator, 3) machine degradation calculator, and 4) maintenance optimizer. The look-ahead bottleneck analyzer anticipates the bottlenecks of the upcoming shift by exploiting the initial condition information, i.e., machine ages and maintenance history, operational status of machines, buffer levels, and scheduled production model mix of that shift. The maintenance time window anticipator anticipates the buffer accumulations throughout the production lines so as to identify the potential time windows for opportunistic maintenance. This will assure that all tools and spare parts are prepared for preventive maintenance ahead of time. The machine degradation calculator estimates the levels of machine degradations using a statistical model. Finally, the maintenance optimizer generates a maintenance schedule that provides guidance on the corrective and preventive maintenance priorities and the right times to perform preventive maintenance.

Discrete event simulation is used to model the system with the initial conditions of the subsequent shift. It has allowed us to detect the bottlenecks of the next shift, anticipate buffer accumulations, estimate machine degradation levels, and analyze different scenarios. We did our initial study in the Front Structure Area of the Body Shop and only one type of product had been produced in that section. The simulation model gave us the ability to do synthetic experiments for the analysis of

[‡] Despite the corrective and preventive maintenance, traditionally, times for doing opportunistic maintenance is not scheduled beforehand. Instead, buffer contents that exceed a certain level give the opportunity to maintain the equipment with failure alarms. This type of maintenance is called opportunistic maintenance.

the model mix case. Modeling the complexity of the body shop and its dynamics would not be feasible with analytic models unless we had undue simplifying assumptions. We conducted our preliminary experiments using an existing and validated simulation model of the body shop with real data and compared the performance of our decision support system with Li et al.'s (2009) PMDSS and other traditional approaches. The APMDSS performs significantly better in many cases.

The contribution of this study is three-fold: First, we developed an effective decision support system (DSS) which avoids the stable system behavior assumption. Instead of using historic bottleneck information, the developed DSS anticipates the bottlenecks of the upcoming shift by exploiting the initial condition information of the system. Second, the proposed DSS is also extended to work in the model mix environment. Third, using real data, we have tested the proposed DSS and demonstrated its value by throughput improvement compared to other methods used in practice and the literature.

The rest of the paper is organized as follows: A selective survey of the related literature is given in Section 2. In Section 3, we introduce the APMDSS and its components. Section 4 presents a case study of an automotive body shop. An analysis of initial conditions and the experimental results of the case study to show the effectiveness of APMDSS under single model and model mix settings are shown in Section 5. Section 6 concludes the study and proposes directions for future research.

2. Literature Review

While production equipment requires corrective maintenance at random moments due to failures and preventive maintenance at regular intervals, when not managed properly, these activities can disrupt production operations. Therefore, maintenance management requires making decisions that will lead to smooth production flow. There is a large body of literature related to the area of maintenance management; however, most studies deal with reliability issues or the maintenance planning and scheduling of individual machines. Here, we mention only the most relevant research to our study and refer the interested reader to look into surveys by Wang (2002), Garg and Deshmukh (2006), and Budai et al. (2008) for further information.

In many studies, production and maintenance planning decisions are made together based on the optimization of production and maintenance rates of the machines under consideration. Boukas and Yang (1996) address the problem of controlling production and preventive maintenance rates of a single machine whose failure probability is an increasing function of its age. Gharbi and Kenne (2005) propose an approach for controlling the production and preventive maintenance rates of a multiple machine production system so as to reduce the inventory and maintenance costs. They use discrete event simulation to model the dynamics of the system. Kenne and Nkeungoue (2008) consider the control of corrective and preventive maintenance rates simultaneously in a manufacturing system consisting of one machine producing a single product. Many other extensions of this type of problem can be found in the literature (e.g., Song, 2009; Kianfar, 2005). Control of

the preventive maintenance rate can be achieved by being more proactive; but controlling the production rate is not easy in the short term. Chang et al. (2007) present a more realistic alternative. They introduce a feedback control mechanism which uses the results of a playback simulation to iteratively adjust the parameters of the bottlenecks. They choose the control parameters as the initial buffer levels of the bottleneck machines and their repair rates, which can be adjusted during operations.

Another area of literature related to our research examines the optimal time for doing preventive maintenance. Dedopoulos and Smeers (1998) consider a single machine which works in a continuous mode of operation characterized by an increasing failure rate. Any machine breakdown is repaired minimally. They determine the optimal time to do preventive maintenance in a time horizon of interest and the required extent to do preventive maintenance by means of age reduction. Cavory et al. (2001) study the preventive maintenance scheduling on the machines of a production line with the goal of increased throughput. Simulation is used repeatedly by the optimizer module to evaluate different scenarios. They focus their attention on setting the parameters of a genetic algorithm used by the optimizer.

Preventive maintenance can be carried out at the moments when production is interrupted by other operations. These moments are called opportunity windows. Some researchers contribute to this end, for instance, Van der Duyn Schouten and Vanneste (1995) use the buffer levels to identify opportunity to do preventive maintenance in a one machine – one buffer environment. The machine has to satisfy a constant demand. The decision to start preventive maintenance depends on the condition of the equipment and the buffer content. Iravani and Duenyas (2002)

extend their model with a stochastic demand and production process. Zequeira et al. (2008) include imperfect production in their study in addition to the determination of optimal buffer content to satisfy demand during maintenance times. Chang et al. (2007) study the opportunistic maintenance of a multiple machine system. Kenne et al. (2007) study the effect of preventive maintenance and machine age on optimal safety stock levels which are kept to cope with unexpected failures.

Since maintenance resources are scarce, prioritizing maintenance tasks is essential. Dekker and Smeitink (1994) deal with the problem of setting priorities for the execution of preventive maintenance tasks at randomly occurring opportunities. They defined an opportunity as a short period of time that occurs when a production unit is shut down for any reason. Since the opportunities are of restricted duration, each maintenance task is split into smaller packages. They propose a model for determining the optimal execution time for these maintenance packages. An operational decision support system for the optimization of maintenance activities, called PROMPT, is developed in a later study by Dekker and van Rijn (1996) using many techniques developed in Dekker and Smeitink (1994). Dekker (1995) exploits penalty functions, which are expressed in average maintenance costs, to determine the preventive maintenance priorities. Khanlari et al. (2008) uses fuzzy logic for assigning maintenance priorities by interpreting the verbal explanations of maintenance experts regarding the condition of the equipment.

Recently, there has been a trend in the study of bottleneck-based maintenance scheduling (e.g., Langer et al., 2010; Li et al., 2009; Chang et al., 2007). These studies suggest prioritizing the maintenance tasks in accordance with

the long-term or the short-term bottleneck orders. If the long-term bottleneck orders are adopted, the past few weeks' or months' data is retrieved to determine the maintenance priorities, which are kept constant during the selected operational period. If the short-term bottleneck orders are adopted, then the past few shifts' or days' bottleneck data determines the priorities.

As seen from the literature, most of the research covers a portion of maintenance management. They either consider the reliability of an equipment or prioritization of preventive or corrective maintenance of single or multiple machine systems. If both preventive and corrective maintenance are considered together, then it is either a single machine problem or has many simplifying assumptions which make the problem impractical.

The paper closest to ours is by Li et al. (2009). They introduce a real-time plant-level maintenance decision support system (PMDSS) for a single product manufacturing system. It prioritizes the corrective, preventive, and opportunistic maintenance tasks based on the bottleneck ranks that are obtained from the most recent data. The maintenance priorities are reset intermittently as more recent data is collected. In the case study of an automotive assembly line, the PMDSS achieved about 12% throughput improvement over the FCFS based corrective maintenance strategy. However, it extracts the bottleneck information from the historic data, so it implicitly assumes that the latest system behavior will be repeated in the subsequent time period. On the other hand, the system dynamics will change due to the stochastic nature of the manufacturing environment. The machine degradation by that time will cause the production line to confront more frequent failures. This may

cause the location of the bottleneck to shift to other machines or develop additional bottlenecks. Finally, the change of the bottleneck order can create control problems for the shop floor personnel.

In this paper, we propose a more effective decision support system, which avoids the stable system behavior assumption. The APMDSS anticipates the bottlenecks of the upcoming shift by exploiting the initial condition information of the system, i.e., machine ages, operational status of machines, buffer levels, and model mix of that shift. The machines requiring preventive maintenance are determined from their degradation level. Buffer accumulations throughout the production lines are anticipated so as to determine the potential time windows for opportunistic maintenance, which will assure that all tools and spare parts are prepared for preventive maintenance beforehand. Lastly, the APMDSS generates a maintenance schedule which gives guidance on the corrective and preventive maintenance priorities and the right times to perform preventive maintenance.

3. Anticipative Plant-level Maintenance Decision Support System (APMDSS)

APMDSS enables maintenance supervisors to handle the complexity of maintenance operations and make maintenance related decisions, which help reach the production throughput targets. It anticipates the bottlenecks and hourly buffer buildups in the upcoming shift by looking at the initial state of the production system and estimates machine degradations using a statistical model. Then, the information is put into the maintenance optimizer, which generates reports on corrective (CM) and preventive maintenance (PM) priorities, and opportunistic times to do PM. The proposed framework is depicted in Figure 3.

In contrast to the conventional bottleneck analysis, APMDSS exploits the initial states, such as ages, buffer levels, initial failures, and model mix information of the production system instead of using the historic bottleneck data.

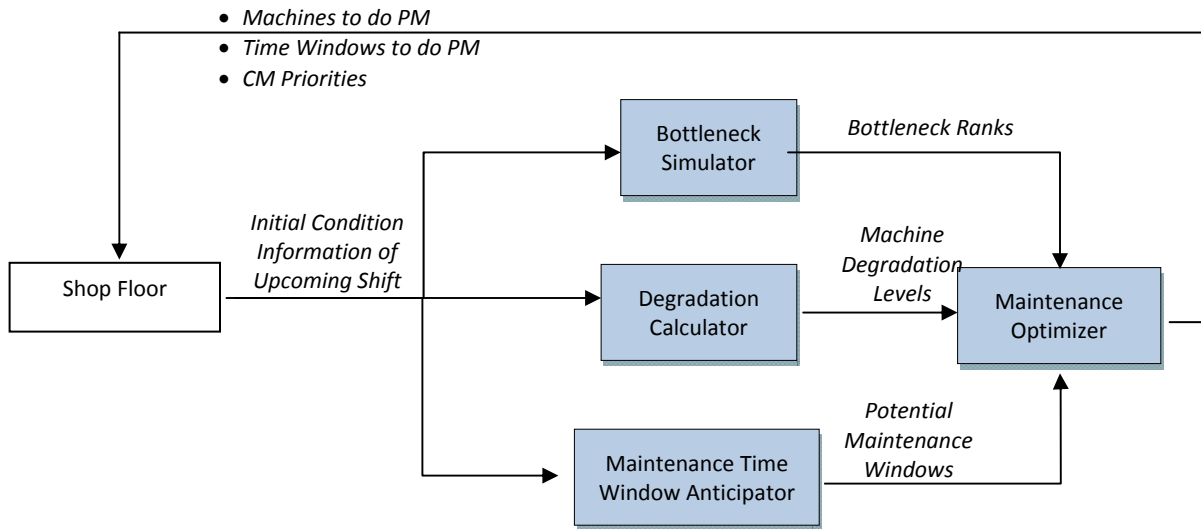

Figure 3 : Framework for APMDSS

APMDSS assumes that the probability of failure of machines increases with usage. Whenever a machine fails, it is repaired minimally with CM. All machines are preventively maintained when their ages (time since last PM) hit a threshold and they are assumed to behave as good as new after PM. PM can be done at predetermined time slots or at opportunistic times. Maintenance Time Window Anticipator tracks those opportunistic times by looking at the buffer accumulations throughout the system.

Maintenance Optimizer aims to create maintenance schedules that lead to the highest shift throughput. It optimally assigns the bottleneck machines with failure alarms, the ones whose age hits the threshold, to opportunistic windows or predetermined time slots and prioritizes corrective work depending on their

bottleneck ranks. APMDSS is beneficial to the maintenance personnel as well as the production personnel on the shop floor.

3.1. Bottleneck Simulator

Identification of the bottlenecks greatly reduces the complexity of the plant throughput improvement problem. Since the bottlenecks are the binding constraints of the throughput maximization problem, their improvement directly improves the overall throughput. According to Bukchin (1998), bottlenecks are the best estimator for the production throughput. Wang et al. (2005) reviews the available bottleneck identification methods extensively. We adopted Toyota's Average Active Period (AAP) method (Roser et al., 2001) because we found it to be very effective in detecting the short-term bottlenecks compared to the other identification methods.

AAP classifies the states of a machine as active and inactive. A machine is inactive if it is blocked or starved; otherwise it is active. Consecutive active states are considered as one active state (see Figure 4). The machine with the highest average active period is the highest bottleneck.

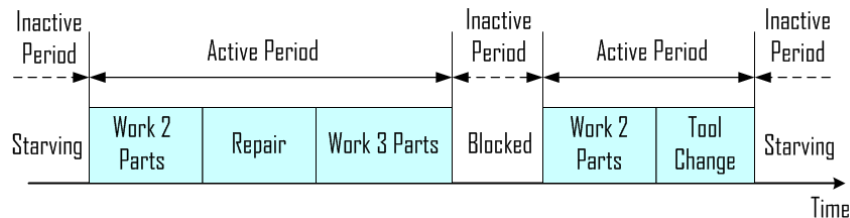

Figure 4 : Active and Inactive States of a Machine (Roser et al., 2001)

Let $A_i = \{a_{i1}, a_{i2}, \dots, a_{in}\}$ be the durations of the active states of machine i , based on a simulation run. \bar{a}_i and s_i are the average and the standard deviation of AAP for

machine i , respectively. To improve accuracy, we also derive confidence intervals for AAP from m simulation runs. If the number of active durations in a simulation run is n_k , then the grand average of active durations for machine i obtained from m runs

will be, $\bar{a}_i = \frac{n_1 \bar{a}_{i1} + n_2 \bar{a}_{i2} + \dots + n_m \bar{a}_{im}}{n_1 + n_2 + \dots + n_m}$. The total variability in the active duration data can

be described by total sum of squares, SS_{total} and equals $SS_{total} = SS_{between_runs} + SS_{within_run}$

where,

SS_{within_run} explains the deviation of each active duration data of machine i from

the average within each run, $SS_{within_run} = (n_1 - 1)s_{i1}^2 + (n_2 - 1)s_{i2}^2 + \dots + (n_m - 1)s_{im}^2$.

$SS_{between_runs}$ explains the deviation of average active duration of each simulation

run from the grand average, $SS_{between_runs} = n_1(\bar{a}_{i1} - \bar{a}_i)^2 + n_2(\bar{a}_{i2} - \bar{a}_i)^2 + \dots + n_m(\bar{a}_{im} - \bar{a}_i)^2$.

The standard deviation of active durations for machine i obtained from m runs

will be, $S_i = \sqrt{\frac{SS_{total}}{\sum_{l=1}^m n_l - 1}}$.

Then, the confidence interval with $(1-\alpha)\%$ confidence for the average of

active durations for machine i can be written as, $\left(\bar{a}_i - t_{\alpha/2, \sum_{l=1}^m n_l - 1} \frac{S_i}{\sqrt{\sum_{l=1}^m n_l}}, \bar{a}_i + t_{\alpha/2, \sum_{l=1}^m n_l - 1} \frac{S_i}{\sqrt{\sum_{l=1}^m n_l}} \right)$.

Based on the grand averages, \bar{a}_i the bottleneck ranks are determined. The confidence intervals help find any shifting bottleneck or ties between the machines by checking to see if there is any overlap between the confidence intervals.

3.2. Maintenance Time Window Anticipator

Opportunistic maintenance (OM) is the preventive maintenance that is done at opportunistic times during production. The maintenance should not slow down the production flow so that the throughput is not degraded. On some occasions, buffer occupancies exceed some amount and the extra amount gives an opportunity to safely maintain the stations in need.

It is important to determine the stations to be maintained and their opportunistic times beforehand in order to prepare all tools and spare parts ahead of time. The APMDSS estimates the OM times by anticipating the hourly buffer averages from a simulation model. Consumption time of any extra buffer in the downstream of a station that exceeds a certain level is counted toward the opportunity window if the buffer amount exceeds the safety level with 50% probability or more. The safety amounts are determined to be 50%, 25%, or 0% of the buffer capacities. The OM realization potential is also estimated from the total number of times that opportunity window realizes in all replications. It is important that enough opportunity window realizes with high probability so that the OM assignments can be guaranteed.

The opportunity windows must be as long a time required for PM. PM will take place in the second half of an hour if the OM realization potential is higher than 50% and it improves the throughput. Modified from Chang et al. (2007), we formulate the opportunity window for the i^{th} station as,

$$\Delta T_i = \sum_i^{k-1} \frac{E[X_i] - N_i * s\%}{\mu_{eqv}} - T_s, \quad E[X_i] \geq N_i * s\%, \quad i \leq k - 1,$$

where $E[X_i]$ is the expected level of the i^{th} buffer, N_i is the capacity of the i^{th} buffer, $s\%$ is the safety fraction that is kept for smooth production. We simply use the average production rate of the line as the equivalent processing rate, μ_{eqv} of the downstream of machine i . T_s is the warm-up time of the line that allows product to flow smoothly once the station resumes working. It is the time it takes for the first finished part to leave the production line once the station is again operational (Chang et al., 2007).

3.3. Machine Degradation Modeling

We define a virtual age, as described in Basile et al. (2007), for each machine which represents the estimated age of that machine since its last PM. It increases as the machine produces parts and is updated hourly using the formula, $A_t = A_{t-1} + X_{t-1,t}$. Here, A_{t-1} is the age that is calculated at time $t-1$ and $X_{t-1,t}$ is the busy time of that machine in the last hour. The probability of failure increases with age. TBF distributions of the machines are updated hourly based on the age updates. Conditional Weibull distribution is used as the TBF distribution of the machines. Hence, the TBF distribution is,

$$f(X|A_t) = \frac{\beta}{\eta} \left(\frac{X + A_t}{\eta} \right)^{\beta-1} \exp \left[\left(\frac{A_t}{\eta} \right)^\beta - \left(\frac{X + A_t}{\eta} \right)^\beta \right].$$

APMDSS has two types of maintenance work: corrective (CM) and preventive (PM). In CM, a broken machine is minimally repaired and the machine age, A_t remains the same as it was before the breakdown. PM takes place before a machine fails. The machine is renewed and its age, A_t is reset to zero after the maintenance. There is an age threshold for each machine which gives a failure alarm when it is

passed; this triggers a PM request. We use the term “repair” or “CM” for corrective work and “maintenance” or “PM” for preventive work interchangeably throughout the paper.

4. Industrial Case Study

At the request of the plant management, the preliminary experiments are done on the Front Structure Area of the Body Shop, which is regarded to be the bottleneck zone of the plant. In the Front Structure Area, left-hand apron, right-hand apron, dash, and bumper are welded and the finished item, “Front Structure,” is transferred to the Underbody Tack via the main line (Sta 60 to 120). Figure 5 shows the layout of the area. There are 13 aggregated stations, representing 79 machines, which are connected to each other with 12 conveyors.

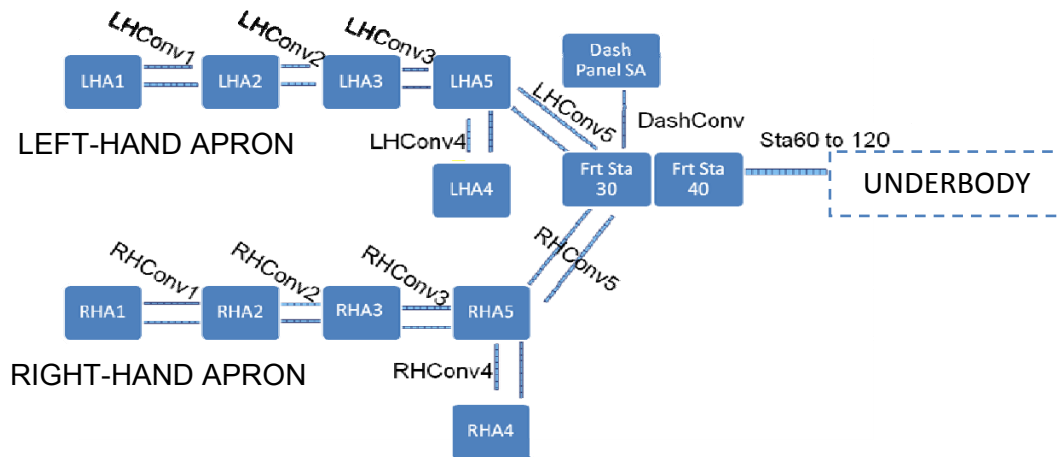

Figure 5 : Front Structure Lines in the Body Shop

In Table 1, the distribution parameters of Time between Failures (TBF), Time to Repair (TTR), and Cycle Time (CT) of the stations are given. The last column of the table shows the synthetic cycle times that are used for the second product type in

the model mix case. Remember that the TBF distributions are Conditional Weibull and they are conditioned on the age of the station. The capacity and the moving speed of the conveyors are listed in Table 2.

Table 1 : Distribution Parameters of the Stations in minutes

Stations	TBF Weibull (scale, shape)	TTR Erlang (mean, shape)	CT	Synthetic CT
LH Apron Cell 1 (LHA1)	(333, 1.5)	(12.56, 3)	0.708	0.55
LH Apron Cell 2 (LHA2)	(1496, 1.5)	(12.36, 3)	0.667	0.6
LH Apron Cell 3 (LHA3)	(333, 1.5)	(8.35, 3)	0.592	0.72
LH Apron Cell 4 (LHA4)	(1496, 1.5)	(15.28, 3)	0.592	0.65
LH Apron Cell 5 (LHA5)	(998, 1.5)	(14.33, 3)	0.547	0.6
RH Apron Cell 1 (RHA1)	(1496, 1.5)	(4.95, 3)	0.624	0.65
RH Apron Cell 2 (RHA2)	(2991, 1.5)	(15.1, 3)	0.559	0.5
RH Apron Cell 3 (RHA3)	(2991, 1.5)	(26.5, 3)	0.653	0.71
RH Apron Cell 4 (RHA4)	(2991, 1.5)	(34.83, 3)	0.576	0.55
RH Apron Cell 5 (RHA5)	(2991, 1.5)	(18.03, 3)	0.605	0.59
Dash Panel SA (Dash)	(2991, 1.5)	(10.67, 3)	0.706	0.64
Frnt Struct Sta 30 (Sta30)	(2991, 1.5)	(34.72, 3)	0.59	0.62
Frnt Struct Sta 40 (Sta40)	(2991, 1.5)	(45.57, 3)	0.632	0.57

The following assumptions apply in the simulation:

- i. One maintenance worker is available for each PM and CM service.
- ii. If only one station requires a PM or CM service, it is responded immediately.
- iii. Both PM and CM services are non-preemptive. Once a service is started on a station, it cannot be interrupted.

- iv. When many stations simultaneously break down, they will be repaired in the order of their priority that is determined by the repair policy.
- v. If there is more than one machine with a failure alarm, only one machine will be maintained in the available time slot and the others will be delayed to the next opportunity window. However, if the reliability threshold is already passed and there are still unmaintained machines available in the next shift, they will immediately be maintained at the beginning of the next shift in the order of their priority.
- vi. Conveyors are reliable.
- vii. The travel times are negligible.
- viii. The preventive maintenance takes 30 minutes.
- ix. The plant runs three 8-hour shifts per day, so there is no off-production hour except the two 30-minute lunch and coffee breaks.
- x. Two model types are produced in the model mix experiments: Model I and Model II. (Model I uses the cycle times written under the CT column and Model II uses the cycle times written under the Synthetic CT column of Table 1.)

Table 2 : Parameters of the Conveyors

Conveyor	Capacity	Speed (minutes)
LH Conveyor 1 (LHConv1)	10	0.16
LH Conveyor 2 (LHConv2)	9	0.22
LH Conveyor 3 (LHConv3)	12	0.20
LH Conveyor 4 (LHConv4)	9	0.20
LH Conveyor 5 (LHConv5)	44	0.29

RH Conveyor 1 (RHConv1)	9	0.37
RH Conveyor 2 (RHConv2)	15	0.71
RH Conveyor 3 (RHConv3)	12	0.63
RH Conveyor 4 (RHConv4)	8	0.18
RH Conveyor 5 (RHConv5)	33	0.67
Dash Conveyor (DashConv)	18	0.42
Main Line (Sta 60 to 120)	6	0.63

5. Simulation Analysis and Results

In this section, we analyze the impact of initial conditions of equipment and buffers at the beginning of the shift on the throughput and bottleneck patterns of a production shift. Then, we compare the performance of APMDSS in maintenance prioritization over other methods. We did the experiments using Simul8 simulation software. Each simulation run is set at 8 hours, typical of production shifts. The statistical analysis is done with 30 simulation replications and 95% confidence intervals are constructed for estimating the expected values and making inferences. Any experiment starts with some initial conditions such as machine ages, buffer levels, model mix, and operational status of the machines. We use actual plant data in the experiments. Synthetic data is also used to investigate the model mix setting. Buffer occupancy is guaranteed with a shift long warm-up period in the model mix case. The results showing the throughput improvement of APMDSS over the other methods are in percentages. Statistical significance is checked by comparing the confidence intervals and the significant results are shown with a star (*) in the tables.

This section is outlined as follows: Section 5.1 analyzes the impact of initial conditions on productivity and bottleneck patterns. Section 5.2 tests the performance of APMDSS in CM prioritization and Section 5.3 tests the performance of APMDSS in PM prioritization for both single model and model mix cases. A final experiment is done to evaluate the performance on a combination of CM, PM, and OM for a model mix setting in Section 5.4.

5.1. Impact of Initial Conditions on Productivity and Bottleneck Patterns

Initial conditions of a production shift may have significant impact on both the productivity and the bottleneck patterns of the manufacturing plants. We explored the possible effects with different initial settings for the Front Structure production lines. In the experiments, all machine ages are either set to zero (Zero Ages) or set to some representative initial ages (Higher Ages), which are obtained after running the simulation model for 30 shifts, PM is done on the equipment when necessary during this period. Buffer levels are either set to zero (Empty Buffer) or average levels (Average Buffers). Representative failure of LHA1, RHA2, and RHA5 (Few Failures) is compared with no equipment failure case (No failure).

Our findings regarding the possible effects of initial machine ages, buffer levels, and operational status of the machines on the average number of jobs produced per hour (JPH) and the severity of bottlenecks have been illustrated with figures. Figure 6, Figure 7, and Figure 8 show the 95% confidence limits of the average number of jobs produced per hour (JPH). Here, we witness the interaction of different initial conditions and their impact on the JPH value. The first two figures demonstrate that, with older machines and/or with the occurrence of failures, the JPH

average reduces while its variability increases. On the other hand, increasing initial buffer levels increases the JPH value.

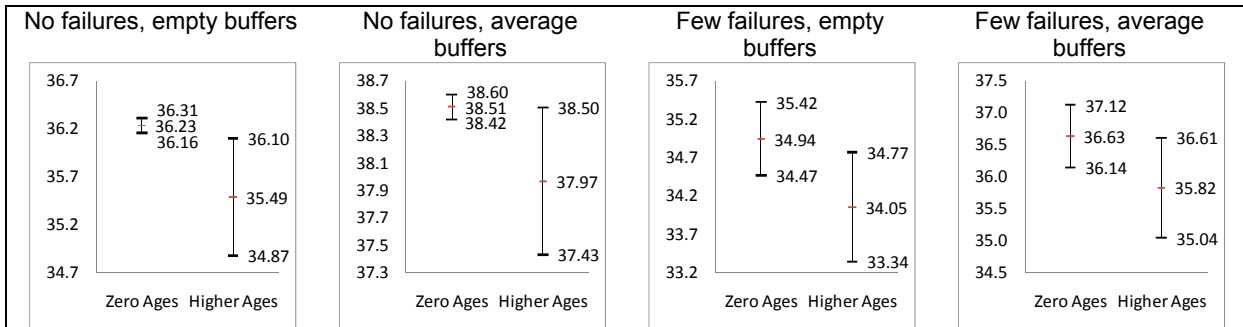

Figure 6 : Impact of Initial Machine Ages on JPH under Different Initial Failure and Buffer Conditions

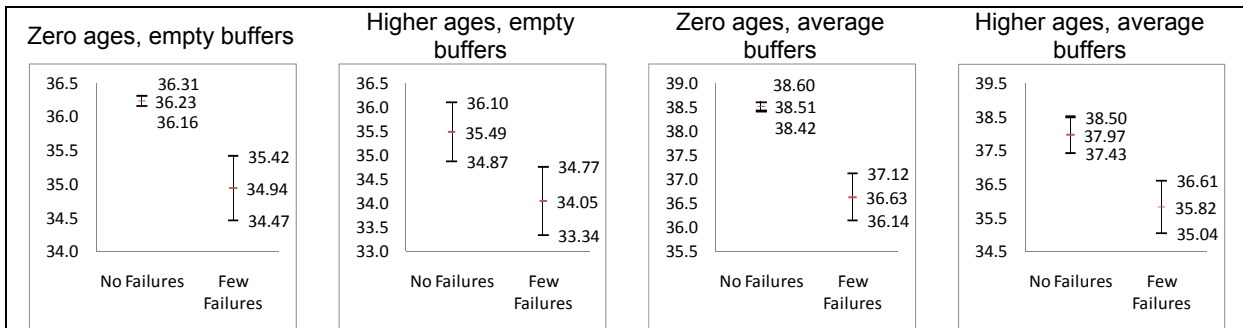

Figure 7 : Impact of Initial Machine Failures on JPH under Different Initial Age and Buffer Conditions

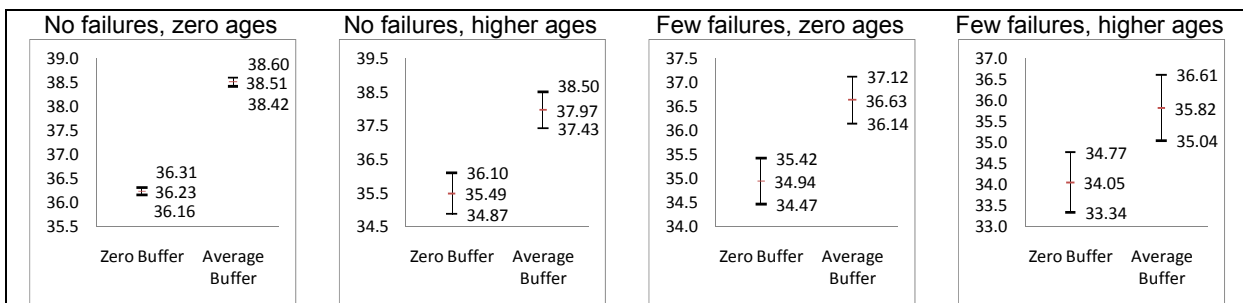

Figure 8 : Impact of Initial Buffer Levels on JPH under Different Initial Failure and Age Conditions

We did two types of analysis for examining the effects of different initial conditions on the severity of bottlenecks: micro and macro. Micro analysis

investigates the impact on individual bottleneck stations. According to the analysis, the bottleneck severity and its variability increase with increasing machine ages and initial failures. Buffers behave differently on different stations based on the location and the strength of the bottlenecks. The graphs of the micro analysis can be seen in Appendix 1.

Macro analysis evaluates the effect of the initial conditions on the bottleneck dynamics of the whole plant. The bar charts in Table 3, Table 4, and Table 5 show the bottleneck severities of all stations in the system. In the charts, the red bar shows the average bottleneck strength and the blue and the green bars show the 95% lower and upper limits, respectively. The data tables under the charts give statistical summary of the charts: each chart provides the average bottleneck strength (μ), the range between the upper and lower limits (R), and the bottleneck order (O) of the top five bottlenecks under different initial settings. The charts and the data tables on the right have one parameter change in initial setting compared to the tables and charts on the left. For example, in the graphs on the left hand side of Table 3, all initial machine ages are set to zero, whereas all the machines have some initial age in the graphs on the right hand side. Similarly, Table 4 tests the effect of initial breakdowns and tests the effect of initial buffers. In the experiment, the three stations with initial breakdown are LHA1, RHA2, and RHA5, with only LHA1 being a severe bottleneck.

In the macro analysis, initial ages and failures cause variability in the bottleneck strengths as in the micro analysis. It is interesting that the initial failures of LHA1, RHA2, and RHA5 propagates to other stations and increase their bottleneck severity and variability. The variability in bottleneck severity causes shifting

bottlenecks, as a result, the bottleneck order changes from time to time as seen on the graphs. It is also observed that initial buffers change the bottleneck order. Essentially, the main contributor to shifting bottlenecks is the model mix and, for this reason, we have also examined its impact. In the experiment, different mixes impact the bottleneck severity differently and create unexpected bottlenecks and shifting bottlenecks. The constructed charts for model mix can be seen in Appendix 2.

System behavior of the next shift is not consistent anymore with the previous shift due to the changes in the bottleneck order. As a result, the maintenance priorities that are set based on the previous shift's bottleneck order will be ineffectively assigned. This will cause the real bottleneck machine to wait unmaintained for longer periods, which will lower the plant throughput. Therefore, anticipating the bottlenecks of the upcoming shift in advance is crucial for maintenance dispatching.

Table 3 : Impact of Initial Ages on Overall Bottleneck Patterns

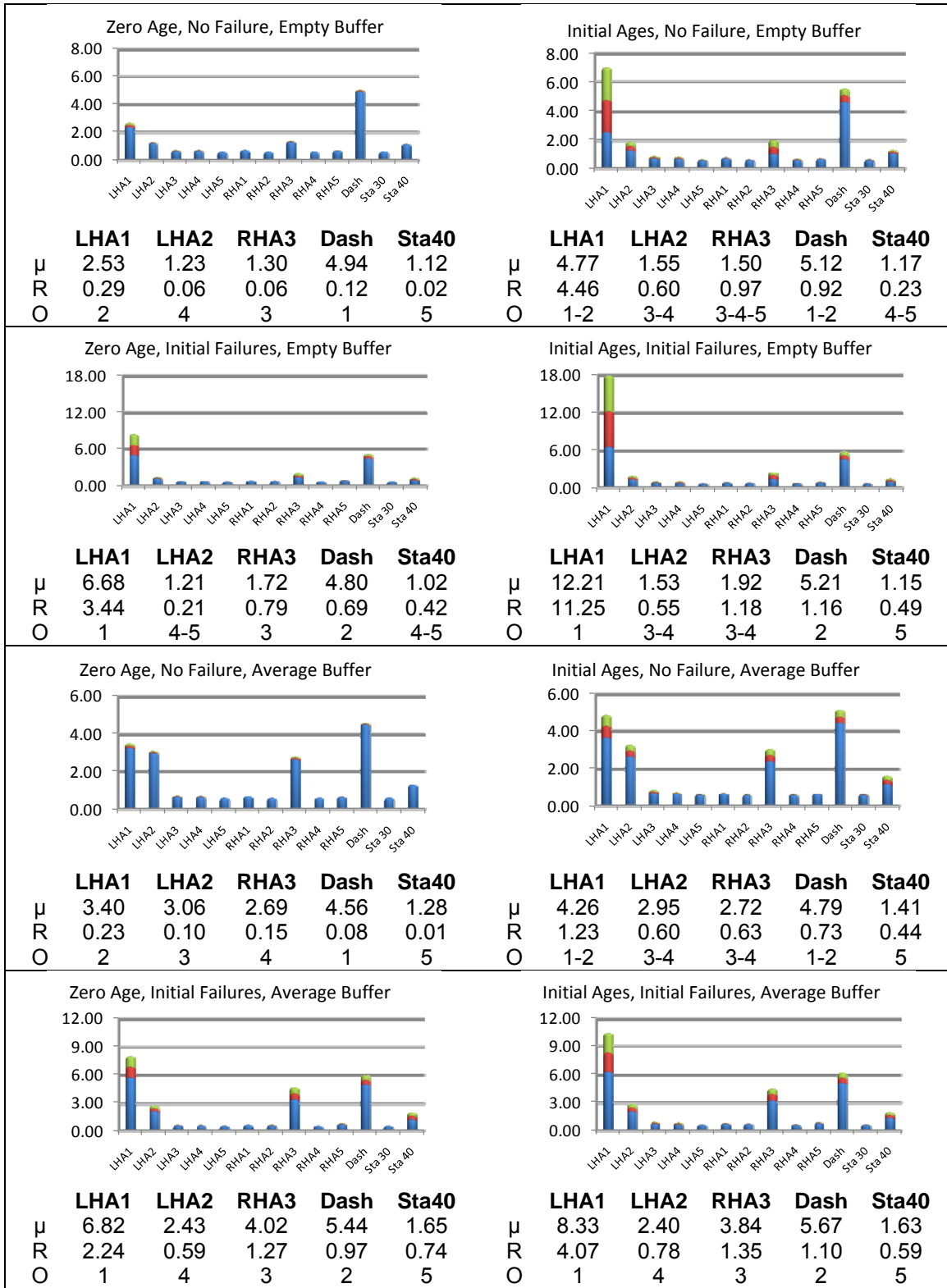

Table 4 : Impact of Initial Failures on Overall Bottleneck Patterns

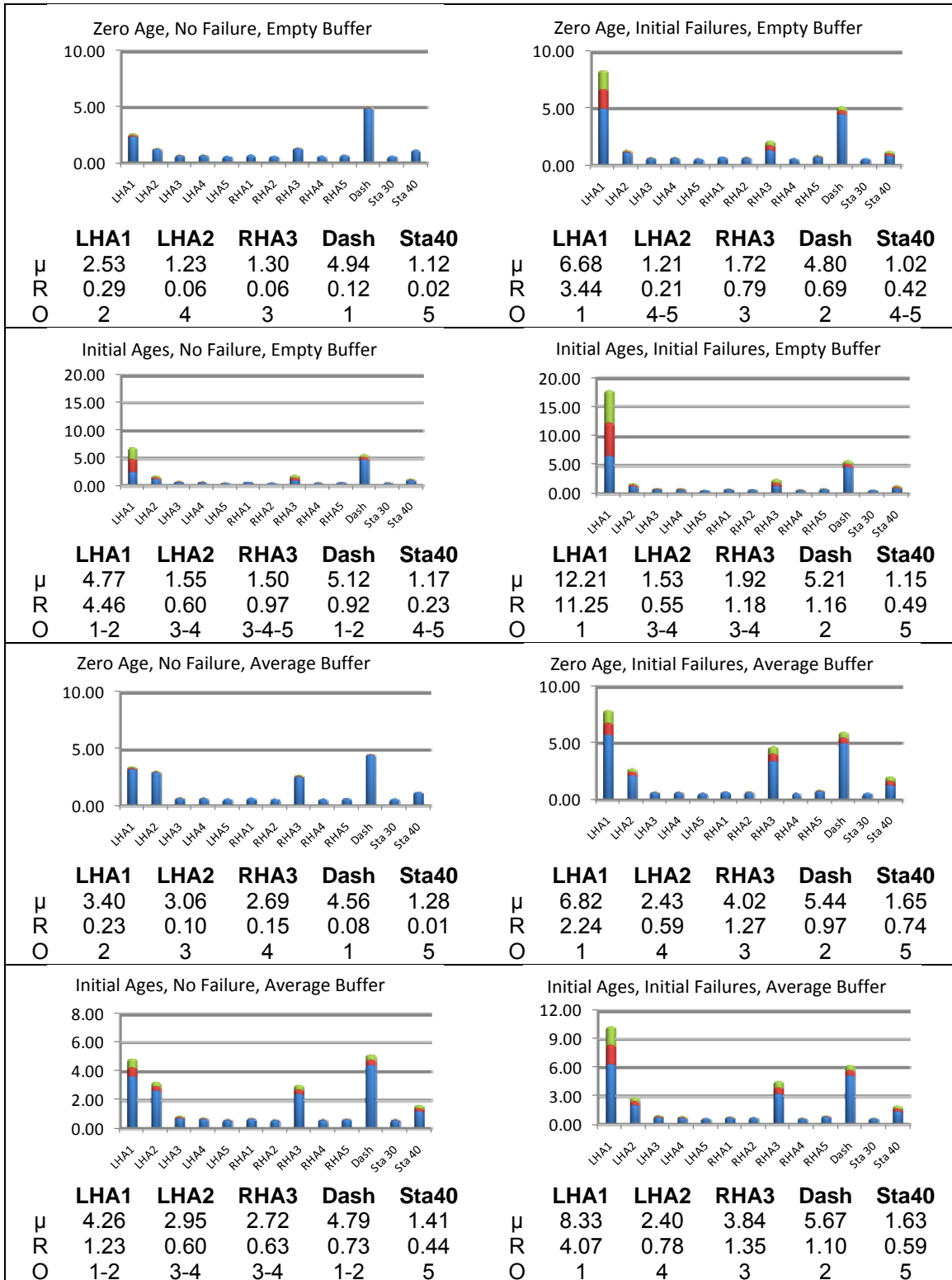
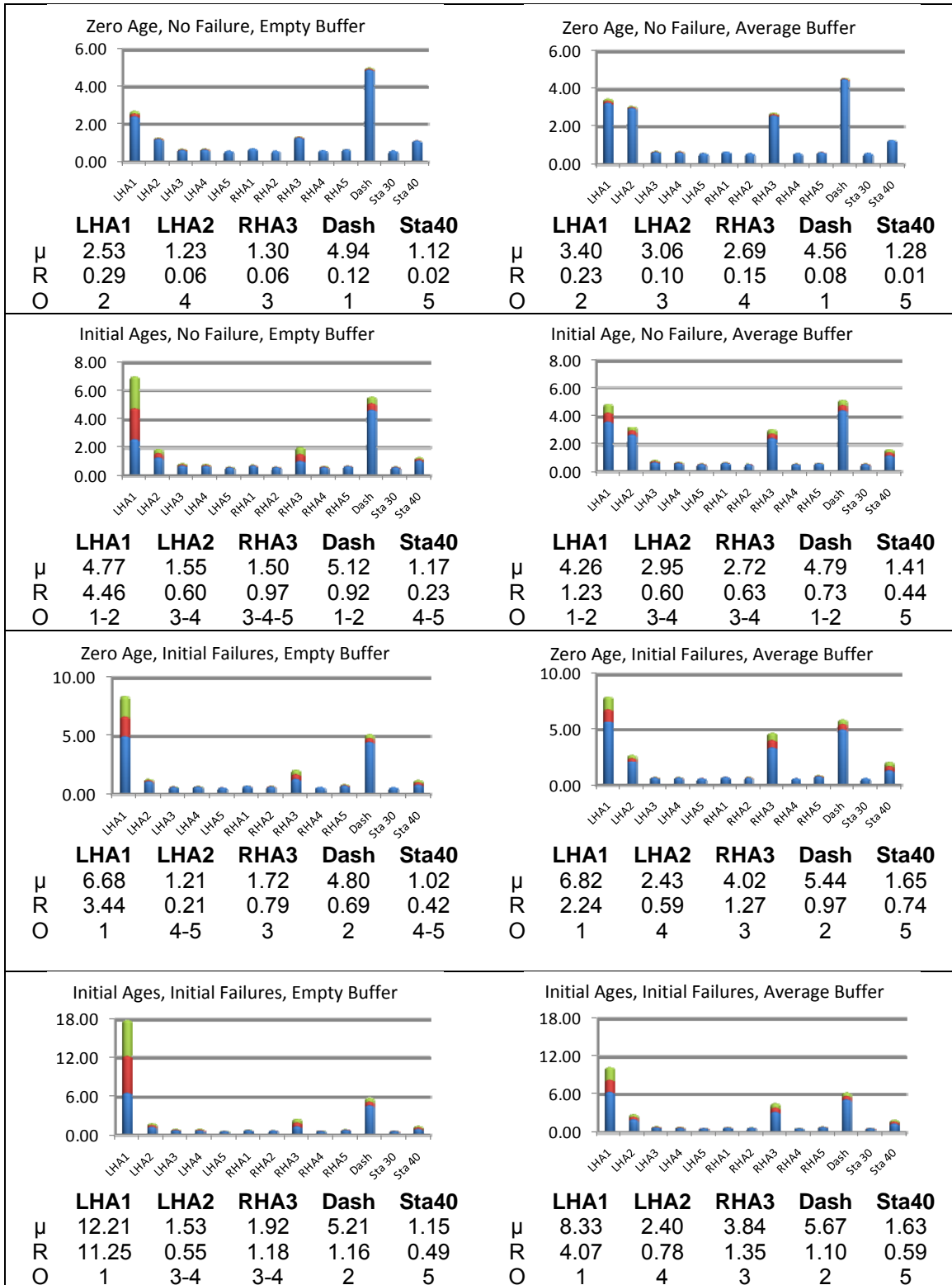

Table 5 : Impact of Initial Buffers on Overall Bottleneck Patterns



5.2. Corrective Maintenance Prioritization

As machines get older, the probability of observing simultaneous breakdowns increase and the CM prioritization becomes more important. In order to estimate the probability of simultaneous breakdowns, we conducted a simulation of 60 shifts of the calibrated/validated plant model with a warm-up period of 30 shifts. Results reveal that some 10.7% of the breakdowns constitute the simultaneous breakdowns of two or more stations. The number of simultaneous equipment breakdowns is counted by counting the number of stations that simultaneously require a CM service.

Performance of APMDSS in prioritizing corrective maintenance tasks of the upcoming production shift is compared to the performance of FCFS and PMDSS in both single model and model mix settings. APMDSS prioritizes the corrective repairs based on the bottleneck orders of the upcoming shift. So, it uses the initial conditions of that shift to determine the bottlenecks. When FCFS policy is adopted, stations are repaired in the order of breakdowns; in case of simultaneously failed stations, the repair order is random. Use of PMDSS suggests prioritizing the corrective repairs of the upcoming shift based on the bottleneck orders of the previous shift. Therefore, instead of using the current shift's initial conditions, the previous shift's initial conditions are used for setting the priorities. The assumptions we have made for PMDSS are as follows: the initial station ages and model mix information (100% Model I) come from the previous shift, buffers are at average levels, and all stations are at operational state.

In the experiments, the initial conditions of the upcoming shift are set from a combination of different age groups, operational status of stations, and buffer

occupancies. The age groups and the operational states of the machines are as given in Table 6 and Table 7. Buffers are set to either empty or average levels.

Table 6 : Age Groups (based on time elapsed in working state since last PM, in minutes)

Stations	Group 1	Group 2
LHA 1	512	1107
LHA 2	5632	3825
LHA 3	916	820
LHA 4	4931	2550
LHA 5	386	3875
RHA 1	5226	3212
RHA 2	4616	8284
RHA 3	5304	9513
RHA 4	4769	8555
RHA 5	4922	8832
Dash	6091	10912
Sta 30	4752	8511
Sta 40	5089	9116

Table 7 : Experimental Setting with Different Initial Failures (0: operational, 1: broken)

Stations	Failure Settings							
	A	B	C	D	E	F	G	H
LHA 1	0	1	0	1	1	1	0	0
LHA 2	1	0	0	1	0	0	0	0
LHA 3	0	0	0	0	0	0	1	0
LHA 4	0	0	1	0	0	0	0	1
LHA 5	0	0	1	0	0	0	0	0
RHA 1	0	1	0	0	0	0	0	0
RHA 2	0	0	0	0	0	0	1	0
RHA 3	1	0	0	1	0	1	0	0
RHA 4	0	0	1	0	0	0	0	1
RHA 5	0	0	0	0	0	0	1	1
Dash	0	0	0	1	1	1	0	0
Sta 30	1	1	0	0	0	0	0	0
Sta 40	0	0	0	1	1	1	0	0

5.2.1. Single Model Setting

The average throughput improvement percentages of APMDSS compared to the other methods are shown in Table 8 and Table 9, respectively. Positive values indicate that APMDSS performs better than the other method or vice versa. Values higher than 1% are highlighted in bold and values lower than -1% are highlighted in dotted frames. The statistically significant improvement values are shown with a star (*).

Table 8 : Superiority % of APMDSS compared to FCFS in CM Prioritization

		A	B	C	D	E	F	G	H
Average Buffers	Age Group 1	5.29*	3.97*	4.85*	1.38	-0.75	0.82	-0.72	-1.94
	Age Group 2	4.67*	4.20*	4.79*	0.06	-1.59	-0.16	-0.50	-1.89
Empty Buffers	Age Group 1	5.79*	6.74*	1.59	4.36	0.47	1.26	1.26	-0.74
	Age Group 2	5.55*	6.67*	1.56	3.39	0.42	1.77	-5.53*	-0.11

Table 9 : Superiority % of APMDSS compared to PMDSS in CM Prioritization

		A	B	C	D	E	F	G	H
Average Buffers	Age Group 1	1.78	-0.18	3.32	1.78	-0.27	-0.14	0.30	-1.56
	Age Group 2	1.50	-0.31	7.36*	1.38	-0.37	-0.26	0.31	-1.20
Empty Buffers	Age Group 1	2.23	0.00	-0.09	2.29	0.37	-0.56	-1.14	0.24
	Age Group 2	2.99	0.00	3.93*	1.62	0.20	-0.15	0.12	0.98

5.2.2. Model Mix Setting

The mix consists of 25% of Model I and 75% of Model II. The average throughput improvement percentages of APMDSS over the other methods are shown

in Table 10 and Table 11, respectively. Values higher than 1% (highlighted in bold) means APMDSS performs better than the corresponding method. Values lower than -1% (highlighted in dotted frames) means APMDSS performs worse.

Table 10 : Superiority % of APMDSS compared to FCFS in CM Prioritization

		A	B	C	D	E	F	G	H
Average Buffers	Age Group 1	4.20	1.28	-2.09	4.98	0.31	3.57	0.04	-4.03
	Age Group 2	5.13	1.23	2.21	4.69	-2.21	2.15	-0.46	-4.28
Empty Buffers	Age Group 1	5.18	6.53	-2.65	3.16	-0.08	2.23	-4.79	-0.88
	Age Group 2	4.09	3.86	-1.27	2.14	-0.29	4.92	-2.35	0.07

Table 11 : Superiority % of APMDSS compared to PMDSS in CM Prioritization

		A	B	C	D	E	F	G	H
Average Buffers	Age Group 1	1.55	0.05	-3.88	6.87	2.00	3.97	-0.05	-4.03
	Age Group 2	1.30	-0.16	3.68	5.63	0.03	1.87	0.00	-3.72
Empty Buffers	Age Group 1	1.95	0.00	-4.17	1.89	0.15	0.55	0.00	-0.34
	Age Group 2	2.67	-0.23	-0.13	2.33	-0.29	2.75	-0.11	0.27

5.3. Preventive Maintenance Prioritization

In the PM Prioritization experiments, the performance of a group of methods is tested by looking at the total throughput of two consecutive shifts. There are 10 experiment sets with different initial age groups given in

Table 12. The initial buffers are at average levels and all stations are initially operational.

Table 12 : Experimental Setting with Different Age Groups

Stations	Age Groups									
	1	2	3	4	5	6	7	8	9	10
LHA 1	1308	1302	1305	313	894	1272	481	1276	1304	1296
LHA 2	5065	2708	4011	719	1264	1618	2148	2894	4032	1768
LHA 3	423	1238	983	886	1364	268	732	1387	1077	578
LHA 4	4437	1569	2713	5290	5767	6077	301	955	2878	6111
LHA 5	4054	2979	4024	2204	2640	2922	3344	3941	4124	3049
RHA 1	4700	2174	3386	6124	341	674	1166	1860	3389	785
RHA 2	4154	7366	8437	10855	11301	11596	12029	244	8443	11634
RHA 3	4769	8458	9689	12467	446	783	1281	1986	9703	975
RHA 4	4292	7608	8714	11213	11674	11977	12423	568	8725	12016
RHA 5	4429	7853	8995	11573	12050	12363	300	955	9004	12403
Dash	5471	9700	11114	1889	2480	2864	3439	4248	11143	2913
Sta 30	4269	7566	8668	11149	11608	11905	12352	474	8691	11951
Sta 40	4572	8103	9285	11942	12433	168	646	1321	9309	268

The remaining life before hitting the threshold (RLT) values of the stations are given in Table 13. At the beginning of the shift, any catastrophic station failures are anticipated by looking at RLTs; the stations with failure alarms are written in red and marked by ([†]) in the table.

Table 13 : RLT Values, [†]: The stations with failure alarms

Stations	RLTs									
	1	2	3	4	5	6	7	8	9	10
LHA 1	82 [†]	88 [†]	85 [†]	1077	496	118 [†]	909	114 [†]	86 [†]	94 [†]
LHA 2	1175	3532	2229	5521	4976	4622	4092	3346	2208	4472
LHA 3	967	152 [†]	407	504	26 [†]	1122	658	3 [†]	313	812
LHA 4	1803	4671	3527	950	473	163 [†]	5939	5285	3362	129 [†]
LHA 5	106 [†]	1181	136 [†]	1956	1520	1238	816	219	36 [†]	1111
RHA 1	1540	4066	2854	116 [†]	5899	5566	5074	4380	2851	5455
RHA 2	8326	5114	4043	1625	1179	884	451	12236	4037	846
RHA 3	7711	4022	2791	13 [†]	12034	11697	11199	10494	2777	11505
RHA 4	8188	4872	3766	1267	806	503	57 [†]	11912	3755	464

RHA 5	8051	4627	3485	907	430	117 [†]	12180	11525	3476	77 [†]
Dash	7009	2780	1366	10591	10000	9616	9041	8232	1337	9567
Sta 30	8211	4914	3812	1331	872	575	128 [†]	12006	3789	529
Sta 40	7908	4377	3195	538	47 [†]	12312	11834	11159	3171	12212

When there is a failure alarm, a PM is scheduled based on the scheduling method.

Table 14 compares the performance of APMDSS with the Baseline, RLT, and PMDSS methods. According to the Baseline method, the higher the *Age/MTBF* ratio for a machine, the higher the PM priority. RLT method gives the highest priority to the machine with the smallest RLT. APMDSS and PMDSS both use the bottleneck ranks to assign the priorities. However, APMDSS exploits the bottleneck ranks of the upcoming shift while PMDSS uses the bottleneck ranks of the previous shift.

We observed two cases for preventive maintenance: One-PM-Slot case and Two-PM-Slot case. In One-PM-Slot case, PM can be done only at lunch breaks, and in Two-PM-Slot case, it can be done at both coffee and lunch breaks. If a machine cannot be maintained in the first shift, it is maintained right at the start of the next shift if the machine age has already hit the threshold. Since its PM requirement is already anticipated at the previous shift, the necessary equipment and spare parts can be prepared ahead of time.

5.3.1. Single Model Setting

The average throughput improvement percentages of APMDSS compared to the other methods are shown in

Table 14. The highlighted cells show where APMDSS performs better than the corresponding method. The statistically significant improvement values are shown with a star (*).

Table 14 : Superiority % of APMDSS compared to Other Methods in PM Prioritization

		1	2	3	4	5	6	7	8	9	10
Two PM Slots	Baseline	0.0	0.0	0.1	0.0	3.9*	2.4*	0.0	7.9*	-0.3	9.2*
	RLT	0.0	0.0	0.0	0.0	0.0	0.0	0.0	7.7*	-0.3	-0.2
	PMDSS	0.0	0.0	0.0	0.0	3.9*	2.3*	0.0	1.1	0.0	3.4*
	No PM	94.2*	87.7*	92.9*	119.1*	320.7*	107.7*	111.1*	442.8*	124.1*	141.2*
One PM Slot	Baseline	11.2*	0.0	11.8*	0.0	28.7*	0.2	0.0	0.0	4.4	5.7*
	RLT	0.0	0.0	0.0	0.0	0.0	0.2	0.0	0.0	4.4	5.7*
	PMDSS	0.0	0.0	0.0	0.0	28.7*	4.4*	0.0	55.2*	0.0	4.4*
	No PM	92.8*	88.0*	92.9*	115.6*	306.0*	103.2*	110.6*	402.3*	110.3*	133.5*

The throughput results of the One-PM-Slot case and the Two-PM-Slot case are compared in Table 15. The throughput results of the Two-PM-Slot case is slightly better or much better than that of the One-PM-Slot case in some of the experiment sets because if there is a need for a second PM, it is responded early, so the throughput loss due to machine health degradation is avoided. In the Two-PM-Slot case, the second PM requirement can be met in the second PM slot of the first shift instead of delaying it to start of the next shift. The statistically significant values are shown with a star.

Table 15 : Throughput Improvement % in Two-PM-Slot Case vs. One-PM-Slot Case

	1	2	3	4	5	6	7	8	9	10
APMDSS	0.7	-0.1	0.0	1.6	3.6	2.2*	0.2	8.1*	6.6*	3.3*
Baseline	11.9*	-0.1	11.7*	1.6	28.3*	0.0	0.2	0.1	11.6*	0.0

RLT	0.7	-0.1	0.0	1.6	3.6	2.4*	0.2	0.3	11.6*	9.4*
PMDSS	0.7	-0.1	0.0	1.6	28.3*	4.3*	0.2	65.8*	6.6*	4.3*

If there is no room for extra PM in a shift other than one PM slot, then the PM can be handled at some opportunistic times that arise during buffer accumulations. Consequently, lost throughput due to machine failures can be compensated.

5.3.2. Model Mix Setting

For these experiments, we assumed there is only one PM slot. The mix consists of 25% of Model I and 75% Model II. PMDSS uses the model mix information (100% Model I) of the previous shift. The average throughput improvement percentages of APMDSS over other methods are shown in Table 16. Values highlighted in bold where APMDSS performs better than the corresponding method. The statistically significant improvement values are shown with a star (*).

Table 16 : Superiority % of APMDSS compared to Other Methods in PM Prioritization

	1	2	3	4	5	6	7	8	9	10
Baseline	2.5	0.0	4.3*	0.0	30.5*	0.7	0.0	0.0	0.0	0.8
RLT	0.0	0.0	0.0	0.0	0.0	0.7	0.0	0.0	0.0	0.8
PMDSS	0.0	0.0	0.0	0.0	30.5*	0.1	0.0	66.0*	10.1*	0.1
No PM	123.2*	111.2*	118.3*	146.2*	348.3*	104.8*	114.0*	113225*	166.3*	110.1*

5.4. Combined CM, PM, and OM Prioritization in Model Mix Setting

The experiments here are done using the initial condition information given in

Table 17. The RLT values written in red ([†]) belong to the stations with failure alarms. The mix consists of 25% of Model I and 75% Model II, but PMDSS uses the model mix information (100% Model I) of the previous shift.

Table 17 : Experimental Setting for OM Prioritization, [†]: The stations with failure alarms

Stations	Age	RLT	Initial BreakDown
LHA1	1304	86[†]	1
LHA2	4032	2208	0
LHA3	1077	313	0
LHA4	2878	3362	0
LHA5	4124	36[†]	0
RHA1	3389	2851	1
RHA2	8443	4037	0
RHA3	9703	2777	0
RHA4	8725	3755	0
RHA5	9004	3476	0
Dash	11143	1337	0
Sta 30	8691	3789	1
Sta 40	9309	3171	0

Table 18 compares the CM and PM prioritization performance of APMDSS with others. APMDSS performs much better in most of the cases. The statistically significant improvement values are shown with a star (*).

Table 18 : Superiority % of APMDSS based CM and PM over Others

	A	B	C	D	E	F	G	H
FCFS based CM	1.98	2.50	-2.70	1.00	-0.62	-2.86	-4.38	-1.37
PMDSS based CM	1.75	-0.40	2.06	2.16	1.43	0.45	-0.49	-1.96
FCFS based CM + PM on LHA1	20.45*	17.30*	14.85*	17.10*	18.02*	17.45*	16.80*	17.12*
FCFS based CM + PM on LHA5	3.99*	0.44	-0.75	1.23	-0.52	1.94	-1.13	-3.12

PMDSS based
CM and PM

18.00* 18.53* 16.19* 16.58* 19.76* 19.33* 20.66* 17.02*

The hourly buffer averages are calculated at every 30th, 90th minutes, and so on with one-hour intervals and are shown in Table 19.

Table 19 : Hourly Buffer Averages

Conveyors	Minutes							
	30 th	90 th	150 th	210 th	270 th	330 th	390 th	450 th
LHConveyor 1	8.43	6.67	7.57	8.03	7.50	5.07	1.90	0.17
LHConveyor 2	7.13	5.37	6.70	6.90	4.60	5.13	1.50	0.20
LHConveyor 3	10.23	7.90	9.33	8.07	8.67	6.27	3.20	1.70
LHConveyor 4	7.87	7.57	7.53	6.20	8.03	6.57	8.37	8.80
LHConveyor 5	40.63	34.57	34.20	37.10	37.80	34.83	25.10	13.53
RHConveyor 1	4.63	6.17	7.40	7.43	4.30	7.97	3.90	8.17
RHConveyor 2	8.07	10.10	8.80	6.60	9.33	6.07	9.73	10.43
RHConveyor 3	7.10	5.20	6.07	7.43	5.83	7.83	5.00	5.60
RHConveyor 4	7.13	7.00	7.03	7.00	6.03	7.03	5.67	7.77
RHConveyor 5	23.83	10.33	5.20	2.93	6.00	2.73	7.40	16.57
DashConveyor	16.80	15.80	15.90	15.17	16.57	16.27	17.10	17.23

The OM realization probabilities, that are calculated when 50% and 25% of the buffers are kept for safety, are presented in Table 20 and Table 21.

Table 20 : "At Least 50% Full Buffer" Probabilities

Conveyors	Minutes							
	30 th	90 th	150 th	210 th	270 th	330 th	390 th	450 th
LHConveyor 1	0.87	0.77	0.87	0.93	0.73	0.57	0.17	0.03
LHConveyor 2	0.80	0.83	0.77	0.70	0.77	0.63	0.27	0.03
LHConveyor 3	0.97	0.73	0.83	0.80	0.90	0.60	0.33	0.17
LHConveyor 4	0.97	0.97	1.00	0.93	1.00	1.00	0.97	1.00
LHConveyor 5	1.00	0.83	0.87	1.00	0.97	0.93	0.60	0.30
RHConveyor 1	0.27	0.80	0.97	0.93	0.27	1.00	0.27	1.00
RHConveyor 2	0.77	0.80	0.67	0.30	0.80	0.20	0.90	0.87
RHConveyor 3	0.60	0.33	0.53	0.80	0.43	0.87	0.33	0.37

RHConveyor 4	1.00	0.97	0.97	1.00	1.00	1.00	0.97	1.00
RHConveyor 5	0.70	0.13	0.00	0.00	0.03	0.03	0.07	0.43
DashConveyor	1.00	1.00	1.00	0.93	1.00	1.00	1.00	1.00

Table 21 : “At Least 25% Full Buffer” Probabilities

Conveyors	Minutes							
	30 th	90 th	150 th	210 th	270 th	330 th	390 th	450 th
LHConveyor 1	0.93	0.87	0.87	0.93	0.83	0.63	0.23	0.03
LHConveyor 2	0.93	0.93	0.93	1.00	0.83	0.67	0.27	0.03
LHConveyor 3	1.00	1.00	1.00	1.00	0.90	0.77	0.37	0.20
LHConveyor 4	1.00	1.00	1.00	1.00	1.00	1.00	1.00	1.00
LHConveyor 5	1.00	0.97	0.93	1.00	1.00	0.97	0.73	0.43
RHConveyor 1	0.93	0.97	1.00	0.97	1.00	1.00	1.00	1.00
RHConveyor 2	0.80	0.90	1.00	0.97	1.00	1.00	1.00	0.97
RHConveyor 3	0.87	0.67	0.83	1.00	0.97	1.00	0.93	0.90
RHConveyor 4	1.00	1.00	0.97	1.00	1.00	1.00	0.97	1.00
RHConveyor 5	0.77	0.53	0.17	0.00	0.07	0.03	0.10	0.57
DashConveyor	1.00	1.00	1.00	1.00	1.00	1.00	1.00	1.00

It is assumed that a PM of a station takes 30 minutes, so the opportunity windows must be at least 30 minutes long. It is also assumed that PM will take place in the second half of an hour if the OM realization potential is higher than 50% and it improves the throughput. The predicted opportunistic windows are highlighted in Table 22, Table 23, and Table 24

In the experimental setting that is shown in

Table 17, LHA1 and LHA5 are the stations with failure alarm. APMDSS suggests doing PM on LHA5 during the lunch break, which is the only time that is allotted for PM. When there are opportunity windows for PM, LHA1 can also be maintained. Doing PM on LHA1 in the opportunistic time window adds another 6.4%

improvement in JPH and increases the value added to JPH by PM from 24.2% up to 30.6%.

Table 22 : Estimated Opportunity Windows with 50% Safety Level

Stations	30th	90th	150th	210th	270th	330th	390th	450th
LHA 1	55.6	30.5	37.5	42.3	39.1	23.7	1.3	0.0
LHA 2	49.1	27.8	32.8	36.7	34.6	24.4	2.1	0.0
LHA 3	44.4	26.8	29.0	32.5	35.2	23.9	2.9	0.0
LHA 4	42.7	29.3	28.4	31.7	37.1	27.7	11.1	5.5
LHA 5	36.4	23.7	22.9	29.0	30.5	24.2	3.8	0.0
RHA 1	12.2	2.3	2.2	2.5	0.0	4.5	0.0	7.2
RHA 2	13.3	0.0	0.0	0.0	0.0	0.0	0.0	0.5
RHA 3	13.3	0.0	0.0	0.0	0.0	0.0	0.0	0.0
RHA 4	18.2	2.5	2.5	2.5	0.4	2.5	0.0	4.1
RHA 5	12.3	0.0	0.0	0.0	0.0	0.0	0.0	0.0
Dash	13.5	11.4	11.6	10.0	13.0	12.4	14.1	14.4
Sta 30	0.0	0.0	0.0	0.0	0.0	0.0	0.0	0.0
Sta 40	0.0	0.0	0.0	0.0	0.0	0.0	0.0	0.0

Table 23 : Estimated Opportunity Windows with 25% Safety Level

Stations	30th	90th	150th	210th	270th	330th	390th	450th
LHA 1	95.0	69.9	76.8	81.7	78.4	63.2	24.4	0.0
LHA 2	83.3	61.9	66.9	70.8	68.7	58.5	25.2	0.0
LHA 3	73.8	56.2	58.4	61.9	64.6	53.3	26.0	0.0
LHA 4	70.5	57.1	56.3	59.6	64.9	55.6	38.9	10.2
LHA 5	59.5	46.8	46.0	52.1	53.6	47.3	26.9	0.0
RHA 1	48.8	19.5	21.2	19.5	15.3	20.4	13.6	25.3
RHA 2	44.8	12.3	11.4	9.7	12.0	9.4	11.1	13.9
RHA 3	36.9	0.2	2.0	4.9	1.5	5.7	0.0	1.0
RHA 4	39.7	6.7	6.7	6.7	4.6	6.7	3.9	8.3
RHA 5	29.6	0.0	0.0	0.0	0.0	0.0	0.0	0.0
Dash	22.9	20.8	21.0	19.5	22.4	21.8	23.6	23.8
Sta 30	0.0	0.0	0.0	0.0	0.0	0.0	0.0	0.0
Sta 40	0.0	0.0	0.0	0.0	0.0	0.0	0.0	0.0

Table 24 : Estimated Opportunity Windows without Safety Buffer

Stations	30th	90th	150th	210th	270th	330th	390th	450th
LHA 1	134.3	109.3	116.2	121.0	117.8	102.6	61.4	27.6

LHA 2	117.4	96.0	101.1	104.9	102.8	92.7	58.2	28.0
LHA 3	103.2	85.6	87.8	91.3	94.0	82.7	55.8	28.4
LHA 4	98.3	84.9	84.1	87.4	92.7	83.4	66.7	43.4
LHA 5	82.6	69.9	69.1	75.2	76.7	70.4	50.0	25.7
RHA 1	85.0	60.1	51.0	44.6	46.8	45.0	48.0	79.0
RHA 2	76.3	48.2	36.5	30.0	38.8	29.3	40.8	62.8
RHA 3	60.5	28.2	19.2	17.4	20.4	17.8	21.6	42.1
RHA 4	61.2	32.6	21.9	17.0	21.4	16.7	23.6	47.3
RHA 5	47.0	18.6	7.8	3.1	9.5	2.6	12.4	31.7
Dash	32.4	30.3	30.5	28.9	31.9	31.3	33.0	33.3
Sta 30	0.0	0.0	0.0	0.0	0.0	0.0	0.0	0.0
Sta 40	0.0	0.0	0.0	0.0	0.0	0.0	0.0	0.0

6. Conclusions and Future Research

Effective maintenance management is crucial in automotive manufacturing plants, which are often unable to reach throughput targets due to being down for long periods with machine breakdowns and overdue repairs. In this paper, we presented a DSS, which guides maintenance managers on making corrective and preventive maintenance related decisions for the upcoming production shift. It anticipates the dynamics (bottlenecks, hourly buffer levels, machine health) of the upcoming shift by exploiting the initial condition information. We showed that the initial conditions (i.e., machine ages, operational status of machines, buffer levels, and model mix) change the bottleneck patterns of the upcoming shift and the use of historic bottleneck data for maintenance task prioritization will not always perform well. We did the experiments using real data of an automotive body shop. We also used synthetic data to investigate the model mix case. The performance of APMDSS in CM, PM, and OM prioritization is compared with Li et al.'s (2009) PMDSS and other traditional approaches. The APMDSS performed significantly better in many of the cases.

In future work, we will extend our DSS to incorporate partial PM so as to benefit the most from the opportunity windows since it takes less time than a complete PM. Preemptive CM will also be integrated to let higher degree bottlenecks resume production without much delay.

CHAPTER III: THROUGHPUT ANALYSIS OF A PRODUCTION SYSTEM WITH TWO DETERIORATING MACHINES AND A FINITE BUFFER

Abstract – The paper presents an analytical evaluation of the throughput of an identically deteriorating two-machine and a finite buffer production line. Unlike the previous studies, the machines degrade with usage and the reliability behavior of each machine changes depending on the machine's health condition. Further, we account for cases where failed machines can be either perfectly or imperfectly repaired. The state transitions of the system are modeled using Markov chains. Geometric failure and repair/maintenance probabilities are defined for each state. The performance of the method is compared with existing methods which consider only perfect repair.

1. Introduction

Unreliable machines, finite buffers, varying processing times, etc. are the sources of variability in the production lines that make the throughput evaluation unpredictable. On the other hand, an accurate estimation of the production performance is important for the design and improvement of manufacturing systems. The estimation can be done using either simulation models or analytical models. Having an analytical formula is more desirable because the development and execution of simulation models can be time consuming. However, exact analytical models are only available for small systems such as two machine-one buffer or three

machine-two buffer systems with restrictive assumptions. The study of these simple systems is not trivial because they have been used as the building blocks for the analysis of longer lines or more complex production systems.

In the paper, we derive an analytical formula for two-machine production lines, consisting of two deteriorating machines and a finite buffer. A two-machine system is depicted in Figure 1. Several models of two-machine lines have been studied over the last 50 years (Li et al., 2006). Gershwin (1994) presents a deterministic analytical model for two-machine finite buffer line with two machine states (operational, down) and perfect repairs. We relax this model's assumptions and consider machine health degradation and perfect and imperfect repairs simultaneously. The machine deterioration is common in industry because the performance of the machines degrades over time due to wear out and is the motivation for this study. To the best of our knowledge, this paper is the first to analyze the production throughput for deteriorating systems.

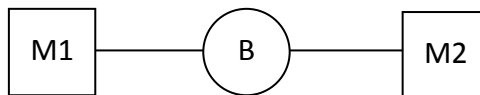

Figure 1 : Two-Machine Line

The paper is organized as follows: Section 2 describes the related literature on analytical throughput prediction models. In Section 3, we introduce our proposed model and its assumptions. Section 4 presents performance measures of the model. In Section 5, we derive compact formulas for calculating the steady-state probabilities. The experimental results are presented in Section 6. Finally, we conclude the study and propose directions for future research in Section 7.

2. Literature Survey

There have been many studies on the throughput prediction of production systems over the last 50 years (See the bibliography by Perros, 1983; literature reviews by Dallery and Gershwin, 1992; Papadopoulos and Heavey, 1996; Govil and Fu, 1999; and the monographs by Buzacott and Shantikumar, 1993; Gershwin, 1994; Altioik, 1997). The earliest and most popular work on a two-machine and a finite buffer system is done by Buzacott (1967). Even though there are few other studies done earlier than Buzacott's model, they were difficult to understand by practitioners due to their mathematical representation (Lim et al., 1990).

Throughput performance for both reliable and unreliable systems has been analyzed in literature. The two-machine line models with random failures and finite buffers can be divided into two categories depending on whether the processing time is random or deterministic. Papers which use random processing times assume exponential failures, where papers which use deterministic processing times assume geometric or Bernoulli failures. Gershwin and Berman (1981) provide a model with random processing times. Another classification is based on whether the failures are time-dependent or operation-dependent. Li and Meerkov (2003) model the two-machine systems with time-dependent failures. Our model uses deterministic processing times and operation-dependent failures. Earlier models in this category are developed by Buzacott (1967) and Gershwin and Schick (1983). Tolio et al. (2002) extends the model in Gershwin and Schick (1983) for two-machine lines with multiple failure modes.

3. Model Description

Consider a two-machine line as in Figure 1, where M1 and M2 represent the machines and B represents the buffer. As raw materials enter the system, they are first processed on Machine 1, transferred to Machine 2 passing through the buffer, and then leave the system. In the model, we characterize the machine states, which represent the health condition of each machine, with different failure and repair/maintenance probabilities. All degradation, failure, repair, and maintenance probabilities are assumed to be geometrically distributed and service times are assumed to be one time unit for each working machine. Buffer level, n can take any discrete value from 0 to N .

Each machine can be in three possible states: 2 representing the “as good as new” state, 1 representing the “degraded, but operational” state, and 0 representing the “down” state. Machines degrade gradually from 2 to 0 with usage. Figure 2 shows the state transition probabilities of Machine 1 and Machine 2. If Machine 1 starts processing a part in state 2, there is a probability of ap_2 that it degrades to state 1 and a probability of ap_3 that it fails in that cycle. If it starts processing in state 1, there is a probability of ap_1 that it fails in that cycle. If Machine 1 is down at the beginning of a cycle, there is a probability of ar_1 that it is repaired to an “as bad as old” state (State 1) or a probability of $a\varphi$ that it is repaired to an “as good as new” state (State 2) in that cycle. ar_2 is a probability of maintaining Machine 1 from a “degraded, but operational” state to an “as good as new” state in that cycle. Same transitions apply for Machine 2. A parameter α_i can be used to define the states of Machine $i = 1, 2$.

$$\alpha_i = \begin{cases} 2, & \text{as good as new (operational)} \\ 1, & \text{degraded, but operational} \\ 0, & \text{down} \end{cases}$$

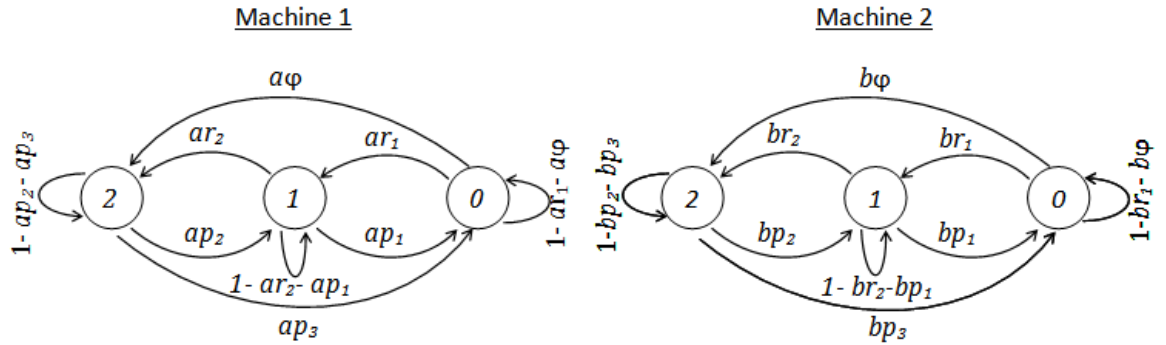

Figure 2 : State Transitions of Machine 1 and Machine 2

In total, we have 13 parameters to characterize the two-machine system: $ar_1, ar_2, a\phi, ap_1, ap_2, ap_3, br_1, br_2, b\phi, bp_1, bp_2, bp_3$ and N . We can show the state of the system as (n, α_1, α_2) , and the probability of being in that state with $P(n, \alpha_1, \alpha_2)$.

The model is based on the following assumptions:

- The machines are identical.
- Service times are one time unit for each of working state of the machines.
- All degradation, failure, repair, and maintenance probabilities are geometrically distributed.
- The buffer has finite capacity. At most one part enters and one part exits the buffer in a time unit.
- Machine 1 is blocked when the buffer is full and Machine 2 is starved when the buffer is empty.
- Machine 1 is never starved, Machine 2 is never blocked.

- Degradations and failures are operation-dependent, i.e., the machines degrade or fail by usage. Further, machines do not fail when they are starved or blocked.
- No part is scrapped.
- Part transfer time is negligible.
- Machine degradations, failures, and repairs occur at the beginning of time units, buffer level changes at the end of time units.
- The analysis is done under steady-state.

4. Performance Measures

The most important performance measure of the two-machine system is the throughput or production rate, E_i . It is the parts produced per unit time by machine i . Because no parts are scrapped or destructed, we have $E_1 = E_2$ in steady state.

$$\text{The probability of blocking, } P_b = P(N, 1, 0) + P(N, 2, 0) \quad (1)$$

$$\text{The probability of starving, } P_s = P(0, 0, 1) + P(0, 0, 2) \quad (2)$$

$$E_1 = e_1(1 - P_b) \quad (3)$$

$$E_2 = e_2(1 - P_s) \quad (4)$$

The isolated production rate, e_i is the fraction of time that Machine i would be in an operational state if it was in isolation and it was never starved or blocked. Figure 3 classifies the operational and non-operational states of Machine 2. Same classification is also possible for Machine 1.

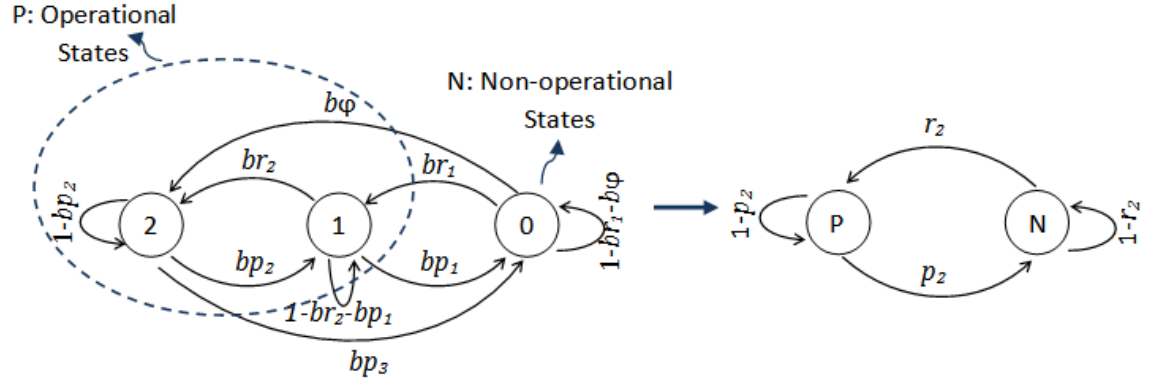

Figure 3 : Operational and Non-operational States of Machine 2

From the steady-state probabilities of being in each state (0, 1, and 2), we can write e_i for Machine $i=1, 2$ as,

$$e_i = \frac{r_i}{r_i + p_i} \quad (5)$$

$$r_1 = ar_1 + a\phi \quad (6)$$

$$r_2 = br_1 + b\phi \quad (7)$$

$$p_1 = \frac{ap_1(a\phi ap_2 + ap_3 ar_1 + ar_1 ap_2) + ap_3(ar_1 ar_2 + a\phi ap_1 + a\phi ar_2)}{a\phi ap_2 + ap_3 ar_1 + ar_1 ap_2 + ar_1 ar_2 + a\phi ap_1 + a\phi ar_2} \quad (8)$$

$$p_2 = \frac{bp_1(b\phi bp_2 + bp_3 br_1 + br_1 bp_2) + bp_3(br_1 br_2 + b\phi bp_1 + b\phi br_2)}{b\phi bp_2 + bp_3 br_1 + br_1 bp_2 + br_1 br_2 + b\phi bp_1 + b\phi br_2} \quad (9)$$

Another important performance measure is the average work-in-process (buffer level, inventory). The steady-state average buffer level can be written as,

$$\bar{n} = \sum_{n=0}^N \sum_{\alpha_2=0}^2 \sum_{\alpha_1=0}^2 nP(n, \alpha_1, \alpha_2) \quad (10)$$

In order to measure the performance of the system, we need to know all the steady-state probabilities.

5. Solution Methodology

The system that we are modeling has $M = 3^2(N + 1)$ states. Therefore, we need to solve M linear transition equations in M unknowns to find the steady-state probabilities. However, this method becomes impractical when N is large. Gershwin (1994) describes a structure of the deterministic processing time model, which we will exploit to solve the deteriorating machines case of the two-machine problem. According to Gershwin (1994), it is possible that $P(n, \alpha_1, \alpha_2)$ is a linear combination of ℓ vectors, ξ_1, \dots, ξ_ℓ , which satisfies at least $M - \ell$ of the transition equations.

Firstly, we will surmise a form of the internal state probabilities. Then, using this form, we identify a set of solutions for the resulting internal equations. If a linear combination of these solutions also satisfies the boundary equations, then the solution procedure becomes complete.

5.1. Analysis of Internal Equations

Internal states include the states in which the buffer level, n has the condition of $2 \leq n \leq N - 2$. Transition equations for internal states are given in the subsection below.

5.1.1. Internal equations for $2 \leq n \leq N - 2$

$$\begin{aligned}
 P(n, 0, 0) = & (1 - ar_1 - a\varphi)(1 - br_1 - b\varphi)P(n, 0, 0) + (1 - ar_1 - a\varphi)bp_1P(n, 0, 1) \\
 & + (1 - ar_1 - a\varphi)bp_3P(n, 0, 2) + ap_1(1 - br_1 - b\varphi)P(n, 1, 0) \\
 & + ap_1bp_1P(n, 1, 1) + ap_1bp_3P(n, 1, 2) + ap_3(1 - br_1 - b\varphi)P(n, 2, 0) \\
 & + ap_3bp_1P(n, 2, 1) + ap_3bp_3P(n, 2, 2)
 \end{aligned} \tag{11}$$

$$\begin{aligned}
P(n, 0, 1) &= (1 - ar_1 - a\varphi)br_1P(n + 1, 0, 0) + (1 - ar_1 - a\varphi)(1 - br_2 - bp_1)P(n + 1, 0, 1) \\
&\quad + (1 - ar_1 - a\varphi)bp_2P(n + 1, 0, 2) + ap_1br_1P(n + 1, 1, 0) \\
&\quad + ap_1(1 - br_2 - bp_1)P(n + 1, 1, 1) + ap_1bp_2P(n + 1, 1, 2) \\
&\quad + ap_3br_1P(n + 1, 2, 0) + ap_3(1 - br_2 - bp_1)P(n + 1, 2, 1) \\
&\quad + ap_3bp_2P(n + 1, 2, 2)
\end{aligned} \tag{12}$$

$$\begin{aligned}
P(n, 0, 2) &= (1 - ar_1 - a\varphi)b\varphi P(n + 1, 0, 0) + (1 - ar_1 - a\varphi)br_2P(n + 1, 0, 1) \\
&\quad + (1 - ar_1 - a\varphi)(1 - bp_2 - bp_3)P(n + 1, 0, 2) + ap_1b\varphi P(n + 1, 1, 0) \\
&\quad + ap_1br_2P(n + 1, 1, 1) + ap_1(1 - bp_2 - bp_3)P(n + 1, 1, 2) \\
&\quad + ap_3b\varphi P(n + 1, 2, 0) + ap_3br_2P(n + 1, 2, 1) + ap_3(1 - bp_2 \\
&\quad - bp_3)P(n + 1, 2, 2)
\end{aligned} \tag{13}$$

$$\begin{aligned}
P(n, 1, 0) &= ar_1(1 - br_1 - b\varphi)P(n - 1, 0, 0) + ar_1bp_1P(n - 1, 0, 1) + ar_1bp_3P(n - 1, 0, 2) \\
&\quad + (1 - ar_2 - ap_1)(1 - br_1 - b\varphi)P(n - 1, 1, 0) \\
&\quad + (1 - ar_2 - ap_1)bp_1P(n - 1, 1, 1) + (1 - ar_2 - ap_1)bp_3P(n - 1, 1, 2) \\
&\quad + ap_2(1 - br_1 - b\varphi)P(n - 1, 2, 0) + ap_2bp_1P(n - 1, 2, 1) \\
&\quad + ap_2bp_3P(n - 1, 2, 2)
\end{aligned} \tag{14}$$

$$\begin{aligned}
P(n, 1, 1) &= ar_1br_1P(n, 0, 0) + ar_1(1 - br_2 - bp_1)P(n, 0, 1) + ar_1bp_2P(n, 0, 2) \\
&\quad + (1 - ar_2 - ap_1)br_1P(n, 1, 0) + (1 - ar_2 - ap_1)(1 - br_2 - bp_1)P(n, 1, 1) \\
&\quad + (1 - ar_2 - ap_1)bp_2P(n, 1, 2) + ap_2br_1P(n, 2, 0) \\
&\quad + ap_2(1 - br_2 - bp_1)P(n, 2, 1) + ap_2bp_2P(n, 2, 2)
\end{aligned} \tag{15}$$

$$\begin{aligned}
P(n, 1, 2) = & ar_1 b \varphi P(n, 0, 0) + ar_1 br_2 P(n, 0, 1) + ar_1 (1 - bp_2 - bp_3) P(n, 0, 2) \\
& + (1 - ar_2 - ap_1) b \varphi P(n, 1, 0) + (1 - ar_2 - ap_1) br_2 P(n, 1, 1) \\
& + (1 - ar_2 - ap_1) (1 - bp_2 - bp_3) P(n, 1, 2) + ap_2 b \varphi P(n, 2, 0) \\
& + ap_2 br_2 P(n, 2, 1) + ap_2 (1 - bp_2 - bp_3) P(n, 2, 2)
\end{aligned} \tag{16}$$

$$\begin{aligned}
P(n, 2, 0) = & a \varphi (1 - br_1 - b \varphi) P(n - 1, 0, 0) + a \varphi bp_1 P(n - 1, 0, 1) + a \varphi bp_3 P(n - 1, 0, 2) \\
& + ar_2 (1 - br_1 - b \varphi) P(n - 1, 1, 0) + ar_2 bp_1 P(n - 1, 1, 1) \\
& + ar_2 bp_3 P(n - 1, 1, 2) + (1 - ap_2 - ap_3) (1 - br_1 - b \varphi) P(n - 1, 2, 0) + (1 - ap_2 - ap_3) bp_1 P(n - 1, 2, 1) \\
& + (1 - ap_2 - ap_3) bp_3 P(n - 1, 2, 2)
\end{aligned} \tag{17}$$

$$\begin{aligned}
P(n, 2, 1) = & a \varphi br_1 P(n, 0, 0) + a \varphi (1 - br_2 - bp_1) P(n, 0, 1) + a \varphi bp_2 P(n, 0, 2) \\
& + ar_2 br_1 P(n, 1, 0) + ar_2 (1 - br_2 - bp_1) P(n, 1, 1) + ar_2 bp_2 P(n, 1, 2) \\
& + (1 - ap_2 - ap_3) br_1 P(n, 2, 0) + (1 - ap_2 - ap_3) (1 - br_2 - bp_1) P(n, 2, 1) + (1 - ap_2 - ap_3) bp_2 P(n, 2, 2)
\end{aligned} \tag{18}$$

$$\begin{aligned}
P(n, 2, 2) = & a \varphi b \varphi P(n, 0, 0) + a \varphi br_2 P(n, 0, 1) + a \varphi (1 - bp_2) P(n, 0, 2) + ar_2 b \varphi P(n, 1, 0) \\
& + ar_2 br_2 P(n, 1, 1) + ar_2 (1 - bp_2 - bp_3) P(n, 1, 2) + (1 - ap_2 - ap_3) b \varphi P(n, 2, 0) \\
& + (1 - ap_2 - ap_3) br_2 P(n, 2, 1) + (1 - ap_2 - ap_3) (1 - bp_2 - bp_3) P(n, 2, 2)
\end{aligned} \tag{19}$$

5.1.2. Solution of the Internal Equations

The steady-state probability distribution for internal states can be shown as,

$$P(n, \alpha_1, \alpha_2) = \sum_{j=1}^{\ell} C_j \xi_j(n, \alpha_1, \alpha_2), \text{ where}$$

$\xi(n, \alpha_1, \alpha_2) = X^n \phi(\alpha_1, \alpha_2)$. If we substitute $\xi(n, \alpha_1, \alpha_2)$ with $X^n \phi(\alpha_1, \alpha_2)$ in the internal equation, we get the following equations:

$$\begin{aligned} \phi(0,0) &= (1 - ar_1 - a\varphi)(1 - br_1 - b\varphi)\phi(0,0) + (1 - ar_1 - a\varphi)bp_1\phi(0,1) \\ &\quad + (1 - ar_1 - a\varphi)bp_3\phi(0,2) + ap_1(1 - br_1 - b\varphi)\phi(1,0) + ap_1bp_1\phi(1,1) \\ &\quad + ap_1bp_3\phi(1,2) + ap_3(1 - br_1 - b\varphi)\phi(2,0) + ap_3bp_1\phi(2,1) \\ &\quad + ap_3bp_3\phi(2,2) \end{aligned} \quad (20)$$

$$\begin{aligned} X^{-1}\phi(0,1) &= (1 - ar_1 - a\varphi)br_1\phi(0,0) + (1 - ar_1 - a\varphi)(1 - br_2 - bp_1)\phi(0,1) \\ &\quad + (1 - ar_1 - a\varphi)bp_2\phi(0,2) + ap_1br_1\phi(1,0) + ap_1(1 - br_2 - bp_1)\phi(1,1) \\ &\quad + ap_1bp_2\phi(1,2) + ap_3br_1\phi(2,0) + ap_3(1 - br_2 - bp_1)\phi(2,1) \\ &\quad + ap_3bp_2\phi(2,2) \end{aligned} \quad (21)$$

$$\begin{aligned} X^{-1}\phi(0,2) &= (1 - ar_1 - a\varphi)b\varphi\phi(0,0) + (1 - ar_1 - a\varphi)br_2\phi(0,1) + (1 - ar_1 - a\varphi)(1 \\ &\quad - bp_2 - bp_3)\phi(0,2) + ap_1b\varphi\phi(1,0) + ap_1br_2\phi(1,1) + ap_1(1 - bp_2 \\ &\quad - bp_3)\phi(1,2) + ap_3b\varphi\phi(2,0) + ap_3br_2\phi(2,1) + ap_3(1 - bp_2 \\ &\quad - bp_3)\phi(2,2) \end{aligned} \quad (22)$$

$$\begin{aligned} X\phi(1,0) &= ar_1(1 - br_1 - b\varphi)\phi(0,0) + ar_1bp_1\phi(0,1) + ar_1bp_3\phi(0,2) \\ &\quad + (1 - ar_2 - ap_1)(1 - br_1 - b\varphi)\phi(1,0) + (1 - ar_2 - ap_1)bp_1\phi(1,1) \\ &\quad + (1 - ar_2 - ap_1)bp_3\phi(1,2) + ap_2(1 - br_1 - b\varphi)\phi(2,0) + ap_2bp_1\phi(2,1) \\ &\quad + ap_2bp_3\phi(2,2) \end{aligned} \quad (23)$$

$$\begin{aligned}
\phi(1,1) &= ar_1 br_1 \phi(0,0) + ar_1(1 - br_2 - bp_1)\phi(0,1) + ar_1 bp_2 \phi(0,2) \\
&\quad + (1 - ar_2 - ap_1)br_1 \phi(1,0) + (1 - ar_2 - ap_1)(1 - br_2 - bp_1)\phi(1,1) \\
&\quad + (1 - ar_2 - ap_1)bp_2 \phi(1,2) + ap_2 br_1 \phi(2,0) \\
&\quad + ap_2(1 - br_2 - bp_1)\phi(2,1) + ap_2 bp_2 \phi(2,2)
\end{aligned} \tag{24}$$

$$\begin{aligned}
\phi(1,2) &= ar_1 b\phi(0,0) + ar_1 br_2 \phi(0,1) + ar_1(1 - bp_2 - bp_3)\phi(0,2) \\
&\quad + (1 - ar_2 - ap_1)b\phi(1,0) + (1 - ar_2 - ap_1)br_2 \phi(1,1) \\
&\quad + (1 - ar_2 - ap_1)(1 - bp_2 - bp_3)\phi(1,2) + ap_2 b\phi(2,0) + ap_2 br_2 \phi(2,1) \\
&\quad + ap_2(1 - bp_2 - bp_3)\phi(2,2)
\end{aligned} \tag{25}$$

$$\begin{aligned}
X\phi(2,0) &= a\phi(1 - br_1 - b\phi)\phi(0,0) + a\phi bp_1 \phi(0,1) + a\phi bp_3 \phi(0,2) \\
&\quad + ar_2(1 - br_1 - b\phi)\phi(1,0) + ar_2 bp_1 \phi(1,1) + ar_2 bp_3 \phi(1,2) + (1 - ap_2 \\
&\quad - ap_3)(1 - br_1 - b\phi)\phi(2,0) + (1 - ap_2 - ap_3)bp_1 \phi(2,1) + (1 - ap_2 \\
&\quad - ap_3)bp_3 \phi(2,1)
\end{aligned} \tag{26}$$

$$\begin{aligned}
\phi(2,1) &= a\phi br_1 \phi(0,0) + a\phi(1 - br_2 - bp_1)\phi(0,1) + a\phi bp_2 \phi(0,2) + ar_2 br_1 \phi(1,0) \\
&\quad + ar_2(1 - br_2 - bp_1)\phi(1,1) + ar_2 bp_2 \phi(1,2) \\
&\quad + (1 - ap_2 - ap_3)br_1 \phi(2,0) + (1 - ap_2 - ap_3)(1 - br_2 - bp_1)\phi(2,1) \\
&\quad + (1 - ap_2 - ap_3)bp_2 \phi(2,2)
\end{aligned} \tag{27}$$

$$\begin{aligned}
\phi(2,2) &= a\phi b\phi(0,0) + a\phi br_2 \phi(0,1) + a\phi(1 - bp_2)\phi(0,2) + ar_2 b\phi(1,0) \\
&\quad + ar_2 br_2 \phi(1,1) + ar_2(1 - bp_2 - bp_3)\phi(1,2) + (1 - ap_2 - ap_3)b\phi(2,0) \\
&\quad + (1 - ap_2 - ap_3)br_2 \phi(2,1) + (1 - ap_2 - ap_3)(1 - bp_2 - bp_3)\phi(2,2)
\end{aligned} \tag{28}$$

Now, we surmise that $\phi(\alpha_1, \alpha_2)$ has the following form:

$$\begin{aligned}
\phi(0,0) &= 1 & \phi(1,1) &= Y_1Y_2 \\
\phi(1,0) &= Y_1 & \phi(1,2) &= Y_1Y_4 \\
\phi(0,1) &= Y_2 & \phi(2,1) &= Y_2Y_3 \\
\phi(2,0) &= Y_3 & \phi(2,2) &= Y_3Y_4 \\
\phi(0,2) &= Y_4
\end{aligned}$$

Substituting these expressions into equations (20)-(28) and factoring, we obtain,

$$1 = (1 - ar_1 - a\varphi + ap_1Y_1 + ap_3Y_3)(1 - br_1 - b\varphi + bp_1Y_2 + bp_3Y_4) \quad (29)$$

$$XY_1 = (ar_1 + (1 - ar_2 - ap_1)Y_1 + ap_2Y_3)(1 - br_1 - b\varphi + bp_1Y_2 + bp_3Y_4) \quad (30)$$

$$X^{-1}Y_2 = (1 - ar_1 - a\varphi + ap_1Y_1 + ap_3Y_3)(br_1 + (1 - br_2 - bp_1)Y_2 + bp_2Y_4) \quad (31)$$

$$XY_3 = (a\varphi + ar_2Y_1 + (1 - ap_2 - ap_3)Y_3)(1 - br_1 - b\varphi + bp_1Y_2 + bp_3Y_4) \quad (32)$$

$$X^{-1}Y_4 = (1 - ar_1 - a\varphi + ap_1Y_1 + ap_3Y_3)(b\varphi + br_2Y_2 + (1 - bp_2 - bp_3)Y_4) \quad (33)$$

$$Y_1Y_2 = (ar_1 + (1 - ar_2 - ap_1)Y_1 + ap_2Y_3)(br_1 + (1 - br_2 - bp_1)Y_2 + bp_2Y_4) \quad (34)$$

$$Y_1Y_4 = (ar_1 + (1 - ar_2 - ap_1)Y_1 + ap_2Y_3)(b\varphi + br_2Y_2 + (1 - bp_2 - bp_3)Y_4) \quad (35)$$

$$Y_2Y_3 = (a\varphi + ar_2Y_1 + (1 - ap_2 - ap_3)Y_3)(br_1 + (1 - br_2 - bp_1)Y_2 + bp_2Y_4) \quad (36)$$

$$Y_3Y_4 = (a\varphi + ar_2Y_1 + (1 - ap_2 - ap_3)Y_3)(b\varphi + br_2Y_2 + (1 - bp_2 - bp_3)Y_4) \quad (37)$$

To find out the solutions for $X, Y_1, Y_2, Y_3,$ and $Y_4,$ we need to solve the nonlinear system of equations in (29)-(37). There are four solution sets to the problem. To simplify the problem, we write the following equalities by exploiting the common factors in equations (29)-(37). Three of the solutions are obtained using the equalities below:

$$X^{-1} = (1 - ar_1 - a\varphi + ap_1Y_1 + ap_3Y_3)k_1$$

$$X = (1 - br_1 - b\varphi + bp_1Y_2 + bp_3Y_4)k_2$$

$$Y_1 = (ar_1 + (1 - ar_2 - ap_1)Y_1 + ap_2Y_3)k_1$$

$$Y_2 = (br_1 + (1 - br_2 - bp_1)Y_2 + bp_2Y_4)k_2$$

$$Y_3 = (a\varphi + ar_2Y_1 + (1 - ap_2 - ap_3)Y_3)k_1$$

$$Y_4 = (b\varphi + br_2Y_2 + (1 - bp_2 - bp_3)Y_4)k_2$$

From equation (29),

$$k_1k_2 = 1$$

When $k_{11} = k_{21} = 1$, the first solution set for equations (29)-(37) will be,

$$\begin{aligned}
 Y_{11} &= \frac{ar_1ap_3 + a\varphi ap_2 + ar_1ap_2}{ap_1ap_3 + ap_3ar_2 + ap_1ap_2} \\
 Y_{21} &= \frac{br_1bp_3 + b\varphi bp_2 + br_1bp_2}{bp_1bp_3 + bp_3br_2 + bp_1bp_2} \\
 Y_{31} &= \frac{a\varphi ap_1 + a\varphi ar_2 + ar_1ar_2}{ap_3ap_1 + ap_3ar_2 + ap_1ap_2} \\
 Y_{41} &= \frac{a\varphi ap_1 + a\varphi ar_2 + ar_1ar_2}{bp_3bp_1 + bp_3br_2 + bp_1bp_2}
 \end{aligned} \tag{38}$$

$$X_1 = 1$$

Another solution set is,

$$\begin{aligned}
 Y_{12} &= ((a\varphi ap_2 - ar_1 + ar_1 ap_2 + ar_1 ap_3)k_1^2 + k_1 ar_1)/(1 \\
 &\quad + (1 - ar_2 - ap_2 + ap_2 ap_1 - ap_1 - ap_3 + ap_3 ar_2 + ap_3 ap_1)k_1^2 \\
 &\quad + (-2 + ar_2 + ap_1 + ap_3 + ap_2)k_1)
 \end{aligned} \tag{39}$$

$$\begin{aligned}
Y_{22} = & ((b\phi bp_2 - br_1 + br_1 bp_2 + br_1 bp_3)k_2^2 + k_2 br_1)/(1 \\
& + (1 - br_2 - bp_2 + bp_2 bp_1 - bp_1 - bp_3 + bp_3 br_2 + bp_3 bp_1)k_2^2 \\
& + (-2 + br_2 + bp_1 + bp_3 + bp_2)k_2)
\end{aligned}$$

$$\begin{aligned}
Y_{32} = & ((ar_2 a\phi + ar_2 ar_1 + ap_1 a\phi - a\phi)k_1^2 + k_1 a\phi)/(1 \\
& + (1 - ar_2 - ap_2 + ap_2 ap_1 - ap_1 - ap_3 + ap_3 ar_2 + ap_3 ap_1)k_1^2 \\
& + (-2 + ar_2 + ap_1 + ap_3 + ap_2)k_1)
\end{aligned}$$

$$\begin{aligned}
Y_{42} = & ((br_2 b\phi + br_2 br_1 + bp_1 b\phi - b\phi)k_2^2 + k_2 b\phi)/(1 \\
& + (1 - br_2 - bp_2 + bp_2 bp_1 - bp_1 - bp_3 + bp_3 br_2 + bp_3 bp_1)k_2^2 \\
& + (-2 + br_2 + bp_1 + bp_3 + bp_2)k_2)
\end{aligned}$$

$$X_2 = \frac{Y_{22} + Y_{42}}{Y_{12} + Y_{32}}$$

$$k_{12}$$

$$= \frac{\frac{1}{6}(36 BCE - 108 AE^2 - 8 C^3 + 12\sqrt{3}\sqrt{4 B^3 E - B^2 C^2 - 18 BCEA + 27 A^2 E^2 + 4 AC^3 E})}{E}$$

$$- \frac{\frac{2}{3}(3 BE - C^2)}{(36 BCE - 108 AE^2 - 8 C^3 + 12\sqrt{3}\sqrt{4 B^3 E - B^2 C^2 - 18 BCEA + 27 A^2 E^2 + 4 AC^3 E})^{\frac{1}{3}}}$$

$$- \frac{1 C}{3 E}$$

$$k_{22} = \frac{1}{k_{12}}$$

Explicit expressions for A, B, C , and E are given in Appendix I. The third solution set is,

$$\begin{aligned}
Y_{13} &= ((a\phi ap_2 - ar_1 + ar_1 ap_2 + ar_1 ap_3)k_2^2 + k_2 ar_1)/(1 \\
&\quad + (1 - ar_2 - ap_2 + ap_2 ap_1 - ap_1 - ap_3 + ap_3 ar_2 + ap_3 ap_1)k_2^2 \\
&\quad + (-2 + ar_2 + ap_1 + ap_3 + ap_2)k_2) \\
Y_{23} &= ((b\phi bp_2 - br_1 + br_1 bp_2 + br_1 bp_3)k_1^2 + k_1 br_1)/(1 \\
&\quad + (1 - br_2 - bp_2 + bp_2 bp_1 - bp_1 - bp_3 + bp_3 br_2 + bp_3 bp_1)k_1^2 \\
&\quad + (-2 + br_2 + bp_1 + bp_3 + bp_2)k_1) \\
Y_{33} &= ((ar_2 a\phi + ar_2 ar_1 + ap_1 a\phi - a\phi)k_2^2 + k_2 a\phi)/(1 \\
&\quad + (1 - ar_2 - ap_2 + ap_2 ap_1 - ap_1 - ap_3 + ap_3 ar_2 + ap_3 ap_1)k_2^2 \\
&\quad + (-2 + ar_2 + ap_1 + ap_3 + ap_2)k_2) \tag{40}
\end{aligned}$$

$$\begin{aligned}
Y_{43} &= ((br_2 b\phi + br_2 br_1 + bp_1 b\phi - b\phi)k_1^2 + k_1 b\phi)/(1 \\
&\quad + (1 - br_2 - bp_2 + bp_2 bp_1 - bp_1 - bp_3 + bp_3 br_2 + bp_3 bp_1)k_1^2 \\
&\quad + (-2 + br_2 + bp_1 + bp_3 + bp_2)k_1)
\end{aligned}$$

$$X_3 = \frac{Y_{23} + Y_{43}}{Y_{13} + Y_{33}}$$

$$k_{13} = k_{22}$$

$$k_{23} = k_{12}$$

Finally the fourth solution set is,

$$Y_{14} = \left(\frac{x_1}{x_1 + x_2} \right) \left(\frac{r_1 + r_2 - r_1 r_2 - r_1 p_2}{p_1 + p_2 - p_1 p_2 - p_1 r_2} \right)$$

$$Y_{24} = \left(\frac{y_1}{y_1 + y_2} \right) \left(\frac{r_1 + r_2 - r_1 r_2 - p_1 r_2}{p_1 + p_2 - p_1 p_2 - r_1 p_2} \right)$$

$$Y_{34} = \left(\frac{x_2}{x_1 + x_2} \right) \left(\frac{r_1 + r_2 - r_1 r_2 - r_1 p_2}{p_1 + p_2 - p_1 p_2 - p_1 r_2} \right)$$

(41)

$$Y_{43} = \left(\frac{y_2}{y_1 + y_2} \right) \left(\frac{r_1 + r_2 - r_1 r_2 - p_1 r_2}{p_1 + p_2 - p_1 p_2 - r_1 p_2} \right)$$

$$X_4 = \frac{Y_{24} + Y_{44}}{Y_{14} + Y_{34}}$$

where x_1 , x_2 , y_1 , and y_2 are as follows:

$$x_1 = a\varphi a p_2 + a p_3 a r_1 + a r_1 a p_2$$

$$x_2 = a r_1 a r_2 + a\varphi a p_1 + a\varphi a r_2$$

$$y_1 = b\varphi b p_2 + b p_3 b r_1 + b r_1 b p_2$$

$$y_2 = b r_1 b r_2 + b\varphi b p_1 + b\varphi b r_2$$

Now, we can write the complete form of the internal probabilities:

$$P(n, 0, 0) = \sum_{j=1}^4 C_j X_j^n \quad P(n, 2, 0) = \sum_{j=1}^4 C_j X_j^n Y_{3j} \quad P(n, 1, 2) = \sum_{j=1}^4 C_j X_j^n Y_{1j} Y_{4j}$$

$$P(n, 1, 0) = \sum_{j=1}^4 C_j X_j^n Y_{1j} \quad P(n, 0, 2) = \sum_{j=1}^4 C_j X_j^n Y_{4j} \quad P(n, 2, 1) = \sum_{j=1}^4 C_j X_j^n Y_{2j} Y_{3j}$$

$$P(n, 0, 1) = \sum_{j=1}^4 C_j X_j^n Y_{2j} \quad P(n, 1, 1) = \sum_{j=1}^4 C_j X_j^n Y_{1j} Y_{2j} \quad P(n, 2, 2) = \sum_{j=1}^4 C_j X_j^n Y_{3j} Y_{4j}$$

We also need to find the probabilities at the boundary which are of the form $P(n, \alpha_1, \alpha_2)$, where $n = 0, 1, N - 1$, or N .

5.2. Analysis of Boundary Equations

5.2.1. Transient States

Some of the boundary states are transient because they cannot be reached from other states, but may only be reached from other transient states. In the steady-state, transient states have zero probability. The states $(0,1,0)$ and $(0,2,0)$ are transient because they can only be reached from each other. The states $(0,1,1)$, $(0,1,2)$, $(0,2,1)$, and $(0,2,2)$ are transient because they can only be reached from each other. $(0,0,0)$ is transient because it can only be reached from itself, $(0,1,0)$, or $(0,2,0)$. The states $(1,1,0)$ and $(1,2,0)$ are transient because they can be reached only from $(0,0,0)$, $(0,1,0)$, or $(0,2,0)$. Similarly, $(N,0,0)$, $(N,0,1)$, $(N,0,2)$, $(N,1,1)$, $(N,1,2)$, $(N,2,1)$, $(N,2,2)$, $(N-1,0,1)$, and $(N-1,0,2)$ are transient.

In the following two subsections, the transition equations are written for the lower and upper boundary states.

5.2.2. Lower Boundary Equations for $n \leq 1$

$$\begin{aligned}
 P(0,0,1) = & (1 - ar_1 - a\varphi)(1 - br_2)P(0,0,1) + (1 - ar_1 - a\varphi)br_1P(1,0,0) \\
 & + (1 - ar_1 - a\varphi)(1 - br_2 - bp_1)P(1,0,1) + (1 - ar_1 - a\varphi)bp_2P(1,0,2) \\
 & + ap_1(1 - br_2 - bp_1)P(1,1,1) + ap_1bp_2P(1,1,2) \\
 & + ap_3(1 - br_2 - bp_1)P(1,2,1) + ap_3bp_2P(1,2,2)
 \end{aligned} \tag{42}$$

$$\begin{aligned}
P(0,0,2) &= (1 - ar_1 - a\varphi)br_2P(0,0,1) + (1 - ar_1 - a\varphi)P(0,0,2) \\
&\quad + (1 - ar_1 - a\varphi)b\varphi P(1,0,0) + (1 - ar_1 - a\varphi)br_2P(1,0,1) \\
&\quad + (1 - ar_1 - a\varphi)(1 - bp_2 - bp_3)P(1,0,2) + ap_1br_2P(1,1,1) + ap_1(1 \\
&\quad - bp_2 - bp_3)P(1,1,2) + ap_3br_2P(1,2,1) + ap_3(1 - bp_2 - bp_3)P(1,2,2)
\end{aligned} \tag{43}$$

$$\begin{aligned}
P(1,0,0) &= (1 - ar_1 - a\varphi)(1 - br_1 - b\varphi)P(1,0,0) + (1 - ar_1 - a\varphi)bp_1P(1,0,1) \\
&\quad + (1 - ar_1 - a\varphi)bp_3P(1,0,2) + ap_1bp_1P(1,1,1) + ap_1bp_3P(1,1,2) \\
&\quad + ap_3bp_1P(1,2,1) + ap_3bp_3P(1,2,2)
\end{aligned} \tag{44}$$

$$\begin{aligned}
P(1,0,1) &= (1 - ar_1 - a\varphi)br_1P(2,0,0) + (1 - ar_1 - a\varphi)(1 - br_2 - bp_1)P(2,0,1) \\
&\quad + (1 - ar_1 - a\varphi)bp_2P(2,0,2) + ap_1br_1P(2,1,0) \\
&\quad + ap_1(1 - br_2 - bp_1)P(2,1,1) + ap_1bp_2P(2,1,2) + ap_3br_1P(2,2,0) \\
&\quad + ap_3(1 - br_2 - bp_1)P(2,2,1) + ap_3bp_2P(2,2,2)
\end{aligned} \tag{45}$$

$$\begin{aligned}
P(1,0,2) &= (1 - ar_1 - a\varphi)b\varphi P(2,0,0) + (1 - ar_1 - a\varphi)br_2P(2,0,1) + (1 - ar_1 - a\varphi)(1 \\
&\quad - bp_2 - bp_3)P(2,0,2) + ap_1b\varphi P(2,1,0) + ap_1br_2P(2,1,1) + ap_1(1 - bp_2 \\
&\quad - bp_3)P(2,1,2) + ap_3b\varphi P(2,2,0) + ap_3br_2P(2,2,1) + ap_3(1 - bp_2 \\
&\quad - bp_3)P(2,2,2)
\end{aligned} \tag{46}$$

$$\begin{aligned}
P(1,1,1) &= ar_1(1 - br_2)P(0,0,1) + ar_1br_1P(1,0,0) + ar_1(1 - br_2 - bp_1)P(1,0,1) \\
&\quad + ar_1bp_2P(1,0,2) + (1 - ar_2 - ap_1)(1 - br_2 - bp_1)P(1,1,1) \\
&\quad + (1 - ar_2 - ap_1)bp_2P(1,1,2) + ap_2(1 - br_2 - bp_1)P(1,2,1) \\
&\quad + ap_2bp_2P(1,2,2)
\end{aligned} \tag{47}$$

$$\begin{aligned}
P(1,1,2) = & ar_1 br_2 P(0,0,1) + ar_1 P(0,0,2) + ar_1 b\varphi P(1,0,0) + ar_1 br_2 P(1,0,1) + ar_1(1 \\
& - bp_2 - bp_3)P(1,0,2) + (1 - ar_2 - ap_1)br_2 P(1,1,1) + (1 - ar_2 - ap_1)(1 \\
& - bp_2 - bp_3)P(1,1,2) + ap_2 br_2 P(1,2,1) + ap_2(1 - bp_2 - bp_3)P(1,2,2)
\end{aligned} \tag{48}$$

$$\begin{aligned}
P(1,2,1) = & a\varphi(1 - br_2)P(0,0,1) + a\varphi br_1 P(1,0,0) + a\varphi(1 - br_2 - bp_1)P(1,0,1) \\
& + a\varphi bp_2 P(1,0,2) + ar_2(1 - br_2 - bp_1)P(1,1,1) + ar_2 bp_2 P(1,1,2) \\
& + (1 - ap_2 - ap_3)(1 - br_2 - bp_1)P(1,2,1) + (1 - ap_2 \\
& - ap_3)bp_2 P(1,2,2)
\end{aligned} \tag{49}$$

$$\begin{aligned}
P(1,2,2) = & a\varphi br_2 P(0,0,1) + a\varphi P(0,0,2) + a\varphi b\varphi P(1,0,0) + a\varphi br_2 P(1,0,1) + a\varphi(1 - bp_2 \\
& - bp_3)P(1,0,2) + ar_2 br_2 P(1,1,1) + ar_2(1 - bp_2 - bp_3)P(1,1,2) \\
& + (1 - ap_2 - ap_3)br_2 P(1,2,1) + (1 - ap_2 - ap_3)(1 - bp_2 \\
& - bp_3)P(1,2,2)
\end{aligned} \tag{50}$$

$$\begin{aligned}
P(2,1,0) = & ar_1(1 - br_1 - b\varphi)P(1,0,0) + ar_1 bp_1 P(1,0,1) + ar_1 bp_3 P(1,0,2) \\
& + (1 - ar_2 - ap_1)bp_1 P(1,1,1) + (1 - ar_2 - ap_1)bp_3 P(1,1,2) \\
& + ap_2 bp_1 P(1,2,1) + ap_2 bp_3 P(1,2,2)
\end{aligned} \tag{51}$$

$$\begin{aligned}
P(2,2,0) = & a\varphi(1 - br_1 - b\varphi)P(1,0,0) + a\varphi bp_1 P(1,0,1) + a\varphi bp_3 P(1,0,2) \\
& + ar_2 bp_1 P(1,1,1) + ar_2 bp_3 P(1,1,2) + (1 - ap_2 - ap_3)bp_1 P(1,2,1) + (1 \\
& - ap_2 - ap_3)bp_3 P(1,2,2)
\end{aligned} \tag{52}$$

5.2.3. Upper Boundary Equations for $n \geq N - 1$

$$\begin{aligned}
P(N - 2, 0, 1) &= (1 - ar_1 - a\varphi)br_1P(N - 1, 0, 0) + ap_1br_1P(N - 1, 1, 0) \\
&\quad + ap_1(1 - br_2 - bp_1)P(N - 1, 1, 1) + ap_1bp_2P(N - 1, 1, 2) \\
&\quad + ap_3br_1P(N - 1, 2, 0) + ap_3(1 - br_2 - bp_1)P(N - 1, 2, 1) \\
&\quad + ap_3bp_2P(N - 1, 2, 2)
\end{aligned} \tag{53}$$

$$\begin{aligned}
P(N - 2, 0, 2) &= (1 - ar_1 - a\varphi)b\varphi P(N - 1, 0, 0) + ap_1b\varphi P(N - 1, 1, 0) \\
&\quad + ap_1br_2P(N - 1, 1, 1) + ap_1(1 - bp_2 - bp_3)P(N - 1, 1, 2) \\
&\quad + ap_3b\varphi P(N - 1, 2, 0) + ap_3br_2P(N - 1, 2, 1) + ap_3(1 - bp_2 \\
&\quad - bp_3)P(N - 1, 2, 2)
\end{aligned} \tag{54}$$

$$\begin{aligned}
P(N - 1, 0, 0) &= (1 - ar_1 - a\varphi)(1 - br_1 - b\varphi)P(N - 1, 0, 0) \\
&\quad + ap_1(1 - br_1 - b\varphi)P(N - 1, 1, 0) + ap_1bp_1P(N - 1, 1, 1) \\
&\quad + ap_1bp_3P(N - 1, 1, 2) + ap_3(1 - br_1 - b\varphi)P(N - 1, 2, 0) \\
&\quad + ap_3bp_1P(N - 1, 2, 1) + ap_3bp_3P(N - 1, 2, 2)
\end{aligned} \tag{55}$$

$$\begin{aligned}
P(N - 1, 1, 0) &= ar_1(1 - br_1 - b\varphi)P(N - 2, 0, 0) + ar_1bp_1P(N - 2, 0, 1) \\
&\quad + ar_1bp_3P(N - 2, 0, 2) + (1 - ar_2 - ap_1)(1 - br_1 - b\varphi)P(N - 2, 1, 0) \\
&\quad + (1 - ar_2 - ap_1)bp_1P(N - 2, 1, 1) + (1 - ar_2 - ap_1)bp_3P(N - 2, 1, 2) \\
&\quad + ap_2(1 - br_1 - b\varphi)P(N - 2, 2, 0) + ap_2bp_1P(N - 2, 2, 1) \\
&\quad + ap_2bp_3P(N - 2, 2, 2)
\end{aligned} \tag{56}$$

$$\begin{aligned}
P(N-1,1,1) &= ar_1 br_1 P(N-1,0,0) + (1-ar_2-ap_1)br_1 P(N-1,1,0) \\
&+ (1-ar_2-ap_1)(1-br_2-bp_1)P(N-1,1,1) \\
&+ (1-ar_2-ap_1)bp_2 P(N-1,1,2) + ap_2 br_1 P(N-1,2,0) \\
&+ ap_2(1-br_2-bp_1)P(N-1,2,1) + ap_2 bp_2 P(N-1,2,2) \\
&+ (1-ar_2)br_1 P(N,1,0)
\end{aligned} \tag{57}$$

$$\begin{aligned}
P(N-1,1,2) &= ar_1 b\varphi P(N-1,0,0) + (1-ar_2-ap_1)b\varphi P(N-1,1,0) \\
&+ (1-ar_2-ap_1)br_2 P(N-1,1,1) \\
&+ (1-ar_2-ap_1)(1-bp_2-bp_3)P(N-1,1,2) + ap_2 b\varphi P(N-1,2,0) \\
&+ ap_2 br_2 P(N-1,2,1) + ap_2(1-bp_2-bp_3)P(N-1,2,2) + (1 \\
&- ar_2)b\varphi P(N,1,0)
\end{aligned} \tag{58}$$

$$\begin{aligned}
P(N-1,2,0) &= a\varphi(1-br_1-b\varphi)P(N-2,0,0) + a\varphi bp_1 P(N-2,0,1) \\
&+ a\varphi bp_3 P(N-2,0,2) + ar_2(1-br_1-b\varphi)P(N-2,1,0) \\
&+ ar_2 bp_1 P(N-2,1,1) + ar_2 bp_3 P(N-2,1,2) + (1-ap_2 \\
&- ap_3)(1-br_1-b\varphi)P(N-2,2,0) + (1-ap_2-ap_3)bp_1 P(N-2,2,1) \\
&+ (1-ap_2-ap_3)bp_3 P(N-2,2,2)
\end{aligned} \tag{59}$$

$$\begin{aligned}
P(N-1,2,1) &= a\varphi br_1 P(N-1,0,0) + ar_2 br_1 P(N-1,1,0) \\
&+ ar_2(1-br_2-bp_1)P(N-1,1,1) + ar_2 bp_2 P(N-1,1,2) \\
&+ (1-ap_2-ap_3)br_1 P(N-1,2,0) \\
&+ (1-ap_2-ap_3)(1-br_2-bp_1)P(N-1,2,1) \\
&+ (1-ap_2-ap_3)bp_2 P(N-1,2,2) + ar_2 br_1 P(N,1,0) + br_1 P(N,2,0)
\end{aligned} \tag{60}$$

$$\begin{aligned}
P(N-1,2,2) &= a\varphi b\varphi P(N-1,0,0) + ar_2 b\varphi P(N-1,1,0) + ar_2 br_2 P(N-1,1,1) \\
&\quad + ar_2(1-bp_2-bp_3)P(N-1,1,2) + (1-ap_2-ap_3)b\varphi P(N-1,2,0) \\
&\quad + (1-ap_2-ap_3)br_2 P(N-1,2,1) \\
&\quad + (1-ap_2-ap_3)(1-bp_2-bp_3)P(N-1,2,2) + ar_2 b\varphi P(N,1,0) \\
&\quad + b\varphi P(N,2,0)
\end{aligned} \tag{61}$$

$$\begin{aligned}
P(N,1,0) &= ar_1(1-br_1-b\varphi)P(N-1,0,0) \\
&\quad + (1-ar_2-ap_1)(1-br_1-b\varphi)P(N-1,1,0) \\
&\quad + (1-ar_2-ap_1)bp_1 P(N-1,1,1) + (1-ar_2-ap_1)bp_3 P(N-1,1,2) \\
&\quad + ap_2(1-br_1-b\varphi)P(N-1,2,0) + ap_2 bp_1 P(N-1,2,1) \\
&\quad + ap_2 bp_3 P(N-1,2,2) + (1-ar_2)(1-br_1-b\varphi)P(N,1,0)
\end{aligned} \tag{62}$$

$$\begin{aligned}
P(N,2,0) &= a\varphi(1-br_1-b\varphi)P(N-1,0,0) + ar_2(1-br_1-b\varphi)P(N-1,1,0) \\
&\quad + ar_2 bp_1 P(N-1,1,1) + ar_2 bp_3 P(N-1,1,2) \\
&\quad + (1-ap_2-ap_3)(1-br_1-b\varphi)P(N-1,2,0) + (1-ap_2 \\
&\quad - ap_3)bp_1 P(N-1,2,1) + (1-ap_2-ap_3)bp_3 P(N-1,2,2) \\
&\quad + ar_2(1-br_1-b\varphi)P(N,1,0) + (1-br_1-b\varphi)P(N,2,0)
\end{aligned} \tag{63}$$

5.2.4. Solution of the Boundary Equations

Let's start with solving the lower boundary equations. If we sum up the equations (42) to (52) excluding (45) and (46), we find:

$$P(2,1,0) + P(2,2,0) = P(1,0,1) + P(1,0,2) \tag{64}$$

From equations (45) and (46), we see that $P(1,0,1)$ and $P(1,0,2)$ can be written in the internal form. Then,

$$P(1,0,1) = \sum_{j=1}^4 C_j X_j Y_{2j}$$

$$p(1,0,2) = \sum_{j=1}^4 C_j X_j Y_{4j}$$

When these results are written in Equation (64), it will be,

$$\sum_j C_j X_j (X_j (Y_{1j} + Y_{3j}) - (Y_{2j} + Y_{4j})) = 0.$$

The first solution set for the internal equations does not satisfy this equation; therefore, C_1 equals 0. The remaining lower boundary probabilities we need to find are $P(0,0,1)$, $P(0,0,2)$, $P(1,0,0)$, $P(1,1,1)$, $P(1,1,2)$, $P(1,2,1)$, and $P(1,2,2)$.

Let's start with summing up equations (42) and (43):

$$\begin{aligned} & (ar_1 + a\varphi)(P(0,0,1) + P(0,0,2)) \\ &= (1 - ar_1 - a\varphi)(br_1 + b\varphi)P(1,0,0) + (1 - ar_1 - a\varphi)(1 - bp_1)P(1,0,1) \\ &+ (1 - ar_1 - a\varphi)(1 - bp_3)P(1,0,2) + ap_1(1 - bp_1)P(1,1,1) + ap_1(1 - bp_3)P(1,1,2) \\ &+ ap_3(1 - bp_1)P(1,2,1) + ap_3(1 - bp_3)P(1,2,2) \end{aligned} \quad (65)$$

Summation of (47), (48), (49), and (50) equals,

$$\begin{aligned} & P(1,1,1) + P(1,1,2) + P(1,2,1) + P(1,2,2) \\ &= (ar_1 + a\varphi)((P(0,0,1) + P(0,0,2)) + (ar_1 + a\varphi)(br_1 + b\varphi)P(1,0,0) \\ &+ (ar_1 + a\varphi)(1 - bp_1)P(1,0,1) + (ar_1 + a\varphi)(1 - bp_3)P(1,0,2) \\ &+ (1 - ap_1)(1 - bp_1)P(1,1,1) + (1 - ap_1)(1 - bp_3)P(1,1,2) \\ &+ (1 - ap_3)(1 - bp_1)P(1,2,1) + (1 - ap_3)(1 - bp_3)P(1,2,2) \end{aligned}$$

After plugging (65) into the above equality, we get

$$\begin{aligned} bp_1P(1,1,1) + bp_3P(1,1,2) + bp_1P(1,2,1) + bp_3P(1,2,2) \\ = (br_1 + b\varphi)P(1,0,0) + (1 - bp_1)P(1,0,1) + (1 - bp_3)P(1,0,2) \end{aligned} \quad (66)$$

If we decompose (66), we can write,

$$bp_1P(1,1,1) = \frac{x_1}{x_1 + x_2} (br_1P(1,0,0) + (1 - bp_1)P(1,0,1)) \quad (67)$$

$$bp_3P(1,1,2) = \frac{x_1}{x_1 + x_2} (b\varphi P(1,0,0) + (1 - bp_3)P(1,0,2)) \quad (68)$$

$$bp_1P(1,2,1) = \frac{x_2}{x_1 + x_2} (br_1P(1,0,0) + (1 - bp_1)P(1,0,1)) \quad (69)$$

$$bp_3P(1,2,2) = \frac{x_2}{x_1 + x_2} (b\varphi P(1,0,0) + (1 - bp_3)P(1,0,2)) \quad (70)$$

We can write equation (44) as,

$$\begin{aligned} (ar_1 + a\varphi + br_1 + b\varphi - (ar_1 + a\varphi)(br_1 + b\varphi))P(1,0,0) \\ = (1 - ar_1 - a\varphi)(bp_1P(1,0,1) + bp_3P(1,0,2)) + ap_1(bp_1P(1,1,1) \\ + bp_3P(1,1,2)) + ap_3(bp_1P(1,2,1) + bp_3P(1,2,2)) \end{aligned} \quad (71)$$

Plugging (67)-(70) into (71) leads to,

$$\begin{aligned}
P(1,0,0) = & \left((bp_1a\varphi + bp_1ar_1 + (ap_1 - 1)bp_1 - ap_1)x_1 \right. \\
& + (bp_1a\varphi + bp_1ar_1 + (-1 + ap_3)bp_1 - ap_3)x_2)P(1,0,1) \\
& + P(1,0,2)((bp_3a\varphi + bp_3ar_1 + (ap_1 - 1)bp_3 - ap_1)x_1 \\
& \left. + (bp_3a\varphi + bp_3ar_1 + (-1 + ap_3)bp_3 - ap_3)x_2) \right) \\
& / \left(((-1 + br_1 + b\varphi)a\varphi + (-1 + br_1 + b\varphi)ar_1 + (br_1 + b\varphi)(ap_1 - 1))x_1 \right. \\
& + x_2((-1 + br_1 + b\varphi)a\varphi + (-1 + br_1 + b\varphi)ar_1 \\
& \left. + (br_1 + b\varphi)(-1 + ap_3)) \right)
\end{aligned}$$

Using the values for $P(1,0,0)$, $P(1,1,1)$, $P(1,1,2)$, $P(1,2,1)$, and $P(1,2,2)$, we can easily write expressions for $P(0,0,1)$ and $P(0,0,2)$. Solution of lower boundary equations is complete.

Now, we will solve the upper boundary equations. From equations (56) and (59), we see that $P(N - 1,1,0)$ and $P(N - 1,2,0)$ are of internal form. Then,

$$P(N - 1,1,0) = \sum_{j=1}^4 C_j X_j^{N-1} Y_{1j}$$

$$P(N - 1,2,0) = \sum_{j=1}^4 C_j X_j^{N-1} Y_{3j}$$

The remaining upper boundary probabilities we need to find are $(N - 1,1,0)$, $P(N - 1,2,0)$, $P(N - 1,0,0)$, $P(N - 1,1,1)$, $P(N - 1,1,2)$, $P(N - 1,2,1)$, and $P(N - 1,2,2)$.

If we sum up equations (62) and (63), we get

$$\begin{aligned}
& (br_1 + b\varphi)(P(N, 1,0) + P(N, 2,0)) \\
&= (ar_1 + a\varphi)(1 - br_1 - b\varphi)P(N - 1,0,0) \\
&+ (1 - ap_1)(1 - br_1 - b\varphi)P(N - 1,1,0) + (1 - ap_1)bp_1P(N - 1,1,1) \\
&+ (1 - ap_1)bp_3P(N - 1,1,2) + (1 - ap_3)(1 - br_1 - b\varphi)P(N - 1,2,0) \\
&+ (1 - ap_3)bp_1P(N - 1,2,1) + (1 - ap_3)bp_3P(N - 1,2,2)
\end{aligned} \tag{72}$$

Addition of equations (57), (58), (60), and (61) makes

$$\begin{aligned}
P(N - 1,1,1) &= ar_1br_1P(N - 1,0,0) + (1 - ar_2 - ap_1)br_1P(N - 1,1,0) \\
&+ (1 - ar_2 - ap_1)(1 - br_2 - bp_1)P(N - 1,1,1) \\
&+ (1 - ar_2 - ap_1)bp_2P(N - 1,1,2) + ap_2br_1P(N - 1,2,0) \\
&+ ap_2(1 - br_2 - bp_1)P(N - 1,2,1) + ap_2bp_2P(N - 1,2,2) \\
&+ (1 - ar_2)br_1P(N, 1,0)
\end{aligned}$$

After plugging equation (72), we get

$$\begin{aligned}
& ap_1P(N - 1,1,1) + ap_3P(N - 1,2,1) + ap_1P(N - 1,1,2) + ap_3P(N - 1,2,2) \\
&= (ar_1 + a\varphi)P(N - 1,0,0) + (1 - ap_1)P(N - 1,1,0) + (1 \\
&- ap_3)P(N - 1,2,0)
\end{aligned} \tag{73}$$

If we decompose (73), we can write,

$$ap_1P(N - 1,1,1) = \frac{y_1}{y_1 + y_2} (ar_1P(N - 1,0,0) + (1 - ap_1)P(N - 1,1,0)) \tag{74}$$

$$ap_1P(N - 1,1,2) = \frac{y_2}{y_1 + y_2} (ar_1P(N - 1,0,0) + (1 - ap_1)P(N - 1,1,0)) \tag{75}$$

$$bp_3P(N - 1,2,1) = \frac{y_1}{y_1 + y_2} (a\varphi P(N - 1,0,0) + (1 - ap_3)P(N - 1,2,0)) \tag{76}$$

$$bp_3P(N-1,2,2) = \frac{y_2}{y_1 + y_2} (a\varphi P(N-1,0,0) + (1 - ap_3)P(N-1,2,0)) \quad (77)$$

Equation (55) can be written as,

$$\begin{aligned} & (ar_1 + a\varphi + br_1 + b\varphi - (ar_1 + a\varphi)(br_1 + b\varphi))P(N-1,0,0) \\ & = (1 - br_1 - b\varphi)(ap_1P(N-1,1,0) + ap_3P(N-1,2,0)) \\ & + bp_1(ap_1P(N-1,1,1) + ap_3P(N-1,2,1)) + bp_3(ap_1P(N-1,1,2) \\ & + ap_3P(N-1,2,2)) \end{aligned} \quad (78)$$

Using the equations (74)-(77), we can reformulate the equation (78) as,

$$\begin{aligned} P(N-1,0,0) = & \left((b\varphi ap_1 + br_1 ap_1 + (-1 + bp_1)ap_1 - bp_1)y_1 \right. \\ & + y_2(b\varphi ap_1 + br_1 ap_1 + (-1 + bp_3)ap_1 - bp_3))P(N,1,0) \\ & + P(N,2,0) \left((-bp_1 + bp_1 bp_3 - ap_3 + br_1 ap_3 + b\varphi ap_3)y_1 \right. \\ & \left. \left. + y_2(bp_3^2 - bp_3 + br_1 ap_3 - ap_3 + b\varphi ap_3) \right) \right) \\ & / \left(((ar_1 + a\varphi - 1)b\varphi + (ar_1 + a\varphi - 1)br_1 + (-1 + bp_1)(ar_1 + a\varphi))y_1 \right. \\ & \left. + ((ar_1 + a\varphi - 1)b\varphi + (ar_1 + a\varphi - 1)br_1 + (-1 + bp_3)(ar_1 + a\varphi))y_2 \right) \end{aligned}$$

Finally, using the values for $P(N-1,0,0)$, $P(N-1,1,1)$, $P(N-1,1,2)$, $P(N-1,2,1)$, and $P(N-1,2,2)$, we can easily write expressions for $P(N,1,0)$ and $P(N,2,0)$.

As stated previously, the internal and the boundary probabilities are linear combination of ℓ vectors and in the form of $\sum_{j=1}^{\ell} C_j \xi_j(n, \alpha_1, \alpha_2)$. We have found

expressions for all states. These expressions must satisfy all the transition equations. Some of equations are automatically satisfied, but some are not. These errors will be eliminated with the choice of coefficient C_j s. We have found that $C_1 = 0$. We need three equations of C_j s to find their values. One equation we can use is the normalization equation (80), which requires that the sum of all steady-state probabilities must equal to 1.

$$\sum_{n=0}^N \sum_{\alpha_1=0}^2 \sum_{\alpha_2=0}^2 P(n, \alpha_1, \alpha_2) = 1 \quad (79)$$

We also obtain the equations (80) and (81) by substituting the boundary probabilities into equations (51), (52), (53) and (54).

$$\begin{aligned} & \sum_{j=2}^4 C_j X_j^2 Y_{1j} + \sum_{j=2}^4 C_j X_j^2 Y_{3j} \\ &= (ar_1 + a\varphi)(1 - br_1 - b\varphi)P(1,0,0) + (ar_1 + a\varphi)bp_1 \sum_{j=2}^4 C_j X_j Y_{2j} \\ &+ (ar_1 + a\varphi)bp_3 \sum_{j=2}^4 C_j X_j Y_{4j} + (1 - ap_1)bp_1P(1,1,1) \\ &+ (1 - ap_1)bp_3P(1,1,2) + (1 - ap_3)bp_1P(1,2,1) + (1 - ap_3)bp_3P(1,2,2) \end{aligned} \quad (80)$$

$$\begin{aligned}
& \sum_{j=2}^4 C_j X_j^{N-2} Y_{2j} + \sum_{j=2}^4 C_j X_j^{N-2} Y_{4j} \\
&= (1 - ar_1 - a\varphi)(br_1 + b\varphi)P(N - 1,0,0) + ap_1(br_1 + b\varphi) \sum_{j=2}^4 C_j X_j^{N-1} Y_{1j} \\
&+ ap_1(1 - bp_1)P(N - 1,1,1) + ap_1(1 - bp_3)P(N - 1,1,2) + ap_3(br_1 \\
&+ b\varphi) \sum_{j=2}^4 C_j X_j^{N-1} Y_{3j} + ap_3(1 - bp_1)P(N - 1,2,1) \\
&+ ap_3(1 - bp_3)P(N - 1,2,2)
\end{aligned} \tag{81}$$

By solving this linear system of equations in (79)-(81), we can find the values for C_j s. Finally, we can calculate the steady-state probabilities and the performance measures.

6. Experimental Study

We have performed two experiments to demonstrate that the modeling of degradation, imperfect repair and preventive maintenance leads to better evaluation of the throughput of the two-machine production lines. In Experiment 1, we compare our throughput results (E) to the one described in Gershwin (1994) for deterministic two machine lines (E_{eqv}) using equivalent repair and failure probabilities that are obtained in equations (6), (7) (8), and (9). With the equivalent failure and repair probabilities, the different operational states of the machines can be represented with a single operational state. In this case, the isolated efficiencies are also preserved.

We have used two sets of cases which are given in Table 1 and Table 2. The “%Error” column shows the error introduced by using equivalent parameters. The

percentage error values are higher in the cases given in Table 2. These errors are due to wrong variances.

Table 1 : Experiment 1 with First Set of Cases

Cases	ar_1	ar_2	$a\phi$	ap_1	ap_2	ap_3	N	E	E_{eqv}	%Error
1	0.3	0.1	0.2	0.03	0.1	0.05	4	0.8906	0.8904	0.023
2	0.3	0.1	0.2	0.03	0.1	0.05	5	0.8965	0.8965	-0.003
3	0.3	0.1	0.2	0.03	0.1	0.05	10	0.9102	0.9105	-0.038
4	0.3	0.1	0.2	0.08	0.1	0.05	4	0.8330	0.8329	0.009
5	0.3	0.1	0.2	0.08	0.1	0.05	5	0.8415	0.8417	-0.028
6	0.3	0.1	0.2	0.08	0.1	0.05	10	0.8611	0.8615	-0.052
7	0.3	0.1	0.2	0.03	0.06	0.05	4	0.8863	0.886	0.035
8	0.3	0.1	0.2	0.03	0.06	0.05	5	0.8923	0.8924	-0.008
9	0.3	0.1	0.2	0.03	0.06	0.05	10	0.9064	0.9068	-0.042

Table 2 : Experiment 1 with Second Set of Cases

Cases	ar_1	ar_2	$a\phi$	ap_1	ap_2	ap_3	N	E	E_{eqv}	%Error
10	0.2	0.005	0.05	0.1	0.05	0.005	4	0.6861	0.6774	1.272
11	0.2	0.005	0.05	0.1	0.05	0.005	5	0.6918	0.6882	0.526
12	0.2	0.005	0.05	0.1	0.05	0.005	10	0.7278	0.7201	1.063
13	0.2	0.005	0.05	0.1	0.05	0.005	20	0.7296	0.7451	-2.131
14	0.05	0.005	0.2	0.1	0.05	0.005	4	0.7921	0.8127	-1.279
15	0.05	0.005	0.2	0.1	0.05	0.005	5	0.7944	0.8318	-2.332
16	0.05	0.005	0.2	0.1	0.05	0.005	10	0.8024	0.7803	1.493
17	0.05	0.005	0.2	0.1	0.05	0.005	20	0.8128	0.7885	0.738

Experiment 2 tests the impact of ignoring the fact of the availability of one of the operational states. In the experiment, the second state of the machines is ignored and only ar_1, ap_1, br_1, bp_1 and N parameters are used to calculate the throughput, E' . Note that we use all parameters to calculate E . As seen in Table 3, higher errors are introduced when the impact of degradation, preventive maintenance, and perfect repair are ignored.

Table 3 Experiment 2 with First Set of Cases

Cases	ar_1	ar_2	$a\phi$	ap_1	ap_2	ap_3	N	E	E'	%Error
1	0.3	0.1	0.2	0.03	0.1	0.05	4	0.8906	0.8541	4.10
2	0.3	0.1	0.2	0.03	0.1	0.05	5	0.8965	0.8605	4.01
3	0.3	0.1	0.2	0.03	0.1	0.05	10	0.9102	0.8784	3.49
4	0.3	0.1	0.2	0.08	0.1	0.05	4	0.8330	0.6933	16.77
5	0.3	0.1	0.2	0.08	0.1	0.05	5	0.8415	0.7048	16.24
6	0.3	0.1	0.2	0.08	0.1	0.05	10	0.8611	0.7365	14.46
7	0.3	0.1	0.2	0.03	0.06	0.05	4	0.8863	0.8541	3.63
8	0.3	0.1	0.2	0.03	0.06	0.05	5	0.8923	0.8605	3.57
9	0.3	0.1	0.2	0.03	0.06	0.05	10	0.9064	0.8784	3.09

Our model behaves in the experiments the following way: When buffer size, N increases, the throughput increases. The throughput also increases in increasing repair probability and decreasing failure probability. In the Cases 10-17, the perfect and imperfect repair probabilities are interchanged. According to these cases, when the machines are in state 2, the failures are less frequent. The results showed that making perfect repair increases the throughput of the system. The model behaves consistent with intuition in the experiments.

7. Conclusions

We proposed an analytical model to analyze the performance of an identically deteriorating two-machine system. The model gives exact results for the throughput of the system. The experiments showed that the results are consistent with intuition.

We compared our results with those models proposed in literature which does not model the degradation, imperfect repair and preventive maintenance. The comparative results demonstrate that neglecting the degradation and imperfect repairs introduces significant throughput estimation errors. We also showed that

calculating the throughput with equivalent reliability parameters is not as accurate as studying the machine health states explicitly.

As future research, a model that studies non-identically deteriorating two machine systems is recommended. The method can be used as a building block for the analysis of longer lines.

CHAPTER IV: A HYBRID AGGREGATION-DECOMPOSITION ALGORITHM FOR PERFORMANCE EVALUATION OF UNRELIABLE PRODUCTION LINES WITH FINITE BUFFERS

Abstract – Aggregation and decomposition methods have been proposed in the literature for modeling throughput of production lines. In an attempt to improve the computational efficiency of the decomposition method, we offer a hybrid method that selectively aggregates parts of the production line based on the locations of bottleneck machines. The performance of the method is compared with the existing aggregation and decomposition methods. The results show that the hybrid approach provides very promising solutions for the throughput analysis of long lines.

1. Introduction

Production lines are of great economic importance in the mass production environments. Companies with these types of manufacturing systems, in particular automotive companies, put great emphasis on having high production rates to stay competitive in today's global market. In order to improve the throughput, accurate throughput estimates are needed. Due to unreliable machines, finite buffers, varying processing times, etc. the throughput prediction is difficult. A common approach is to either develop simulation models or resort to analytical models. Whereas a more detailed and realistic analysis can be done with simulation models, it can be time-consuming. Analytical models, while more efficient, are subject to errors due to the

simplifying assumptions. Due to the large state space, exact analytical models are only available for two-machine or three-machine systems. Instead, approximate analytical methods such as aggregation or decomposition methods are proposed for the analysis of longer lines or more complex production systems. The exact analytical model for the two-machine lines constitutes the building block for these approximate models.

In the paper, we offer a hybrid aggregation-decomposition algorithm for throughput prediction of a k -machine production line as shown in Figure 1. The algorithm selectively aggregates parts of the line based on the location of the bottlenecks, which are the best estimators of the throughput (Bukchin, 1998). In our model, we employ the aggregation method of Terracol and David (1987) and the decomposition method of Burman (1995) which is the continuous model extension of the Dallery-David-Xie (DDX). The basic idea of hybridizing these two throughput evaluation approaches is to simultaneously benefit from the speed of the aggregation method and the accuracy of the decomposition method.

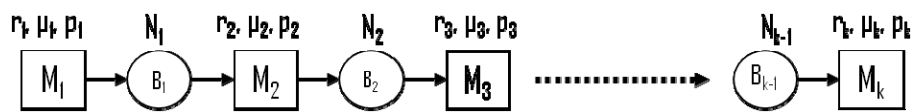

Figure 1 : k -Machine Production Line

In general, the execution of the decomposition methods is as follows: The original production line is broken down into $k - 1$ two-machine line segments as illustrated in Figure 2. The buffer in *Line i* shows the same behavior as the original line buffers and the pseudo-machines of *Line i* show the aggregate behavior of the line upstream (subscript u) and the line downstream (subscript d) of the buffer, B_i .

The pseudo-machines of *Line i* are characterized by 6 unknown parameters $(\mu_u(i), r_u(i), p_u(i), \mu_d(i), r_d(i), p_d(i))$. Therefore, the connection between the subsystems can be established through $6(k - 1)$ equations.

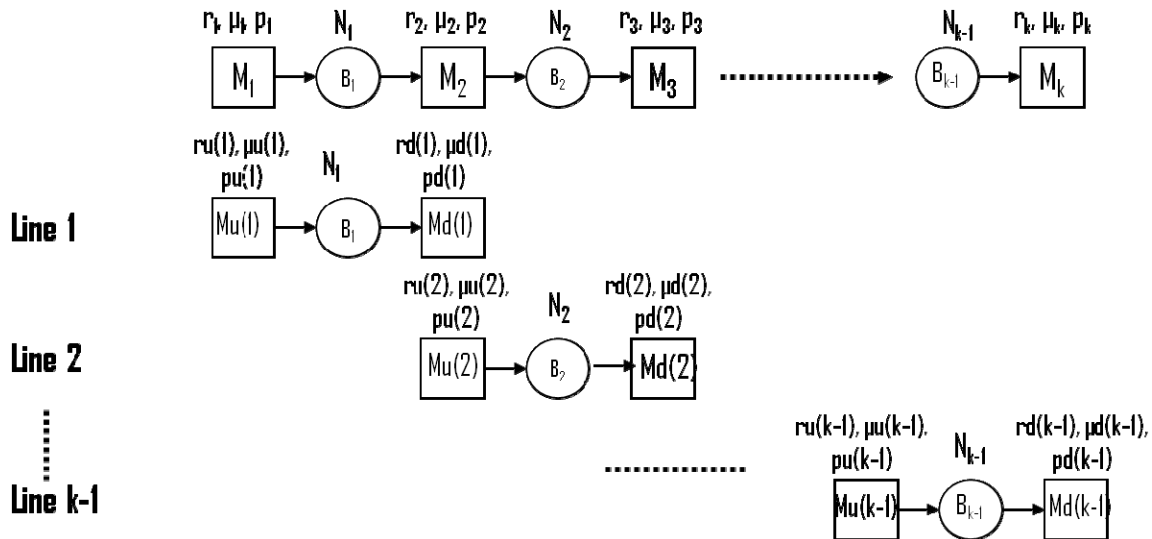

Figure 2 : Decomposition of a k-Machine Line

The aggregation methods, beginning with from the first or the last machine, replace a buffer and two machines of the *k*-machine line with a single equivalent machine, and this is done repeatedly until a single equivalent machine is left (See Figure 3). The remaining single equivalent machine has the same up and down times and processing rate of the production line. The details of the aggregation and decomposition methods are given in Section 5 for non-bottleneck machines.

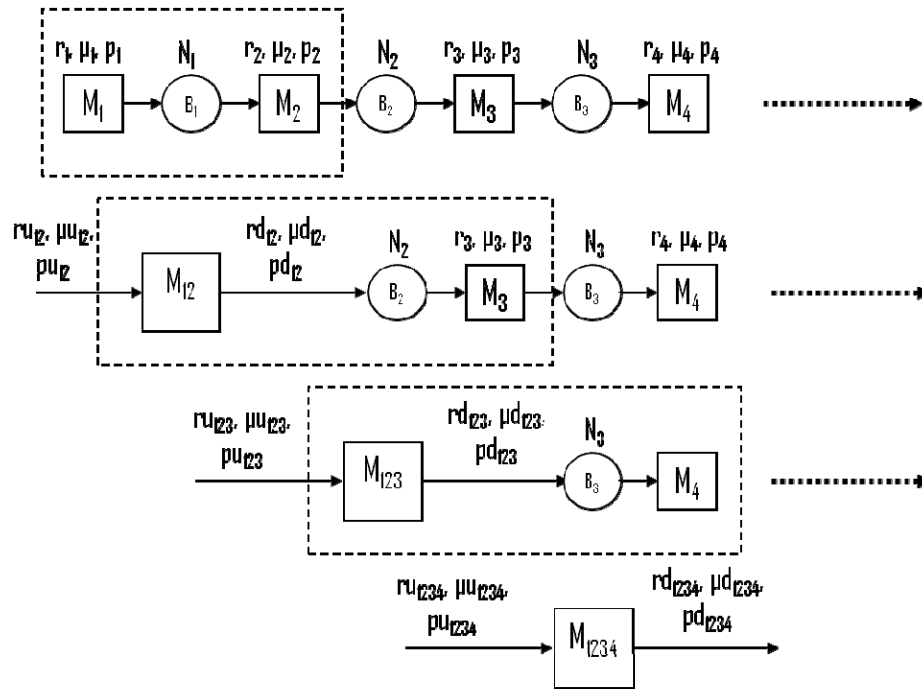

Figure 3 : Aggregation of a k-Machine Line

The remainder of the paper is structured as follows: Section 2 describes the related literature which includes only analytical models of production lines. In Section 3, we introduce our model and the modeling assumptions. Section 4 presents performance measures of the model. In Section 5, we define our solution approach. The experimental results are shown in Section 6. Finally, we conclude the study and propose directions for future research in Section 7.

2. Literature Review

Performance evaluation of production systems has been studied over the last 50 years (See the bibliography by Perros, 1983; literature reviews by Dallery and Gershwin, 1992; Papadopoulos and Heavey, 1996; Govil and Fu, 1999, Li et al.,

2009, Bergeron et al., 2010; and the monographs by Buzacott and Shantikumar, 1993; Gershwin, 1994; Altioik, 1997).

Aggregation and decomposition methods have been used in the literature to approximately model the throughput of production lines. The principles of decomposition were established by Zimmern (1956) and Sevastyanov (1962). While Sevastyanov (1962) analyzes the continuous material systems, Zimmern (1956) analyzes the discrete material systems with the continuous material assumption. Alvarez-Vargas et al. (1994) explains in what cases the continuous flow model is a good approximation. In another study from Suri and Fu (1994), the advantages of using a continuous flow model for discrete flow systems are explained.

The papers which use decomposition technique to approximate k-machine production lines are Buzacott (1967), Gershwin (1987), Dallery, David, and Xie (1988), Choong and Gershwin (1987), Hong, Glassey, and Seong (1992), and Burman (1995). Gershwin (1987) proposed a deterministic processing time model for production lines with unreliable machines and finite buffers. He used geometric distribution for failure and repair probabilities. Soon after this study, Dallery, David, and Xie (1988) provided a more robust and efficient algorithm (called DDX algorithm). Choong and Gershwin (1987) analyzed production lines with unreliable machines, random processing times, and finite buffers. They used exponential processing, failure, and repair rates. Hong, Glassey, and Seong (1992) offered a simpler and more efficient method using a continuous material flow model for a system that is analyzed in Choong and Gershwin (1987). Finally, Burman (1995) extended the DDX

algorithm to a continuous flow model and developed an accelerated version of the DDX algorithm (ADDX), which converges in most of the cases tested.

Aggregation methods are mainly used to study more complex systems. De Koster (1988), Terracol and David (1987), Lim et al. (1990), and Chiang et al. (2000) are some of the authors who analyzed the production lines using this technique. Previous studies using this technique used forward, backward, or hybrid aggregation methods in order to approximate the throughput of the line, which is similar to a one-step decomposition method. Lim et al. (1990) and Chiang et al. (2000) improved the accuracy of the method with iterative backward and forward aggregation steps.

3. Model Description and Assumptions

We consider a serial production line as shown in Figure 1. The line consists of k machines (M_1, M_2, \dots, M_k) and $k - 1$ buffers (B_1, B_2, \dots, B_{k-1}). A part enters from outside the system to M_1 and it moves to B_1 after it is processed, then it enters M_2 and it moves to B_2 after it is processed, and so forth until it exits the system after being processed in M_k .

Machines can be in two states: up or down. When a machine is up and not starved or blocked, it either processes a part with a probability of $\mu_i \delta t$, or it may fail with a probability of $p_i \delta t$ during the time interval $(t, t + \delta t)$, where δt is an infinitesimal duration. When it fails, it has a probability of $r_i \delta t$ of getting repaired during the time interval $(t, t + \delta t)$. The parts are modeled as continuous fluids; therefore, the machine's processing rate and failure rate behaves differently when it is blocked or starved. The buffer level, x_i , is continuous and can take any value from 0 to N_i .

A parameter α_i can be used to define the states of Machine $i = 1, 2, \dots, k$.

$$\alpha_i = \begin{cases} 1 & \text{operational} \\ 0 & \text{under repair} \end{cases}$$

The state of the system can be represented by the instantaneous buffer levels and the states of machines, e.g., $(x_1, x_2, \dots, x_{k-1}, \alpha_1, \alpha_2, \dots, \alpha_k)$. In a two-machine line, given that x is continuous, the probability can be defined with mass functions for the boundary states, $P(x, \alpha_1, \alpha_2)$ and density functions for the internal states, $f(x, \alpha_1, \alpha_2)$. The model is based on the following assumptions:

- Discrete parts are produced in the system.
- The isolated service times, $1/\mu_i$ are deterministic and non-homogeneous. In other words, the isolated processing rates are constant, but differ from machine to machine.
- If $\mu_i < \mu_{i+1}$ and B_i is empty, both machines operate at a rate of μ_i . Similarly, if $\mu_i > \mu_{i+1}$ and B_i is full, both machines operate at a rate of μ_{i+1} .
- The failure rate, p_i and repair rate, r_i of each machine are exponentially distributed. If $\mu_i < \mu_{i+1}$ and B_i is empty, the failure rates for M_i and M_{i+1} become p_i and $\left(\frac{\mu_i}{\mu_{i+1}}\right)p_{i+1}$, respectively. If $\mu_i > \mu_{i+1}$ and B_i is full, the failure rates for M_i and M_{i+1} become $\left(\frac{\mu_{i+1}}{\mu_i}\right)p_i$ and p_{i+1} , respectively.
- The buffers are finite.
- Machine, M_i is blocked when the buffer, B_i is full and it is starved when the buffer, B_{i-1} is empty.
- First machine is never starved and last machine is never blocked.
- Failures are operation-dependent, e.g., the machines do not fail when they are starved or blocked.

- No part is created or destroyed during the processing.
- Buffers are reliable and part transfer times are negligible.
- The analysis is done under steady-state.

4. Performance Measures

The most important performance measures of the production lines are the efficiency, the production rate and the average buffer levels. To calculate them, we need to calculate the isolated efficiency and the steady-state probabilities for idleness. The isolated efficiency for M_i is the fraction of time it is operational and can be calculated from,

$$e_i = \frac{r_i}{r_i + p_i}$$

The isolated production rate for M_i is the production rate of M_i when it is in isolation and not be impeded by other machines. It can be shown as,

$$\rho_i = \mu_i e_i$$

The efficiency, E_i is the probability that M_i processes a part. It can be calculated using,

$$E_i = e_i(1 - P_s - P_b)$$

where P_b and P_s are the probability of blocking and the probability of starving, respectively. Gershwin (1994) defines these probabilities as follows:

$$P_b = P(N, 1, 0) + \left(1 - \frac{\mu_2}{\mu_1}\right) P(N, 1, 1). \text{ If } \mu_2 > \mu_1, P(N, 1, 1) = 0$$

$$P_s = P(0, 0, 1) + \left(1 - \frac{\mu_1}{\mu_2}\right) P(0, 1, 1). \text{ If } \mu_1 > \mu_2, P(0, 1, 1) = 0$$

The production rate, P_i is the parts produced per unit time by machine M_i and it equals,

$$P_i = \rho_i(1 - P_s - P_b)$$

Finally the average level of the buffer B_i is,

$$\bar{x}_i = \sum_{\alpha_2=0}^1 \sum_{\alpha_1=0}^1 \left[\int_0^N x_i f(x_i, \alpha_1, \alpha_2) dx_i + N_i P(N_i, \alpha_1, \alpha_2) \right]$$

5. Hybrid Aggregation-Decomposition Method

Derivation of exact analytical solutions for a k -machine line is impossible because of the size of the state space. The dimension of the discrete state space is, $M = 2^k \prod_{i=1}^{k-1} (N_i + 1)$ and it gets larger as the buffer sizes (N_i) increases or the line gets longer. Instead, we use an approximate solution algorithm, which consists of three steps:

- Identify the line bottlenecks
- Aggregate the contiguous non-bottleneck machines while leaving the immediate neighboring buffers of the bottlenecks outside the aggregation
- Decompose the virtual ℓ -machine system into $\ell - 1$ two-machine subsystems

In the aggregation and decomposition steps, we have used the steady-state probabilities that are provided for the continuous two-machine lines by Gershwin (1994).

5.1. Bottleneck Identification

Identification of the bottlenecks greatly reduces the complexity of the plant throughput improvement problem. Since the bottlenecks are the binding constraints

of the throughput maximization problem, their improvement directly improves the overall throughput. According to Bukchin (1998), bottlenecks are the best estimator for the production throughput. Wang et al. (2005) reviews the available bottleneck identification methods extensively. We adopted Toyota's Average Active Period (AAP) method (Roser et al., 2001) because we found it to be very effective in detecting the short-term bottlenecks compared to the other identification methods.

AAP classifies the states of a machine as active and inactive. A machine is inactive if it is blocked or starved; otherwise it is active. Consecutive active states are considered as one active state (see Figure 4). The machine with the highest average active period is the highest bottleneck.

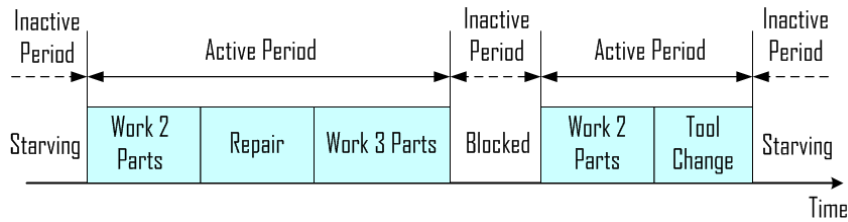

Figure 4 : Active and Inactive States of a Machine (Roser et al., 2001)

Let $A_i = \{a_{i1}, a_{i2}, \dots, a_{im}\}$ be the durations of the active states of machine i , based on a simulation run. \bar{a}_i and s_i are the average and the standard deviation of AAP for machine i , respectively. To improve accuracy, we also derive confidence intervals for AAP from m simulation runs. If the number of active durations in a simulation run is n_k , then the grand average of active durations for machine i obtained from m runs will be, $\bar{a}_i = \frac{n_1 \bar{a}_{i1} + n_2 \bar{a}_{i2} + \dots + n_m \bar{a}_{im}}{n_1 + n_2 + \dots + n_m}$. The total variability in the active duration data can

be described by total sum of squares, SS_{total} and equals $SS_{total} = SS_{between_runs} + SS_{within_run}$

where,

SS_{within_run} explains the deviation of each active duration data of machine i from

the average within each run, $SS_{within_run} = (n_1 - 1)s_{i1}^2 + (n_2 - 1)s_{i2}^2 + \dots + (n_m - 1)s_{im}^2$.

$SS_{between_runs}$ explains the deviation of average active duration of each simulation

run from the grand average, $SS_{between_runs} = n_1(\bar{a}_{i1} - \bar{\bar{a}}_i)^2 + n_2(\bar{a}_{i2} - \bar{\bar{a}}_i)^2 + \dots + n_m(\bar{a}_{im} - \bar{\bar{a}}_i)^2$.

The standard deviation of active durations for machine i obtained from m runs

will be, $S_i = \sqrt{\frac{SS_{total}}{\sum_{l=1}^m n_l - 1}}$.

Then, the confidence interval with $(1-\alpha)\%$ confidence for the average of

active durations for machine i can be written as, $\left(\bar{\bar{a}}_i - t_{\alpha/2, \sum_{l=1}^m n_l - 1} \frac{S_i}{\sqrt{\sum_{l=1}^m n_l}}, \bar{\bar{a}}_i + t_{\alpha/2, \sum_{l=1}^m n_l - 1} \frac{S_i}{\sqrt{\sum_{l=1}^m n_l}} \right)$.

Based on the grand averages, $\bar{\bar{a}}_i$ the bottleneck ranks are determined. The confidence intervals help find any shifting bottlenecks or ties between the machines by checking to see if there is any overlap between the confidence intervals.

5.2. Aggregation of Non-Bottleneck Machines

We use the aggregation method introduced by Terracol and David (1987) in our hybrid algorithm. After identifying the bottlenecks, we aggregated the non-bottleneck machines into a single equivalent machine and leave the neighboring buffers of bottlenecks outside the aggregation. Figure 5 shows the aggregation process. The bottlenecks are highlighted in green in the figure. We replace one buffer

and the two surrounding machines by a single equivalent machine until we aggregate all non-bottleneck machines. In Figure 5, the 7-machine line is reduced to a 5-machine line (virtual line) with aggregation.

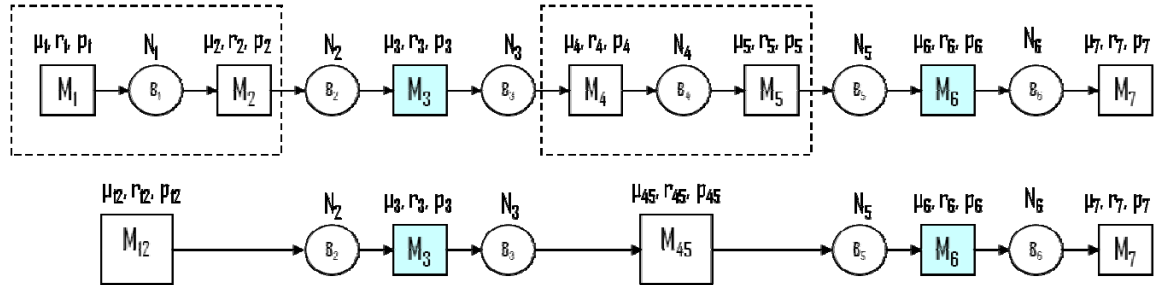

Figure 5 : Aggregation around the Bottleneck Machines

Let the states of each two-machine line segment of the production line be as in Table 1 and the probability of being in state S_j be pr_j . For $\mu_1 = \mu_2 = \mu$, the state transitions will be as in Figure 6. When we replace the two-machine and a buffer with an equivalent machine, these states reduces to two states: productive and unproductive states.

Table 1 : States of a Two -Machine Line Segment

States	B_i	M_i	M_{i+1}
S_1	x	1	1
S_2	x	1	0
S_3	x	0	1
S_4	x	0	0
S_5	N	1	1
S_6	N	1 (blocked)	0
S_7	0	0	1 (starved)
S_8	0	1	1

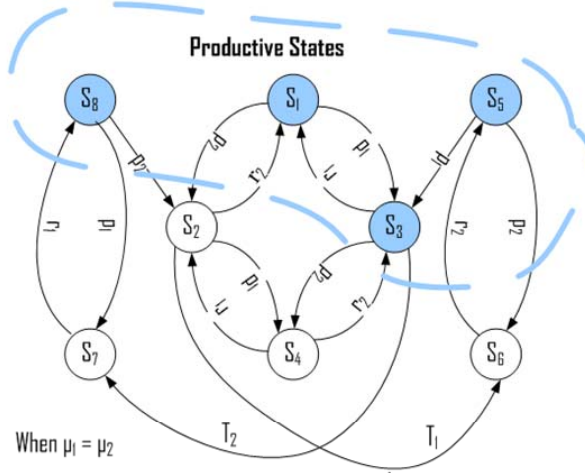

Figure 6 : State Transition Graph

The definition of an equivalent machine differs based on the side of the view. To find the parameters of the equivalent machine from downstream view, we classify the productive and unproductive states of the second machine M_{i+1} . Figure 6 encircles the productive states of the second machine. The probability of the second machine being in productive state is shown with $Pr(A^d)$ and being in unproductive state is shown with $Pr(N^d)$. Then, $Pr(A^d)$ equals $pr_1 + pr_3 + pr_5 + pr_8$ and $Pr(N^d)$ equals $pr_2 + pr_4 + pr_6 + pr_7$. The equivalent processing rate will be $\mu_{12}^d = \mu$. From the balance equations, we can then find T_1 and T_2 .

The r_{12}^d is the rate of the equivalent machine going from an unproductive state to a productive state. Then, we can write $Pr(A^d)p_{12}^d = pr_1p_2 + pr_3(p_2 + T_2) + pr_5p_2 + pr_8(p_1 + p_2)$. The p_{12}^d is the rate of the equivalent machine going from a productive state to an unproductive state. Then, we can write $Pr(N^d)r_{12}^d = pr_2r_2 + pr_4r_2 + pr_6r_2 + pr_7r_1$. The parameters of an equivalent machine from the downstream view are all defined. Now, the production rate, ρ_{12}^d will be equal to $\mu_{12}^d \frac{r_{12}^d}{r_{12}^d + p_{12}^d}$. Other parameters can be

calculated similarly. Interested readers can see Terracol and David (1987) for details.

We give all parameter equations below:

When $\mu_1 = \mu_2 = \mu$

$$Pr(A^u) = pr_1 + pr_2 + pr_5 + pr_8$$

$$Pr(A^d) = pr_1 + pr_3 + pr_5 + pr_8$$

$$Pr(N^u) = pr_3 + pr_4 + pr_6 + pr_7$$

$$Pr(N^d) = pr_2 + pr_4 + pr_6 + pr_7$$

$$p_{12}^u = \frac{pr_1p_1 + pr_2(p_1 + T_1) + pr_5(p_1 + p_2) + pr_8p_1}{Pr(A^u)}$$

$$p_{12}^d = \frac{pr_1p_2 + pr_3(p_2 + T_2) + pr_5p_2 + pr_8(p_1 + p_2)}{Pr(A^d)}$$

$$r_{12}^u = \frac{pr_3r_1 + pr_4r_1 + pr_6r_2 + pr_7r_1}{Pr(N^u)}$$

$$r_{12}^d = \frac{pr_2r_2 + pr_4r_2 + pr_6r_2 + pr_7r_1}{Pr(N^d)}$$

$$\mu_{12}^u = \mu$$

$$\mu_{12}^d = \mu$$

$$T_1 = \frac{pr_6r_2 - pr_5p_2}{pr_2}$$

$$T_2 = \frac{pr_7r_1 - pr_8p_1}{pr_3}$$

When $\mu_1 > \mu_2$

$$Pr(A^u) = pr_1 + pr_2 + pr_5$$

$$Pr(A^d) = pr_1 + pr_3 + pr_5$$

$$Pr(N^u) = pr_3 + pr_4 + pr_6 + pr_7$$

$$Pr(N^d) = pr_2 + pr_4 + pr_6 + pr_7$$

$$\mu_{12}^u = \frac{\mu_1(pr_1 + pr_2) + \mu_2pr_5}{Pr(A^u)}$$

$$\mu_{12}^d = \mu_2$$

$$p_{12}^u = \frac{pr_1p_1 + pr_2(p_1 + T_1) + pr_5\left(\frac{p_1\mu_2}{\mu_1} + p_2\right)}{Pr(A^u)}$$

$$p_{12}^d = \frac{(pr_1p_2 + pr_3(p_2 + T_2) + pr_5p_2)}{Pr(A^d)}$$

$$r_{12}^u = \frac{(pr_3r_1 + pr_4r_1 + pr_6r_2 + pr_7r_1)}{Pr(N^u)}$$

$$r_{12}^d = \frac{(pr_2r_2 + pr_4r_2 + pr_6r_2 + pr_7r_1)}{Pr(N^d)}$$

$$T_1 = \frac{pr_6r_2 - pr_5p_2}{pr_2}$$

$$T_2 = \frac{pr_7r_1}{pr_3}$$

When $\mu_1 < \mu_2$

$$Pr(A^u) = pr_1 + pr_2 + pr_8$$

$$Pr(N^u) = pr_3 + pr_4 + pr_6 + pr_7$$

$$\mu_{12}^u = \mu_1$$

$$p_{12}^u = \frac{(pr_1p_1 + pr_2(p_1 + T_1) + pr_8p_1)}{Pr(A^u)}$$

$$r_{12}^u = \frac{pr_3r_1 + pr_4r_1 + pr_6r_2 + pr_7r_1}{Pr(N^u)}$$

$$T_1 = \frac{pr_6r_2}{pr_2}$$

$$Pr(A^d) = pr_1 + pr_3 + pr_8$$

$$Pr(N^d) = pr_2 + pr_4 + pr_6 + pr_7$$

$$\mu_{12}^d = \frac{\mu_2(pr_1 + pr_3) + \mu_1pr_8}{Pr(A^d)}$$

$$p_{12}^d = \frac{pr_1p_2 + pr_3(p_2 + T_2) + pr_8\left(p_1 + \frac{p_2\mu_1}{\mu_2}\right)}{Pr(A^d)}$$

$$r_{12}^d = \frac{pr_2r_2 + pr_4r_2 + pr_6r_2 + pr_7r_1}{Pr(N^d)}$$

$$T_2 = \frac{pr_7r_1 - pr_8p_1}{pr_3}$$

5.3. Decomposition of the Virtual Line

We use the continuous model extension of the Dallery-David-Xie (DDX) decomposition method that is introduced by Burman (1995). After the aggregation of the non-bottleneck machines, we decompose the virtual ℓ -machine system into $\ell - 1$ two-machine subsystems (Figure 7).

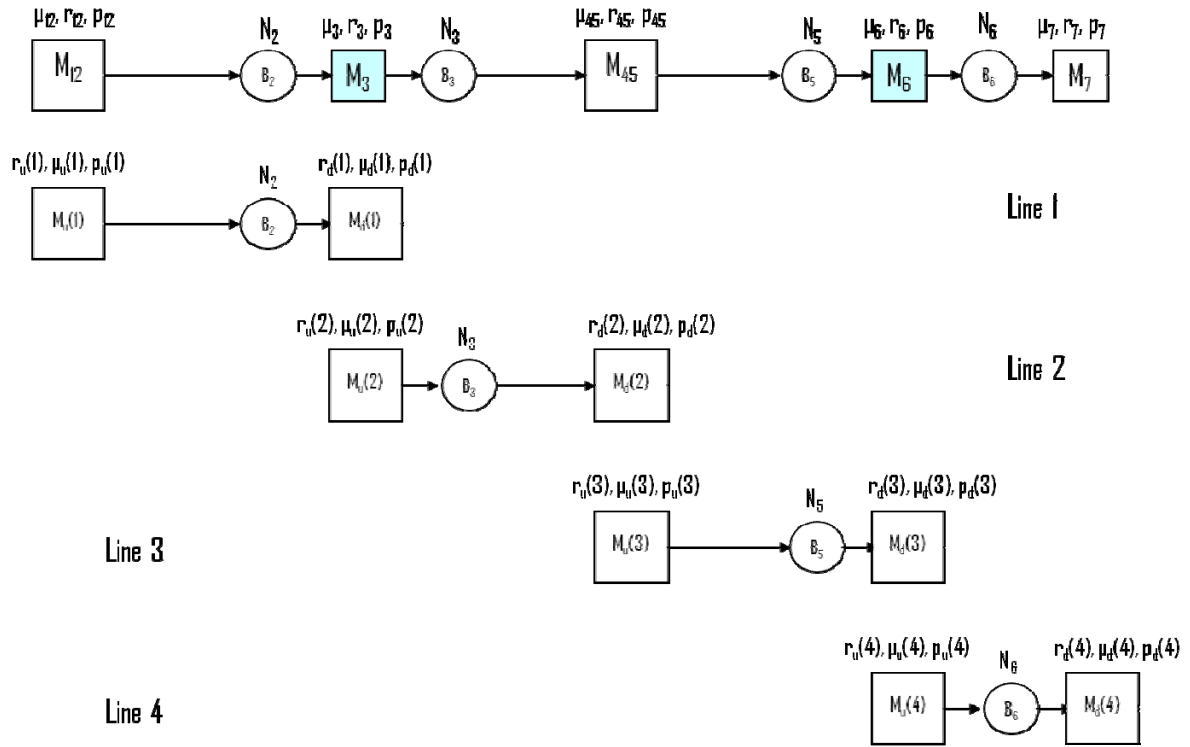

Figure 7 : Decomposition of the Virtual Line

The pseudo-machines of each two-machine systems are characterized by 6 unknown parameters $(\mu_u(i), r_u(i), p_u(i), \mu_d(i), r_d(i), p_d(i))$. Therefore, we need $6(\ell - 1)$ equations to find out the unknown parameters. These equations are derived by using some characteristics of the production lines. These characteristics are summarized in the following subsections. Interested readers can see Burman (1995) for details.

5.3.1. Conservation of Flow

Since no part is created or destroyed, the production flow will be conserved.

$$P(i) = P(1) \quad i = 2, \dots, \ell - 1$$

5.3.2. Flow Rate-Idle Time Relationship

The production rate of each machine in the line is less than its isolated production rate because it is impeded by other machine due to blocking and starving.

$$P(i) = e_i \mu_i (1 - P_s(i-1) - P_b(i)) \quad i = 2, \dots, \ell - 1$$

5.3.3. Interruption of Flow

If $M_u(i)$ is down, this is due to a failure of M_i or a starvation of B_{i-1} and a failure of $M_u(i-1)$ simultaneously.

$$p_u(i)\delta t = P(M_i \text{ is down or } (x_{i-1} = 0 \text{ and } M_u(i-1) \text{ is down}) \text{ at } t \\ + \delta t \mid M_u(i) \text{ is up and } x_i < N_i \text{ at } t)$$

Similarly, if $M_d(i)$ is down, this is due to a failure of M_i or a blockage of B_{i+1} and a failure of $M_d(i+1)$ simultaneously.

$$p_d(i)\delta t = P(M_i \text{ is down or } (M_d(i+1) \text{ is down and } x_{i+1} = N_{i+1}) \text{ at } t \\ + \delta t \mid M_d(i) \text{ is up and } x_i > 0 \text{ at } t)$$

5.3.4. Resumption of Flow

Remember that the conditions that $M_u(i)$ and $M_d(i)$ are down from the interruption of flow definition. Recovery from this condition leads to the derivation of resumption of flow equations. We write the equations for the resumption of $M_u(i)$ below. Similar equations can be written for the resumption of $M_d(i)$.

$$r_u(i)\delta t = A(i-1)X(i) + B(i)X'(i) \quad i = 2, \dots, \ell - 1$$

where,

$$A(i-1) = P(M_i \text{ is up and NOT } (x_{i-1} = 0 \text{ and } M_u(i-1) \text{ is down}) \text{ at } t + \delta t \mid x_{i-1} \\ = 0 \text{ and } M_u(i-1) \text{ is down at } t) = r_u(i-1)\delta t$$

$$B(i) = P(M_i \text{ is up and NOT}(x_{i-1} = 0 \text{ and } M_u(i-1) \text{ is down}) \text{ at } t + \delta t | M_i \text{ is down at } t)$$

$$= r_i \delta t$$

$$X(i) = P(x_{i-1} = 0 \text{ and } M_u(i-1) \text{ is down at } t | M_i \text{ is down or } (x_{i-1} = 0 \text{ and } M_u(i-1) \text{ is down}) \text{ at } t)$$

$$X'(i) = 1 - X(i)$$

5.3.5. Summary of Equations

The equations for $\mu_u(i)$ and $\mu_d(i)$ can be derived jointly from the conservation of flow and flow rate-idle time relationships. We can summarize all the decomposition equations as below:

Boundary Equations

$$\begin{aligned} r_u(1) &= r_1 & r_d(\ell - 1) &= r_\ell \\ p_u(1) &= p_1 & p_d(\ell - 1) &= p_\ell \\ \mu_u(1) &= \mu_1 & \mu_d(\ell - 1) &= \mu_\ell \end{aligned}$$

Upstream Equations $i = 2, \dots, \ell - 1$

$$p_u(i) = p_i \left(1 + \frac{P_{i-1}(0,1,1)\mu_u(i)}{P(i-1)} \left(\frac{\mu_u(i-1)}{\mu_d(i-1)} - 1 \right) \right) + \frac{P_{i-1}(0,0,1)\mu_u(i)}{P(i-1)} r_u(i-1)$$

$$r_u(i) = r_u(i-1) \frac{P_{i-1}(0,0,1)r_u(i)\mu_u(i)}{p_u(i)P(i-1)} + r_i \left(1 - \frac{P_{i-1}(0,0,1)r_u(i)\mu_u(i)}{p_u(i)P(i-1)} \right)$$

$$\mu_u(i) = \frac{1}{e_u(i)} \left(\frac{1}{\frac{1}{P(i-1)} + \frac{1}{e_i \mu_i} - \frac{1}{e_d(i-1)\mu_d(i-1)}} \right)$$

Downstream Equations $i = 1, \dots, \ell - 2$

$$p_d(i) = p_{i+1} \left(1 + \frac{P_{i+1}(N_{i+1}, 1, 1)\mu_d(i)}{P(i+1)} \left(\frac{\mu_d(i+1)}{\mu_u(i+1)} - 1 \right) \right) \\ + \frac{P_{i+1}(N_{i+1}, 1, 0)\mu_d(i+1)}{P(i+1)} r_d(i+1)$$

$$r_d(i) = r_d(i+1) \frac{P_{i+1}(N_{i+1}, 1, 0)r_d(i)\mu_d(i)}{p_d(i)P(i+1)} + r_{i+1} \left(1 - \frac{P_{i+1}(N_{i+1}, 1, 0)r_d(i)\mu_d(i)}{p_d(i)P(i+1)} \right)$$

$$\mu_d(i) = \frac{1}{e_d(i)} \left(\frac{1}{\frac{1}{P(i+1)} + \frac{1}{e_{i+1}\mu_{i+1}} - \frac{1}{e_u(i+1)\mu_u(i+1)}} \right)$$

6. Experimental Study

In the experiments, we tested the effectiveness and the efficiency of the hybrid aggregation-decomposition algorithm. We experimented with three variants of the hybrid aggregation-decomposition method with different levels of aggregation. We compared the results with pure aggregation (Terracol and David, 1987) and decomposition methods (Burman, 1995) using assembly lines published in Alvarez-Vargas et al. (1994), actual lines from the automotive industry, and synthetically generated lines. We also evaluated our hybrid algorithm's performance by comparing the results to the throughput averages that are obtained by simulation. Effectiveness of the methods is measured in number of standard deviations from the simulation averages. We implemented all of our algorithms and methods in Matlab R2007b and executed them on a Celeron M machine (with CPU 1.4 GHz and 512 MB RAM) running Microsoft Windows XP operating system.

We used both synthetic and real data in the experiments. The experiment sets consist of non-homogeneous production lines, in which the processing rates of each machine are different. We categorized the experiments into three groups (Cases 1-5, Cases 6-10, and Cases 11-16) based on the location of the bottleneck. In the remainder, we denote Hybrid Aggregation-Decomposition Method results by HAD, whole aggregation method results by AGG, and whole decomposition method by DEC.

6.1. Experimental Setting I: Cases 1-5

In this set of five experiments, the bottleneck machine is in the beginning of the line (Table 3). Case 1 is taken from Alvarez-Vargas et al. (1994). Case 2 belongs to a framing line of an automotive body shop. The other cases are synthetically generated. HAD1, HAD2, and HAD3 show different hybrid method implementations with varying degree of aggregation. For example, in HAD1, the bottleneck machine (M_1) and its neighboring buffer (B_1) are left outside the aggregation and the rest of the line (M_2, \dots, M_{10}) is replaced with an aggregate machine. Similarly, machines 3-10 and 4-10 are replaced with aggregate machines in HAD2 and HAD3. Table 2 shows the level of aggregations in the methods.

Table 2 : Level of Aggregation while Bottlenecks are at the Beginning

AGG	whole aggregation			
HAD1	1	2-10		
HAD2	1	2	3-10	
HAD3	1	2	3	4-10
DEC	whole decomposition			

Table 3 : Experimental Setting I: Cases 1-5

Case 1	St. #	St#1	St#2	St#3	St#4	St#5	St#6	St#7	St#8	St#9	St#10
	μ	0.5	1.2	2.5	2	1.5	0.8	0.9	1.1	0.7	1.4
	p	0.02	0.04	0.06	0.05	0.08	0.01	0.03	0.05	0.01	0.04
	r	0.1	0.2	0.1	0.08	0.15	0.05	0.09	0.1	0.04	0.2
	N	10	15	18	22	12	16	18	30	20	
	e	0.417	1	1.563	1.231	0.978	0.667	0.675	0.733	0.56	1.167

Case 2	St. #	St#10	St#20	St#30	St#40	St#50	St#60	St#70	St#80	St#90	St#100	
	μ	1.28	3.82	1.87	8.16	1.53	8.03	7.58	7.84	7.23	7.87	
	p	0.004	0.004	0.003	0.003	0.003	0.003	0.003	0.003	0.003	0.003	0.003
	r	0.45	0.34	0.35	0.26	0.21	0.31	0.4	0.4	0.4	0.23	
	N	3	3	3	3	3	3	3	3	3		
	e	1.27	3.779	1.856	8.071	1.508	7.948	7.528	7.786	7.18	7.769	

Case 3	St. #	St#10	St#9	St#8	St#7	St#6	St#5	St#4	St#3	St#2	St#1	
	μ	5.5	6	6.5	7	7.5	8	8.5	9	9.5	10	
	p	0.003	0.003	0.003	0.003	0.003	0.003	0.003	0.003	0.003	0.003	0.003
	r	0.3	0.3	0.3	0.3	0.3	0.3	0.3	0.3	0.3	0.3	0.3
	N	3	3	3	3	3	3	3	3	3	3	
	e	5.446	5.941	6.436	6.931	7.426	7.921	8.416	8.911	9.406	9.901	

Case 4	St. #	St#1	St#2	St#3	St#4	St#5	St#6	St#7	St#8	St#9	St#10
	μ	0.4	1	1.8	2.5	5	3.1	2.3	1.8	1.2	0.9
	p	0.04	0.04	0.04	0.04	0.04	0.04	0.04	0.04	0.04	0.04
	r	0.2	0.2	0.2	0.2	0.2	0.2	0.2	0.2	0.2	0.2
	N	3	3	3	3	3	3	3	3	3	
	e	0.333	0.833	1.5	2.083	4.167	2.583	1.917	1.5	1	0.75

Case 5	St. #	St#1	St#2	St#3	St#4	St#5	St#6	St#7	St#8	St#9	St#10
	μ	0.8	4.5	2	5	1.5	3	2	7	2.5	4
	p	0.004	0.004	0.004	0.004	0.004	0.004	0.004	0.004	0.004	0.004
	r	0.25	0.25	0.25	0.25	0.25	0.25	0.25	0.25	0.25	0.25
	N	3	3	3	3	3	3	3	3	3	
	e	0.787	4.429	1.969	4.921	1.476	2.953	1.969	6.89	2.461	3.937

Table 4 compares the performance of the algorithms. Even though AGG is the most efficient, it does not always provide consistent throughput estimates. (e.g., it is far away from the average throughput in Case 1.) HAD1 is not only efficient but also has reasonable accuracy in all cases. HAD1 outperforms DEC in all cases but Case 2 where the difference is small. As the level of aggregation decreases, the hybrid and decomposition methods become less efficient. We note that HAD2, HAD3, and DEC predicted efficiencies are very far away from the simulated average throughput in Case 5. We also note that the accuracy is not monotone in the degree of aggregation as accuracy going from HAD1 to HAD2, HAD3 and DEC is first decreasing and then increasing.

Table 4 : Comparison of Methods while Bottlenecks are at the Beginning

	Case Number									
	Number of Deviations from the Mean					CPU				
	1	2	3	4	5	1	2	3	4	5
AGG	7.25	3.78	1.69	5.04	1.86	0.17	0.13	0.19	0.13	0.15
HAD1	1	2.79	1.73	1.41	1.31	0.64	0.63	0.99	0.85	0.80
HAD2	2.84	3.63	1.37	0.55	41.99	2.66	10.59	8.79	1.77	44.61
HAD3	3.74	4.64	1.08	3.27	54.58	45.55	47.48	12.94	43.51	46.32
DEC	6.51	2.06	5.19	5.72	15.98	64.25	64.41	54.79	57.47	57.39

6.2. Experimental Setting II: Cases 6-10

In this set of experiments, the bottleneck is in the middle of the line. Case 6 is modified from Alvarez-Vargas et al. (1994), Case 7 belongs to a front structure line of an automotive body shop. The other cases are synthetic. The level of aggregation of the methods are shown in Table 5.

Table 5 : Level of Aggregation while Bottlenecks are in the Middle

AGG	whole aggregation						
HAD1			1-4	5	6-10		
HAD2	1-3	4	5	6	7-10		
HAD3	1-2	3	4	5	6	7	8-10
DEC	whole decomposition						

Table 6 : Experimental Setting II: Cases 6-10

Case 6	St. #	St#5	St#2	St#3	St#4	St#1	St#6	St#7	St#8	St#9	St#10
	μ	1.5	1.2	2.5	2	0.5	0.8	0.9	1.1	0.7	1.4
	p	0.08	0.04	0.06	0.05	0.02	0.01	0.03	0.05	0.01	0.04
	r	0.15	0.2	0.1	0.08	0.1	0.05	0.09	0.1	0.04	0.2
	N	10	15	18	22	12	16	18	30	20	
	e	0.978	1	1.563	1.231	0.417	0.667	0.675	0.733	0.56	1.167

Case 7	St. #	St#10	10R8	St#20	20R8	St#30	40R8	St#50	St#60	St#70	St#80
	μ	4.48	8.44	1.45	6.21	1.36	3.35	8.12	7.32	2.56	8.28
	p	0.003	0.002	0.003	0.003	0.003	0.003	0.002	0.002	0.003	0.002
	r	0.27	0.27	0.31	0.31	0.31	0.31	0.28	0.28	0.32	0.26
	N	3	3	3	3	3	3	3	3	3	
	e	4.438	8.362	1.439	6.151	1.344	3.318	8.049	7.256	2.537	8.204

Case 8	St. #	St#1	St#2	St#3	St#4	St#5	St#6	St#7	St#8	St#9	St#10
	μ	10	9	8	7	6	5	6	7	8	9
	p	0.003	0.003	0.003	0.003	0.003	0.003	0.003	0.003	0.003	0.003
	r	0.3	0.3	0.3	0.3	0.3	0.3	0.3	0.3	0.3	0.3
	N	3	3	3	3	3	3	3	3	3	
	e	9.901	8.911	7.921	6.931	5.941	4.95	5.941	6.931	7.921	8.911

Case 9	St. #	St#1	St#2	St#3	St#4	St#5	St#6	St#7	St#8	St#9	St#10
	μ	5.5	7.5	10	8	4	8	10	7.5	5.5	5
	p	0.003	0.003	0.003	0.003	0.003	0.003	0.003	0.003	0.003	0.003
	r	0.3	0.3	0.3	0.3	0.3	0.3	0.3	0.3	0.3	0.3
	N	3	3	3	3	3	3	3	3	3	
	e	5.446	7.426	9.901	7.921	3.96	7.921	9.901	7.426	5.446	4.95

Case 10	St. #	St#1	St#2	St#3	St#4	St#5	St#6	St#7	St#8	St#9	St#10
	μ	1.5	4.5	2	5	0.8	3	2	7	2.5	4
	p	0.004	0.004	0.004	0.004	0.004	0.004	0.004	0.004	0.004	0.004
	r	0.25	0.25	0.25	0.25	0.25	0.25	0.25	0.25	0.25	0.25
	N	3	3	3	3	3	3	3	3	3	
	e	1.476	4.429	1.969	4.921	0.787	2.953	1.969	6.89	2.461	3.937

The performance of the algorithms is given in Table 7. Again, the AGG is the most efficient, but the throughput estimates are not consistent, e.g., it is far away from the average throughput in Case 1. HAD1 is fast and consistently accurate in all cases. As the level of aggregation decreases, the methods get slower. HAD2, HAD3, and DEC struggle in some cases.

Table 7 : Comparison of Methods while Bottlenecks are in the Middle

Case Number										
	Number of Deviations from the Mean					CPU				
	6	7	8	9	10	6	7	8	9	10
AGG	7.08	0.1	1.03	0.03	0.22	0.17	0.17	0.42	0.17	0.17
HAD1	1.18	0.25	0.84	0.06	0.82	1.41	1.21	7.50	2.71	1.37
HAD2	0.6	19.97	1.04	11.87	16.37	43.95	44.02	24.16	54.37	43.99
HAD3	1.33	19.54	4.45	23.96	3.72	46.98	55.87	29.17	52.95	48.16
DEC	0.71	26.38	4.64	9.8	11.62	51.70	60.76	57.59	58.66	57.89

6.3. Experimental Setting III: Cases 11-15

The bottleneck is at the end of the line in this experiment set. Case 11 is modified from Alvarez-Vargas et al. (1994), Case 12 modified from the framing line data that is used in Case 2. The other cases are synthetic. The level of aggregation of the methods are shown in Table 8.

Table 8 : Level of Aggregation while Bottlenecks are at the End

r	0.25	0.25	0.25	0.25	0.25	0.25	0.25	0.25	0.25	0.25
N	3	3	3	3	3	3	3	3	3	
e	3.937	4.429	1.969	4.921	1.476	2.953	1.969	6.89	2.461	0.787

The performance of the algorithms is compared in Table 10. AGG is the most efficient and has reasonable accuracy. HAD1 is fast in all cases, but the throughput estimate for Cases 14 and 15 are far from the simulation average. However, in Case 15, we calculated the 95% confidence interval for simulation throughput as (0.7838, 0.7887). The throughput estimate of HAD1 is 0.7731 and within the interval with a relative error of 1.67%, which is reasonable. The throughput estimate of HAD1 for Case 14 is 0.3169 and the 95% confidence interval for simulation throughput as (0.3282, 0.3388). The relative error makes 4.97% for this case. As the level of aggregation decreases, the methods get slower. HAD3 and DEC struggle in some cases.

Table 10 : Comparison of Methods while Bottlenecks are at the End

	Case Number									
	Number of Deviations from the Mean					CPU				
	11	12	13	14	15	11	12	13	14	15
AGG	2.2	1.13	2.6	3.99	1.64	0.16	0.17	0.13	0.17	0.16
HAD1	2.38	3.24	1.93	6.14	10.52	0.67	0.71	0.78	2.54	0.82
HAD2	3.21	5.7	1.5	4.73	3.8	3.86	3.46	6.25	2.62	4.35
HAD3	3.47	25.56	1.28	30.73	525.96	5.10	4.30	10.98	45.54	41.24
DEC	12.4	22.24	4.79	41.79	335	51.50	59.06	59.09	58.61	57.91

7. Conclusions

We proposed a hybrid aggregation-decomposition algorithm that approximates the throughput of longer production lines. The algorithm selectively aggregates the

parts of the line based on the location of the bottlenecks and uses decomposition method for approximate analysis of the resulting virtual line.

We compared our results with the aggregation and decomposition methods. The experiments showed that the aggregation method provides fast, but inconsistent results. The decomposition method requires longer CPU time in case of long production lines. On the other hand, the hybrid method provides consistently accurate results in all cases in much less CPU time than the decomposition method and is comparable to those of the aggregation method.

As future research, the level of aggregation in the hybrid method can be studied with the construction of error bounds. The analysis of the bottleneck behavior in throughput prediction is recommended.

CHAPTER V: CONCLUSIONS & FUTURE RESEARCH

The dissertation proposes analytical methods for throughput evaluation and a decision support system for throughput improvement in production facilities. While making productivity related decisions, maintenance operations should not be thought of separately. Effective management of maintenance operations is crucial in production facilities, which are often unable to reach throughput targets due to being down for long periods with machine breakdowns and overdue repairs.

We first present a decision support system (APMDSS), which guides maintenance managers in making corrective and preventive maintenance related decisions for the upcoming production shift. The APMDSS anticipates the dynamics (bottlenecks, hourly buffer levels, machine health) of the upcoming shift by exploiting the initial condition information. We show that the initial conditions (such as, time since last machine preventive maintenance cycle, operational status of machines, inventory buffer levels, and scheduled production model mix) change the bottleneck patterns of the upcoming shift and the use of historic bottleneck data for maintenance task prioritization will not always perform well. We did the experiments using real data from a body shop of a major automotive company. We also used synthetic data to investigate production lines that handle multiple products (model mix case). The results are very promising when we compared the performance of APMDSS with methods from the literature and practice.

Secondly, we offer an exact analytical formula that estimates the throughput performance of an identically deteriorating two-machine system. The experiments show that the results are consistent with intuition. In the model, we consider degradation, imperfect repair and preventive maintenance. Our results show the importance of considering these details. We also show that calculating the throughput with equivalent reliability parameters is not as accurate as studying the machine health states explicitly.

Thirdly, we propose a hybrid aggregation-decomposition algorithm that approximates the throughput of longer production lines. The algorithm selectively aggregates the parts of the line based on the location of the bottlenecks. We compared our results with the existing aggregation and decomposition methods. The experiments show that the hybrid method provides reasonable solutions. The results are obtained in less CPU time than the decomposition method and they are consistent and more accurate than the aggregation method.

Future Work

Future research can consider extending APMDSS to incorporate partial PM to benefit from the short opportunity windows and to incorporate preemptive CM to let higher degree bottlenecks resume production without much delay.

A model that studies non-identically deteriorating two machine systems is also recommended. The method can be used as a building block for the analysis of longer lines.

Another future study can be the construction of error bounds to determine the level of aggregation in the hybrid method. The analysis of the bottleneck behavior in throughput prediction is also recommended.

APPENDICES

Chapter II : Appendix 1

Figure 1 through Figure 6 show the 95% confidence limits of the average active periods of the top two most severe bottlenecks under different initial conditions. As seen in the figures, the severity and the variability of these bottlenecks increase with increasing ages and failures in general. Buffers may have different impact on the bottleneck severity based on the location of the bottlenecks (see Figure 5 and Figure 6). They do not have much impact on the variability of the bottlenecks.

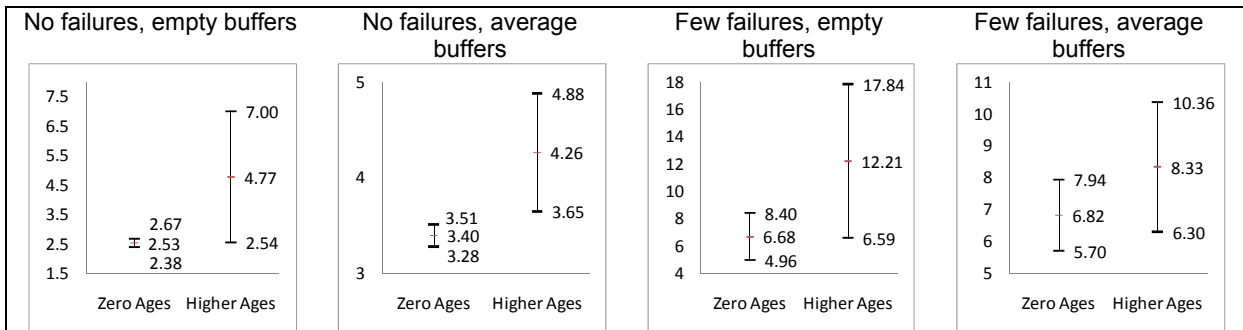

Figure 1 : Impact of Initial Machine Ages on Bottleneck Status of LHA1 under Different Initial Conditions

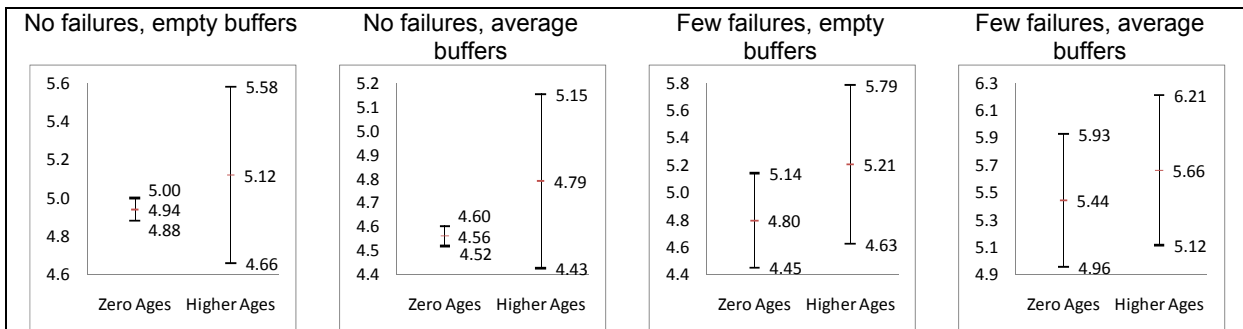

Figure 2 : Impact of Initial Machine Ages on Bottleneck Status of Dash under Different Initial Conditions

Zero ages, empty buffers	Higher ages, empty	Zero ages, average	Higher ages, average
--------------------------	--------------------	--------------------	----------------------

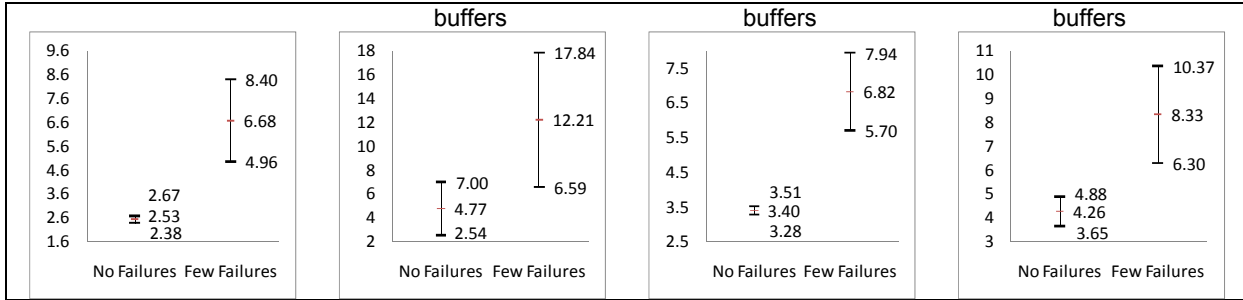

Figure 3 : Impact of Initial Machine Failures on Bottleneck Status of LHA1 under Different Initial Conditions

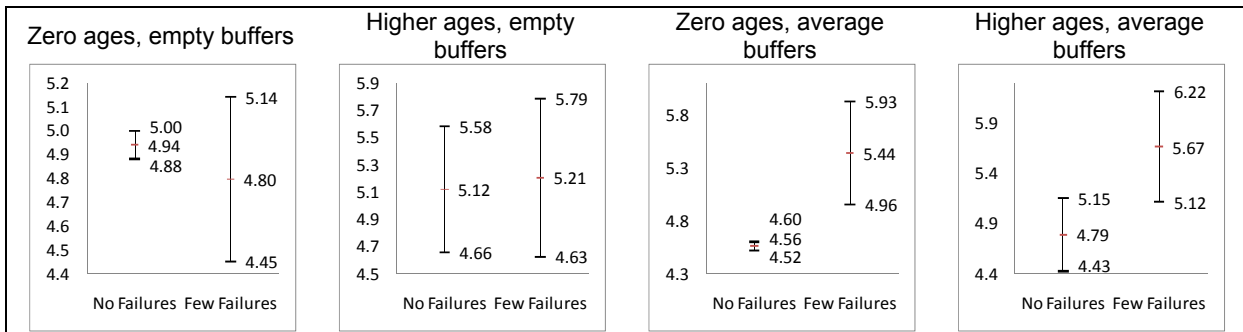

Figure 4 : Impact of Initial Machine Failures on Bottleneck Status of Dash under Different Initial Conditions

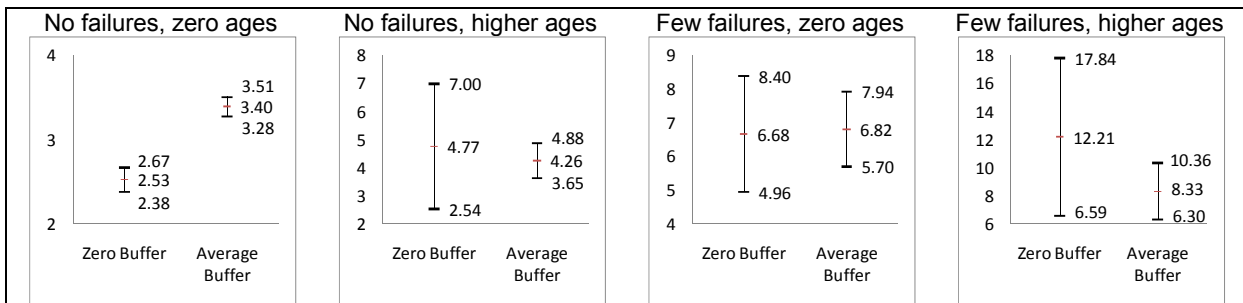

Figure 5 : Impact of Initial Buffer Levels on Bottleneck Status of LHA1 under Different Initial Conditions

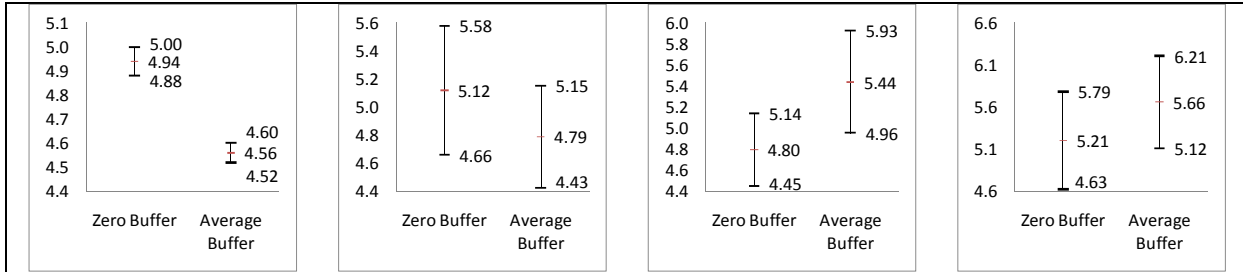

Figure 6 : Impact of Initial Buffer Levels on Bottleneck Status of Dash under Different Initial Conditions

If we group the bottlenecks as primary, secondary, and tertiary bottlenecks based on their severity, LHA1 and Dash belong to the first category and LHA2, RHA3, and Sta40 belong to the second category under given conditions. The variability of the secondary bottlenecks increases with higher initial ages and initial failures; their severity increases with buffers.

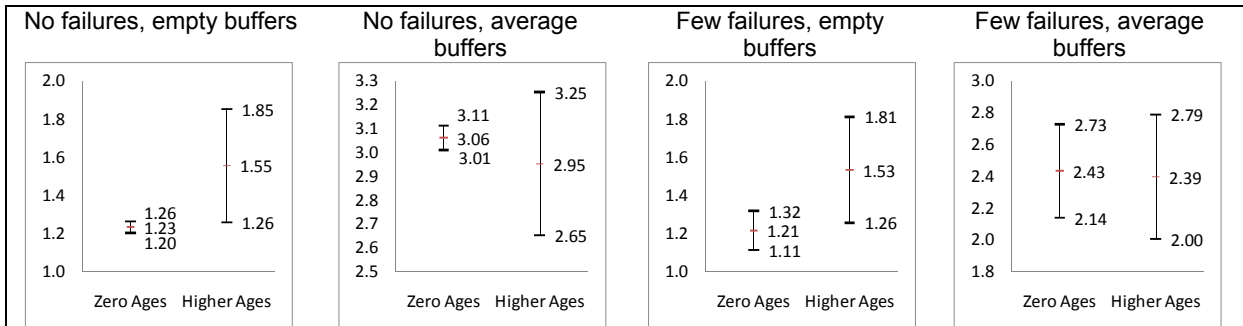

Figure 7 : Impact of Initial Machine Ages on Bottleneck Status of LHA2 under Different Initial Conditions

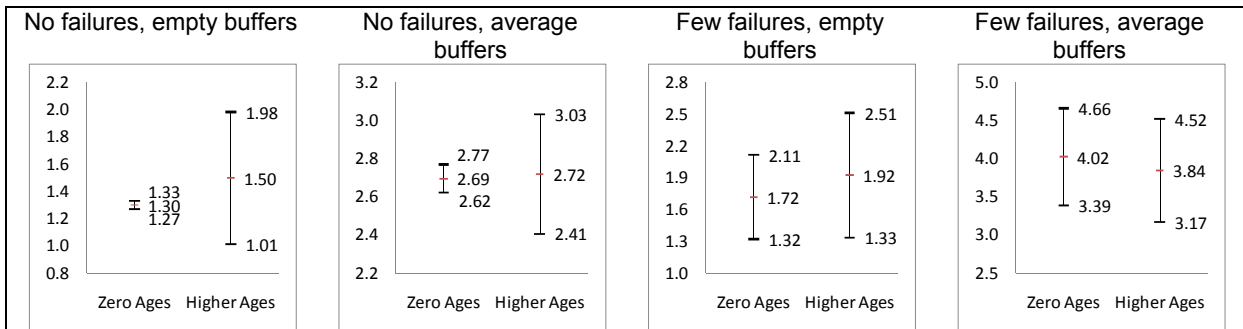

Figure 8 : Impact of Initial Machine Ages on Bottleneck Status of RHA3 under Different Initial Conditions

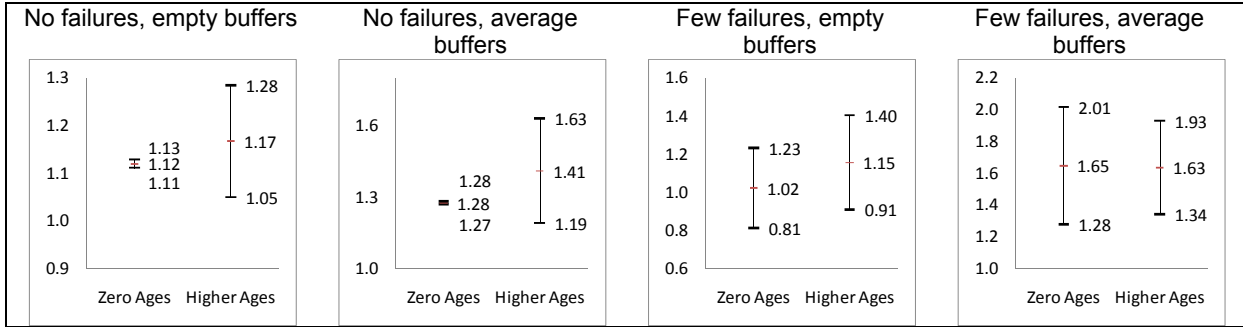

Figure 9 : Impact of Initial Machine Ages on Bottleneck Status of Sta40 under Different Initial Conditions

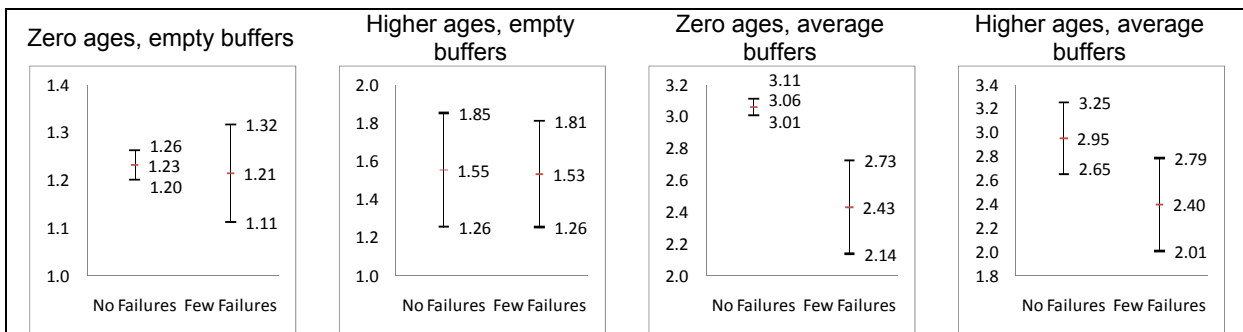

Figure 10 : Impact of Initial Machine Failures on Bottleneck Status of LHA2 under Different Initial Conditions

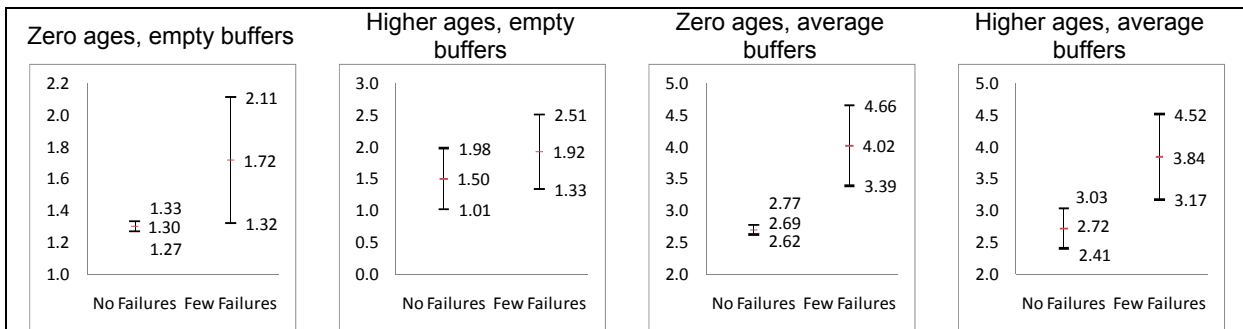

Figure 11 : Impact of Initial Machine Failures on Bottleneck Status of RHA3 under Different Initial Conditions



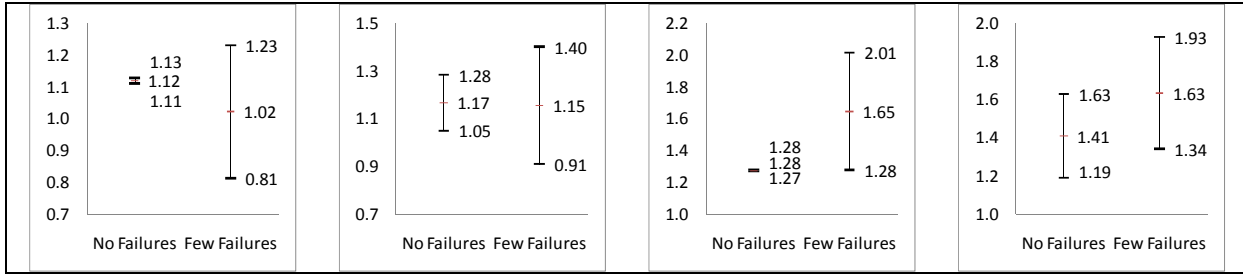

Figure 12 : Impact of Initial Machine Failures on Bottleneck Status of Sta40 under Different Initial Conditions

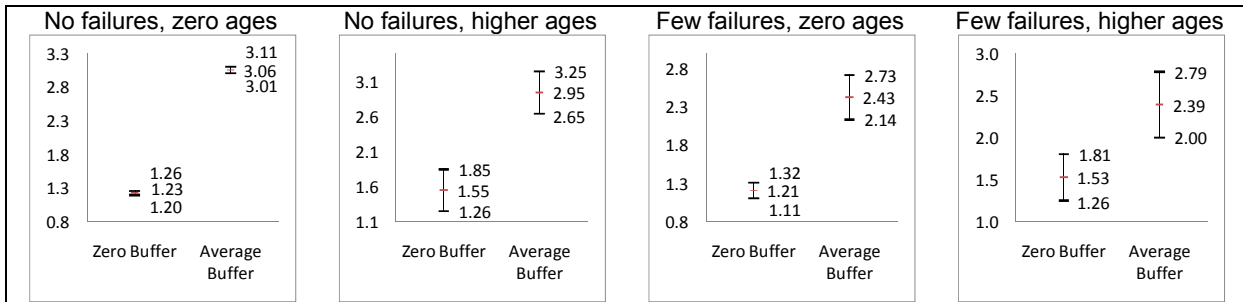

Figure 13 : Impact of Initial Buffer Levels on Bottleneck Status of LHA2 under Different Initial Conditions

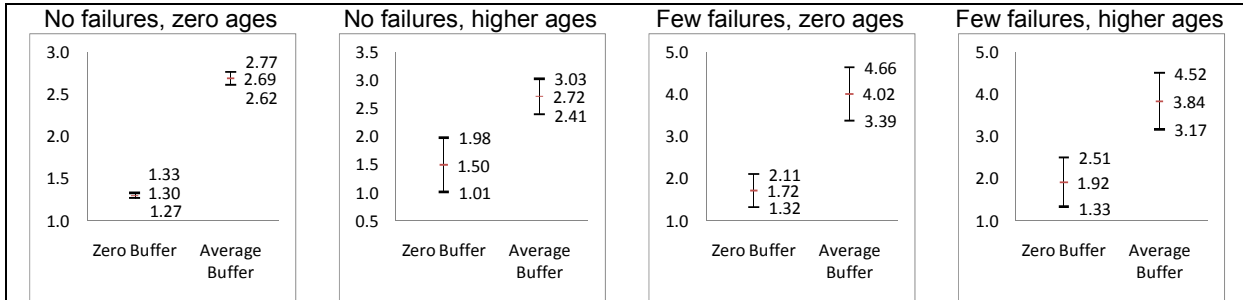

Figure 14 : Impact of Initial Buffer Levels on Bottleneck Status of RHA3 under Different Initial Conditions

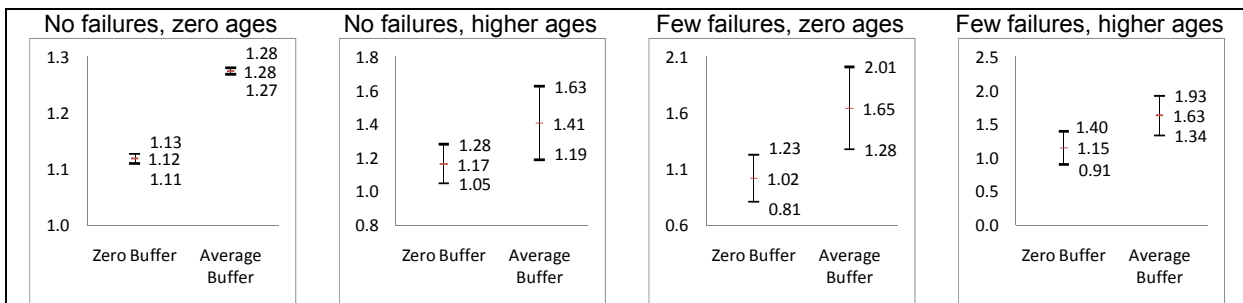

Figure 15 : Impact of Initial Buffer Levels on Bottleneck Status of Sta40 under Different Initial Conditions

Chapter II : Appendix 2

The mix percentages are written on the title of each table column. Different mixes create unexpected bottlenecks and lead to shifting bottlenecks.

Table 1 : Impact of Model Mix on JPH and Overall Bottleneck Patterns

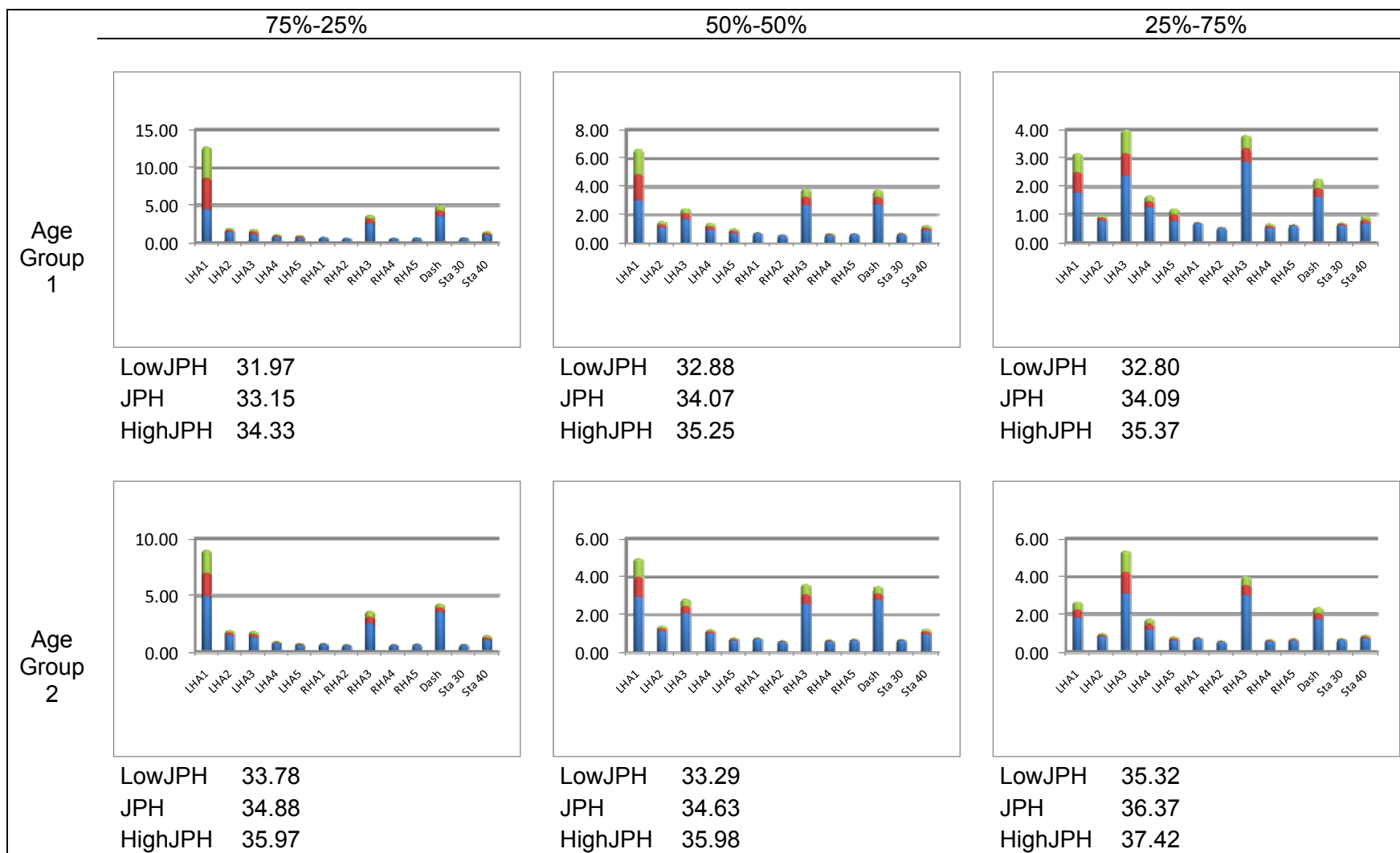

Table 2 : Impact of Model Mix on JPH and Overall Bottleneck Patterns (continued)

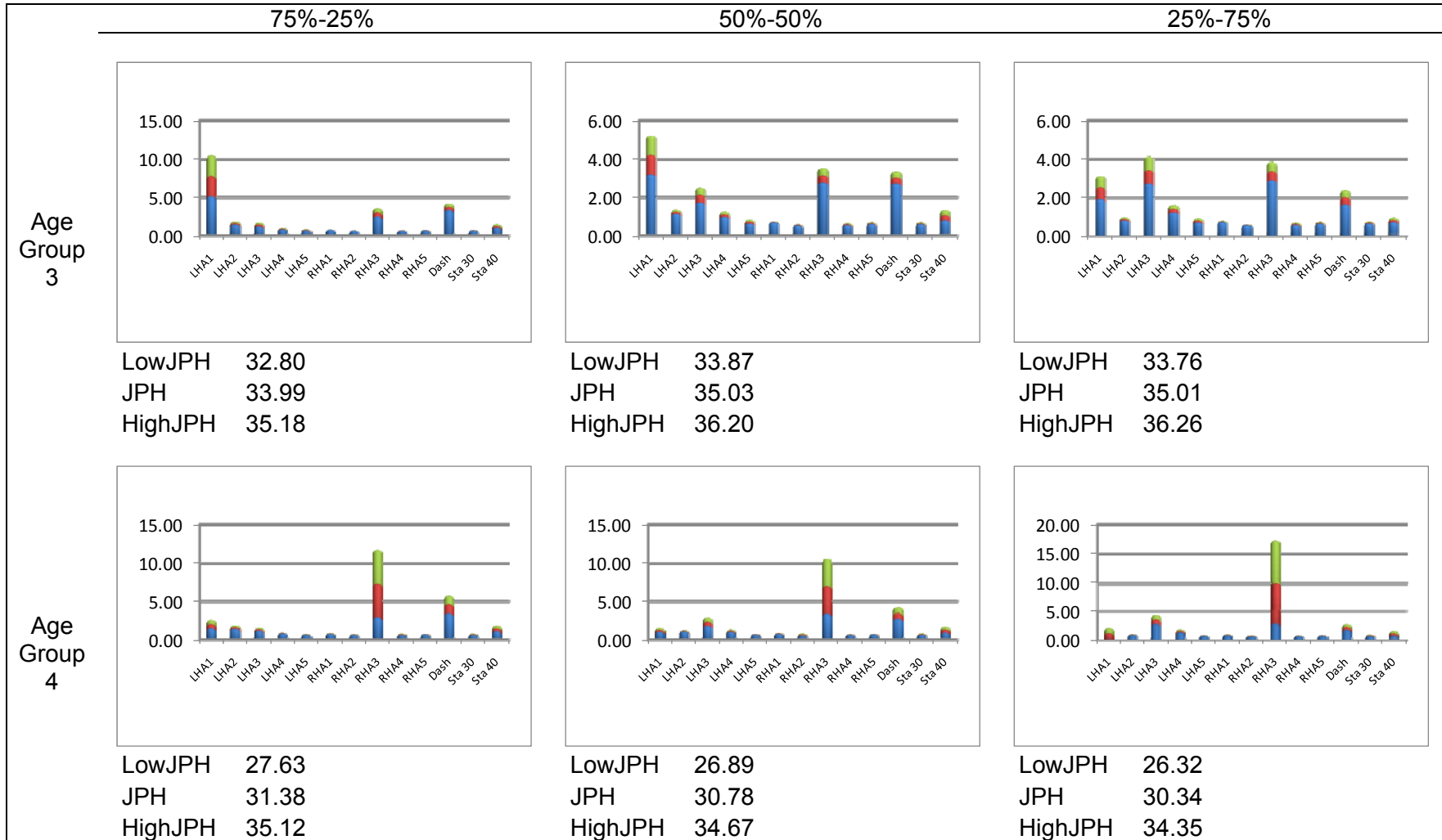
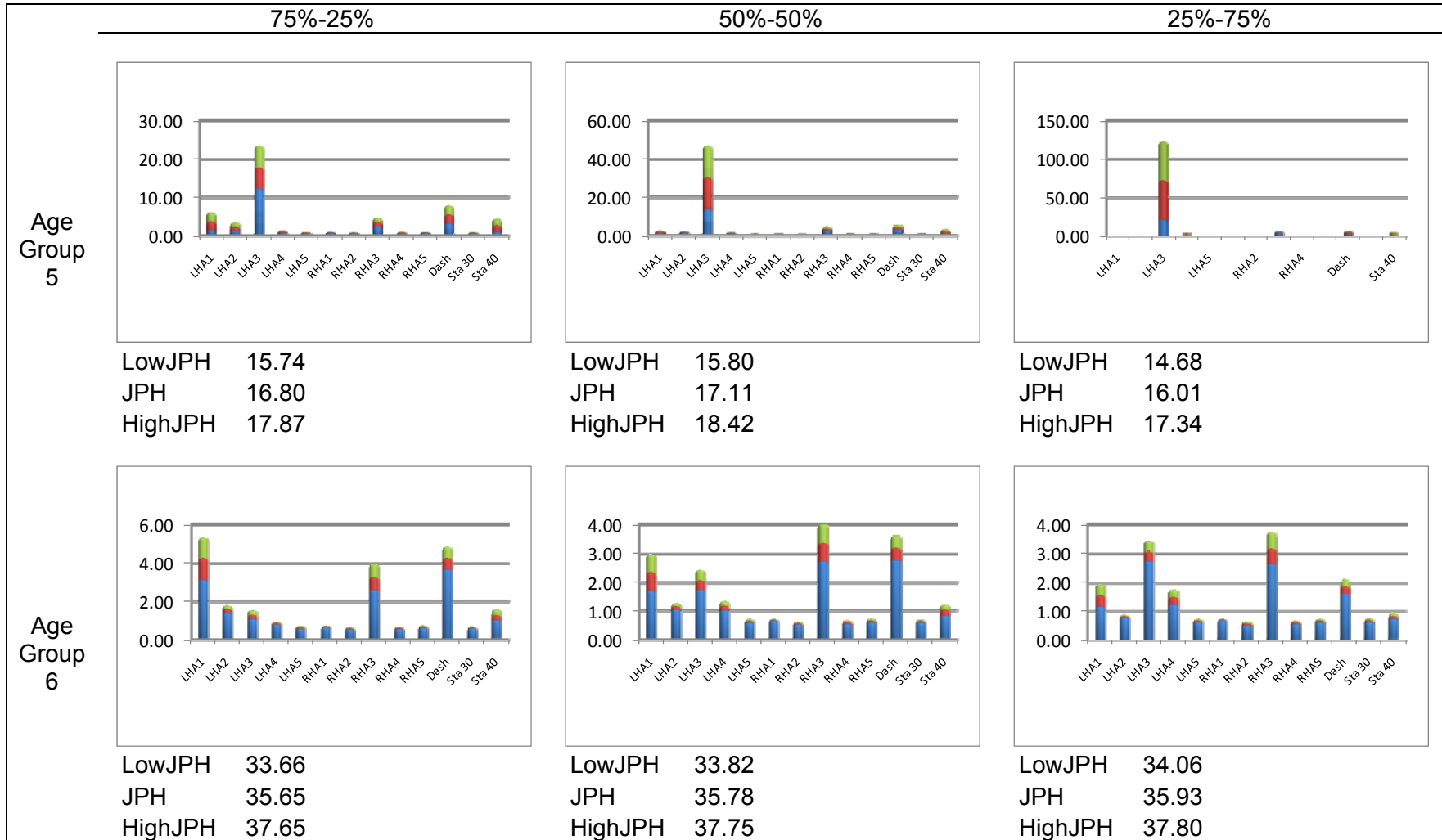

Table 3 : Impact of Model Mix on JPH and Overall Bottleneck Patterns (continued)



Chapter III : Appendix 1

$$\begin{aligned}
A = & ((1 - bp_3 - bp_2 - br_2)br_1 + (1 - bp_1 - bp_2 - br_2)b\varphi + (1 - bp_1)bp_2 \\
& - (-1 + bp_3)(br_2 + bp_1 - 1))ar_1 \\
& + ((1 - bp_3 - bp_2 - br_2)br_1 + (1 - bp_1 - bp_2 - br_2)b\varphi + (1 - bp_1)bp_2 \\
& - (-1 + bp_3)(br_2 + bp_1 - 1))a\varphi + (bp_2 + bp_3 - 1 + br_2)br_1 + b\varphi(br_2 \\
& + bp_2 + bp_1 - 1)
\end{aligned}$$

$$\begin{aligned}
B = & \left((2 - ar_2 - ap_3 - ap_2)bp_2 + (2 - ar_2 - ap_3 - ap_2)br_2 + (1 - bp_3)ap_2 \right. \\
& + (1 - bp_3)ar_2 + (2 - ap_3)bp_3 - 3 + ap_3)br_1 \\
& + ((2 - ar_2 - ap_3 - ap_2)bp_2 + (2 - ar_2 - ap_3 - ap_2)br_2 + (1 - bp_1)ap_2 \\
& + (1 - bp_1)ar_2 + (2 - ap_3)bp_1 - 3 + ap_3)b\varphi \\
& + ((1 - bp_1)ap_2 + (1 - bp_1)ar_2 + (1 - ap_3)bp_1 - 2 + ap_3)bp_2 \\
& + ((1 - bp_3)ap_2 + (1 - bp_3)ar_2 + (1 - ap_3)bp_3 - 2 + ap_3)br_2 \\
& - (-1 + bp_3)(-1 + bp_1)ap_2 - (-1 + bp_3)(-1 + bp_1)ar_2 \\
& + ((1 - ap_3)bp_3 - 2 + ap_3)bp_1 + (-2 + ap_3)bp_3 + 3 - ap_3)ar_1 \\
& + \left((2 - ar_2 - ap_1 - ap_2)bp_2 + (2 - ar_2 - ap_1 - ap_2)br_2 + (1 - bp_3)ap_2 \right. \\
& + (1 - bp_3)ar_2 + (2 - ap_1)bp_3 - 3 + ap_1)br_1 \\
& + ((2 - ar_2 - ap_1 - ap_2)bp_2 + (2 - ar_2 - ap_1 - ap_2)br_2 + (1 - bp_1)ap_2 \\
& + (1 - bp_1)ar_2 + (2 - ap_1)bp_1 - 3 + ap_1)b\varphi \\
& + ((1 - bp_1)ap_2 + (1 - bp_1)ar_2 + (-ap_1 + 1)bp_1 - 2 + ap_1)bp_2 \\
& + ((1 - bp_3)ap_2 + (1 - bp_3)ar_2 + (-ap_1 + 1)bp_3 - 2 + ap_1)br_2 \\
& - (-1 + bp_3)(-1 + bp_1)ap_2 - (-1 + bp_3)(-1 + bp_1)ar_2 \\
& + ((-ap_1 + 1)bp_3 - 2 + ap_1)bp_1 + (-2 + ap_1)bp_3 + 3 - ap_1)a\varphi \\
& + ((-2 + ar_2 + ap_1 + ap_3 + ap_2)bp_2 + (-2 + ar_2 + ap_1 + ap_3 + ap_2)br_2 \\
& + (-1 + bp_3)ap_2 + (-1 + bp_3)ar_2 + (-2 + ap_1 + ap_3)bp_3 + 3 - ap_3 \\
& - ap_1)br_1 \\
& + ((-2 + ar_2 + ap_1 + ap_3 + ap_2)bp_2 + (-2 + ar_2 + ap_1 + ap_3 + ap_2)br_2 \\
& + (-1 + bp_1)ap_2 + (-1 + bp_1)ar_2 + (-2 + ap_1 + ap_3)bp_1 + 3 - ap_3 \\
& - ap_1)b\varphi
\end{aligned}$$

$$\begin{aligned}
C = & \left((-2 + br_2 + bp_2 + bp_3)ap_2 + (-2 + br_2 + bp_2 + bp_3)ar_2 + (-1 + ap_3)bp_2 \right. \\
& + (-1 + ap_3)br_2 + (bp_3 - 2)ap_3 - bp_3 + 3)ar_1 \\
& + ((-2 + br_2 + bp_2 + bp_3)ap_2 + (-2 + br_2 + bp_2 + bp_3)ar_2 \\
& + (-1 + ap_1)bp_2 + (-1 + ap_1)br_2 + (bp_3 - 2)ap_1 - bp_3 + 3)a\varphi \\
& + ((-1 + ap_1)bp_2 + (-1 + ap_1)br_2 + (-1 + bp_3)ap_1 - bp_3 + 2)ap_2 \\
& + ((-1 + ap_3)bp_2 + (-1 + ap_3)br_2 + (-1 + bp_3)ap_3 - bp_3 + 2)ar_2 \\
& + (-1 + ap_3)(-1 + ap_1)bp_2 + (-1 + ap_3)(-1 + ap_1)br_2 \\
& + ((-1 + bp_3)ap_3 - bp_3 + 2)ap_1 + (-bp_3 + 2)ap_3 - 3 + bp_3)br_1 \\
& + \left(((-2 + br_2 + bp_2 + bp_1)ap_2 + (-2 + br_2 + bp_2 + bp_1)ar_2 \right. \\
& + (-1 + ap_3)bp_2 + (-1 + ap_3)br_2 + (bp_1 - 2)ap_3 - bp_1 + 3)ar_1 \\
& + ((-2 + br_2 + bp_2 + bp_1)ap_2 + (-2 + br_2 + bp_2 + bp_1)ar_2 \\
& + (-1 + ap_1)bp_2 + (-1 + ap_1)br_2 + (bp_1 - 2)ap_1 - bp_1 + 3)a\varphi \\
& + ((-1 + ap_1)bp_2 + (-1 + ap_1)br_2 + (-1 + bp_1)ap_1 - bp_1 + 2)ap_2 \\
& + ((-1 + ap_3)bp_2 + (-1 + ap_3)br_2 + (-1 + bp_1)ap_3 - bp_1 + 2)ar_2 \\
& + (-1 + ap_3)(-1 + ap_1)bp_2 + (-1 + ap_3)(-1 + ap_1)br_2 \\
& + ((-1 + bp_1)ap_3 - bp_1 + 2)ap_1 + (-bp_1 + 2)ap_3 - 3 + bp_1) b\varphi \\
& + ((2 - bp_2 - bp_3 - bp_1 - br_2)ap_2 + (2 - bp_2 - bp_3 - bp_1 - br_2)ar_2 \\
& + (1 - ap_3)bp_2 + (1 - ap_3)br_2 + (-bp_3 + 2 - bp_1)ap_3 + bp_3 + bp_1 \\
& - 3)ar_1 \\
& - a\varphi((-2 + bp_2 + bp_3 + bp_1 + br_2)ap_2 \\
& + (-2 + bp_2 + bp_3 + bp_1 + br_2)ar_2 + (-1 + ap_1)bp_2 + (-1 + ap_1)br_2 \\
& + (bp_1 - 2 + bp_3)ap_1 - bp_3 - bp_1 + 3)
\end{aligned}$$

$$\begin{aligned}
E = & ((ap_2 + ap_3 + ar_2 - 1)ar_1 + (ap_2 + ar_2 + ap_1 - 1)a\varphi + (-1 + ap_1)ap_2 \\
& + (-1 + ap_3)(ap_1 + ar_2 - 1))br_1 \\
& + ((ap_2 + ap_3 + ar_2 - 1)ar_1 + (ap_2 + ar_2 + ap_1 - 1)a\varphi + (-1 + ap_1)ap_2 \\
& + (-1 + ap_3)(ap_1 + ar_2 - 1))b\varphi + (1 - ap_2 - ar_2 - ap_3)ar_1 \\
& - (ap_2 + ar_2 + ap_1 - 1)a\varphi
\end{aligned}$$

REFERENCES

- Alden J. M., Burns L. D., Costy T., Hutton R. D., Jackson C. A., Kim D. S., Kohls K. A., Owen J. H., Turnquist M. A., Veen D. J. V., 2006. General Motor Increases Its Production Throughput, *Interfaces*, Vol. 36, No. 1, 6-25.
- Altiok T., 1997. *Performance Analysis of Manufacturing Systems*, Springer: New York
- Alvarez-Vargas, R., Dallery, Y., David, R., 1994, A study of the continuous flow model of production lines with unreliable machines and finite buffers, *Journal of Manufacturing Systems*, Vol. 13, 221–234.
- Basile, O., Dehombreux, P., Riane, F., 2007. Evaluation of the uncertainty affecting reliability models, *Journal of Quality in Maintenance Engineering* 13, 137-151.
- Bergeron D., Jamali A., Yamamoto H., 2010. Modeling and Analysis of Manufacturing Systems: A Review of Existing Models, *International Journal of Product Development*, Vol. 10, 46-60.
- Boukas, E.K., Yang, H., 1996. Optimal control of manufacturing flow and preventive maintenance, *IEEE Transactions on Automatic Control* 41, 881-885.
- Budai, G., Dekker, R., Nicolai, R.P., 2008. Maintenance and production: A review of planning models, In D.N.P. Murthy and K.A.H. Kobbacy (eds.), *Complex System Maintenance Handbook*, Springer Series in Reliability Engineering 13, 321-344.

- Bukchin J., 1998. A comparative study of performance measures for throughput of a mixed model assembly line in a JIT environment, *International Journal of Production Research* 36, 2669-2685.
- Burman, M.H., 1995. New results in flow line analysis, PhD Thesis, OR Center, MIT.
- Buzacott J.A., 1967. Automatic transfer lines with buffer stocks, *International Journal of Production Research*, Vol. 5, 183–200.
- Buzacott J.A., Shanthikumar J.G., 1993. *Stochastic Models of Manufacturing Systems*, Prentice Hall: New Jersey.
- Buzacott, J.A., 1967. Automatic transfer lines with buffer stocks. *Int. J. Prod. Res.*, Vol. 5, 183–200.
- Cavory, G., Dupas, R., Goncalves, G., 2001. A genetic approach to the scheduling of preventive maintenance tasks on a single product manufacturing production line. *Internal Journal of Production Economics* 74, 135–146.
- Chang, Q., Ni, J., Bandyopadhyay, P., Biller, S., Xiao, G., 2007. Maintenance opportunity planning system, *ASME Transaction, Journal of Manufacturing Science and Engineering*, 129, 661–668.
- Chang, Q., Ni, J., Bandyopadhyay, P., Biller, S., Xiao, G., 2007. Supervisory factory control based on real-time production feedback, *ASME Transaction, Journal of Manufacturing Science and Engineering* 129, 653–660.
- Chiang S.-Y., Kuo C.-T., Meerkov S. M., 2000. DT-Bottlenecks in Serial Production Lines: Theory and Application, *IEEE Transactions on Robotics and Automation*, Vol. 16, No.5, 567-580.

- Choong Y. F., Gershwin S. B., 1987. A decomposition method for the approximated evaluation of capacitated transfer lines with unreliable machines and random processing times, *IIE Transactions*, Vol. 19, 150-15.
- Dallery Y., David R., Xie X.-L., 1988. An efficient algorithm for analysis of transfer lines with unreliable machines and finite buffers, *IIE Transactions*, Vol. 20, 280–283.
- Dallery Y., Gershwin, S. B., 1992. Manufacturing flow line systems: a review of models and analytical results, *Queuing Systems*, Vol. 12, 3–94.
- De Koster, M.B.M., 1988. An improved algorithm to approximate the behavior of flow lines, *International Journal of Production Research*, Vol. 26, 691–700.
- Dedopoulos, I.T., Smeers, Y., 1998. An age reduction approach for finite horizon optimization of preventive maintenance for single units subject to random failures, *Computers & Industrial Engineering* 34, 643-654.
- Dekker R., 1995. Integrating optimisation, priority setting, planning and combining of maintenance activities, *European Journal of Operational Research* 82, 225–240.
- Dekker, R., Smeitink, E., 1994. Preventive maintenance at opportunities of restricted duration, *Naval Research Logistics* 41, 335-353.
- Dekker, R., van Rijn, C., 1996. Prompt - A decision support system for opportunity based preventive maintenance, In Özekici S. (ed.), *Reliability and Maintenance of Complex Systems*, Springer-Verlag, Proceedings of the NATO ASI series 154, 517-536.

- Garg, A., Deshmukh, S.G., 2006. Maintenance management: literature review and directions, *Journal of Quality in Maintenance Engineering* 12, 205–238.
- Gershwin S. B., 1987. An Efficient Decomposition Method for the Approximate Evaluation of Tandem Queues with Finite Storage Space and Blocking, *Operations Research*, 291-305.
- Gershwin, S.B., 1994. *Manufacturing Systems Engineering*, (Prentice Hall: Englewood Cliffs, NJ)
- Gershwin, S.B., Berman, O., 1981. Analysis of transfer lines consisting of two unreliable machines with random processing times and finite storage buffers, *AIIE Transactions* Vol. 13, No. 1, 2-11.
- Gershwin, S.B., Schick, I.C., 1983. Modeling and analysis of three-stage transfer lines with unreliable machines and finite buffers, *Operations Research* Vol. 31, No. 2, 354-380.
- Gharbi, A., Kenne, J. 2005. Maintenance scheduling and production control of multiple-machine manufacturing systems, *Computers & Industrial Engineering* 48, 693-707.
- Govil M. K., Fu M. C., 1999. Queueing Theory in Manufacturing: A Survey, *Journal of Manufacturing Systems*, Vol. 18, No. 3, 214-240.
- Harbour Report by Oliver Wyman, 2008. *The Harbour Report North America*, Media Release.
- Hong Y., Glassey C.R., Seong D., 1992. The analysis of a production line with unreliable machines and random processing times, *IIE Transactions*, Vol. 24, 77–83.

- Iravani, S., Duenyas, I., 2002. Integrated maintenance and production control of a deteriorating production system, *IIE Transactions* 34, 423-435.
- Kenne J, Gharbi A, Beit M, 2007. Age-dependent production planning and maintenance strategies in unreliable manufacturing systems with lost sale. *European Journal of Operational Research* 178, 408-420.
- Kenne, J.P., Nkeungoue, L.J., 2008. Simultaneous control of production, preventive and corrective maintenance rates of a failure-prone manufacturing system. *Applied Numerical Mathematics* 58, 180-194.
- Khanlari, A., Mohammadi, K., Sohrabi, B., 2008. Prioritizing equipments for preventive maintenance activities using fuzzy rules, *Computers & Industrial Engineering* 54, 169-184.
- Kianfar, F. 2005. A numerical method to approximate optimal production and maintenance plan in a flexible manufacturing system, *Applied Mathematics and Computation* 170, 924-940.
- Langer, R., Li, J., Biller, S., Chang, Q., Huang, N., Xiao, G., 2010. Simulation study of a bottleneck-based dispatching policy for a maintenance workforce, *International Journal of Production Research* 48, 1745-1763.
- Li J., Blumenfeld D. E., Alden, J. M., 2006. Comparisons of two-machine line models in throughput analysis, *International Journal of Production Research*, Vol. 44, No. 7, 1375–1398.
- Li J., Blumenfeld D. E., Huang N., Alden J. M., 2009. Throughput analysis of production systems: recent advances and future topics, *International Journal of Production Research*, Vol. 47, 3823-3851.

- Li, J., Meerkov S.M., 2003. Due-time performance in production systems with Markovian machines, In *Analysis of Manufacturing Systems*, edited by S.B. Gershwin et al., 221–253, Kluwer Academic Publisher.
- Li, L., Ambani, S., Ni, J., 2009. Plant-level maintenance decision support system for throughput improvement, *International Journal of Production Research* 47, 7047-7061.
- Lim J.-T., Meerkov S.M., Top F., 1990. Homogeneous, asymptotically reliable serial production lines: theory and a case study, *IEEE Transactions on Automatic Control*, Vol. 35, No. 5, 524-534.
- Papadopoulos H. T., Heavey C., 1996. Queueing theory in manufacturing systems analysis and design: A classification of models for production and transfer lines, *European Journal of Operational Research*, Vol. 92, 1-27.
- Patchong A., Lemoine T., Kern G., 2003. Improving Car Body Production at PSA Peugeot Citroen, *Interfaces*, Vol. 33, No. 1, 36-49.
- Perros H. G., 1983. Queueing Networks with Blocking: A Bibliography, *IIE Transactions*, Vol. 15, 292-299.
- Pfeil G., Holcomb R., Muir C. T., 2000. Visteon's Sterling Plant Uses Simulation-Based Decision Support in Training, Operations, and Planning, *Interfaces*, Vol. 3, No. 1, 115-133.
- Roser C., Nakano M., Tanaka M., 2001. A Practical Bottleneck Detection Method, In *Proceedings of Winter Simulation Conference*.

- Salonen, A., Deleryd, M., 2011. Cost of poor maintenance: A concept for maintenance performance improvement, *Journal of Quality In Maintenance Engineering* 17, 63-73.
- Sevastyanov B.A., 1962. Influence of storage bin capacity on the average standstill time of a production line, *Theory of Probability Applications*, Vol. 6, 429–438.
- Song, D. P., 2009. Production and preventive maintenance control in a stochastic manufacturing system. *International Journal of Production Economics* 19, 101-111.
- Suri R., Fu, B.R., 1994. On Using Continuous Flow Lines to Model Discrete Production Lines, *Discrete Event Dynamic Systems*, Vol. 4, 129-169.
- Terracol, C., David, R., 1987. An aggregation technique for performance evaluation of transfer lines with unreliable machine and finite buffers, In: *Proceedings of the IEEE international conference on robotics and automation*, 1333–1338.
- Tolio T., Matta A., Gershwin S.B., 2002. Analysis of two-machine lines with multiple failure modes, *IIE Transactions* Vol. 34, 51–62.
- Van der Duyn Schouten, F., Vanneste, S., 1995. Maintenance optimization of a production system with buffer capacity, *European Journal of Operational Research* 82, 323-338.
- Wang, H., 2002. A survey of maintenance policies of deteriorating systems, *European Journal of Operational Research* 139, 469–489.
- Wang, Y., Zhao, Q., Zheng, D., 2005. Bottlenecks in Production Networks: An Overview, *Journal of Systems Science and Systems Engineering* 14, 347-363.

Zequeira, R. I., Valdes, J. E., Berengure, C., 2008. Optimal buffer inventory and opportunistic preventive maintenance under random production capacity availability, *International Journal of Production Economics* 111, 686-696.

Zimmern B. , 1956. Etudes de la propagation des arrest aleatoires dans les chaines de production, *Rev. Statist. Appl.*, Vol. 4, 85-104.

ABSTRACT**THROUGHPUT ANALYSIS AND BOTTLENECK MANAGEMENT
OF PRODUCTION LINES**

by

HATICE UCAR**May 2012****Advisor:** Dr. Ratna Babu Chinnam**Major:** Industrial Engineering**Degree:** Doctor of Philosophy

Companies are improving their manufacturing excellence in order to stay competitive in global markets. Manufacturing facilities are becoming more complex due to increasing product variety, shrinking product life-cycles, and novel production technologies and processes. The design and operation of manufacturing systems is of greater importance today than it was in the past. Many studies have been carried out on the design and operation of manufacturing systems by academicians and practitioners over the years, however, there is still no agreement on how to best predict, manage, and improve the factory performance. The studies are based on either analytical approaches or simulation-based approaches. Success stories from some companies that applied these techniques in combination motivate our study.

In the dissertation, our main focus is on the effective management and improvement of complex production facilities, such as those encountered in the automotive industry (e.g., body shops and assembly facilities). Maintenance, being a

critical component of production facilities, has a direct impact on the improvement of the overall production performance. In this dissertation, we develop methods and tools to manage the efficiency of plant operations.

We introduce an anticipative plant level maintenance decision support system (APMDSS), which gives guidance in prioritizing and scheduling the corrective and the preventive maintenance activities. APMDSS does this based on the dynamic bottleneck ranks (i.e., equipment that most constrain the throughput) with an objective of improving the throughput of a plant. Unlike the previous bottleneck management approaches, APMDSS anticipates the system dynamics (i.e., bottlenecks, hourly buffer levels, and machine health) for the upcoming shifts by using initial state information from the beginning of the product shift (such as, time since last machine preventive maintenance cycle, operational status of machines, inventory buffer levels, and scheduled production model mix). In order to improve the accuracy of anticipating plant dynamics, we rely on discrete event simulation models.

We also propose two analytical models for throughput evaluation. First model addresses deteriorating two-machine systems. In the model, the machines degrade with usage and the reliability behavior of each machine changes depending on the machine's health condition. The model considers both perfect and imperfect repairs, simultaneously. The second model is based on a hybrid aggregation-decomposition algorithm that approximates the throughput of longer production lines. The algorithm selectively aggregates parts of the production line based on the location of the bottlenecks. In this model, we combine the existing aggregation and decomposition

methods based on their relative strengths. The basic idea is to benefit from the speed of the aggregation method and the accuracy of the decomposition method.

Extensive experiments based on synthetic production lines and real production lines from a major automotive company confirm the superior performance of the proposed APMDSS and hybrid aggregation-decomposition method under certain conditions.

AUTOBIOGRAPHICAL STATEMENT

Hatice Ucar Guner received her B.S. and M.S. degrees in Industrial Engineering in 2003 and 2005, respectively, from Fatih University, Istanbul, Turkey. She received her Ph.D. degree in Industrial Engineering from Wayne State University, Detroit in 2012. Her research interests are in the application of optimization and simulation techniques to manufacturing system design and operations management.

During her studies at Wayne State University, Ms. Ucar worked on “Bottleneck Identification and Throughput Management at Dearborn Truck Plant” project funded by Ford Motor Company and “Mathematics Instruction using Decision Science and Engineering Tools” (MINDSET) Project funded by National Science Foundation. The latter project aims to introduce operations research techniques to high school students.

Ms. Ucar authored a number of peer reviewed journal articles and conference proceedings. She made several technical presentations at INFORMS annual meetings and national conferences. She is a member of INFORMS.