

---

This item was submitted to [Loughborough's Research Repository](#) by the author.  
Items in Figshare are protected by copyright, with all rights reserved, unless otherwise indicated.

## **Robust nonlinear generalized predictive control of a permanent magnet synchronous motor with an anti-windup compensator**

PLEASE CITE THE PUBLISHED VERSION

<http://dx.doi.org/10.1109/ISIE.2010.5637565>

PUBLISHER

© IEEE

VERSION

VoR (Version of Record)

LICENCE

CC BY-NC-ND 4.0

REPOSITORY RECORD

Errouissi, Rachid, Mohand Ouhrouche, and Wen-Hua Chen. 2011. "Robust Nonlinear Generalized Predictive Control of a Permanent Magnet Synchronous Motor with an Anti-windup Compensator". figshare. <https://hdl.handle.net/2134/7732>.

This item was submitted to Loughborough's Institutional Repository (<https://dspace.lboro.ac.uk/>) by the author and is made available under the following Creative Commons Licence conditions.



**CC creative commons**  
COMMONS DEED

**Attribution-NonCommercial-NoDerivs 2.5**

**You are free:**

- to copy, distribute, display, and perform the work

**Under the following conditions:**

**BY:** **Attribution.** You must attribute the work in the manner specified by the author or licensor.

**Noncommercial.** You may not use this work for commercial purposes.

**No Derivative Works.** You may not alter, transform, or build upon this work.

- For any reuse or distribution, you must make clear to others the license terms of this work.
- Any of these conditions can be waived if you get permission from the copyright holder.

**Your fair use and other rights are in no way affected by the above.**

This is a human-readable summary of the [Legal Code \(the full license\)](#).

[Disclaimer](#) 

For the full text of this licence, please go to:  
<http://creativecommons.org/licenses/by-nc-nd/2.5/>

# Robust Nonlinear Generalized Predictive Control of a Permanent Magnet Synchronous Motor with an Anti-windup Compensator

Rachid Errouissi<sup>(1)</sup>, Mohand Ouhrouche<sup>(1)</sup>, *Senior Member, IEEE*, and Wen-Hua Chen<sup>(2)</sup>, *Senior Member, IEEE*.

<sup>(1)</sup>Applied Sciences, University of Quebec at Chicoutimi, Quebec, Canada

<sup>(2)</sup>Department of Aeronautical and Automotive Engineering, Loughborough University, Loughborough, Leicestershire, UK

**Abstract-** This paper presents a robust nonlinear generalized predictive control (RNGPC) strategy applied to a permanent magnet synchronous motor (PMSM) for speed trajectory tracking and disturbance rejection. The nonlinear predictive control law is derived by using a newly defined design cost function. The Taylor series expansion is used to carry out the prediction in a finite horizon. No information about the external perturbation and parameters uncertainties are needed to ensure the robustness of the proposed RNGPC. Moreover, to maintain the phase current within the limits using saturation blocks, a cascaded structure is adopted and an anti-windup compensator is proposed. The validity of the proposed control strategy is implemented on a dSPACE DS1104 board driving in real-time a 0.25 kW PMSM. Experimental results have demonstrated the stability, robustness and the effectiveness of the proposed control strategy regarding trajectory tracking and disturbance rejection.

**Index Terms** — Permanent magnet synchronous motor (PMSM), nonlinear generalized predictive control (NGPC), disturbance observer, anti-windup compensator, stability, robustness.

## I. INTRODUCTION

THE PMSM has been gradually replacing DC and induction motors in a wide range of drive applications such as: robotic actuators, computer disk drives, domestic applications, automotive and renewable energy conversion systems. Despite its advantages, such as high efficiency, high power density and high torque to current ratio, the PMSM remains complicated and difficult to control when good transient performance under all operating conditions is desired. This is due to the fact that the PMSM is a nonlinear, multivariable, time varying system subjected to unknown disturbances and variable parameters.

Over the past decades, various robust control techniques have been developed in order to improve the performances of the PMSM in the presence external disturbances. However, the widely used approach consists in using linear control theory with the disturbance estimate [1]-[2]. In [3], the robustness is ensured by using  $H_\infty$  control theory. Disturbance observers which rely on time delay control approach have been reported in [4]. In [5], an observer is designed based on a Lyapunov function, to deduce the voltage disturbance caused by uncertainties. To take into account nonlinearities of the PMSM, different approaches have been adopted such as nonlinear control [6] and sliding mode control [7].

The main objective in the control of a PMSM is to design a robust controller for rotor speed trajectory tracking while

regulating the  $d$ -axis current, in the presence of varying parameters and unknown load torque. Discrete time model predictive control (DTMPC) for nonlinear dynamic processes can improve some desirable features, such as robustness which can be handled using the internal model control (IMC) [8]-[9]. More detailed literature review on the robustness features of DTMPC for nonlinear systems can be found in [10]. However, it is still quite hard to adopt this strategy for nonlinear systems having fast dynamics such as electrical machines; as it requires heavy online computation.

In order to apply MPC to fast nonlinear systems, many approaches have been proposed [11]-[15]. In [11] and [12], an optimal predictive control for a continuous time system is developed. Chen et al. [13] has proposed a NGPC based on Taylor series expansion to a certain order for Mutli-Input Multi-Output (MIMO) systems. The control order is taken to be different from zero to analyze the stability of the closed loop system when the input relative degree is higher than four. Robust nonlinear predictive control for a SISO system is introduced in [14], where the external disturbance is estimated and compensated in the control law. In [15] the robust NGPC is extended to MIMO systems.

Nowadays, the MPC has been successfully applied for control of power electronics converters and electric drives. Hedjar et al [16]-[17] have designed a cascaded NGPC based on Taylor series expansion for an induction motor (IM). It is to be noted that NGPC based on Taylor series expansion can't remove completely the steady state error under unknown disturbances. In [18]-[19], the robustness of the classical NGPC is improved by modifying its cost function. This strategy has proved to be effective when applied to the speed control of the PMSM [20]. However, the  $d$ -axis current regulation is not guaranteed when the electrical parameters vary.

The MPC of a PMSM with unknown load torque based on linear plant models has been investigated in [21], where the decoupling method of current and voltage is used to obtain a linear model. In [22], the General predictive control (GPC) has been employed to generate the required torque to implement the DTC technique. Constrained MPC of PMSM is studied in [23].

In this paper, the NGPC based on the Taylor series expansion is revised to enhance the robustness in controlling a PMSM, which is a nonlinear system with fast dynamics. A novel performance index is proposed and the controller is developed under the assumption that there is no disturbance and no mismatched parameters. A cascade structure for the controller is adopted. This structure allows directly limiting the magnitude of the armature phase current by using

saturation blocks. However, when the control saturates, the closed loop performances deteriorate significantly; resulting in a high overshoot and a long settling time. This is due to the fact that the RNGPC contains an integral action. The windup phenomenon occurs, especially, when large set-point changes are made. To suppress this undesired effect, known as integrator windup, an anti-windup compensator based on the well known conditional integral [24] method is used.

The rest of the paper is organized as follows. In Section II, the PMSM model is defined by a bilinear state space model. In Section III, the RNGPC for MIMO nonlinear system is presented. The proposed controller is applied to PMSM in Section IV. Experimental results are given in Section VI.

## II. MATHEMATICAL MODEL OF THE PMSM

The mathematical model of the PMSM in the ( $d$ - $q$ ) rotor reference is given by:

$$\begin{cases} \frac{di_d}{dt} = -\frac{R}{L_d}i_d + \frac{L_q}{L_d}p\omega_r i_q + \frac{1}{L_d}u_d \\ \frac{di_q}{dt} = -\frac{R}{L_q}i_q - \frac{L_d}{L_q}p\omega_r i_d - \frac{\phi_v p\omega_r}{L_q} + \frac{1}{L_d}u_q \\ \frac{d\omega_r}{dt} = \frac{p}{J}(\phi_v i_q + (L_d - L_q)i_q i_d) - \frac{B}{J}\omega_r - \frac{T_L}{J} \end{cases} \quad (1)$$

$i_d$  and  $i_q$ , are respectively  $d$ -axis and  $q$ -axis components of the armature current;  $u_d$  and  $u_q$  are  $d$ -axis and  $q$ -axis components of the supply voltage;  $\omega_r$  is the rotor speed and  $T_L$  is the load torque, considered an unknown disturbance and ignored in the synthesis of the controller.  $R$ ,  $L_d$  and  $L_q$ , are respectively the per-phase armature resistance and the  $d$ -axis and  $q$ -axis inductances.  $\phi_v$  is the permanent magnet flux;  $p$  is the number of pole pairs;  $J$  is the moment of inertia and  $B$  is the coefficient of friction.

The variables to be controlled are the rotor speed  $\omega_r$  and the  $d$ -axis component of the armature current  $i_d$ .

## III. ROBUST NONLINEAR GENERALIZED PREDICTIVE CONTROL

In this section, the GNPC developed in [13]-[15] is revised in order to enhance the robustness of the closed loop system without using a disturbance observer.

Consider a multivariable nonlinear system with the same input relative degree  $\rho$  for the output  $y$ :

$$\begin{cases} \dot{x}(t) = f(x) + g(x)u(t) \\ y = h(x) \end{cases} \quad (2)$$

$x$ ,  $u$  and  $y$  are the vectors of, respectively, the state ( $d$ - $q$  components of the armature current and rotor speed), the input ( $d$ - $q$  components of the armature voltage) and the output ( $d$  component of the armature current and the rotor speed).  $f(x)$  and  $h(x)$  are assumed to be continuously differentiable.

### A. Design of the controller

The objective of the RNGPC is to find the best input such that the future plant output  $y(t+T)$  can track a future reference trajectory  $y_r(t+T)$  in presence of perturbation. This can be reduced to solving the minimization of the cost function defined by:

$$\mathfrak{J} = \frac{1}{2}(y_r(t+T) - y(t+T))^T (y_r(t+T) - y(t+T)) \quad (3)$$

where  $T > 0$  is the prediction horizon.

The addition of an integral action in the controller design allows the achievement of a zero steady state error under the mismatched parameters and external perturbation. This can be accomplished by choosing the following cost function.

$$\mathfrak{J} = \frac{1}{2}I(t+T)^T I(t+T) \quad (4)$$

where

$$I(t) = \int_0^t (y_r(\tau) - y(\tau)) d\tau = \int_0^t e(\tau) d\tau$$

To solve the nonlinear optimization problem (4), the predicted term  $I(t+T)$  is expanded into a  $(\rho+1)$ <sup>th</sup> order Taylor series expansion using the Lie derivative  $h(x)$  along a field of vectors  $f(x)$ . The Taylor series expansion yields:

$$I(t+T) = \Gamma(T)Y(t) \quad (5)$$

where

$$\begin{cases} Y(t) = [I(t) \quad e(t) \quad \dot{e}(t) \quad \dots \quad e^{(\rho)}(t)]^T \\ \Gamma(T) = \begin{bmatrix} I_d & \bar{T} & \frac{\bar{T}^2}{2} & \dots & \frac{\bar{T}^{\rho+1}}{(\rho+1)!} \end{bmatrix} \end{cases}$$

The  $(m \times m)$  matrices  $\bar{T}$  and  $I_d$  are given by:

$$\bar{T} = \text{diag}\{T, \dots, T\} \quad ; \quad I_d = \text{diag}\{1, \dots, 1\} \quad (6)$$

From the fact that  $\rho$  represents the relative degree for the output  $y$ , it follows that:

$$\begin{cases} \dot{y}(t) = L_f h(x) \\ \ddot{y}(t) = L_f^2 h(x) \\ \vdots \\ y^{(\rho)}(t) = L_f^\rho h(x) + L_g L_f^{\rho-1} h(x) u(t) \end{cases} \quad (7)$$

Invoking (4), (5) and (6) with (7) yields:

$$\mathfrak{J} = \frac{1}{2}(\Psi(x) - M(u(t)))^T \Pi(T)(\Psi(x) - M(u(t))) \quad (8)$$

where

$$\begin{aligned} \Pi(T) &= \Gamma^T(T)\Gamma(T) \\ \Psi(x) &= \begin{bmatrix} I(t) \\ e(t) \\ (\dot{y}_r(t) - L_f h(x)) \\ \vdots \\ (y_r^{(\rho)}(t) - L_f^\rho h(x)) \end{bmatrix} ; \quad M(u(t)) = \begin{bmatrix} 0_{m \times 1} \\ 0_{m \times 1} \\ \vdots \\ 0_{m \times 1} \\ L_g L_f^{\rho-1} h(x) u(t) \end{bmatrix} \end{aligned}$$

The derivative of the performance index of (8) with respect to command  $u(t)$  gives:

$$\frac{d\mathfrak{J}}{du} = -G^T(x)[\Pi_1 \quad \Pi_2]\Psi(x) + G^T(x)\Pi_2 G(x)u(t) \quad (9)$$

where

$$\begin{cases} G(x) = L_g L_f^{\rho-1} h(x) \\ \Pi_1 = \begin{bmatrix} \frac{\bar{T}^{\rho+1}}{(\rho+1)!} & \frac{\bar{T}^{\rho+2}}{(\rho+1)!} & \frac{\bar{T}^{\rho+3}}{2!(\rho+1)!} & \dots & \frac{\bar{T}^{2(\rho+1)-1}}{\rho!(\rho+1)!} \end{bmatrix} \\ \Pi_2 = \frac{\bar{T}^{2(\rho+1)}}{(\rho+1)!(\rho+1)!} \end{cases}$$

The necessary condition for the optimal control over the prediction horizon is given by:

$$\frac{d\mathfrak{J}}{du} = 0 \quad (10)$$

From (9) and (10), it follows that the optimal control can be derived as follows:

$$u(t) = G^{-1}(x)K(T)\Psi(x) \quad (11)$$

The matrix  $K$  is given by:

$$\begin{cases} K(T) = [K_0 \ K_1 \ \cdots \ K_\rho \ I_d] = [\Pi_2^{-1}\Pi_1 \ I_d] \\ K_j = \frac{(\rho+1)!}{j!} \bar{T}^{-(\rho-1+j)}; j \in [0, \dots, \rho] \end{cases} \quad (12)$$

The nonlinear predictive controller (11) contains an integral action. Hence, if the closed loop system is stable, the proposed controller eliminates completely the steady state error regardless the presence of unknown perturbations and mismatched parameters.

### B. Stability analysis

The stability of the closed-loop system can be illustrated by proving the convergence of the output tracking error to the origin.

Combining (7) with the controller (11) yields:

$$K_0 \int_0^t e(\tau) d\tau + K_1 e(t) + K_2 \dot{e}(t) + \cdots + e^{(\rho)}(t) = 0 \quad (13)$$

From (13), it follows that the characteristic polynomial matrix equation of the closed loop system is as follows:

$$s^{\rho+1} + K_\rho s^\rho + K_{\rho-1} s^{\rho-1} + \cdots + K_1 s + K_0 = 0 \quad (14)$$

The condition of the stability can be established by calculating the roots of the above polynomial matrix for each input relative degree  $\rho$ . For  $\rho=1$  to 4, these roots are given respectively by (15) to (18) hereafter.

$$s_{1,2} = \frac{-1 \pm j}{T} \quad (15)$$

$$s_1 = -\frac{1.5961}{T}; \quad s_{2,3} = \frac{-0.7020 \pm j1.8073}{T} \quad (16)$$

$$s_{1,2} = \frac{-0.2706 \pm j2.5048}{T}; \quad s_{3,4} = \frac{-1.7294 \pm j0.8890}{T} \quad (17)$$

$$\begin{cases} s_{1,2} = \frac{0.2398 \pm j3.1283}{T}; \quad s_3 = -2.1806 \\ s_{4,5} = \frac{-1.6495 \pm j1.6939}{T} \end{cases} \quad (18)$$

Since the predictive time is positive, the real parts of the roots are negatives only for  $\rho < 4$ . Therefore, the closed loop system is stable if the relative degree  $\rho \leq 3$ . Moreover, it can be shown that a smaller predictive time will result in a fast response at the expense on the control effort due to the high controller gain. Reducing the controller gain by increasing the predictive time may cause high oscillations to appear or, even worse, render the system unstable.

### C. Limitation of the control effort

When the dynamic trajectory is changing very fast, the control input may saturate immediately, and the integral part in the controller may cause high oscillations to appear. To avoid this drawback, an anti-windup compensator is introduced in the controller (11).

For the RNGPC, if saturation should occur, an integral component  $\bar{u}(t)$  is added to the control in order to compensate the saturation's effect by reducing the effect of the integral action  $I(t)$  [24]. This leads to the following controller:

$$u(t) = G^{-1}(x)(K(T)\Psi(x) + \bar{u}(t)) \quad (19)$$

where

$$\bar{u}(t) = -\mu K_0 \int_0^t (u(\tau) - u^{ref}(\tau)) d\tau$$

$\mu$  is an  $(m \times m)$  diagonal matrix with parameters are  $> 1$ .

$u^{ref}(t)$  is the effective control provided by the saturation block. Its expression is given by:

$$u^{ref}(t) = sat(u(t)) = \begin{cases} u(t) & \text{if } u_{\min} \leq u(t) \leq u_{\max} \\ u_{\min} & \text{if } u(t) < u_{\min} \\ u_{\max} & \text{if } u(t) > u_{\max} \end{cases}$$

## IV. CASCADED RNGPC FOR A PMSM

Fig. 1 depicts a cascaded RNGPC for a PMSM. This structure allows to directly limiting the armature phase currents using saturation blocks. The initial system (1) is decomposed into two sub-systems in a cascaded form. The inner loop is used to regulate the currents by acting on the armature voltage, whereas the outer loop is employed to track the speed reference by considering the  $q$ -axis current as the input control.

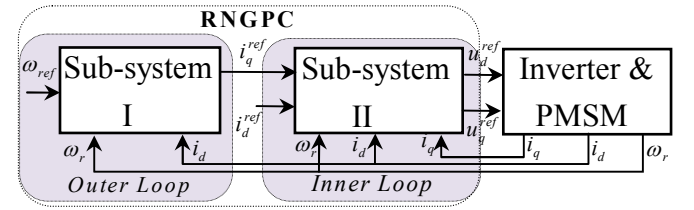

Fig. 1. Cascaded structure of the RNGPC

### A. RNGPC for the inner loop

The predictive control is applied to the electrical equations in order to provide the components of the armature voltage which minimizes the difference between the current component and the current reference. From (1), it follows that the electrical equations can be expressed as:

$$\begin{cases} \dot{x} = f(x, \omega_r) + gu(t) \\ y(t) = h(x) \end{cases} \quad (20)$$

The state vector  $x$  is composed of the  $d$ -axis and  $q$ -axis components of the armature current ( $i_d, i_q$ ). The input vector  $u$  is made of the  $d$ -axis and  $q$ -axis components of the armature voltage ( $u_d, u_q$ ). The output vector  $y$  consists of the  $d$ -axis and  $q$ -axis components of the armature current ( $i_d, i_q$ ), while  $f$  and  $g$  are defined as

$$f(x, \omega_r) = \begin{bmatrix} -\frac{R}{L_d} i_d + \frac{L_q}{L_d} p \omega_r i_q \\ -\frac{R}{L_q} i_q - \frac{L_d}{L_q} p \omega_r i_d - \frac{\phi_r p \omega_r}{L_q} \end{bmatrix}; \quad g = \begin{bmatrix} \frac{1}{L_d} & 0 \\ 0 & \frac{1}{L_q} \end{bmatrix} \quad (21)$$

The input relative degree of the outputs is  $\rho = 1$ , since the control appears in the first derivative. Therefore, the inner loop under the RNGPC is asymptotically stable. Consequently, the controller given by (19) can be applied easily to track the desired trajectory of the components of current under the constraints on the armature voltage.

### B. RNGPC for the outer loop

The predictive control is applied to the equation of motion in order to provide the optimal  $q$ -axis current reference under the constraints on the armature phase currents. The mechanical equation is given by:

$$\begin{cases} \dot{x} = f(x) + g(i_d)u(t) \\ y = h(x) \end{cases} \quad (22)$$

$x$  and  $u$  are respectively the rotor speed  $\omega_r$  and the  $q$ -axis component of the armature current  $i_q$ ; the output  $y$  is rotor speed  $\omega_r$ , while  $f$  and  $g$  are defined as

$$\begin{cases} f(x) = -\frac{B}{J}\omega_r \\ g(i_d) = \frac{p}{J}(\phi_v + (L_d - L_q)i_d) \end{cases} \quad (23)$$

It can be shown that the input relative degree of the outer loop is  $\rho=1$ . Hence, the controller (19) can be applied easily to track the desired speed reference despite the saturation.

## V. LABORATORY TEST SETUP

A laboratory prototype is developed to experimentally test the validity of the proposed RNGPC scheme for a PMSM drive. This scheme is shown in Fig. 2. Fig. 3 depicts the experimental setup, which consists of a 10-pole, 0.25 kW, 7A and 42V PMSM coupled to a permanent magnet DC generator, a speed sensor, an IGBT inverter and a dSPACE DS1104 board.

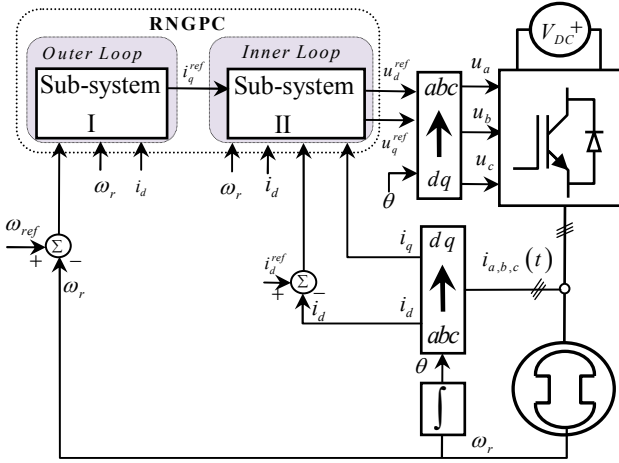

Fig. 2. Block diagram of the proposed RNGPC scheme for a PMSM.

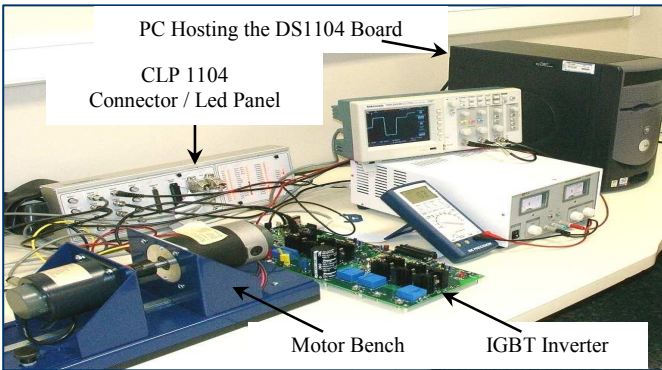

Fig. 3. Laboratory test setup.

The DS1104 board is a powerful and popular tool for rapid control prototyping and for Hardware-in-the-Loop (HIL) applications. It is equipped with two processors: Motorola MPC8240 processor (master) with PPC 603e core and on-chip peripherals, 250 MHz and a Texas Instruments TMS320F240 DSP (slave), 20 MHz.

The proposed RNGPC algorithm has been implemented on the main processor. The control sampling frequency is set equal to 10 kHz. The slave unit has been dedicated to the PWM signals generation unit, whose modulation frequency is set to 50 kHz, and to the management of the digital I/O signals.

## VI. EXPERIMENTAL RESULTS

The load torque  $T_L$  is an unknown disturbance, and the slope of the speed reference is chosen bigger than the maximum acceleration of the drive such that the current reference exceeds the maximum value in the transient. In this case, the saturation blocks are switched on in order to limit the current. The predictive time for the inner loop is taken as  $T_1=5T_s=0.5\text{ms}$ , whereas the predictive time for the outer loop is chosen as  $T_2=50*T_s=5\text{ms}$ . The  $(m \times m)$  matrix  $\mu$  is chosen as follows:

$$\mu(\text{Inner loop}) = \begin{bmatrix} 10 & 0 \\ 0 & 10 \end{bmatrix}; \mu(\text{External loop}) = 10$$

### A. Performance evaluation of the anti-windup compensator

Fig. 4 and 5 give the speed response respectively without (controller given by (11)) and with (controller given by (19)) the use of an anti-windup compensator. As shown in Fig. 4, the controller eliminates the steady state error, but results in a large overshoot due to the saturation's effects. Fig. 5 shows that the overshoot observed in the previous test is eliminated and the settling time is improved.

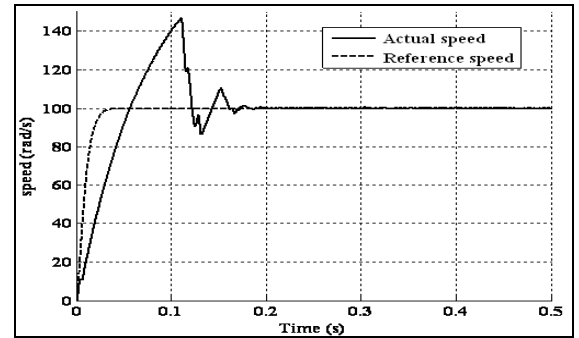

Fig. 4. Speed response without an anti-windup scheme

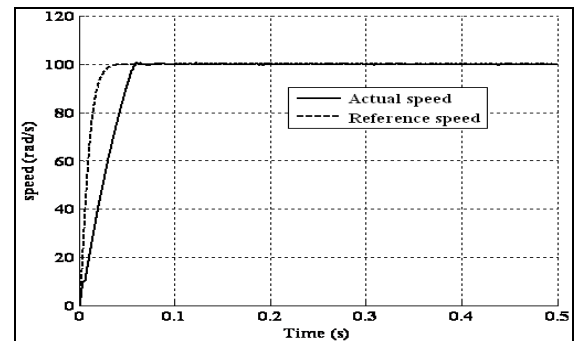

Fig. 5. Speed response with an anti-windup scheme

### B. Tracking performance under unknown load torque

This test is concerned with bidirectional speed control under variable load torque. According to the field oriented control, the  $d$ -axis current is forced by the control action to zero value. Fig. 6 gives the speed response. The response is characterized by strong dynamics, and the steady state error

is well removed. Moreover, no overshoot appears in the transient time despite limitation of current.

Fig. 7 gives the  $dq$ -axis components of the armature current waveforms. As shown, the field oriented control is satisfactorily guaranteed by maintaining the  $d$ -axis current null. The transient state of  $q$ -axis component is well controlled. Fig. 8 gives the waveform of the instantaneous armature phase current. As shown, the peak-value of the armature current is smaller than the imposed limit during transients.

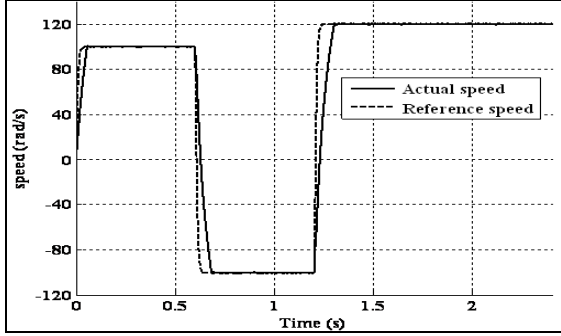

Fig. 6. Rotor speed trajectory tracking.

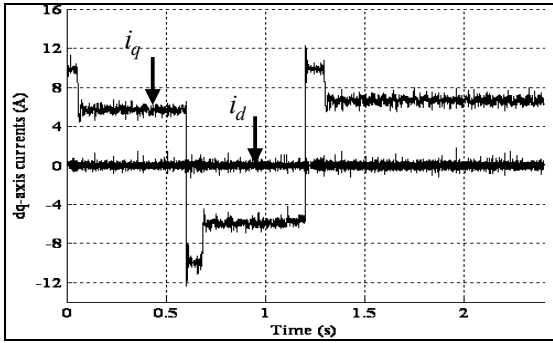

Fig. 7.  $dq$ -axis components of the armature current

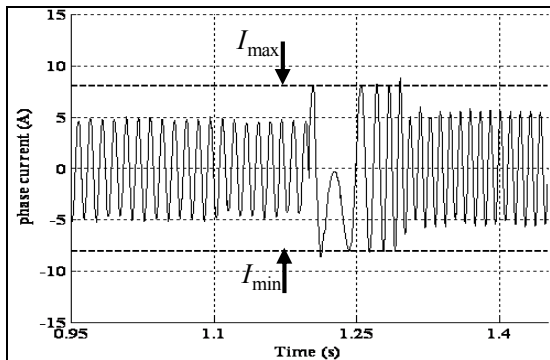

Fig. 8. Armature phase current waveform

### C. Uncertainty in the electrical parameters

To verify the robustness of the drive using the proposed RNGPC, three electrical parameters are varied in the control law at  $t = 0.5$ s. The values of the rotor flux linkage, the armature resistance and the  $q$ -axis inductance were rapidly increased respectively by 50%, 80% and 50%. The  $d$ -axis current is forced by the control to a non-null value. This permits to test the sensitivity of the  $d$ -axis current regulation against the variation of the electrical resistance. Indeed, the  $d$ -axis current reference is chosen equal to -1. In addition, the motor was started under unknown load torque.

Fig. 9 shows that the steady state error disappears quickly despite changes in the electrical parameters and magnetic flux linkage. As shown in Fig. 10, the  $d$ -axis current regulation is insensitive to the variation of the parameters.

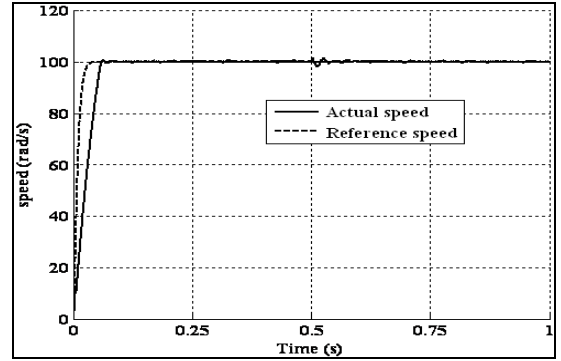

Fig. 9. Speed response under uncertainty in the electrical parameters

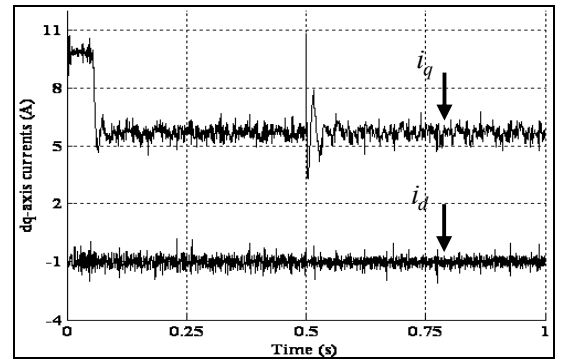

Fig. 10  $dq$ -axis components of the armature current response under uncertainty in the electrical parameters

### D. Uncertainty in the mechanical parameters

To verify the robustness of the proposed controller against the variation of the mechanical parameters, the values of the coefficient of friction and the moment of inertia were decreased rapidly by 80% at  $t = 0.5$ s. Fig.11 shows that the steady state error is eliminated and precise speed tracking is achieved.

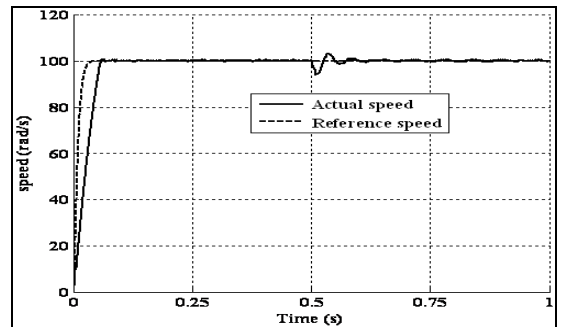

Fig. 11 Speed response under uncertainty in the mechanical parameters

### E. Performance evaluation under quick load torque change

To verify the robustness of the proposed controller against the variation of the load torque, the value of load was rapidly increased by 100% at  $t = 0.5$  s. Fig. 12 and 13 give respectively the rotor speed trajectory tracking and the  $dq$ -axis components of the armature current. As shown, the steady state error is quickly removed under a sudden change of the load torque.

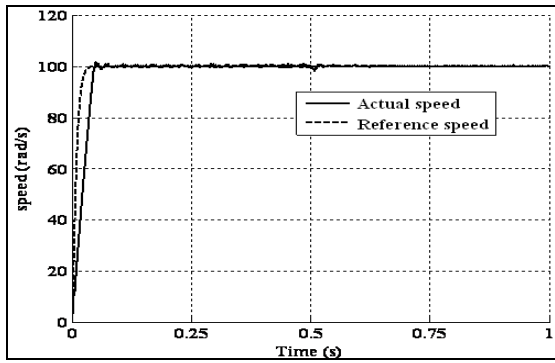

Fig. 12. Rotor speed response under load torque variation

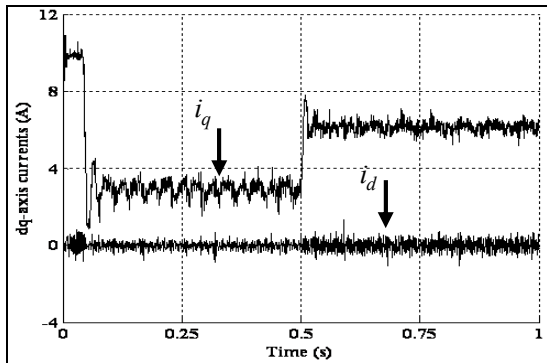

Fig. 13.  $dq$ -axis components of the armature current response under load torque variation.

## VII. CONCLUSION

A robust nonlinear generalized predictive controller (RNGPC) for a permanent magnet synchronous motor (PMSM) has been presented. The objective of the proposed controller is to track the rotor speed trajectory while regulating the  $d$ -axis current in the presence of load torque and mismatched parameters. To this end, the existing NGPC is revised and a nonlinear predictive law is developed by using a newly defined design cost function. The proposed RNGPC contains an integral action, which guarantees zero steady state error as long as the closed loop system is stable. Furthermore, when the control effort is limited due to saturation, an anti-windup scheme is suggested to suppress the undesired side effect caused by the integral action.

A laboratory prototype was developed to experimentally test the validity of the proposed controller. Experimental results have shown its effectiveness regarding speed trajectory tracking and robustness.

## REFERENCES

- [1] Y. Zhang, C.M. Akujubi, W.H. Ali, C.L. Tolliver and L.-S. Shieh, "Load Disturbance Resistance Speed Controller Design for PMSM," *IEEE Transactions on Industrial Electronics*, vol. 53, no. 4, June, 2006, pp. 1198-1208.
- [2] Y. Zhang, L.-S. Shieh, C. Akujubi and X. GU, "Observer-based load disturbance compensation for motor drive with DSP implementation," *IEEE-IES, 31<sup>st</sup> Annual Meeting*, 6-10 November, 2005, pp. 1486 - 1491.
- [3] X. Dongmei, Q. Daokui and X. Fang, "Design of  $H_{\infty}$  Feedback Controller and IP-position Controller of PMSM Servo System," *IEEE International Conference, Mechatronics and Automation*, vol. 2, no. 29, 29 July - 1 Aug, 2005, pp. 578-1108.
- [4] K.-H. Kim and M.-J. Youn, "A simple and robust digital current control technique of a PM synchronous motor using time delay control approach," *IEEE transactions on power electronics*, vol. 16, no. 1, January 2001, pp. 72-77.
- [5] Y. Abdel-Rady, and I. Mohamed, "Design and implementation of a robust current-control scheme for a PMSM vector drive with a simple adaptative disturbance observer," *IEEE transactions on industrial electronics*, vol. 54, no. 4, August, 2007, pp. 1981-1988.
- [6] J. Solsona, M.I. Valla and C. Muravchik, "Nonlinear control of a permanent magnet synchronous motor with disturbance torque estimation," *IEEE Transaction on Energy Conversion*, vol. 15, no. 2, June, 2000, pp. 163 - 168.
- [7] Y. Abdel-Rady and I. Mohamed, "A Newly Designed Instantaneous-Torque Control of Direct-Drive PMSM Servo Actuator with Improved Torque Estimation and Control Characteristics," *IEEE transactions on industrial electronics*, vol. 54, no. 5, October, 2007, pp. 2864-2873.
- [8] C.E. Garcia, D.M. Prent and M. Morari, "Model predictive control: theory and practice - A survey," *Automatica*, vol. 25, no. 3, 1989, pp. 335-348.
- [9] M. Morari, E. zafiriou "Robust process control," *Dunod*, 1989.
- [10] L. Magni, R. Scattolini, "Robustness and robust design of MPC for nonlinear discrete-time systems," *Assessment and Future Directions of NMPC*, Berlin, Springer-Verlag pp. 239-254.
- [11] P. Lu, "Optimal Predictive Control of Continuous Nonlinear Systems," *International Journal of Control*, vol. 62, no. 1, 1995, pp. 633-649.
- [12] P. Lu, "Nonlinear Predictive Controllers for Continuous Systems," *Journal of Guidance, control and Dynamics*, vol. 17, no.3, 1994, pp. 553-560.
- [13] W.-H. Chen, "Optimal Control of Nonlinear Systems: A Predictive Control Approach," *Automatica*, vol. 39, no. 4, 2003, pp. 633-641.
- [14] W.-H. Chen, D.J. Balance, P.J. Gawthrop, J.J. Gribble and J. O'Reilly, "Nonlinear PID predictive controller," *IEE Proceedings Control Theory application*, vol. 146, no. 6, 1999, pp. 603-611.
- [15] W. Feng, J. O'Reilly and D.J. Balance, "MIMO Nonlinear PID Predictive Controller," *IEE Proceedings Control Theory application*, vol. 149, no. 3, 2002, pp. 203-208, 20
- [16] R. Hedjar, R. Toumi, P. Boucher and D. Dumur, "Cascaded nonlinear predictive control of induction motor," *Proceeding of the IEEE Conference on control Applications*, Anchorage, Alaska, USA, 2000, pp. 698-703.
- [17] R. Hedjar, R. Toumi, P. Boucher and D. Dumur, "Two Cascaded nonlinear predictive control of induction motor," *IEEE Conference on control Applications*, Vol. 1, Istanbul, Turkey, 2003, pp. 458-463.
- [18] R. Hedjar, P. Boucher, "Nonlinear Receding-Horizon Control of Rigid Link Robot Manipulators," *International Journal of Advanced Robotic Systems*, vol. 2, no. 1, 2005, pp. 015-024.
- [19] R. Hedjar, R. Toumi, P. Boucher and D. Dumur, "Finite horizon nonlinear predictive control by the Taylor approximation: application to robot tracking trajectory," *International Journal of Applied Mathematics & Computer Sciences*, vol. 15, no. 4, 2005, pp. 527-540.
- [20] R. Hedjar, "Robust Nonlinear Speed Control of PM Synchronous Motor," *International conference on communication, computer & power*, Muscat, 19-21 February, 2007.
- [21] L.-B. Li, H.-X. Sun, J.-D. Chu, G.-L. Wang, "The predictive control of PMSM based on state space," *IEEE Proceedings of the second International Conference on Machine Learning and Cybernetics*, vol. 2, November, 2003, pp. 859-862.
- [22] S. Hassaine, S. Moreau, C. Ogebe, B. Mazari, "Robust Speed Control of PMSM using Generalized Predictive and Direct Torque Control Techniques," *IEEE International symposium on Industrial Electronics*, June 9-13, 2007, pp. 1213-1218.
- [23] S. Bolognani, L. Peretti, and M. Zigliotto, "Design and Implementation of Model Predictive Control for Electrical Motor Drives," *IEEE Transactions on Industrial Electronics*, vol. 56, n. 6, June 2009, pp. 1925-1936.
- [24] J.W. Choi and S.C. Lee, "Antiwindup Strategy for PI-Type Speed Controller," *IEEE Transactions on Industrial Electronics*, vol. 56, n. 6, June 2009, pp. 2039-2046.