

ABSTRACT

Title of Document: THE BLUE HERON CONFERENCE CENTER
AT TRITON BEACH

David Brendan Tudryn, M.ARCH, 2008

Directed By: Professor Emeritus William Bechhoefer, FAIA,
School of Architecture

Along the quiet waters of the Chesapeake is a long-forgotten beachfront park called Triton Beach. Since the 1950's its buildings have been abandoned, slowly succumbing to the Bay's high tides and persistent coastal vegetation. The tract is nearly four hundred acres and contains valuable wetlands which contribute to the beauty of the Chesapeake. But without funding to repair the shore line, this area is in danger of eroding into the Chesapeake. Through a public-private initiative, a small parcel of this property will be allocated to construct a conference center. The small scale of a conference center facility will allow this project to be developed at a finite level and the building details will be the emphasis of the exercise. The delicate nature of the site demands caution and steps will be taken to preserve the natural beauty of the waterfront as viewed from both the park and the Bay.

THE BLUE HERON CONFERENCE CENTER AT TRITON BEACH

By

David Brendan Tudryn

Thesis submitted to the Faculty of the Graduate School of the
University of Maryland, College Park, in partial fulfillment
of the requirements for the degree of
Master of Architecture
2008

Advisory Committee:

Professor Emeritus William Bechhoefer, FAIA, Chair

Professor Richard A. Etlin, Ph.D., FAAR

Professor Gary Bowden

Dedication

For my daughters Courtney and Alyssa; and for Pamela who always managed to keep
the ship on an even keel.

Acknowledgements

This work has experienced a long detour on the way to completion. The fact that it's finished has less to do with my own perseverance and more to do with the encouragement of the faculty at the University, my fellow colleagues, and most importantly my family. Many thanks to Professor Mark McInturff, FAIA for introducing me to Bohlin Cyminski Jackson Architects, Centerbook Architects and others whose coherent assembly of materials foster a sensuality of place; and to Professor Bechhoefer who introduced me to the beauty of Japanese joinery and detailing. And thanks to Professor Ralph Bennett, who encouraged me to carefully illustrate my observations in sketchbooks. Eleven sketchbooks later I've found their worth, and the skills I've learned while sketching have been invaluable to the completion of this thesis. And thanks to my original thesis committee, Professor Bechhoefer, Professor Etlin and Professor Guido Francescato who each observed my interests and guided me towards a project that enabled me to focus on what I enjoyed most about my years at Maryland. And a special thanks to Wes Gardner, a fellow architecture student and constant studio companion who shares my love for sailing on the Chesapeake and who was always around for encouragement. Perhaps we'll meet again.

Table of Contents

Dedication.....	ii
Acknowledgements.....	iii
Table of Contents.....	iv
List of Tables.....	vi
List of Figures.....	vii
Chapter 1: Introduction.....	1
Chapter 2: Site Analysis.....	3
Site Location.....	3
Site Boundaries.....	4
Neighborhood Character/Density.....	6
Traffic Flow.....	10
Existing Site Structures.....	11
Vegetation.....	13
Topography and Land Features.....	17
Sun Path and Prevailing Winds.....	19
Additional Site Features.....	21
Past Uses.....	21
Zoning.....	26
Other General Conclusions.....	29
Chapter 3: Program.....	35
Program Comparisons.....	43
Conference Center Program by Rooms and Areas.....	44
Guestrooms.....	44
Main Entry Lobby.....	46
Amphitheater.....	46
Conference Areas.....	47
Breakout Rooms.....	48
Dining Area.....	48
Recreation Areas.....	48
Final Program.....	52
Chapter 4: Precedent.....	53
Conference Centers.....	53
Buildings in the Landscape.....	58
Vernacular Forms.....	66
Details of Assembly.....	67
Chapter 5: Design Approach.....	71
Concept 1.....	71
Concept 2.....	73
Concept 3.....	75
Chapter 6: Design Conclusion.....	77
Sensitivity to the Natural Landscape.....	77
Utilization of Vernacular architecture.....	90

Image-able and Intimate Space	93
Attention to Detailing	99
Bibliography	118

List of Tables

Table 1: Sample Programs, University Conference Centers	43
---	----

List of Figures

Figure 1: Site Location Plan.	3
Figure 2: Neighborhood and Project Site Boundaries.	5
Figure 3: Photo of Beverly-Triton Beach Park Looking South (edge of project site)..	6
Figure 4: Typical Housing Typologies within the Adjacent Neighborhoods.	7
Figure 5: Neighborhood Densities.	9
Figure 6: Existing Roads.	11
Figure 7: Aerial Photograph taken in 1952.	14
Figure 8: Aerial Photograph taken in 1991.	15
Figure 9: Vegetation.	16
Figure 10: Site Topography.	18
Figure 11: Sun Path and Prevailing Winds.	20
Figure 12: The Beachfront Pavilions.	23
Figure 13: Viewpoints.	24
Figure 14: General Site Features.	25
Figure 15: Existing Neighborhood Zoning.	30
Figure 16: Proposed Site after Proposed Re-Zoning.	31
Figure 17: Photo of Triton Beach Park Looking South.	32
Figure 18: Photo of Triton Beach Looking North.	32
Figure 19: Photo of Approach Road.	33
Figure 20: Photo of Access Road.	33
Figure 21: Photo of Remnants of Steel Buildings.	34
Figure 22: Photo of Inside of Old Steel Buildings.	34
Figure 23: The Marigold Lodge Footprint on the Project Site.	37
Figure 24: The Minnowbrook Lodge Footprint on the Project Site.	38
Figure 25: The Council House Footprint on the Project Site.	39
Figure 26: The GE Management Institute Footprint on the Project Site.	40
Figure 27: The GTE Development Center Footprint on the Project Site.	41
Figure 28: The IBM Advanced Business Institute Footprint on the Project Site.	42
Figure 29: Samples of Guest Room Layouts.	45
Figure 30: Amphitheatre from the Steinberg Center, University of Pennsylvania.	47
Figure 31: Application of Program Areas Relative to the Site.	50
Figure 32: Room Adjacencies.	51
Figure 33: IBM Advanced Business Institute. Plan Configuration.	54
Figure 34: IBM Advanced Business Institute. Break-out Rooms.	55
Figure 35: IBM Advanced Business Institute. Original Sketch of Dining Area.	56
Figure 36: IBM Advanced Business Institute. Original Sketch of Exterior.	57
Figure 37: Fallingwater, Bear Run, Pennsylvania. Original Sketch.	59
Figure 38: Salk Institute, La Jolla, California. Original Sketch.	60
Figure 39: Lake Washington House, Seattle. Original Sketch.	61
Figure 40: Pool Pavilion in Pennsylvania. Original Sketch.	62
Figure 41: Katsura Villa, Japan. Original Sketch.	63
Figure 42: Katsura Villa, Japan-Delineation of Building Edge. Original Sketch.	64
Figure 43: Katsura Villa, Japan-Shoji Screens. Original Sketch.	65

Figure 44: Driftwood Washed up Along the Chesapeake Bay	66
Figure 45: Stone Breakwaters along the Chesapeake.	67
Figure 46: Vanity and Towel Rack, Bohlin Cywinski Jackson. Original Sketch.....	68
Figure 47: Japanese Joinery – Shiribasami tsugi (scarf joint).	69
Figure 48: A Lattice Window of a Merchant’s House - Takayama, Japan.....	70
Figure 49: Concept 1 Sketch.....	71
Figure 50: Design Concept 1- Site Plan.....	72
Figure 51: Concept 2 Sketch.....	73
Figure 52: Design Concept 2 – Site Plan.	74
Figure 53: Design Concept 3.	75
Figure 54: Design Concept 3 – Site Plan.	76
Figure 55: Bird’s-Eye View.....	79
Figure 56: Partial Enlargement of Bird’s-Eye View.....	80
Figure 57: Site Plan.....	81
Figure 58: Partial Enlargement of Site Plan.	82
Figure 59: Garden-Level Plan.....	83
Figure 60: Partial Enlarged View of Garden-Level Plan.....	84
Figure 61: 2 nd Level Plan.	85
Figure 62: Residence Buildings- Plans and Elevations.	86
Figure 63: View of Walkway around the Residential Court.....	87
Figure 64: View from Entrance Drive.	88
Figure 65: Porte Cochere.	89
Figure 66: Library.....	92
Figure 67: Reception Area.	95
Figure 68: Detail of Breakout Room.	96
Figure 69: Amphitheatre.	97
Figure 70: View from the Porch towards the Chesapeake.....	98
Figure 71: Column Connection Detail.....	100
Figure 72: Exposed Masonry Tie Detail.....	101
Figure 73: Bench Detail with Built-In HVAC Distribution.....	102
Figure 74: 2 nd Floor Wall Detail at Windows.....	103
Figure 75: Scupper Detail at Trellis Support.	104
Figure 76: Typical Post Base Detail.	105
Figure 77: Structural Framing Details.	106
Figure 78: Courtyard Details.	107
Figure 79: Walkway Lighting.....	108
Figure 80: Sliding Door Details for Break-Out Room.....	109
Figure 81: Structural Support at Tower.	110
Figure 82: Framing Assembly.	111
Figure 83: Dining Room.	112
Figure 84: Courtyard Wall Section and Assembly Detail.	113
Figure 85: Partial Wall Elevation.	114
Figure 86: Site Section, (Illustration Broken into Four Parts).....	115
Figure 87: Cross Section Looking South.	115
Figure 88: Cross Section Looking North.	116
Figure 89: Front Elevation.....	116

Figure 90: Enlargement of South Courtyard Wall.....	116
Figure 91: Tower – Garden Level Plan.....	117
Figure 92: Tower – Second and Third Level Plans.	117

Chapter 1: Introduction

The Chesapeake Bay offers hundreds of miles of coastline, much of it within reach of the Baltimore and Washington DC metro areas. Unfortunately, a significant amount of waterfront property appears to be in hands of private owners, affording very little public use. The beauty of the Bay and its shores are worth sharing, and it would seem that more interactive exposure to the Bay would help local environmental foundations spread the word about the health of the Bay and spawn a stronger sense of ownership by its waterfront residents. Beverly-Triton Beach, just a few towns south of Annapolis, is an abandoned park that has not been used for years. The park is strategically located amongst three suburban neighborhoods, all of which show potential for growth and would benefit from a public recreation area on the Bay. A revitalization of such a park would be an excellent opportunity to better share the Chesapeake.

There is at least one local example of a successful waterfront park which has become a valuable asset to nearby Annapolis. Quiet Waters Park is situated between the South River and Harness Creek and offers walking trails, water vistas, boating, playgrounds and picnicking sites. Though quite popular to nearby residents, the park is costly to tax-payers: it has a yearly operating budget of \$500,000. (Jefferery Mauck, park ranger for Beverly-Triton Beach Park, personal interview by David Tudryn, October 15, 1996). It's not likely the residents around Beverly-Triton Beach Park, however, could easily afford to support a park for their neighborhood. In order to raise the necessary funds to renovate and maintain a park with features similar to Quiet Waters Park, part of the four hundred acres of Beverly-Triton Beach Park will

be allocated to the University of Maryland for the development of a non-profit conference center for use by the university as well as other governmental organizations. As a stipulation to the land transfer, the University will be responsible for overseeing the development of a park master plan and after its implementation will assume some of the yearly maintenance costs of the park.

A conference center is perhaps the most appropriate private building for the site because it requires a tranquil retreat setting that inspires not only un-distracted thought, but promotes relaxation. The calm waters of the Chesapeake and the serenity of the small lakes furnish a perfect setting for this type of program, and many precedents are available to examine how this relationship between building and site are made. In an effort to minimize impact on the natural aesthetic present along the Chesapeake Bay shoreline, design for the proposed conference center will entail a study of naturally occurring forms, materials and textures, as well as architecture considered to be vernacular for this waterfront area. Every opportunity will be made to make this building in context to the landscape, but at the same time provide the university with a comfortable, marketable, memorable building. The scale of the program will allow for the exploration of architectural detail at a finite level and provide an opportunity to examine building technique as an important tool in the design process.

Any other manipulation to the natural landscape for recreational purposes will be made in a manner that retains the current aesthetic and allows for both public and university use. The intention of this exercise after all, is too make a well designed, highly detailed, private building that also gives something valuable back to the public.

Chapter 2: Site Analysis

Project Coordinates: Latitude: 38°52'49.65" N, Longitude: 76°30'08.09" W

Site Location

The proposed site is located along the western shore of the Chesapeake Bay, just south of the South River in Mayo, Maryland. Mayo is approximately 18 miles from the Capital Beltway, 27 miles from downtown Baltimore, and 22 miles from the University of Maryland at College Park. Maryland Routes 50 and 214 provide direct access to the proposed site.

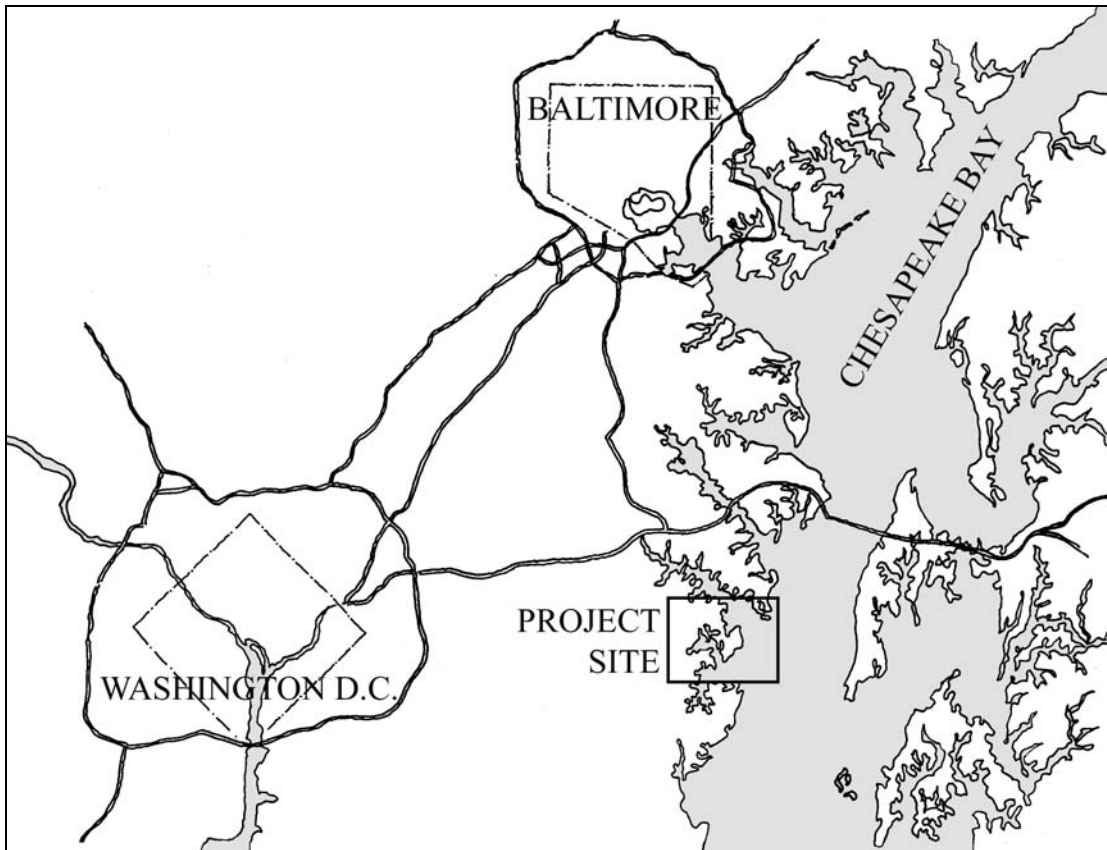

Figure 1: Site Location Plan.
Mayo is located just south of Annapolis within twenty-five miles of the two metropolitan beltways.

Not to Scale



Site Boundaries

Beverly-Triton Beach Park, a beachfront park facility once considered a thriving beach and recreation area, retains boundaries along its north edge at Triton Beach Road, its west edge at Cedar Avenue, its south edge at Grande View, and its east edge, of course, the Chesapeake Bay. A small width of the park also extends south of Grande View between the Bay and Chesapeake Avenue. Due to its proximity to the surrounding residential community, this narrow parcel appears to be the most highly utilized area of the park, attracting children on bicycles, dog-walkers, and fishermen. The location of the park between several residential areas makes it a potentially valuable asset to the community, one that at this time acts as more of a divider between communities due to its enormous size. At almost 400 acres, the park is currently too large to manage as an open public facility. Economic aid for development of the park as a public facility would not only help to create a new found amenity but also a critical civic link between the neighborhoods.

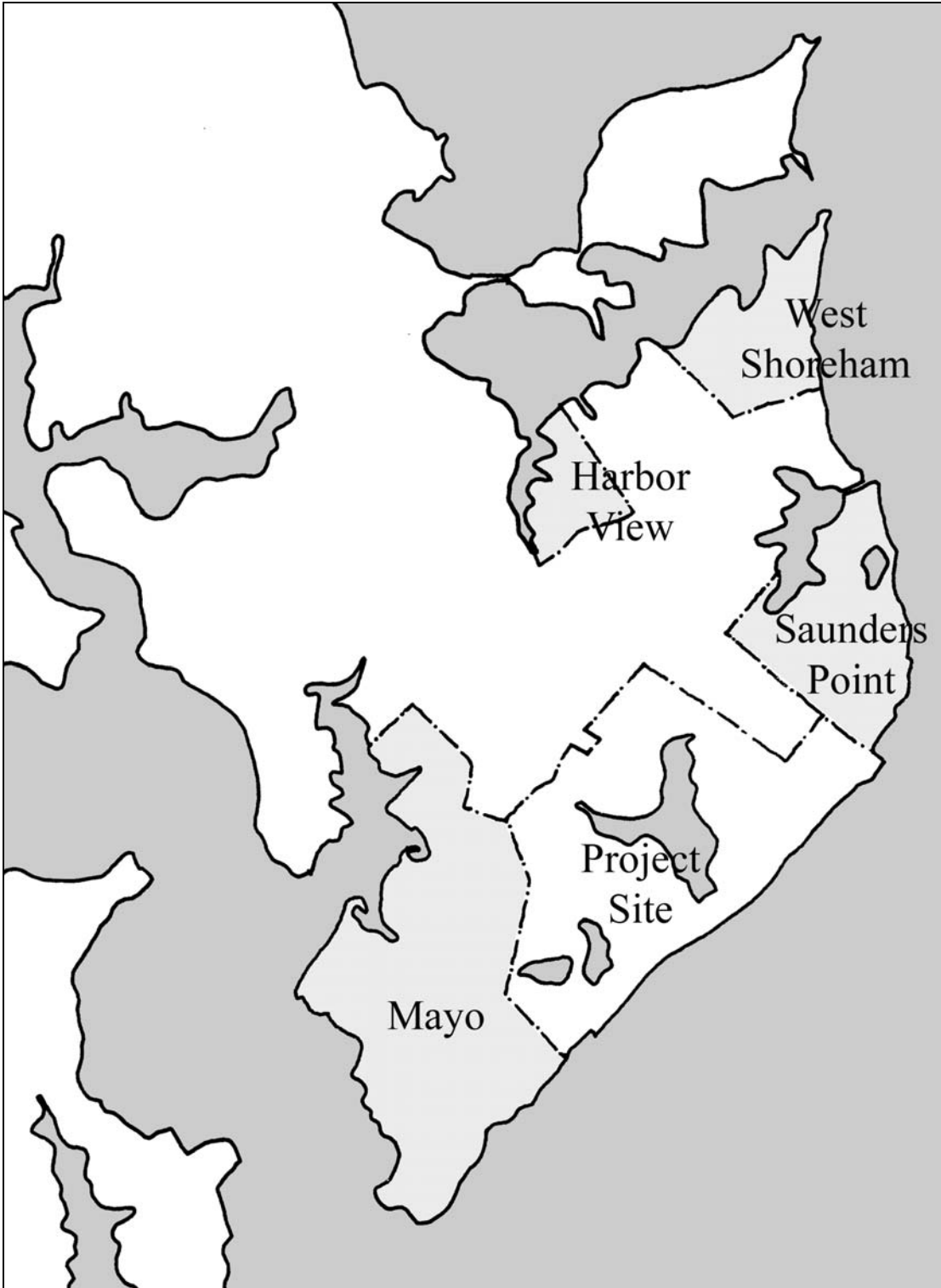

Figure 2: Neighborhood and Project Site Boundaries.

Scale: 1"=2000'-0"





Figure 3: Photo of Beverly-Triton Beach Park Looking South (edge of project site).

Neighborhood Character/Density

Mayo

The community of Mayo is almost entirely residential except for spotted commercial development along Route 214, the primary street. The town has a piecemeal grid layout with 150 foot wide blocks, permitting typical lot sizes of 75 feet by 30 feet. Most of the residences are single story bungalow-style dwellings built after World War II (See Figure 4). On average they are in fair condition, with little or no modern renovation having occurred. Several vacant lots are being developed, most of which are two story structures that take advantage of the adjacent lower residences and provide water views. Houses along the waterfront are also quite modest, but are generally modernized with larger windows and decks. Overall the

neighborhood seems to have suffered from some neglect but generally shows promise.

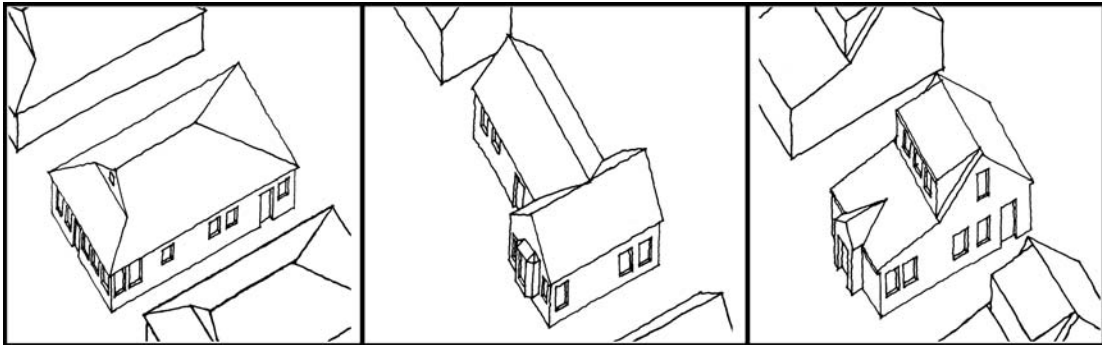

Figure 4: Typical Housing Typologies within the Adjacent Neighborhoods.

Saunder's Point

To the north of Beverly-Triton Beach Park there are several developments, including Saunder's Point, Harbor View and West Shoreham (see Figure 5). Neither Harbor View nor West Shoreham are directly adjacent the site, but both could still benefit from a nearby recreational area. Saunder's Point is a rather new development that shares the same access road as the north entry to the site. Because of its location of a peninsula, there is only one way in and out of the development, namely Triton Beach Road. The road is approximately 30 feet wide with large rights-of-way to either side, making expansion feasible. Houses in the neighborhood are marginally larger than those of Mayo, especially along the waterfront. Lot sizes are less regulated and vary considerably from deep, narrow sites along the water to the standard 75-foot by 30-foot lot inland. Saunder's Point is quite a bit smaller than Mayo and has the illusion of a more exclusive neighborhood. Real estate appears better maintained than most of Mayo, and the development of an adjacent park for its residences would surely make this small community thrive. A comfortable 500-foot

wooded buffer zone currently exists between the southernmost development and the parks north entry, permitting a reasonable separation in the event of use of this entry for recreational use.



Figure 5: Neighborhood Densities.
Beverly-Triton Park is shown in the center.

Scale: 1"=2000'-0"



Traffic Flow

The most direct entry to the site is Route 214 which runs along the northernmost edge of Mayo (see Figure 6). The scale of this route could easily accommodate additional traffic flow from the conference center, and because of the streets partially commercial nature would cause the least amount of impact to the area. Assuming the university conference center hosts only one event per week, increased traffic flow would be about 100 to 150 cars per week traveling in and out of the site. Because the center is indented as an 'all inclusive' establishment, minimal traffic flow should occur during a conference, but there will be some delivery service requirements. The refurbishment of the park would also increase traffic flow especially on weekends in the summer months. Calculation of an exact amount is not within the scope of this exercise. There is also a parcel suitable to provide additional parking spaces at the northern edge of the park boundary at Triton Beach Road. This area is already cleared and is immediately adjacent the north entry. Locating the access point to the new park to Triton Beach Road would also help to minimize impact on one specific neighborhood and prevent confusion between conference center and recreation area parking. Signs already direct beach traffic toward Triton Beach Road for access to Mayo Beach, a nearby public facility on the South river. Expansive right-of-way on this road would easily accommodate the overflow of traffic typical to hot summer weekends without interfering with private residential property. No infrastructure improvements would be necessary to Route 214 as the road is already wide enough to allow any increased traffic flow. Furthermore, since

most of the commercial development in Mayo occurs west of the Route 214 - Triton Beach Road split, shopkeepers would benefit equally from either proposed function.

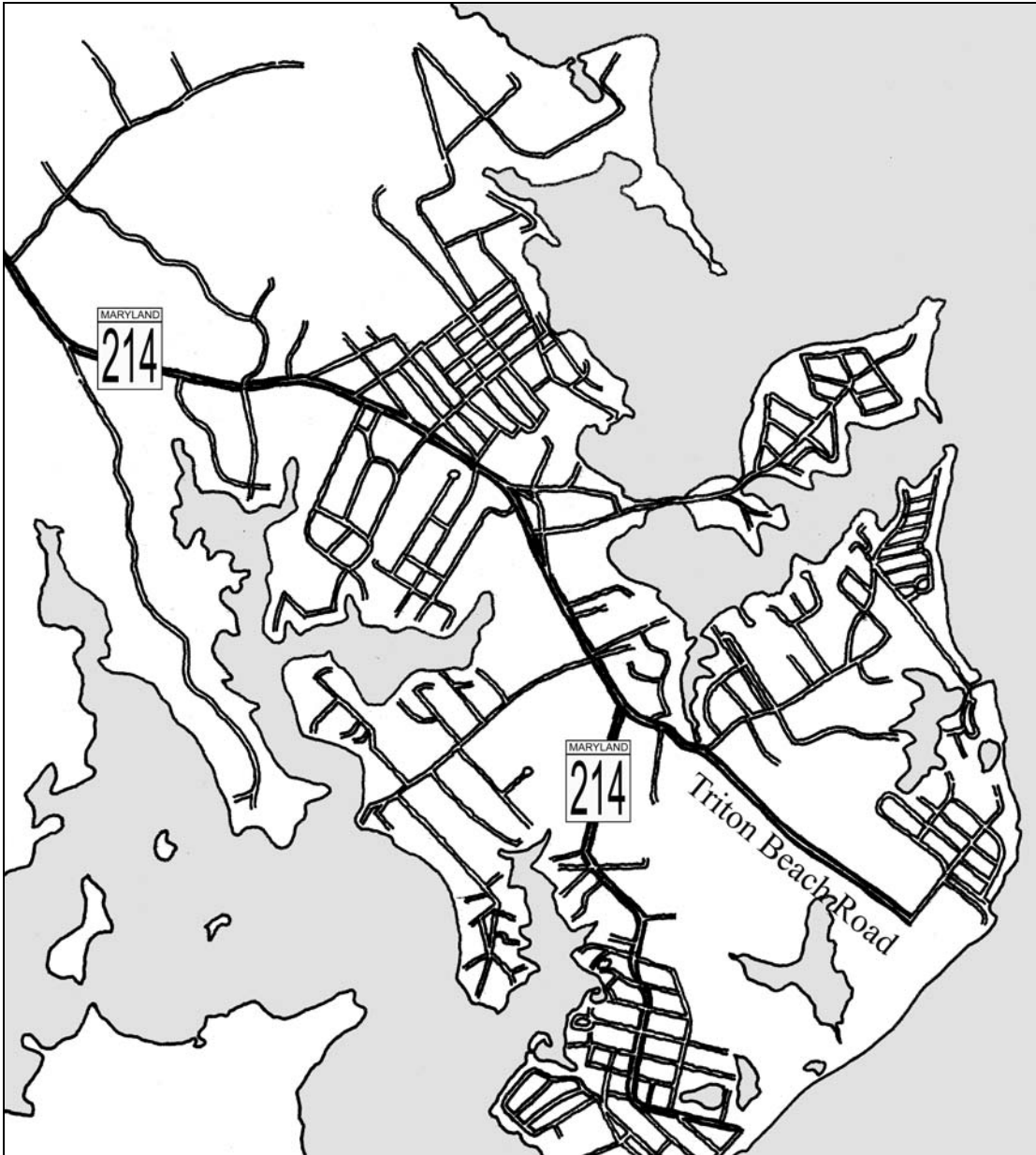

Figure 6: Existing Roads.
Route 214 connects the site directly to Route 50, providing direct access to the Washington metropolitan area.
Scale: 1"=2000'-0"



Existing Site Structures

Several pavilions exist along the edge of the Bay dating back to the 1950's (see Figure 12). Their current condition is fair to poor, with most of the structure

intact. In their present state they pose dangerous hazard to children that play along the nearby shoreline. The southernmost pavilion measures 80 feet by 70 feet and the other 250 feet by 60 feet with a 38 foot by 22-foot addition on the northern side. Both pavilions have low pitched roofs measuring 25 feet and 22 feet to the peaks, respectively. Although infill between the structural steel columns no longer exists, remnants of removable wooden panels with screens appear in stacks throughout the site. A clerestory of mostly broken glass panels runs along the bottom edge of the roof. Inside of the panels knee bracing laterally supports the 12-foot columns, and the connection is detailed delicately enough to imply that some time was taken in the development of a modest but playful aesthetic for the buildings. The long, squatty proportion of these buildings provides beautifully framed views outward to the Chesapeake Bay and the eastern shore.

After inquiring with a local resident on the history of Beverly-Triton Beach Park, it's clear that the past use of these pavilions was gambling casinos which once attracted hundreds of gamblers to Mayo in the summer months (anonymous Mayo resident, personal interview by David Tudryn, September 18, 1996). Gambling continued there until the 1960's when gambling was made illegal throughout Anne Arundel County and much of Maryland. The construction of the Bay Bridge twin span then enticed gamblers to the more grandiose scale of Atlantic City. The thriving nightlife of Mayo is long since gone, and the pavilions remain only as remnants of a more playful era. The immense scale and the relatively intact appearance of the existing pavilions warrant further study for inclusion into either the recreational or conference center programs of the park.

Vegetation

An aerial photograph taken in 1952 illustrates forestation of the site as it existed during the park's use as a large recreation area (see Figure 7). These areas of vegetation have since matured and are for the most part healthy. Areas showed cleared by the 1952 photograph have been repopulated by 1991 with trees and low ground cover appearing in equally good health (see Figure 8). Vegetation is both deciduous and evergreen. Tree canopies within the old growth rise to 50 feet with calipers ranging from several inches to about 16 inches. In the new growth areas, canopies rise to about 30 feet with calipers up to 9 inches (see Figure 9).

The current state of the vegetation does not imply any one specific area more suitable for development except for a 250-foot by 80-foot wide area consisting of tall grass that had been previously been cleared, likely by a forest fire. Because the area falls within the 100-foot required buffer area, (refer the section on zoning, this chapter) it is unsuitable for use but its existence would provide for breathtaking views outward to the Bay from within the site. Additionally, the parcel of land between Deep Pond and the Chesapeake is cleared, allowing for views over the pond outward to the bay (See viewpoints diagram, figure 11). In order to minimize deforestation and development costs, use of the current dirt road off Route 214 will be strongly considered as a main entry to the conference center facility.



Figure 7: Aerial Photograph taken in 1952.





Figure 8: Aerial Photograph taken in 1991.



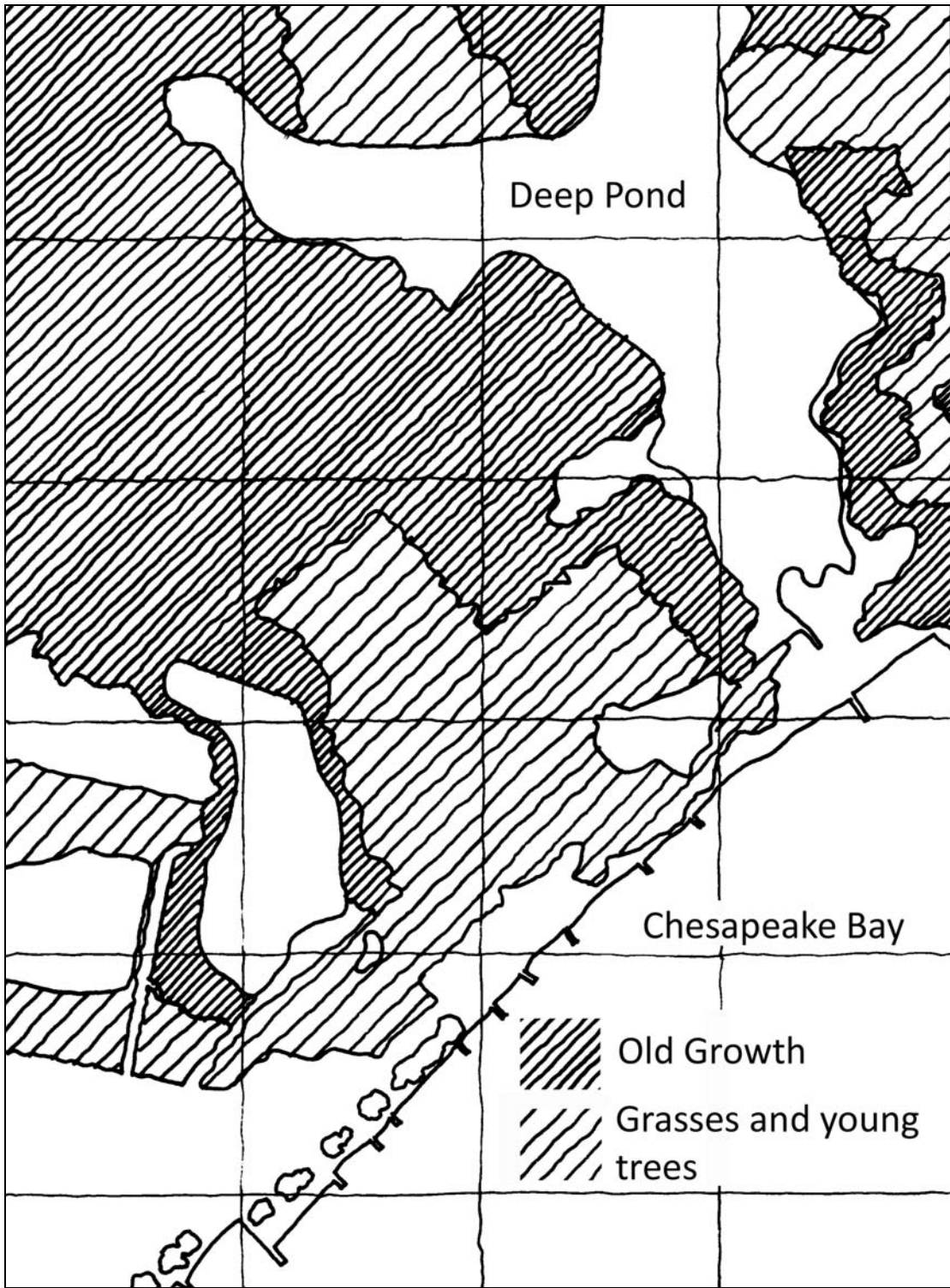

Figure 9: Vegetation.

Scale: 1"=400'-0"



Topography and Land Features

The proposed site ranges from 27 feet above sea level to 0 feet along the edge of the Chesapeake Bay. Grading is generally flat with the exceptions of the shorelines along the ponds and the bay. No significant slopes are detectable while walking the site, but grading percentages range from 3 to 20 percent overall. Two noticeable hilltops exist, one along the edge of the bay south of Deep Pond and the other at the southern edge of Deep Pond 500 feet inland (see Figure 10).

Current grading will easily accommodate the conference center facility without any significant grade changes occurring to constitute a sectional shift of the ground plane. The two existing hilltops may provide ideal points to place program space requiring views out to the Bay. Any significantly steep grading will be avoided, again to minimize impact to the existing site. Several steep edges occur along Deep pond, suggesting areas that are more suitable for elements of the program that could utilize water views. Additional shallow edges along the pond must be avoided to retain natural wetlands.

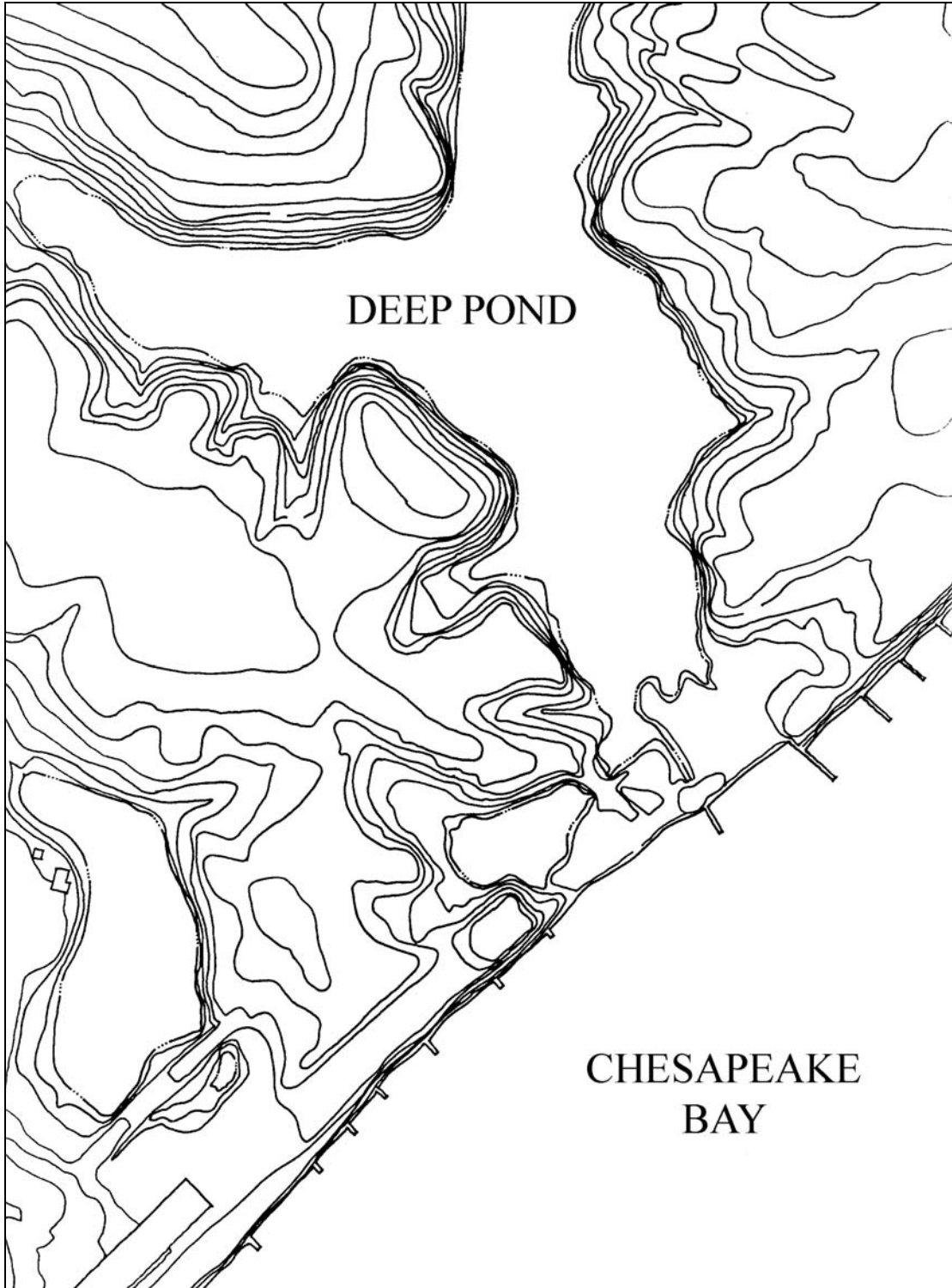

Figure 10: Site Topography.

The contour interval depicted here is two feet. The site varies minimally in elevation

Scale: 1"=400'-0"



Sun Path and Prevailing Winds

Because the shoreline meanders in a southwestern direction along the site, there is an opportunity to provide southern exposure for a majority of program while at the same time retaining views out toward the Bay (see Figure 11). An ideal building shape would to advantage of ample early morning light and indirect light at the noon hour with minimized building surface at the southwestern end to lesson heat gain from the afternoon sun. Eastern sunlight is preferable for the dormitories in the morning, encouraging an early rise for participation in the conferences. The meeting facilities do not require any distracting light or views, but the break-out areas and pre-function areas could take advantage of moderate sunlight and views of the bay or the pond. These facilities will most likely be located inboard of the dormitories so as to take advantage of the tranquility of the wooded site. Of course, strong summer sun in any large amount is not favorable in any part of the facility, so care will be taken to limit low altitude light through the use of the natural landscape and shading devices.

Prevailing winds are from the southwest for most of the year (see Figure 11), but in the summer the humidity and land/water temperatures cause more calm days. Generally, there is at least some breeze coming off the water combined with cool from Deep Pond, both of which are attainable by situating the building close to the waters edge. Due to its natural setting, there are no adverse foul smelling winds on the site. Conceptual studies within the chapter four make every attempt to maximize natural sunlight and ventilation for each program requirement, as well as to provide views to the Bay and the Pond where appropriate.

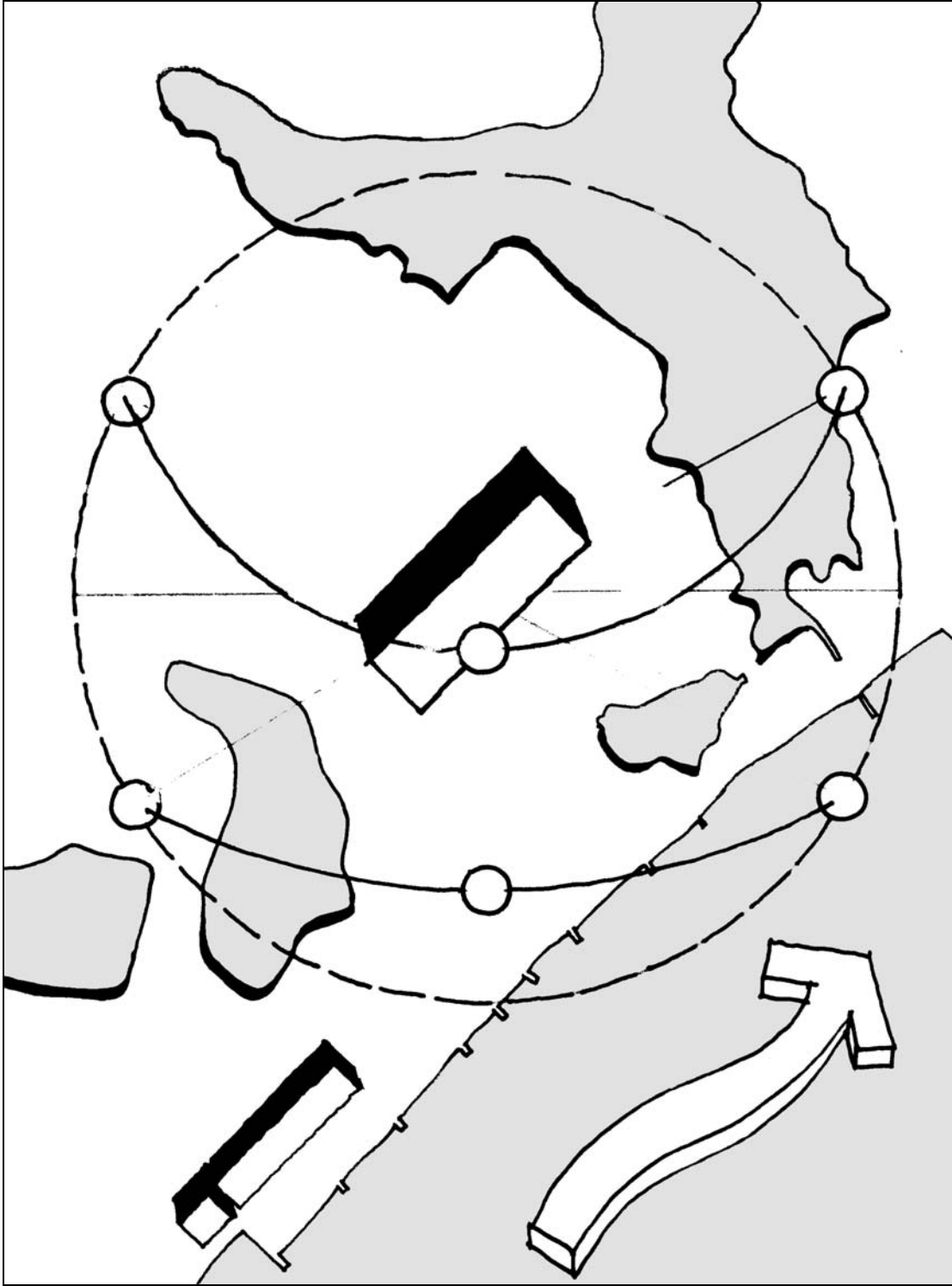

Figure 11: Sun Path and Prevailing Winds.

Scale: 1' = 400'-0"



Additional Site Features

The shoreline of the Chesapeake not only provides breathtaking views and unobstructed sunrises, but offers a diversified catalog of natural materials. Installed to defend the shoreline from erosion, dozens of breakwaters protrude into the bay (see Figures 12 and 17). These piers are constructed mostly of stone rubble and the weathering on their surfaces has battered their shape, making them contrast nicely to the serenity of the water. The Bay has delivered numerous layers of articles along the shore, some of it refuse but most of it driftwood piled at some points a foot high. The tidal waters tend to reveal their contents only for a while before carrying the wood back into the Bay, but the presence of the driftwood continues sporadically throughout the year, climaxing after the spring thaw. The diversity and contrast of the objects along the shoreline suggest several materials and perhaps even an aesthetic that would make a building contextual at the waters edge.

Past Uses

As established earlier in this chapter, past use of the park was discovered to be a recreational area with gambling facilities on site. The largest facilities of the park, including the gambling pavilions, were adjacent Bream Pond on the southernmost edge of the site (see Figure 12). The pond included paddle boats and row boats, most of them now abandoned within the new tree growth. There were several other picnic pavilions within the park, some of them measuring up to 1200 square feet each. Concrete slabs remain at their locations, but there are no visible signs of the rest of their structure. In the 1952 photograph there appears to be a substantial amount of parking adjacent the gambling pavilions with at least 12 lanes visible (see Figure 7).

From the detectable amount of worn out grass areas within the park it's doubtful that this parking was used exclusively for the pavilions-it probably also served as an entrance to the beach in the summer months.

Deep Pond more aggressively approaches the shoreline of the Chesapeake, allowing literally no connection between the north and south parcels except at the beach. The existence of a well-traveled roadway at the north end suggests two separate recreational facilities, each with a different program. In fact, there are five remnants of cabins still visible along the northern shore of Deep Pond in ideal location for fishing and secluded enough to be vacation cottages (see Figure 14). Most of the roads on either side of the pond still exist as dirt pathways through the park. There is a possibility of reclaiming the old gambling pavilions for a similar or related use. That use may be for the conference center, the public, or both, but its adaptive reuse might increase utilization of the park space and at the same time provide an additional amenity to the conference center program.

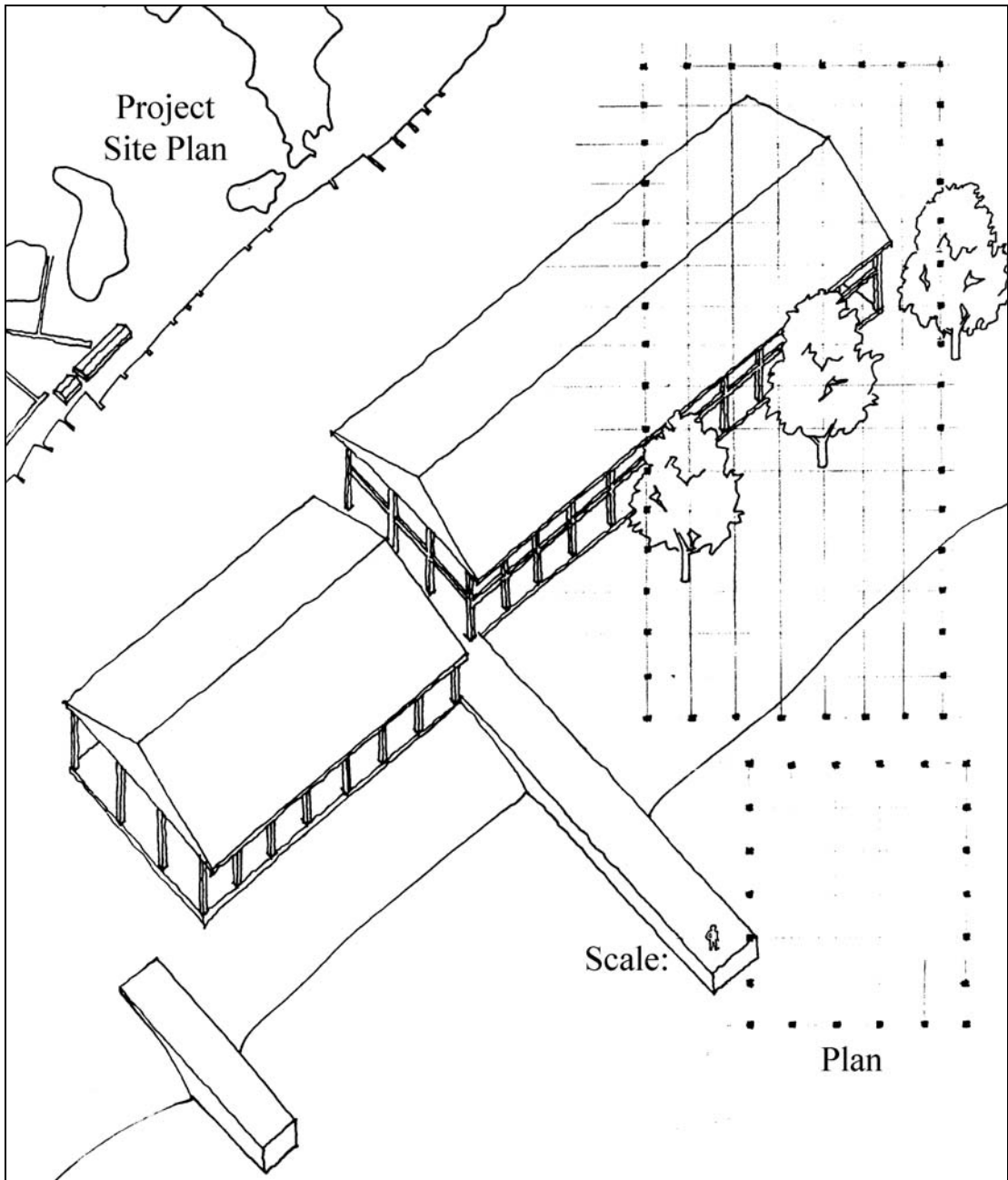

Figure 12: The Beachfront Pavilions.
These pavilions have direct access to the beach and may support a new function related to the public use of the park. Not to Scale.



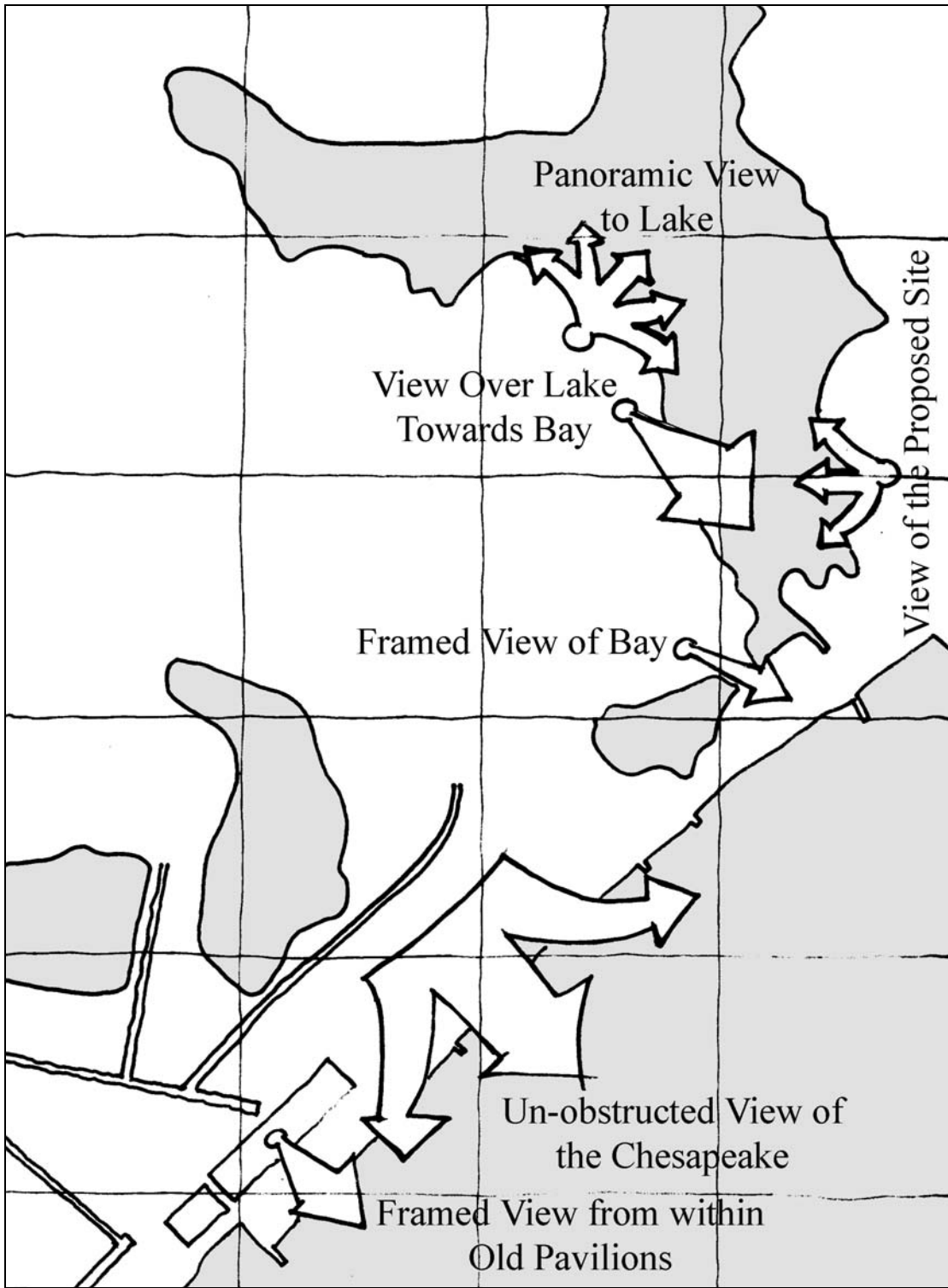

Figure 13: Viewpoints.

Scale: 1"=400'-0"



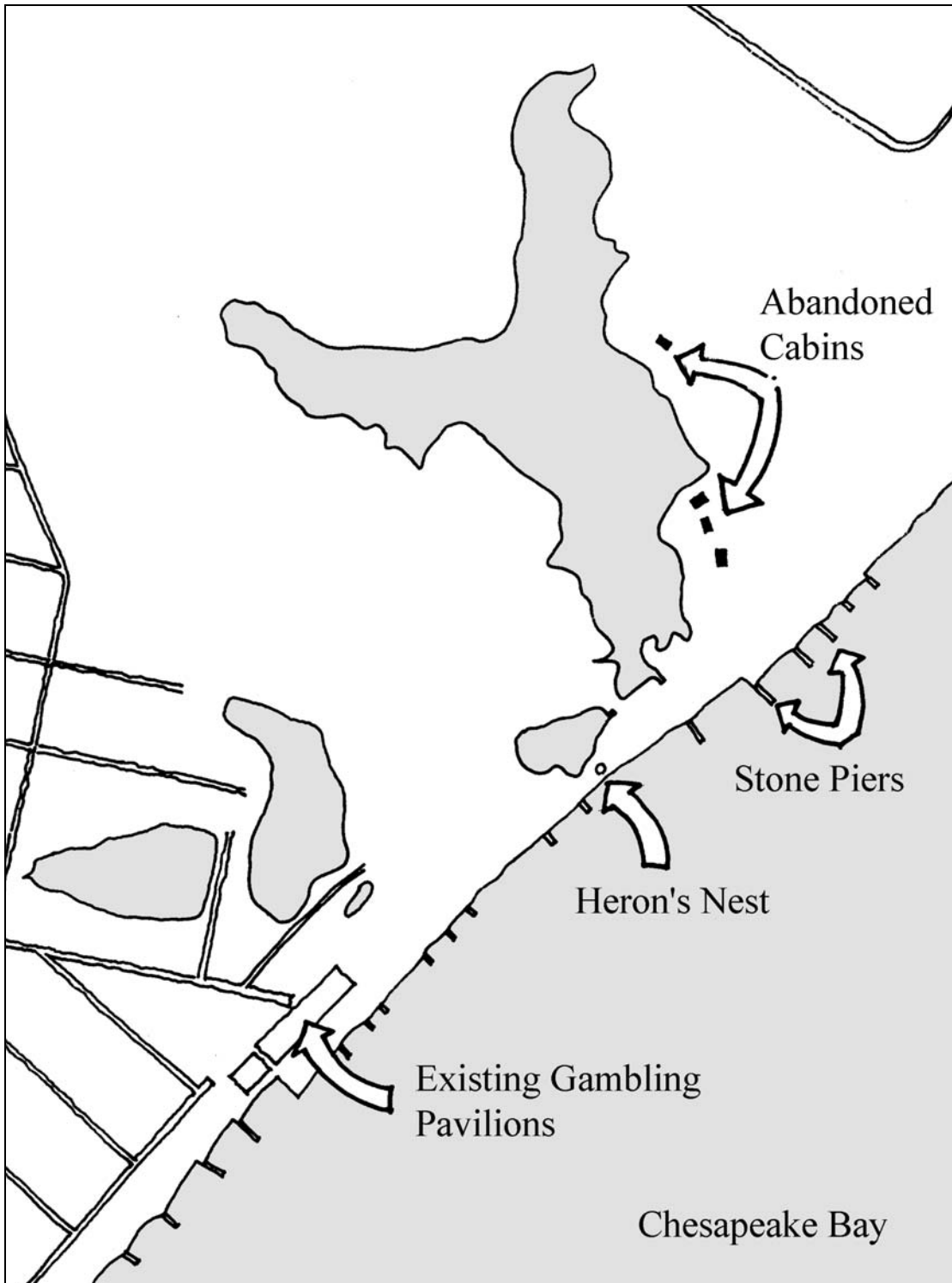

Figure 14: General Site Features.

Scale: 1"=400'-0"



Zoning

Several types of zoning legislation govern the proposed conference center site, all of which are outlined in the Anne Arundel County Code and described below:

Residential and Open Space Districts

All residential areas adjacent the site are classified as R-5 zones, allowing for density up to 5 dwelling units per acre¹ (see Figure 15). Currently development in the area averages around 1.7 units per acre with not enough land for sale to increase this figure substantially in the next few years. Even a modest increase in housing density would have minimal effect on area infrastructure since the access roads appear to have been sized for easy access to the once thriving waterfront casinos and public beach. Currently Triton-Beverly Beach Park itself and the undeveloped area southeast of Chesapeake Avenue is designated by zoning as an Open Space District (labeled OS). This classification restricts building uses to the following²:

- Alcoholic beverage uses accessory to other uses
- Camps, nonprofit, including dormitories, cabins, and structures for administrative, maintenance, and custodial activities
- Commercial telecommunication facilities permanently located on the ground
- Conservation uses, practices, and structures for the maintenance of the natural environment
- Farming or nurseries, including truck gardening, grazing of livestock, and other similar activities if the use does not change the stability of the land
- Golf courses
- Home occupations
- Launching ramps
- Piers, private
- Piers, recreational
- Public utility essential services
- Public utility uses

¹ Anne Arundel County, *Anne Arundel County Code*, Article § 18-4-701

² Anne Arundel County, *Anne Arundel County Code*, Article § 18-9-202.

- Residential uses, existing
- Staging areas for County capital projects
- Structures for administrative and custodial uses of the principal use of the site if building coverage, including parking, does not exceed 20% of the site and the structures are not located in the natural drainage system
- Structures, permanent, for hunting, golf courses, ice skating, nature study, picnic areas, play areas, and stables
- Structures, temporary, for boating, swimming, fishing, hunting, golf courses, ice skating, nature study, picnic areas, play areas, stables, and stands for the sale of products raised on the premises
- Volunteer fire stations

The construction of a conference center facility within the boundaries of Beverly-Triton Beach Park would not be permitted under current zoning legislation, necessitating a re-zoning proposal for the area in order to proceed.

Critical Area Zoning

The Anne Arundel County Code also labels part of the site as a Chesapeake Bay Critical Area. Critical Areas are defined as “all wetlands and all land and water areas in the county within 1,000 feet measured planimetrically beyond the landward boundaries of tidal wetlands and the heads of tides.”³ The intent of these areas is to minimize adverse impacts on water quality, conserve plant, fish and wildlife habitat, and foster more sensitive development activity for shoreline areas. The following Critical Area restrictions apply to the site:

- A 100-foot buffer from the landward boundaries of tidal wetlands is to be established, and development activities within the buffer are to be limited to water-dependent facilities.
- Deforestation within the 100-foot buffer is not allowed, except by approval of the Office of Planning and zoning (A buffer management plan for any disturbance within the buffer shall be required.)
- The pollutant loading shall be at least 10% below the level of pollution from the site prior to development.

³ Anne Arundel County, *Anne Arundel County Code*, Article § 18-13-200

- No more than 20% of any forest or developed woodland may be cleared for development. An additional 10% of the total forest may be disturbed with a replacement of 1 ½ times the total acreage of disturbed forest in an alternative area of the site. Off-site forest replacement is allowed, but at a cost of 60 cents per square foot of disturbed forest.
- Corridors of existing forest or woodland vegetation that connect undeveloped or mostly vegetated tracts of land within and adjacent to the site shall be maintained.
- Impervious areas shall be limited to 15% of the development site.
- Development on slopes of 15% or greater is not permitted.

Careful treatment of the wooded areas will be necessary to allow for a minimum 20% deforestation. The maximum allowable impermeable surface area as a percentage of the total site will most likely govern the purchased lot size. Because the University would purchase the appropriate amount of land from the County, the luxury of ‘backing in’ to this number is available. More conventional development might force build-able area and maximum impermeable surface areas to restrict the size of the program. There are a minimal amount of slopes present that approach 15%, most of which occur within the 100-foot buffer areas along the ponds and the Bay. Any deforestation approaching 20% could be reforested to the northwest of the intended development area between Deep Pond and the Bay, with additional areas available at the northwest corner of the park. Decreased pollutant loading is questionable considering the site is currently not developed, but the removal of several concrete slabs once used for picnic area (some of which measure 1200 square feet) might improve stormwater runoff filtering.

The nature of a waterfront site makes it a highly restrictive area in terms of development, but current zoning regulations under the Chesapeake Bay Critical Area Legislation have the same intent as the proposed project: to minimize adverse impacts of the Chesapeake Bay and its wildlife habitat. It is the aim of this exercise to comply

with all regulations set forth by this legislation, and to create a building that both functionally and aesthetically lives in harmony with the Bay.

Other General Conclusions

In addition to the responses to site analysis listed in the previous corresponding sections, the following additional positions have been derived: Most of the site analysis indicates the area between Bream and Deep ponds as the most favorable to develop. This area minimizes impact on the adjacent neighborhoods, takes the best advantage of natural land features, and minimizes deforestation within the park. It also allows for unhindered connections between potential north and south recreational facilities with both adjacent neighborhoods and accommodates zoning restrictions, with the exception of the necessary rezoning.

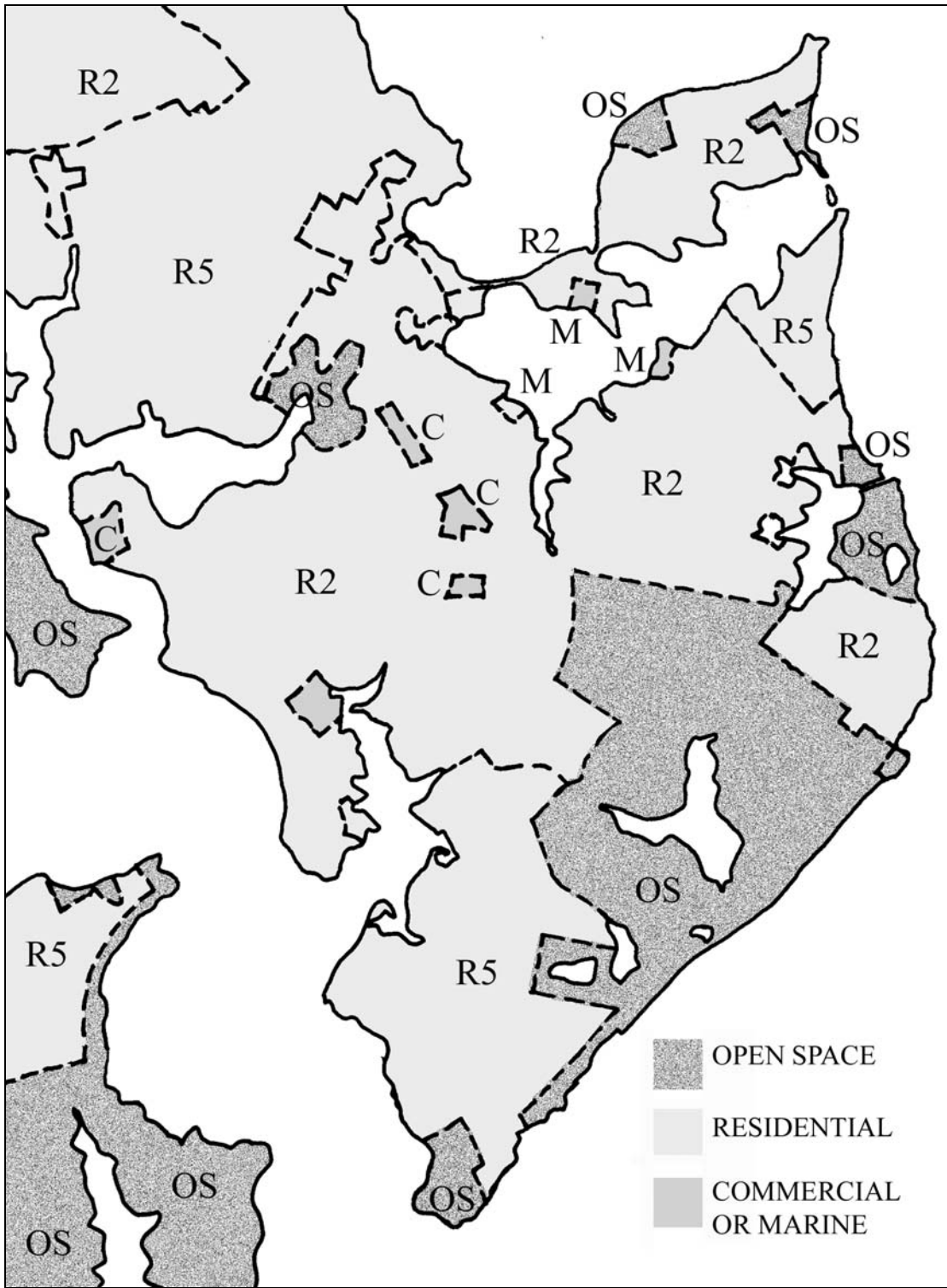



Figure 15: Existing Neighborhood Zoning.

Scale: 1"=400'-0"



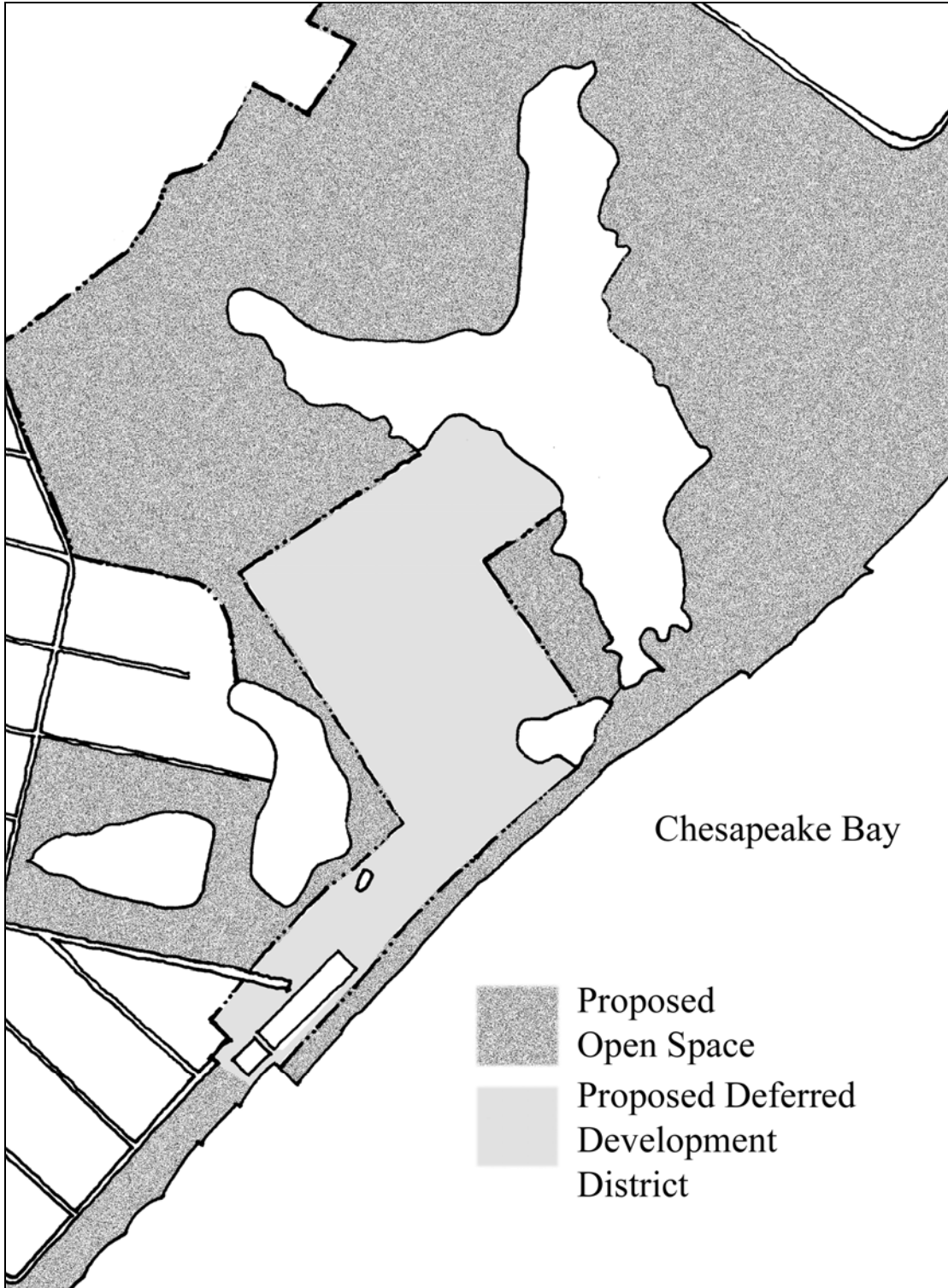

Figure 16: Proposed Site after Proposed Re-Zoning.

Scale: 1"=400'-0"





Figure 17: Photo of Triton Beach Park Looking South.



Figure 18: Photo of Triton Beach Looking North.



Figure 19: Photo of Approach Road.



Figure 20: Photo of Access Road.



Figure 21: Photo of Remnants of Steel Buildings.



Figure 22: Photo of Inside of Old Steel Buildings.

Chapter 3: Program

This section works toward developing a building program through comparison of existing conference center programs, the needs of its users, and the relationship between specific programmatic elements to each other. The intention of this thesis, as stated in the introduction, is to develop a building in a scale that makes it possible to take the design to a very detailed level, delineating the building in great detail. Because of this, the desired program target will be around 50,000 square feet.

A conference center was chosen because it provides programmatic elements in various scales, from the large conference meeting rooms to the individual dormitories. Because the success of the conference center relies on the satisfaction of its attendees, there is a need to make the spaces not only memorable, but comfortable. A conference center is different from other corporate and academic facilities in that it requires a quiet, secluded site that provides various leisure activities for its users.

Another important factor in program scale is the impact of the building foot print on the park. Figures 23 through 28 illustrate the result of placing several other conference centers directly on the site. In each circumstance the buildings fit within the proposed site boundaries, but buildings below 10,000 square-feet tend to get lost in the vast landscape. Based on this direct application of square-footage to the proposed site and the desire to make a building that is developed to a finite scale of architectural detail, the range of acceptable program size will be above 10,000 square feet and below the mammoth conference center sizes of 200,000 square feet and up.

The university will sponsor retreats for university organizations and other organizations that could benefit from a retreat-like setting. There are many examples

of the latter, including the Princeton University Conference Center⁴ and The Aspen Institute at Wye Plantation⁵. In fact, both local government organizations from Annapolis and federal government organizations from Washington DC could benefit from the proximity of the Mayo site. The scale of the facility would most likely attract the smaller groups of around 100 people, and meetings would generally last one week or over a single weekend.

⁴ Lawson, *Congress, convention & exhibition facilities: planning, design and management*, 159.

⁵ The Aspen Institute. “*The Aspen Wye River Campus*.” <http://www.aspeninstitute.org>.

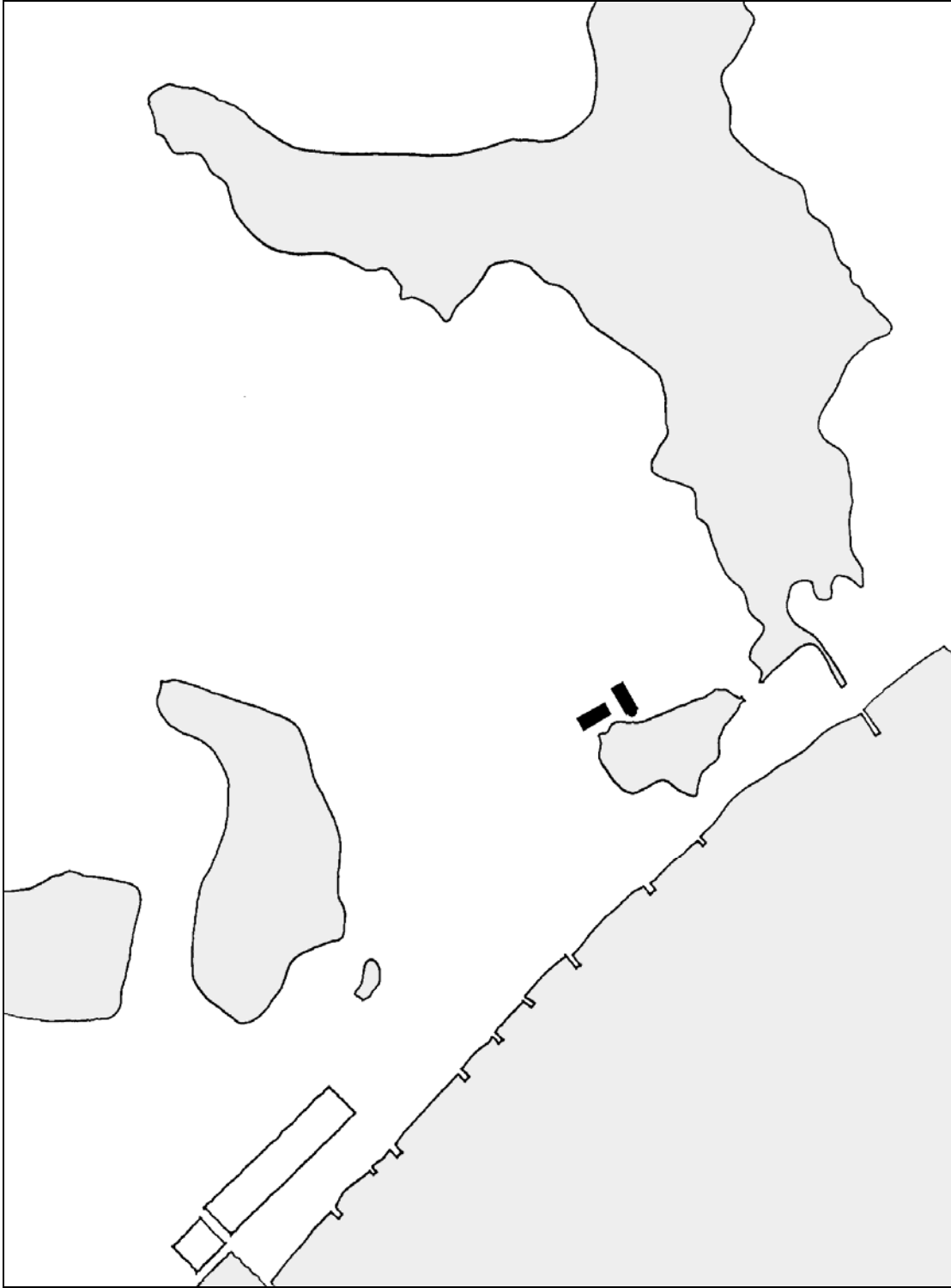

Figure 23: The Marigold Lodge Footprint on the Project Site.
This conference center is 7,650 square feet distributed on two floors. Scale: 1"=400'



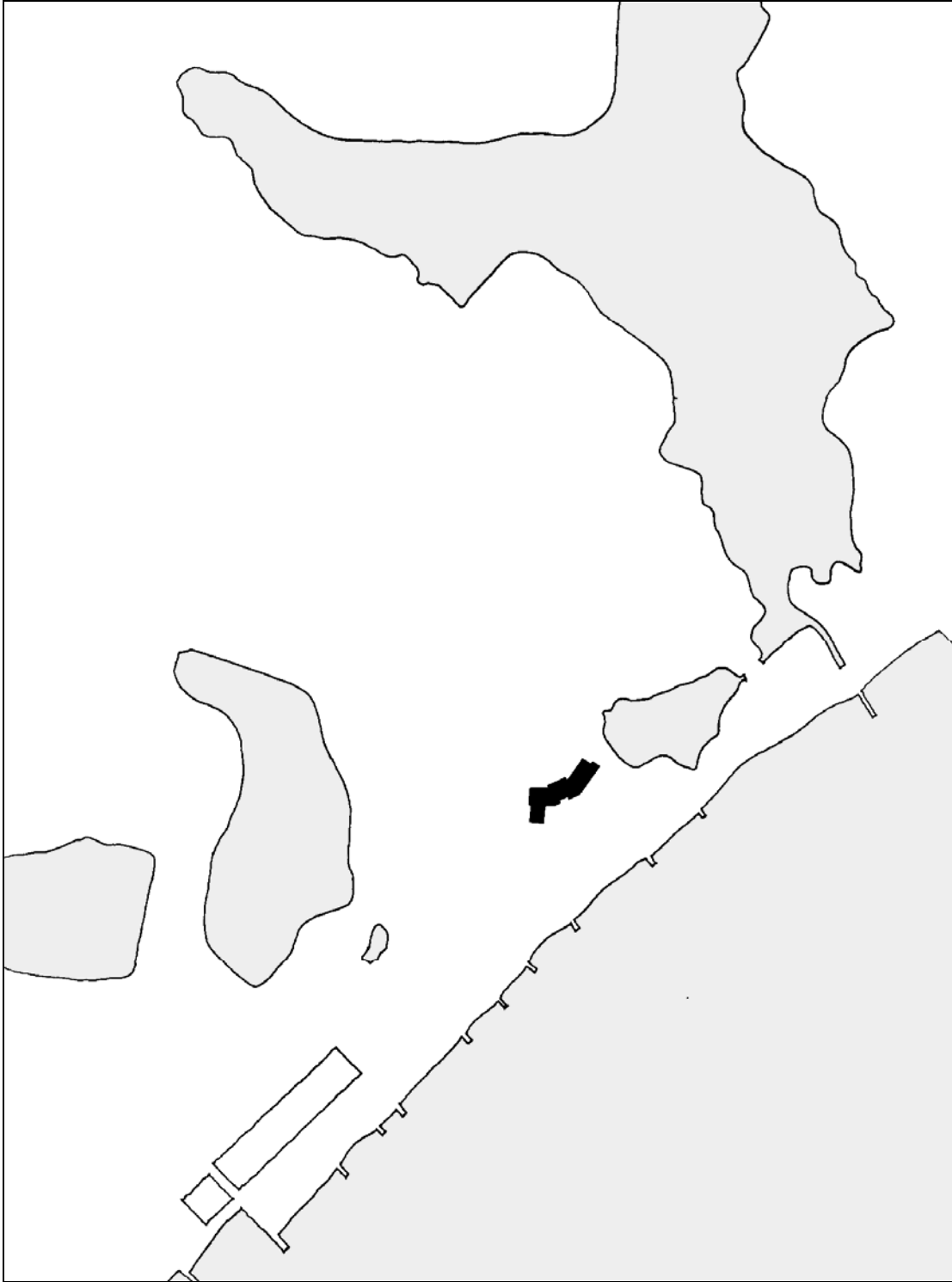

Figure 24: The Minnowbrook Lodge Footprint on the Project Site.
This conference center is 8,800 square feet distributed on two floors. Scale: 1"=400'



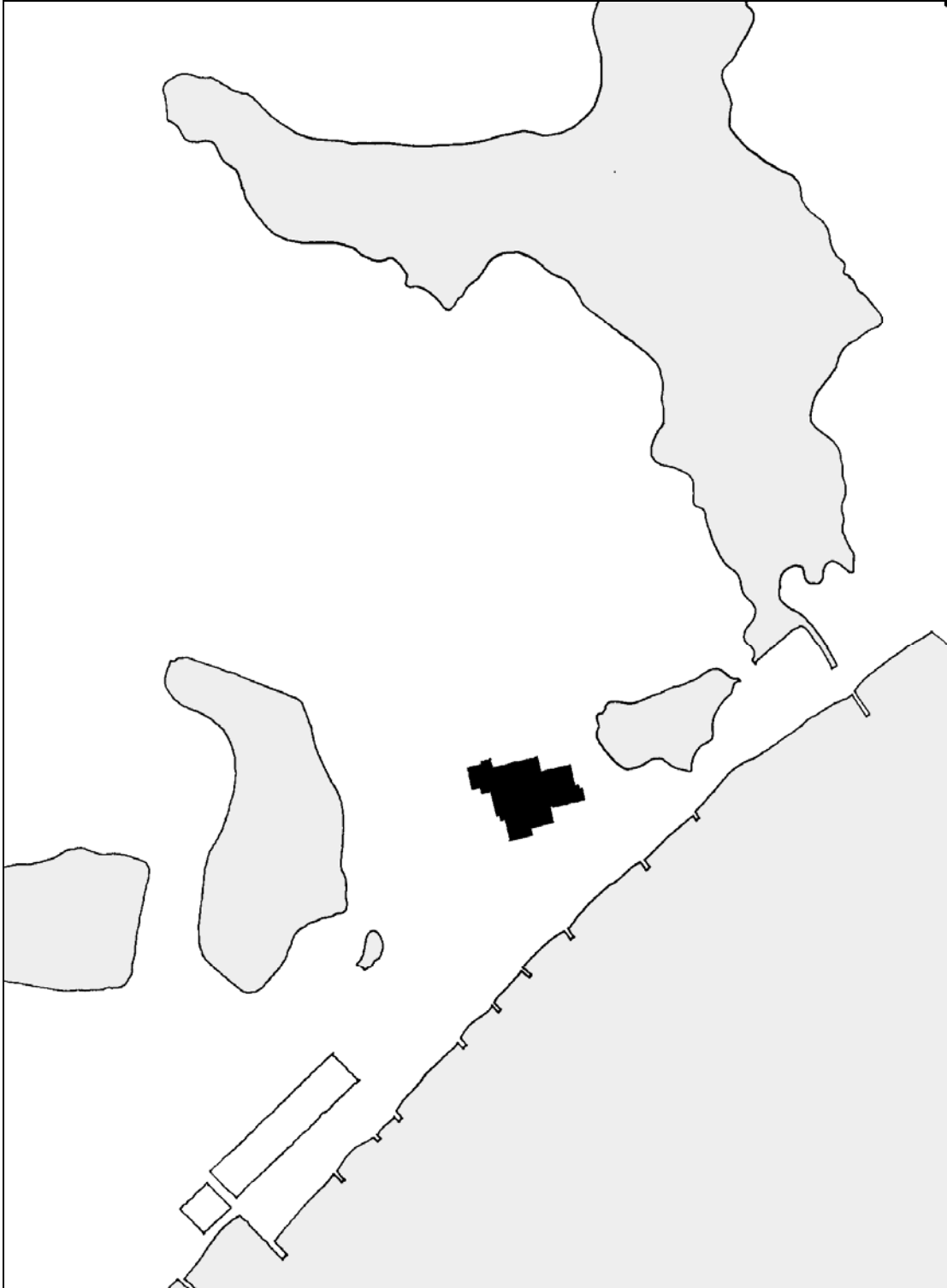

Figure 25: The Council House Footprint on the Project Site.
This conference center is 76,000 square feet distributed on two floors. Scale: 1"=400'



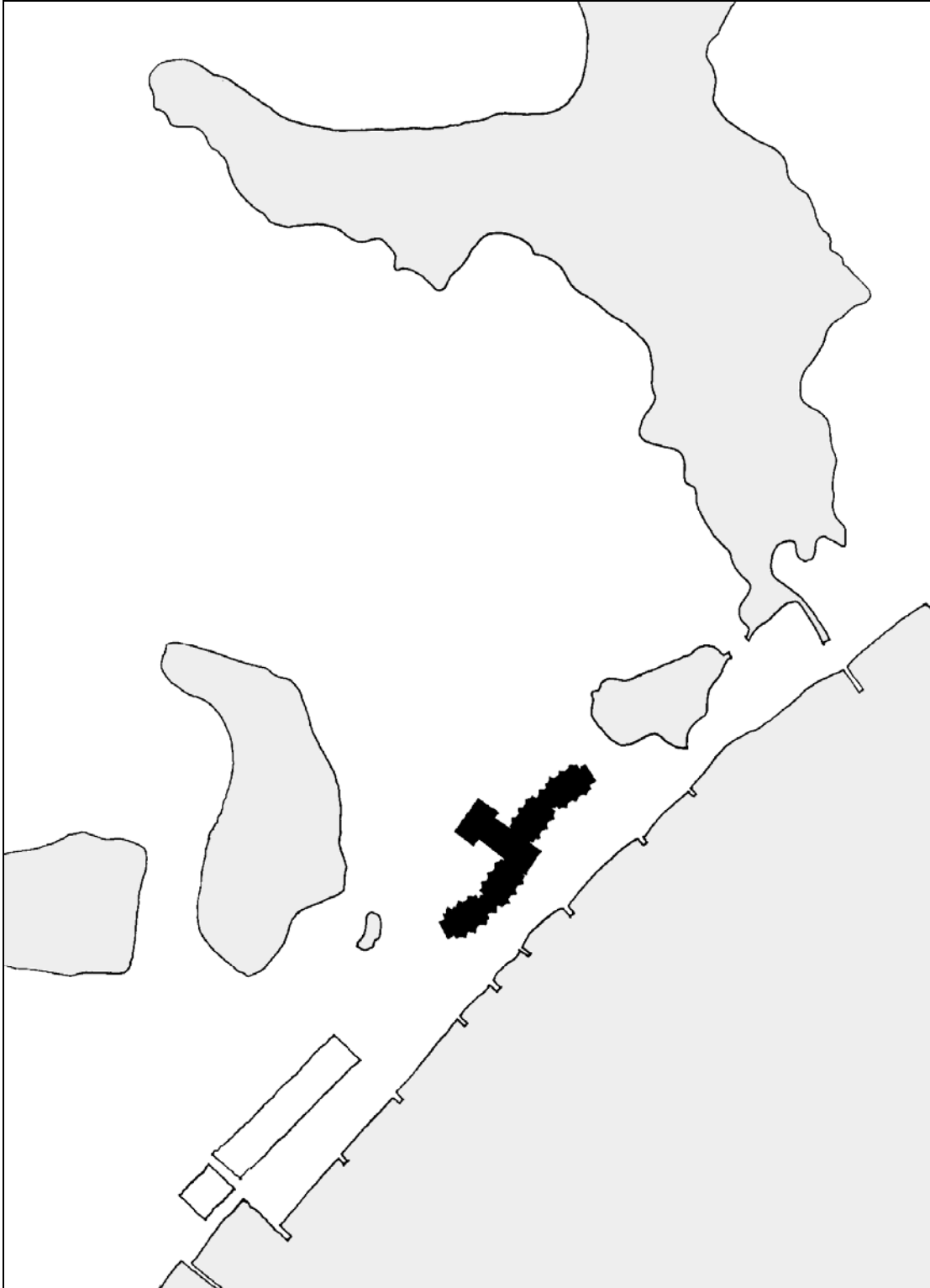

Figure 26: The GE Management Institute Footprint on the Project Site.
This conference center is 113,000 square feet on three floors. Scale: 1"=400'



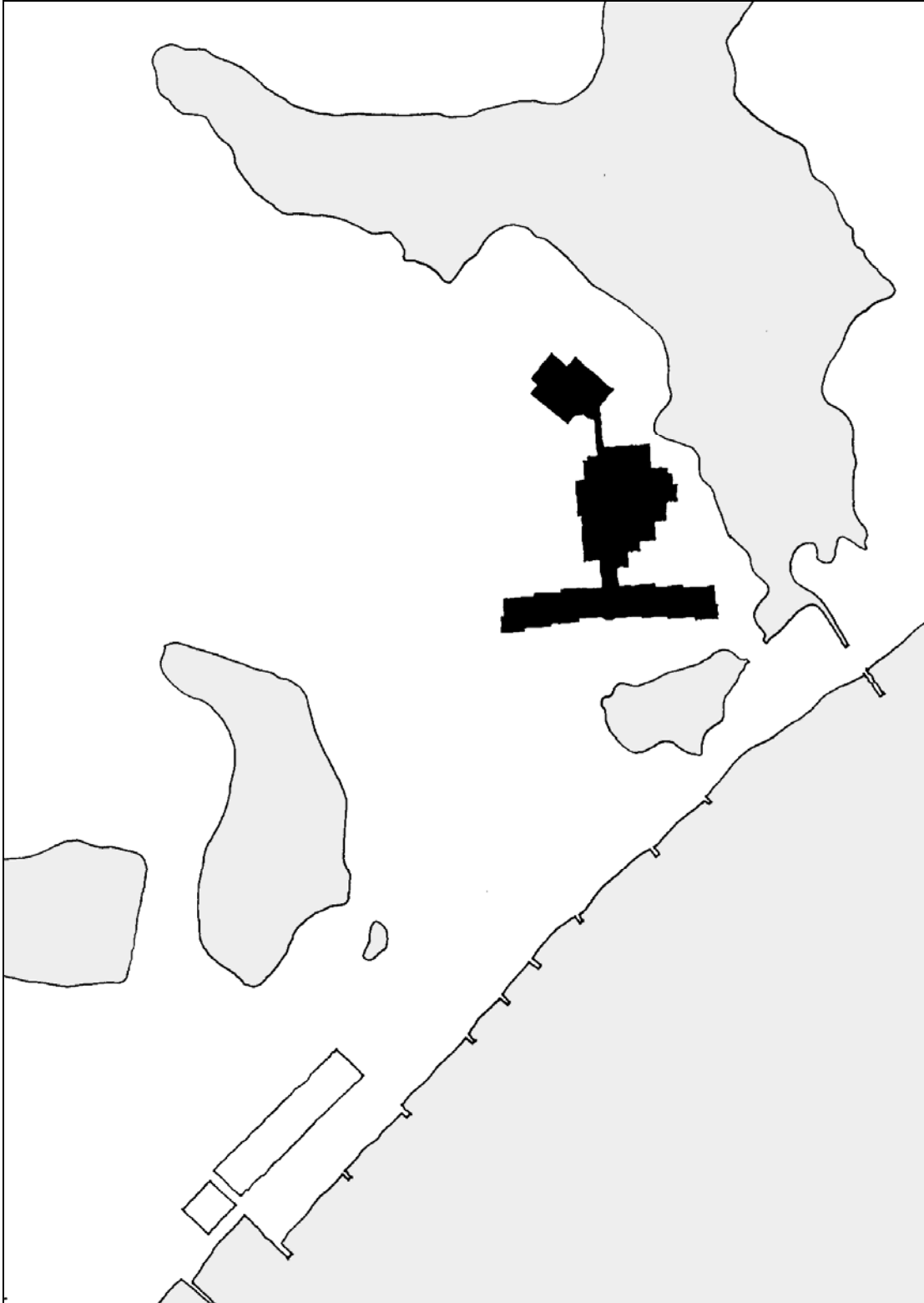

Figure 27: The GTE Development Center Footprint on the Project Site.
This conference Center is 184,000 square feet on three floors. Scale: 1"=400'



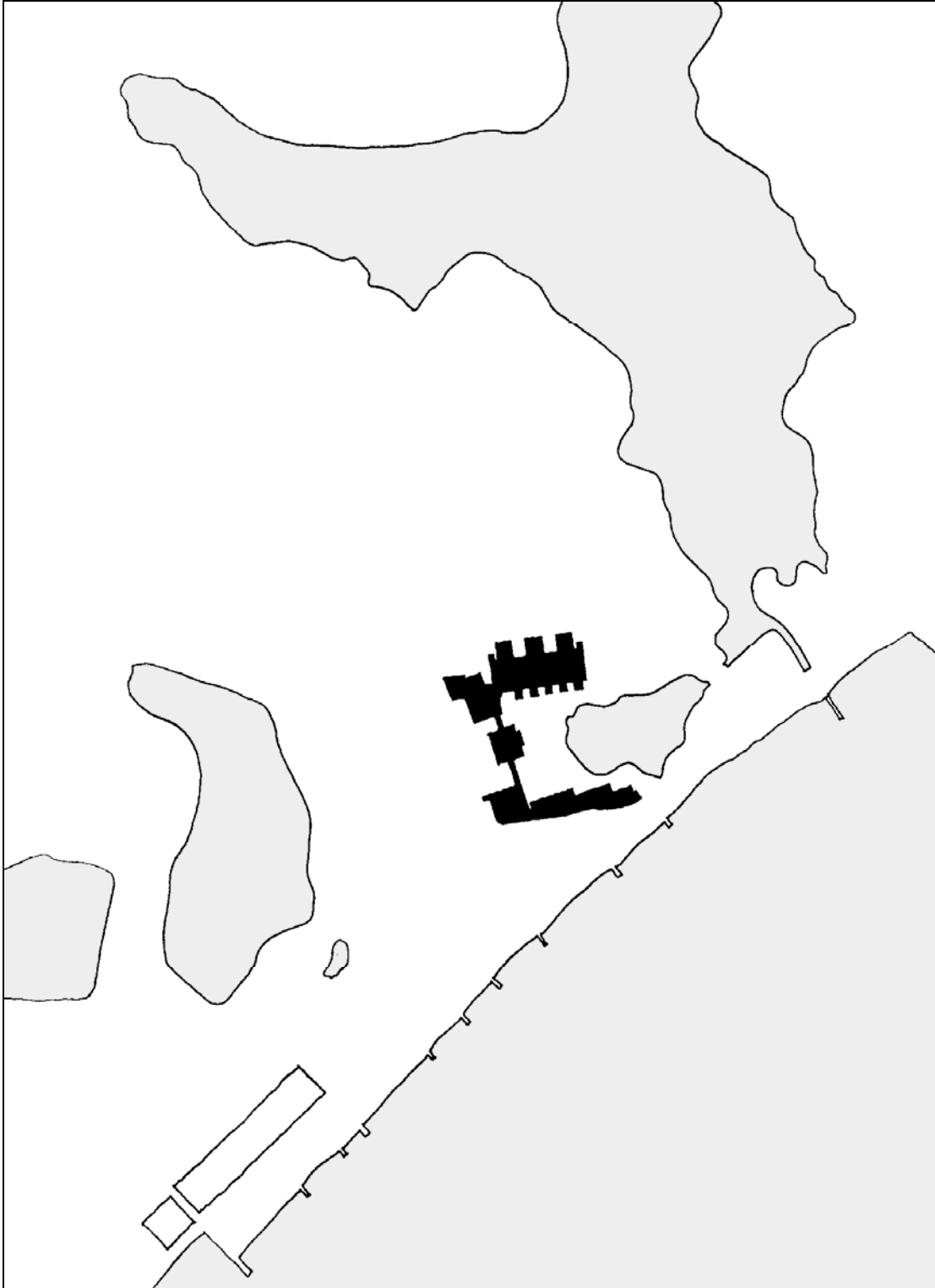

Figure 28: The IBM Advanced Business Institute Footprint on the Project Site.
This conference center is 410,000 square feet on three floors. Scale: 1"=400'



Program Comparisons

<i>Table 1: Sample Programs, University Conference Centers⁶ in net square feet</i>						
	University of Michigan <i>Ann Arbor, MI</i>	University of Pennsylvania <i>Philadelphia, PA</i>	Northwestern University <i>Evanston, IL</i>	Duke University <i>Durham, NC</i>	Babson College <i>Boston, MA</i>	Cornell University <i>Ithaca, NY</i>
Total square ft.	76,400	118,200	93,900	103,800	108,900	159,400
# of guestrooms	96	103	104	113	130	150
Total square feet of guestrooms	31,300	62,800	42,300	46,400	52,300	74,100
Square feet per guestroom	326	609	406	410	402	494
Public areas	10,600	10,200	12,300	12,300	11,100	28,500
Conference areas	27,000	29,100	26,700	19,500	29,600	21,700
Administrative areas	500	4,300	3,400	1,900	2,400	6,000
Back-of-house areas	7,000	9,900	8,300	21,800	13,500	29,100
Recreation	0	1,900	8,300	21,800	13,500	29,100
Average square feet per room	796	1,148	903	918	837	1,063

⁶ Penner, *Conference Center Planning and Design*, 66.

Conference Center Program by Rooms and Areas

Guestrooms

It is anticipated that nearly all of the conference attendees will be staying at the center, therefore the number of guestrooms is directly proportional to the other program functions. Based on a significant amount of trial and error, there will be 96 guestrooms provided at 300 square feet each. Unlike corporate conference centers, university centers provide modest accommodations with minimal amenities⁷. The room will consist of its own private bathroom, a closet, a dresser, ample room for seating, a large desk. Although these rooms are intended for single occupancy, several types of functions may require a number of double occupancy rooms. Queen-size beds will make the rooms easily convertible, and the total square-footage is enough to accommodate the extra person. Aside from a television, a clock and a computer, few electrical appliances will be provided, as the intent of the center is to discourage stay in the rooms and encourage participation in the conference. A significant amount of light and air should be present, especially early and late in the day when the occupant will be present. Good views are desirable, as well as direct access to leisure functions. Because the conference attendees will naturally have preconceptions of a university dormitory, attention must be taken not to design the guestrooms to look and feel like cramped college dorm rooms.

⁷ Lawson, *Conference, convention and exhibition facilities*, 65.

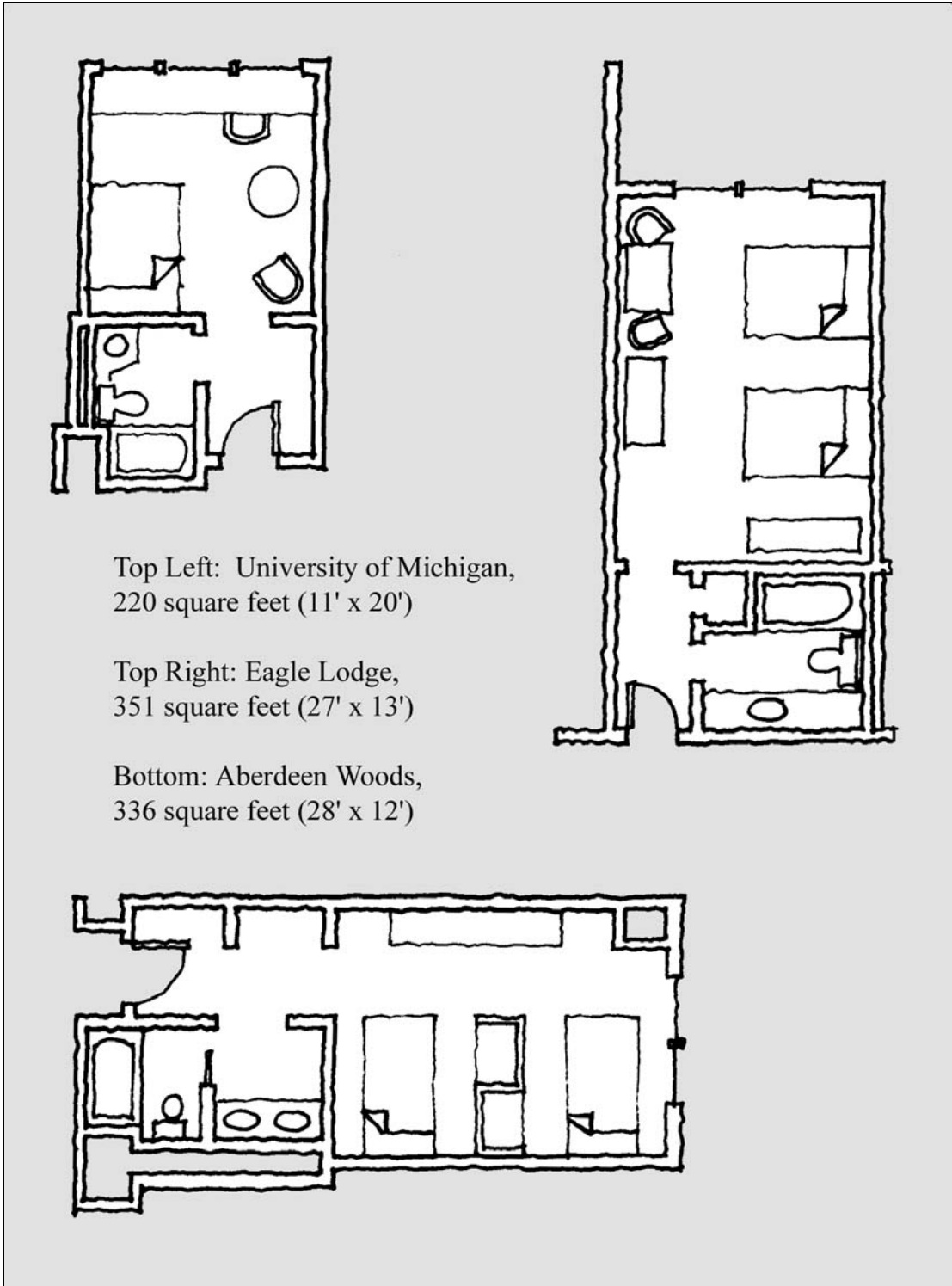

Figure 29: Samples of Guest Room Layouts.

Main Entry Lobby

In the interest of conserving space, the main entry lobby will act as a multi-functional room. All attendees will register here and proceed to the guestroom wing. Bell service will be very limited or non-existent, so easy access to the guestrooms is preferable. Small social areas within the lobby will be provided, as well as a reception desk and public phones. The lobby will also need to be convertible in order to house large receptions for the conferences. Because it is the largest room intended for both formal and informal social events and it provides the first impressions of the center to its attendees, the room deserves special attention to detail. There is an opportunity here to visually connect the center to the landscape by providing strong views outward from the lobby as well as significant light and air. The lobby will no doubt act as a connector between the conference and residential wings and provide a memorable space to relate the two architecturally.

Amphitheater

The two amphitheaters should be tiered in section to allow unobstructed viewing. Seating for 54 attendees will be provided in each room with a chair that incorporates writing and work surfaces. Rows of seating will most likely be curved to focus attention towards a small stage located front and center⁸. The room should include front screen projection for multimedia presentations, as well as adequate task and area lighting. Adjacent projection rooms will be large enough to allow for electronic equipment associated with interactive teaching including a computer with monitor, a server, and necessary overhead computer projection equipment. Natural

⁸ Lawson, *Conference, convention and exhibition facilities*, 72

lighting is optional, but its presence will necessitate the use of shading devices during presentations. Size of the amphitheaters will allow for an average of 25 square feet per seat.

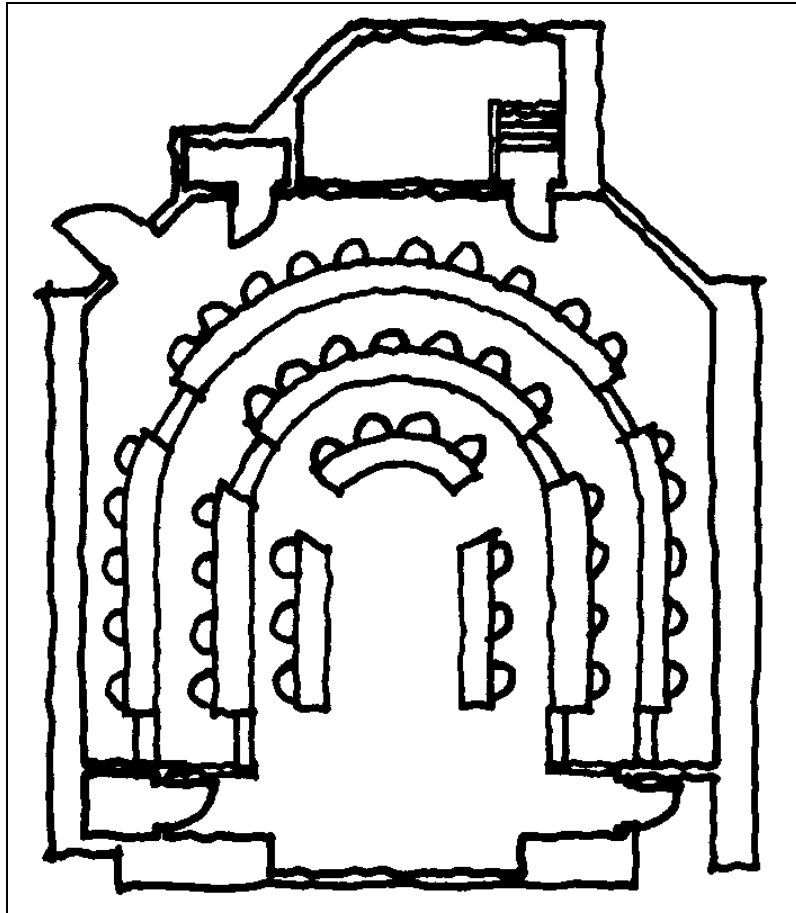

Figure 30: Amphitheatre from the Steinberg Center, University of Pennsylvania.

Conference Areas

Both small and medium conference facilities will be included, accommodating 35 and 55 seats respectively. Floors in these rooms will be flat, but again with chairs providing work surfaces. Walls will require tack-able surfaces, presentation rails, and projection screens. The seating formal will be classroom style. Again, distracting landscape views are not desirable, but sufficient light and air is a necessity.

Breakout Rooms

Small scales of break-out rooms will be provided for focus groups, the larger ones accommodating 13 people at 25 square feet per person, and the smaller ones 10 people at the same square footage allowance. These spaces have a more personable nature and would benefit from landscaped views as well as natural ventilation.⁹

Seating here is much less formal and generally depends on the group leaders' preferences. Flexible seating arrangements will necessitate nearby closets to store excess chairs and tables.

Dining Area

The dining area will contain around 115 seats, which averages 1.19 dining seats per guestroom. Although it is quite common in conference centers to provide dining tables in the kitchen for the staff¹⁰, extra seating is allocated here for visiting faculty. Dining areas for university conference centers average 30 to 35 square feet per guestroom¹¹, and at 3,000 square feet, this dining room will average 31.25.

Layout of the dining hall will most likely allow for movable tables around a buffet table. Proximity to conference areas is preferable, allowing conference attendees to use the dining facilities between scheduled meetings. Any other special receptions will be held in the main entry lobby, a space less tied to the necessary business environment of the conference wing.

Recreation Areas

The nature of the landscaped site is conducive to outdoor recreational activities. The conference center will share park amenities with the public, including

⁹ Lawson, *Conference, convention and exhibition facilities*, 91

¹⁰ Penner, *Conference Center Planning and Design*, 138.

¹¹ Penner, *Conference Center Planning and Design*, 138.

swimming areas and beaches, jogging and walking trails, boating facilities, and gardens. The common areas adjacent the guestrooms will also serve as television rooms and provide convertible space for informal meetings. Additionally, an exercise room and lockers as well as a game room will be provided within the conference center residential wing. All recreational activities will be directly accessible from the guestrooms.

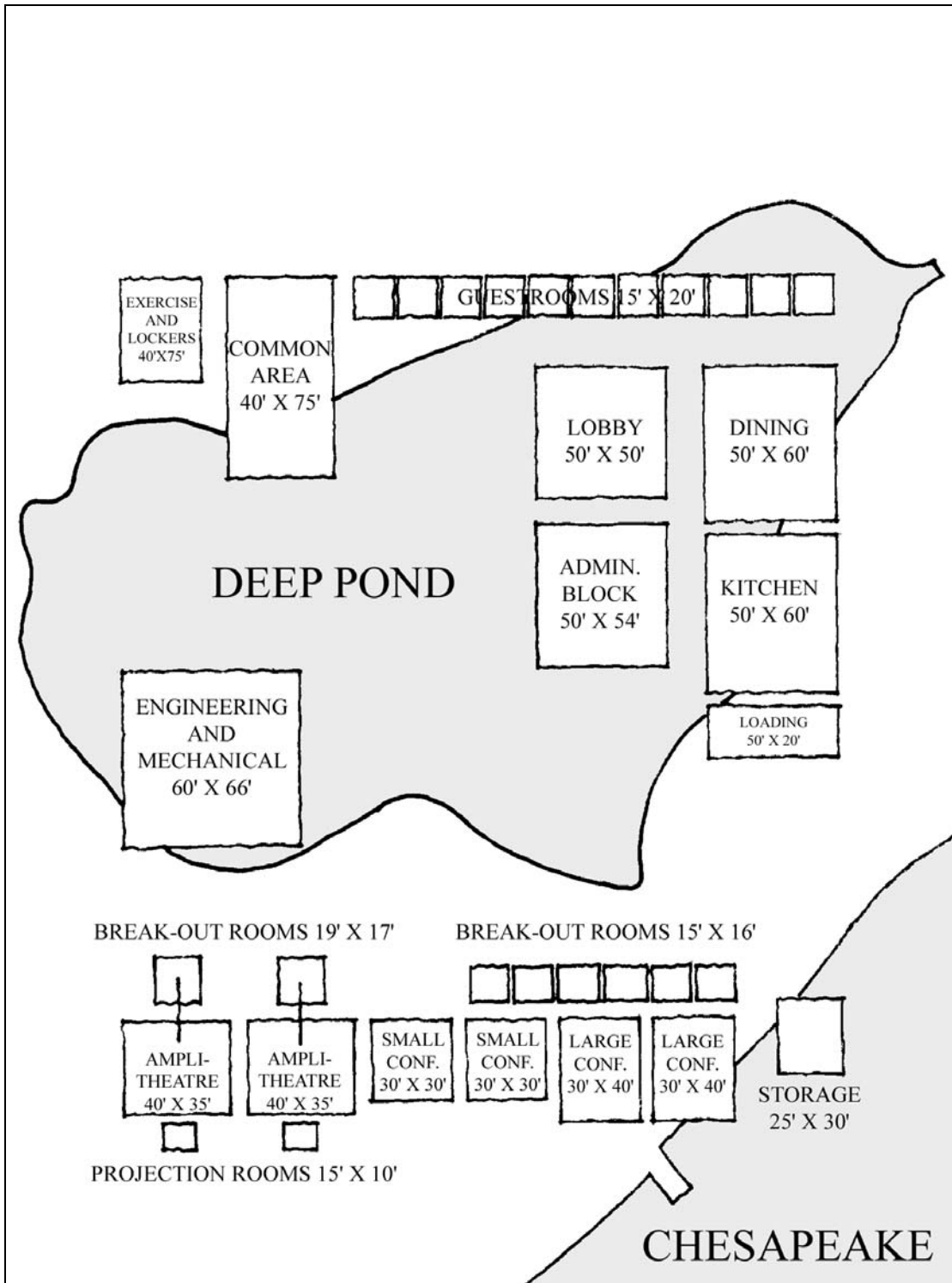

Figure 31: Application of Program Areas Relative to the Site.
 Placement of specific rooms is only approximate to their programmatic relationships.



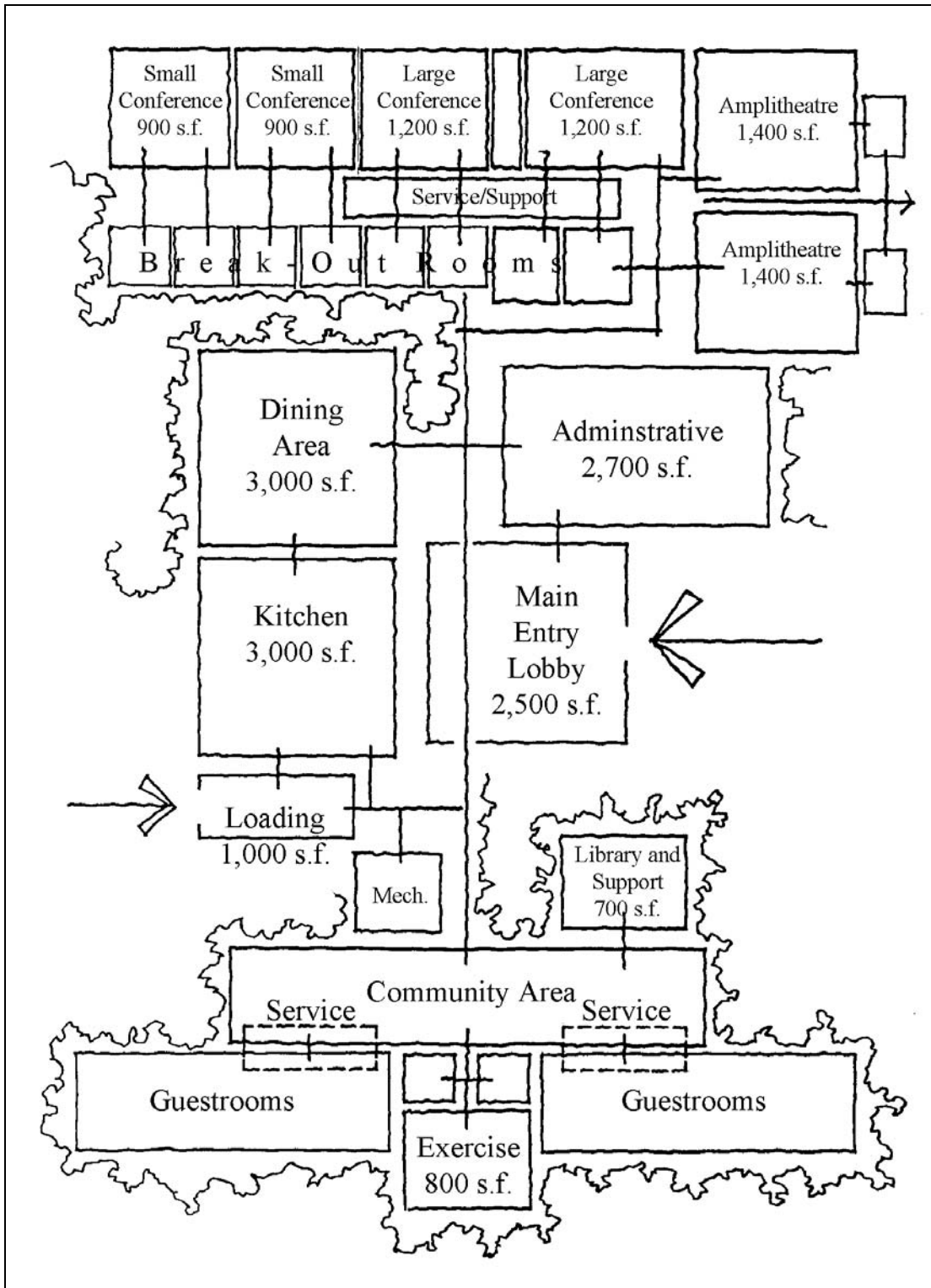

Figure 32: Room Adjacencies.

The tree line represents where a view is desirable. The large arrow represents the main entrance and the small arrow represents the loading/service entrance. Not to scale.

Final Program

Guest Accommodations		
Guestrooms	96 @ 300 Sq. Ft. Each	28,800
Guest room Common areas		3,000
Total, Guestroom and common areas		31,800
Public Areas		
Main Entry Lobby (Also to serve as Ballroom)		2,500
Support (storage areas for chairs/tables)		300
Dining Room		3,000
Library/Reading Room		500
Support for Library		200
Total, Public areas		6,500
Conference Areas		
Medium Size Conference Areas	2@1200 Sq. Ft. each	2,400
Small Conference Areas	2@900. Ft. each	1,800
Breakout Rooms	2@325 Sq. Ft.	650
	6@250 Sq. Ft.	1,500
Amphitheater	2@1,400 Sq. Ft.	2,800
Projection Rooms	2@150 Sq. Ft.	300
Storage Areas		500
Pantry		200
Total, Conference Areas		10,150
Back-of-House		
Kitchen		3,000
Receiving area with loading dock		1,000
Employee dining and break areas		1,000
Laundry and Housekeeping Areas		1,500
Maintenance and Engineering Areas		4,000
Total, Back-of-House		10,500
Administrative		
Front Office and Reception Desk		600
Executive Offices		800
General Offices (accounting, management, booking)		1,300
Total, Administrative		2,700
Recreation		
Exercise Room		800
Lockers and Toilets		400
Total, Recreation		1,200
Total Net Square Feet		62,850

Chapter 4: Precedent

Conference Centers

Although the majority of the conference centers illustrated are larger in scale than the proposed program, each one has some architectural significance and presents image-able architectural space and/or takes a position toward its presence in the natural landscape. Below is a list of Conference Centers that were examined for this project:

- IBM Advanced Business Institute, Palisades, New York
- Battelle Seattle Conference Center, Seattle, Washington
- Minnowbrook Lodge, Blue Mountain Lake, New York
- McDonald's Lodge and Training Center
- GE Management Development Institute, Croton-on-Hudson, New York
- GTE Management Development Center, Norwalk, Connecticut
- IBM Management Development Center, Armonk, New York

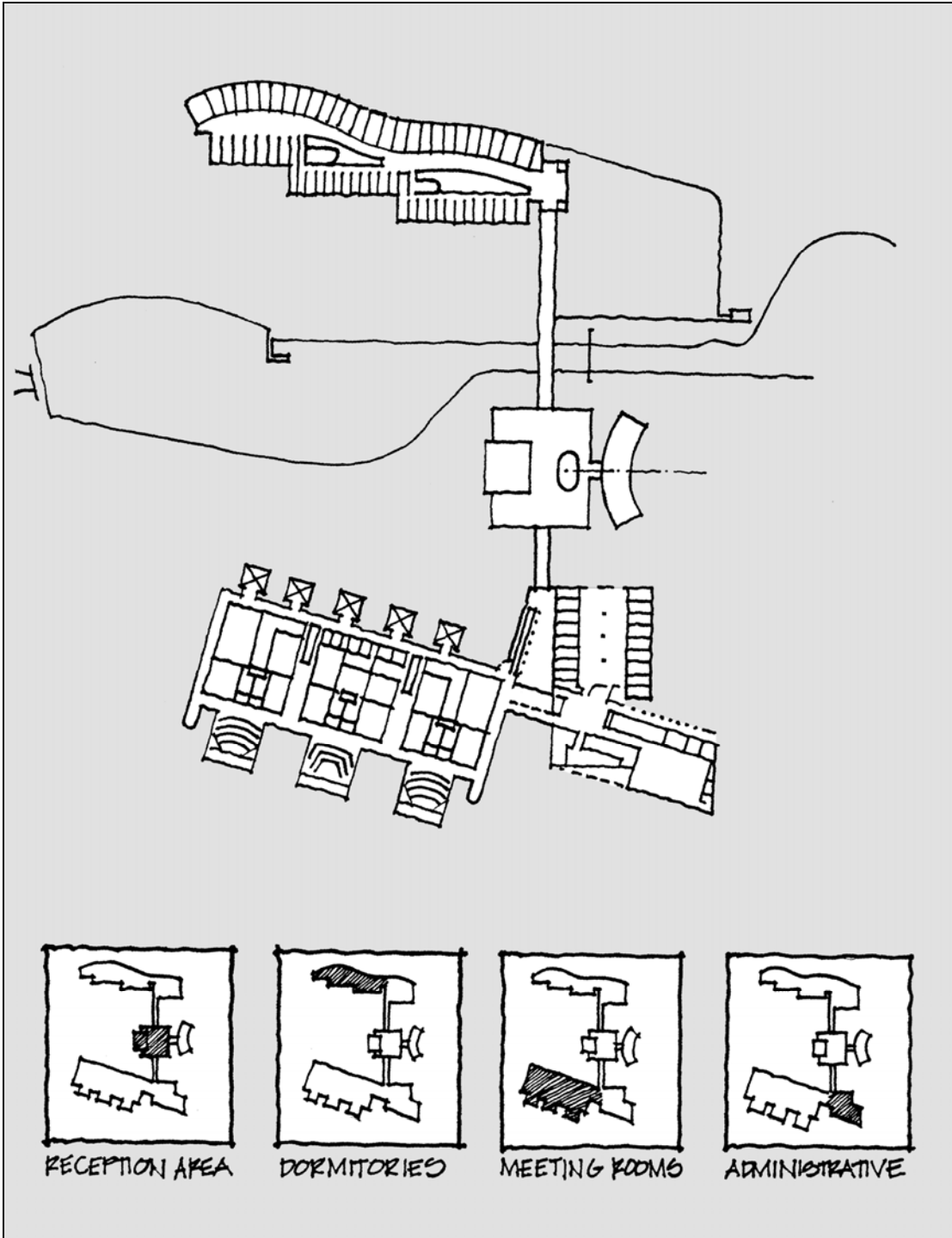

Figure 33: IBM Advanced Business Institute. Plan Configuration.

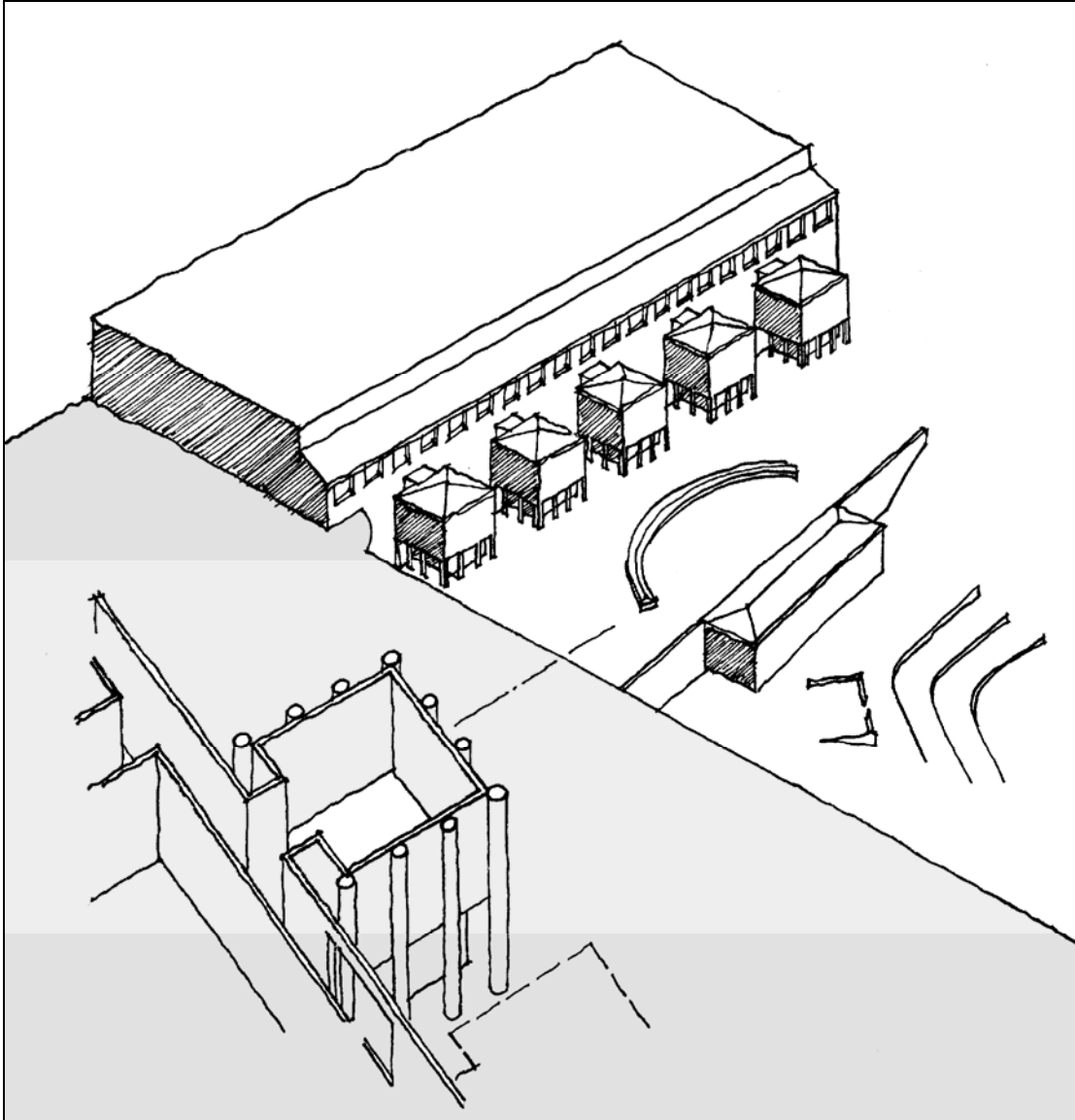

Figure 34: IBM Advanced Business Institute. Break-out Rooms.

The IBM Advanced Business Institute, despite its overwhelming size of 410,000 square feet, appears to exhibit the ideal diagram for the program of a conference center and thus is illustrated here in detail.

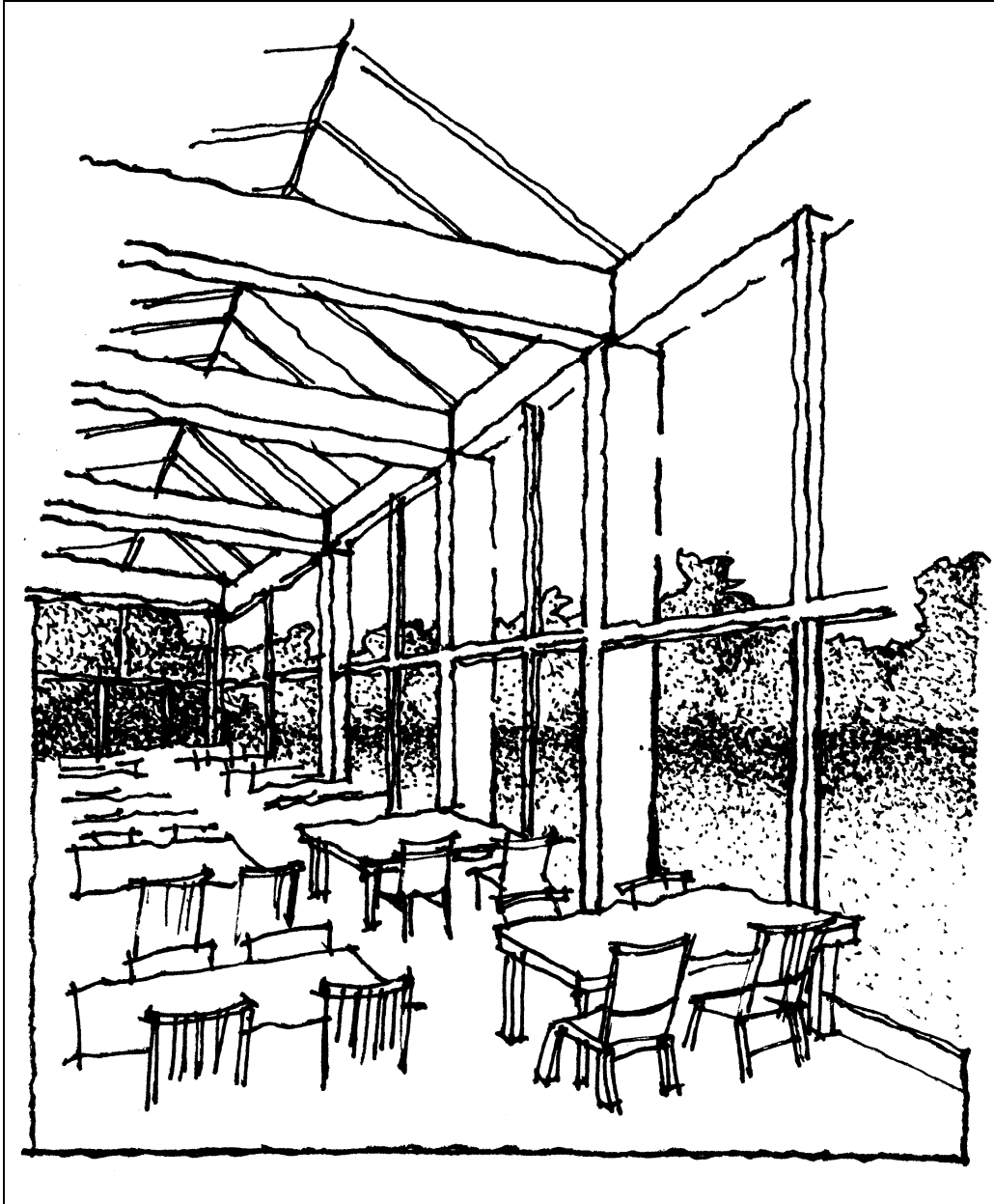

Figure 35: IBM Advanced Business Institute. Original Sketch of Dining Area.

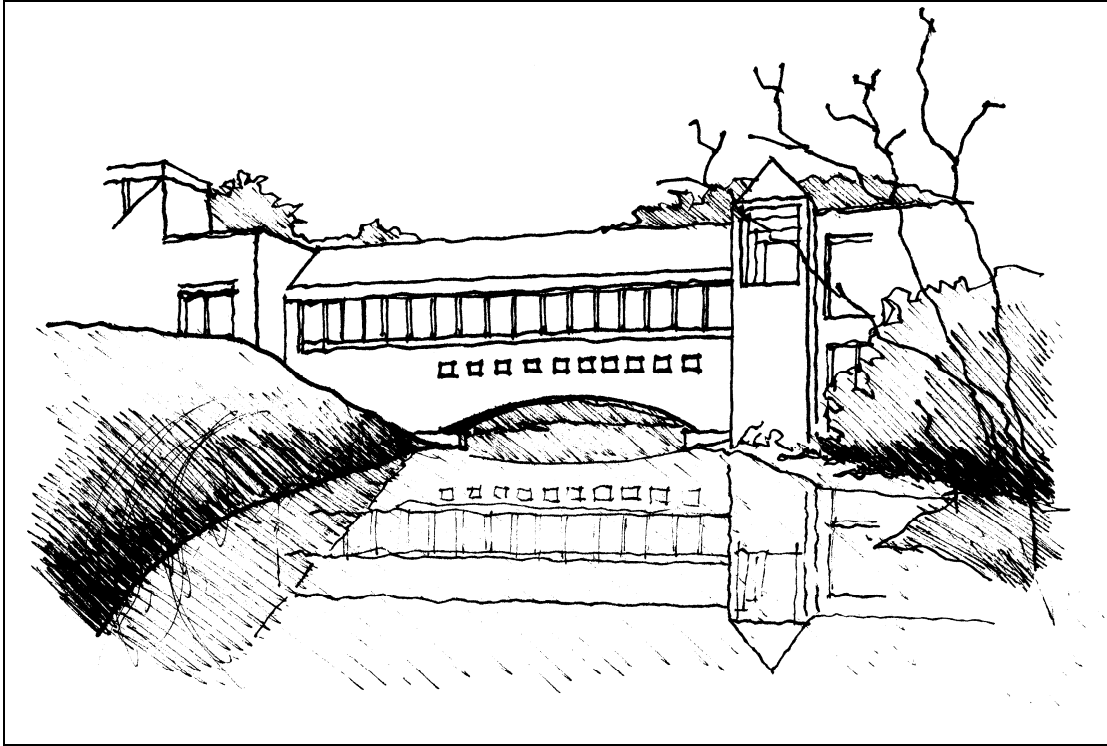

Figure 36: IBM Advanced Business Institute. Original Sketch of Exterior.

Buildings in the Landscape

The architecture illustrated here is used as precedent toward approaches to dealing with the organization of the program or the relationship of the building to the landscape.

- Fallingwater, Bear Run, Pennsylvania
- Salk Institute, La Jolla, California
- Lake Washington House, Seattle
- Pool Pavilion in Pennsylvania by Bohlin Cywinski Jackson
- Katsura Villa, Japan

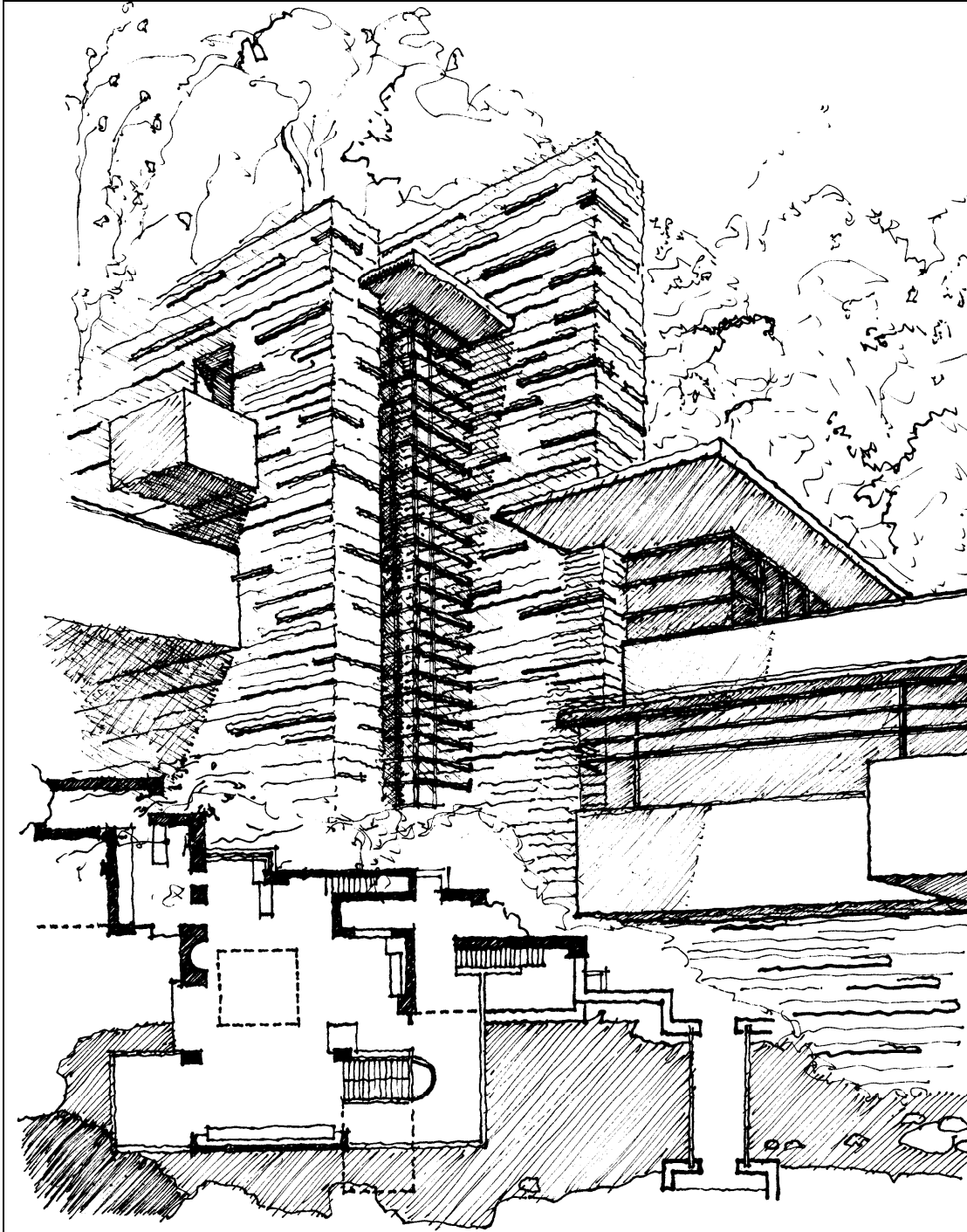

Figure 37: Fallingwater, Bear Run, Pennsylvania. Original Sketch.

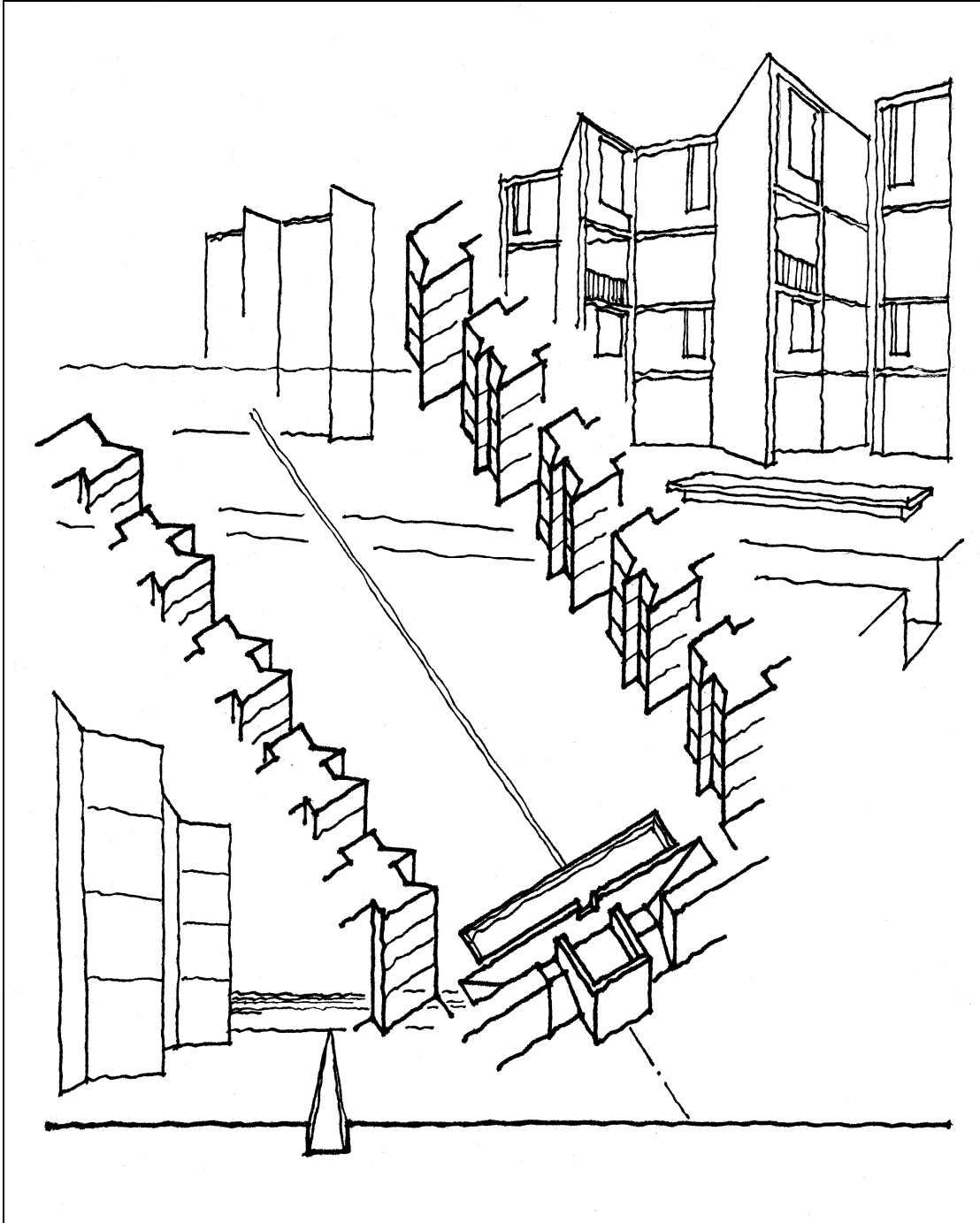

Figure 38: Salk Institute, La Jolla, California. Original Sketch.

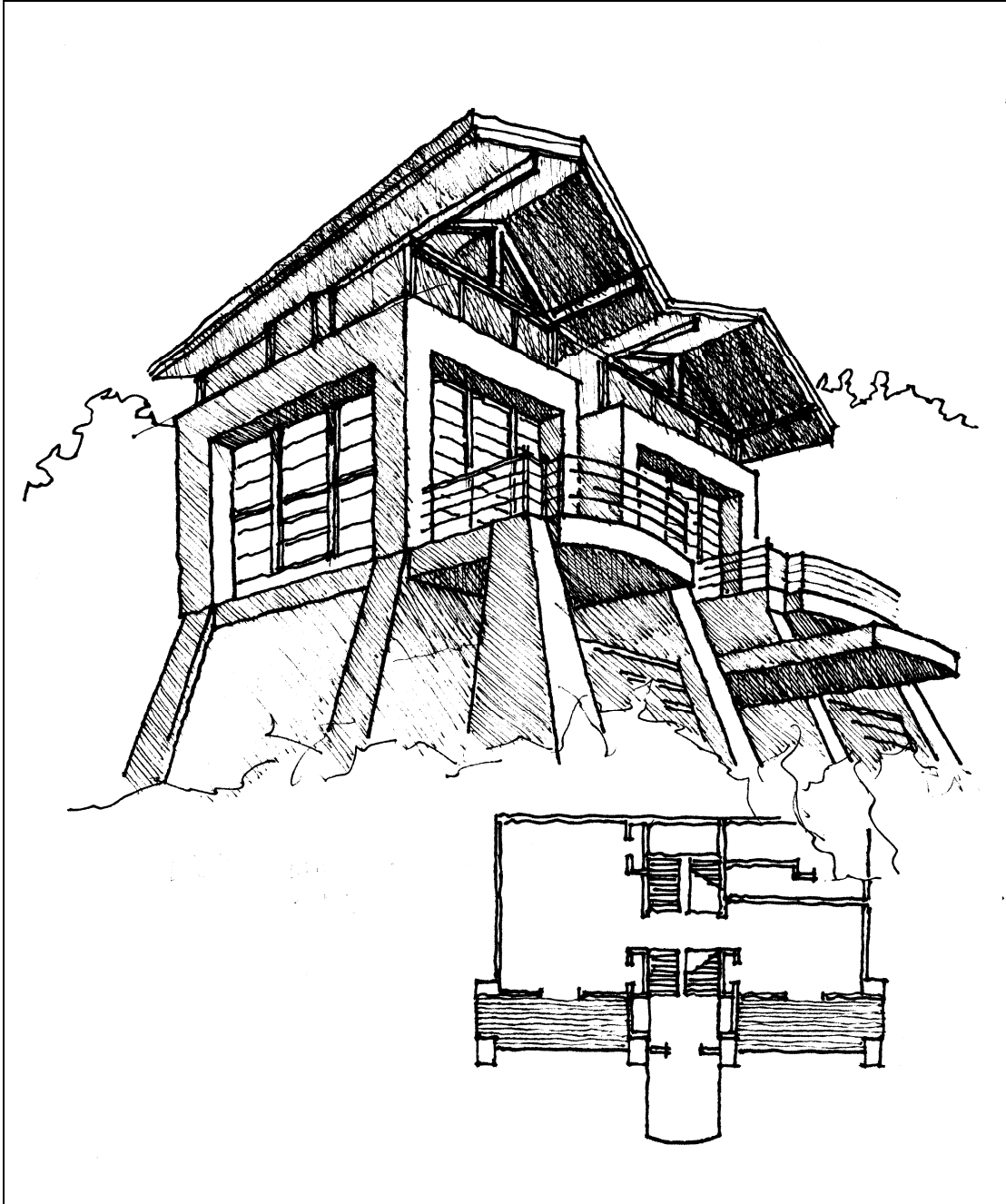

Figure 39: Lake Washington House, Seattle. Original Sketch.

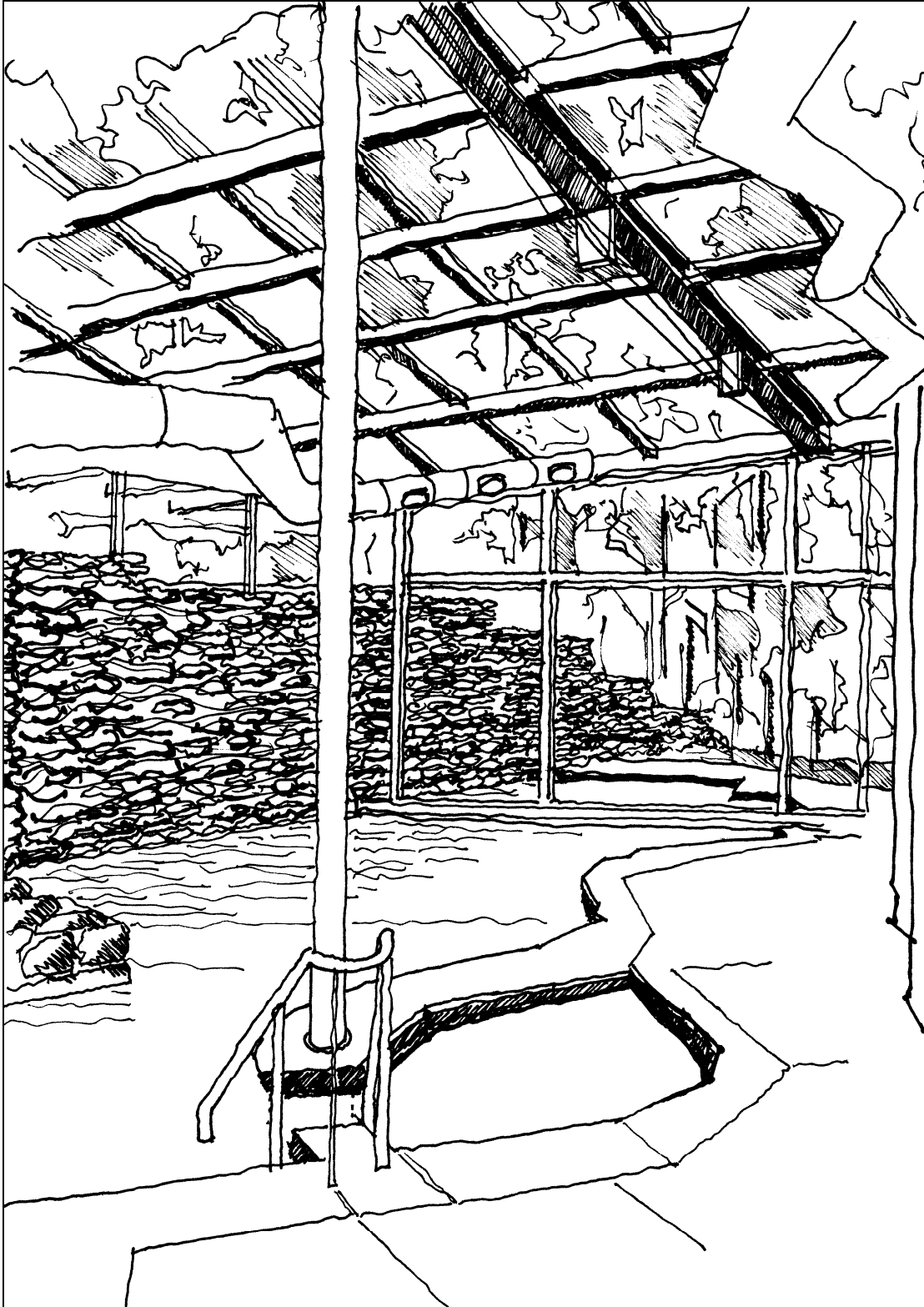

Figure 40: Pool Pavilion in Pennsylvania. Original Sketch.

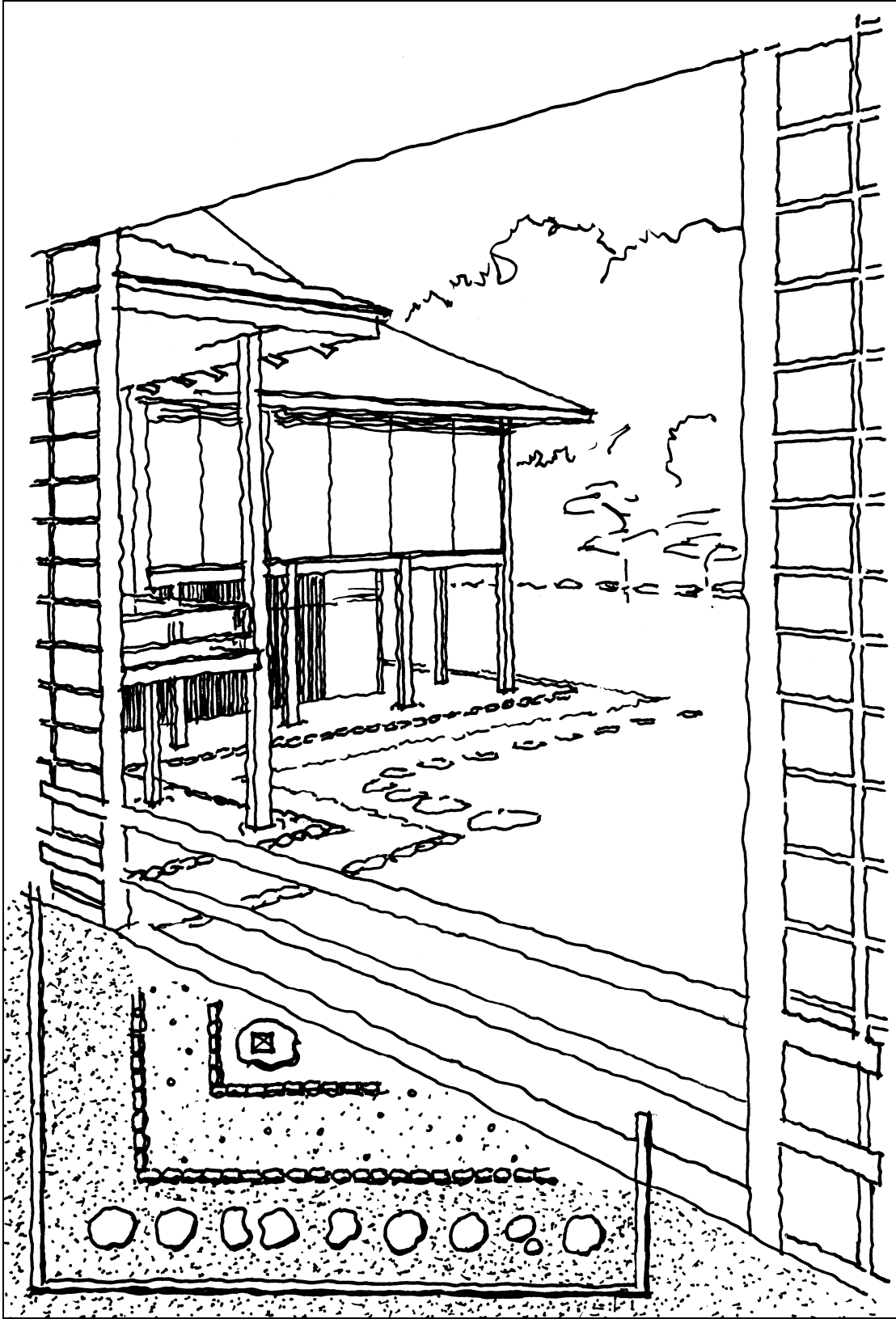

Figure 41: Katsura Villa, Japan. Original Sketch.

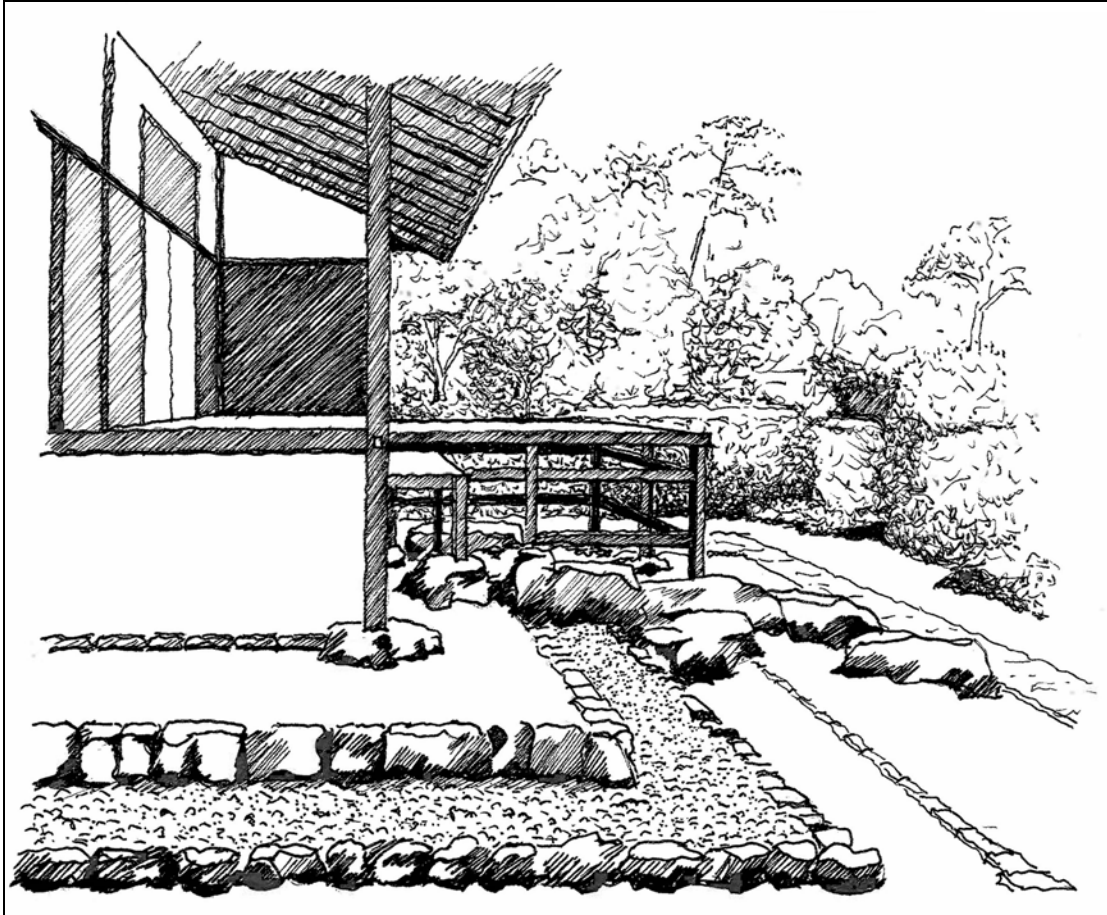

Figure 42: Katsura Villa, Japan-Delineation of Building Edge. Original Sketch.

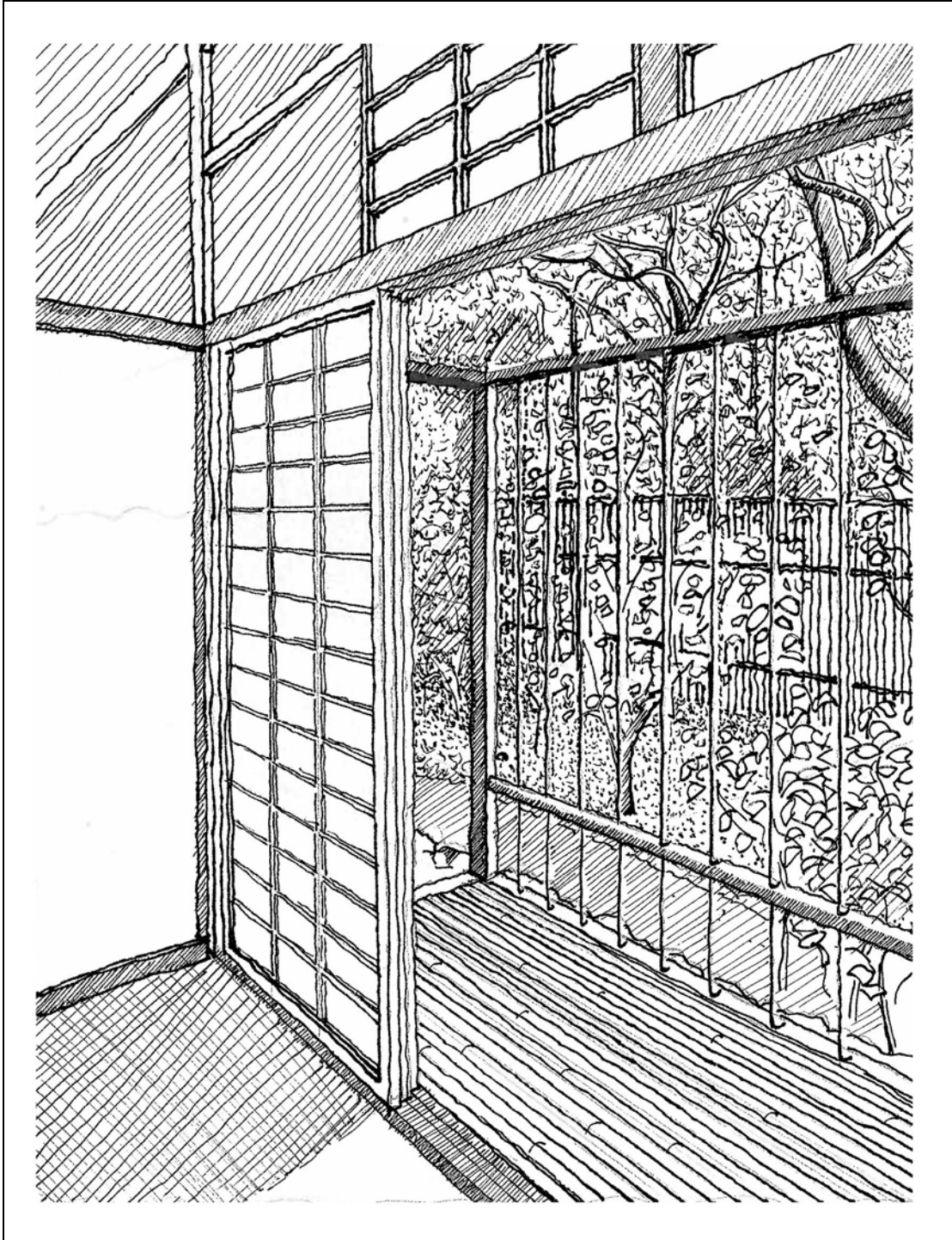

Figure 43: Katsura Villa, Japan-Shoji Screens. Original Sketch.

Vernacular Forms

Precedents listed in this section are forms, not necessarily architectural, that are common to the Chesapeake Bay and the Atlantic coastline. They don't represent opportunities for metaphorical imagery so much as they are a general catalog of local forms that may provide options for material uses and textures and imagery.



Figure 44: Driftwood Washed up Along the Chesapeake Bay



Figure 45: Stone Breakwaters along the Chesapeake.

Details of Assembly

Through the study of various Bohlin, Cywinski Jackson projects and of various Japanese joinery techniques, a strong appreciation for careful detailing became a strong influence in this project. The following illustrations not only describe how careful attention to detailing can help to strengthen the architectural language of the design, but how it can be beautifully and clearly illustrated to depict the relationship and assembly of the parts.

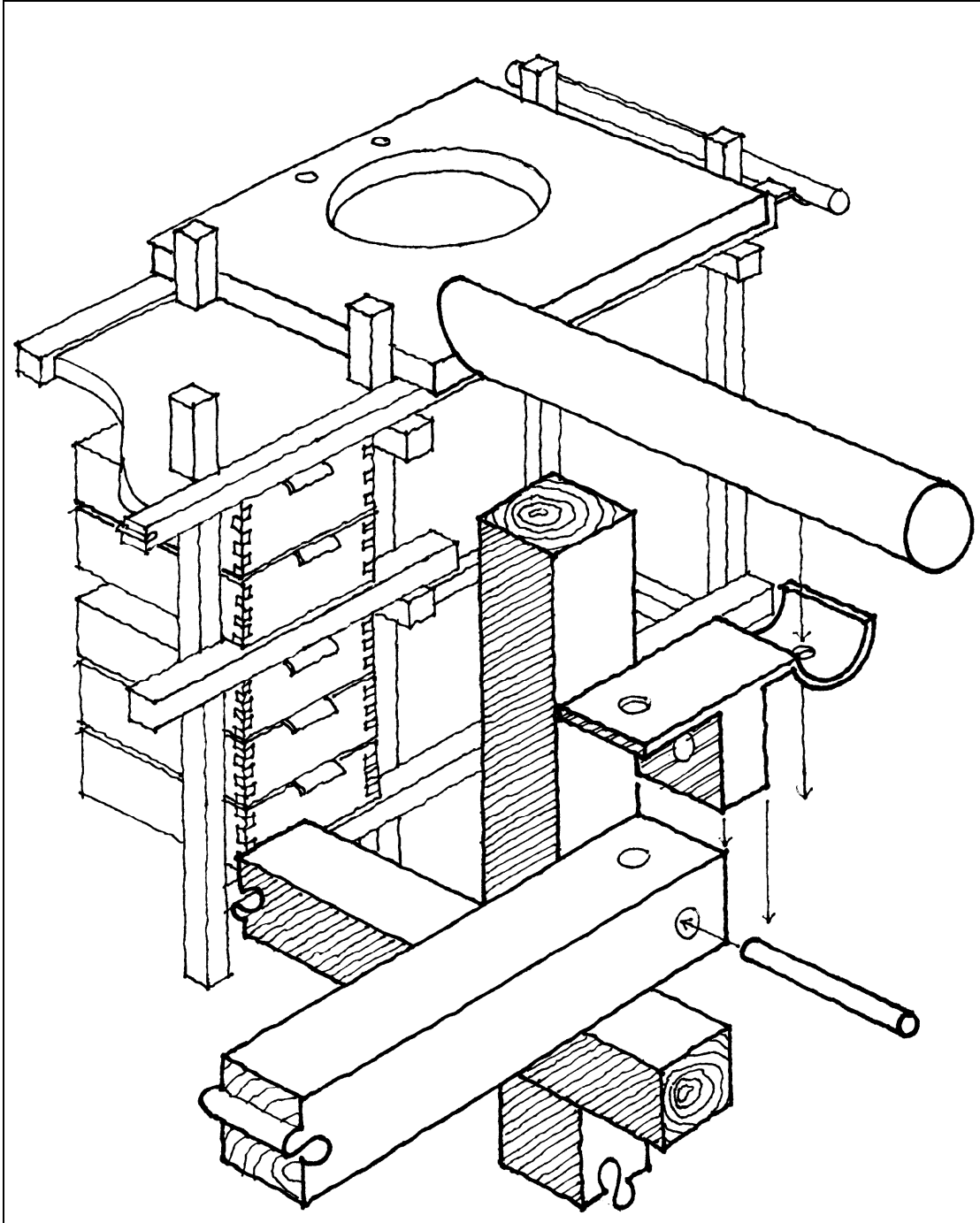

Figure 46: Vanity and Towel Rack, Bohlin Cywinski Jackson. Original Sketch.

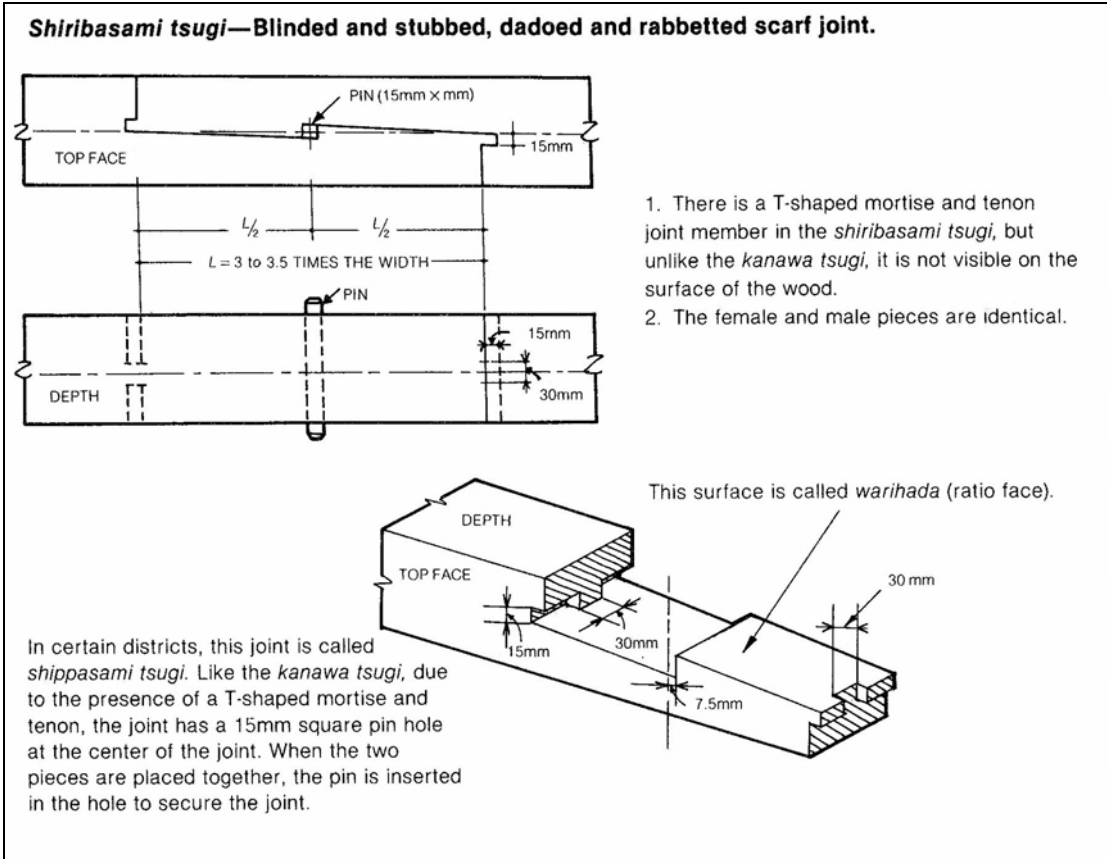

Figure 47: Japanese Joinery – Shiribasami tsugi (scarf joint).¹²

¹² Nakahara, Yasua. *Japanese joinery*, 180.

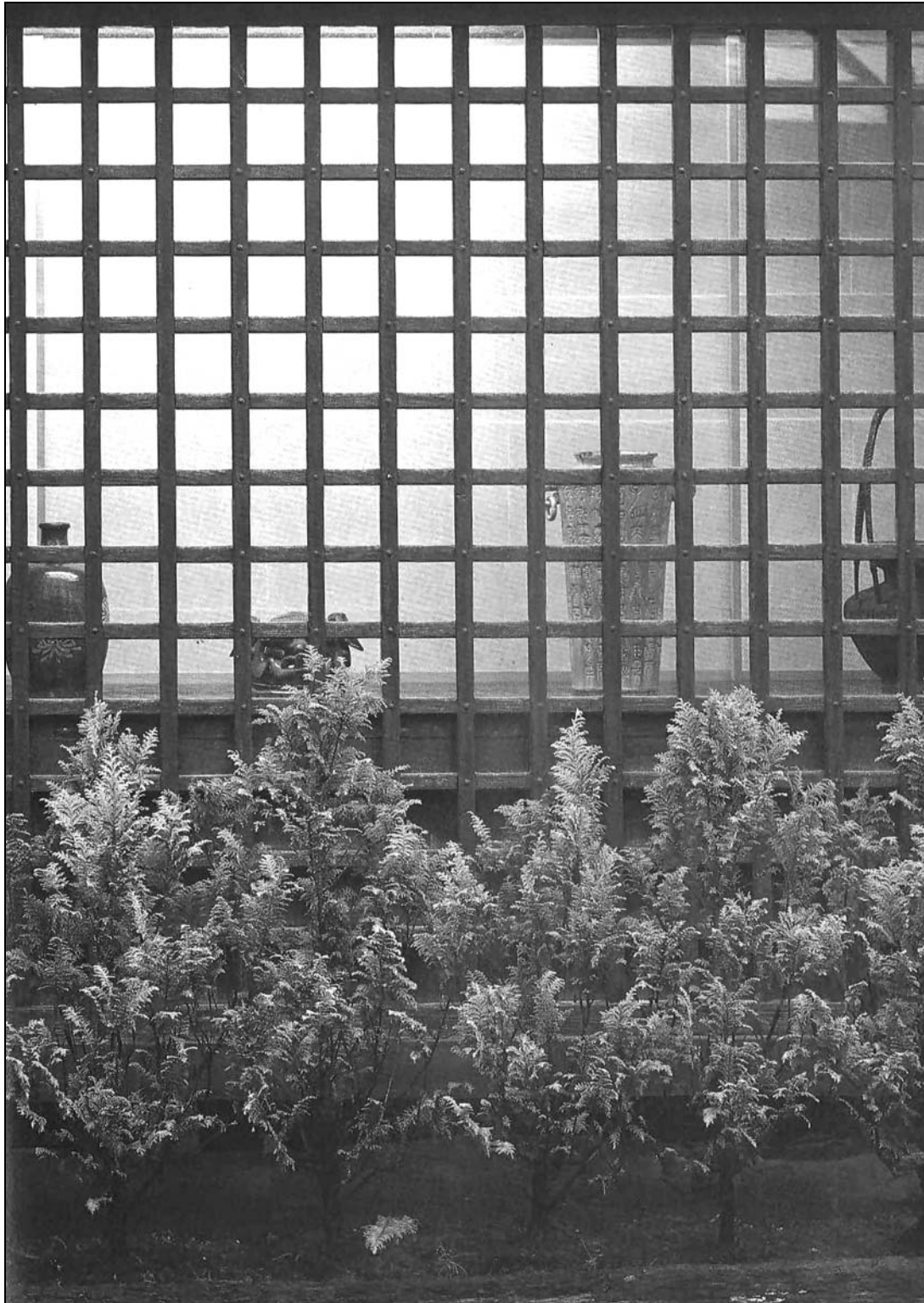

Figure 48: A Lattice Window of a Merchant's House - Takayama, Japan.¹³

¹³ Hibi, Sabao. *Japanese detail architecture*, 55.

Chapter 5: Design Approach

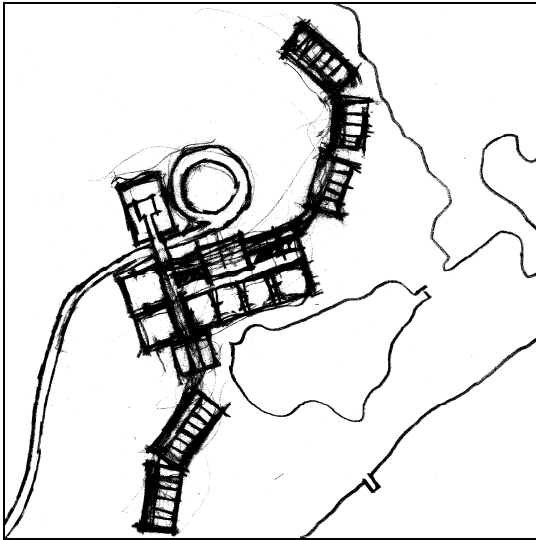

Figure 49: Concept 1 Sketch.

Concept 1

This concept utilizes smaller units that are connected by hexagonal-shaped community rooms. By dividing the guest rooms up into smaller pavilions, the building scale tends to look smaller. The hexagonal community rooms allow the pavilions to turn differently to conform to the landscape and take advantage of the views. The bulky mass of the conference meeting facilities is located in the center to allow easy access from each pavilion. The conference wing is composed of an entrance in the center with a dining hall and kitchen on one side and meeting rooms to the other. Breakout rooms are located in a separate pavilion that is connected to the meeting rooms with a bridge over the access road. The existing cleared path through the park was adapted for the road with a spine of conference parking located to the west side. There are additional spaces allocated for the administrative staff on the entrance loop, and the loading dock is on the west side of the main conference wing.

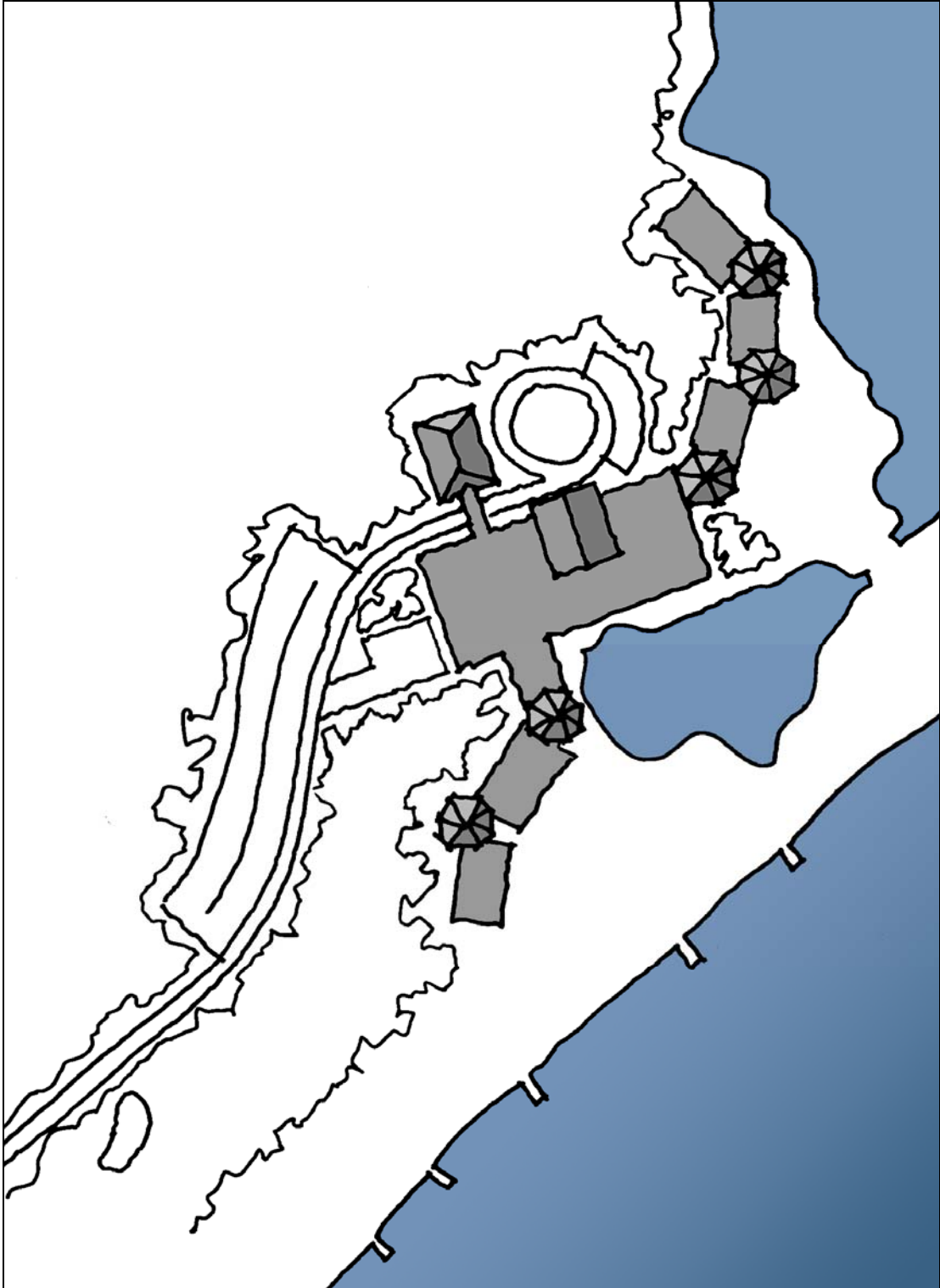

Figure 50: Design Concept 1- Site Plan.
Scale: 1"=200'

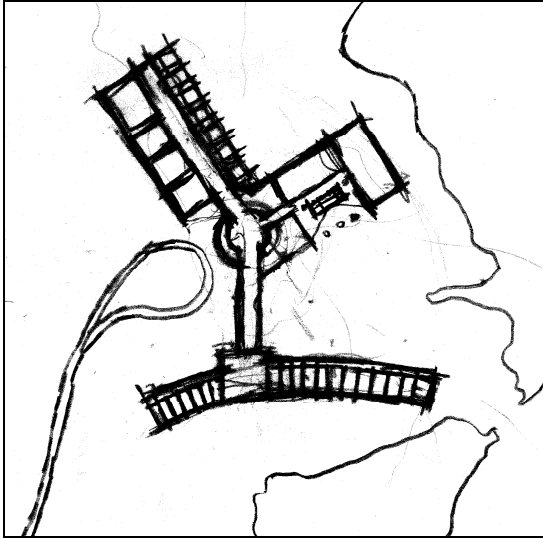

Figure 51: Concept 2 Sketch.

Concept 2

The second concept is a derivative of the GTE Management Development Center. The residential wing is located to the south just above the small pond, and connected to a main lobby area to the north. This main lobby resolves the geometry of two other wings, one houses the meeting spaces and the other houses the dining facilities, service areas, and administrative offices on a second floor.

The center lobby space allows each wing to be rotated appropriately to receive maximum daylight and views. In the dining wing a room is created in the center to act as an informal meeting area before dinner or between meetings. This space is open on the south end to provide a view out toward the Chesapeake. The back of the residential wing draws the eye out towards the bay and at the same time provides a frame for the view on the right side. Again, the existing path was reused as an access road to the building and parking occurs in a more rectangular area tucked into the woods.

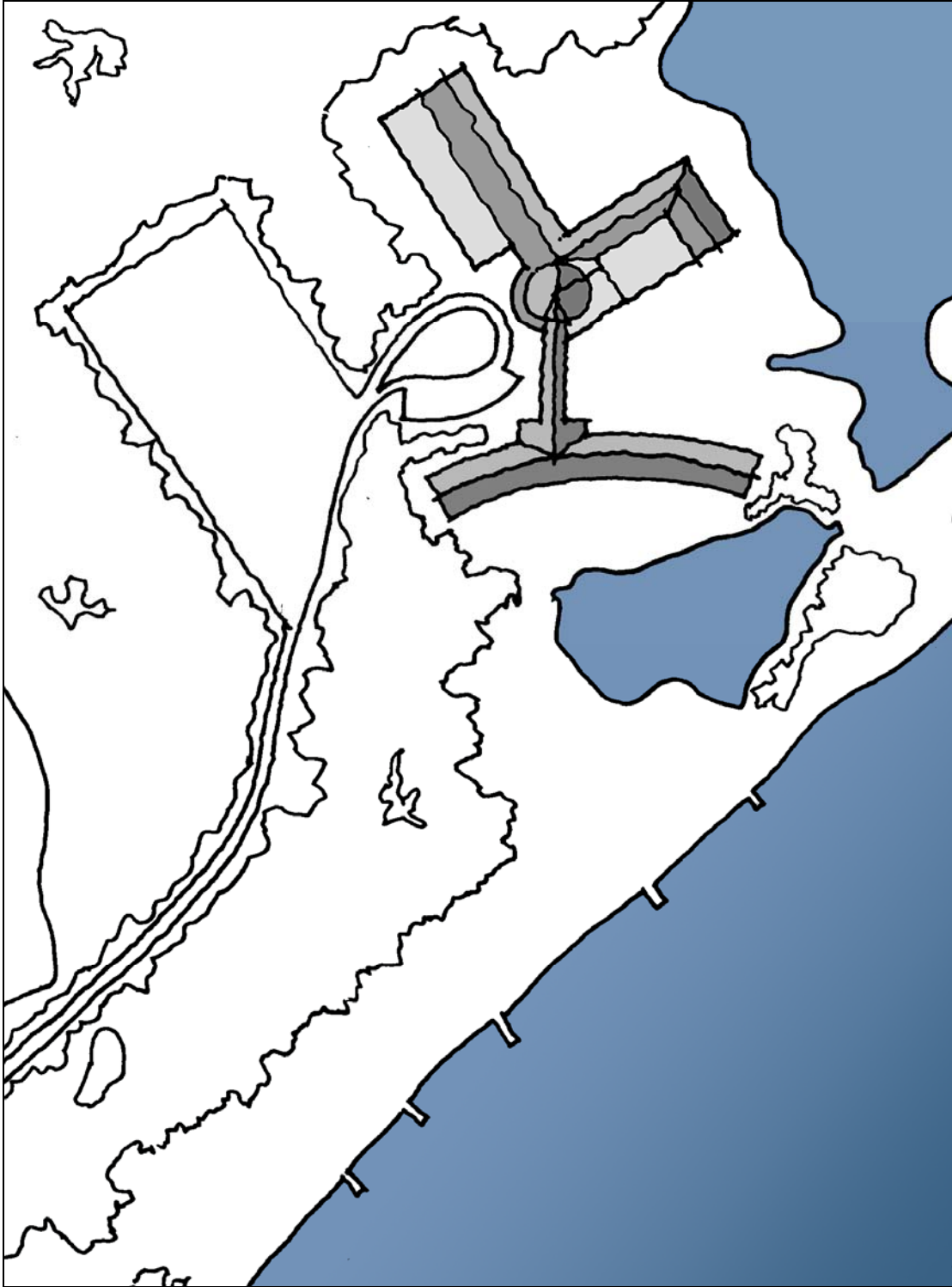

Figure 52: Design Concept 2 – Site Plan.
Scale: 1"=200'

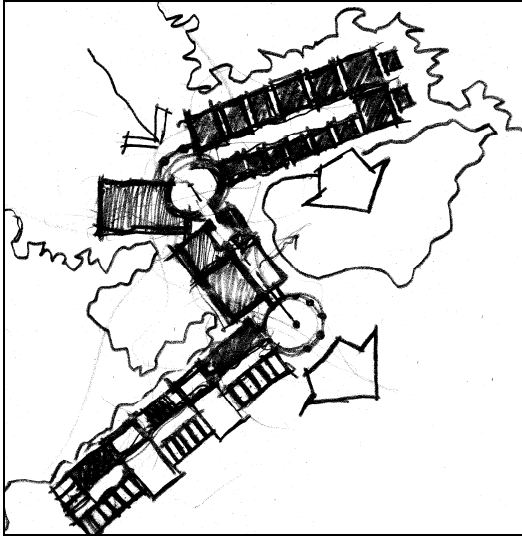

Figure 53: Design Concept 3.

Concept 3

The third concept again separates the residential and meeting facility spaces into wings. Entry is on an axis that is defined by two circular spaces: one an entry lobby and the other a double-height community room. The administrative offices are located to the west of the entry and allow easy access from the parking lot. There is also a loading dock incorporated into this area to serve the kitchen and mechanical areas located in the spine between the residential and meeting wings. In the conference wing, meeting rooms are on the north side facing into the woods to insure a quiet setting. The breakout rooms line the edge at the south side and provide a wide angle view of the pond and the Bay beyond. This view is framed on one side by the two-story community room and by a line of old trees on the other.

The community room itself serves as link between the lobby space and the residential wing and provides a panoramic view of the bay. Additional community areas are located within the residential wing to house exercise and recreation activities.

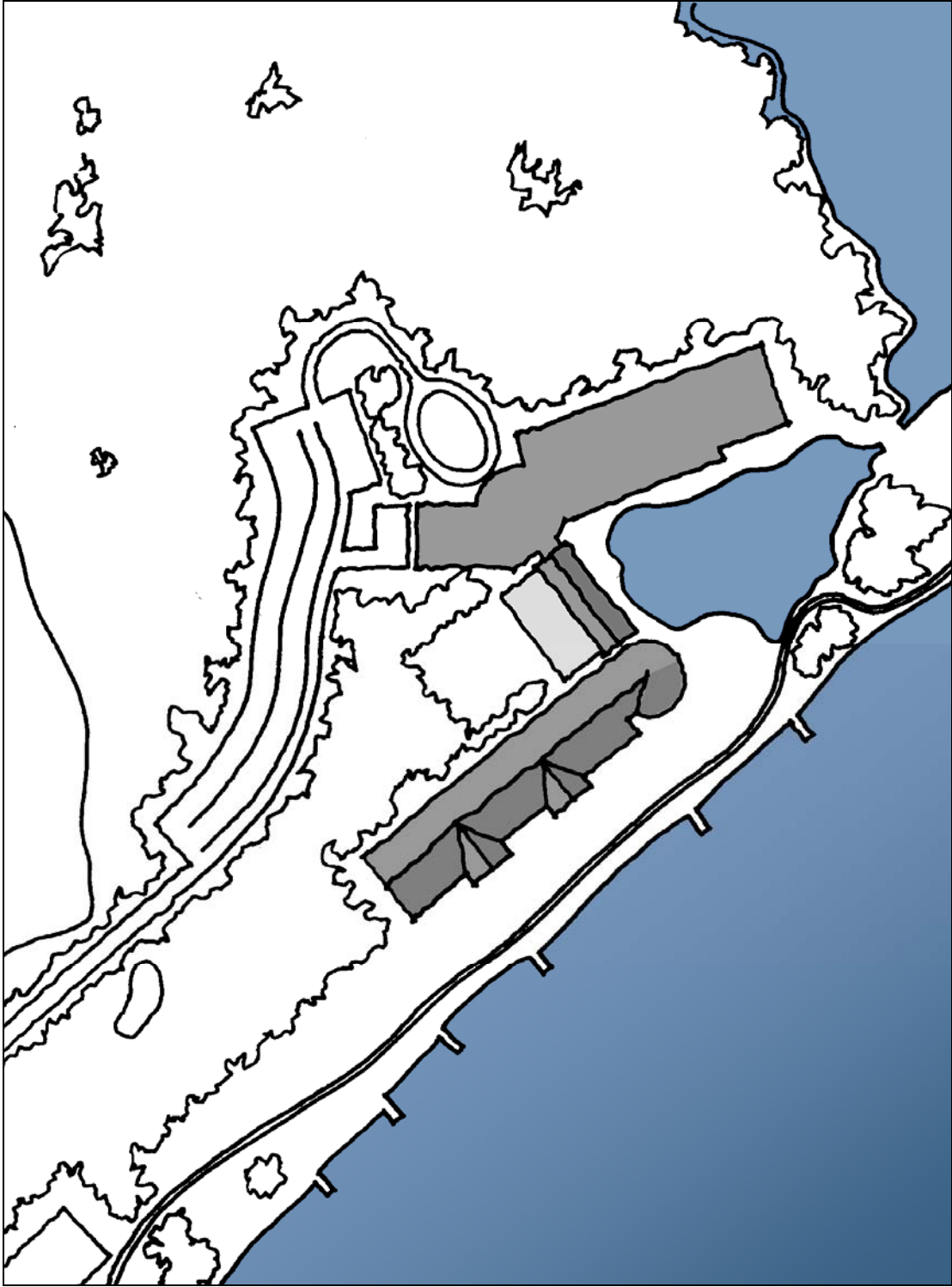

Figure 54: Design Concept 3 – Site Plan.

Chapter 6: Design Conclusion

The previous chapters outlined four distinct goals to be achieved through the design of the Conference Center:

1. To design within the natural environment, being sensitive to the fragile nature of the adjacent landscape.
2. To utilize vernacular forms and materials from not just the immediate area but the Atlantic coastline in general.
3. To provide tranquil, serene spaces for undisturbed conversation as well as several more image-able, large scale spaces.
4. To develop the building details to a finite level, leaving them exposed to the user as an aesthetic component to the design.

Sensitivity to the Natural Landscape

Not only is the preservation of forested property a core concern (as defined in chapter one), but it is a necessary practice that protects the delicate banks of the Chesapeake Bay. The Conference Center utilizes the existing gravel path as an entry drive, with only minimal disturbance to the forest for additional paths and walkways. No walking/driving surfaces are paved in asphalt – pea stone gravel is used instead. An innovative new mesh fabric which allows grass to growth through it covers the parking areas. The fabric essentially disappears under the growth of the lawn, and what could have been a sea of asphalt is transformed into a green pasture beneath the tree canopy.

The obvious need to connect the conference areas to the dormitories was addressed somewhat differently. A wooden boardwalk extends between the buildings, introducing a familiar coastal aesthetic to the design and allowing a

permeable earth surface to continue underneath. Edges of the walkway are lined in stones that were left on the site from the construction of jetties years ago.

Placement of the main conference building on the site was another important matter. Since excessive re-grading would destroy too much forest, the largest of the conference buildings was placed on an existing flat area located far enough away from the Bay to be within code restrictions. This area is made up of fairly new tree growth, mostly deciduous. Some clearing is necessary in order to construct the facility, but this is limited by keeping the footprint small and forming a courtyard in the center. During construction the courtyard will provide a central staging area for building materials and machinery. After the building is complete, the courtyard will house the major outdoor recreation areas for the building and allow the forest to remain undisturbed on the outside, virtually creeping right up to the building's outer walls. Areas that must be disturbed by construction will be replanted with flowering trees such as pear trees, dogwoods, and crabapples.

Trees that are cleared for the courtyard and parking areas will be sent to a laminated wood beam factory and re-used for the main ingredient to the laminated wood timbers in the building. All other solid wood timbers will be collected and re-sawn from old beams found in dilapidated barns and factories in the area.

Another method that will minimize environmental impact on a more global perspective includes using passive solar design by adding a continuous loggia around the second floor. The loggia increases the effectiveness of the large roof overhangs in protecting the interior spaces from mid-day solar gain. In each building operable windows are also used to facilitate natural cooling with the breezes that travel along

the Chesapeake. Existing trees, especially evergreens, are taken advantage up to provide shading for the interior spaces.

The nature of a significantly landscaped site necessitates a large grounds-keeping facility. In an effort to minimize impact and separate service functions from the conference meeting facility, the existing steel and glass pavilions at the southern most part of the site will be reused for grounds-keeping and greenhouse functions.

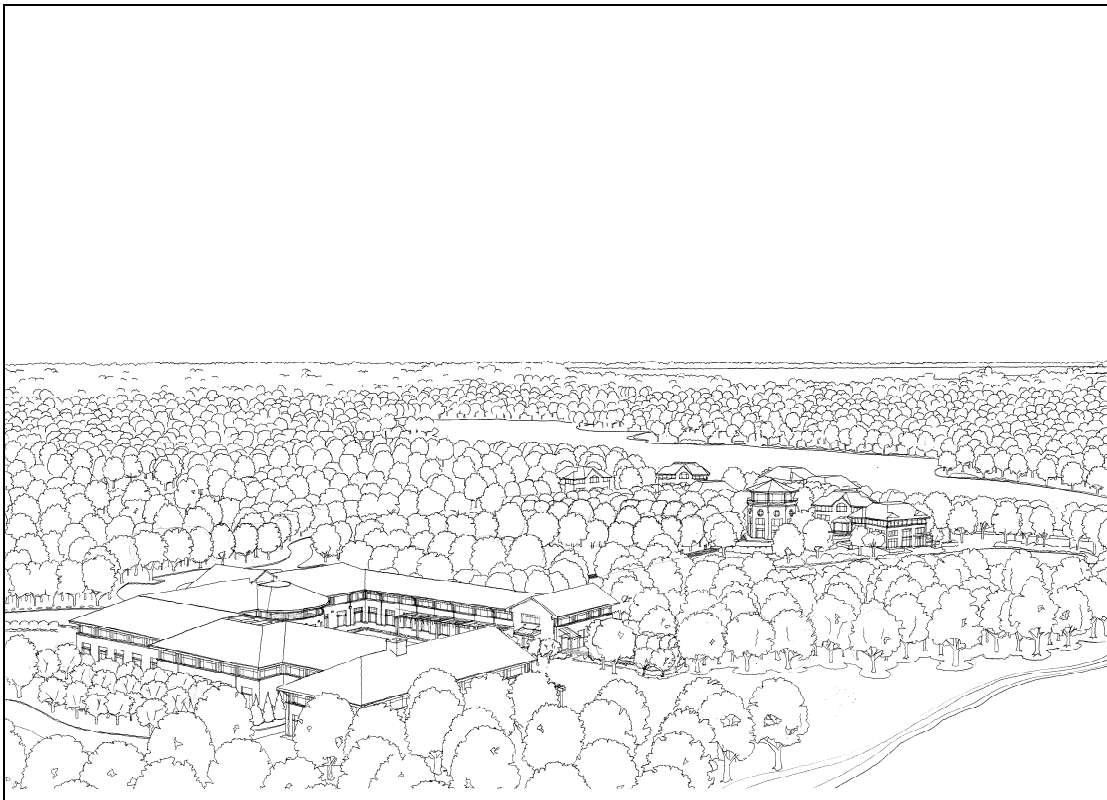

Figure 55: Bird's-Eye View.

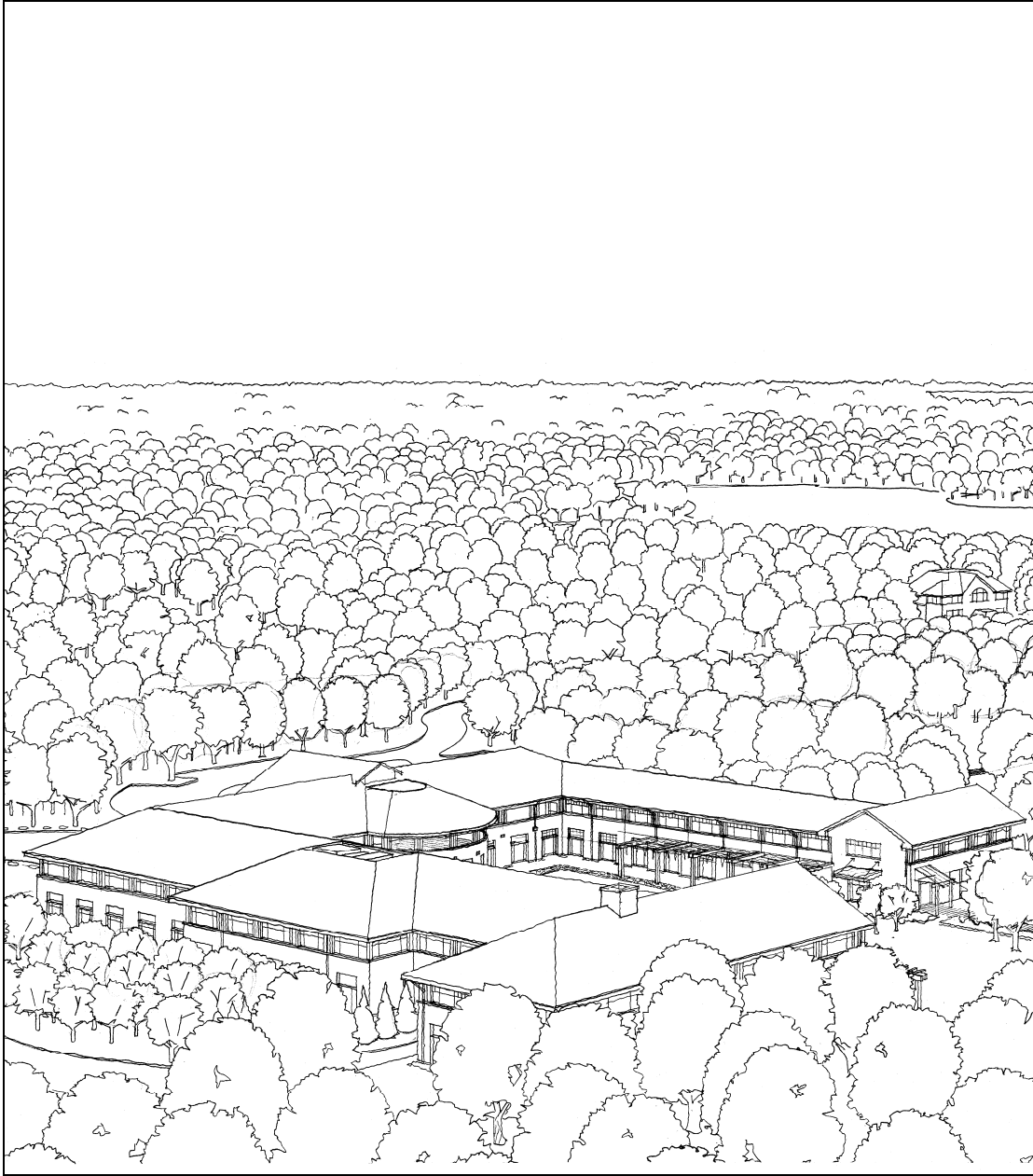

Figure 56: Partial Enlargement of Bird's-Eye View.

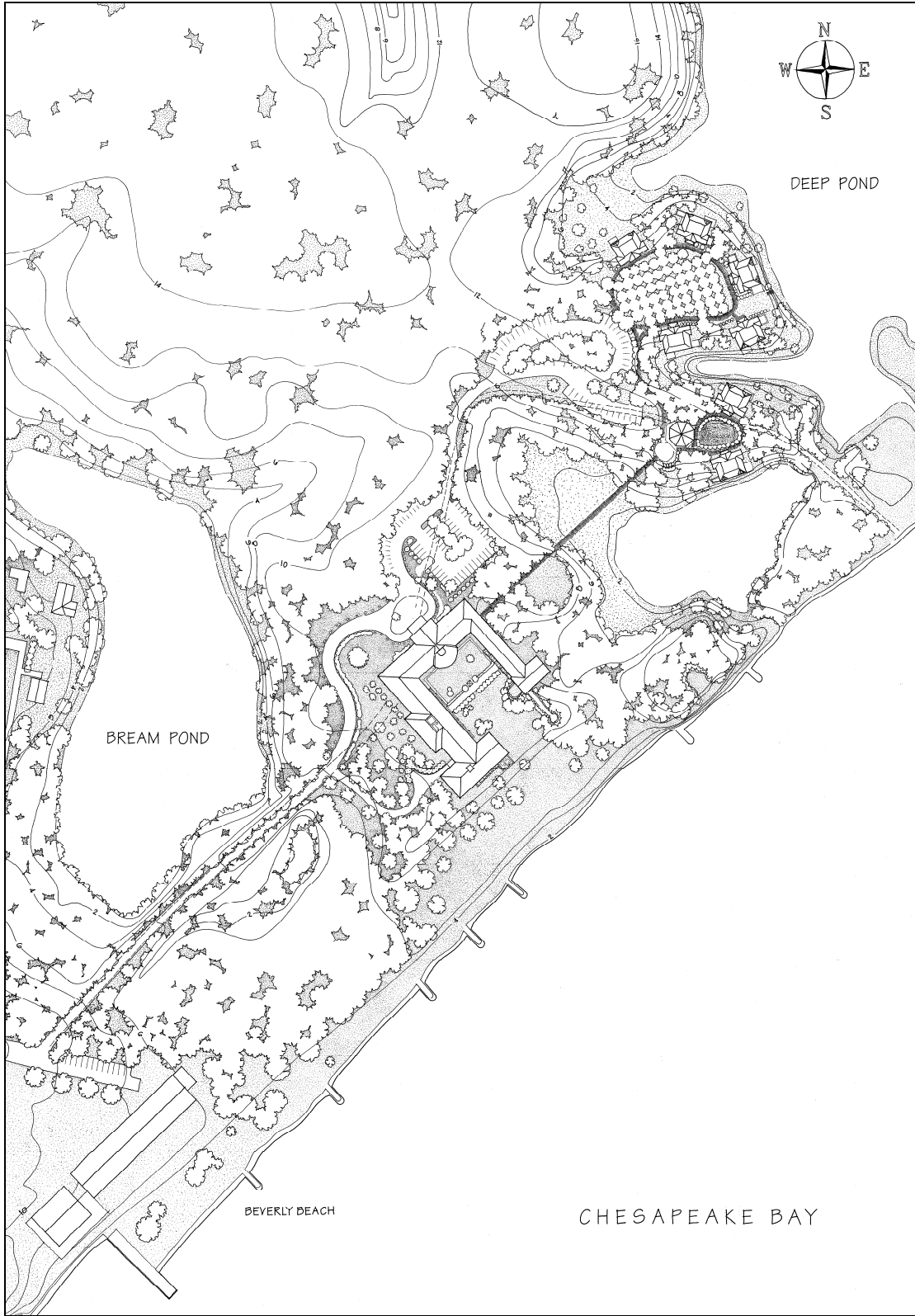

Figure 57: Site Plan.

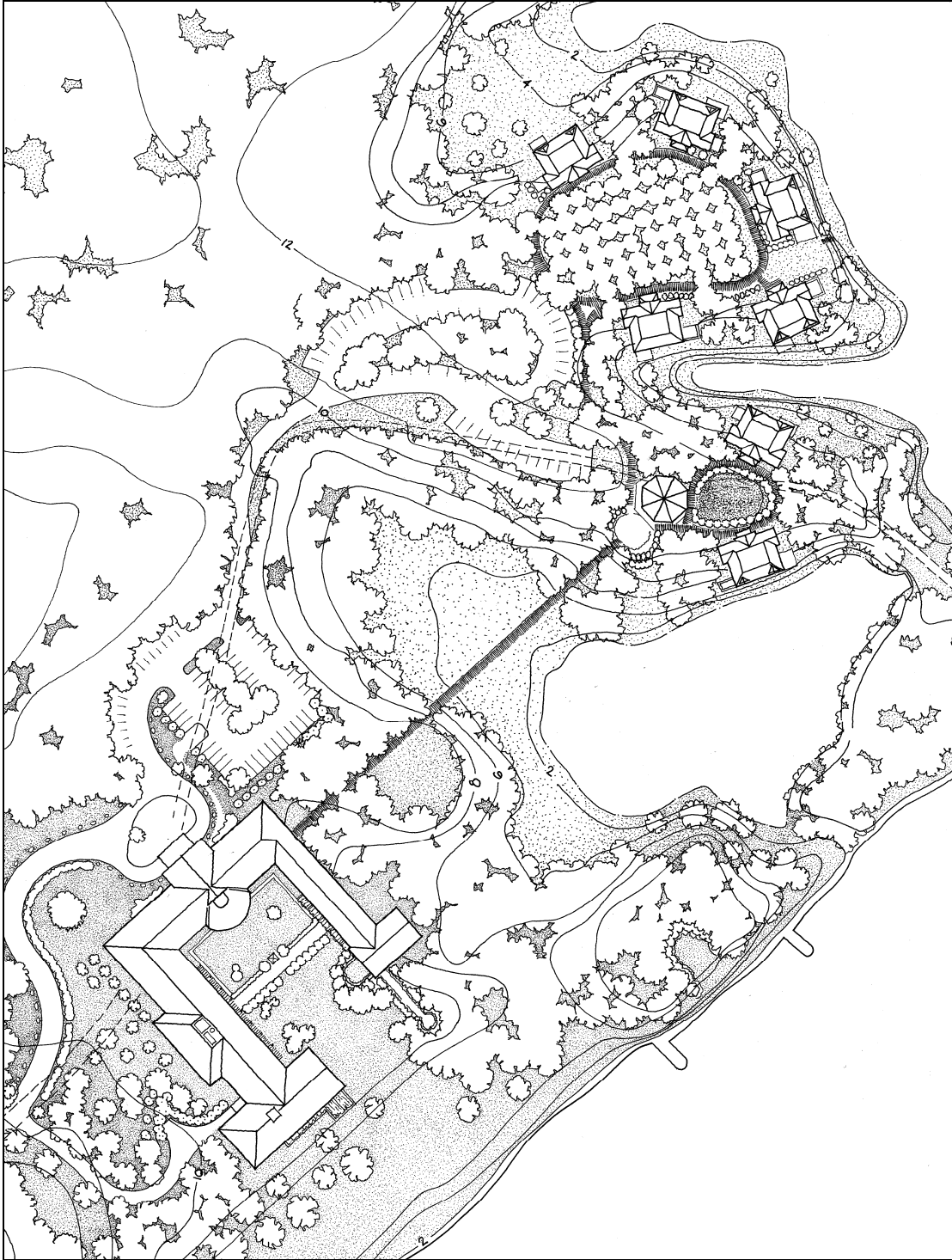

Figure 58: Partial Enlargement of Site Plan.

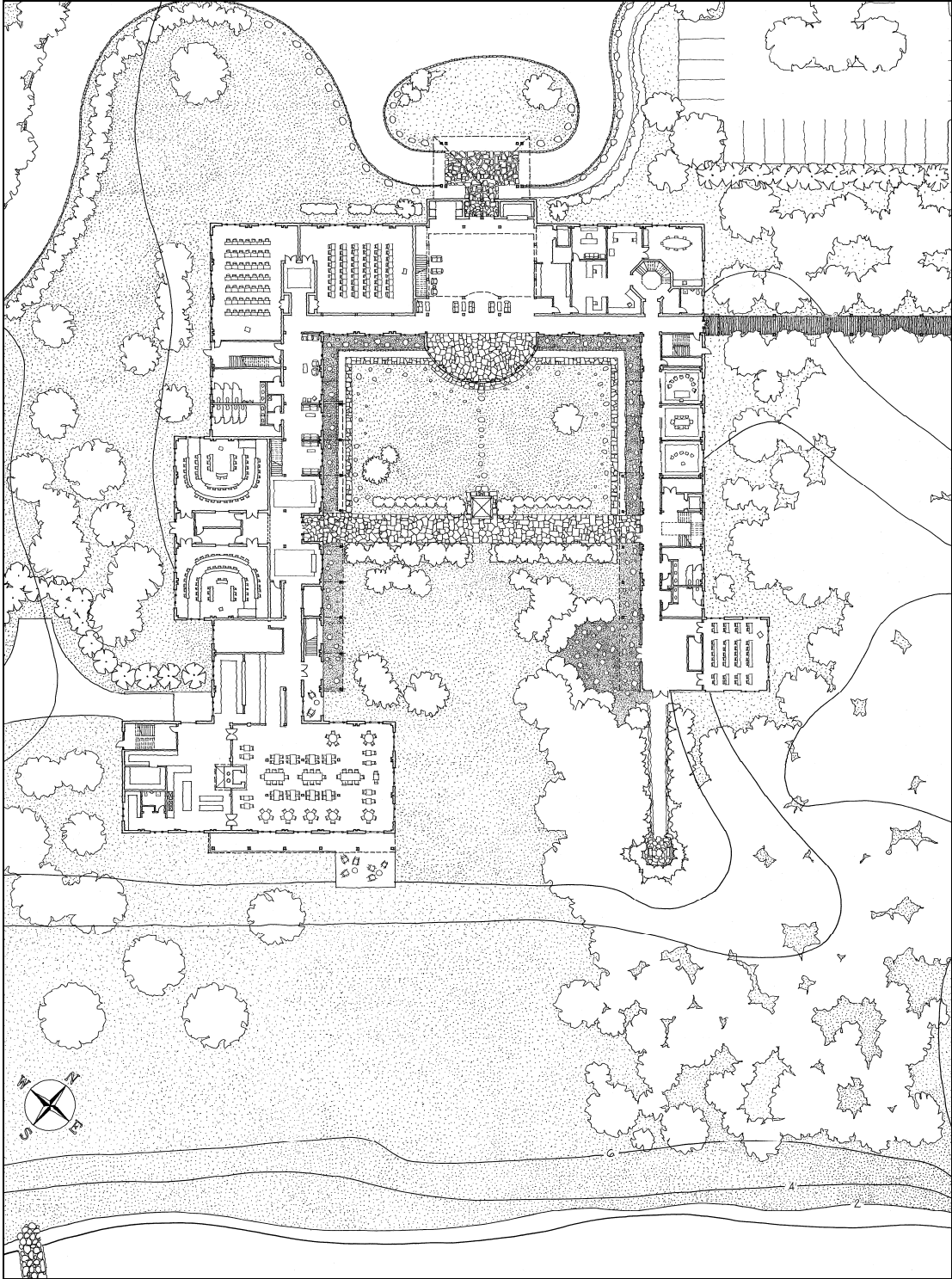

Figure 59: Garden-Level Plan.

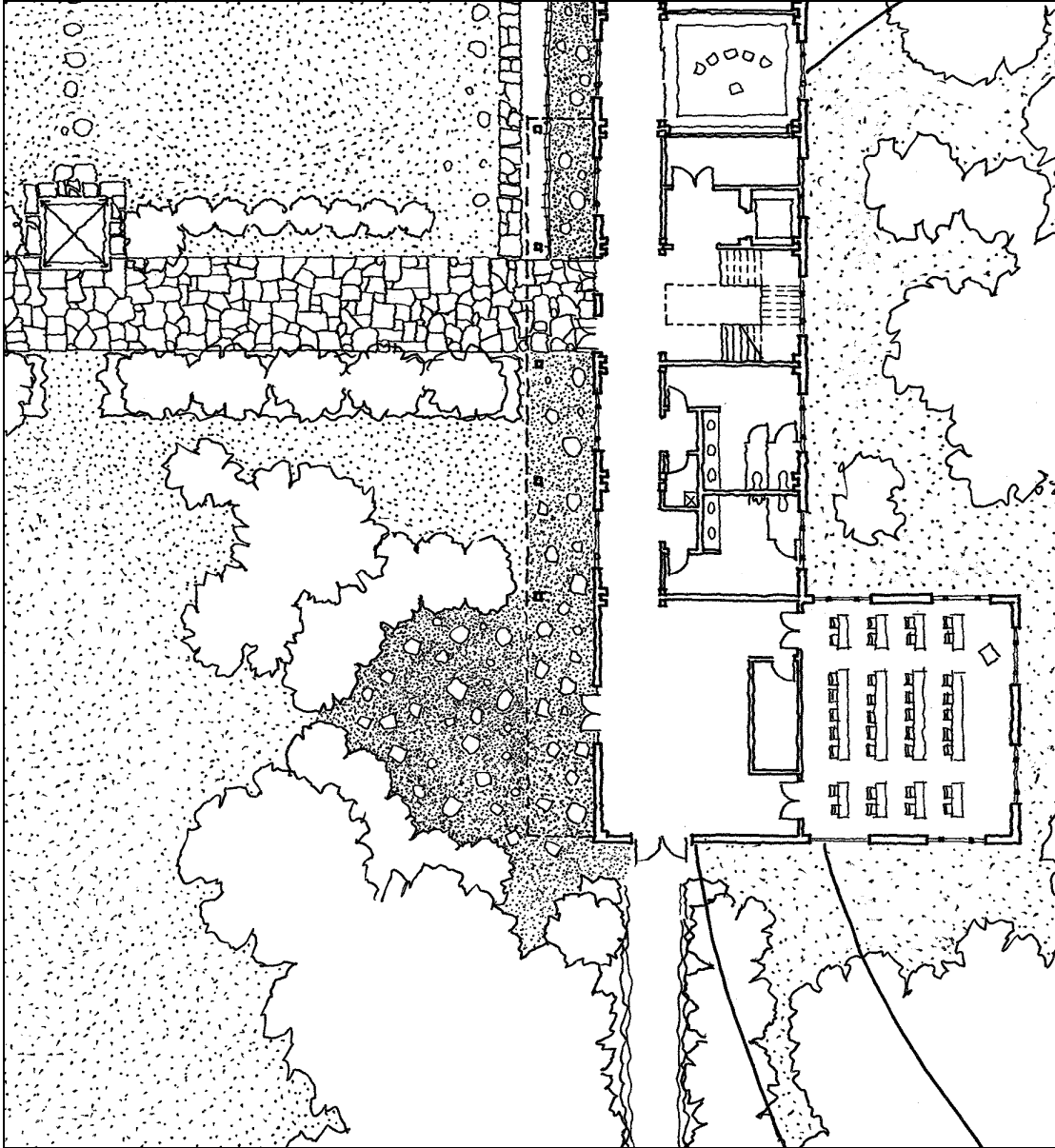

Figure 60: Partial Enlarged View of Garden-Level Plan.

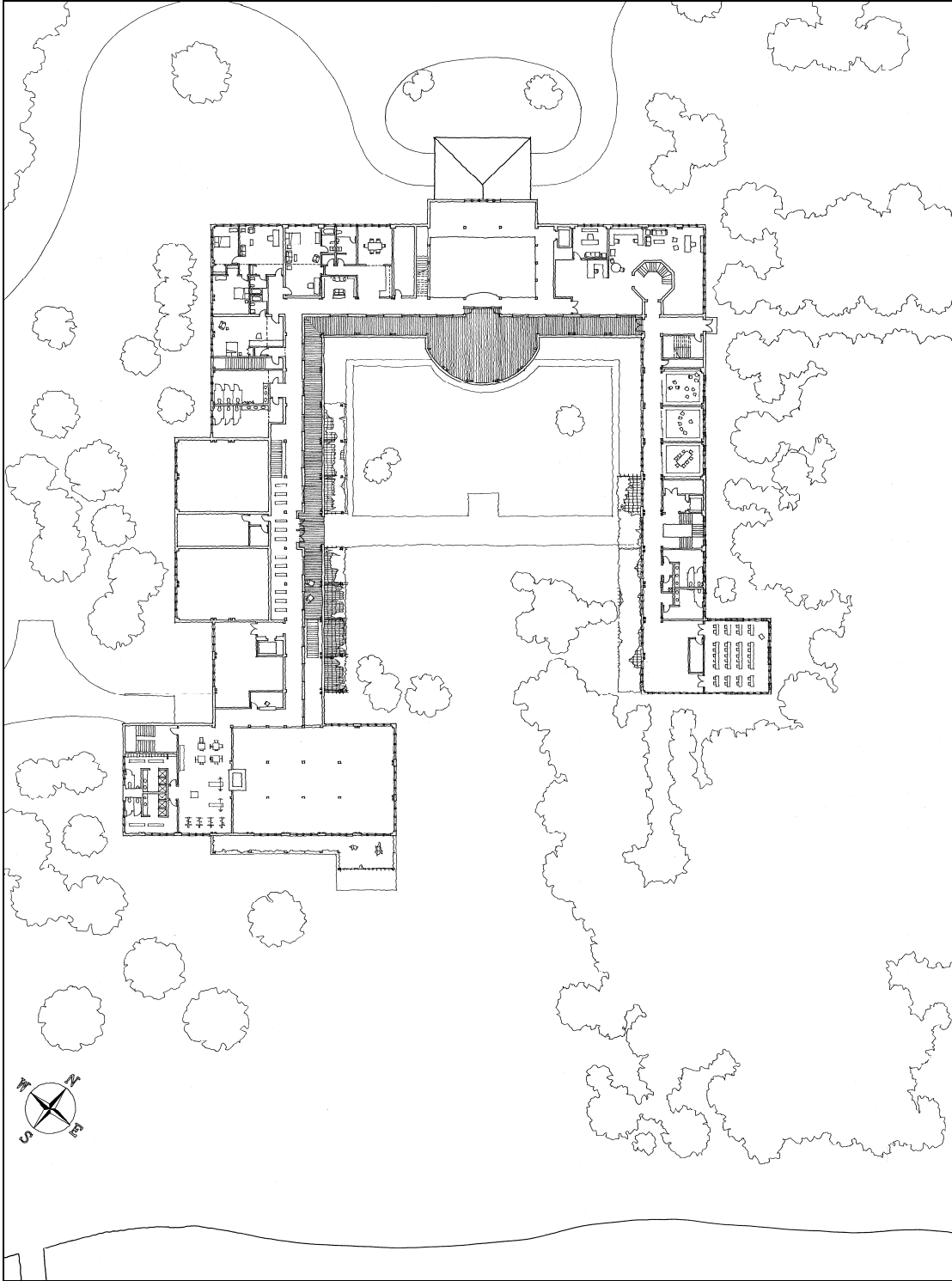

Figure 61: 2nd Level Plan.

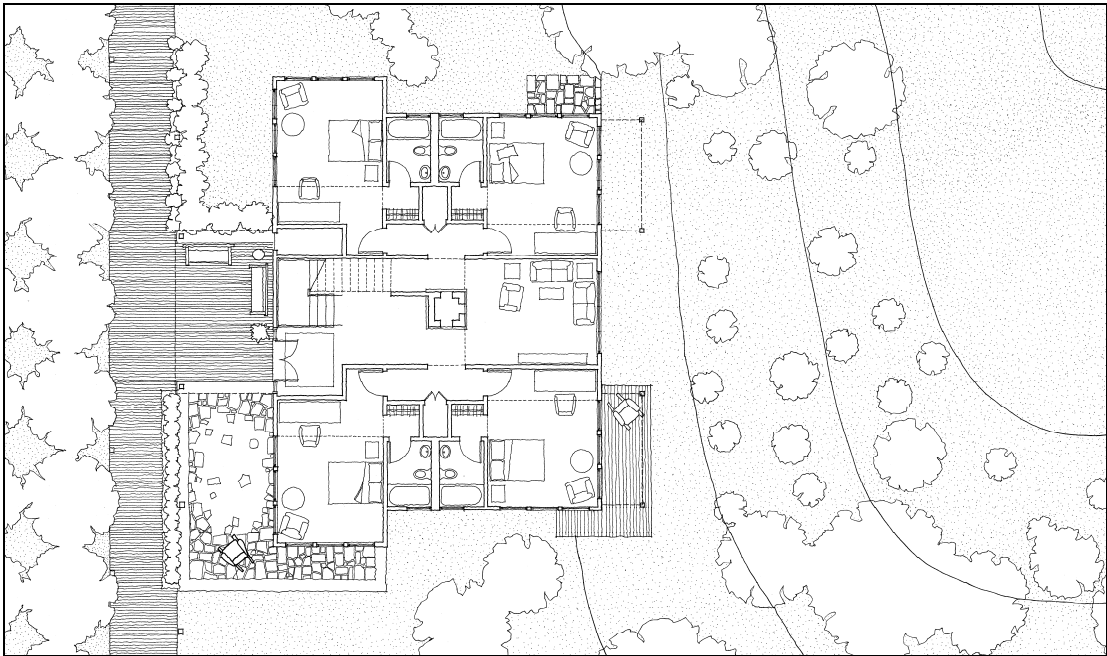

Figure 62: Residence Buildings- Plans and Elevations.

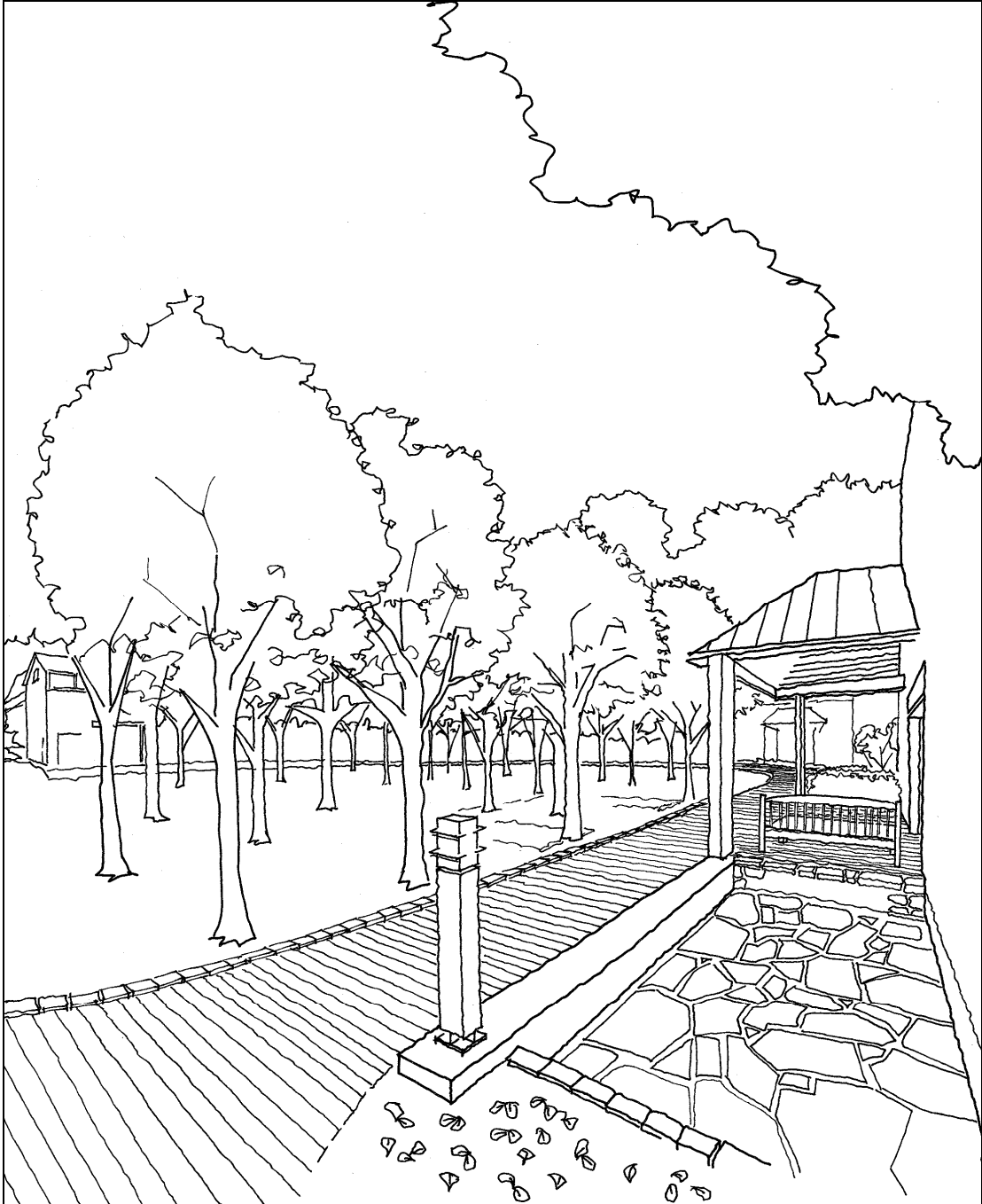

Figure 63: View of Walkway around the Residential Court.

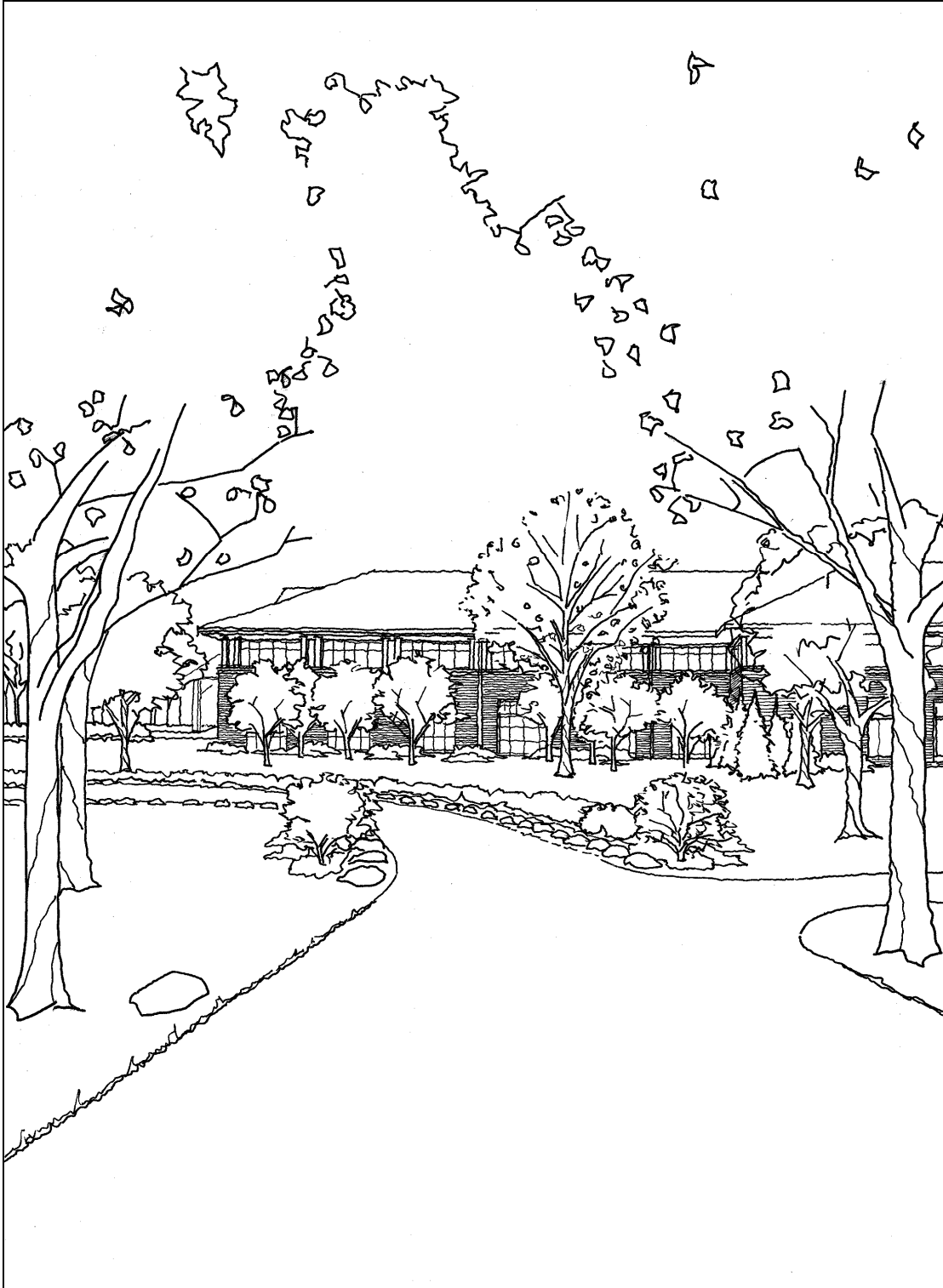

Figure 64: View from Entrance Drive.



Figure 65: Porte Cochere.

Utilization of Vernacular architecture

The wooden boardwalk between the conference center buildings has already been noted as an icon that is familiar to this coastal region, but several other steps have been taken to provide the building with an inherently vernacular aesthetic. Used as a beacon to gather conference attendees from the dormitories, the 3 ½-storey library takes on the distinct look of a lighthouse that could be at home anywhere along the Atlantic. The library sits precariously on the edge of a rock-paved clearing and alerts the pedestrian of this clearing from far beyond the edge of the forest, much like a lighthouse would do for sea-going traffic. From the waters of the Chesapeake, the library is the only structure that protrudes significantly above the tree line and is a valid navigation point marking the western shore. The breezeway allows conference attendees to enjoy a 360-degree view and to see first-hand the delicate transition between land and water.

The use of reclaimed timbers was mentioned above as a technique to minimize the use of new wood. With this material comes a very distinct aesthetic. A quick drive to the Eastern Shore of the Chesapeake reveals many barn structures, some of them hundreds of years old. In the conference center design, a post and beam structure not unlike the familiar barns of the past has been utilized for the Dining Hall and Entry Hall. Both spaces have clear-spans that necessitate large timbers, and the beauty of the old growth wood adds a richness and warmth to the interior spaces that would be difficult to obtain with conventional lumber or steel.

The conference center actually exhibits two building materials found within the Mid-Atlantic region – wood and brick. Brick, often present in the Georgian style architecture of nearby Annapolis, is used here to clad the first floor of the conference

facility below the tree line and denote the areas of the program that are generally public spaces. As the building reaches above the canopies and the program becomes increasingly private, a wood-clad wall takes over. The construction of these walls, mainly along the loggia and the upper floor windows, is made up of a unique ship-lapped process and clear-finished to withstand the elements. The entire assemblage of wood exhibits boat-like craftsmanship and a method that is time-proven and reliable for weather-protection.



Figure 66: Library.

Image-able and Intimate Space

The conference center program introduces the need for very large meeting spaces. These areas are the memorable spaces within the design. The first, the entry hall, greets the conference attendee at arrival. Following are the amphitheaters, the meeting rooms, and the dining hall. Their significant structural wood spans, the way some of them carefully frame views of the shoreline and the very nature of the conversation within their walls insure that they will not soon be forgotten by the conference attendees. These rooms are constructed with an equal amount of wood and brick construction, attention to detailing, and window/wall/surface treatment throughout, thereby setting the pace for the architectural style of the entire center.

Additional to the large program spaces needed in the program, a conference center requires smaller, more personable places for small groups of attendees to gather and share in more intimate conversation. Along the main hallway strung between the entry hall and the dining hall are a series of seating areas providing a more private place to wait for admittance into the amphitheater or to have a more intimate dinner conversation. The seating varies in each area, and some of them allow exit into the courtyard.

On the opposite side of the courtyard is defined by a wing that houses the break-out rooms, rooms that small groups of attendees can use to hold less formal conversations. These rooms have entirely flexible furnishings, and can be opened or closed to the hallway with shoji screens. The screens allow varying degrees of privacy and help filter late afternoon sunlight from the southwest.

Not all of the rooms fall within the walls of the conference facility walls. A small garden is carved out of the forest along the axis created by the northeast

conference wing, allowing groups to enjoy the outdoors. Terraces extend from the residences out to the boardwalks to invite informal conversations and gatherings, much like front porches and sidewalks would do in a small town. The open-air loggia invites couples to stroll along the second floor much like a boat deck taking advantage of the sweeping views, or perhaps just enjoying a book from the library from one of the porch chairs.

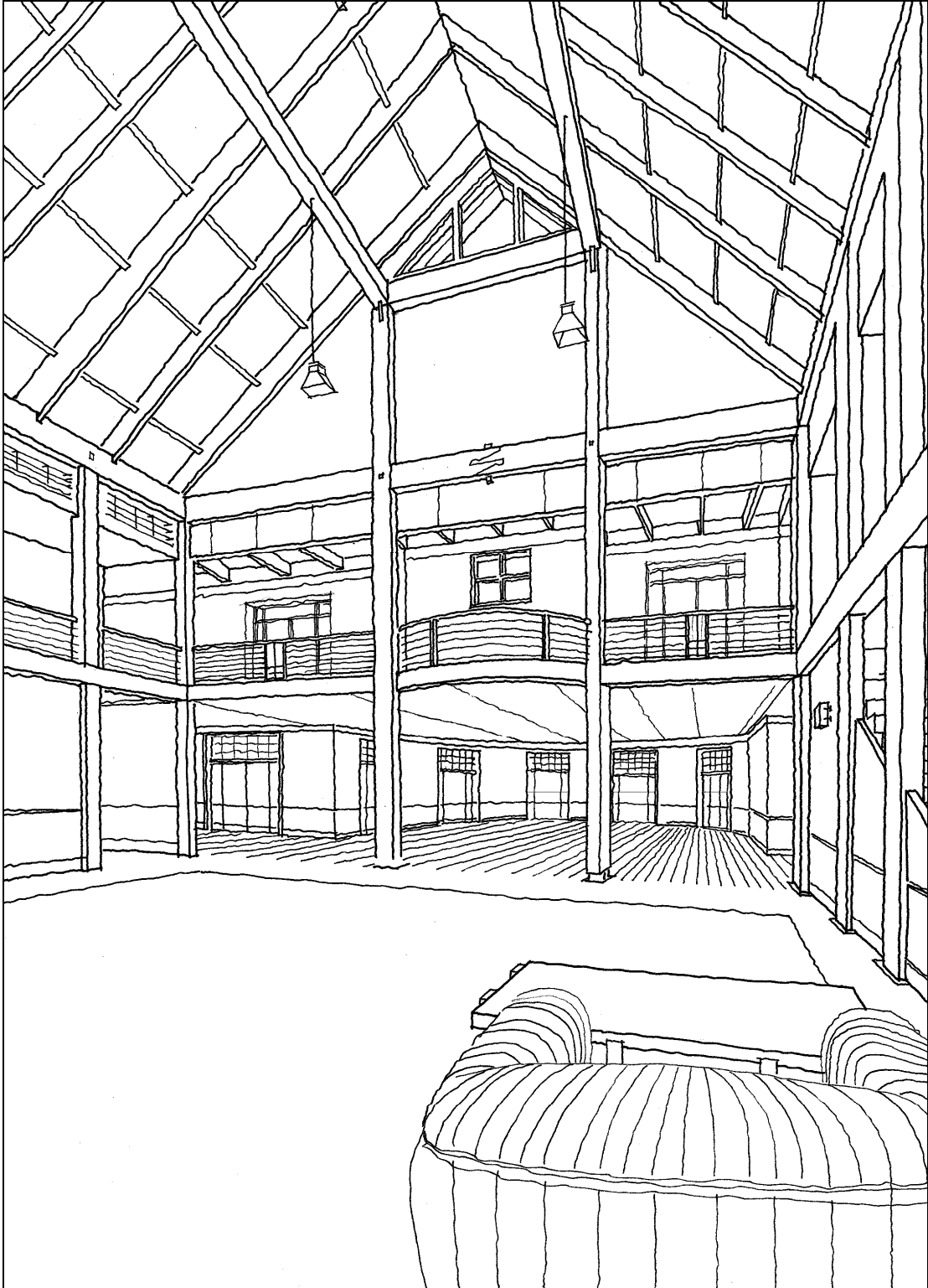

Figure 67: Reception Area.

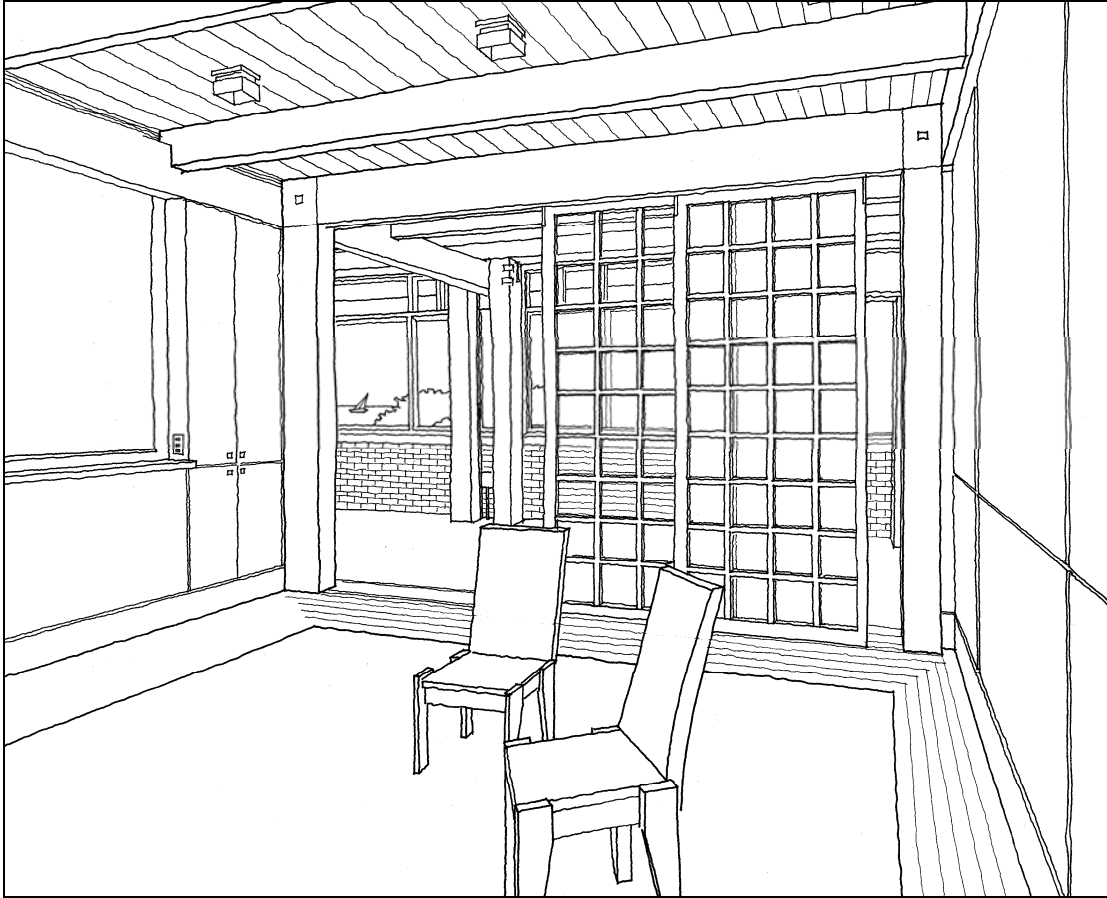

Figure 68: Detail of Breakout Room.

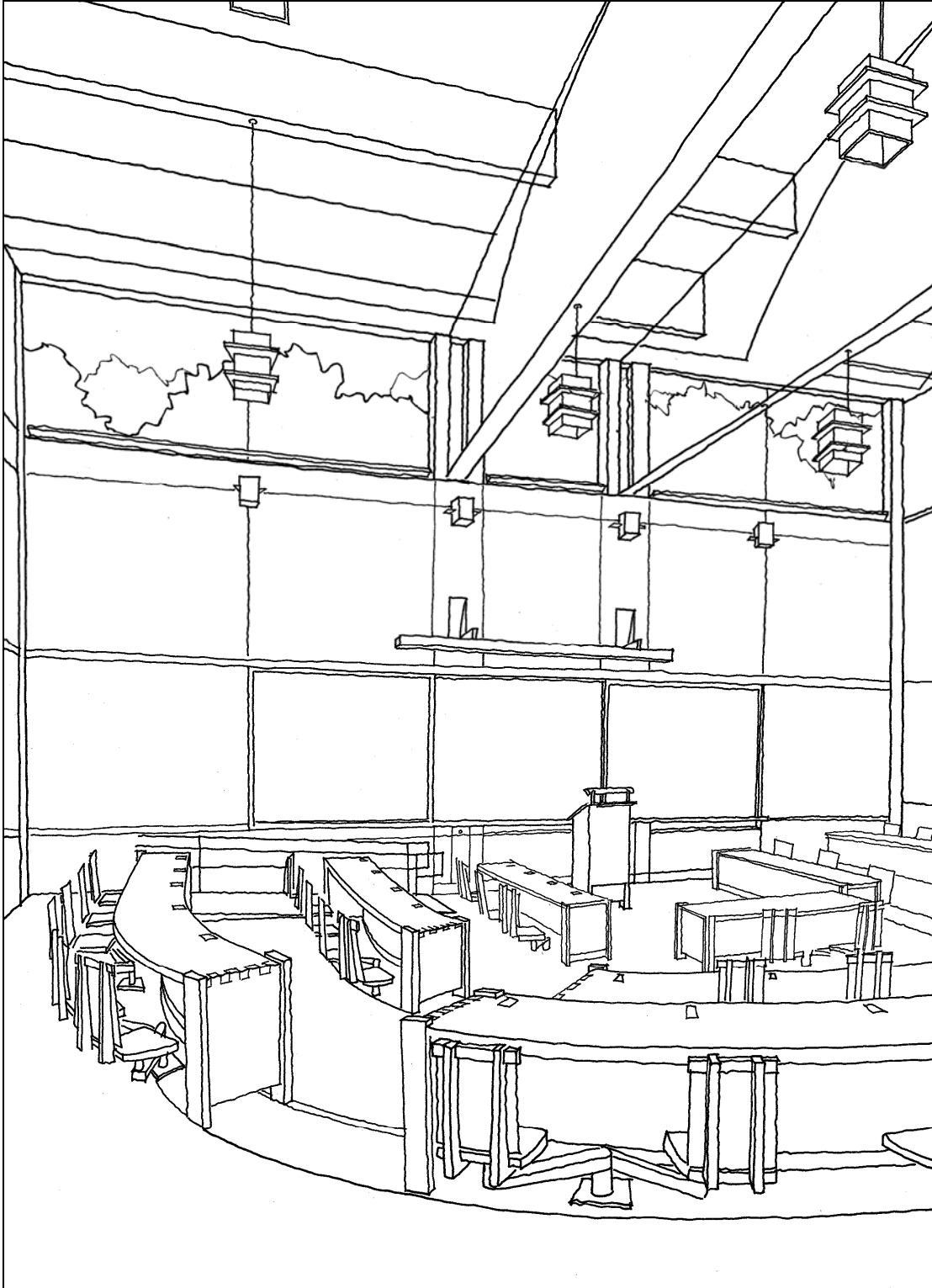

Figure 69: Amphitheatre.

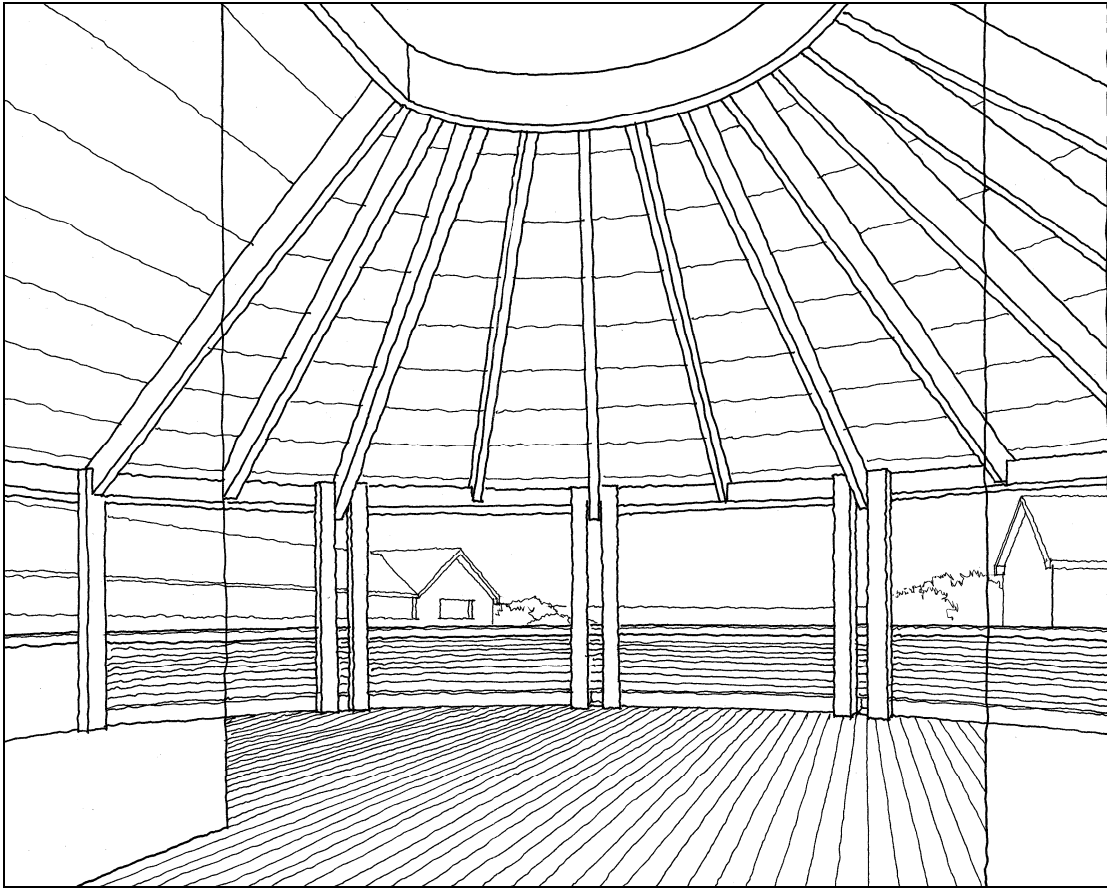

Figure 70: View from the Porch towards the Chesapeake.

Attention to Detailing

The connections between structural, mechanical, and lighting elements, besides serving their utilitarian purpose, provide a unique aesthetic for the building. Beam and column connections combine wood craftsmanship with modern steel pins and brackets that when assembled provide a stable connection that can be left exposed within the building interior. Such details are carried throughout the conference center, from post lighting along walks to masonry ties along the conference center hallways. Heating/cooling registers are built into furniture, scuppers efficiently collect water between trellis beams and into the courtyard, and steel brackets support the loads of the breezeway on the library while enriching the facade. The landscaping employs the same level of detail in stone edging within the courtyard, pea-stone gravel areas to collect runoff from the roof, and stone stepping blocks to create pathways.

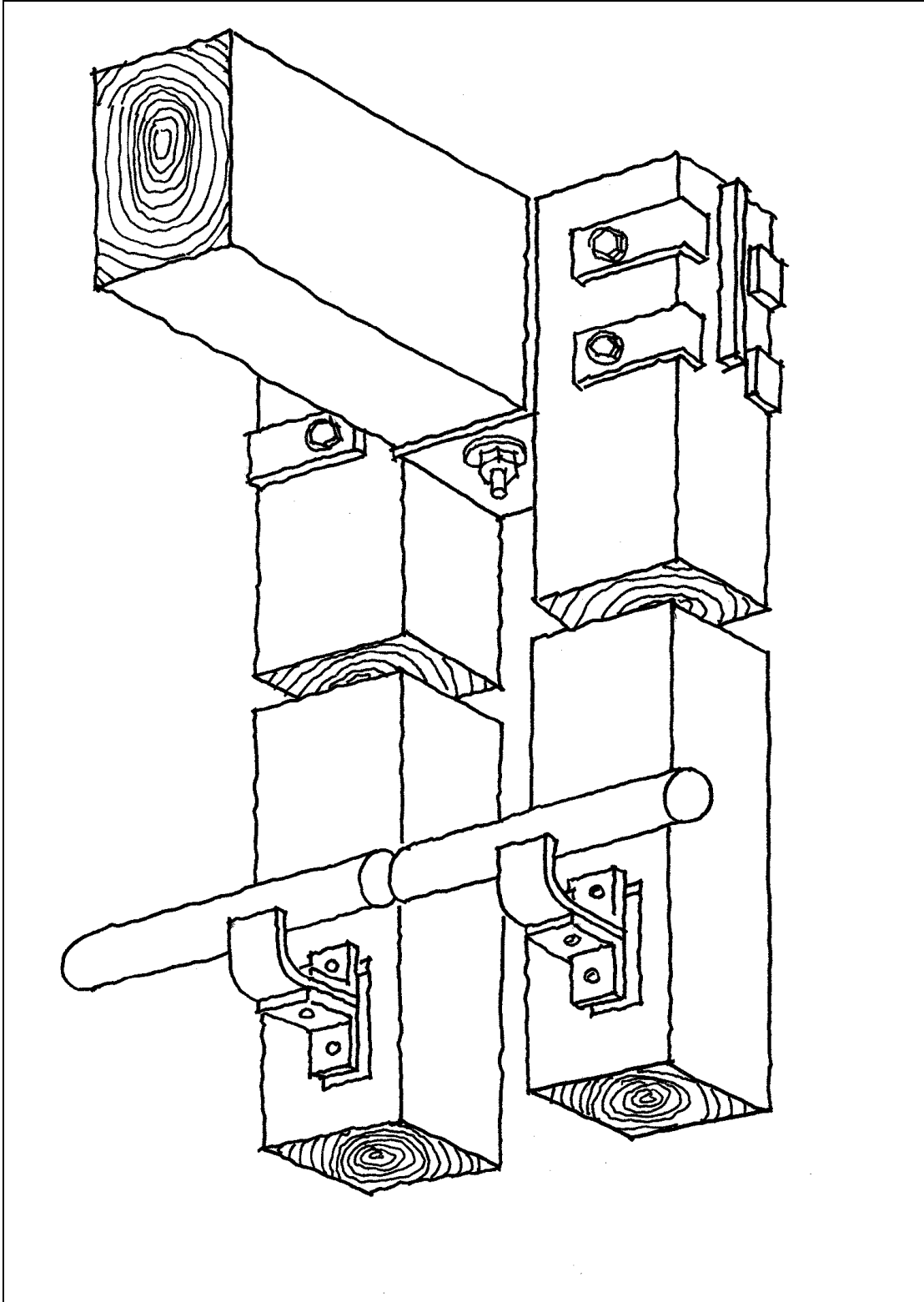

Figure 71: Column Connection Detail.

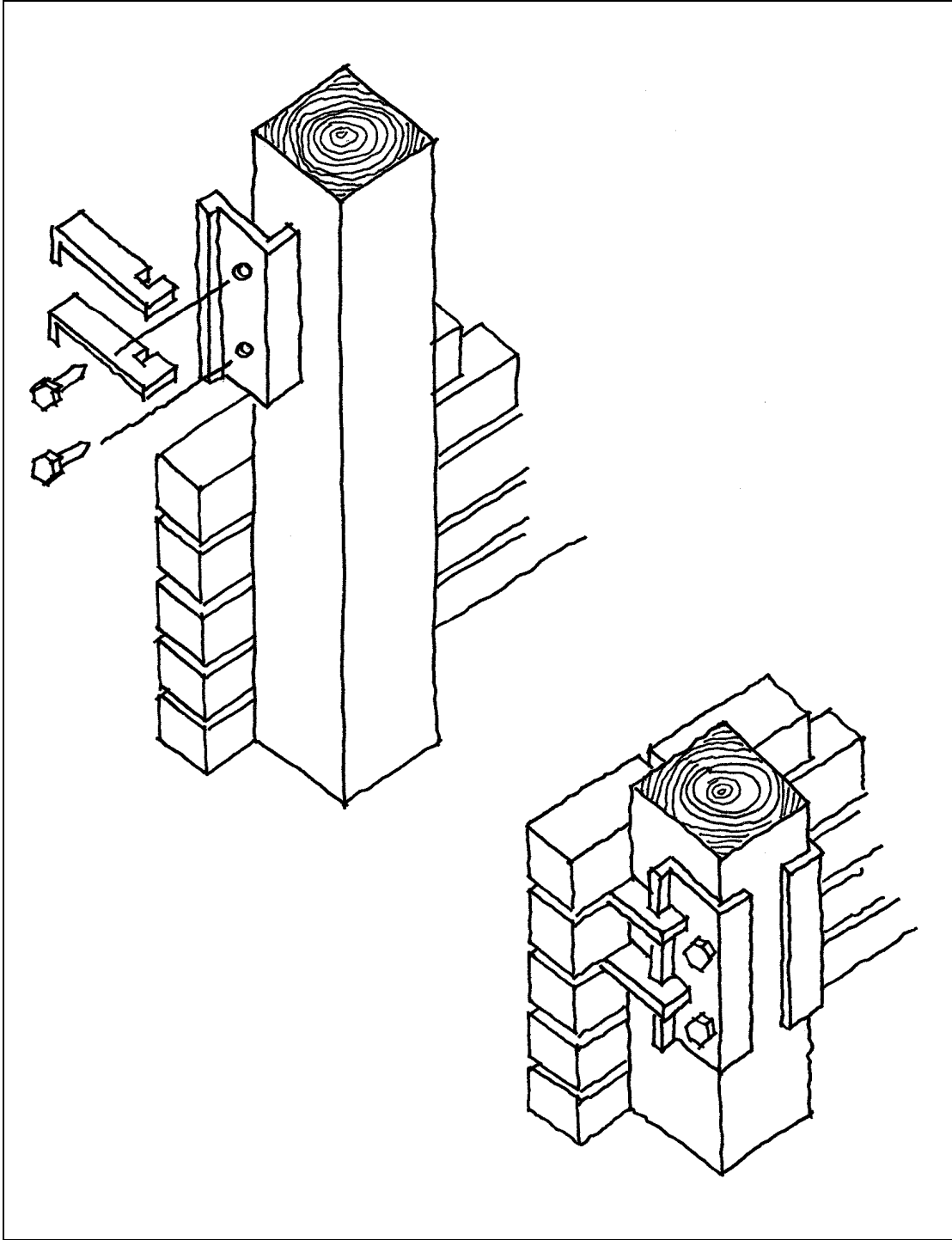

Figure 72: Exposed Masonry Tie Detail.

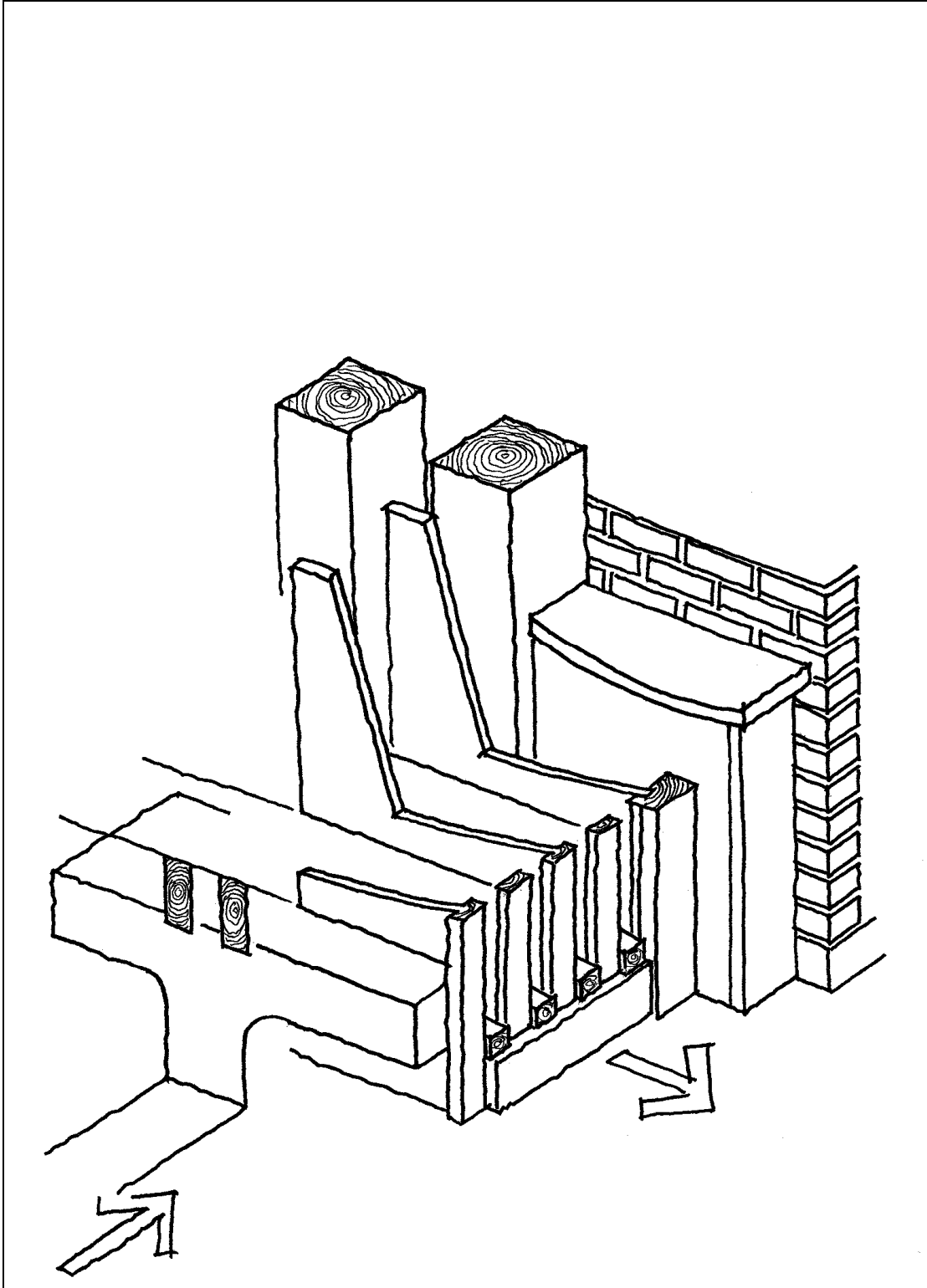

Figure 73: Bench Detail with Built-In HVAC Distribution.

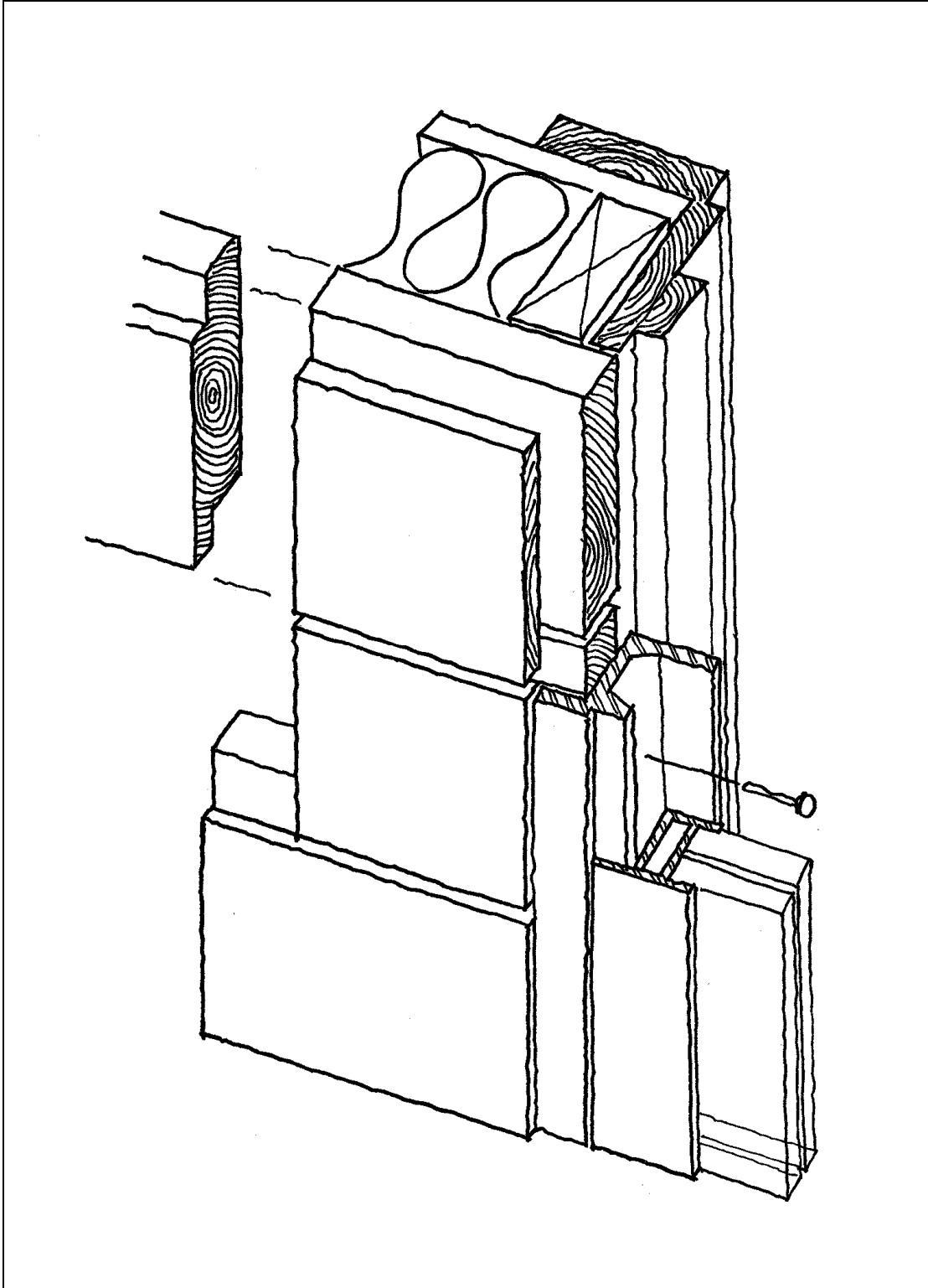

Figure 74: 2nd Floor Wall Detail at Windows.

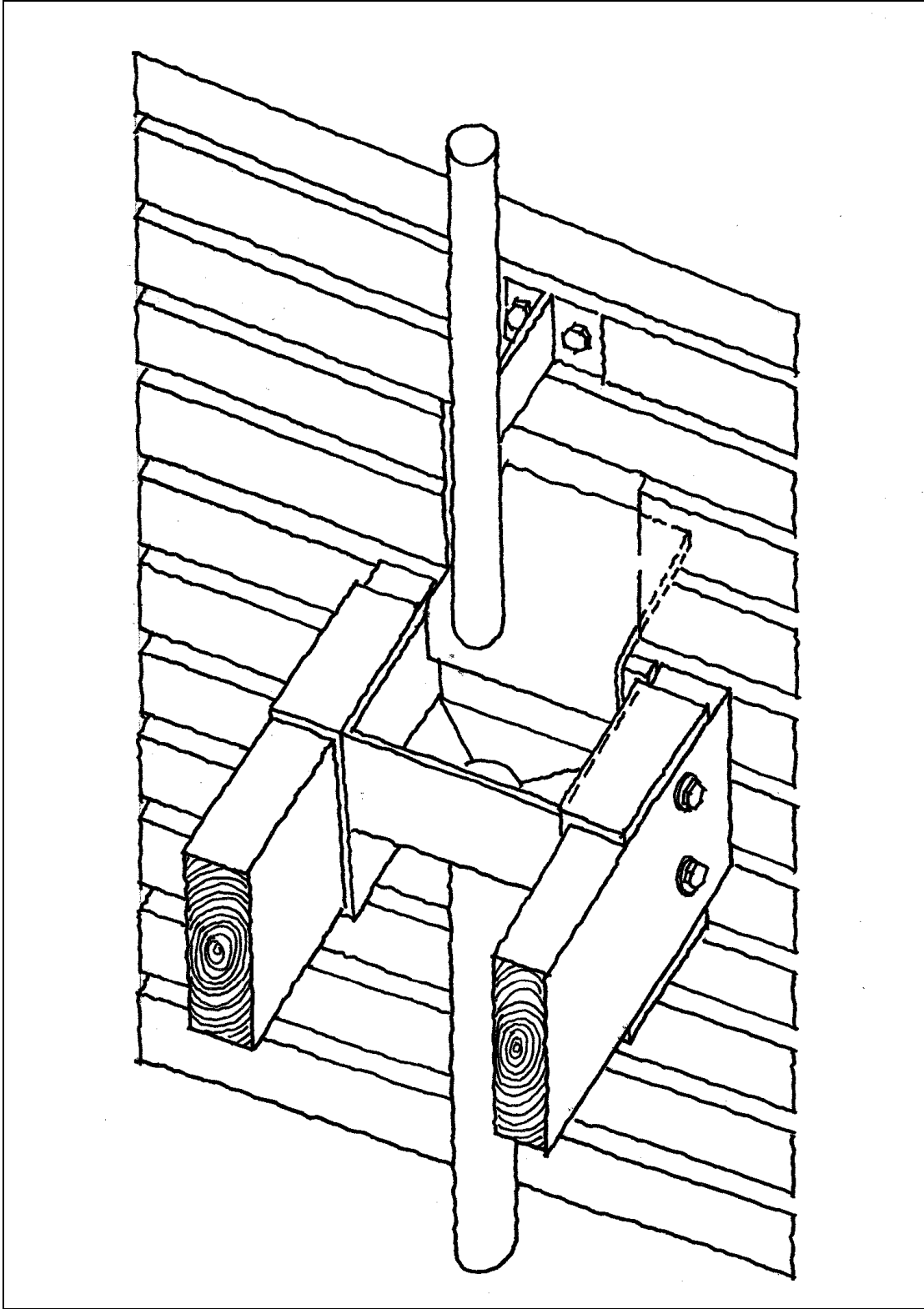

Figure 75: Scupper Detail at Trellis Support.

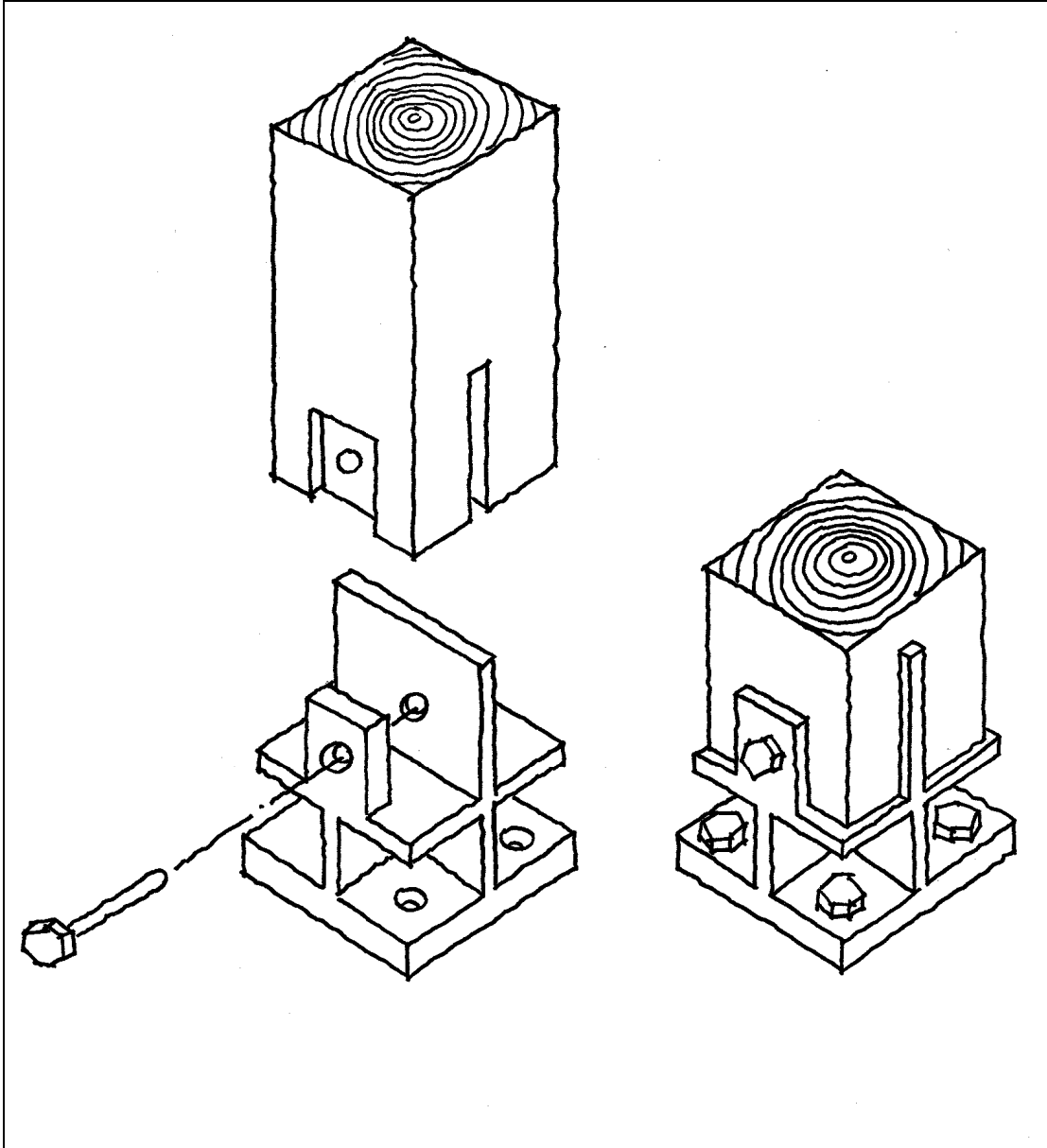

Figure 76: Typical Post Base Detail.

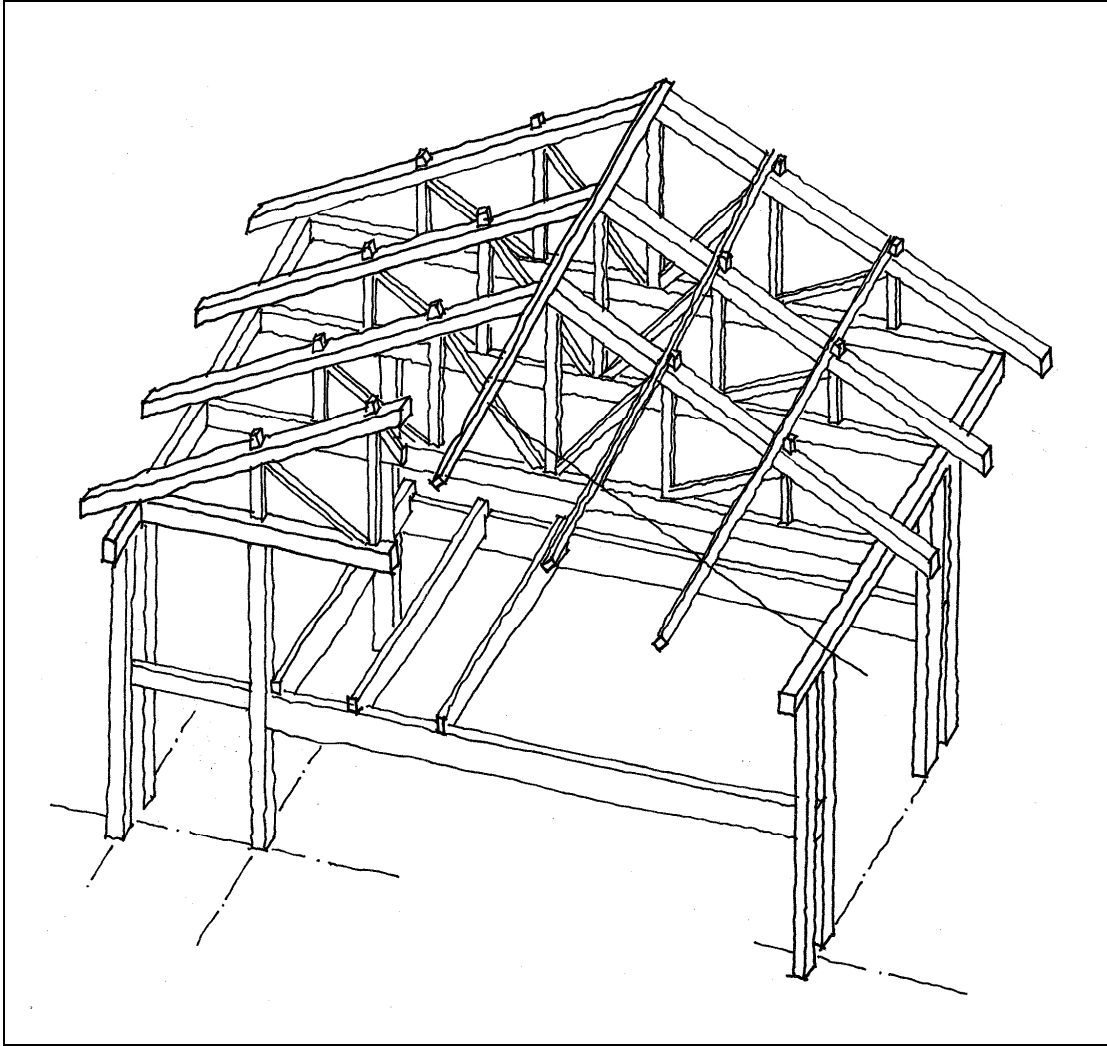

Figure 77: Structural Framing Details.

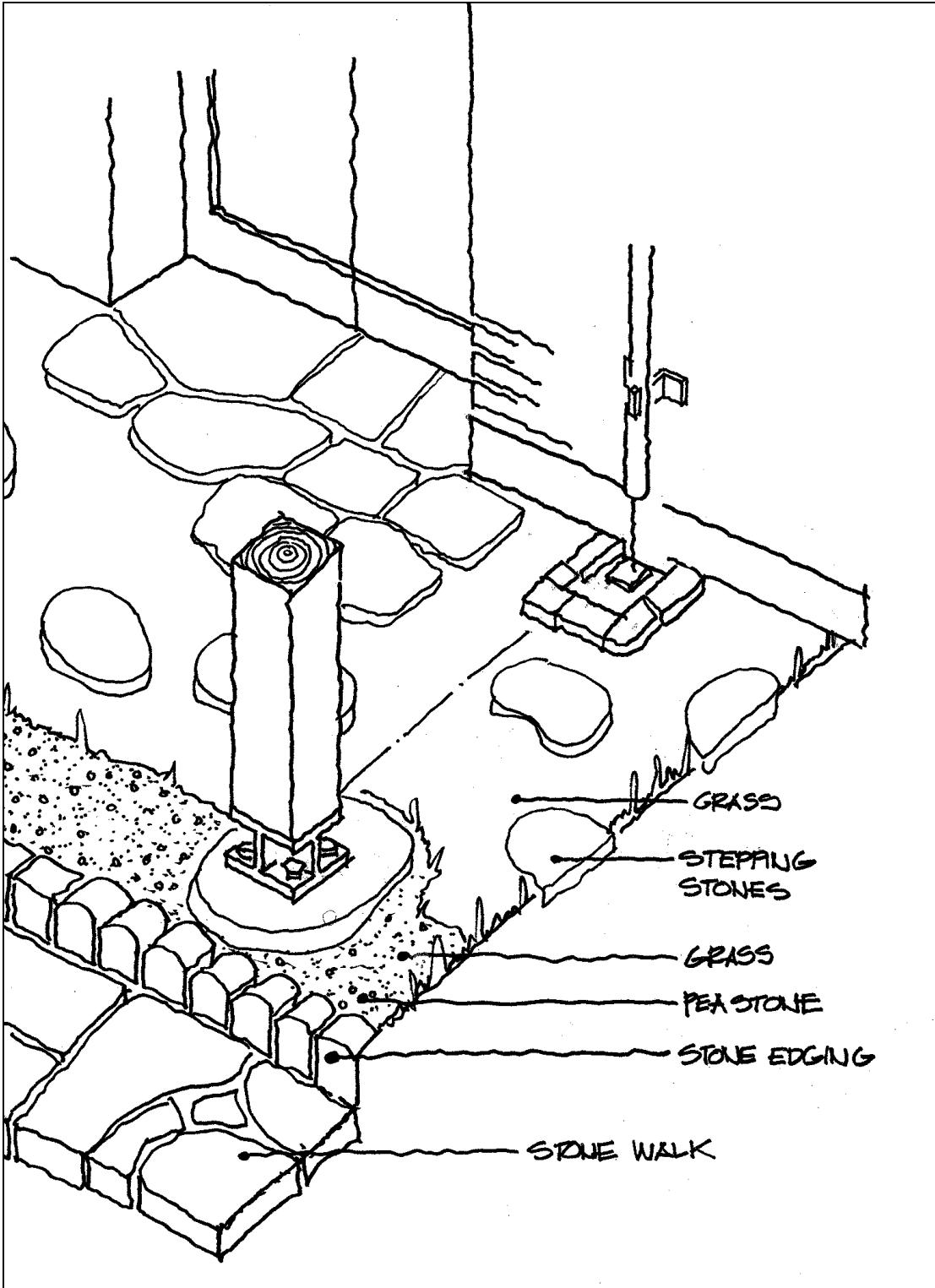

Figure 78: Courtyard Details.

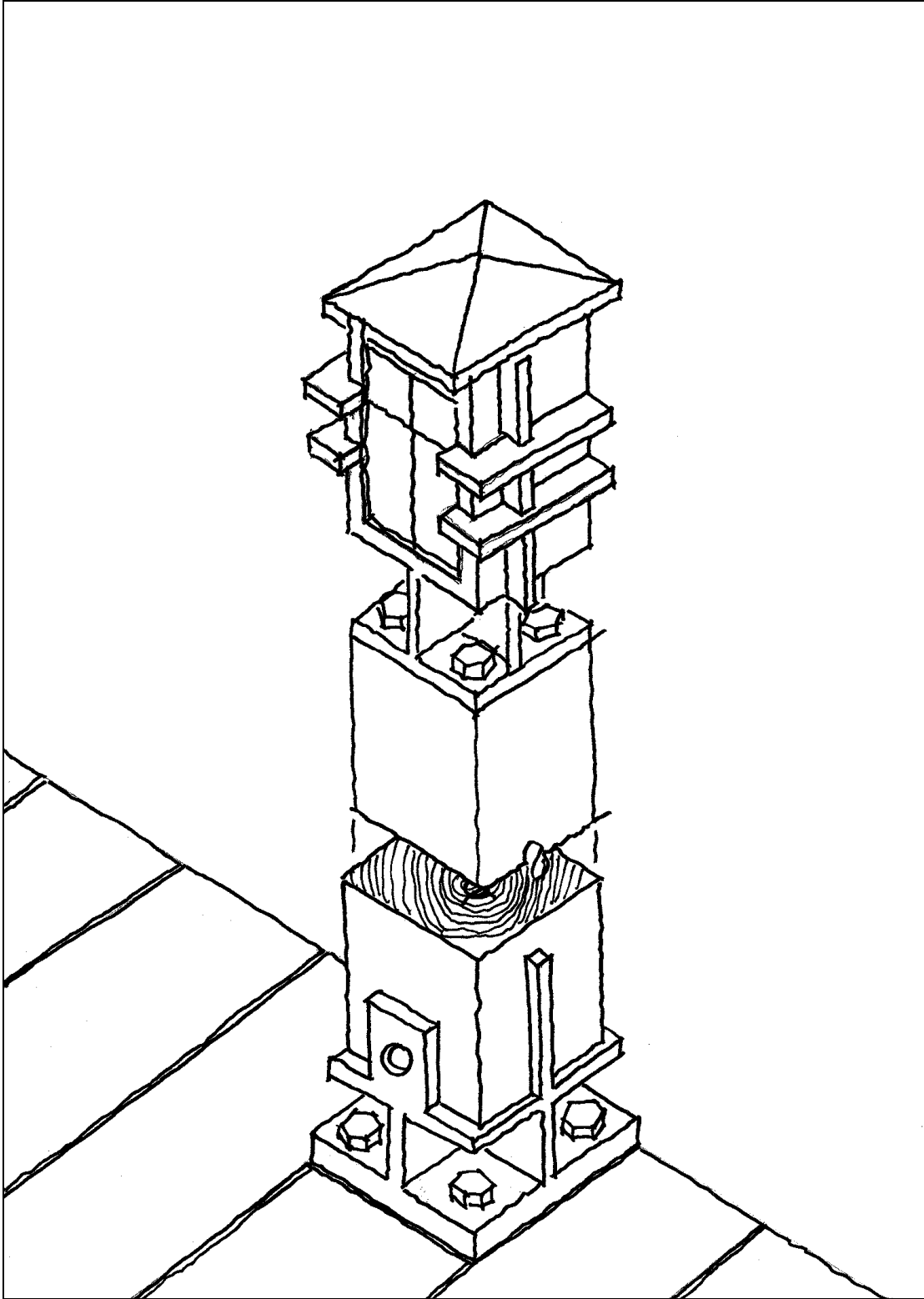

Figure 79: Walkway Lighting.

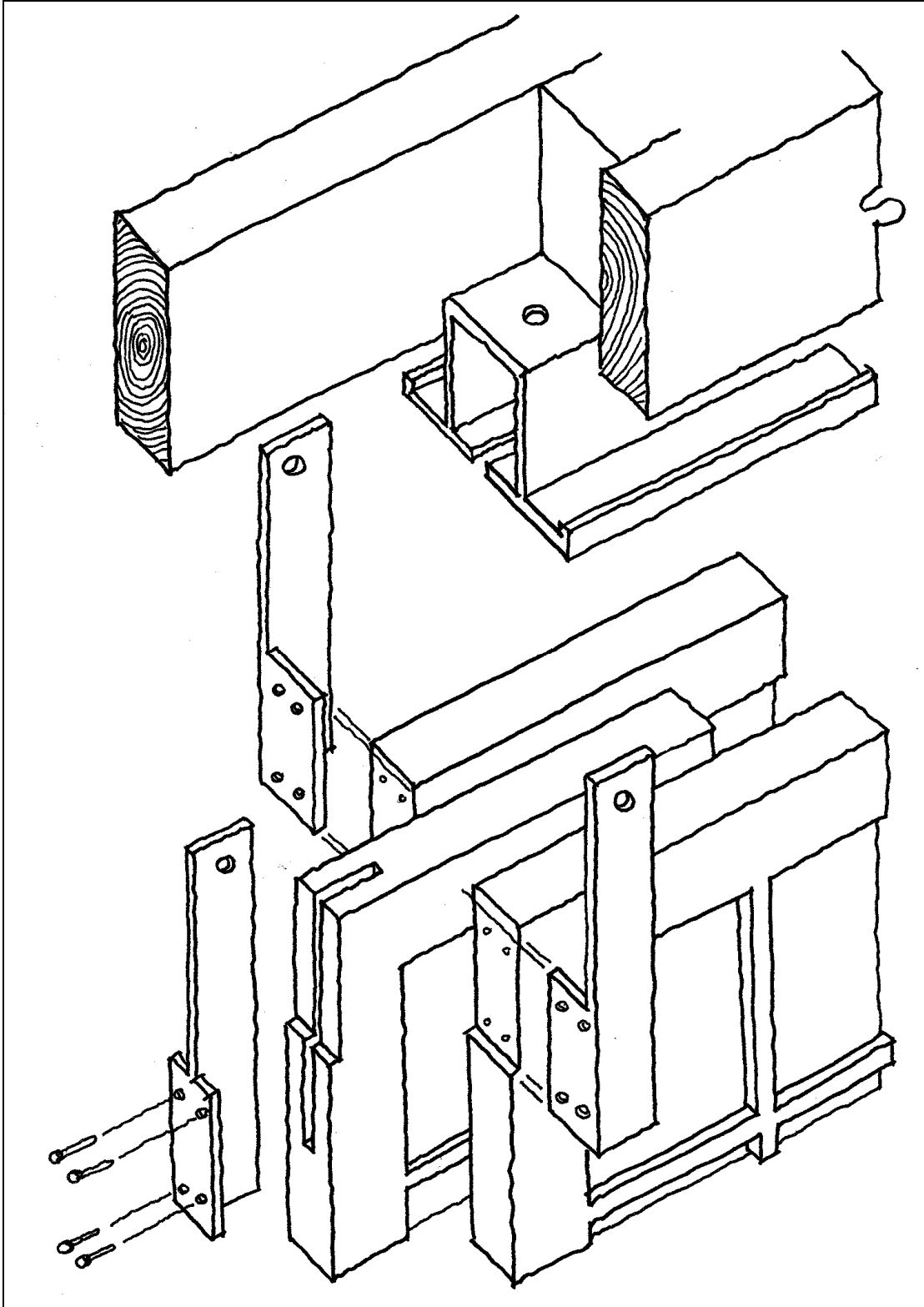

Figure 80: Sliding Door Details for Break-Out Room.

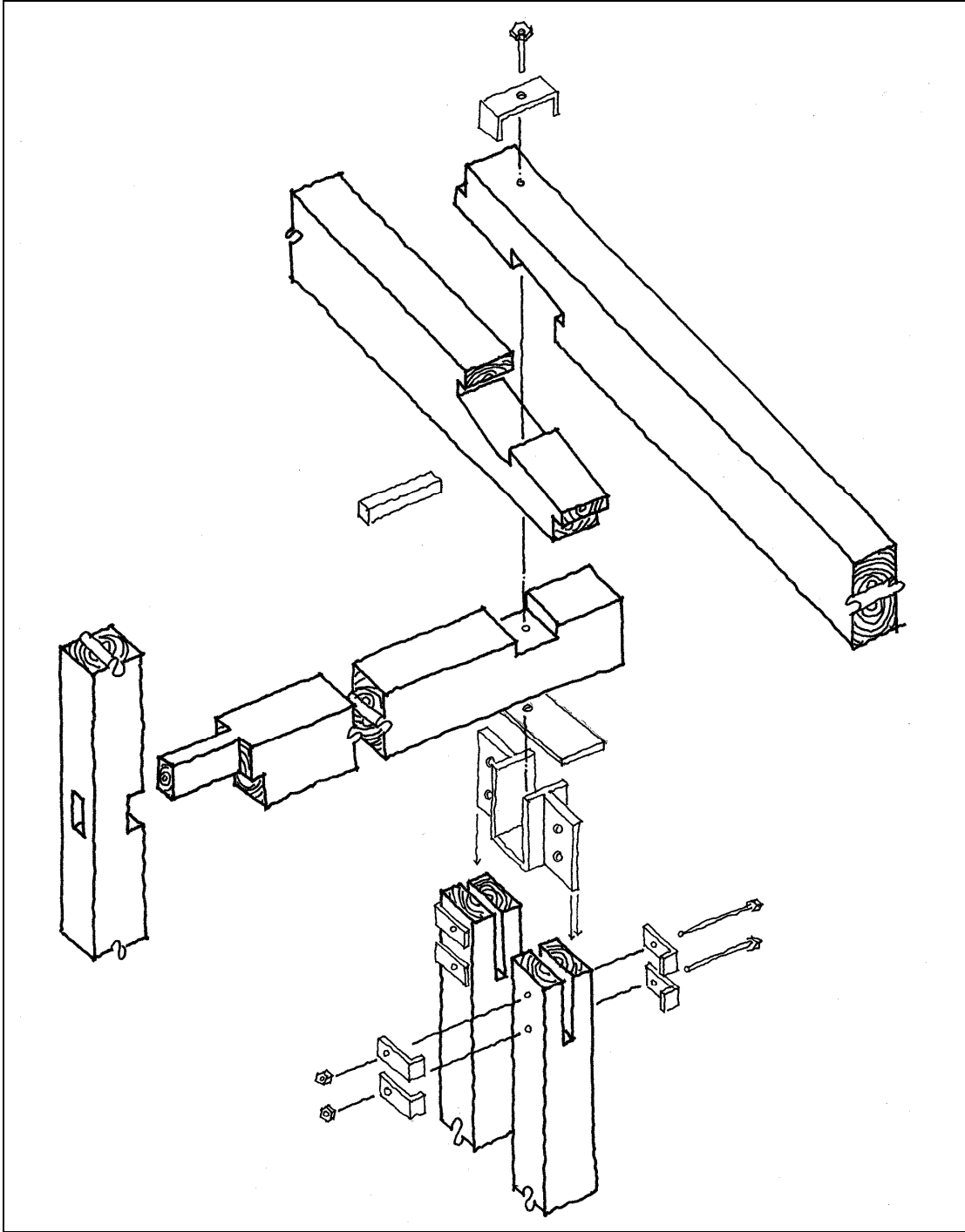

Figure 82: Framing Assembly.



Figure 83: Dining Room.

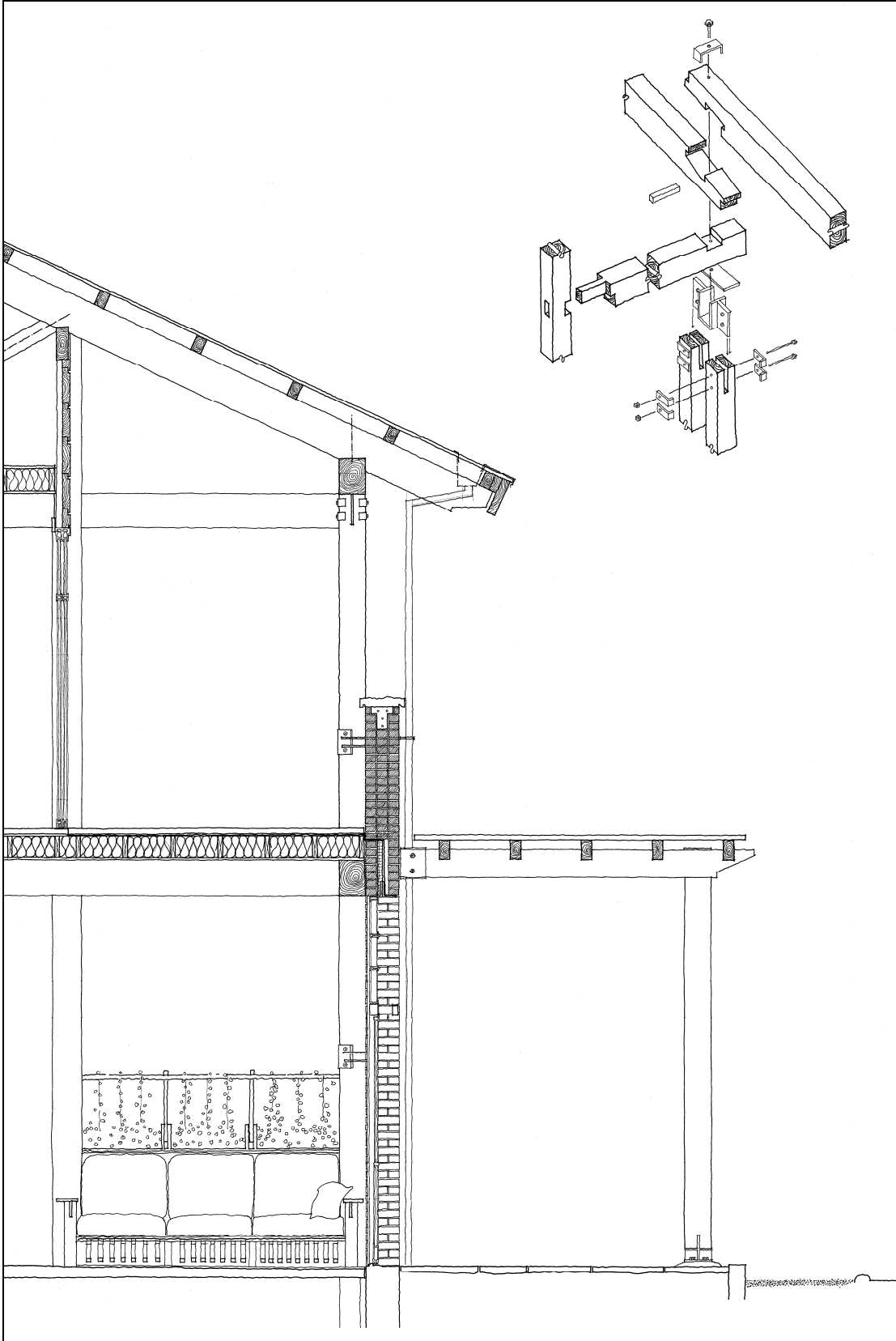

Figure 84: Courtyard Wall Section and Assembly Detail.



Figure 85: Partial Wall Elevation.

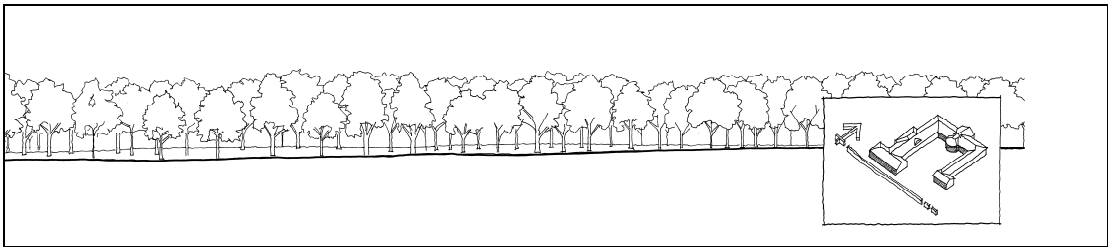
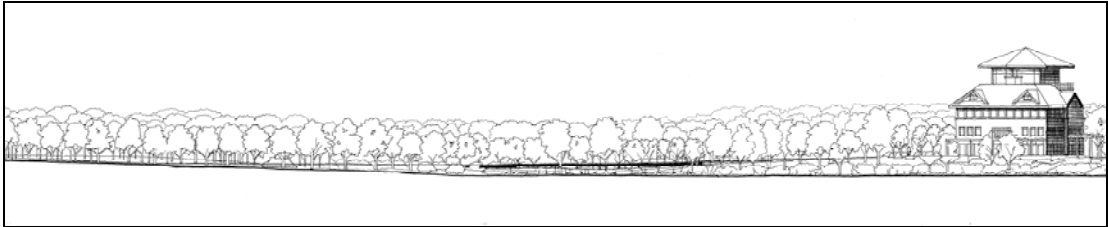
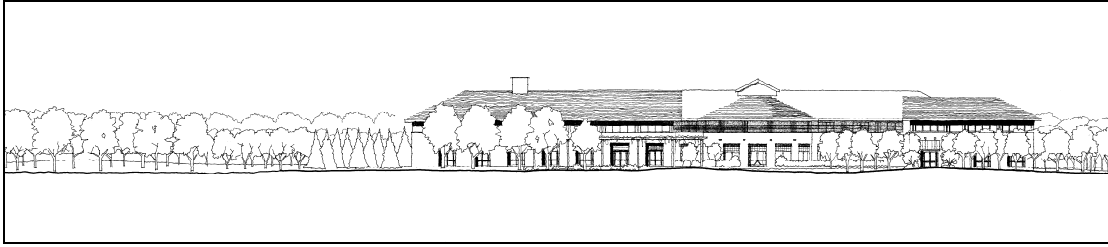

Figure 86: Site Section, (Illustration Broken into Four Parts).

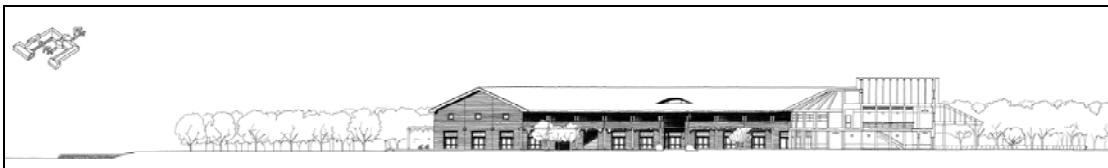

Figure 87: Cross Section Looking South.

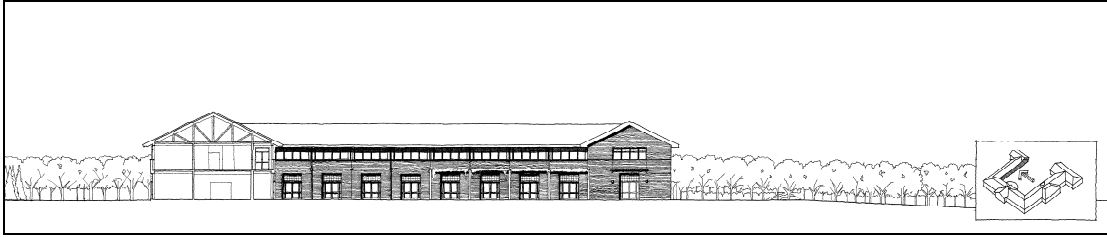

Figure 88: Cross Section Looking North.

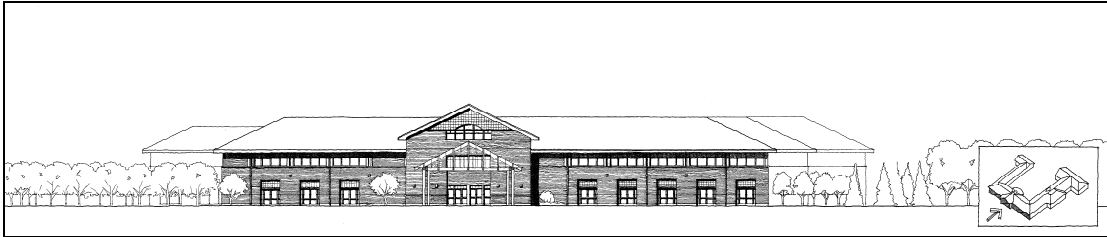

Figure 89: Front Elevation.

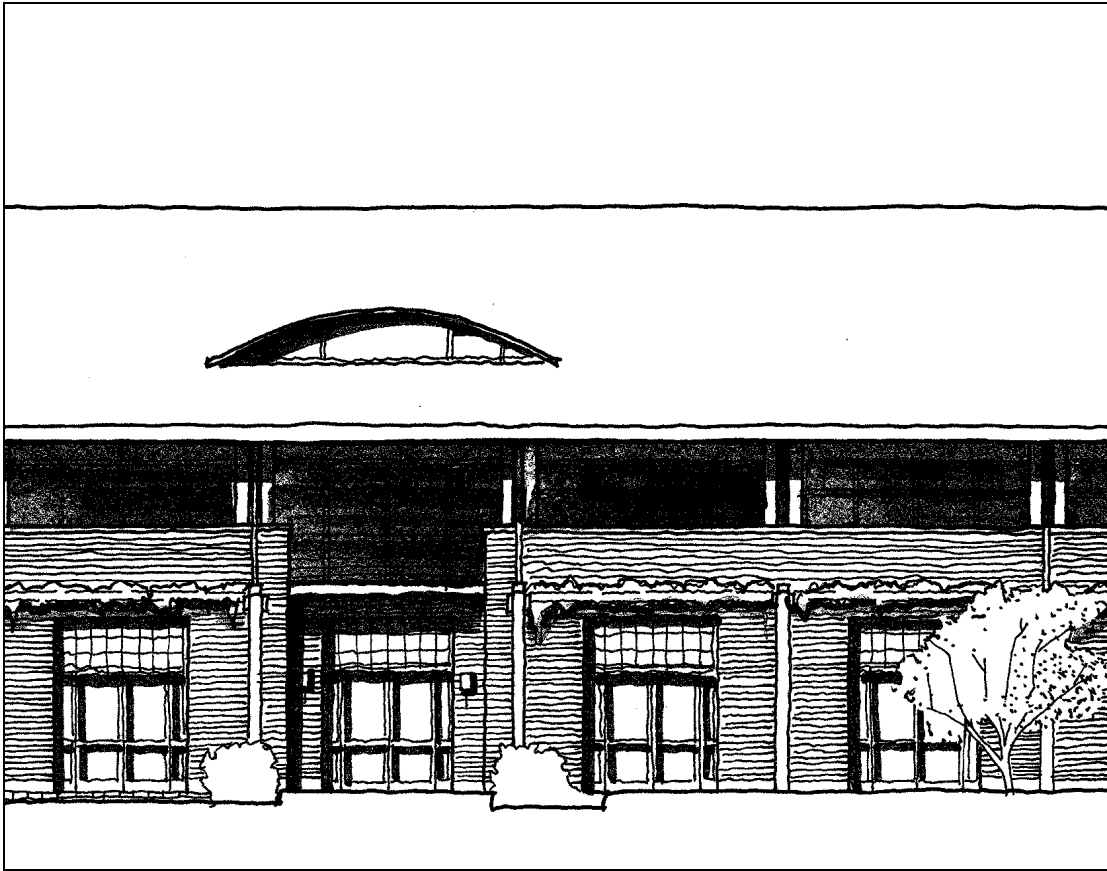

Figure 90: Enlargement of South Courtyard Wall.

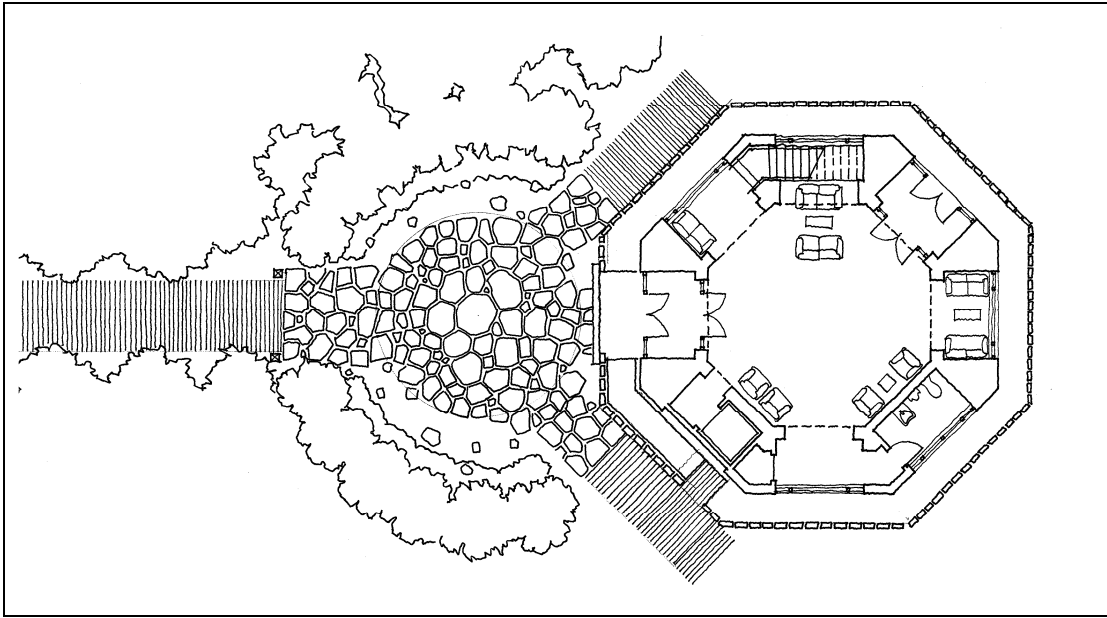

Figure 91: Tower – Garden Level Plan.

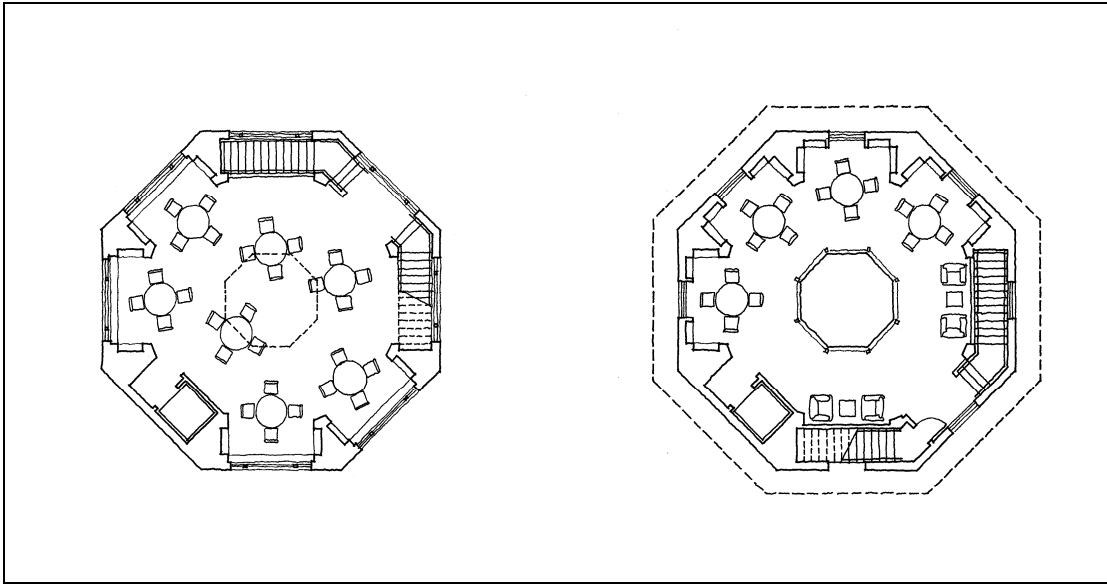

Figure 92: Tower – Second and Third Level Plans.

Bibliography

Anne Arundel County. *Anne Arundel County Code*. Cincinnati, Ohio: American Legal Publishing Corporation, 2008.

Hibi, Sabao. *Japanese detail architecture*. San Francisco: Chronicle Books, 1989.

Lawson, Fred. *Conference, convention and exhibition facilities*. London: The Architectural Press, 1981.

Lawson, Fred. *Congress, convention & exhibition facilities: planning, design and management*. Oxford: The Architectural Press, 2000.

Nakahara, Yasua. *Japanese joinery*. Vancouver: Hartley & Marks Publishers Inc, 1995.

Penner, Richard H. *Conference center planning and design*. New York: Whitney Library of Design, 1991.

The Aspen Institute. "The Aspen Wye River Campus." <http://www.aspeninstitute.org>.