

MASTER'S THESIS

An Integrated Rapid Prototyping and Vacuum Casting System for
Medical Applications

by Rena Surana

Advisor: Guangming Zhang

MS 97-11



ISR develops, applies and teaches advanced methodologies of design and analysis to solve complex, hierarchical, heterogeneous and dynamic problems of engineering technology and systems for industry and government.

ISR is a permanent institute of the University of Maryland, within the Glenn L. Martin Institute of Technology/A. James Clark School of Engineering. It is a National Science Foundation Engineering Research Center.

Web site <http://www.isr.umd.edu>

AN INTEGRATED RAPID PROTOTYPING AND VACUUM CASTING SYSTEM FOR
MEDICAL APPLICATIONS

by

Rena Surana

Thesis submitted to the Faculty of the Graduate School of the
University of Maryland at College Park in partial fulfillment
of the requirements for the degree of
Master of Science
1997

Advisory Committee:

Associate Professor Guangming Zhang, Chairman/Advisor
Professor David F. Barbe
Professor Patrick F. Cunniff

DEDICATION

To my parents, Rawatmal & Kusum Surana, for their endless love, understanding, and commitment to their children - and very importantly, for teaching me to believe in myself and my potentials.

ACKNOWLEDGMENTS

This thesis represents work completed over a two year period. I am thankful for all the support and efforts from professors, staff members, fellow graduate students, and industrial partners.

I would like to express my sincere appreciation to Dr. Guangming Zhang, my thesis advisor. Without his dedication, support, and guidance this work would not have been possible. Aside from Dr. Zhang, I would like to thank Dr. David Barbe and Dr. Patrick Cunniff for serving on my thesis committee

This work has been conducted under a project with the Neural Control Laboratory at the National Institutes of Health. Sincere appreciation goes to Dr. Edward Schmidt and Paul DiCamillio for supplying the Computer Tomographic scans, CT Modeler software, and for initiating the research.

To support this project financially, I would like to thank the Best Manufacturing Practices Program. Without the support, this research work would not have been possible.

For their constant support, I would like to thank members of the Engineering Research Center. In particular, sincere appreciation goes to Dr. David Barbe, Mr. Dan Carafelli, and Ms. Shirley Nestor.

I would like to thank past and current lab members at the Advanced Design and Manufacturing Lab, including Mark Richardson, DT Le, Lixun Qi, Yuqing Cao, Xin Che, John Eshelmen, Yi-Chien Tsou and Charles Clinton.

Finally, I would like to thank my family, especially my parents, sisters, and fiancé, for their never ending support and encouragement. This work would never have been accomplished without their true guidance, patience, and love.

TABLE OF CONTENTS

Dedication	ii
Acknowledgments	iii
List of Tables	viii
List of Figures	ix
1 Introduction	1
1.1 Background	1
1.2 Solid Freeform Fabrication	2
1.2.1 Evolution of Rapid Prototyping	2
1.2.2 Casting and Investment Casting	4
1.3 Scope of the Thesis	7
1.4 Organization of the Thesis	8
2 Literature Review	9
2.1 Rapid Prototyping	9
2.2 Stereolithography Technology	12
2.2.1 CAD Process	13
2.2.2 Software System	14
2.2.3 Stereolithography Process	17
2.3 Existing Rapid Prototyping Technologies	19
2.3.1 Laminated Object Manufacturing (LOM)	19
2.3.2 Selective Laser Sintering (SLS)	21
2.3.3 Fused Deposition Modeling (FDM)	22
2.3.4 Solid Ground Curing (SGC)	23
2.3.5 Summary	24
2.4 Vacuum Casting	25
2.4.1 Investment Casting	25
2.4.2 Vacuum Casting	25
2.4.3 Procedure of Vacuum Casting	26
2.4.4 MCP Vacuum Casting System	30
2.4.5 Success of Using Vacuum Casting at Porsche	30
2.5 Medical Applications	33
2.5.1 Example of a Medical Application	33
2.5.2 Computer Tomography (CT) Scanning	35
3 An Integrated Rapid Prototyping and Vacuum Casting Process	37
3.1 Need for an Integrated Process	37
3.2 Requirements for an Integrated Process	38
3.3 The Role of Vacuum Casting in an Integrated Process	40

3.4	The Role of Stereolithography in an Integrated Process	42
3.5	Integrated Process	43
4	Cost Evaluation of Using Rapid Prototyping Technology	45
4.1	Process Flow of Rapid Prototyping	46
4.2	Cost Structure and Cost Estimates	47
4.2.1	Cost Estimates Related to 3D Solid Modeling	47
4.2.1.1	Conversion of 2D Drawings to 3D Solid Models	47
4.2.1.2	Recreating True Geometric Shapes as Replacements for Cosmetic Features	49
4.2.1.3	Dimensional Adjustment to Accommodate Tolerance Requirements	51
4.2.2	Cost Related to Data Preparation for Solid Freeform Fabrication	51
4.2.3	Cost Related to Part Building	52
4.2.4	Example	53
4.3	Discussion of Results	54
4.3.1	High Initial Investment of Rapid Prototyping Equipment	54
4.3.2	High Reliance on Technical Support Provided by Engineering Service Bureaus	55
4.3.3	Economic Potential of Applying Rapid Prototyping	56
5	Case Study: Medical Applications	57
5.1	Introduction to Medical Applications	57
5.2	Case Study Background Information	58
5.3	Software Overview	58
5.3.1	MIMICS	60
5.3.2	CTM.....	65
5.3.3	<i>Maestro</i> and Stereolithography Building Process	66
5.4	Evaluation of the Rapid Prototyped Model	67
5.5	Multiple Replications	69
5.5.1	MIMICS and CTM	70
5.5.2	<i>Maestro</i> and Stereolithography Building Process	73
5.6	Evaluation of the Modified Rapid Prototyped Model	75
5.7	Vacuum Casting of the Rapid Prototyped Model	75
6	Conclusions and Recommendations	84
6.1	Conclusions	84
6.2	Recommendations	86
Appendix	88
References	89

LIST OF TABLES

Table 2-1	Summary of rapid prototyping companies and products	24
Table 2-2	Number of prototypes for each development stag at Porsche	31
Table 2-3	Comparison of prototype production methods employed by Porsche	32
Table 4-1	Cost structure for applying rapid prototyping	54
Table 5-1	Extents of the monkey skull in mm	67
Table 5-2	Cost structure for applying rapid prototyping to the skull	68
Table 5-3	Extents of the modified monkey skull in mm	74
Table 5-4	Cost structure for applying rapid prototyping to the skull	75

LIST OF FIGURES

Figure 1-1	Stereolithography apparatus at the University of Maryland	3
Figure 2-1	Stereolithography process	13
Figure 2-2	Selection of part orientation	16
Figure 2-3	Support structures to prevent deformation and curling	17
Figure 2-4	Stereolithography cleaning work table and post curing apparatus	18
Figure 2-5	Laminated object manufacturing process and part building	20
Figure 2-6	Selective laser sintering build process	22
Figure 2-7	Casting frame with suspended pattern	27
Figure 2-8	Casting the silicone rubber mold	27
Figure 2-9	De-gassing the mold in the vacuum chamber	28
Figure 2-10	Taped mold	28
Figure 2-11	MCP VC System 001 ST used in research work	30
Figure 3-1	Flow chart of the integrated process	44
Figure 4-1	Process flow of rapid prototyping application	46
Figure 4-2	Conversion of 2D drawing to a 3D solid model	48
Figure 4-3	Cosmetic features versus solid models	50
Figure 5-1	Software overview	59
Figure 5-2	Example of CT-Modeller header for CT scans	61
Figure 5-3	Views of the three dimensional monkey skull	64
Figure 5-4	CTM parameters for .stl file generation	66
Figure 5-5	Stereolithography model of monkey skull	67

Figure 5-6	Bottom of the skull depicting excess detail	70
Figure 5-7	Views of the three dimensional modified monkey skull	71
Figure 5-8	Bottom of the modified skull with simplified detail	72
Figure 5-9	CTM parameters for .stl file generation of the modified skull	72
Figure 5-10	Stereolithography model of the modified monkey skull	74
Figure 5-11	Stereolithography model of both skulls	74
Figure 5-12	Suspended skull with gate and vents	77
Figure 5-13	Casting the silicone rubber mold	78
Figure 5-14	De-gassing of the silicone rubber mold	79
Figure 5-15	Finished silicone rubber mold	79
Figure 5-16	Polyurethane SG200 replica of the monkey skull using vacuum casting	81
Figure 5-17	Polyurethane 2120 replica of the monkey skull using vacuum casting	82
Figure 5-18	Silicone mold and polyurethane SG200 and 2120 replicas of the monkey skull using vacuum casting	83

Chapter 1

Introduction

1.1 BACKGROUND

Manufacturers constantly seek opportunities to shorten lead time needed to bring new products to market. An increase of competition in the world market has magnified this pressure in today's economy. Manufacturers must not only meet customer demands for functional products, but also reduce production cost to secure profit margins. In design verification and product development, engineering prototypes play a unique role to improve product quality, shorten the time to market, and, in-turn, increase profitability

Traditional methods to produce prototypes include numerically controlled (NC) machining, wood making fabrication, rubber molding, investment casting, and others. NC machining has been one of the most popular forms of prototype production due to few limitations on the material used for making the prototypes. This process offers industry a unique tool to fabricate functional prototypes for cost evaluation and design verification. However, a disadvantage often associated with machining is the lead time needed to prepare the required tooling before carrying out the machining operation. Additionally, NC machining is limited in its capabilities to machine geometrically complex surfaces or structures.

1.2 SOLID FREEFORM FABRICATION

As a new technology, solid freeform fabrication has made a significant impact on the manufacturing sector for producing prototypes. This technology is based on the principles of fabricating solid objects directly from computer aided design (CAD) models with limited human involvement. All solid freeform fabrication methods generate models in a layer by layer fashion by use of a laser which processes each individual layer, thus, eliminating the need for secondary tooling. The time needed for producing prototypes can be significantly reduced.

1.2.1 Evolution of Rapid Prototyping

Rapid prototyping has emerged as a new and innovative technology to overcome the shortcomings of traditional prototyping methods. Recent advancement of emerging technologies such as 3-dimensional modeling and laser technologies, promote this form of prototyping. This solid freeform fabrication method is characterized by the ability to generate physical objects directly from CAD data without part-specific tooling or human intervention. The central part of rapid prototyping is the utilization of a laser as a processing tool to solidify materials. The narrow and intense beam creates a unique fabrication environment, in which simple or very complicated, intricate shapes may be produced. This technology has created enormous opportunities for the manufacturing community.

There are several rapid prototyping systems that have recently emerged. However, the stereolithography process is the current leader of all these technologies. Figure 1-1 illustrates a stereolithography apparatus in a working

environment. Stereolithography is based on the same principles as other rapid prototyping technologies - the fabrication of a prototype directly from CAD data without tooling or human intervention. In this system, a narrow laser beam is used to build successive layers of the prototype in a vat of photo reactive resin. Each layer is adhered to the previous one until the entire model is created. The use of a laser allows the creation of a prototype without any physical contact, therefore, protecting each individual layer as it is built. The efficiency and accuracy which are acquired from a prototype created on a stereolithography apparatus surpass all other rapid prototyping technologies.



Figure 1-1. Stereolithography apparatus at the University of Maryland.

Despite the recent advancements and successes of rapid prototyping, there are various limitations which still exist. The first and foremost issue is the high cost associated with rapid prototyping. A lack of cost estimating and cost analysis of rapid prototyping technologies has brought about uncertainties for industrial applications. Secondly, rapid prototyping systems are limited by the materials which may be used. For example, stereolithography systems only use photo reactive resins. This serves as a limitation when functional prototyped parts are required since the material properties of the prototyped part may not match the requirements of a functional part. A third serious limitation of rapid prototyping is the cost associated with prototyping more than approximately ten replicas of one part. Justification for building a small batch of replicas using the stereolithography process is very difficult and alternative methods, such as casting, must be explored.

1.2.2 Casting and Investment Casting

Traditionally, casting is a technique where a metal part is created by pouring molten metal into a mold or a die. Compared to all metal forming processes, casting is one of the most direct processes to acquire a finished product from a component design. Due to the flexibility of the process, castings may virtually be of any shape, size, or weight.

Investment casting is a traditional and commonly used casting procedure which makes use of a pattern to produce duplicates. This form of casting is the most ancient of all metal casting forms. Due to technological advances, investment casting has also become the most versatile modern metal casting technique. Investment casting uses a wax pattern of the part to be cast. The pattern is

submerged in a ceramic slurry, consisting of water, silica, zirconia (sand) and a clay like binder. Once the slurry is dried, the process is repeated until a shell of approximately 6-8 mm in thickness is acquired. Next, the wax pattern is burned out of the shell. Once all of the wax is removed, molten metal is poured into the shell and left to solidify. After solidification, the ceramic shell is broken and the casting is removed.

The method of investment casting provides designers with the design flexibility and close dimensional tolerances. Holes, bevels, serrations, slots, and other such configurations may be produced in investment casts. Investment castings allow dimensional tolerances of +/- 0.005 inch/inch. Additionally, alloys which are difficult to machine may be cast using the investment casting procedure. More importantly, investment casting creates *functional* parts in a variety of materials, unlike rapid prototyping. Parts may be cast in copper, iron, aluminum, steel, and other metals.

Recently, rapid prototyped models have been used in place of the traditional wax patterns. This integration of both processes signifies the efforts towards reducing costs and cycle time for product development. Additionally, the integration stresses the need for functional parts which rapid prototyping alone cannot deliver. Using rapid prototyped patterns as wax substitutes is the key element for creating castings for low production runs while eliminating the high cost of foundry pattern tooling.

Unfortunately, the substitution of rapid prototyped models for the wax patterns creates problems. One difficulty which the rapid prototyped patterns

create is that they expand more than the traditional wax pattern when heated. This expansion causes the pattern to crack the ceramic shell. Additionally, other problems include "incomplete pattern burn-out, reactive part residue on surfaces of the inside mold surfaces, poor surface finish, mold cracking, reproduction of rapid prototyping part model defects". [Smith, St. Jean, Duquette, 1996] Thus, other methods for casting are explored.

Similar to investment casting, vacuum casting has become popular within the manufacturing domain. With this technique, once again, rapid prototyped patterns are used as a master for casting. However, with vacuum casting, replicas are made of polyurethane, not metals. These polyurethanes come in a variety of characteristics such as hardness and impact strength to meet required mechanical properties of prototypes for design evaluation.

In the vacuum casting process, ceramic materials are not used to create the mold, rather, silicone is used. Solidified silicon is flexible and deformable, therefore, allowing designers the freedom to create parts with intricate details, undercuts, and no draft. Vacuum casting allows for fine detail, even a finger print, to be reproduced.

Vacuum casting overcomes some of the shortcomings of investment casting. In this process, the pattern is not burned out, but simply removed after the mold is formed and cut open. Thus, there are no problems with heating, expansion, or breaking of a mold. By not burning out the pattern, the rapid prototyped model is preserved as well, thus, it may be further used to make additional molds. A wide

variety of resins are available for vacuum cast parts to simulate different materials including acrylic, styrene, rubber, and others.

1.3 SCOPE OF THE THESIS

The objective of this research is to integrate the rapid prototyping and vacuum casting processes for production of a small batch of prototypes. Because there is a great demand for shortening lead times needed to bring products to market, designers have significant interests in this integration. Research efforts have been focused on the evaluation of prototyping and casting methodologies. The development of an integrated system would provide designers and engineers with a very powerful tool which reduces both cost and cycle times. Additionally, a cost analysis of using rapid prototyping has been conducted.

Furthermore, special attention of this thesis research is given to applications of rapid prototyping in the medical arena. A new phenomena in this field is called computer aided surgery. This practice employs the high power of computers and advancements in image processing to assist physicians and surgeons. One specific area of computer aided surgery involves converting Computer Tomography (CT) or Magnetic Resonance Image (MRI) data into computer-aided design (CAD) solid models. These solid models serve numerous purposes for surgeons and physicians. Modeled parts may be used for visualization, consultation, practicing of surgical procedures, or even to cast implants. Thus, in this research work, significant efforts have been made to reconstruct solid models from 2-dimensional CT scans. Using rapid prototyping technologies, the CAD models are used to construct prototypes of a patient's imaged bone, ligament, etc. In cases where multiple copies of a model

are required, due to cost considerations and material requirements, vacuum casting has been used to supply these replicas.

1.4 ORGANIZATION OF THE THESIS

The thesis is organized into six chapters. Chapter 2 presents a literature review on traditional and advanced prototyping and casting techniques. It also describes the medical applications of this research work. Additionally, an introduction to various rapid prototyping technologies existing in the manufacturing community is included. Chapter 3 presents an integrated system of rapid prototyping and vacuum casting. A cost analysis of rapid prototyping is described in chapter 4. Chapter 5 presents a case study where the integrated system is used in a medical application. Finally, chapter 6 concludes with the thesis findings, recommendations, and suggestions for future work.

Chapter 2

Literature Review

As an emerging technology, rapid prototyping is revolutionizing every sector of industry, creating opportunities to design and manufacture products of superior quality with shorter lead-times and at more competitive prices. Furthermore, rapid prototyping has made a significant impact on complementary technologies such as investment casting, vacuum casting, computer hardware, software, and others. To understand the implications and applications of these recent advances in the manufacturing community, and, thus, the direction of this thesis, a review of current rapid prototyping technologies and applications is required. This chapter presents a literature survey regarding background material pertaining to the research subjects of this thesis work. The survey covers the following: an introduction to rapid prototyping, competing rapid prototyping systems, vacuum casting, and medical applications.

2.1 RAPID PROTOTYPING

With recent advancements in information technologies, including 3-dimensional modeling and laser technologies, rapid prototyping (RP) has gained great attention from the product design and manufacturing communities. This technology is characterized by the ability to produce physical objects directly from computer graphical data using the methodology of layer manufacturing. As a result, this solid freeform fabrication technology creates the opportunity to generate physical models of a designed object for evaluation during the design stage. Along

with rapid prototyping, many other terms are associated with this technology such as: automated fabrication, desktop manufacturing, and rapid automated prototyping.

Traditionally, machining has been used to produce prototypes. The versatility of computer numerically controlled (CNC) machine tools in producing geometrically complicated features offers industry a unique tool to fabricate prototypes for design verification and cost evaluation. As the accuracy of numerically controlled (NC) machining stands out amongst many other manufacturing processes, such as wood-making, casting, rubber molding, CNC machine tools are widely used to make prototypes today. One of the shortcomings of CNC machining is the lead time needed to complete the machining operation starting from preparing cutting tools and selecting fixtures, to having limited capability of dealing with geometrical complexity characterized by a wide range of surface curvature.

Manufacturers always seek to shorten the lead time needed to bring new products to market. This pressure has been magnified in today's economy due to the increasing competition in the world market. To strive for business success, manufacturers have to work hard not only to meet the customer's demands for functional products, but also to reduce production cost to secure profit margins. The market rewards those manufacturers who have the ability to design, produce, and introduce high-quality products to the market in minimum time. Quickly, making engineering prototypes in short time for design verification plays a unique role in product development. Rapid prototyping has emerged as a new and innovative technology for meeting this challenge.

Solid freeform fabrication is defined as a technology where freeform solid objects are created directly from CAD models without human intervention or part-specific tooling. Solid freeform fabrication involves building objects, layer by layer, without additional means, such as second tooling. The core of the majority of rapid prototyping technologies is the use of a laser to process the prototype. The intense and narrow laser beam creates an environment where simple as well as extremely complicated shapes may be fabricated. This technology has created new and exciting opportunities for the manufacturing sector.

Rapid prototyping offers a large range of applications to its users. This technology more often creates a working model or prototype as opposed to an end-user part. The creation of these models are used for various applications, three of the more critical ones being:

Concept models: Enables the designer to touch and carefully examine the part. It also allows the consumer to gain actual visualization of the conceptual part.

Casting models: Manufacturers increasingly use rapid prototyping as a means for casting molds. These molds are used for replicating the parts for full-scale production.

Fit and function testing: Ensures the accurate fitting of the part to other parts. It also allows for testing of compatibility of functions with other parts.

2.2 STEREOGRAPHY TECHNOLOGY

The word “stereolithography is a combination of the word “stereo” meaning three-dimensional, and “lithography”, which means printing. Thus, stereolithography is a three dimensional printing process which creates solid models out of a photopolymer.

Stereolithography technology was pioneered by 3D Systems, Inc. of Valencia, California in 1986. 3D Systems conceived, designed, and marketed the technology and entered the commercial market in 1988. 3D Systems introduced the first layer-additive process which creates physical objects in a rapid fashion directly from CAD databases, making rapid prototyping technology approximately a decade old. As of June 1994, 3D Systems’ SL technology dominates over 62% of the rapid prototyping market worldwide and over 83% of the stereolithography market [Jacobs, 1996].

The SL process begins with the conversion of CAD data to a stereolithography file (.stl file). This file is then sliced into extremely thin cross sections. The slice file is then downloaded to the stereolithography apparatus (SLA) build-station. The SLA houses an optical scanning system from which a laser generates an intense beam of ultraviolet energy. As the laser traverses the vat, any liquid photopolymer subjected to the UV energy will become solid. After each layer is completed an elevator drops the newly formed layer into the vat and applies a new layer of polymer over the solidified layer. Each new layer is drawn and adhered to the last solidified layer. This process is repeated until the last layer is completed. Figure 2-1 is a schematic diagram of the stereolithography process.

After completion, the solid part is removed, cleaned, and post cured with UV energy to fully cure the part. Parts are further finished by sanding, painting, and sandblasting to meet individual needs.

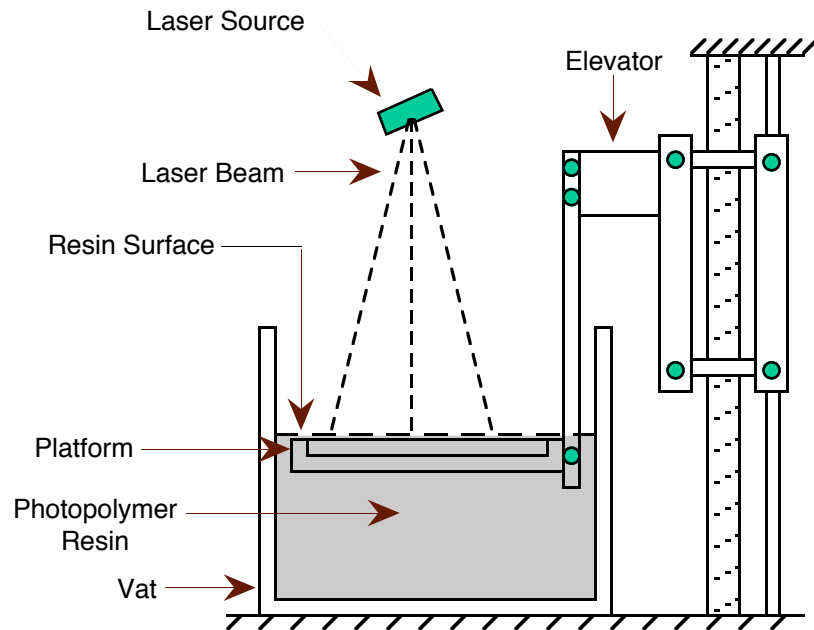

Figure 2-1. Stereolithography process.

The entire stereolithography process may be divided into three main steps: CAD process to create a three-dimensional solid model, software system to generate build files to run the SLA, and the stereolithography process to fabricate a physical prototype. Following is a detailed description of each individual step.

2.2.1 CAD Process

The CAD process begins with the design of an object in a three-dimensional representation. The designer must keep in mind four factors: units, CAD

resolution, feature size, and wall thickness. The CAD data must fully specify the outside, inside, and boundary of the object. The CAD file is then tessellated, forming a connected array of triangles. The size of triangles is determined by the user, however, smaller triangles create a finer resolution of curved surfaces and thus, greater accuracy of the final prototype. On the other hand, larger triangles require lesser storage requirements while sacrificing part accuracy. The tessellated file is known as a STeroLithography or .stl file. An .stl file contains the X, Y, and Z coordinates of each surface triangle. All triangles in an .stl file must mate with other triangles, thus, eliminating all gaps within the file. Additionally, the triangles must be oriented to indicate which side of the triangle contains mass. Thus, .stl files contain the coordinates of the vertices of the triangles as well as an index which describes the surface normal orientation based on the right-hand rule.

2.2.2 Software System

Maestro is a workstation based software package created by 3D Systems. The purpose of this software is to prepare a part for building. There are four critical stages which are accomplished by use of the software.

The first component of the software is data verification. As flaws and errors may not be readily apparent while modeling in a CAD package or on the computer screen, errors often appear during the construction of .stl files. Thus, the software will verify, analyze, and repair any corrupted .stl files.

The next stage involves selection of part orientation for building. Surface finish, build time, part accuracy, and part resolution are all dependent upon the

choice of orientation. Following is a list of general guidelines used when selecting orientation:

- a) In order to decrease build time, it is necessary to minimize the geometry in the z-direction. Thus, limiting the number of layers will decrease the overall build time.
- b.) Orienting curved surfaces in the horizontal plane normal to the laser beam will allow for higher resolution of the part.
- c.) Flat regions which are up-facing will have the best finishing as no support structures will be attached.
- d.) Trapped volumes should be eliminated or minimized. A trapped volume is any region which holds uncured resin, such as a cup. In the example of a cup, turning it upside down would not constitute a trapped volume.

Choosing correct orientation for a part is often dependent upon the build time and accuracy which is desired. Oftentimes, choosing a particular orientation will decrease the build time, however at the same time, sacrificing accuracy and finishing of the part. An example of such is illustrated in figure 2-2 where a cylinder may be built standing (figure 2-2 (a)) or lying down (figure 2-2 (b)). In the first case, accuracy is the main focus, where in the second case, a shorter build time is achieved. It is apparent that building the cylinder in the second fashion will

create a stair-stepping effect and, hence, decrease the accuracy and finishing of the overall part.

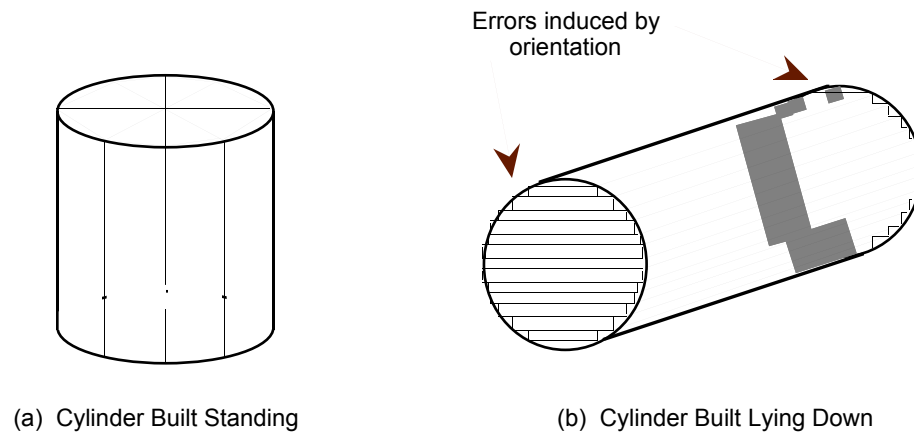

Figure 2-2. Selection of part orientation.

Maestro's third feature is the design and creation of support structures. Parts are built attached to a platform and removing them may damage the parts. Thus, supports are built to attach the part to the platform. The support structures are broken from the platform and carefully removed from the part after the build process is completed. Support region 1 of figure 2-3 illustrate these types of support structures.

Consequently, support structures serve the same purpose as fixtures which hold workpieces for machining. Additionally, supports are used to prevent curling or warping of any overhanging or cantilevered sections of the prototype. Without support region 2, shown in figure 2-3, the top of the part would most begin to curl and warp.

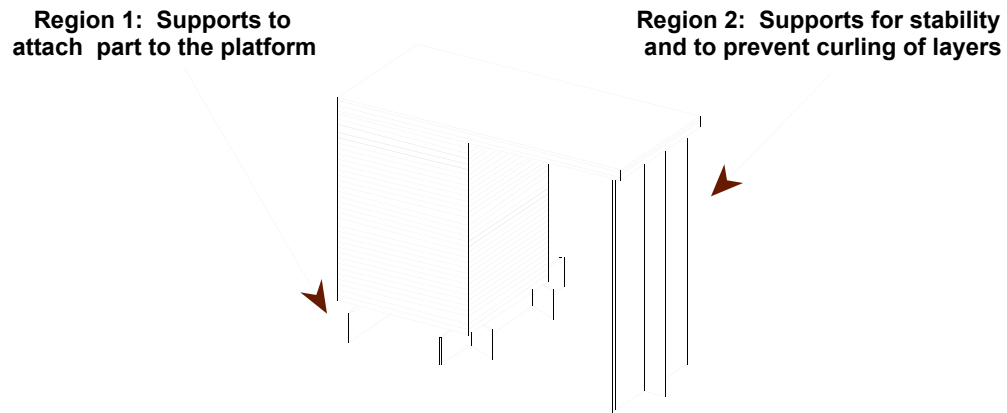

Figure 2-3. Support structures to prevent deformation and curling.

The final component of the software system is the slicing feature. Slicing converts the .stl file data into two-dimensional cross sections and transmits the .stl file information into layer vector data. This layer information defines the geometric patterns which the laser will scan at each individual layer. A layer thickness is assigned to each cross section during the slicing procedure. The surface finishing of each prototype is dependent upon the layer thickness assigned to each slice. Thin slices offer the best quality in terms of finishing and surface quality. However, at the same time, these layers also increase the build time and thus, cost as well.

2.2.3 Stereolithography Process

The stereolithography process begins with downloading the files created in the software system to the SLA build-station. The data from the files supply information to deflecting mirrors which direct the laser beam onto the resin. Each layer is 'etched' by the laser in the X direction and then again in the Y direction. Supports attaching the part to the platform are first created. After completion of the

first layer, the platform is lowered into the resin. An uncured layer of resin coats the previously cured layer. To ensure the layer has a uniform thickness, a recoater blade sweeps across the uncured layer. A second layer is now ready for curing. The process is repeated and successive cross sections of the part are created from bottom to top, one layer at a time on top of the platform. Once the entire part is completed, the platform and part emerge from the vat of liquid resin.

A part is 98% cured when it emerges from the stereolithography apparatus. To achieve the final 2% of curing, the part must be drained, relieved of residual liquid resin, supports must be broken off, and then cured in a post curing apparatus (PCA). The PCA fully cures the part so that it achieves full resin strength. The following figure 2-4 illustrates a work table for cleaning and the post curing apparatus:



Figure 2-4. Stereolithography cleaning work table and post curing apparatus.

2.3 EXISTING RAPID PROTOTYPING TECHNOLOGIES

Aside from stereolithography, there are several other rapid prototyping technologies existing in the manufacturing world. Each technology differs from others and offers its own uniqueness and competitive features to its users. However, all the existing systems are created on the same principles and philosophy. Following is a brief description of four competing RP technologies popularly used within industry and the academia worlds.

2.3.1 Laminated Object Manufacturing (LOM)

Helisys, Inc. developed the Laminated Object Manufacturing technology. As the name suggests, this technology builds objects by laminating thin, consecutive sheets of material. The sheets are joined by the use of an adhesive which is sensitive to temperature and pressure alike.

The first stage in the LOM process is the CAD modeling of the object to be prototyped. The file is exported in the .stl format and sliced in layers with a thickness identical to that of the material to be used in the building process. Material is fed into the work area of the LOM by means of a feed roller. After each layer is cut by a carbon dioxide laser, the computer controlled platform is lowered allowing for a new layer of material to enter the workplace. This new layer is adhered to the previous layer as a heated roller traverses across the material, thus, bonding the consecutive layers. The two figures shown in figure 2-5 are taken from a Helisys, Inc. publication to illustrate the LOM process and demonstrate part building.

(a) LOM Process

(b) LOM part building

Figure 2-5. Laminated object manufacturing process and part building.

LOM is noted for its capability of building larger and bulkier parts. Also, the surrounding unwanted material acts as supports for the part. This layer-subtractive process, does however, require intense post-processing.

2.3.2 Selective Laser Sintering (SLS)

The initial development of the selective laser sintering (SLS) process was done at the University of Texas in Austin. The product is now sold by DTM Corporation in Austin, Texas. This layer-additive process is based on the sintering or fusing of small particles by use of a high powered carbon dioxide laser. The SLS process also requires .stl files which are then sliced into thin cross sections.

A thin layer of powdered material is dispensed over the work area by a feed cylinder, piston, and counter-rotating roller. A second feed cylinder removes excess material which used to form subsequent layers. The process chamber of the SLS station is kept in an inert nitrogen environment to prevent any oxygen contamination of the bonding surfaces and possible combustion. Additionally, to minimize the laser output, the powder is kept at an elevated temperature. Orthogonal mirrors and an optic unit direct the carbon dioxide laser beam on the working area. The heat from the laser cause the particles in the material to fuse and bind, forming a solid object. After each layer is traced by the laser, a new layer of material is deposited into the work area and the process is repeated until the part is completed. Figure 2-6 demonstrates the selective laser sintering process. [Kalpakjian, 1992]

Figure 2-6. Selective laser sintering build process. [Kalpakjian, 1992]

The completed SLS part is encased in a large powder cake. This approach is an advantage since the powder cake serves as supports for any cantilevers or isolated structures within the part. The part must be removed from the cake after it has cooled down for a few hours. The surrounding powder is cut away and the part is appropriately post-processed.

2.3.3 Fused Deposition Modeling (FDM)

Stratasys, Inc. has developed the fused deposition modeling (FDM) technology which uses spools of thermoplastic filament for the fabrication of prototypes. Material is heated in a delivery head just beyond its melting point. The thermoplastic is then expelled from the head via a nozzle as a thin ribbon. The ribbon is deposited according to the geometry of the object as controlled by a computer. The FDM technology also builds prototypes in subsequent thin layers.

Layer thickness is dependent upon the physical properties of the material, extrusion pressure, delivery headspeed, and the dimensions of the nozzle exit. The temperatures of the liquefier and substrate are crucial to the surface finish of prototypes built using FDM technology.

FDM is an advantageous method as it offers a large variety of thermoplastic materials to build prototypes. Similarly, FDM is versatile in the environment in which it may be used. Due to the fact that no high powered lasers are required in this technology, FDM machines may be used in an office environment as well as in laboratories.

2.3.4 Solid Ground Curing (SGC)

Solid Ground Curing (SGC) was developed by Cubital, Ltd., in Israel. This technology involves the usage of photopolymer resins similar to those used in the stereolithography process. However, SGC technology does not use lasers, rather, multiple steps must be completed to create prototypes.

Similar to other RP technologies, SGC requires a CAD model of the object to be prototyped. The CAD file is then downloaded to the Cubital work station or the “Data Front End” (DFE). The file is then converted into a Cubital Face List (CFL) which contains all necessary cross-section information for each layer. This information is used to create masks. A charge is created on a glass plate corresponding to the cross section of a layer. The charge is created by ionography. Next, black toner is spread across the plate and it adheres to the charged locations. Remaining toner is then removed. A substrate with a thin layer of resin is then

moved to an exposure station. The glass plate is then moved above the substrate and subjected to ultraviolet radiation. Thus, wherever the mask is transparent, the photopolymer is cured. Areas with the toner powder on the glass block out the radiation. After curing, an air knife removes any uncured resin remaining on the plate. The described procedures are repeated until the prototype is completed.

SGC provides an advantage over all the other RP methods as it allows for prediction of build time. Each layer in the SGC process takes the same amount of time to build, independent of part geometry or size. Therefore, an accurate build time may be determined by multiplying the number of layers by the time per layer.

2.3.5 Summary

Table 2-1 summarizes the existing rapid prototyping technologies. The systems are evaluated based on cost, build areas, major applications, and materials used. Information within the table is acquired from respective companies and based on the products listed under each company name.

Table 2-1. Summary of rapid prototyping companies and products.

Company	Cost (approximate)	Build Area l x w x h (mm)	Accuracy (mm)	Material
3DSYSTEMS - SLA 250/40	\$145,000	250 x 250 x 250	+/- 0.0406	epoxy, acrylate resins
Helisys, Inc. - LOM 1015 Plus	\$ 92,000	381 x 254 x 355	+/- 0.127	paper
DTM - Sinterstation 2000	\$300,000	305 diam x 381 hgt	+/-0.0635	wax, nylon, steel - copper
Stratasys - FDM 1650	\$125,000	254 x 254 x 254	+/- 0.127	ABS, wax, polyester
Cubital - Solider 4600	\$275,000	350 x 350 x 350	+/- 0.100-0.150	polymer resin

2.4 VACUUM CASTING

2.4.1 Investment Casting

Casting is one of the oldest existing industries which brought an end to the Stone Age and started the Bronze Age. Of all casting techniques, investment casting is the most ancient form of metal casting and has documented use prior to the creation of Egypt's pyramids and during China's Shang Dynasty (1766 to 1122 BC). This method of casting usually employs a wax pattern to produce duplicates. Investment casting involves dipping the wax pattern in a slurry of refractory material repeatedly so as to build a mold. After the dipping, the mold is dried and fired. The firing will melt out the wax pattern. The next stage involves the casting procedure which begins with pouring the casting material into the mold. After solidification, the mold is broken and the casting is removed.

2.4.2 Vacuum Casting

Based upon the principles of investment casting, vacuum casting is also a popular method for creating replicas. However, the major difference between the two methods is the material used for the mold and for the castings. Vacuum casting uses polyurethane materials to create casts. These types of castings have been in use for over twenty-five years.

Vacuum casting generally offers superior properties to other casting methods which generate limited runs of parts. Advantages include finished surfaces, void-free interior structure, clarity or color if desired, and close tolerances

to a predetermined size. The closer dimensional tolerance and absence of voids also result in parts with physical properties closer to those expected from production runs of injection molded thermoplastic shapes. Additionally, this technology offers more part to part consistency and finished parts within thirty to forty minutes. The combination of all of these advantages makes vacuum casting a very attractive method of producing casted parts.

Vacuum casting has been used around the world in many industries. In the automotive industry, multi-component assemblies have been used for environmental standards testing. Pre-production design verification of enclosures and assemblies enable faster time to market in the electronics industry. In the consumer products marketplace, vacuum casted parts that are indistinguishable from production parts are used for evaluation by consumer focus groups.

2.4.3 Procedure of Vacuum Casting

Vacuum casting represents the current state of the art in creating accurate casts in required quantities in the shortest period of time. The entire process begins with a pattern (usually one created from a solid freeform fabrication method) and the mold making and duplication process proceeds as follows:

1. The first step is to prepare the pattern for the casting process. The pattern may be made of metal, wood, plaster, plastic, or wax. This includes rapid prototyped patterns made from epoxy, wax, polyethylene, ABS, nylon, polystyrene, polycarbonate, vinyl esters, acrylates, and paper. Any finishing on the part which will

not effect the silicone curing process may be used. The finish of this pattern is very critical as the surface finish and tolerances will be faithfully reproduced in the casting process.

2. Casting gates and vents are fitted to the pattern, parting lines are established, and the pattern is suspended in a casting frame. Figure 2-7 illustrates a pattern suspended in a casting frame with a gate attached to it.

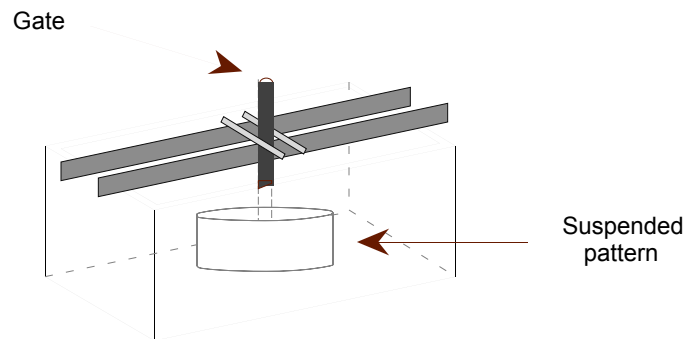

Figure 2-7. Casting frame with suspended pattern.

3. After room temperature vulcanizing (RTV) silicone is poured into the casting frame as shown below in figure 2-8:

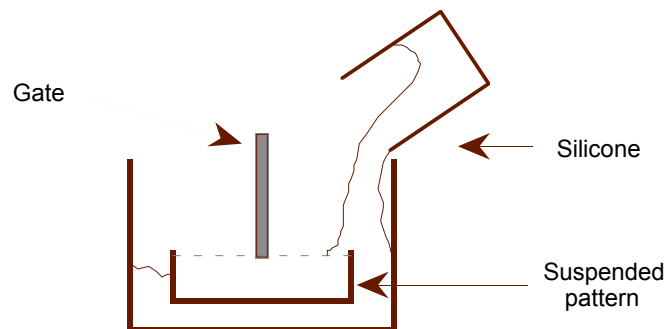

Figure 2-8. Casting the silicone rubber mold.

Next, the frame is placed into the vacuum chamber to de-gas the silicone (figure 2-9). This results in the accurate replication of part features.

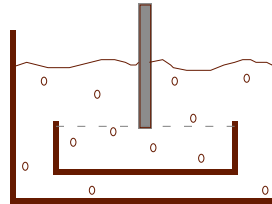

Figure 2-9. De-gassing of the mold in the vacuum chamber.

4. After a 4 hour cure of the mold, the casting frame is removed, the mold cut apart, and the master pattern removed.
5. The mold is prepared for casting with a light spray of mold release. All the parts of the mold are then taped together, as shown in figure 2-10, and a connector is fitted into the runner of the mold.

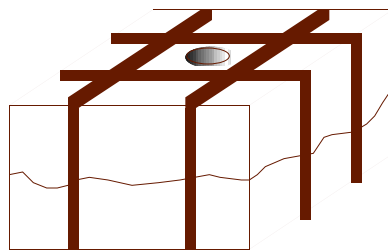

Figure 2-10. Taped mold.

6. Plastic tubing connects the mold to the funnel and the mold is placed in the vacuum casting equipment's vacuum chamber. The

casting materials, resin components A and B, are then weighed and positioned in into the brackets in the noxing and pouring robot.

7. A computerized cycle controls the vacuum pressure along with the mixing and de-gassing of the resin components. The equipment is computer controlled and may be customized with program variations for different shot sizes, resin viscosity, and gel times.
8. The resin is automatically poured through the funnel into the prepared mold in the lower part of the chamber. As the resin enters the mold, the vacuum is slowly leaked. This creates a positive pressure differential to ensure complete mold filling. The complete cycle in the equipment takes approximately 8 minutes.
9. The resin cure is concluded in an elevated temperature chamber at 70 C. In 20-40 minutes, the mold is removed from the oven and the part is de-molded.
10. To finish the part, the sprue and vents are cut off and the edges are finished. The part is now completed and the mold is ready for re-use in less that one hour from the initial mold preparation. No additional post curing cycles are needed to improve the physical properties of these castings.

2.4.4 MCP Vacuum Casting System

The material presented in this thesis work involves castings made by the vacuum casting technology. The equipment used to complete the work is made by MCP Systems, Inc., based in Fairfield, Connecticut. Figure 2-11 illustrates the equipment, MCP Vacuum Casting System 001 ST, and its important components. MCP System equipment are used by various companies including Polaroid, Porsche, and many others.

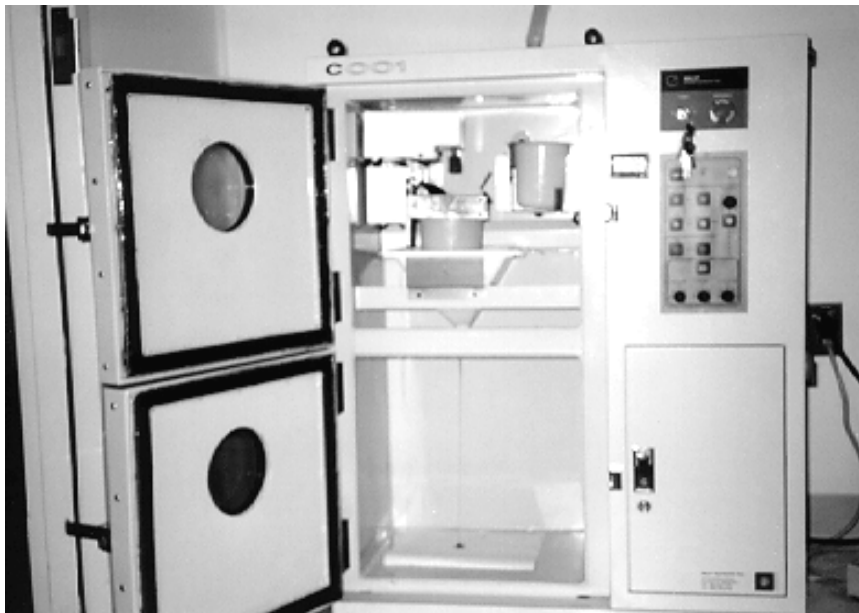

Figure 2-11. MCP VC System 001 ST used in research work.

2.4.5 Success of Using Vacuum Casting at Porsche

Many companies have incorporated vacuum casting into the design cycle. Porsche, a major car maker, is just one of these companies which has recognized the benefits of incorporating such a process into its product development of fan

blades, reflectors, and other automobile components. Engineers at the company employ vacuum casting for a wide range of purposes ranging from planning to building tooling. The company has also used various other methods for prototyping and has proven how powerful vacuum casting is in terms of cost, time, and material choices.

The following tables illustrate how Porsche has incorporated vacuum casting into the design cycle. Table 2-2 shows the stages in product development and the amounts of parts which would be needed for each stage. From the table, it is seen that the desired amount of parts ranges from 1 to 5,000. The initial planning and designing require a total of only up to 15 parts. Thus, rapid prototyping alone is not practical to create the replicas, and soft tooling, such as vacuum casting, is ideal. Vacuum casting may also be used for parts needed in the research and development stage. However, once the development reaches the building tooling and development and administrative stages, other methods of fabricating parts must be explored.

Table 2-2. Number of prototypes for each development stage at Porsche.

DEVELOPMENT STAGE	PURPOSE OF THE SAMPLE	DESIRED NUMBER OF SAMPLES
Planning	Planning of a new product	1
Artist's Design	Examination and approval of the product (image)	1 - 4
Design	Examination and approval of the design (assembly of the model)	4 - 10
Research & Development	Examination and computation of functional studies, working model	10 - 50
Building Tooling	Study and approval of costs and preparation for production	50 - 5,000
Development & Administration	Overall Examination and approval of the production process	1- 5,000

Table 2-3 illustrates different methods and the specifications associated with each method used by Porsche to acquire the parts shown in table 2-2. Each method is evaluated based on cost, weight of material, time, number of parts, and reusability. If machining is considered a cost of 100%, Porsche has found vacuum casting costs 2-5 % of the machining costs. Evidently, cost associated with vacuum casting are significantly lower than all of the other methods described in table 2-3. Furthermore, of all the methods listed in the table, vacuum casting requires only 8 to 12 hours to produce all parts. This is extremely important when considering the overall design cycle and time required for evaluation and iterations. Such a shortened lead time and low cost would create numerous opportunities for iterations, modifications, and adjustments in the design of the product.

Table 2-3. Comparison of prototype production methods employed by Porsche.

Mold Production Mtd.	Costs	Cast/Spray Weight (kg)	Production Time	Numbers	Reusability
Steel mold (machining)	100%	unlimited	50 days	over 100,000	below 5%
Fine zinc (cast)	70%	4	40 - 50 days	10,000	90%
Nickel (galvanically coated)	23%	2-4	60 days	5-10,000	-
MCP/TAFA (metal sprayed)	15%	3-5	within 3 days	1,000 - 6,000	90%
Silicone (vacuum cast)	2-5%	4	8- 12 hours	up to 100	-

Thus, the versatility and potentials of vacuum casting have been described. This method offers a wide range of advantages to the users, and most significantly, in a reduced amount of time. The vacuum casting method combined with the

stereolithography process proposes a very powerful tool for rapid replication of prototyped parts.

2.5 MEDICAL APPLICATIONS

A new and exciting practice followed by many physicians and surgeons is known as computer aided surgery. This phenomenon is making an impact in the medical arena for its uses of visualization, patient consultation, procedural practices, etc. One application of computer aided surgery converts Computer Tomography (CT) or Magnetic Resonance Image (MRI) data into CAD solid models. Using rapid prototyping technologies, the CAD models are used to construct prototypes of the patient's imaged bone, ligament, etc. Thus, this technology allows the physician or surgeon to have a prototype of the patient's body part prior to the commencement of any medical procedures. The prototypes are very useful and effective in terms of improving and reducing medical expenses. The prototypes are also used to create custom implants prior to surgery as opposed to traditional means where surgeons essentially carve the implant while in the operating room. In this thesis work, CT scans are used to reconstruct a solid model of a monkey skull. Thus, an example of utilizing a form of computer aided surgery and the principles of CT scanning are explained in the following sections.

2.5.1 Example of a Medical Application

To date, this practice has been employed in various cases around the world. In particular, a case in Australia involving a woman with a tumor the size of an apple illustrates the power of the concept of computer aided surgery. Traditionally,

to remove the tumor, surgeons would have to remove a large portion of the skull during surgery, thus, leaving a sizable area of the brain exposed. The challenge in such a scenario is to patch the hole as quickly as possible to reduce the amount of risk of infection. The head surgeon, Dr. Paul D'Urso, has been a strong promoter of computer aided surgery. He quickly acquired the patient's CT scans and processed the data using a software package to separate the boney material from the patient's flesh shown in the CT scans. After processing, build files are generated and a model of the patient's skull is created on a stereolithography apparatus. Support structures are then removed from the part and it is post-cured.

The surgeons utilize the model in many different ways. First of all, the model is used as a diagnostic tool for pre-operative planning to describe the surgery to the patient. This helps the patient understand the procedure and reduce her level of anxiety and stress. A second model is used to actually rehearse surgical procedure. The surgeons remove the "tumor" from the model and fit a stereolithography created prototype of an implant into the modeled skull. A mold of the prototyped implant is then made and cast prior to surgery for actual use.

From the model, the surgeons were able to gage exactly where to make incisions, and what area of the skull to remove. The tumor is removed and the implant is fit into the skull. This procedure is completed successfully allowing the patient full recovery. More importantly, the procedure is completed in a shorter amount of time which reduces high risks to the patient and also saves money.

Surgeons estimate that the use of a medical prototype saves a minimum of 20% surgical time. [The Edge, 1995] This reduction in time results in a reduction

of blood loss, amount of administered anesthesia, and the risk of infection. These factors result in lower surgical costs which truly mean saved money for the patient and hospital.

2.5.2 Computer Tomography (CT) Scanning

Computer tomographic (CT) scanning is an alternative method to medical imaging but not always desirable due to the slight risk that accompanies the low radiation doses of CT scanning. Despite the drawback of CT scanning, it remains revolutionary in medical imaging in that there is no image receptor, such as film. A collimated x-ray beam is directed on the patient, and the remnant radiation is measured by a detector whose response is transmitted to a computer. The computer analyzes the signal from the detector, reconstructs an image, and displays the image on a television monitor. The image can then be photographed for further evaluation and analysis.

The basic principles of CT scanning can be demonstrated if one considers the simplest of systems, consisting of a finely collimated x-ray beam and a single detector. The x-ray source and the detector are connected so that they move synchronously. When the source-detector assembly makes one sweep across the patient, the internal structures of the body attenuate the x-ray beam according to their mass density and atomic number. The intensity of radiation detected varies according to this attenuation pattern and forms an intensity profile. At the end of this translation the source-detector assembly will return to its starting position, rotate, then begin a second sweep across the same cross-section. This process will be repeated several times, generating a large number of projections. The effective

superposition of each projection creates an image of the anatomic structures in that slice.

Chapter 3

An Integrated Rapid Prototyping and Vacuum Casting Process

3.1 NEED FOR AN INTEGRATED PROCESS

Like all other methods, rapid prototyping has a series of limitations. The first limitation is the cost associated with using rapid prototyping, more specifically, the cost associated with using stereolithography, is significantly high. These high costs are attributed to initial equipment, material costs, and costs to support high technical personnel. Furthermore, most rapid prototyping technologies do not have cost analysis or estimation techniques associated with each individual build.

Another short coming is often encountered as rapid prototyping techniques are limited in terms of material. Each rapid prototyping technology uses very particular types of material. For example, stereolithography employs photopolymer resins while laminated-object manufacturing uses paper and plastic. These materials are often not the same, or even remotely similar, as the properties of a final product. These materials usually have "poor to marginal mechanical and thermal properties compared to the end use materials." [Jacobs, 1996] For fit and function testing, it is evidently important to have a prototype with similar material properties as the final product, which rapid prototyping materials cannot always offer.

Often, to evaluate a product in the design stage, a small batch of prototypes is required. These batches, approximately 10 - 20 prototypes each, are used for fit, function, and concept testing. However, producing these batches by means of the stereolithography process, through repeated build procedures, is proven to be cost inefficient. Thus, a critical challenge is created for those requiring the multiple prototypes. Users recognize the extreme importance of having prototypes prior to mass production, however, find it difficult to justify using rapid prototyping to create each batch due to the cost and material limitations.

Thus, to meet the needs of designers and engineers, an alternative method must be developed by which the prototype batches may be created. An ideal system would use a stereolithography part as a master to create further replicas by another process which would create multiple prototypes made of various materials greater resembling end product material properties.

3.2 REQUIREMENTS FOR AN INTEGRATED PROCESS

The more time spent in the prototyping stage of product development, more opportunities are lost for creating profits. This philosophy is what drives many industries as they develop new products. Recognizing the need for a method to quickly create multiple prototypes of a single part, efforts have been made to develop a system for cost efficient rapid replication. This system gives users the freedom to verify the design and ensure quality of it before mass production and introduction to the market. Such a method would combine two manufacturing processes including stereolithography and a tooling process. In this system, the first manufacturing process is used to produce a master pattern. The second

manufacturing process uses the master pattern to produce a batch of replicas that will be used as functional prototypes.

In order to achieve the desired integrated system, an appropriate secondary process must be determined. Based upon the quantity of replicas needed, a soft tooling application is employed with the stereolithography process as opposed to hard tooling. Soft tooling is a secondary process in which materials with low hardness levels are used to make a mold. From the mold, functional prototypes are made through a casting process. Soft tooling is a tool used for low-cost, small production quantities. Of course, 'small production' is relative to each industry and must be internally defined. To ensure the quality of the mold, materials with low hardness levels are used, such as silicone, rubber, epoxies, aluminum, etc. Likewise, in hard tooling, the most commonly used material is steel and production quantities range from 1,000 to over 500,000.

A combined process of rapid prototyping and soft tooling must fulfill certain characteristics in order to satisfy the needs of design engineers. The engineers perform functional evaluation of the functional prototypes in terms of:

1. The prototype should look like the final product in terms of dimensional tolerance accuracy, production quality surface characteristics (finish), and color are factors to consider.
2. The prototype should be made of a material with similar physical characteristics to the finished product so that it may be tested for

strength and durability. It should be free of internal voids and other unpredictable features.

3. The prototype should be made in large enough quantity to facilitate and expedite design changes and iterations.
4. The individual items in a prototype run should be identical each with the others.
5. The prototype should be easy to change, in response to review and suggestions. Therefore, it must be produced, modified, and revised in an appropriate time frame.

3.3 THE ROLE OF VACUUM CASTING IN AN INTEGRATED PROCESS

Vacuum casting has become a widely accepted method of soft tooling, replacing traditional methods such as investment casting. Vacuum casting is a newer version of investment casting with changes to the process of creating the mold. Several needs are addressed by vacuum casting which make it extremely popular. Most importantly, vacuum casting reduces the time for part production when compared to tradition methods. This, in turn, significantly reduces costs. The additional following characteristics offered by vacuum casting justify the choice of this technology for the integrated process:

1. Accurate Castings: Textures, fine details, and complex surfaces are exactly reproduced from the master model due to the replicating nature of the silicone rubber mold.
2. Consistent Quality: Vacuum casting produces dimensionally stable and accurate castings. The technique allows castings of thin wall and void free sections as well. Furthermore, vacuum casting in silicone molds allows producing parts with undercuts because the pliable silicone molds do not present problems when removing casted parts, even with undercuts, from the mold.
3. Up to 95% Saving in Time: After the silicone mold has been created, replicas of the master model may be fabricated within a few hours, depending on the number of parts required.
4. Fit and Function Testing: The casted parts are sufficiently accurate so that fit and function testing may be conducted to determine which modifications must be made.
5. Cost Savings: Using vacuum casting offers reductions in cost when compared to rapid prototyping or traditional hard tooling.
6. Material Choices: Vacuum casting resins simulate production thermoplastics, rubber, and glass. Additionally, the resins sustain high impact and resist elevated temperatures. With

vacuum casting, users have the options to create clear or colored parts as well.

3.4 THE ROLE OF STEREO LITHOGRAPHY IN AN INTEGRATED PROCESS

Stereolithography plays a very vital and key role in the proposed integrated process. Stereolithography parts are preferred for producing the master pattern for various reasons including the ability to sustain elevated temperatures. Epoxy resins used in a stereolithography apparatus have glass transition temperature (in general, the temperature related to the softening or hardening of an amorphous material) values of about 80° C (175° F). [Jacobs, 1996] In vacuum casting, the master pattern is exposed to a maximum of 40° C. Thus, there is no risk of a stereolithography part melting or burning out during the silicone mold curing process.

The accuracy of stereolithography parts is extremely important. Stereolithography parts are well known for the overall accuracy of a finished prototype. To illustrate this point, consider a study conducted on user-part accuracy with measurements taken by a Brown and Sharpe Coordinate Measuring Machine (CMM). The root-mean-square (RMS) error is calculated from over 170 measurements (on one user part) and a total of ten different user parts are used for each study.

Based on the overall part accuracy, the RMS value for a stereolithography built part is 0.0016 inch. For comparison purposes, a similar test involving the selective laser sintering process is conducted. The results of this study show the

SLS overall part accuracy to be 0.0064 inch. These values may seem nominal, however, they are significant in terms of tolerances and part accuracy when compared to the original dimensions.

Stereolithography is quickly approaching the accuracy offered by NC machining processes. The same test described above has been repeated on user-parts since 1989. During the time frame from 1989 to 1994, the overall part accuracy has improved drastically with RMS values of +/- 0.0089 to +/- 0.0018 inch. Various factors contribute to this improvement including advances in software, hardware, materials, processes, etc. The improvements also show the potentials of stereolithography compared to other rapid prototyping technologies and their lack of advancements.

3.5 INTEGRATED PROCESS

In this research work, stereolithography and vacuum casting are chosen for an integrated process based upon the advantages and characteristics each offers. Combined together, an integrated process gives users the opportunity to analyze and verify a design quickly and with extreme accuracy and precision before launching into mass production. The prototypes provide designers and engineers a method by which testing, verification, and modifications may be made with ease. This integrated process, as described, also gives users the advantages of increased iterations to the design.

Very importantly, the prototypes are available in a short amount of time and at low cost. Integrating vacuum casting with stereolithography eliminates the high

costs associated with rapid prototyping alone, while still providing users with the batches of prototypes required. Both cost and time play extremely critical roles in the product development cycle.

Thus, the ideal integrated process is a combination of stereolithography and vacuum casting. Stereolithography is used to create the master pattern, and in turn, vacuum casting is employed to fabricate a silicone mold. The mold creates essentially exact replicas of the master model. The process and quantities of parts are illustrated in the following flow chart in figure 3-1.

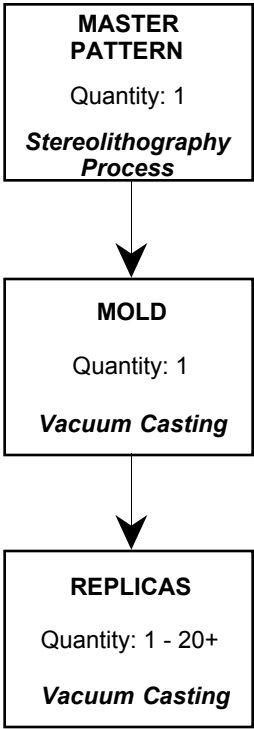

Figure 3-1. Flow chart of the integrated process.

Chapter 4

Cost Evaluation of Using Rapid Prototyping Technology

There is an impressive number of success stories concerning applications of rapid prototyping, such as revenue increase due to early introduction of products to market, and the strengthening of concurrent engineering of design and manufacturing. Rapid prototyping has created a new business sector. Although rapid prototyping is a fast-growing industry, its acceptance by industry in the product development cycle has been slow. Due to the high initial capital investment of rapid prototyping equipment, large sized companies must evaluate their ability to afford equipment for in-house applications. Most small and medium sized companies, must rely on engineering service bureaus and infrequently do so due to their high charges for rapid prototyping services.

The uncertainty and high risk on the rate of investment and capital return have caused barriers between technology providers and users. To promote this emerging technology for industrial applications, reliable and useful information on cost estimating and cost analysis of rapid prototyping is needed. Thus, this chapter presents a study which aims to enhance the potential for efficient utilization of rapid prototyping.

The complexity of rapid prototyping is characterized by the requirements for special skills, methods, and equipment. Due to few texts or high technical treatises on mathematical and statistical aspects of estimating cost items which are directly associated with rapid prototyping, a logical method is employed in this

evaluation. First, a top-down approach is used to define the major steps involved in applying rapid prototyping. Next, a decomposition approach is used to itemize individual engineering steps involved at each stage. The approach calls for estimating labor hours, material consumption, equipment depreciation, and pricing of other work related to the rapid prototyping process.

4.1 PROCESS FLOW OF RAPID PROTOTYPING

There are four key steps in applying rapid prototyping to the product development cycle. These steps include 3D solid modeling, data preparation for solid freeform fabrication, part building process, and quality inspection of built prototypes. Figure 4-1 illustrates the four key steps and the process flow of rapid prototyping.

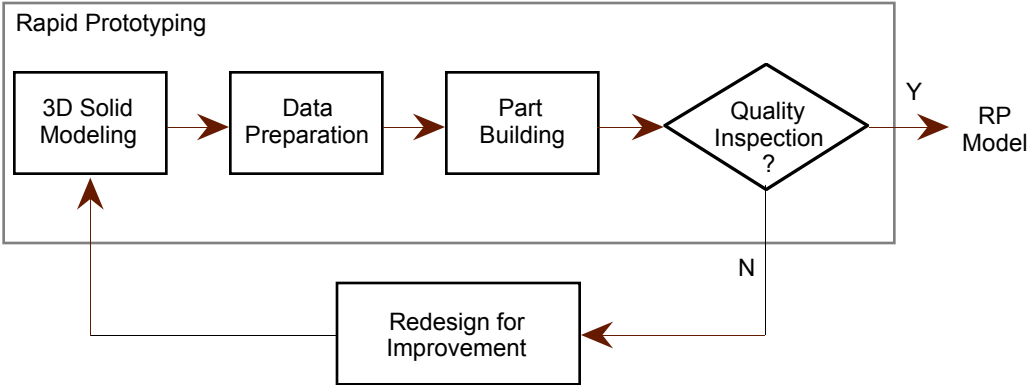

Figure 4-1. Process flow of rapid prototyping application.

Cost estimation of each of the four key elements is based on personnel, equipment and facility requirements. These three requirements are the main

resources which provide companies with the capability of carrying out business activities.

4.2 COST STRUCTURE AND COST ESTIMATES

Based on the rapid prototyping process flow, an industrial engineering approach towards cost estimating is used in this study. Cost elements are identified through engineering activities involved in each of the four key steps of rapid prototyping applications. A cost analysis is performed to justify the presence of the cost elements.

4.2.1 Cost Estimates Related to 3D Solid Modeling

In analyzing the engineering process of 3D solid modeling, three important cost elements are identified. The elements are: costs of converting 2D drawings to 3D solid models, recreating cosmetic features, and the adjustment of dimensions associated with tolerances.

4.2.1.1 Conversion of 2D Drawings to 3D Solid Models

Building processes of solid freeform fabrication require the contour of a layer to be in a closed format. Thus, CAD solid modeling plays a critical role in the rapid prototyping process. Due to the importance of concurrent engineering, many companies have adopted 3D solid modeling as a stage of their product development. Solid modeling provides companies the freedom to model and prototype a design before implementing or documenting it. This is crucial because often that design may not be feasible or appropriate for the pre-set requirements.

For companies who implement this practice, no cost is associated because their engineering designs already begin with 3D solid modeling. However, companies who use 2D drawings as the documenting format, would need to estimate costs for converting the drawings to 3D solid models. Figure 4-2 demonstrates the conversion from 2D drawings to 3D solid modeling. Figure 4-2(a) illustrates the 2D drawings of an urn. The 3D solid model is shown in figure 4-2(b) and a shaded version of the solid model is illustrated in figure 4-2(c).

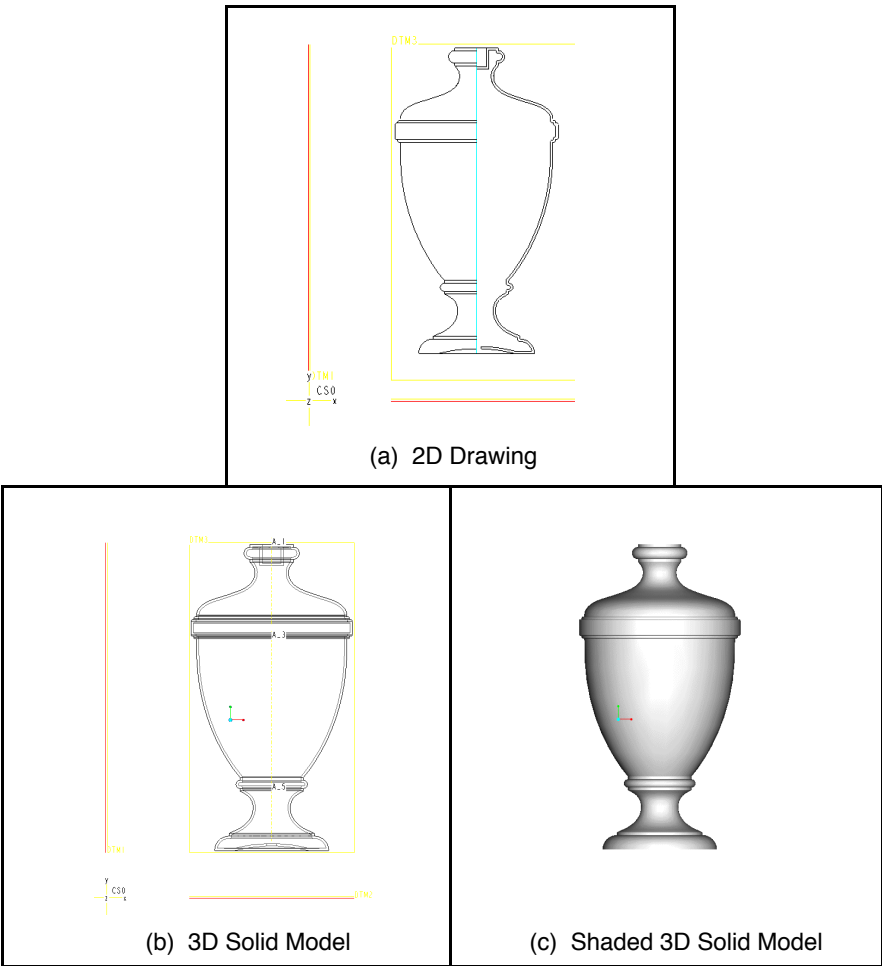

Figure 4-2. Conversion of a 2D drawing to a 3D solid model.

Two major costs elements for this process are:

Equipment Costs: These costs are related towards the purchase of computer(s) and CAD software. Due to the high costs of such hardware and software, the cost is entered into the overall cost estimate of rapid prototyping. Generally, these purchases are used for supporting other engineering tasks in the company as well. Equipment costs, which also include the costs for maintenance and operation of the items, are considered as an element in overhead costs.

Labor Costs: Solid modeling requires special skills for operating and implementing both hardware and software. Additional expenses to pay design engineers and other trained professionals with relatively high wages are anticipated.

Engineering service bureaus in the Eastern Region of the United States, indicate the charge to convert 2D drawings to 3D solid models is approximately \$40 per hour with an overhead rate of 35%. Therefore, a total cost of \$540 is expected for a total of 10 hours of work, explained by the following calculation:

$$(\$40 \times 10 \text{ hours}) \times 1.35 = \$540$$

4.2.1.2 Recreating True Geometric Shapes as Replacements for Cosmetic Features

For companies who implement 3D solid modeling as opposed to 2D drawings, no costs are associated with (1). However, additional costs for recreating cosmetic features of components in the design stage are still required. An example of this would be any design with threads. Based on ISO 6410 and ANSI standards, threads are represented as dashed lines and specialized symbols respectively. This convention of engineering design has been implemented by most CAD systems. However, these methods of cosmetic representation do not fit requirements of solid modeling for rapid prototyping. Cosmetic features of the thread must be replaced by true geometric shapes on the designed object. Figure 4-3 illustrates a pair of two components coupled with external and internal threads. True geometric shapes, i.e. thread form, pitch, length, and location of the starting surface have been created accurately.

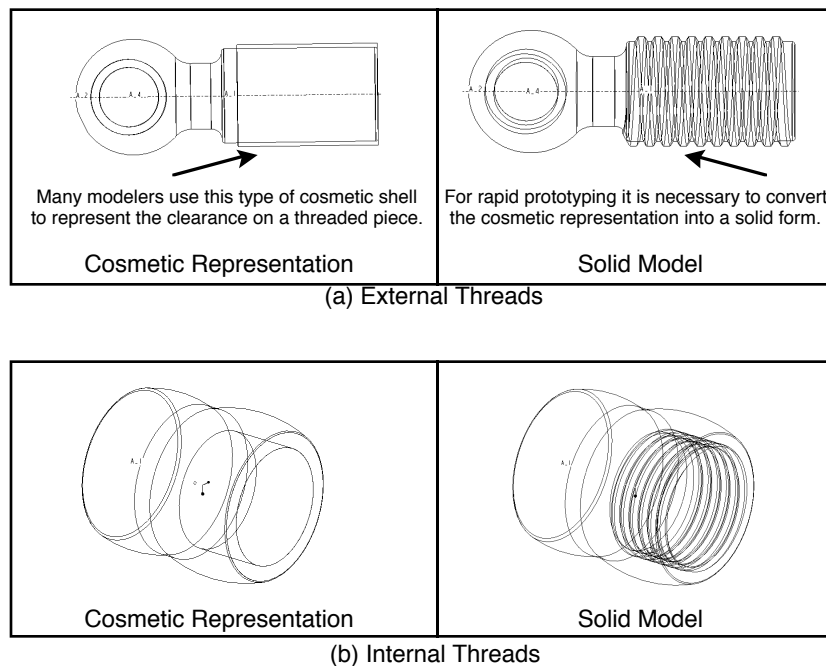

Figure 4-3. Cosmetic features versus solid models.

4.2.1.3 Dimensional Adjustment to Accommodate Tolerance Requirements

Additional costs may be needed for adjusting dimensions related to assembly. When prototypes are being made with two or more parts, dimensions regarding tolerances must be adjusted to reflect the design intent. An example of this situation are the components illustrated in Figure 4-3. The thread diameters must be adjusted to ensure that the two components may be successfully assembled.

Both equipment and labor costs are applied to recreating geometric shapes and dimension adjustment. Cost estimating should follow the same procedure as used in (1). For 3 hours of replacement work and 2 hours of adjustment work, the cost may be as high as \$270, including overhead costs, or:

$$[(\$40 \times 3 \text{ hours}) + (\$40 \times 2 \text{ hours})] \times 1.35 = \$270$$

4.2.2 Cost Related to Data Preparation for Solid Freeform Fabrication

Solid freeform fabrication is characterized by building a solid part layer by layer. There are several critical requirements in this process. To eliminate difficulties created by trapped volumes of liquid resins during the building process, selection of part orientation for building is extremely critical. To ensure accuracy, support structures have to be designed and added to part geometry prior to building. Deflection of thin, solidified layers without sufficient supports causes distortion of the part and tolerances. A software tool is also required to slice the part in horizontal cross sections for part building.

All of the stated requirements call for special skills, and, in turn, applicable labor costs. Additionally, specialized software tools are needed to assist in the designing of support structures and the generation of slicing files. These tools come with the rapid prototyping equipment and are limited only to rapid prototyping applications. Most engineering service bureaus apply relatively high charges for these services. Labor costs range from \$60 to \$80 per hour with a 35% overhead rate. Therefore, 3 hours of data preparation may cost as much as \$324:

$$(\$80 \times 3 \text{ hours}) \times 1.35 = \$324$$

4.2.3 Cost Related to Part Building

Costs related to the part building process are dependent upon the specific rapid prototyping technique used. In this study, cost analysis is based upon the stereolithography process. Stereolithography employs a slow building process as the rate of solidification limits the rate of energy absorption to ensure part accuracy. In other words, the size of the laser spot is kept minimum so parts with greater accuracy will be created.

The initial investment of a stereolithography apparatus is relatively high. A machine (3D Systems SLA 250) with a build envelope of 250 x 250 x 250 mm is priced at \$200,000. Currently, maintenance costs account for 10-15 % of the equipment purchasing price. Costs associated with laser replacement must also be included in equipment costs. Thus, it is shown that although a fully automatic and unattended stereolithography operation is claimed to reduce labor costs, the

operational costs are high. Engineering service bureaus indicate hourly charges of \$130 for part building.

Cost of the photo reactive resin used in the stereolithography process stands for a variable cost item to cover material consumption. Material costs are associated with both, the built solid as well as support structures. A built part weighing 1000 grams ranges from \$100 to \$200.

A surcharge fee is generally enforced to cover the labor cost for setting up the machine, cleaning supports from the built part, post-process curing for final solidification, and surface finishing, such as light sanding of the part. An average surcharge fee of \$150 per part is usually added. By summing, equipment, material, and labor costs, a part weighing 500 grams and requiring 12 hours of build time may cost as much as \$1,785:

$$[(\$150 \times 0.5 \text{ kg}) + (\$130 \times 12 \text{ hours}) + \$150]1.35 = \$1,785$$

4.2.4 Example

To summarize the discussion of cost analysis for applying rapid prototyping, and to quantify each cost estimate, an example is used and illustrated in Table 4-1. An assumed part requiring 10 hours for converting 2D drawings to a 3D solid model, 2 hours for data preparation, and 10 hours of build time is employed. The final part weighs 100 grams. The itemized cost elements and total cost, without overhead charges, are displayed in the table.

Table 4-1. Cost structure for applying rapid prototyping

COST ELEMENT	CHARGE	TOTAL
2D to 3D Conversion	\$ 40 x 10	\$ 400
Data Preparation	\$ 70 x 2	\$ 140
Material Cost	\$150 x 0.1	\$ 15
Building Hours	\$130 x 10	\$1,300
Surcharge Fee	\$150	\$ 150
	TOTAL	\$ 2,005

4.3 DISCUSSION OF RESULTS

The ultimate objective for product development is to create products of superior quality quickly and at competitive prices. Global competition dictates that companies are getting products to market faster by reformulating business strategies. Rapid prototyping, as a tool in product development, is playing a unique role in speeding up product design. Additionally, the use of rapid prototyping assists in identifying unforeseen problems early in the design stage. Based on cost estimates and analysis, the relatively high cost associated with rapid prototyping applications is mainly a result of:

4.3.1 High Initial Investment of Rapid Prototyping Equipment

The 1995 market price of a 3D Systems Stereolithography Apparatus 250 was \$200,000 per unit. The rapid prototyping industry is quite young with a history of approximately one decade. The accumulated expenditure made by

industry in research and development has been high. Although the market growth rate of rapid prototyping is one of the highest amongst promising technologies, the industry wealth has not accumulated enough to offer lower equipment prices. However, a significant price drop is anticipated as the rapid prototyping equipment industry is making tremendous progress and introducing new and innovative technologies with significantly lower prices.

4.3.2 High Reliance on Technical Support Provided by Engineering Service Bureaus

Based on a survey conducted in 1996, in the United States, alone, there are 126 engineering service bureaus providing rapid prototyping services [Wohlers, 1996]. Since most companies are only in the process of transition to 3D solid modeling, many drawings are still made in the 2D format. When these companies want to use rapid prototyping, they must often seek technical support from service bureaus to convert their drawings.

An investment of \$200,000 for a five-year return comes with an annual payment of \$52,759 at an interest rate of 10%. Annual maintenance fee is in the order of \$15,000 and laser replacement comes to \$10,000 approximately every 2000 hours. These three elements constitute the majority of operational expense aside from labor costs. An actual hourly rate for part building on a stereolithography apparatus, based on these estimates, ranges between \$38 to \$70 per hour depending on the life of the laser. This number is significantly lower than what most engineering service bureaus charge. These inflated prices reflect upon companies and their attempts to keep low costs for product development.

However, service charges are expected to drop as competition amongst service providers increases.

4.3.3 Economic Potential of Applying Rapid Prototyping

Product innovation is a fundamental element for companies to maintain a competitive edge. Additionally, it is crucial for companies to develop new products quickly enough to keep up with a turbulent and shifting market. With the introduction of rapid prototyping, bringing products to market faster is now a reality. Benefits of a short development cycle are evident for extending products' sales life, strengthening of customer loyalty, and gaining extra revenue and profit. The faster a product is brought to market with better quality, the greater the payoff is. Due to these compelling economic potentials of shortening product development cycles, it is anticipated that companies will gradually and gladly create a culture of rapid prototyping to guide product design.

Chapter 5

Case Study: Medical Applications

5.1 INTRODUCTION TO MEDICAL APPLICATIONS

Applications of an integrated rapid prototyping and vacuum casting process are not limited only to the manufacturing sector. Aside from product design and development, the versatility of the integrated process allows it to be applied to many other arenas. One such domain where this system would be very beneficial is the medical community.

As computer technology advances, computer aided surgery has greatly evolved and is becoming an important part of medical practices. Computer aided surgery is a technique which utilizes the high power of computers and advanced image processing to assist physicians and surgeons in many different applications. One critical area of computer aided surgery is creating solid models from two dimensional image data by converting data from computer tomography (CT) scans or magnetic resonance image (MRI) data into three-dimensional solid models. The models are usually of a patient's bone, ligament, brain, etc. The computer generated solid model is used to create an .stl file for stereolithography purposes. After build files are generated, the model is reconstructed using a rapid prototyping technology. Medical prototypes play significant roles as they are used for surgery preparation, consultation, visualization, and creation of implants. One of the most significant roles the prototypes play is the reduction of risk and cost for both the

patient and physician. Although it is a relatively new practice, case studies and applications prove the potentials and importance of this phenomenon.

5.2 CASE STUDY BACKGROUND INFORMATION

In conjunction with the National Institutes of Health (NIH), a project involving preparation for exploratory surgery was initiated. Researchers at NIH have been studying the possibilities of restoring sight in blind individuals by implanting electrodes in the visual cortex. To determine the possibilities of success on human subjects, the procedure will first be conducted on a monkey. More than 200 electrodes will be implanted in an area of one square inch in the visual cortex of the monkey. This is a very difficult and high risk procedure if the skull and brain are left exposed for an extended period of time, inviting possible infections. Thus, the surgeon and researchers are faced with the challenge of knowing exactly where to implant the electrodes prior to actually entering the operating room.

To facilitate the challenge, the researchers took a series of CT scans of the monkey's skull and brain to help map out the procedure. Still limited by two dimensional representation, the possibility of constructing a three-dimensional solid model was explored.

5.3 SOFTWARE OVERVIEW

In order to reconstruct the solid model of the monkey's skull, various software packages are employed. Figure 5-1 illustrates an overview of the CT-Modeller software system used for producing rapid prototypes from medical data:

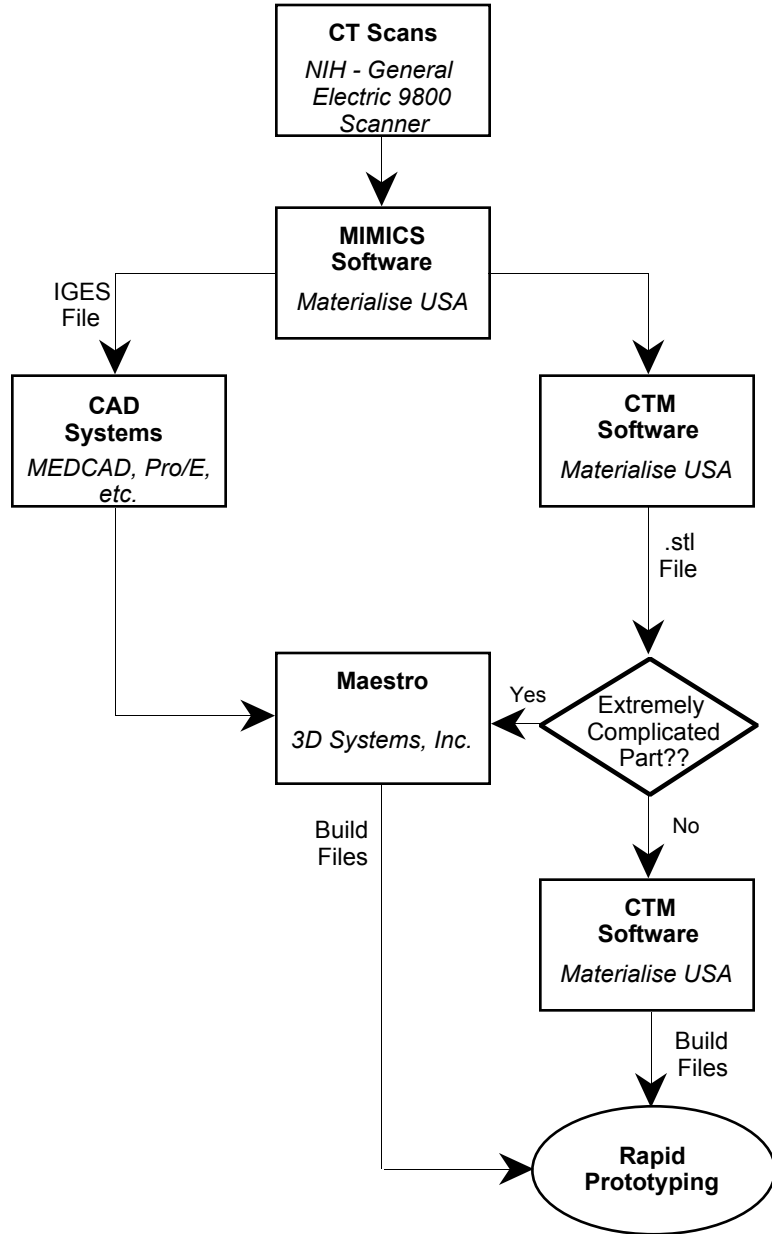

Figure 5-1. Software overview.

After the data is collected by a CT scanner, MIMICS software is used to process the two-dimensional data and define the regions which will be used from the CT scans. From MIMICS, the resulting data may be either exported, as an IGES file,

to a CAD interface program or to CTM. In this research work, the data is sent to CTM which interpolates the data and constructs the solid model. CTM is based upon higher order interpolation algorithms which allows the creation of extremely accurate models. After an .stl file is created in CTM, there are two choices for preparing rapid prototyping build files. CTM is equipped to interface with all rapid prototyping technologies, including 3D System's stereolithography. However, in this research work, the .stl file is imported into Maestro. Maestro is chosen primarily because of better visualization tools, the ability to custom create support structures, and the ease of assigning build parameters. All of the features are not as readily available in the CTM software. After build files are generated, a stereolithography model is created. The following describes the process by which the monkey's skull is reconstructed.

5.3.1 MIMICS

Materialise's Interactive Medical Image Control System (MIMICS) is a software tool developed by Materialise, Inc. for the visualization and segmentation of CT scans and MRI images. Additionally, MIMICS creates three-dimensional renderings of medical images and allows the user to essentially "correct" the segmentation of medical image data. The software is able to process any number of two-dimensional scans and, in turn, extract volumetric information from them.

Each different brand of CT scanners has a different format for recording data. A GE 9600 CT scanner was used at NIH to acquire the CT scans of the monkey. In order to use MIMICS, once the CT scans of the monkey's skull were taken, each of the thirty-two scans needed to be converted into the Materialise

image format. Specifically, thirty-two scans were taken because this number of scans covered the region the surgeons were interested in - from the top of the skull to the base of the nose. This image format, created by Materialise, is universal so that MIMICS may use data from all different brands of CT scanners. Each of the scans is given a header, such as the one shown in figure 5-2, which provides information from the scanning procedure and about the patient. MIMICS is a more powerful tool than other similar software created to convert CT or MRI data, because other packages usually focus on very limited scanners and are not as versatile as MIMICS.

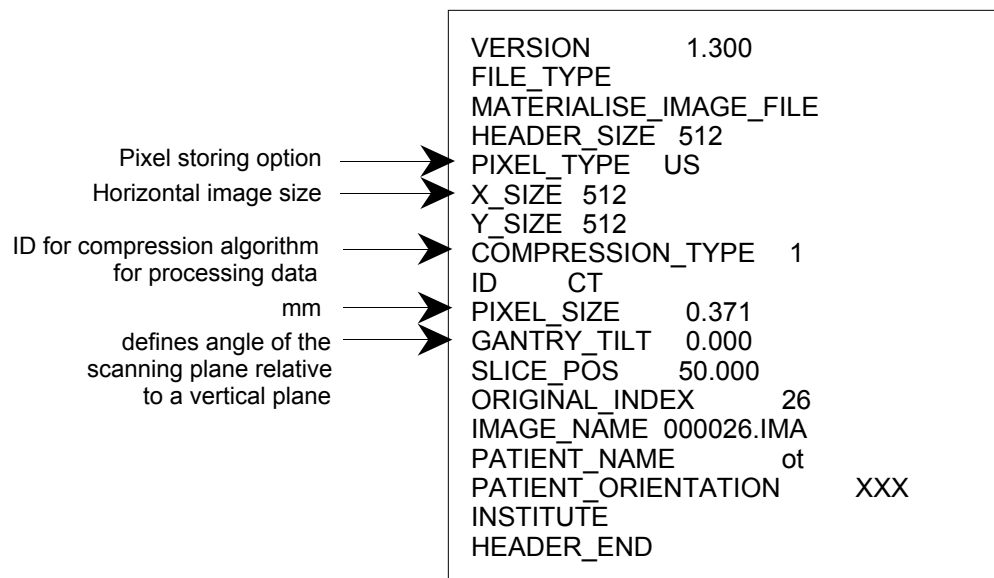

Figure 5-2. Example of CT-Modeller header for CT scans.

After converting, the thirty-two scans of the monkey's skull were loaded into MIMICS. The first step requires "segmenting" the images and creating 3D objects. To accomplish this task, first of all, the contrast of images must be

adjusted. Contrast adjustment will change and help decipher between bones and soft tissue. MIMICS allows the user to change and choose the contrast of the images to appear on the screen. An inappropriate choice of contrast would result in difficulties in deciphering of soft tissue and boney material. This in turn, would create problems in either losing necessary information or keeping more information from the scan than required.

Next, thresholding is completed. Thresholding involves adjustments so that the object to be 'segmented' contains only pixels of the image with a value equal or higher than the chosen threshold value. For example, if soft tissue is the area of interest in a scan, a threshold value of about 800 is chosen. However, for dense parts, such as bones, a high threshold is required. Choosing the correct threshold is also dependent upon the details desired in a model. With the monkey scans, the threshold value was set at approximately 1200, so that much of the soft tissue was eliminated tissue and the focus was on the boney material. If a threshold value which was too high was chosen, only dense, boney material would be chosen, while a low threshold value would keep all soft tissue and boney material of the scans. Thus, with adjustments to the threshold, a segmentation of the monkey skull was formed.

Once the contrasting and thresholding were finished, the next stage was region growing. Region growing allows the segmentation created by thresholding to be split within the scans. In the case of the monkey skull, the segmentation was not split since the skull was needed in its entirety. After region growing, the scans were now ready to be 'assembled' into a three dimensional representation. The software calculated the three-dimensional representation and created the solid

model. MIMICS allows the user to view the reconstructed model in multiple views. Viewing the model allows the user to evaluate the model prior to exporting for rapid prototyping or CAD work. If the user is not satisfied by the model, the threshold may be changed to allow for more or less details, adjustments may be made to the segmentation to change the size of the model, etc. Figure 5-3 (a) shows the top left view of the monkey's skull which was created from the CT scans. The top right view is shown in figure 5-3 (b) and the front view is illustrated in figure 5-3 (c).

After evaluating the model in the 3D module, it was decided the monkey skull was reconstructed appropriately. Therefore, the model was now ready for .stl file generation.



(a) Top left view

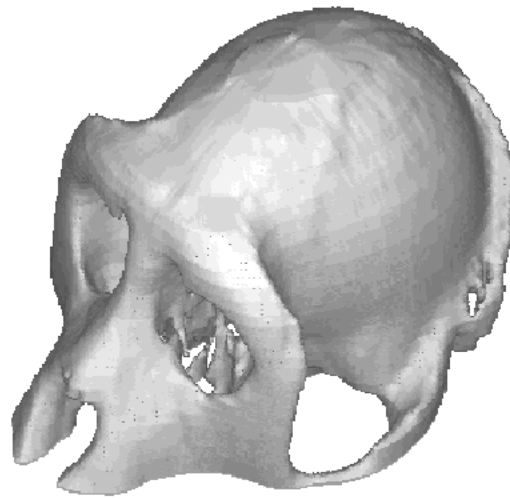

(b) Top right view



(c) Front view

Figure 5-3. Views of the three dimensional monkey skull.

5.3.2 CTM

To create a .stl file, the model of the skull was exported to CTM software, a commercial product also created by Materialise, Inc. This software package interfaces from MIMICS to any rapid prototyping system. CTM provides users with three different options for processing the MIMICS created file:

RP Model: CTM will generate files for different rapid prototyping systems. The files greatly resemble the build files and contain all vector information needed to run a rapid prototyping machine. CTM is capable of producing support structures and creating all build files for various rapid prototyping technologies. However, *Maestro* offers more options in terms of creating support structures and assignment of build parameters.

.stl Model: CTM has an .stl interface which creates the triangle mesh about a given volume. Two to six triangles are assigned to each surface pixel of the solid, resulting in a very high surface resolution. With this research work, only this interface was used for creation of an .stl file.

IGES Model: The third option is to generate IGES files. CTM allows the user to export files in the IGES format so that it may be imported in CAD systems. This is a popular choice for those users interested in custom made prosthesis where it is necessary to use the

patient's imaged body part to construct the prosthesis in a CAD packages.

In this research, the three-dimensional file created by MIMICS was then imported into CTM. The software scanned the file and read the extents of the model. These extents were then converted to z-height in the .stl file. After the scanning was completed, a parameter window was displayed similar to figure 5-4. The parameters may be changed if required. After the parameters were accepted, the .stl file was created.

Top of the skull	→	Position of the first slice	1.00
3 times the pixel size	→	Position of the last slice	32.00
2times the slice distance	→	XY Resolution	2.80
		Z Resolution	2
Calculation intestive	→	Gantry tilt angle	0.000
option to filter .stl file	→	STL filtering	NO
STL filtering parameters	→	Filter Tolerance	-
		Filter Max. Angle	-
		Filter buffer size	-
		Output filename	ot

Figure 5-4. CTM parameters for .stl file generation.

5.3.3 *Maestro* and Stereolithography Building Process

After creating the .stl file in CTM, it was imported into *Maestro*. After analyzing and fixing the file, the orientation was chosen for building. To avoid trapped volumes and to gain the best finishing on the outer portion of the skull, an upright position was chosen for building. The x, y, and z extents of the skull are shown in table 5-1:

Table 5-1. Extents of the monkey skull in mm.

x	0.00	103.5914
y	0.00	129.3013
z	0.00	58.1178

The medical prototype took 23.9 hours to complete building. Following, the support structures were removed and residual resin was rinsed off prior to post curing. The final prototype weighed 200.8 grams. Figure 5-5 shows the finished stereolithography model of the monkey skull.



Figure 5-5. Stereolithography model of monkey skull.

5.4 EVALUATION OF RAPID PROTOTYPED MODEL

The rapid prototyped model of the monkey skull was evaluated based on different parameters. The researchers and surgeons were primarily interested in the

top portion of the skull and not as much in the facial area. The first area of evaluation was based on visualization. Aesthetically, the model was exceptionally well detailed and very accurately resembled an actual skull. Additionally, the model was very accurate in dimensional and geometrical features. Thus, the model was ideal for the surgeon to practice the surgery and implanting of the electrodes.

The part was then evaluated based on cost. According to the cost estimating tools presented in Chapter 4, this particular part, if built by a service bureau, could cost as much as \$3,437. Details of this cost are provided in table 5-2:

Table 5-2. Cost structure for applying rapid prototyping to the skull.

COST ELEMENT	CHARGE	TOTAL
2D to 3D Conversion	\$ 40 x 2	\$ 80
Data Preparation	\$ 70 x 1	\$ 70
Material Cost	\$150 x 0.200	\$ 30
Building Hours	\$130 x 23.9	\$3,107
Surcharge Fee	\$150	\$ 150

TOTAL \$ 3,437

However, also explained in Chapter 4 is that this rate is very inflated and thus, a more reasonable and practical hourly rate for part building would be approximately \$50 per hour. Thus, based on this rate, the monkey skull should cost approximately \$1,525. The "true" cost is less than one half of an inflated service bureau price.

The rapid prototyped model was also evaluated on its uses. To begin with, the surgeons used the model to identify the visual cortex in three-dimensional representation, helping them determine areas of incision. The prototype is also used to practice implanting the multitude of electrodes in the cortex. However, prior to implanting the electrodes, that area of the skull must be smoothed and flattened with surgical facing tools, which takes some practice. There are different approaches which the surgeons could take on accomplishing this task and needed to determine the best one. Thus, the researchers and surgeons realized the critical need for multiple models of the skull for the various purposes. Unfortunately, the cost for producing multiple stereolithography parts was well beyond a reasonable budget. Therefore, alternative methods, i.e., vacuum casting, were explored for further replications.

5.5 MULTIPLE REPLICATIONS

The model of the current monkey skull would be difficult to vacuum cast due to the extensive detail and matter on the bottom of the model. Detail on the skull would create undercuts and would pose problems in making the silicone mold and casting parts. Figure 5-6 shows this detail captured by the stereolithography prototype. This detail is irrelevant and not of interest to the work conducted by the surgeons. Thus, it was decided to edit the skull and eliminate the bottom portion, essentially making the skull hollow to ease the vacuum casting process. In the first model, the skull was built from the top of the skull down to the nostrils of the monkey. The proposed second model would stop at the bottom of the monkey's eye sockets, eliminating excess detail. Additionally, the second model would take less time to build and require less material, thus, reducing the cost.

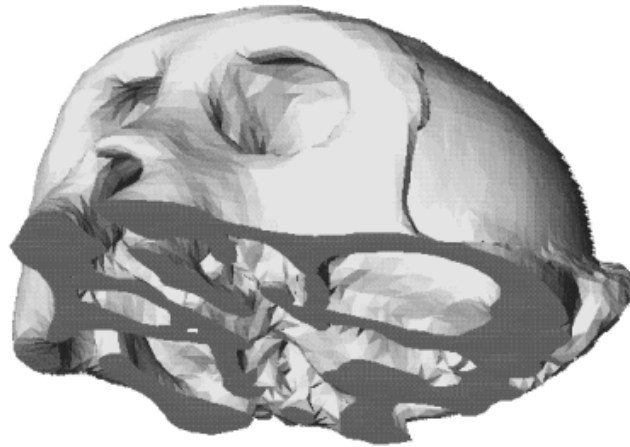
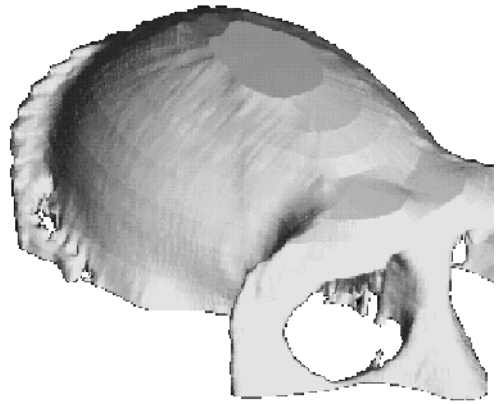

Figure 5-6. Bottom of the skull depicting excess detail.

5.5.1 MIMICS and CTM

The CT scans were once again imported in MIMICS. The contrast and threshold were not adjusted in order to maintain the same detail at each individual scan. However, during the region growing stage, the segmentation from thresholding was adjusted. During this second iteration, the entire skull created by the original thirty-two scans was not used, rather, a modified and shorter span of the skull was utilized. The first, or bottom, seven scans were not used and only the remaining twenty-five were employed to create the three-dimensional representation. Thus, there was a decrease in the z-height of the skull. MIMICS reconstructed the solid model which was then viewed for verification. Figure 5-7 (a) represents the top left view of the second skull, 5-7 (b) shows the top right view, and 5-7 (c) depicts the front view of the modified skull.



(a) Top left view

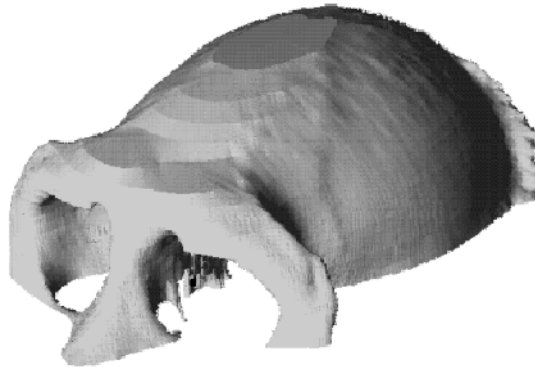

(b) Top right view

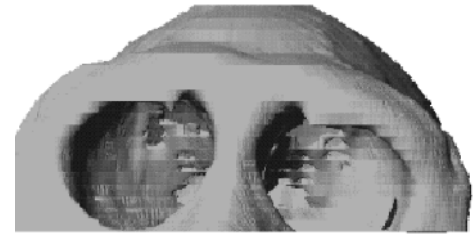

(c) Front view

Figure 5-7. Views of the three-dimensional modified monkey skull.

During the second iteration, additional attention was paid to the bottom of the model. Detail was simplified, therefore, creating a hollow skull. Figure 5-8 illustrates the lack of detail on the lower end of the modified monkey skull.



Figure 5-8. Bottom of the modified skull with simplified detail.

After a full evaluation of the modified skull, the new skull was approved and ready for .stl file generation. The file was exported to CTM, scanned by the software, and extents were converted to z-height. Similar to the first iteration, a parameter window appeared, however, with different values for slice positions as seen below in figure 5-9. Finally, an .stl file was generated from the three dimensional solid model.

NOTE: Position of the first slice has changed to layer # 8. →

Position of the first slice	8.00
Position of the last slice	32.00
XY Resolution	2.80
Z Resolution	2
Gantry tilt angle	0.000
STL filtering	NO
Filter Tolerance	-
Filter Max. Angle	-
Filter buffer size	-
Output filename	ot

Figure 5-9. CTM parameters for .stl file generation of the modified skull.

5.5.2 *Maestro* and Stereolithography Building Process

Similar to the first iteration, using *Maestro*, the .stl file was analyzed for any possible errors and fixed. To avoid trap volumes and to achieve the best finishing on the top of the skull, once again an upright orientation was chosen for building. The x, y, and z extents of the second skull are shown in table 5-3.

Table 5-3. Extents of the modified monkey skull in mm.

x	0.00	82.7067
y	0.00	114.5078
z	0.00	38.2212

It should be noted that the second skull was decreased by 19.897 mm in the z-direction. Additionally, there was a decrease of 20.8847 mm in the x-direction and 14.7935 mm in y-direction. This plays a significant role in build time and amount of material consumed.

A total of 11.4 hours were required to build the second monkey skull. After removing the supports and post processing the model, the final prototype weighed 65.2 grams. The finished modified skull is shown below in figure 5-10. Furthermore, figure 5-11 shows both models of the skulls together for comparison.



Figure 5-10. Stereolithography model of the modified monkey skull.

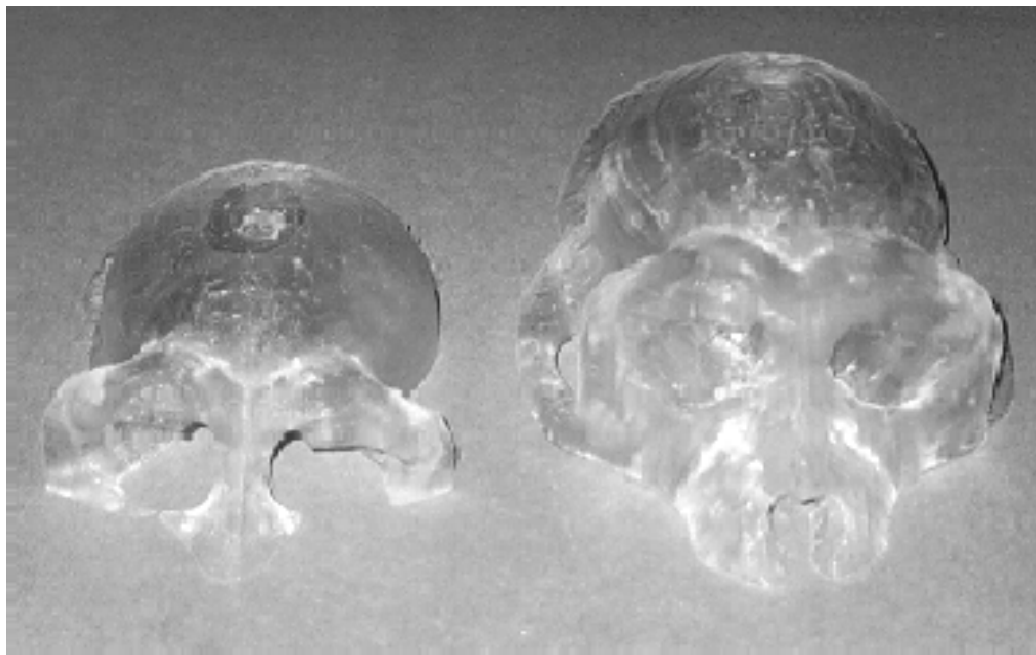

Figure 5-11. Stereolithography models of both skulls.

5.6 EVALUATION OF THE MODIFIED RAPID PROTOTYPED MODEL

Once again, the prototype was evaluated for visual and economical purposes. The second model captured the same detail and accuracy as the first skull. Due to the decrease in build time and weight of the final part, the second model cost significantly less than the first as shown in table 5-4.

An engineering service bureau could charge as much as \$1,980 based on the cost structures presented in Chapter 4. The more practical rate of \$50 per hour would result in the part costing \$840.

Table 5-4. Cost structure for applying rapid prototyping to the modified skull.

COST ELEMENT	CHARGE	TOTAL
2D to 3D Conversion	\$ 40 x 1	\$ 40
Data Preparation	\$ 70 x 1	\$ 70
Material Cost	\$150 x 0.0652	\$ 9.78
Building Hours	\$130 x 11.4	\$1,710
Surcharge Fee	\$150	\$ 150
	TOTAL	\$ 1,980

5.7 VACUUM CASTING OF THE RAPID PROTOTYPED MODEL

The second model of the monkey skull was ideal for vacuum casting due to its limited undercuts and excessive detailing. To preserve the accuracy, no

additional finishing, such as sanding, was performed on the stereolithography model of the skull. To prepare the part for casting, all 'holes' and voids had to be filled with clay or blocked off with tape. This practice eliminates any difficulties which result when trying to remove the cured silicone mold which may become "trapped" in such voids.

Next, a parting line needed to be established on the model. This line determines where the finished mold will be separated. After deciding that the bottom of the skull was to be used for parting, clear tape was applied along the bottom. A marker pen was used to color the tape to assist in cutting the mold after curing.

After establishing a parting line, the next stage involved gating. The number of gates used in a mold is dependent upon the size, weight, and shape of the part. It is preferable to place gates towards the rear of the model and at the lowest location in the model. The gate was formed by gluing a Delrin™ rod to the model. Gates range from 10 to 20 mm in diameter. Along with gating, venting is also very important. Vents are used to prevent imperfections from being formed when casting parts since the resins tend to release gases. Vents are placed where gas bubbles are most likely to accumulate - usually at higher points in the model. Vents are created by gluing 1.5 - 2.5 mm brass rods to the model. Three vents were created on the model of the skull. Vents are usually attached after the part is suspended in the casting frame.

The casting frame is constructed from ABS or laminated chip board. The size of the frame is relatively arbitrary. In the case of the monkey skull, the

dimensions were approximately 140mm x 175mm x 120mm. Three sides of the frame were erected and the model was suspended in the frame by attaching the gate to two supporting slots on top of the frame. Next, vents were glued to the model and the frame. Figure 5-12 illustrates the suspended model, gate, and vents. Once the gate and vents were properly placed, the remaining wall of the frame was attached and the casting frame was completed.

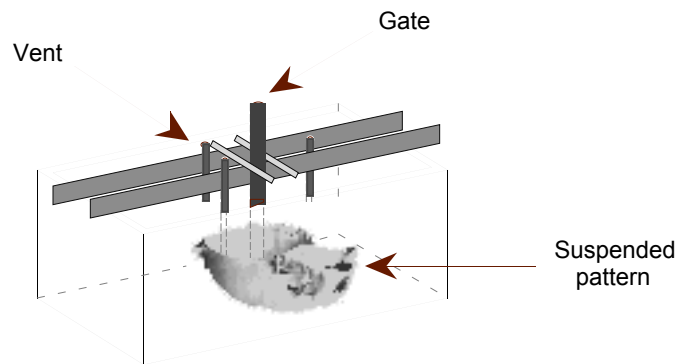

Figure 5-12. Suspended skull with gate and vents.

After completion of the casting frame, silicone rubber and a catalyst were mixed in preparation for creating the mold. The amount of silicone to be used was determined by multiplying the volume of the mold by 1.1, the specific gravity of the silicone. The required amount of catalyst is 10% by weight of the silicone. The two materials were poured into a bucket and mixed thoroughly. After mixing, the container was placed inside the vacuum chamber of the MCP Systems equipment

and the vacuum was started. This was the "primary de-gassing" stage which was completed in approximately 10 minutes.

The resulting de-gassed silicone mixture was then removed from the chamber and poured into the casting frame. To avoid disturbances, the liquid was initially poured under the model very slowly and steadily. During this stage, it is important to maintain the steadiness and to avoid sudden rushes of rubber in the mold to prevent bubbles and damage to the set-up of the suspended pattern. Figure 5-13 illustrates the pouring of the silicone into the casting frame with the modified monkey skull:

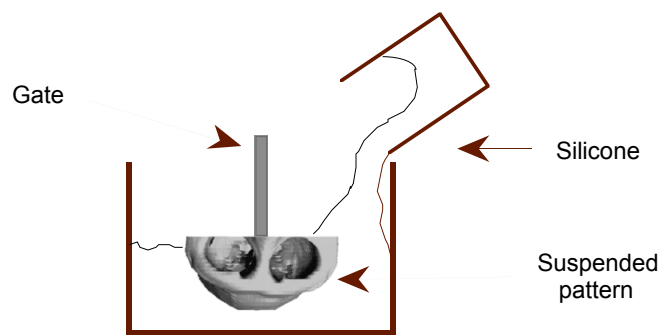

Figure 5-13. Casting the silicone rubber mold.

Next, the mold was placed in the vacuum chamber to carry out the secondary de-gassing process as shown in figure 5-14. Normally this process requires 10 minutes, but may take more for larger volumes of rubber. After de-gassing, the mold was cured in an oven set at 40° C. Molds may be cured at room temperature, however curing in an oven accelerates the process which is completed in 4-8 hours depending on the size of the mold.

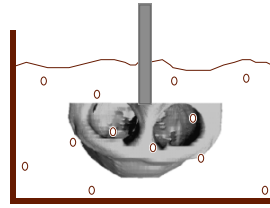

Figure 5-14. De-gassing of the silicone rubber mold.

When the curing process was completed, the mold was removed from the oven and the casting frame, gate, and vents were removed. Mold openers and scalpels were used to cut the mold into two halves and the complete mold was opened at the parting line. The finished mold halves are shown below in figure 5-15.

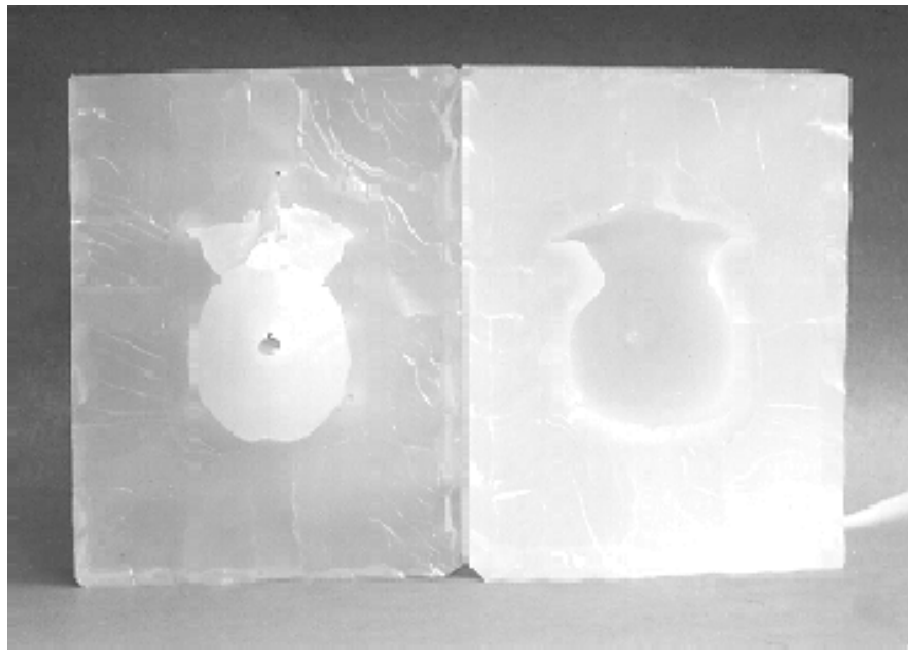

Figure 5-15. Finished silicone rubber mold.

In order to cast replicas, after the mold was separated, the mold was washed since the vacuum casting technique will exactly reproduce all imperfections and blemishes. After washing, mold halves were pre-heated in an oven. After heating, a mold release agent was sprayed on the halves and they were then taped together using an adhesive fabric tape.

The first parts were casted using a polyurethane (PU) material named SG200A. Material properties of various casting resins are found in Appendix A. The PU has a 0.2% shrinkage rate and a cure time of 20 minutes. This material is comprised of two separate components, resin A and resin B. Correct amounts of the resin components were determined based upon the weight of the master model and the specific gravity of the resin. Both components were weighed out and placed in cups. These cups were then inserted in their proper positions in the casting machine. In order to cast parts of different colors, pigments would be added at this stage.

The mold was placed in the vacuum chamber right before the casting was started. The funnel by which the resin would enter the mold, was attached by means of a flexible hose and connectors. After the mold and resins were in position, the upper and lower doors of the machine were locked.

The MCP Systems vacuum casting machine may be operated manually or by programming. With the vacuum on, resin A was poured into resin B automatically by the robotic arms in the casting machine. The two were mixed automatically by a mixing whisk, controlled by the machine and then poured down the funnel into the mold. The mixing and pouring were all done under vacuumed

conditions, thus, reducing chances of bubbles and other deformities created by released gases. Once the pouring was completed, the plastic hose and connectors were carefully removed and discarded.

The mold was then placed in an oven for 20 minutes. After curing, the tape was removed from the mold and compressed air was injected into the gates and vents to initiate separation of the mold. Mold openers were used to separate the mold halves once again and the casted skull was removed. The casting process was repeated and three replicas were made of the SG200A material. A casted part is shown below in figure 5-16.



Figure 5-16. Polyurethane SG200 replica of the monkey skull using vacuum casting.

Additional parts were casted using a more pliable and less rigid polyurethane, 2120. The shrinkage rate for the material is 0.3% and the cure time

is 45 minutes. The same procedures were followed to cast the part and figure 5-17 shows a replicated part.



Figure 5-17. Polyurethane 2120 replica of the monkey skull using vacuum casting.

The two types of castings were evaluated based upon their material characteristics and the needs of the surgeons. The first material produced a rigid, white casting while the second material resulted in a very pliable and yellow model. In this case, color was not of significant importance to the surgeons, however, the rigidity of the casts was of great concern. To practice the surgery and implanting, the surgeons required a replica resembling the actual skull in terms of hardness and texture. Thus, the first polyurethane castings were preferred due to the hardness. The surgeons will use the replicas to practice planing the skull and determining the best process and location to implant the electrodes. Based upon the evaluation from NIH, the second casting material properties would be ideal for casting objects such as a modeled brain of the monkey. Figure 5-18 illustrates both types of castings together.

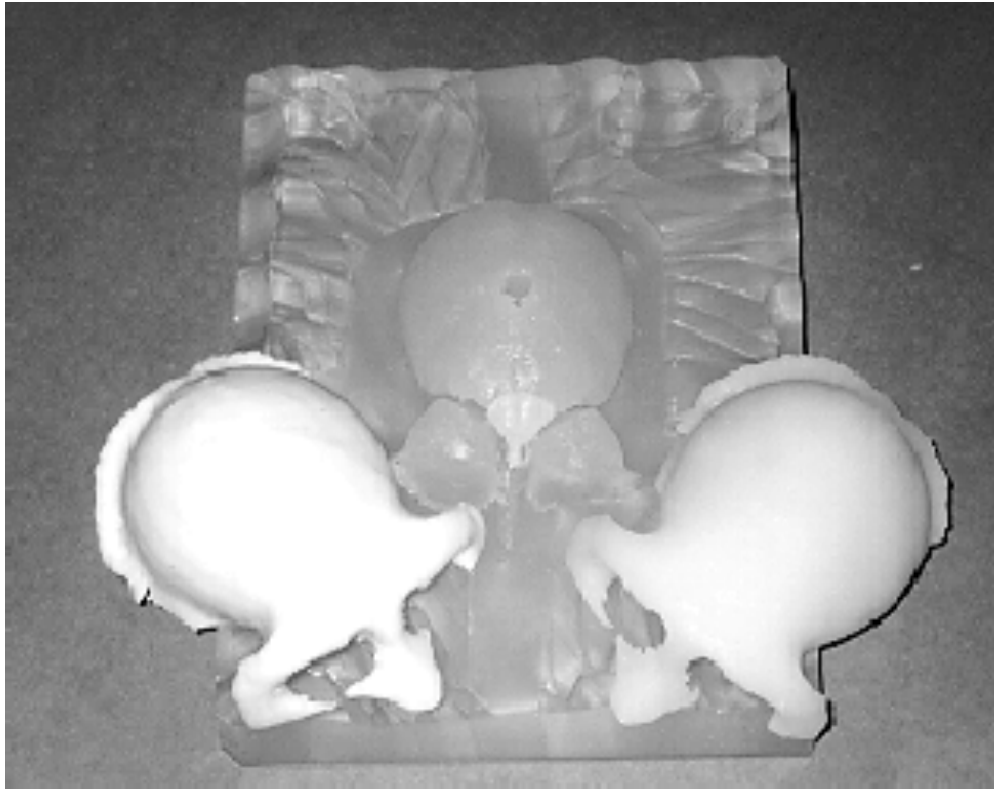

Figure 5-18. Silicone mold and polyurethane SG200 and 2120 replicas of the monkey skull using vacuum casting.

Chapter 6

Conclusions and Recommendations

6.1 CONCLUSIONS

The main objective of this thesis research has been to develop an integrated rapid prototyping and vacuum casting system to produce multiple functional prototypes. A system architecture combining computer software and hardware has been designed and demonstrated through a case study in the medical arena. Contributions of this work and significant findings from this study are summarized as follows:

1. A new method to produce multiple prototypes of a single part is proposed and developed in this research. By integrating rapid prototyping and vacuum casting, a batch of functional prototypes of a single part may be fabricated. Due to the versatility of vacuum casting, the integrated approach is unique as it creates opportunities to use materials with properties resembling those of the final products. Additionally, the use of an integrated process reduces the high costs often associated with using rapid prototyping alone.
2. The successful implementation of the integrated rapid prototyping and vacuum casting system demonstrates the importance of team work. This thesis work has resulted in a process which requires input and evaluation from different parties, thus, integrating knowledge from each. Through the

research, the input from medical experts forms a basis for development of an image-based 3D model. The input from production engineers working with vacuum casting technology facilitates the process of designing and preparing the casting mold. The author of this thesis functions as the decision maker to design the integrated system and as a system integrator to coordinate the collaborative research. As described in this thesis, physicians provide evaluation and feedback of material characteristics required in the medical prototypes. Based on these requirements, vacuum casting technologists provide their inputs to the system integrator on how to create functional prototypes of geometrically complex parts such as the skull with many undercuts and voids. Such a highly interactive feedback loop is crucial in the successful fabrication of a batch of functional prototypes.

3. Results obtained from this thesis work strongly demonstrate the importance of information technology in the development of new products. The developed system architecture characterizes the unique contribution of the presence of a virtual manufacturing environment. In order to create functional prototypes, CAD software is required to initiate the 3D solid modeling process. However, in the medical arena, it is the image data which plays a crucial role for physicians. Processing this image data for prototyping represents a new challenge which is well beyond problem-solving in a traditional mechanical engineering domain. Thus, as a pioneer effort, an image software system is incorporated in the process of designing the integrated system. The selected MIMICS and CTM software packages, developed by Materialise USA, have recorded an excellent performance in

the process of creating 3D solid models from 2D CT or MRI data. With 3D Systems' *Maestro*, incorporation of MIMICS and CTM represents a unique accomplishment in this thesis research.

4. A significant contribution of this thesis work is the product realization of monkey skull replicas. The replicas are extremely accurate in dimension and geometrical shape, and have mechanical properties which are close to the natural monkey skull. Due to the successful creation of replicas, surgeons are able to prepare for performing exploratory surgery to restore sight. Experience gained from pre-operative planning and procedural practicing of such non-routine procedures will play critical roles in surgical considerations, and could lead to minimization of risks and potential loss of life.

6.2 RECOMMENDATIONS

As in any research work, there are certain areas for continuous improvement and expansion. Several recommendations to improve the integrated system are listed as follows:

1. There is a great deal of work to be done in creating a master pattern which best fits the needs for mold fabrication. Complexity of geometry may not pose difficulties in the stereolithography process, however, these complex features are often perceived as undercuts and voids during the creation of the silicone mold. Thus, there is a need for creating master patterns which limit intricate features in order to fabricate a mold which will produce high

quality replicas. Additionally, master patterns with reduced complexity will limit the amount of preparation required of the pattern prior to casting.

2. Vacuum casting utilizes a variety of polyurethanes with different material properties. In this research, only two of the polyurethanes were used. Although key mechanical properties of these two materials meet the need in surgical consideration, additional choices could be better to simulate the natural bone material. Certainly, keeping the cost of material down is another major concern in this research. Thus, it is recommended that other materials be explored and evaluated based on feedback from users. In particular, in medical applications, physicians should provide more input regarding their needs and the types of characteristics they require.
3. Design of new facilities to automate the fabrication of molds used in vacuum casting represents a pressing need to expand its applications in industry. This also involves making standardizations of gating and venting procedures. An automated process with standard functions would make the vacuum casting technology more accepted and preferred in industrial applications.

APPENDIX

Properties of Vacuum Casting Resins

PRODUCT GRADE		SG200	2120
Natural Color		White	Yellow
Hardness	Shore A/D @25 C	80D	60A
	Shore A/D @ 60 C		65A
Tensile	kg/cm sq	650	50
	lb/sq in		711
Bend Strength	kg/cm sq	950	
Izod Impact	kg/cm sq	16	
	ft/lb sq		
Elongation	%		270
Tear Strength	kg/cm sq		30
	lb/sq in		215
Tensile Modulus	25C kg/cm sq		12
	77F lb/sq in		170
Deflection under load	18.5 kg/cm sq	90C	
Shrinkage	in/in	0.002	0.003
Cure time	@65C	20 min.	45 min.

** Data obtained from MCP Systems

REFERENCES

- Askeland, D.R., *The Science and Engineering of Materials*, Second Edition, PWS-KENT Publishing Company, Massachusetts, 1989.
- Bushong, S.C., *Radiologic Science for Technologists: Physics, Biology, and Protection*, Mosby-Year Book, Inc., Missouri, 1993.
- Chang, T-C., Wysk, R., and Wang, H-P., *Computer-Aided Manufacturing*, Prentice-Hall, Inc., New Jersey, 1991.
- Davey, D. "Overview of Vacuum Cast Molding from Stereolithography Parts," Proceedings of Rapid Prototyping and Manufacturing '96 Conference, Michigan, 1996.
- Gates, J.H., "Report on Rapid Prototyping Industry: August 1996", Proceedings of A New Dimension in the Technological Revolution - Rapid Prototyping Conference, Maryland, October, 1996.
- Halliday, T.A., "Combining Technologies for Fast Prototypes", *Computer Aided Engineering*, Penton Publishing, Inc., Ohio, 1996.
- Jacobs, P., *Rapid Prototyping and Manufacturing: Fundamentals of StereoLithography*, Society of Manufacturing Engineers, Michigan, 1992.
- Jacobs, P., *Stereolithography and other RP&M Technologies*, ASME Press, Michigan, New York, 1996.
- Jacobs, P., "Recent Advances in Rapid Tooling From Stereolithography," Proceedings of A New Dimension in the Technological Revolution - Rapid Prototyping Conference, Maryland, October, 1996.
- Kalpakjian, S., *Manufacturing Engineering and Technology: Second Edition*, Addison-Wesley Publishing Company, 1992.
- Lehner, K.D., Essig, R., and Bauer, C., "Time is Money", *Christophorus Porsche Magazin*, HEK GmbH, Germany, 1996
- Maestro: Workstation User Guide for Software Release 1.7, 3D Systems, Inc., California, 1995.
- Rush, O., "Vacuum Cast Molding as a Tool for Team Based Product Development," Proceedings of A New Dimension in the Technological

Revolution - Rapid Prototyping Conference, Maryland, October, 1996.

Smith, J.B., St. Jean, P., and Duquette, M.L., "A Comparison of Rapid Prototype Techniques for Investment Casting Be-Al", Proceedings of Rapid Prototyping and Manufacturing '96 Conference, Michigan, 1996.

Stewart, R., *Cost Estimating*, Second Edition, John Wiley & Sons, Inc., 1991.

Tsou, Y.C., "System Design for Object Reconstruction Using Information-Based Manufacturing", Master Thesis, University of Maryland, 1997.

Vacuum Casting Technique: A Guide for New Users, MCP Equipment, Mining & Chemical Products, Ltd., England, 1995.

Wohlers, T., "Rapid Prototyping: Past, Present, Future," RP Directory, Connect Press, Ltd., 1996.

Wohlers, T., "State of the Industry: Rapid Prototyping 1995-96 Worldwide Report," Society of Manufacturing Engineers, 1996.

Zhang, G., Richardson, M., and Surana, R., "Cost Evaluation of Using Rapid Prototyping Technology," Proceedings of the International Conference on Agile Manufacturing, Louisiana, February, 1997.

Zhang, G., Richardson, M., and Surana, R., "Economic Evaluation of Rapid Prototyping in the Development of New Products," Proceedings of the Flexible Automation and Intelligent Manufacturing Conference, England, June, 1997.

Zhang, G., Richardson, M., and Surana, R., "Development of a Rapid Prototyping System for Tactile Graphics Production," Proceedings of the Flexible Automation and Intelligent Manufacturing Conference, Georgia, May, 1996.

Zhang, G., and Lu, S., "An Expert System Framework for Economic Evaluation of Machining Operation Planning," Journal of Operations Research Society, Vol. 41, No. 5, 1990.