

ABSTRACT

Title of Dissertation: A ROLE FOR THE SUPERIOR COLLICULUS
IN THE CONTROL OF SONAR VOCAL
PRODUCTION IN THE ECHOLOCATING
BAT, *EPTESICUS FUSCUS*.

Shiva Ranjan Sinha, Ph.D., 2005

Dissertation Directed By: Cynthia F. Moss
Department of Psychology

Microchiroptera have evolved a biological sonar system that enables aerial foraging in total darkness. These echolocating bat species emit sequences of ultrasonic vocalizations and use the returning echoes to create acoustic images of the environment. Bats orient their gaze in space by adjusting their sonar vocalizations, flight dynamics, and head aim in a coordinated manner when approaching targets. Insectivorous species of echolocating bats have been shown to actively modulate the features of sonar vocalizations with changing target distance. Therefore, variations in the time–frequency structure and temporal patterning of sonar calls produced by foraging bats reflect adaptive goal directed behaviors.

The bat's heavy reliance on sound production and processing is reflected in neural specializations of auditory and motor structures. The experiments described in this dissertation probe the midbrain superior colliculus (SC), a vertebrate sensorimotor nucleus mediating orienting behaviors, and they specifically explore

adaptations in the SC of the insectivorous bat, *Eptesicus fuscus*, for acoustic orienting. The anatomical experiments conducted demonstrate that the bat SC has projections to pre-vocal motor control regions in the brainstem: paralemniscal tegmentum area, cuneiform nucleus, and midbrain reticular formation. Further insights were gained by developing chronic neural recording techniques to study SC neuronal activity in actively echolocating bats. These are the first chronic recordings in unrestrained, freely behaving bats. The physiological experiments reveal two bouts of neural activity prior to each sonar vocalization, and suggest a relationship between the timing of pre-vocal activity and sonar call duration.

Based on the anatomical findings and the functional pre-motor activity identified here, along with previous electrical and chemical microstimulation studies in the bat midbrain, a conceptual model is proposed for the SC of bats that suggests its role in orienting acoustic gaze along the range axis. This role of the bat SC is similar to that proposed for primate and feline SC in controlling the visual depth of focus via vergence eye movements. The parallel between the visuomotor and echolocation systems for orienting gaze to objects at different distances suggests that the computations performed by the SC serve common functions across modalities and effort organs.

A ROLE FOR THE SUPERIOR COLLICULUS IN THE CONTROL OF SONAR
VOCAL PRODUCTION IN THE ECHOLOCATING BAT, *EPTESICUS FUSCUS*.

By

Shiva Ranjan Sinha

Dissertation submitted to the Faculty of the Graduate School of the
University of Maryland, College Park, in partial fulfillment
of the requirements for the degree of
Doctor of Philosophy
2005

Advisory Committee:
Professor Cynthia F. Moss, Chair
Assoc. Professor David Yager
Asst. Professor Timothy Horiuchi
Asst. Professor Jonathon Simon
Professor Richard Payne

© Copyright by
Shiva Ranjan Sinha
2005

Preface

In my graduate I have endeavored research to study neural mechanisms that underlie animal behaviors. To that end I have been strongly influenced by the neuroethological approach to studying the biology of behavior, and the manner by which many neuroethologists conduct their science. Animals live in a rapidly changing environment, and have many subtle and sophisticated behaviors that they employ to extract information from their surroundings. Hence, animals actively gather sensory information by dynamically adjusting their behaviors. I have learned to appreciate these behaviors that have been shaped by generations of evolution, since ultimately understanding how animals extract information is crucial in guiding neurophysiological research.

I have been introduced to and have studied a number of animal systems, but for my dissertation research I have focused on the echolocating bat, *Eptesicus fuscus*, a species commonly found throughout North America. Echolocating bats represent an excellent example of how organisms can use auditory information in conjunction with self-generated sounds to move within and interact with the world. This behavior as used by microchiropteran bats is amazing since it is a dynamic, intricate, orchestrated behavior that happens in the blink of an eye. Bats can acquire within a fraction of a second sufficient auditory information to detect and direct high-speed attacks in order intercept ephemeral targets – flying insects – dancing through the night sky. This dissertation is an effort to understand that beautiful and tantalizingly complex behavior, echolocation.

In this research I focus on only one aspect of the echolocation behavior, the production of sonar vocalizations. Indeed, it is even further specific, as the dissertation focuses on the role of one nucleus in sonar vocal production. I have made all due efforts to study the system in as natural a behavioral state as possible, for as the ever vigilant neuroethologist in me reminds, the behavior is most important, the behavior should guide the scientific question.

In the hands of some the ability to record neuronal activity from living, breathing, behaving animals has reached remarkable levels, and their success is built on the research of a large number of other researchers, technicians and engineers. However, I was reluctant to begin tackling this goal in the bat, since the task even today remains technically quite challenging. Nonetheless, I began down this road, and have made progress to the point now where we can record routinely from unrestrained, tethered, freely behaving bats. This has not previously been accomplished, so I hope it will prove useful to the neuroethology field at large. I also hope that the results of my research will contribute, however small, to the scientific knowledge at large.

Dedication

This work is dedicated to my beloved parents, Savithri and Dinesh P. Sinha, who have nurtured in me perseverance and the respect for knowledge. To my dearest friend, Jennifer J. Lentz, who has given me infinite support and advice while keeping me on course each step of my way through graduate school. And, to my sisters, Shanta and Devayani, who are a constant source of inspiration.

Acknowledgements

A doctoral degree, even though a result of the candidate's hard work and determination in search of knowledge is also a culmination of support, guidance, advice, and encouragement of many others. I am grateful to my many teachers, colleagues and friends. For her patience, and tremendous support, I am most grateful to Dr. Cynthia F. Moss. To Dr. Catherine Carr, I owe much. For her frequent counsel and watchful eye, I am indebted. To the other members of my Dissertation Committee, Drs. Yager, Horiuchi, and Simon, I am indebted as well, not in the least for their generosity in sharing their precious time and thoughts. A special note of thanks to Dr. Avis Cohen, she opened the world of neuroscience by sharing her enthusiasm.

To the many friends and colleagues I have been truly fortunate to have in my life and research career: Todd Roberts, Murat Aytekin, Jeffery Triplehorn, Marc Holderied, David Boothe, Nachum Ulanovsky, Edward Smith, Sandy Davis, Jade Zee, Christofer Edwards, Jessica Cardin, Melissa Coleman, Mark Masino, and the members of the Maryland Batlab, I am truly indebted. Last and by far not the least are the people whose careers in science have been of inspiration: Walter Heiligenberg, Donald Griffin, Ron Hoy, David A. Robinson, and Peter Marler.

My graduate research has been funded by two fellowships. The first was from the Center for Evolutionary Biology of Hearing (CEBH) Training Grant at the University of Maryland. The second was a National Research Service Award (NRSA) from the National Institutes of Mental Health (NIMH).

Table of Contents

| | |
|---|------|
| Preface..... | ii |
| Dedication..... | iv |
| Acknowledgements..... | v |
| Table of Contents..... | vi |
| List of Tables..... | viii |
| List of Figures..... | ix |
| List of Abbreviations..... | x |
| Chapter 1: Introduction..... | 1 |
| Active Sensing..... | 2 |
| Gaze..... | 2 |
| Sampling the World..... | 4 |
| A Means to an End: Primate Eyes and Rodent Whiskers..... | 7 |
| Echolocating Bats..... | 16 |
| Sound Localization..... | 18 |
| Sonar Repertoire..... | 19 |
| Sonar Beam Pattern..... | 22 |
| Neural Control of Sonar Vocal Production..... | 24 |
| The Superior Colliculus..... | 33 |
| The Superior Colliculus in Mammals..... | 36 |
| The Superior Colliculus in Echolocating Bats..... | 45 |
| Proposed Experiments..... | 54 |
| Chapter 2: Vocal Pre–Motor Activity in the Superior Colliculus of the Echolocating Bat, <i>Eptesicus fuscus</i> | 57 |
| Introduction..... | 57 |
| Methods..... | 63 |
| Results..... | 79 |
| Sonar Vocal Behavior..... | 79 |
| Pre–motor activity in the Superior Colliculus..... | 84 |
| Oscillating Target..... | 90 |
| Controls..... | 99 |
| Discussion..... | 103 |
| Superior Colliculus Activity Related to Sonar Vocalizations..... | 104 |
| Controls..... | 105 |
| Sonar Call Duration and PI..... | 107 |
| Latency of Vocal Pre–motor Activity..... | 108 |
| Patterns of Neural Activity in Different Behaviors..... | 108 |
| Superior Colliculus Connections for Sonar Vocal Control..... | 109 |
| Role of Collicular Vocal Pre–motor Activity..... | 112 |
| Chapter 3: Anatomical Connections of the Superior Colliculus for Sonar Vocal Control in the Echolocating Bat, <i>Eptesicus fuscus</i> | 117 |
| Introduction..... | 117 |
| Methods..... | 121 |
| Results..... | 124 |

| | |
|--|-----|
| Discussion..... | 135 |
| An Integrative Role in Vocal Production..... | 138 |
| Control of Orienting Behaviors | 142 |
| Chapter 4: Conclusion..... | 146 |
| Gaze in Bats | 146 |
| Acoustic Gaze Along the Range Axis | 147 |
| Summary | 151 |
| Appendices..... | 154 |
| Bibliography | 162 |

List of Tables

| | | |
|---------|--|----|
| Table 1 | Occurrence of neural events prior to sonar calls for Echo Playback and Oscillating Target Paradigms..... | 89 |
|---------|--|----|

List of Figures

| | | |
|-----------|---|-----|
| Figure 1 | Ulric Neisser's 'perceptual cycle'. | 6 |
| Figure 2 | Schematic of the macaque brain showing major brain regions involved in both smooth pursuit and saccadic eye movement control. | 9 |
| Figure 3 | Drawings of the rat mystacial pad vibrissae from the side and the top. | 12 |
| Figure 4 | Diversity of sonar vocalizations from four different species of echolocating bats. | 21 |
| Figure 5 | The central acoustic tract is a paralemniscal pathway in mammals. | 32 |
| Figure 6 | Schematic drawings of the rat and cat brain highlighting the location of the midbrain superior colliculus. | 35 |
| Figure 7 | A drawing of the lamina of the cat superior colliculus made from a coronal, Nissl stained, cross-section. | 37 |
| Figure 8 | The discharge pattern of burst and buildup neurons during memory guided saccades. | 44 |
| Figure 9 | Sonar vocal behavior, neural circuitry, and experimental subjects. | 59 |
| Figure 10 | Experimental design for the flight room experiments and the two different behavioral paradigms used for chronic recordings. | 67 |
| Figure 11 | The temporal characteristics of sonar vocal sequences in different behavioral scenarios. | 80 |
| Figure 12 | Variation in sonar call durations with target distance and pulse interval in an oscillating target trial. | 83 |
| Figure 13 | Bat sonar call time waveform, power spectrogram, and time aligned pre-motor neural activity with sonar vocalizations in the SC. | 85 |
| Figure 14 | Sonar-related pre-motor activity is consistently observed in all recordings from the superior colliculus. | 87 |
| Figure 15 | Pre-motor neuronal activity in the SC during an oscillating target trial. | 91 |
| Figure 16 | Representative plots of sonar call duration versus mean LLE time. | 94 |
| Figure 17 | Linear regression analyses using the mean LLE time to predict sonar call duration. | 96 |
| Figure 18 | Short lead events are time-locked well to sonar vocal onsets. | 98 |
| Figure 19 | Control experiments conducted to verify relationship between SC pre-motor neural activity and sonar vocalizations. | 100 |
| Figure 20 | The superior colliculus is a multi-lamina, mesencephalic nucleus. | 125 |
| Figure 21 | Schematic drawing of the injection sites shown on a representative coronal section through the superior colliculus. | 126 |
| Figure 22 | Connections of the superior colliculus with brainstem nuclei. | 129 |
| Figure 23 | The paralemniscal tegmentum area receives dense innervation from the superior colliculus. | 132 |
| Figure 24 | Projections to the SC from basal ganglia, thalamus, and cortex. | 134 |
| Figure 25 | Schematic drawing of the connections identified after tracer injection into the superior colliculus of <i>Eptesicus fuscus</i> and vocal motor output pathways. | 137 |
| Figure 26 | Three potential models depicting the contribution of SC pre-motor commands to sonar vocal production. | 150 |

List of Abbreviations

| | |
|------|--|
| BIC | brachium of the IC |
| nBIC | nucleus of the brachium of the inferior colliculus |
| CUN | cuneiform nucleus |
| dMRF | dorsal mesencephalic reticular formation |
| DMN | deep mesencephalic reticular nucleus |
| DNLL | dorsal nucleus of the lateral lemniscus |
| DTD | dorsal tegmental decussation |
| IC | inferior colliculus |
| ICc | central nucleus of the inferior colliculus |
| ICX | external shell of the inferior colliculus |
| INLL | inferior nucleus of the lateral lemniscus |
| MGB | medial geniculate body |
| NA | nucleus ambiguus |
| NCAT | nucleus of the central acoustic tract |
| PAG | periaqueductal gray |
| PB | parabrachial nucleus |
| PLa | paralemniscal tegementum area |
| Pt | pretectal nucleus |
| Pp | peripeduncular nucleus |
| RA | nucleus retroambiguus |
| SC | superior colliculus |
| Sgp | suprageniculate nucleus |
| SNc | substantia nigra pars compacta |
| SNr | substantia nigra pars reticulata |
| VNLL | ventral nucleus of the lateral lemniscus |
| ZI | zona incerta |

*“When we try to pick out anything by itself,
we find it hitched to everything else in the universe.”*

– John Muir

Chapter 1: Introduction

This dissertation considers the hypothesis that neurophysiological processes co-vary with behaviors in a task dependent manner. The introduction first develops the idea that behavioral orienting of gaze is part of an ongoing cycle of perception. Next, in support of the hypothesis, two examples of co-variation between neuronal activity and orienting behaviors of behaving animals are presented; one in the visual system, the other in the somatosensory system. This is followed by a summary of current knowledge on the acoustic orienting behavior of the echolocating bat. This auditory specialist produces sonar vocalizations to explore its environment, and processes the acoustic information in reflected echoes to guide orienting behaviors. Historically, research on neural processing in this animal has focused on auditory processes in the primary ascending pathway nuclei and the cortex, while the animal passively listened to sounds. In contrast, this dissertation will focus on the superior colliculus (SC), which generates commands for gaze orienting movements, and examines its functional properties in actively vocalizing bats. The third part of this Introduction is devoted to introducing the SC, and its novel role in bats, acoustic orientation by sonar.

Active Sensing

Gaze

Organisms operate in a complex and continually changing world. Their continued survival depends on a steady assessment of biologically relevant information. The information that animals gather from the environment is derived from the compliment of sensory transduction organs that have evolved. For animals to successfully navigate and forage within their environment an important question concerns how sensory information is sampled.

The means of sampling is constrained by the morphology and function of a particular sensory organ. This point cannot be underestimated, because the design of a sensory organ will determine and shape how the sampling is ultimately achieved. Simultaneous acquisition of the entire physical range of a sensory modality, at each moment in time, is not observed among biological organisms. Generally, sensory organs sample a limited range of a space, and within this subspace they have regions of higher and lower sensitivity, along with varying spatial and temporal resolution.

Given the constraints on sensory sampling imposed by form and function, animals have developed behavioral strategies to adjust their gaze. Here, gaze refers to the locus in space (defined in terms of azimuth, elevation and range) from which the highest resolution sensory information is acquired. The gaze can be directed by: a) adjusting the orientation of a sensory apparatus, or b) orienting the body to acquire sensory information. The acquisition of sensory information by directing gaze is

accomplished using species-specific behaviors. For instance, head orienting movements facilitate sound localization in the auditory system, saccadic eye movements align the fovea for high-resolution analysis in the visual system, and haptic exploration mediates tactile discrimination in the somatosensory system.

This working definition of gaze can be considered spatial gaze and needs to be expanded to account for classes of animals that actively probe the environment by producing their own signals and by controlling the rate at which they sample information. Classes of animals that fall into this category are the echolocating bats, cetaceans, and weakly electric fish. All of these classes of animals produce a signal that is emitted into the environment, is modified by the environment, and returned back to the animal. Thus the animals can compare the outgoing and altered incoming signals to gather information about their environments. Therefore, there is another component that needs to be added to the definition of gaze: adjusting the time of emitting a signal and responding to returning signals with appropriate delays.

This last method of adjusting gaze is important for the animal model used in the experiments described here, the echolocating bat. Bats emit high intensity, broad bandwidth, variable duration sonar signals, and use the returning echoes to generate an image of their environment. Therefore, the time of return of echoes is as important as the direction from which echoes arrive. The importance of this additional dimension of gaze control will prove important for acoustic sampling when we relate

the sonar vocalizations bats produce with, a) the distance of targets during foraging, and b) the features of vocal pre-motor neuronal firing.

Sampling the World

Orienting gaze for the purpose of sampling sensory space is a process that changes dynamically and involves an active sensing process. Other scientists have already proposed this idea for visual information processing (Aloimonos et al., 1988; Findlay and Gilchrist, 2003) where the visual world is sampled by sequences of fixation-movement-fixation of the fovea of the human eye. This active process is part of an overall cycle of the kind described by the psychologist Ulric Neisser (Neisser, 1976). Neisser suggested a '*perceptual cycle*' in which exploratory behaviors serve to sample sensory space, and in turn the sensory sampling generates perceptions that are acted upon by cognitive factors, which then direct future behaviors. The cognitive factors themselves Neisser categorized into 'schemata'. He considered the schemata as a modifiable collection of knowledge relevant to the current behavior, which prepared the perceiver to accept some information rather than others, and thus control the evolution of the behavior. These cognitive factors come into play when considering important questions related to how sensory sampling is achieved: How is the decision made when to redirect gaze? How is it determined where to direct the gaze in order to take the next sample? What information is taken in during each sample? How is information from one sample integrated with that from previous and subsequent samples? Therefore, Neisser considered the construction of a mental image (representation), not as a static image for a

homunculus to examine, but rather that at each moment the perceiver is constructing expectations of certain kinds of information that enable the perceiver to accept and interpret that information when it becomes available. Thus schemata generate expectations that direct exploratory behavior, the exploratory behaviors result in information that modifies the original schemata, which then drives further exploration. This cycle has been referred to as the Neisser perceptual cycle (Neisser, 1976) (Figure 1).

What guides the evolution of the sampling process during active sensing? This challenging question is only partially addressed by observations of the animal's behavior, an understanding of the physical processes in signal transmission, and our knowledge of peripheral sensory signal transduction. This is because the cognitive factors in the perceptual cycle, i.e. the schemata, play an important role in the sampling process as well. The components are in part made up of the arousal state of the animal (e.g. anesthetized, sleep, awake, attentive), experiences (prior probabilities) that guide decision making in animals (e.g. memory of an environment, complexity of a behavioral task, coordination of motor plans), and the objectives of the animal (e.g. foraging, exploring, navigating). Experimentally if an animal's arousal state, experiences, and objectives can be constrained, and if the entire context within which an organism operates is appropriately designed and controlled, the evolution of the sampling process can be simplified. Developing an experimental design to completely constrain behavior is nontrivial, however, it should be kept in mind that the answers gathered are a function of internal states of the animal.

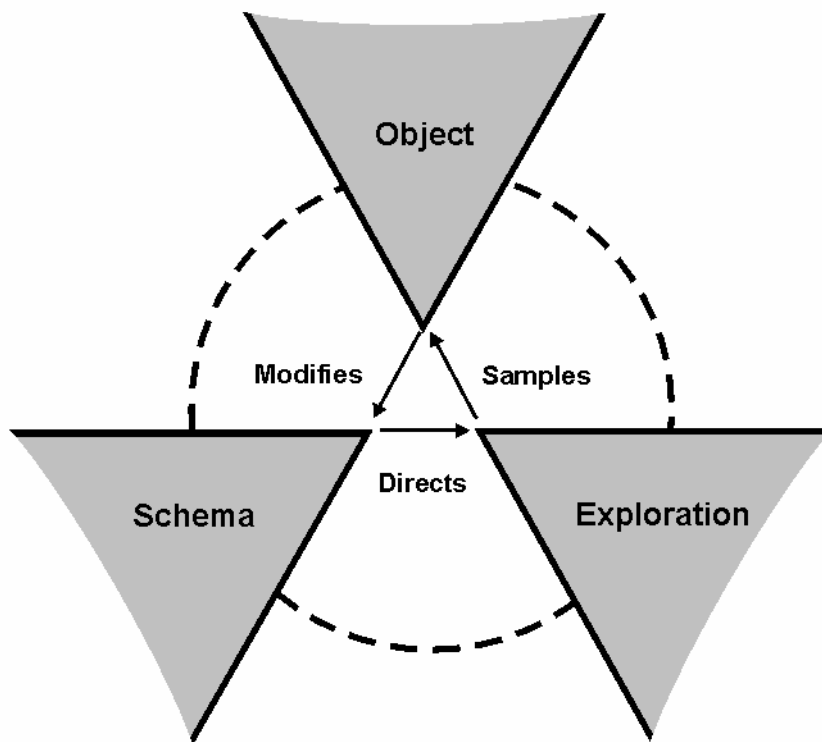

Figure 1 Ulric Neisser's 'perceptual cycle'.

Neisser considered that each at moment the perceiver is constructing anticipations of certain kinds of information, which enable the acceptance of the information when it becomes available. Interactions with the environment, therefore, occur continuously in a cyclical manner where sampling provides available information in the environment, which in turn serves to modify schema of the present environment, that then direction further exploration. (Adapted from "Cognition and Reality", Neisser, 1976).

During experiments, measurement of an animal's behavior is crucial since the effects of active sensing in freely moving animals can be observed behaviorally, when animals shift between behavioral strategies to complete tasks (Carvell and Simons, 1995; Hollins and Risner, 2000; Gamzu and Ahissar, 2001), as well as physiologically, as changes in neuronal firing patterns or receptive field properties (Ahissar et al., 1992; Ghazanfar and Nicolelis, 1999; Ahissar et al., 2000; Knierim and McNaughton, 2001; Krauzlis, 2003; Carello and Krauzlis, 2004). Thus, data from freely behaving animals suggests that when an animal shifts between classes of behaviors a corresponding change occurs in the firing pattern or mode of operation of neurons. In terms of sensory sampling and gaze, an organism's ability to actively redirect its gaze by employing different behaviors will impact the characteristics of sensory information acquired by its central nervous system. Importantly, the changing behavior co-occurs with, or is preceded by, dynamic changes in neuronal patterns of activity. To illustrate this point two examples – one involving eye movements in primates, the other whisker movements in rodents – are expanded upon below.

A Means to an End: Primate Eyes and Rodent Whiskers

Primate Eyes

Primates have developed complex eyes with a retinal region that contains a specialized central area, the fovea, with an especially high density of photoreceptors. To see things with high resolution the orientation of the eyes are continuously changed to align the fovea with objects of interest. Three classes of eye movements are employed by primates to reorient their eyes: saccades, smooth pursuit, and

vergence eye movements. The last class of eye movements is used to change the depth of focus, and has received comparatively little attention in terms of psychophysics and neurophysiology experiments, and will not be considered further in this section. Visual saccades are discrete eye movements that ‘ballistically’ change the orientation of the eyes and thereby translate the image of the object of interest from an eccentric retinal location to the fovea. Smooth pursuit is a continuous movement that slowly (relative to saccades) rotates the eyes to compensate for motion of the visual object, minimizing blur that would otherwise compromise visual acuity. Saccades are driven by a wide variety of signals, whereas smooth pursuit is primarily driven by visual motion (Rashbass, 1961). A network of circuits that involve the parietal (lateral intraparietal area, LIP) and frontal cortex (frontal and supplementary eye fields, FEF and SEF), the basal ganglia, the cerebellum, the midbrain superior colliculus (SC), and brainstem reticular formation mediate these two classes of eye movements (Figure 2).

The SC is an important midbrain site for generating coordinated eye–head gaze orienting movements. (The superior colliculus in bats and mammals in general is discussed at greater length in subsequent sections and chapters). In primates the intermediate and deep layers contain a motor map in which each site is thought to encode a specific gaze vector (for reviews, see Wurtz and Albano, 1980; Sparks, 1999). Three lines of evidence support SC involvement in generating a command for adjusting visual gaze.

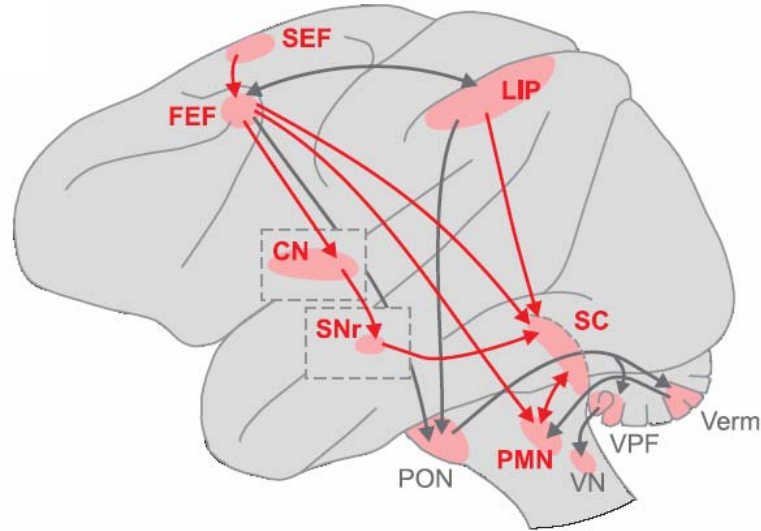

Figure 2 Schematic of the macaque brain showing major brain regions involved in both smooth pursuit and saccadic eye movement control.

Dashed lines demarcate regions that are beneath the cortex in macaques, and arrows indicate anatomical connections. CN caudate nucleus of the basal ganglia, FEF frontal eye field, LIP lateral intraparietal area, PMN brain stem premotor nuclei (PPRF, riMLF, cMRF), PON precerebellar pontine nuclei, PPRF paramedian pontine reticular formation, riMLF rostral interstitial nucleus of the medial longitudinal fasciculus, SC superior colliculus, SEF supplementary eye field, SNr substantia nigra pars reticulata, Verm vermis (cerebellum), VN vestibular nucleus, VPF ventral paraflocculus (cerebellum) (Modified from Krauzlis, 2004).

First, electrical stimulation evokes gaze shifts whose vectors are determined by the site of stimulation (Schiller and Stryker, 1972; Freedman et al., 1996). Second, tectoreticular neurons projecting to the pons discharge most vigorously for a specific gaze saccade vector (Munoz et al., 1991; Scudder et al., 1996a). Third, focal pharmacological inactivation of small zones in the map selectively impairs gaze shifts encoded by that area (Hikosaka and Wurtz, 1985a; Hikosaka and Wurtz, 1986).

Neurons in most parts of this motor map modulate their activity during the preparation and execution of saccades (Glimcher and Sparks, 1992; Munoz and Wurtz, 1995a). However, in the rostral SC (rSC), corresponding to the central visual field, many neurons modulate their firing rates during both smooth pursuit eye movements and small amplitude saccades. This activity is not simply a visual response because it persists in the absence of a visual target (Sparks et al., 1976; Sparks, 1978; Krauzlis, 2003). Moreover, activating the rSC with currents too weak to directly evoke eye movements nonetheless biases the metrics of both the pursuit and saccadic eye movements that are ultimately generated (Carello and Krauzlis, 2004). Thus the neurons in the rSC that are involved in the preparation of saccades also mediate the metrics of pursuit eye movements. In contrast, while changes in the tonic activity of rSC neurons directly gate the initiation of pursuit and saccades, the triggering of saccades also requires the recruitment of visual saccade-related burst neurons in the caudal SC. The neurons in the rSC exhibit selectivity for stimuli that will be the target of pursuit and saccadic eye movements, and this selectivity can predict the timing of pursuit and saccadic choices (Krauzlis and Dill,

2002). Together these results suggest one function of the rSC is to specify the eye movement goal, and to an extent the overall pattern of activity influences the strategy used to achieve the goal (Bergeron et al., 2003). Thus the SC in primates serves as a substrate for generating saccades and smooth pursuit, and the pattern of activity in this structure influences the selected goal and the eye movement that will be generated to achieve this goal.

Rodent Whiskers

A more elaborate understanding of how changing behaviors co-occur with different neuronal modes of activity is observed in a number of mammalian species, including rats, hamsters, walruses, and seals that have developed an elaborate, evolutionarily conserved spatial array of facial mystacial vibrissae. The direction, frequency, amplitude and duration of motion of these vibrissae can be voluntarily controlled. The most widely studied are the well-organized macrovibrissae, thought to function either as distance detectors (Brecht et al., 1997) or operate in a touch like manner comparable to primate fingertips to provide high-resolution information (Carvell and Simons, 1990). These animals also possess shorter and more numerous microvibrissae located more anterior to the macrovibrissae and close to the mouth (Wineski, 1985; Brecht et al., 1997) (Figure 3).

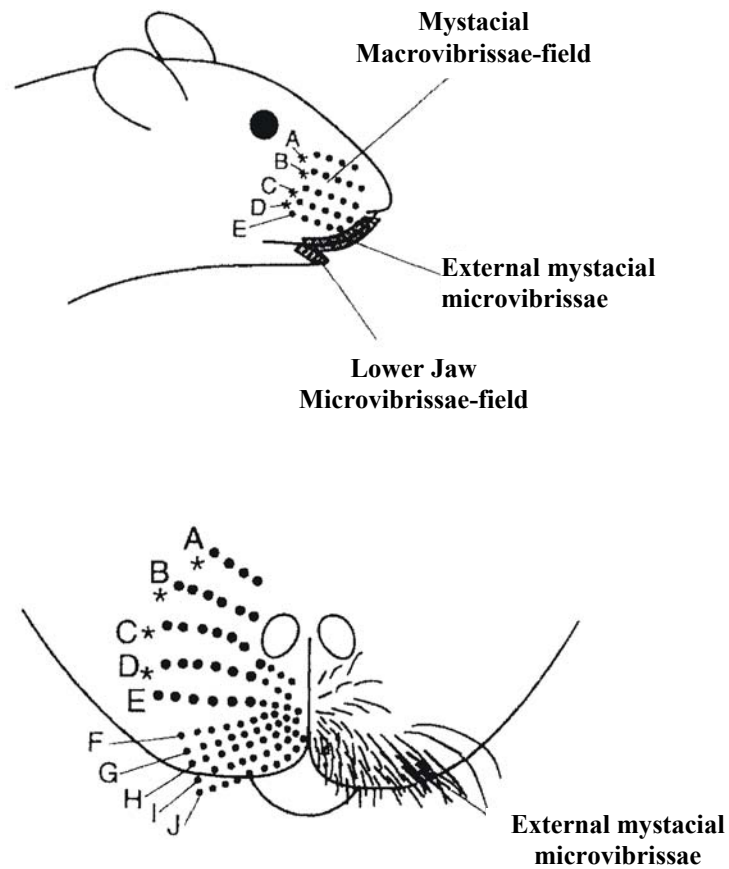

Figure 3 Drawings of the rat mystacial pad vibrissae from the side and the top.

The letters are the naming convention used in the field for the different rows of whiskers. The macrovibrissae are the most heavily investigated in studies, and are the whiskers discussed in the text (Modified from Brecht et al., 1997).

While the exact functions of the macrovibrissae are still debated, it is agreed that the whiskers permit sampling of somatosensory information from the environment. Multiple classes of whisker movements are behaviorally observed and experiments suggest that these animals actively choose the appropriate class of movements for acquiring essential tactile information. These whisker movements can broadly be classified into three groups: quiet immobility, whisker twitching, and whisking (Welker WI, 1964; Carvell and Simons, 1990; Nicolelis and Fanselow, 2002b).

The neurophysiological correlates to these classes of behavior have been most extensively studied in the highly developed rat vibrissal trigeminal somatosensory system. Experiments have shown that each type of whisker movements employed by the rat is suited to convey different classes of information (simple versus complex), permits different degrees of behavioral sensitivity to stimuli, and is best correlated with distinct modes of firing (bursting and tonic) in thalamic neurons projecting to the cortex. The main loop is made of projections from the trigeminal brainstem complex to neurons in the ventral posterior medial (VPM) nucleus of the thalamus. In the rat, VPM contains only one type of neuron (excitatory neurons) that project to layer IV of the primary somatosensory cortex (so called barrel cortex).

The pattern of activity of VPM neurons is related with the observed whisking behavior. For instance, when rats sit still and exhibit no movements of their facial whiskers (the quiet immobility state) thalamic VPM neurons are generally

depolarized and tend to fire tonically (McCormick and von Krosigk, 1992). During this quiet period VPM neurons respond to tactile stimuli with a stereotyped sequence of excitation and inhibition, rendering them incapable of responding to rapidly changing incoming sequences. However, this state allows VPM neurons to respond robustly to the presence of a single stimulus. Based on this finding it has been argued that when rats are in quiet immobility VPM neurons are in a stimulus detection state (Nicoletis and Fanselow, 2002b).

When rats are sitting still but exhibit rhythmic, small-amplitude, whisker-twitching movements (7–12 Hz), a second potentially more sensitive stimulus detection mode occurs. This behavioral state is accompanied by a highly synchronous 7–12 Hz oscillatory activity in the thalamo-cortical loop (Welker WI, 1964; Semba and Komisaruk, 1984). Experiments have demonstrated that shortly after onset of oscillatory activity in the VPM–SI oscillatory loop, rats begin whisker-twitching movements that are phase-locked to the neural oscillations. During this state VPM neurons exhibit periods when the probability of a response to a tactile stimulus is substantially enhanced (hypersensitive period), higher than during any other behavioral state (Fanselow et al., 2001). In addition, VPM and SI neurons fire bursts of action potentials substantially more frequently than during quiet immobility state (approximately x6 more likely) (Nicoletis and Fanselow, 2002a). The period of heightened sensitivity occurs after a burst of action potentials in VPM when the thalamic neurons are hyperpolarized and can produce Ca^{2+} spikes mediated by T-type Ca^{2+} channels (Gutierrez et al., 2001; Sherman, 2001). Remarkably, this period

coincides with the time when the rat's whiskers begin to move forward, and therefore when these neurons are capable of bursting. Thus, in this scheme the occurrence of each VPM burst 'resets' the activation state so that the period when neurons in VPM burst occurs during the retraction phase of whisker twitching movements, and the period when the VPM neurons are able to burst occurs during the protraction phase of whisker twitching.

The third behavioral whisker movement strategy, whisking, is characterized by large amplitude back and forth sweeps at a rate of 4–6 Hz permitting repeated contact between vibrissae and objects in the environment. This behavioral state too has a corresponding physiological state suited for acquisition of complex and rapidly presented stimuli. Essentially, whisker deflection results in a volley of information being sent to VPM neurons, as well as activation of cholinergic reticular formation (RF) neurons. Stimulation of cholinergic RF neurons is known to depolarize VPM neurons (Steriade and Deschenes, 1988) and it is known that activity in the RF is substantially increased during aroused states (Steriade et al., 1990). The increased level of excitation from brainstem trigeminal neurons to VPM neurons plus their more depolarized state results in a tonic mode of firing. This mode of firing facilitates the transmission of information provided by the complex sequences of multi-whisker deflections, as each whisker deflection results in a change in the tonic rate of VPM firing.

Thus the rat somatosensory system is a complex and dynamic system that is capable of shifting its physiological state to maximize the type of tactile information sampled by a particular active exploratory behavior. Therefore, it putatively can choose from multiple functional modes to actively examine and analyze tactile inputs based on expectations built throughout a lifetime of vibrissae movements.

Two specialized animal sensori–motor systems, one vision–based in primates and the other somatosensory–based in rats, have been briefly reviewed. In both systems, actively changing behavioral strategies occurred concomitantly with changes in neuronal processing that putatively aided in the processing of specific types of information. Therefore, different classes of eye movements involved with shifting the high–resolution fovea co–occur with different rates and temporal patterns of neural activity in the superior colliculus, and separate classes of rat whisker movements take place concurrently with changing sensitivity in somatosensory thalamocortical neurons that permits greater sensitivity during protraction. In the next section attention is focused on an auditory specialist, the echolocating bat, which has evolved an active biological sonar system for orienting in the world.

Echolocating Bats

Echolocating bats are in the suborder Microchiroptera and exhibit tremendous diversity, with bat species displaying behavioral, anatomical and physiological adaptations to a broad range of habitats, including desert and tropical rain forest ecosystems (Jones et al., 2002). The bats of this suborder have evolved a biological

sonar system that permits aerial foraging in complete darkness (Griffin, 1958). In addition to specializations in their auditory system, they have evolved a specialized larynx to produce ultrasonic vocalizations, with different bat species showing different degrees of specialization based on the structure of their sonar calls (Griffiths, 1983). The structure of their sonar vocalizations are closely linked to the ecological system they live and the acoustic conditions they encounter while foraging. Several schemes have been proposed to categorize bats according to their habitat and sonar signal characteristics (Aldridge and Rautenback, 1987; Neuweiler, 1990; Fenton MB, 1995; Schnitzler and Kalko, 2001; Schnitzler et al., 2003). When foraging, bats control the timing, duration, frequency content and intensity of sonar signals to probe the environment. Sound recordings, made in the field and laboratories, demonstrate that foraging bats actively adapt the temporal patterning and features of their sonar vocalizations based on the relative location of targets in space and the constraints of the space they forage in (Simmons et al., 1978; Wadsworth and Moss, 2000; Surlykke and Moss, 2000; Simmons et al., 2001; Moss and Surlykke, 2001; Schnitzler and Kalko, 2001). The spectro-temporal structure of bat sonar vocalizations provide certain benefits and trade-offs for detecting, tracking, localizing in azimuth and elevation, and determining the range of targets when foraging (Altes, 1976; Simmons and Stein, 1980). The information in the returning echoes is used to determine the location, range, size and other features of sonar targets (Moss and Schnitzler H-U, 1995). In turn, the acoustic information the bat processes guides subsequent adaptive motor behaviors, including adjustments of the head aim, flight path and dynamics, presumably pinna movements and the features of successive sonar vocalizations

(Griffin, 1958;Griffin et al., 1962;Pye and Roberts, 1970;Hartley et al., 1989;Ghose and Moss, 2003).

The following sections introduce in more detail aspects of bat echolocation including, sound localization, sonar vocal repertoire, sonar beam pattern, and sonar production mechanisms.

Sound Localization

For spatial orientation, bats exploit the same auditory cues used by other species to localize the direction of sound sources, i.e. interaural intensity differences (IID) and interaural temporal differences (ITD) (Simmons, 1979). ITD cues are not thought to be in echolocating bats based on the physical size of their heads and the wavelength of the sonar frequencies they emit. Binaural cues for sound localization are used to estimate the azimuth of a sonar target (Simmons et al., 1983). Monaural spectral cues are considered essential for determining the elevation of a sound source in space (Simmons and Lawrence, 1982). The bat's pinna–tragus system creates patterns of acoustic interference that are used by the bat to estimate target elevation (Wotton et al., 1996). The third spatial dimension, target range, is estimated from the time delay between an outgoing sonar vocalization and its returning echo (Hartridge, 1945;Simmons, 1973;Feng et al., 1978) the time delay being converted into an estimate of target distance. FM–bats show extraordinary spatial selectivity along this 'range axis' (Moss and Schnitzler H-U, 1995). While species of bats have been studied that can use passive auditory cues for target localization (Fuzessery ZM et al.,

1993;Barber et al., 2003), the majority of echolocating bat species actively generate cues by emitting sonar vocalizations and listening to the returning echoes.

Sonar Repertoire

Each species of bat has a distinct repertoire of signals that it uses for echolocation, the features of these sounds ultimately determines the acoustic information available to its sonar imaging system (Carvell et al., 1991;Altes and Titlebaum, 1970;Altes, 1976). Bat sonar signals fall broadly into two categories, constant frequency (CF) and frequency modulated (FM) components (Figure 4). Species using CF–FM signals for echolocation typically forage in dense foliage, and some of these species adjust the frequency of their sonar vocalizations to compensate for Doppler shifts in returning echoes (Schnitzler, 1973;Metzner et al., 2002). The CF–FM bat’s Doppler shift compensation (DSC) serves to cancel a rise in echo frequency introduced by its own flight velocity and isolates spectral modulations in echoes that come from fluttering insect wings (Schnitzler and Flieger, 1983). In some Doppler shift compensating bats, researchers have identified auditory specializations, which give rise to heightened sensitivity and frequency selectivity in the spectral region of the bat’s CF signals (Neuweiler, 2003).

By contrast, many FM–bats forage in the open or at the edge of forests, using shorter duration, broadband signals that are well suited for three dimensional (3–D) target localization and for separating figure and ground. FM–bats can discriminate differences in echo delay, the cue for target distance, of less than 60 microseconds

(Moss and Schnitzler H-U, 1995; Simmons, 1973), and they use this delay information to control the timing of sonar vocalizations (Moss and Surlykke, 2001).

The clear dichotomy between foraging habits (open space versus close space hunters) based on call structure is not an absolute limiting factor. More recent infrared high-speed video imaging of FM-bats in natural conditions at night demonstrate bats able to use their echolocation calls in a wide range of environments including near and in vegetation (Simmons et al., 1978; Simmons et al., 2001).

Foraging bats change the features of their sonar vocalizations as they detect, approach, and intercept a target. The characteristics of sonar vocalizations have been used to divide the bat's insect pursuit sequence into three different phases: search, approach, and capture (Griffin et al., 1960). During the search phase, signals produced by *Eptesicus fuscus* are characterized by narrowband FM sweeps, with durations of 15–20 ms at a repetition rate of 5–10 Hz. Once a bat detects a prey item, it produces approach phase signals that show broadband FM, shorter durations (2–5ms), and 20–80 Hz repetition rates. In the final phase of capture, the terminal buzz, signals shorten further in duration (0.5–1ms), are produced at very high repetition rates (150–200 Hz), and show a drop in overall frequency with the sweep frequencies extending below 20 kHz (Surlykke and Moss, 2000).

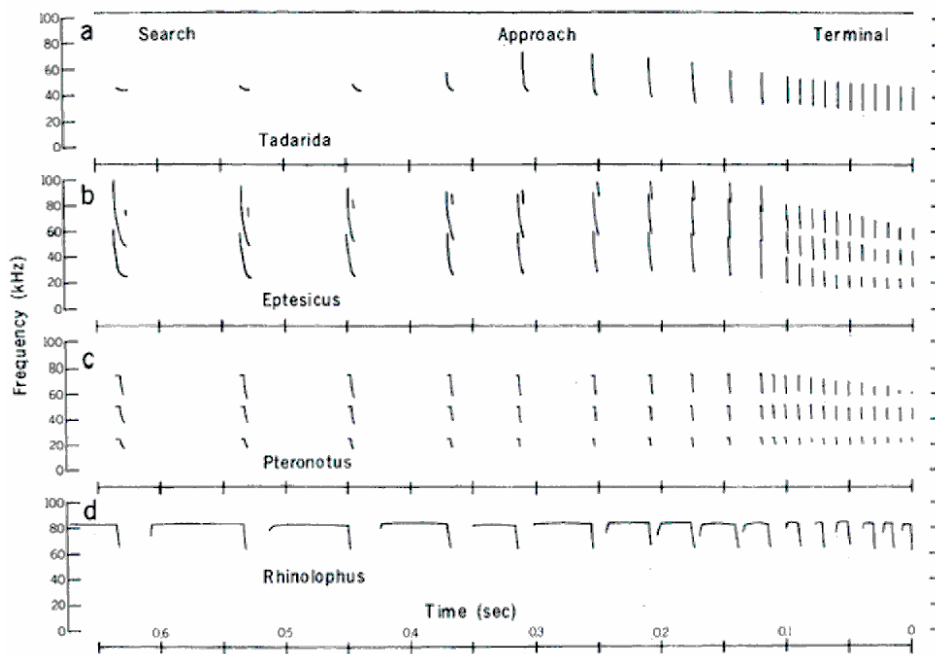

Figure 4 Diversity of sonar vocalizations from four different species of echolocating bats.

Each row illustrates the type of sonar calls emitted as bats approach a target (left side of figure). The spectrograms show the variation in sonar spectral content, duration and pulse interval as bats attack a target. Typical of insectivorous echolocating bats, signal repetition rate increases and the duration decreases as the animal approaches its prey. The dashed line indicates the change from search or orienting signals to approach signals. (Modified from Simmons et al., 1979).

These phases with different call characteristics provide a good first order scheme for classifying sonar calls, but much greater flexibility is observed when bats are hunting in a variety of natural conditions. This versatility in the use of echolocation for a variety of tasks beyond insect capture is demonstrated in recent field-work (Simmons et al., 2001) where *Eptesicus* employs echolocation while pursuing other bats, gleaning prey, or hunting very close to vegetation. More specific examples can be seen in laboratory experiments with CF-FM and FM-bats. Both *Rhinolophous ferrumequinum* and *Eptesicus fuscus* generally adjust the duration and repetition rate of their vocalizations in a graded manner, but can also demonstrate abrupt transitions where they produce distinct groups of sonar calls (sets of two or three calls) when hunting (Smotherman and Metzner, 2004; Moss et al., 2005). In this manner, dynamic sonar vocalization patterns form part of a complex set of adaptive behaviors to potentially improve the acoustic information gathered (Moss and Surlykke, 2001).

Sonar Beam Pattern

Echolocating bats emit their high-frequency orientation pulses from either the mouth or nostrils in a species-specific obligate manner (Griffin, 1958; Sales and Pye, 1974). The directionality of sonar emission is an important parameter for the echolocation system of bats. A directional emitter can save energy by ensonifying only the target, rather than the whole environment, and the resulting attenuation of echoes from areas other than the target improves the resistance to clutter. A directional receiver has increased sensitivity on-axis, and can help to improve the binaural angular acuity of systems that use interaural level difference (ILD) cues for

sound localization (Grinnell and Grinnell, 1965). The trade-off in employing a directional emission system is that it must scan to probe the environment.

Echolocating bats like *Eptesicus fuscus* are oral emitters and do so with their mouths wide open, forming a rudimentary horn (Strother and Mogus, 1970). The sonar beam emission patterns have been investigated for a number of bats species, including oral and nasal emitters as well as CF-FM and FM bats. Hartley and Suthers have conducted a number of these studies and for *Eptesicus fuscus* (Hartley and Suthers, 1989) they identified four main points: 1) Sound emission is directional and most intense in both the horizontal and vertical dimensions to give a mainlobe aimed forward of the animal. 2) The mainlobe is narrower at higher frequencies. 3) The axis of the mainlobe varies its orientation with frequency, such that it is directed more ventrally at lower frequencies. 4) A prominent ventral sidelobe is present at higher frequencies.

The characteristics of this emission pattern have a great deal of similarity with that observed in two other FM emitting bat species, *Carollia perspicillata* (Hartley and Suthers, 1987) a nasal emitter, and *Myotis grisescens* (Shimozawa et al., 1974) an oral emitter. Both have well-defined mainlobe with a ventral sidelobe below it. Additionally, the relative intensities of ventral sidelobes compared to the mainlobe are similar in both species at -6 dB. For all these bats the half-power (-3dB) point relative to the beam center axis is at approximately $\pm 20^\circ$, which we can refer to as a 40° cone of maximum signal intensity that the bat may then reorient in space to

maximize the echo returns. Therefore, the emission patterns of the FM emitting bats mentioned above appears conserved and may reflect an advantage for sound processing in the echolocation system. Whether the emissions patterns can be adaptively changed during echolocation is still an open question, as all the experiments described above were conducted in bats that spontaneously vocalized outside of any insect pursuit behavior, or were forced to vocalize by brain electrical microstimulation.

Neural Control of Sonar Vocal Production

The spectro-temporal parameters and patterning of sonar vocalizations is critical to echolocation behavior. A number of experiments, reviewed below, have been conducted over the last thirty years to identify and delineate the contribution of nuclei involved in the sonar vocal production circuitry. These experiments have relied heavily on electrical and chemical microstimulation and pharmacological manipulation techniques to ascertain the functional contribution of regions involved in producing sonar calls. The majority of these experiments have focused on brainstem loci, with one notable exception that studied regions in frontal cortex (Gooler and O'Neill, 1992). These studies used microstimulation techniques to identify cytoarchitecturally well defined regions (and others less so) that elicit vocalizations, and have also attempted to map out their interconnections. The general consensus is that a distributed organization, rather than more limited and localized organization, is responsible for vocal production and audio-vocal integration. This network involves nuclei in the mesencephalon, such as the paralemniscal tegmentum

area (PLa), periaqueductal gray (PAG), parabrachial nucleus (PB), and the superior colliculus (SC). Their direct and indirect projections to metencephalic and myelencephalic nuclei such as the nucleus retroambiguus (RA) and nucleus ambiguus (NA), which project to the laryngeal motor neurons, have been elucidated (Rübsamen and Schweizer, 1986; Suga and Yajima, 1989; Metzner, 1996; Schuller et al., 1997; Fenzl and Schuller, 2002).

Larynx and Nucleus Ambiguus

Four bat species have predominantly served as systems for studying the mechanisms involved in sonar vocal production: *Pteronotus parnelli*, *Rhinolophus rouxi* and *Rhinolophus ferrumequinum* all CF–FM bat species, and *Eptesicus fuscus* a FM bat species. These studies have evaluated the structure of the bat larynx, and have used various techniques to record from the nerves innervating the laryngeal muscles, the nucleus ambiguus, as well as respiratory dynamics that are coupled to vocal production.

Suthers and Fattu have studied the mechanisms of vocal production in *Eptesicus fuscus* at the level of the larynx. Bats emit sonar calls at various rates ranging from 1–200 calls/sec. These investigators (Suthers and Fattu, 1973; Fattu and Suthers, 1981) found that the maximum sound pressure level of sonar calls is positively correlated to the magnitude of the subglottic pressure at the onset of phonation. For short duration sonar calls subglottic pressure drops rapidly, and for long duration calls it shows the smallest rate of decline. They suggested that the

ability of *Eptesicus* to produce high intensity sounds is a function of the high subglottic pressures that is due in part to their extremely non-compliant lungs (Fattu and Suthers, 1981).

The control of parameters of sonar vocalizations has been studied by selective laryngeal neurotomy. These studies have found that specific nerves innervating the larynx control separate broad aspects (spectral and temporal) of the vocal structure. Frequency control in the larynx is mainly accomplished by the cricothyroid muscle, which alters the tension of the vocal folds. The cricothyroid muscle is innervated by the motor branch of the superior laryngeal nerve (SLN). Sectioning both SLNs results in dramatic decreases of the emitted frequency (Novick and Griffin, 1961;Schuller and Suga, 1976). In contrast the recurrent (inferior) laryngeal nerve (RLN) innervates several pairs of intrinsic laryngeal muscles. These muscle groups include the posterior cricoarytenoid muscle that opens the glottis, and the lateral cricoarytenoid muscles that close the glottis. Therefore, while sectioning the RLN has multiple potential side effects as it innervates a number of muscles, it does not markedly change the structure (spectrally) of the emitted sonar call (Novick and Griffin, 1961;Schuller and Suga, 1976;Suthers and Fattu, 1982).

In *R. ferrumequinum*, two recording studies have been conducted that examined the functional contribution of intact SLN and RLN during sonar vocal production. In these experiments sound playbacks were used to elicit Doppler shift compensation calls (see page 19) from the bat or electrical stimulation of the central

grey matter was used to elicit calls. The activity of the SLN was closely tied to the emission of sonar calls. The nerve activity started 30–50 ms prior to vocal onset and continued during the sound emission. The bats spontaneously produced calls with durations of 50 ± 5 ms. The spike count and the emitted CF frequency component were linearly related and highly correlated ($r=0.96, 0.95$, two bats tested) (Schuller and Rübsamen, 1981). RLN activity was present both in cases where subthreshold microstimulation was used (not eliciting sonar calls) and when sonar calls were elicited. In both cases the discharge rate of the RLN was sustained during inspiration and reduced to spontaneous levels during exhalation, corresponding to the time of vocalization. However, when the stimulation level was higher and the bat vocalized, the activity during inhalation remained unaffected, but a pronounced peak in nerve activity was observed approximately 20 ms prior to exhalation (and vocal onset). During the CF component of the vocalization the nerve maintained an elevated but steadily decreasing level of activity, and the terminal FM–sweep was preceded by a brief burst of RLN activity. The authors proposed that these two bursts of RLN activity correspond to the closing of the glottis to build–up sub–glottal pressure, prior to expiration, and the opening of the glottis that causes a rapid decrease in subglottic pressure and ends the emitted call (Rübsamen and Schuller, 1981).

The contribution of nucleus ambiguus neurons to sonar call production has been studied using single–unit neural recordings techniques in *R. rouxi* that spontaneously emitted sonar calls (Rübsamen and Betz, 1986). Neurons with a variety of pre–motor discharge patterns were identified. The discharge pattern of

different neuronal classes was correlated with the onset (on–chopper, on–tonic, prior–tonic), offset (pre–off–tonic, off–pauser, off–tonic) of sonar vocalizations, or the frequency shift of the CF component during DSC behavior ($r=0.68-0.8$, 14/19 units tested). The activity of these motoneurons drives, via the SLN and RLN, the separate laryngeal muscles. The authors classified the different discharge patterns with the activity of different muscles during call production. The call production occurs during expiration and can be broadly classified into three periods: abductors (posterior cricoarytenoid muscle) open the glottis for inspiration, adductors (lateral cricoarytenoid muscle) close the glottis for vocalization, and tension of the cricothyroid muscle influences the emitted frequencies. The authors suggested that on–type discharge patterns serve to close the glottis, the off–type discharge patterns serve to open the glottis, and the pre–off–tonic discharge pattern serves to control emitted CF frequency. The activity pattern of the different classes of neuronal discharges was in good correspondence with their observations.

Paralemniscal Tegmental Area

In the midbrain, studies have focused their attention on the PLa as a site for temporal and frequency control of emitted sonar vocalization in CF-FM bats (Metzner, 1989;Schuller and Radtke-Schuller, 1990;Schuller et al., 1997). Electrical microstimulation of the PLa in two CF-FM bat species (*Rhinolophus rouxi*, *Pteronotus parnellii*) elicits sonar vocalizations. Additionally, the PLa in *Rhinolophus rouxi* projects to the vicinity of laryngeal motoneurons (Schuller and Radtke-Schuller, 1990;Metzner, 1996), providing a direct putative pathway for

shaping motor neuron activity. In addition, Metzner (Metzner, 1993; Metzner, 1996) showed that auditory as well as vocal related responses were evident in this nucleus, suggesting the PLa sits within a feedback circuit for updating vocalizations. However, lesions of the PLa do not eliminate the ability to produce sonar vocalizations (Pillat and Schuller, 1998), suggesting that it not a mandatory component of the sonar vocal circuitry.

Ventral Midbrain Tegmental Pre-Motor Vocal Nuclei: PB, NCAT, PAG, & DMN

More recent experiments have studied the role of the parabrachial nucleus (PB) in sonar vocalizations in the CF-FM bat, *Rhinolophus ferrumequinum* (Smotherman et al., 2003). Using iontophoretic application of GABAergic and L-glutamate agonists and antagonists, the authors demonstrated that the PB plays a role in the control of call frequency. Application of muscimol (GABA_A agonist) or CNQX (6-cyano-7-nitroquinoxaline-2,3-dione; a glutamatergic antagonist) lowered the call frequency emitted at rest and during DSC behavior. Conversely, excitation induced by application of AMPA or by blocking inhibition using BMI (bicuculline methiodide, a GABA_A antagonist) increased sonar call frequencies. These results provide evidence that the PB nucleus is part of a circuit for controlling the frequency modulation of sonar calls.

The nucleus of the central acoustic tract (NCAT), receives auditory information directly from the cochlear nucleus and sends projections, that bypass the inferior colliculus, to the deep layers of the superior colliculus and to the

supragenulate nucleus (in the auditory thalamus) (Figure 5). In bats this pathway was demonstrated in *Pteronotus parnellii* (Casseday et al., 1989) and later in *Rhinolophus rouxi* (Behrend and Schuller, 2000). Additionally in *P. parnellii* the thalamic target of the NCAT, the supragenulate nucleus, projects to a circumscribed region of the bat frontal cortex, a region that receives direct projections from the primary auditory cortex (Kobler et al., 1987). As such, this pathway conveys auditory information from the cochlea to the frontal cortex in approximately four synapses, and has therefore been proposed to provide rapid auditory information to regions that can guide orienting behaviors.

Studies in the CF–FM bat *Rhinolophus rouxi* demonstrate that the NCAT receives bilateral projections from the cochlear nuclei. Contralateral projections are excitatory and ipsilateral projections are inhibitory with 53% of cells being E/I cells, 23% being E/E cells, the remainder being E/O in their response type (Behrend and Schuller, 2000). The latencies of response were 2.5–5.0 ms, the units had little to no spontaneous firing rate, no tonotopic organization was evident, and 80% of cells had best frequencies around the bats CF resting frequency. Electrical microstimulation of NCAT resulted in normal–like sonar vocalizations with latencies of 25–70 ms. Stimulation generally resulted in concomitant ear movements. Unilateral lesions of NCAT results in loss of the Doppler shift compensation (DSC) behavior that did not return even after 24 hours.

Three additional midbrain sites have been implicated as components of a sonar vocal production circuit. This includes the PAG and the deep mesencephalic nucleus (DMN). While electrical stimulation of the PAG in *Eptesicus fuscus* elicited communication calls (Valentine et al., 2002), chemical stimulation in the neotropical FM bat, *Phyllostomus discolor*, elicited communication calls and sonar calls from separate loci within the nucleus (Fenzl and Schuller, 2002). The PAG has been implicated as a mandatory vocal motor output pathway in other mammalian species (Jürgens, 2002), so this result suggests that it has been co-opted into serving a role in sonar vocal control. The DMN is also thought to play a role in vocal production but has not been extensively studied, outside of demonstrating that electrical microstimulation of this nucleus elicits sonar vocalizations (Schuller and Radtke-Schuller, 1990).

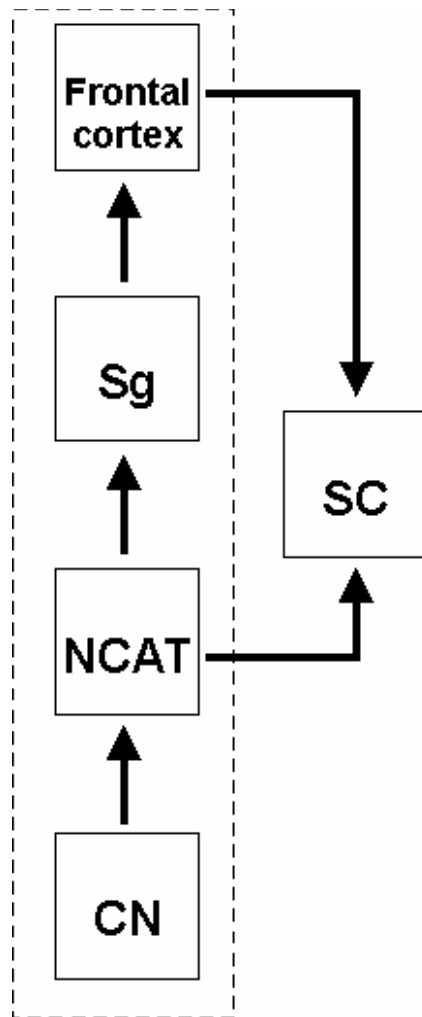

Figure 5 The central acoustic tract is a paralemniscal pathway in mammals. This pathway bypasses the primary auditory nuclei in the brainstem, and projecting straight to the auditory thalamus. It also sends projections to the SC, providing the SC with rapid auditory information. The entire pathway has been demonstrated in the mustached bat, *Pteronotus parnellii*. CN cochlear nucleus, NCAT nucleus of the central acoustic tract (also referred to as the anterolateral periolivary nucleus, SC superior colliculus, Sg suprageniculate nucleus (Adapted from Casseday et al., 1989).

The third midbrain site implicated in sonar vocal control is the superior colliculus (SC). This structure is one of the most extensively studied sensori–motor structures in vertebrates and is involved in orienting an animal’s gaze. A role for the SC in vocal control has not previously been reported among non–bat species. Furthermore, and similar to other species, microstimulation of the SC elicits other species–specific orienting behaviors like pinna movements (Schuller and Radtke-Schuller, 1990; Valentine et al., 2002), and head movements (Valentine et al., 2002). In addition the SC in *Eptesicus fuscus* has auditory specializations related to processing of acoustic information. These sensori–motor specializations make the bat SC a putative site for audio–vocal integration, where converging auditory information guides the production of sonar vocalization and other orienting behaviors. In the next section, important aspects of the anatomy and function of the mammalian SC are described, and current knowledge of the bat SC is reviewed, and serves as the basis for the experiments described in this dissertation.

The Superior Colliculus

The superior colliculus (SC), or the non-mammalian vertebrate homologue, the optic tectum (OT), is a prominent structure in the mesencephalon (Figure 6). Anatomical and neurophysiological evidence strongly supports the SC’s role in sensori-motor integration processes that underlie species–specific orienting behaviors. The functional organization of the SC (OT) reflects the importance of a sensory modality to an animal’s goal-directed behaviors. Comparative animal studies indicate a role for the SC (OT) in the saccadic eye–movement system (Sparks, 1986), smooth–

pursuit eye movements (Krauzlis, 2004) and vergence eye movements (Chaturvedi and Van Gisbergen, 1999) in primates, the control of head, eye, and pinna in cat (Guitton and Munoz, 1991; Munoz and Guitton, 1991; Stein and Clamann, 1981) and head turning in barn owl (du Lac and Knudsen, 1990; Masino and Knudsen, 1992; Masino and Knudsen, 1993). Other studies have identified specializations of the OT that support its role in visual prey–capture behaviors (approach, snapping) in frog (Ewert, 1997) and visual and infrared–imaging based head–turning in rattlesnakes (Hartline et al., 1978), and in orienting and evasive behaviors in the rat (Dean et al., 1989) and goldfish (Herrero et al., 1998; Herrero et al., 1999).

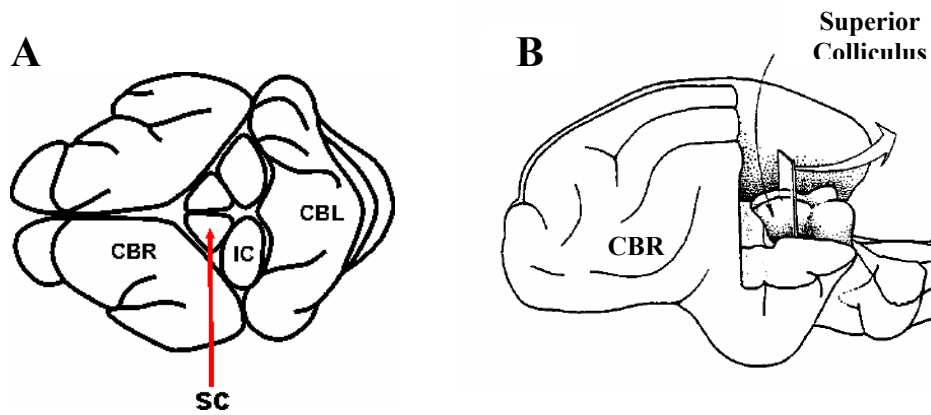

Figure 6 Schematic drawings of the rat and cat brain highlighting the location of the midbrain superior colliculus.

Drawing of the **A**) bat (*Eptesicus fuscus*) and **B**) cat brain showing the relative positions of the superior colliculus in each. Scale bat for bat is 8 mm. CBR cerebral cortex, SC superior colliculus, IC inferior colliculus, CBL cerebellum (cat drawing modified from Stein and Meredith, 1993).

The Superior Colliculus in Mammals

Anatomically the SC in mammals generally has seven-lamina as identified in Nissl and myelin stained anatomical sections, that are oriented parallel to the dorsal surface. On the basis of anatomical connections and functional responses the layers can be grouped into the superficial layers which are more dorsal and the sensori-motor deep layers which are more ventral. The superficial layers are comprised of the stratum zonale (SZ), the stratum griseum superficiale (SGS), and the stratum opticum (SO). The deeper layers encompass the stratum griseum intermediale (SGI), the stratum album intermediale (SAI), the stratum griseum profundum (SGP), and the stratum album profundum (SAP) (Figure 7).

The intermediate and deep layers of the SC are connected with a multitude of structures that are related to visual, auditory and somatosensory motor functions (for review see Wurtz and Albano, 1980; Huerta and Harting, 1984b), and to other sensory modalities that other animal species may possess. Neurons with many different functional properties have been identified in the intermediate and deep layers, including classes of sensory (uni-modal and multi-modal), pre-motor, and sensori-motor all of which generally have spatially tuned receptive fields. In most vertebrates studied the sensory neurons within these deeper layers are topographically organized, and are aligned with the visual representation present in the superficial layers. In addition, the deeper layers contain 'motor' maps of movements, such as eye movement (as in primates), and head and pinna movement maps (as in cats and bats).

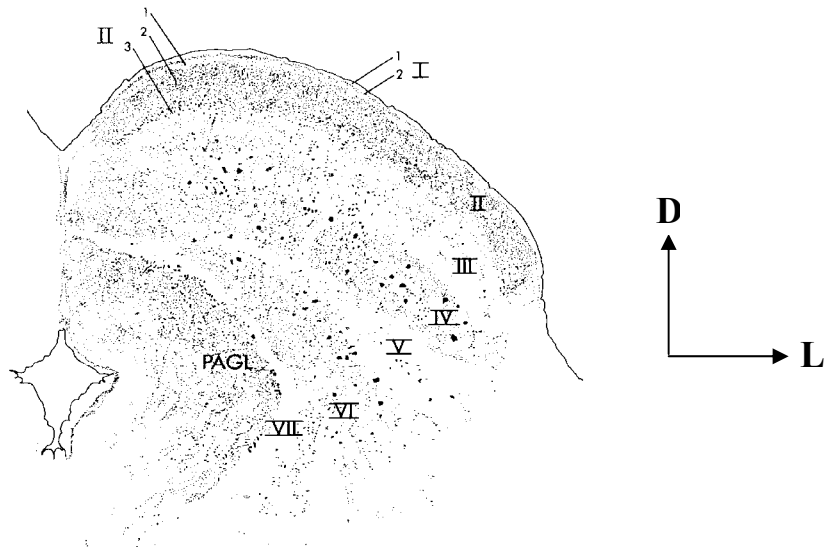

Figure 7 A drawing of the lamina of the cat superior colliculus made from a coronal, Nissl stained, cross-section.

The seven lamina identified in cat are marked on the figure from dorsal to ventral, and the alternating pattern of cell body layers is evident alternating with the fiber layers (Modified from Kanaseki and Sprague, 1974).

In most vertebrates the motor maps are aligned with their sensory space maps (see for example Schiller and Stryker, 1972). The motor map is comprised of different classes of pre-motor neurons that discharge prior to and during orienting movements. In addition, when the SC is stimulated (electrically or chemically) well coordinated, natural movement sequences resembling tracking, pursuit, avoidance, defensive, or escape behaviors can be elicited (Hess et al., 1946;Dean et al., 1989).

The connectivity and important functionality of the different lamina are briefly reviewed in the following subsections, with an emphasis on the deeper SC layers/lamina, where the recording experiments described in Chapter 2 are conducted. In addition, the focus will be on visual and oculomotor related functions of the SC, as these are by far, the most extensively studied and understood aspects of the SC and pertinent to discussions later in this dissertation.

The Superficial Layers

The SZ and SGS lamina have relatively few afferent and efferent connections when compared to the deep layers of the SC and all of these connections are to the visual system. These superficial laminae respond only to visual stimulation, and have small visual receptive fields. The neurons in the superficial layers can be further subdivided into sub layers based on the distribution of response latencies from optic nerve stimulation (Hoffmann, 1973), and differential connections (Mize, 1996).

The most superficial part of these layers receives input from the W retinal pathway (Schiller and Malpeli, 1977). They have slow axonal conduction velocities,

large receptive fields, poor spatio-temporal resolution, poor contrast sensitivity, and respond maximally to slowly moving stimuli (Schiller and Malpeli, 1977; Sur and Sherman, 1982). The lower part of the visual layers in SC receives inputs from Y retinal cells. These cells have the best temporal resolution, contrast sensitivity, and conduction velocity, and are involved in motion processing. These cells are similar to primate M (magnocellular) cells. The cells in the SC receiving Y retinal cell input project to the posterior nucleus of the thalamus (the pulvinar). Y-cells in the SC also receive strong excitation from cortical areas 17 and 18 (Palmer and Rosenquist, 1975), and their responses are disrupted when their magnocellular inputs are inactivated (Schiller et al., 1974; Schiller et al., 1979). The SO is the sole retinal recipient layer in the SC. Additionally, the visual receptive fields of neurons in these layers have retinotopic organization primarily of the contralateral hemi-field and a limited extent of the ipsilateral field, with central regions being represented rostrally, peripheral regions caudally, upper visual hemi-field medially and lower hemi-field laterally (Schiller and Stryker, 1972). Cortical projections to these SC layers obey the retinotopic organization. These cells respond to visual stimuli within their spatial receptive field. After a saccade these visual cells exhibit a suppression of their background firing rate resulting from a corollary discharge that occurs during a saccade in the oculomotor system (Richmond and Wurtz, 1980).

The Deeper Layers

The deeper layer of the mammalian SC, comprising the intermediate and deep layers (SGI, SAI, SGP, SAP), in contrast to the superficial ones, receives inputs from

a multitude of different functional areas. They arise from visual, and nonvisual sensory modalities, frontal and parietal cortical regions, and basal ganglia structures and send descending and/or ascending projections to the brainstem reticular formation, spinal cord, and thalamus (Huerta and Harting, 1984a). The dominant role of the SC in visual and oculomotor function has guided much of the research and theories on SC function (Sparks, 1999; Sparks, 2002; Wurtz and Albano, 1980).

The studies of the SC in visual animals have identified a retinotopic visual map in the deeper layers of the SC that is in register with the topography observed in the superficial layers (Schiller and Stryker, 1972). Other sensory modalities are also mapped in the deeper layers and are aligned with the visual representation found in the deeper layers. Thus the superficial and deep layers have sensory maps in register. The spatial receptive fields of sensory neurons in the intermediate and deep layer are large (Wurtz and Albano, 1980). In addition, many of these neurons are responsive to multiple sensory modalities (Meredith et al., 1992; Wallace et al., 1996), and show supra-linear responses when stimuli from two or more modalities are simultaneously presented as compared to individually presenting stimuli. These multi-modal sensory neurons create an integrated sensory representation of the world and are heavily shaped in their response profile by projections from the anterior ectosylvian sulcus and its surround, in the parietal cortex (Wallace et al., 1993; Jiang et al., 2001).

In addition to the topographically organized sensory neurons, the deep layers of the SC have pre-motor neurons that discharge, prior to and during, species-

specific gaze orienting movements such as saccadic eye, head, vibrissal and pinna, and body movements. These pre-motor neurons are organized topographically in register with the retinotopic map (Robinson, 1972), and have been extensively studied in visual animals like monkeys and cat (for review see Moschovakis et al., 1996). The mapping observed from electrical stimulation experiments in the SC shows that electrical stimulation results in contralateral movements such that, stimulation of rostral sites elicits small amplitude movements, stimulation of caudal sites elicits large amplitude movements, stimulation of medial sites elicits upward movements, and stimulation of lateral sites elicits downward movements. This has been shown both for (saccadic) eye movements (Robinson, 1972; Roucoux and Crommelinck, 1976), head movements (Freedman et al., 1996; Corneil et al., 2002b; du Lac and Knudsen, 1990), and other species-specific orienting behaviors. The effect of electrical stimulation can be largely explained by a specific pattern of SC projections onto the brainstem and spinal cord movement generators (Moschovakis et al., 1998).

The collicular efferent pathways have a complex pattern of terminations in the brainstem and in the cervical spinal cord (Huerta and Harting, 1984a; Grantyn, 1988; Moschovakis et al., 1996), which in turn transform collicular input and project to motor neurons (Masino, 1992). Two classes of efferent neurons involved in orienting movements have been identified. The first kind of efferent neurons, the T neurons, are predominantly located in the intermediate layer (SGI), and sometimes in adjacent layers (SO, SGP) (Moschovakis and Karabelas, 1985). These T neurons provide a commissural branch (tecto-tectal), issue recurrent collaterals distributed

within a more or less restricted area of the deeper layers, and project to pontomedullary structures. The T group of neurons have various morphologies and are composed of two distinct populations, immunoreactive for glutamate or GABA in roughly equal proportion (Olivier et al., 2000). The second class of efferent neurons, called X neurons, are located in the SGI and SGP and are excitatory (i.e. glutamatergic). X neurons are mostly large and multipolar and project to hindbrain reticular formation and into the cervical spinal cord. These neurons have intracollicular collaterals in some animals but not others (Grantyn and Grantyn, 1982; Moschovakis and Karabelas, 1985; Moschovakis et al., 1988).

The target structures of T and X neuron efferents are associated with orienting motor behaviors. In the T class of cells specifically, vigorous bursts of activity precede the initiation of saccadic eye movements by 20 ms (Scudder et al., 1996a; Sparks, 1978), and are referred to as saccade-related burst neurons. In the SC, this burst of activity occurs on the retinotopic movement map in accordance with the size and direction of the impending saccade. For instance, cells in the anterior SC will discharge for small amplitude saccades, and if the receptive field includes the foveal region they discharge during target fixation, while cells in the caudal SC will discharge for a large amplitude saccade. Population coding of the saccadic eye movements was demonstrated in the SC by local injections of lidocaine (a Na⁺ channel blocker) (Hikosaka and Wurtz, 1986; Hikosaka and Wurtz, 1986; Aizawa and Wurtz, 1998; Quaia et al., 1998), which showed that the direction, amplitude and

velocity of saccadic eye movements are determined by the entire population of active SC cells.

A number of classification schemes have been created in the study of superior colliculus neurons. The saccade-related burst cells (Wurtz and Goldberg, 1971; Mohler and Wurtz, 1976; Sparks, 1978), have been called 'burst' cells by others (Munoz and Wurtz, 1995a; Munoz and Wurtz, 1995b) are thought to contribute to saccade initiation. These authors also identified a second class of cells that have a slow build-up of activity starting hundreds of milliseconds prior to a change in visual gaze. They referred to neurons with this discharge pattern as 'build-up' cells, similar to those found in cats (Munoz and Guitton, 1991) (Figure 8). These cells discharge to a flashed target (T), but as long as fixation is required, their discharge decreases slowly. When the fixation point (FP) disappears and the monkey is allowed to shift its visual gaze to the memorized location, the discharge of the buildup cell increases, and changes into a high frequency burst at saccade onset. Since the activity increases slowly over 100–150 ms before the saccade could be regarded as an argument for the movement preparation in the SC.

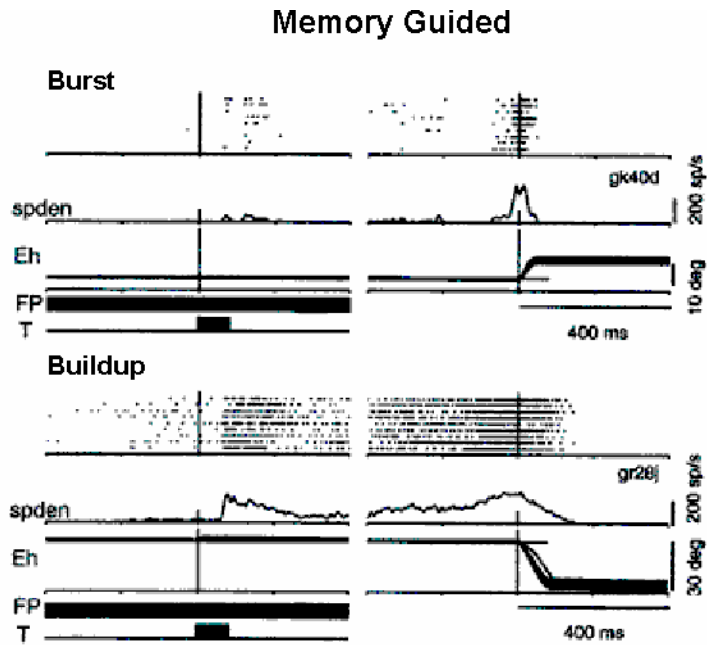

Figure 8 The discharge pattern of burst and buildup neurons during memory guided saccades.

The discharge pattern of burst and buildup neurons during memory guided saccades. In the upper panel is displayed the discharge of a burst cell, which is represented by a spike raster and a spike density function (spden, $\sigma=4$ ms). The eye horizontal position (Eh) is shown below with a schematic representation of the behavioral paradigm. While the fixation point (FP) remained illuminated, the Target was flashed. After a random period of time (400-800 ms), the FP was turned off and the monkey was required to make a saccade in the direction of the remembered location of the T flash. On the left, the discharge of the burst cell is aligned with the T onset, whereas on the right, this discharge is aligned with the beginning of the eye movement. The burst cell discharged mainly just before and during the saccade. (B) In contrast, the buildup cell exhibited a sustained response after the presentation of the target and this discharge increased until the saccade was performed. (Modified from Munoz and Wurtz, 1995a).

The Superior Colliculus in Echolocating Bats

Few studies have been directed toward understanding the function of the superior colliculus among auditory specialists like the echolocating bat, when compared to SC function in visual specialists like cats and monkeys. However, based on current studies in the echolocating bat, the SC shows many shared properties with that seen in other animals, in addition to functional specializations for acoustic orientation using sonar. These functional adaptations are consistent with species-specific morphological and functional adaptations observed in bat species. The evidence derived from anatomical, physiological and behavioral studies of the bat SC provide a basis for the transformation or linking of an acoustic representation of auditory space with motor pathways that can mediate acoustic orientation by sonar (Shimozawa et al., 1984; Wong, 1984; Covey et al., 1987; Casseday et al., 1989; Reimer, 1991; Valentine and Moss, 1997; Valentine et al., 2002; Schuller et al., 1997; Behrend and Schuller, 2000). The following subsections review current data on bat SC anatomical connectivity, response properties of auditory neurons, and microstimulation experiments that elicit species-specific orienting behaviors.

Anatomical Connections of the Superior Colliculus in the Echolocating Bat

Two lines of anatomical investigations have elucidated the connections of the superior colliculus in echolocating bats. The first line has focused on the connections of the superior colliculus with primary auditory structures and vocal motor nuclei. These studies have attempted to identify roles for the SC in echolocation and acoustic

orienting. The second line of investigation has evaluated retinofugal projections among animal species that rely on vision to varying degrees. Therefore, these comparative studies have evaluated the SC connections and their relative strength among different microchiropteran bat species, megachiropteran bat species and non-echolocating species. The first set of studies is most pertinent in the context of this dissertation and is described below. The later line of inquiry is introduced afterwards and the basic findings highlighted.

In bats, as in other mammals, the SC has populations of neurons that support sensory representations of space and pre-motor neurons related to orienting behaviors. In bats it is proposed that the SC uses auditory information to guide orienting behaviors like body and head aim, and pinna movements. In line with this, experiments have demonstrated that the bat SC receives auditory information via two separate auditory pathways: the extralemniscal (Casseday et al., 1989) and the lemniscal (primary) auditory pathway. The extralemniscal pathway, the central acoustic tract (CAT) (Figure 5), was first described by Ramón y Cajal in mouse, and later elaborated on by Papez in cat (Papez, 1929). This pathway conveys auditory information from the cochlear nucleus to the nucleus of the central acoustic tract (NCAT), which sends projections, that bypass the inferior colliculus, to the deep layers of the superior colliculus and to the suprageniculate nucleus, a thalamic auditory nucleus dorsomedial to the ventral division of the medial geniculate body. The suprageniculate nucleus in turn projects to a region of the frontal cortex (shown in *P. parnellii*) (Kobler et al., 1987). This site in frontal cortex receives direct

projections the mustached bat's primary auditory cortex, and has robust single-unit responses to auditory stimuli. Tracer injections into this auditory frontal cortex region demonstrate anterograde projections to the deep layers of the superior colliculus. Therefore, a pathway conveying auditory information from the cochlea to the frontal cortex exists, which send descending projections back to the SC, thereby influencing brainstem motor pathways.

Two reports have described the projections of superior colliculus using wheat germ agglutinin conjugated to horse-radish peroxidase (WGA-HRP) tracer deposits into the SC (Covey et al., 1987;Zhang et al., 1987). The qualitative pattern of SC projections observed in these two bat species (*Pteronotus parnellii* and *Eptesicus fuscus*), are similar to those observed in such disparate species as frogs (Masino and Grobstein, 1990), turtles (Serenio, 1985), snakes (Hartline et al., 1978), owls (Masino and Knudsen, 1992), cats (Grantyn and Grantyn, 1982) and primates (Scudder et al., 1996a;Scudder et al., 1996b;Moschovakis et al., 1998).

The first report evaluated extensively the connections of the SC in the mustached bat, *Pteronotus parnellii* (Covey et al., 1987), using tracer injections into the SC as well as into various structures that project to the SC – the eye, inferior colliculus, deep cerebellar nuclei, and dorsal nucleus of the lateral lemniscus. They found that the SC was composed almost entirely of layers below SO. The superficial and retinal recipient layers of the SC were small in comparison to other mammals, SGS and SAS (layers 1 and 2) showed no clear means of differentiation, and the

authors observed a sparseness or absence of pathways connecting the SC with the visual system. The primary sources of afferent input were from auditory structures: the central nucleus of the inferior colliculus (ICc), the nucleus of the central acoustic tract (referred also as the anterolateral periolivary nucleus, ALPO), and parts of the dorsal nucleus of the lateral lemniscus (DNLL), all part of the so-called lemniscal pathway. The principal outputs were to the cerebellum, the zona incerta (ZI) and the paralemniscal tegmentum area (PLa) (implicated in triggering sonar vocalizations vocal production), and the medial nucleus of the dorsal thalamus, which sends projections to the frontal cortex (Kobler et al., 1987), and in primates contain neurons with responses temporally linked to onset of eye movements. The second report described connections of the SC in the big brown bat, *Eptesicus fuscus* (Zhang et al., 1987). Their findings were consistent with studies in other animal systems, however, unlike the specialized connections related to acoustic orienting observed in *P. parnellii* (Covey et al., 1987), these authors did not report any pathways distinct to *Eptesicus fuscus*.

The retinofugal pathways have been studied at some depth, in a number of echolocating bat species including *E. fuscus*. While echolocating bats rely heavily on their echolocation system when foraging and navigating they still have preserved visual pathways that are similar to that in other mammals. Studies (Pentney and Cotter, 1976a; Cotter and Pentney, 1979; Cotter, 1985) have examined retinofugal pathways in echolocating bats *Myotis sodalis*, *Myotis lucifugus*, *Eptesicus fuscus*, *Pteronotus parnellii* and *Artibeus jamaicensis*, and nonecholocating bats *Pteropus*

gigantus. These authors emphasize that the overall retinal projections are remarkably similar to that in other mammals, but that the different morphologies and functions of microchiropteran visual systems seem adapted to species-specific behaviors, feeding habitats and environments. In turn, the reduced reliance on vision in some bat species is associated with less developed visual systems. For instance in *Artibeus jamaicensis* which inhabits the tropics of the New World and feeds primarily on plants, the eyes are larger, the vision is functionally more sensitive and discriminatory (Suthers, 1966) (Hope and Bhatnagar, 1979a; Hope and Bhatnagar, 1979b), the retinal projection pathways are larger and the target visual nuclei are better developed, when compared with that of *Eptesicus fuscus* (Cotter, 1985).

Receptive Field Properties of Auditory Neurons in the Superior Colliculus of Echolocating Bats

A series of studies by P.H. Jen and colleagues first described the response properties of auditory neurons in the superior colliculus of the insectivorous bat *Eptesicus fuscus* (Sun et al., 1983; Jen et al., 1984; Shimozawa et al., 1984). Using free-field acoustic stimulation, presenting stimuli across the frontal 180°, and $\pm 40^\circ$ in elevation, they demonstrated sensitivity to ultrasonic signals, with spatial receptive fields in the contralateral hemisphere. For all the neurons tested, the size of the spatial response area of each neuron was large, varying between 20° and 40°, sharply defined, and circular or elliptical (along the azimuth) in shape. These areas were shown to expand with increasing stimulus intensity, in some cases encompassing the entire contralateral hemifield, while the best azimuth (BA, the stimulus azimuthal

angle that generated the best response) did not change. The response patterns were similar to the responses of IC neurons to ultrasonic stimuli, i.e. zero to low spontaneous firing rates and onset type responses (Schlegel et al., 1988). Best frequencies (BF) of the recorded neurons were in the range of 23–85 kHz, but with a greater amplitude–sensitivity to FM sweeps as compared to pure tones. The response to tones was not tonotopically organized along the dorsal–ventral axis as it is in the IC. These studies, which used penetrations normal to the brain surface, could not demonstrate any precise representation of the auditory space in the SC of this bat species (based on 70 penetrations and 123 single–units recorded) (Shimozawa et al., 1984), which is a striking difference to the topography observed in the OT of owls, and in the SC of cats, and monkeys. Other investigators have also reported similar findings in *Eptesicus fuscus* (Poussin and Schlegel, 1984). These authors also reported that all the SC neurons in their population had BA, but that 20% of these neurons showed shifts in the BA toward the mid–line with decreasing stimulus intensity (tones at BF, 50–90 dB SPL). As in the previous studies there was no evidence of a point–to–point mapping of auditory space among the SC neurons tested (n=130).

The responses of auditory neurons in the SC of another FM–bat species from the Vespertilionidae family, *Myotis lucifigus*, have been studied (Wong, 1984). In this study free–field, downward sweeping, FM stimuli were presented to bats. The latencies for response were similar to that observed in *Eptesicus fuscus*. Two classes of neurons were described based on their BA spatial tuning. The first class was

referred to as hemi-field neurons, represented one-third of their population, responded to stimuli originating from a large part of the contralateral side, independent of stimulus intensity. The second class of neurons was referred to as azimuth-sensitive, and exhibited spatial selectivity near the neurons' minimum threshold for specific azimuths, generally on the contralateral side, and showed broadening of azimuthal tuning at progressively higher stimulus intensities, to the point where spatial tuning disappeared, very similar to the observations in *Eptesicus fuscus*. The two classes of neurons in *Myotis* showed a corresponding segregation in BFs, the azimuth-sensitive neurons having BFs in the range of 80–100 kHz, while the hemi-field neurons were tuned to frequencies below 70 kHz. This study used oblique penetrations along a caudal–rostral axis, and showed that the BA of neurons within a penetration systematically shifted with location, caudal–rostral and dorsal–ventral, with sounds originating from 0°–10° ipsilateral represented in the rostral SC, and sounds from 30°–40° contralateral represented in the caudal SC.

The previously mentioned studies of SC have used free-field methods of auditory stimulation in bats producing FM calls. One other study has examined the SC in the CF–FM horseshoe bat, *Rhinolophus rouxi* (Reimer, 1991), and used dichotic stimulation. Tonal stimuli were primarily used as the responses to FM signals and bat-like calls were similar to the pure tone responses. Recordings of auditory neurons demonstrated an over-representation of neurons with best frequencies (BF) at the CF component of this species' CF–FM call. Half the neurons recorded (246/592) responded to acoustic stimuli with very low firing rates. Neurons

with higher BF had higher Q_{10} dB values (> 50), and response latencies were similar (mean: 9 ms, range: 3–36 ms) to those reported in *E. fuscus* and *M. lucifigus*. Little indication of tonotopy was observed. However, at ventral sites, in the rostral SC, extending down into the MRF neurons with lower BF were predominant. The author speculated that neurons in this rostral region may be less influenced by CF information, and may encode the shorter duration CF–FM calls that have a shorter CF component. The majority of the units (65%) responded to monaural stimulation from the contralateral side, with 32% responding to stimulation from either ear and the remaining 3% requiring binaural stimulation.

Further studies of the superior colliculus in *Eptesicus fuscus* (Valentine and Moss, 1997) have identified two populations of spatially selective auditory neurons. The first population showed selectivity to auditory stimuli in both azimuth and elevation (2–D neurons) similar to that found by Jen and colleagues. A second population (3–D neurons) showed spatial selectivity to azimuth, elevation, and echo delay, the bat's cue for target range. Neurons with echo delay–sensitivity respond in a facilitative manner to pairs of FM sounds separated by specific temporal delays, i.e. their response to a pair of sounds is greater than the sum of the responses to the component parts. These neurons have a putative role in encoding target distance in the bat auditory system (Feng et al., 1978; Suga et al., 1978). This population of neurons had best echo delays (BD) ranging from 4–20 ms (mean: 13.5 ± 8.1 ms), a behaviorally relevant range of delays during insect pursuit, and Q_{50} dB ranging from

0.70–5.56 (mean: 1.68 ± 1.01). These 3–D neurons show no particular topographic organization within the SC.

Activation of Orienting Behaviors by Microstimulation of the Superior Colliculus in Echolocating Bats

Behavioral context shapes the sonar vocalizations bats produce. This is evident in numerous bat species when measuring the considerable variation in duration, bandwidth, spectral content, and temporal patterning of sonar vocalizations during insect pursuit (variations shown for selected species in Figure 4). The variations in call design, the relative motion of the bat with respect to targets of interest, and the changes in call structure and temporal patterning all influence the information available to the bat's auditory system in returning echoes.

Electrical and chemical microstimulation experiments in the big brown bat SC elicit sonar vocalizations, head and pinna movements (Valentine et al., 2002). The microstimulation has revealed a basic topographic map of pinna movements, and in experimental cases in which the animal's head was not restrained, coordinated movement of pinna, head, and sonar vocal production. A detailed analysis of the coordination of motor behaviors was not possible due to the limitations in the audio and video recording configuration (Valentine et al., 2002).

The sonar vocalizations elicited by electrical stimulation resemble those produced by the bat in the approach phase of insect pursuit, i.e. 2–5 ms duration, > 30

kHz bandwidth of the fundamental, with multiple harmonics. At threshold levels of stimulation one sonar vocalization was produced for each stimulus train. Increases in the strength of electrical microstimulation (from 9-15 μ A) elicited higher vocal repetition rates, and the total number of vocalizations produced, but only a modest change in the range of call durations. Similar findings from electrical microstimulation experiments in the SC of a CF-FM bat species, *Rhinolophous rouxi* have been reported (Schuller and Radtke-Schuller, 1990). Direct electrical stimulation of the periaqueductal gray (PAG), that lies ventral to the SC, elicits communication calls (Valentine et al., 2002; Fenzl and Schuller, 2002).

Proposed Experiments

The echolocating bat's adaptive motor behaviors serve to constrain the time-scales over which neuronal operations must take place. The temporal patterning of the bat's echolocation signals provides explicit data on the likely timing of vocal-motor commands for spatially guided behavior. Given the current understanding of sonar vocal behavior in foraging bats, this active mode of sensing provides fertile ground for neurophysiological investigations. This dissertation research has concentrated on neural recordings in awake and freely behaving bats, and has focused the relation of this activity to the temporal parameters of sonar vocalization used by bats engaged in echolocation behavior. In support of this work experiments using microstimulation and tract tracing techniques have been conducted to show the connections of the SC, both functional and anatomical, with sonar vocal production.

To study the role of the SC in sonar vocal control three sets of experiments were conducted. Two of these experiments required neural recordings from freely echolocating bats. For this purpose, chronic neural recording techniques for the bats were developed. The first experiment involved neural recordings from bats resting on a platform and spontaneously producing sonar vocalizations as they listened to electronically delayed playbacks of their sonar cries. The design of the experimental set-up did not involve insect capture behavior and the bat was trained to maintain a relatively stable head position. Therefore, with appropriate controls, neural recordings during this task isolated pre-motor activity related to sonar vocalizations, from head or pinna movements.

The second experiment used a newly developed behavioral paradigm with an oscillating target. Bats were trained to rest on a platform, and catch a tethered edible target oscillating toward and away from the bat on a pendulum arm, while neuronal activity from the SC was simultaneously recorded. This target-directed behavior evoked a natural sequence of sonar vocalizations, closely approximating aspects of the bat's echolocation behavior during insect pursuit and capture. The vocalizations emitted showed a distinct relationship between target distance, call duration, and pulse intervals (PI) that were not observed in the echo playback paradigm. This repertoire allowed a more extensive analysis of relationships between sonar call features and temporal patterning with simultaneously recorded neural activity and physical target position in space.

The third experiment used anatomical tract tracing techniques to identify anterograde connections of the SC with brainstem sonar–vocal control nuclei. Connections between the SC and pre–vocal nuclei serve as putative output pathways for influencing sonar vocalizations. This experiment also addresses confounding issues related to microstimulation, in which the spread of current or chemical agonist to other loci may elicit the observed sonar vocalizations.

In the following sections of this dissertation, Chapter 2 describes the two neurophysiological experiments by summarizing the background, information, elaborating the methods, giving the results, and discussing the findings. The anatomical experiments are described in Chapter 3, in a similar manner. Finally, Chapter 4 discusses the conclusions of the study, as well as presents a conceptual model for the role of the bat superior colliculus in acoustic orientation by sonar, specifically sonar vocal production.

Chapter 2: Vocal Pre–Motor Activity in the Superior Colliculus of the Echolocating Bat, *Eptesicus fuscus*.

Introduction

Echolocating bats employ temporally complex, dynamic sequences of sonar vocalizations to successfully orient and hunt in darkness (for review, see Griffin, 1958) (Figure 9A). Echolocation, like whisking in rodents, or oculo–motor control in primates, is an active process in which behavioral strategies are rapidly adapted and changed to handle evolving task demands (Griffin et al., 1960; Surlykke and Moss, 2000). Also, similar to the somatosensory system of rodents and the visual system of primates, feedback is essential to the bat in order to select and produce appropriate behavioral responses to changing acoustic information (Wadsworth and Moss, 2000). One neural structure implicated in the orienting behaviors of all these mammals is the midbrain superior colliculus (SC), which has evolved functional specializations for the control of species–specific orienting behaviors. In the case of echolocating bats, the SC has been implicated in the production of complex sonar vocalizations, as well as head and pinna movements (Valentine et al., 2002; Schuller and Radtke-Schuller, 1990).

The functional organization of the SC reflects the relative importance of a sensory modality to an animal’s species–specific behaviors. Comparative animal studies indicate a role for the SC in the saccadic eye movements (Robinson, 1972; Sparks, 2002), smooth–pursuit eye movements (Krauzlis, 2004) and vergence eye movements (Gnadt and Beyer,

1998;Chaturvedi and Van Gisbergen, 1999) in monkeys, the control of the head, eyes, and pinnae in cat (Guitton and Munoz, 1991;Stein and Meredith, 1993) and in orienting and evasive behaviors in the rat (Dean et al., 1989). Other studies have identified specializations of the optic tectum (OT, the non-mammalian homolog to the SC) that support head turning in barn owl (du and Knudsen, 1990), and a role in snapping and body and head turning behaviors in frog (Ewert, 1997), head orienting in rattlesnakes (Hartline et al., 1978;Dacey and Ulinski, 1986), and tail, head, and eye movements in goldfish (Herrero et al., 1998). The SC's role in controlling orienting behaviors is mediated by a number of pathways to brainstem nuclei that transform SC commands and in turn project to motoneurons (Masino and Knudsen, 1990;Moschovakis et al., 1996).

Echolocating bats comprise approximately one-fourth of all extant mammalian species (Jones et al., 2002). They are extremely successful aerial predators that have evolved a biological sonar system. This system allows bats to orient and forage in three-dimensional space in total darkness. Bats orient in space by coordinating flight dynamics, head movements and sonar vocalizations (Griffin et al., 1960). The diminished role of the vision in the orienting behavior of insectivorous echolocating bats is supported by various reports in the literature. Experiments on the visuo-motor system in echolocating bats describe solely head orienting movements to visual stimuli (Suthers, 1966;Suthers et al., 1969). In addition, Walls (Walls, 1963) states that microchiropteran bats do not move their eyes, even reflexively, and no morphologically distinct foveal region has been identified in the retina (Neuweiler, 1993).

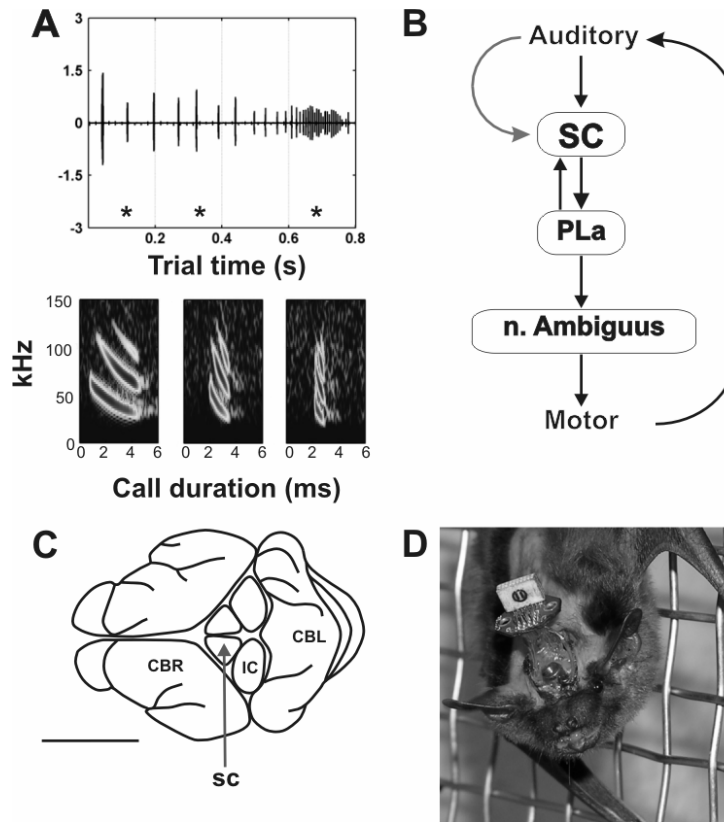

Figure 9 Sonar vocal behavior, neural circuitry, and experimental subjects.

A) Time waveform and selected spectrograms of a sequence of sonar vocalizations produced by a flying bat attacking a stationary insect target. Typical of an insect pursuit sequence there are dynamic changes in the sonar pulse intervals as bats approach and capture a target (top panel). The representative spectrograms demonstrate the change in bandwidth, call duration, and sweep rate during insect capture (bottom panel). Asterisks (*) are positioned below calls for which spectrograms are shown. **B)** Network of input–output pathways that connect the SC with the sonar vocal production circuitry. Lemniscal (black arrow, top) and paralemniscal (gray arrow, at side) auditory inputs are integrated in the SC, which in turn projects to the laryngeal motoneurons indirectly via a tecto–tegmento–bulbar pathway. **C)** Top-view drawing of the bat brain showing the dorsomedial position and relative size of the superior colliculus compared with adjacent structures. Scale bar is 5 mm. **D)** Photograph of a 15-gram bat with chronic implant prior to recording session. The small interface board mates with a head–stage board has amplifiers incorporated.

These factors together with the small number of retinal ganglion cells (RGC) (when compared to other mammals), the low RGC density (Pettigrew et al., 1988) all suggest the use of vision is limited.

Bats actively produce ultrasonic vocalizations and use the information contained in the returning echoes to determine the position, size and other features of sonar targets (Simmons, 1973; Simmons et al., 1988; Simmons et al., 1990; Moss and Schnitzler H-U, 1995). The timing, duration, frequency content, and intensity of the sonar signals employed by bats effectively determines the acoustic information available to its acoustic imaging system (Simmons et al., 1975; Simmons and Stein, 1980).

Each species of bat has a distinct repertoire of signals that it uses for echolocation. In this study we used an insectivorous bat from the Vespertilionidae family, *Eptesicus fuscus*. Foraging bats adjust the timing and the features of their sonar vocalizations as they search for, approach, and intercept a target. The characteristics of their sonar vocalizations have been used to divide the bat's insect pursuit sequence into three different phases (Griffin et al., 1960). During the search phase, signals produced by *Eptesicus fuscus* are characterized by narrowband FM sweeps, with durations of 15–20 ms at a repetition rate of 5–10 Hz. Bats foraging in open spaces with little clutter primarily produce these calls. Once *E. fuscus* detects a prey item, it produces approach phase signals that are broadband, multi-harmonic FM, with shorter durations (2–5ms) at a repetition rate of 20–80 Hz. In the final phase of capture, terminal buzz, signals shorten

further in duration (0.5–1ms), are produced at even higher repetition rates (150–200 Hz), and show a drop in sound frequency to below 20 kHz (Surlykke and Moss, 2000). This dynamic variation in the vocal production patterns of bats hunting insects is demonstrative of a context–dependent change in vocal behavior during hunting.

The adaptive vocal behavior observed in bats is shaped by audio–vocal feedback, and functional specializations in the SC may support orienting by sonar. Evidence derived from anatomical and physiological studies suggests that the SC of bats links auditory spatial localization with motor pathways for acoustic orienting (Figure 9B,C) (Shimozawa et al., 1984; Wong, 1984; Covey et al., 1987; Casseday et al., 1989; Sinha et al., 2000). Biologically relevant specializations are observed both in sensory responses and motor behaviors of this bat species. On the sensory side, two populations of spatially selective auditory neurons have been identified. One population shows selectivity to auditory stimuli in both azimuth and elevation (2–D neurons) (Shimozawa et al., 1984; Jen et al., 1993; Valentine and Moss, 1997; Reimer, 1991). The second population (3–D neurons) shows spatial selectivity to azimuth, elevation, and echo delay, the bat’s cue for target range (Valentine and Moss, 1997). Electrical and chemical microstimulation experiments in the SC of *Eptesicus fuscus* elicits sonar vocalizations, as well as head and pinna movements (Valentine et al., 2002). The sonar vocalizations elicited using electrical stimulation resemble those produced by the bat in the approach phase of insect pursuit, i.e. 2–5 ms duration, > 30 kHz bandwidth of fundamental, with multiple harmonics. By parametrically varying the electrical microstimulation parameters, changes in vocal repetition rate, and the total number of vocalizations can be

elicited. Chemical stimulation with non-lesion, low-volume injections of kainic acid elicit a broader range of sonar calls, all identical to calls these bats naturally produce when freely echolocating. Similar findings have been reported using microstimulation techniques in the SC of an old world bat species, *Rhinolophous rouxi* (Schuller and Radtke-Schuller, 1990). Control experiments in which the adjacent periaqueductal grey (PAG) was stimulated failed to produce sonar calls but instead elicited long duration, lower frequency signals characteristic of communication calls (Valentine et al., 2002). These experiments demonstrated that SC stimulation could trigger sonar calls, and affect the number of calls produced, call duration, and repetition rate.

Based on the role of the SC in orienting, and the specializations identified in the bat SC, we investigated the functional relationship between SC neuronal activity and sonar vocal production in freely echolocating bats. To accomplish this we developed chronic neuronal recording techniques for use in unrestrained and freely behaving bats (Figure 9D). We focused on interactions between the temporal parameters of sonar calls and SC neuronal activity and specifically set out to: 1) identify whether pre-motor neural activity was present in the SC and correlated with sonar vocalizations, 2) determine relationships between observed vocal pre-motor activity and sonar vocal parameters, and 3) ascertain whether the time-scales over which echolocation behaviors operate are related to the time-scales over which neuronal computations take place.

Two behavioral experiments were designed to engage the bat in echolocation behavior, both of which permitted the bat to remain at rest while performing in a target-capture or undirected echolocation task. In the goal-directed echolocation task, bats used

echolocation to track and capture a tethered edible target that swung on a pendulum toward and away from the bat. This task evoked vocal behavior similar to that produced by bats engaged in insect capture and elicited from each bat a wide range of sonar call parameters very similar to that observed during the approach and terminal phase of natural insect pursuit. In the undirected task bats were trained to spontaneously produce sonar calls, while listening to attenuated and delayed playbacks of their sonar calls. Data from both these behavioral paradigms were compared with vocal behavior during free flight insect capture behavior recorded in a laboratory flight room.

It is reported here that neuronal activity in the bat SC is temporally coupled to sonar vocal onset, that the firing pattern of pre-motor events occurs in two discrete bouts, which has been termed as short lead events (SLE) and long lead events (LLE). The SLE show tight coupling to vocal onset and the timing of LLE appears related to sonar call duration. Brief preliminary results have been reported (Sinha and Moss, 2004).

Methods

Animals. Adult insectivorous bats (*Eptesicus fuscus*) ranging from 13–18 grams were collected from the wild and housed in a bat vivarium at the University of Maryland. Bats were housed under constant 12:12 hour, light:dark conditions and given food and water ad libitum. The Institutional Animal Care and Use Committee at the University of Maryland approved all the procedures described here.

Surgery. Bats were anesthetized with isoflurane gas (2–3 % / 700 cc / min O₂, NLS Animal Health). The muscles of mastication overlying the skull were undermined and deflected from the midline exposing the skull surface. A stainless steel skull screw (Fine Science Tools, Inc.), inserted rostral to the cortex approximately over the olfactory bulb region, was then secured for use as an animal ground. A craniotomy was performed over one superior colliculus, exposing the duramater. A custom, light-weight (< 0.5 g), 16-channel electrode interface board (EIB) (Neuralynx, Tuscon, AZ) was positioned over the craniotomy site. The implant was constructed of two to nine, 30-gauge stainless steel cannula, soldered in a 3x3 matrix configuration to the EIB, with the cannula tips angled (20°) toward the central cannula. Adjacent electrodes were spaced 350µm apart at the level of the EIB board. The EIB was a printed circuit board with no electronics, and with a 20-pin Omnetics connector (Omnetics, Corp.) for mating during experiments to an active head-stage board. All cannula were insulated externally, served as extra-cranial guide tubes, and functioned as a means of electrical contact between the electrodes and the EIB. All but one cannula was loaded with 75µm diameter platinum/iridium wire recording electrodes (1.0–3.0 MΩ) (Microprobe, Inc., Bethesda, MD). The remaining cannula was loaded with a 1.0 kΩ platinum\iridium reference electrode. The EIB was positioned with a three-stage micromanipulator over the craniotomy site, and the exposed dura was covered with biomedical grade Silastic (Dow Corning). This prevented dental cement or cyanoacrylate from contacting the brain. The EIB was secured to the skull with cement or medical grade cyanoacrylate (Loctite 4113, CT). A fine insulated, 32-gauge insulated wire attached to the skull screw, was then secured to the implant and served as animal ground.

Histology. Bats were deeply anesthetized with sodium pentobarbital (0.04 ml/bat, intraperitoneal). Intracardial perfusion with saline was followed by a 4% buffered paraformaldehyde fixative and the brain tissue removed from the skull and blocked. The brains were subsequently stored in sodium phosphate buffered saline (PBS) (0.1M; pH=7.2) with 30% sucrose overnight, sectioned at 40 μ m on a sliding freezing microtome, mounted and Nissl stained. Electrode tracts were reconstructed based on this material.

Free Flight Experiments. In free flight experiments (Figure 10A) *Eptesicus fuscus* were trained to capture tethered whole mealworms (*Tenebrio molitor*) in a large flight room (6.4 x 7.3 x 2.5 m) lined with acoustical foam (Sonex). Their vocalization behaviors were studied under open-space and clutter conditions. In the open-space condition, no obstacles were in the vicinity (within 1 m) of the insect target; however, the walls, ceiling, and floor of the flight room prevent us from creating a truly open space environment. Experiments were carried out using only long-wavelength lighting (>650 nm) by using filters (Plexiglas #2711, Reed Plastics, MD and Bogen Filter #182). This eliminated wavelengths of light that this bat species is sensitive to (<650 nm) (Hope and Bhatnagar, 1979b). Mealworms were suspended at a height of about 1.5 m above the floor by monofilament line (Trilene Ultra Thin, 0.1 mm diameter) within a 5.3 m target area in the center of the room. A mealworm was suspended at a randomly selected location within the target area, and then the bat was released in a random direction to orient to the target area and find the mealworm. So that the bat would not memorize the target area, the mealworm was suspended outside the target area 50% of the time, and

those trials were not recorded. Once each bat achieved a consistent capture rate of nearly 100% in open-space conditions (typically within 2 weeks of introduction to the task), audio and video recordings were recorded in order to quantify the features of the sonar vocalizations and how these features were related to target distance.

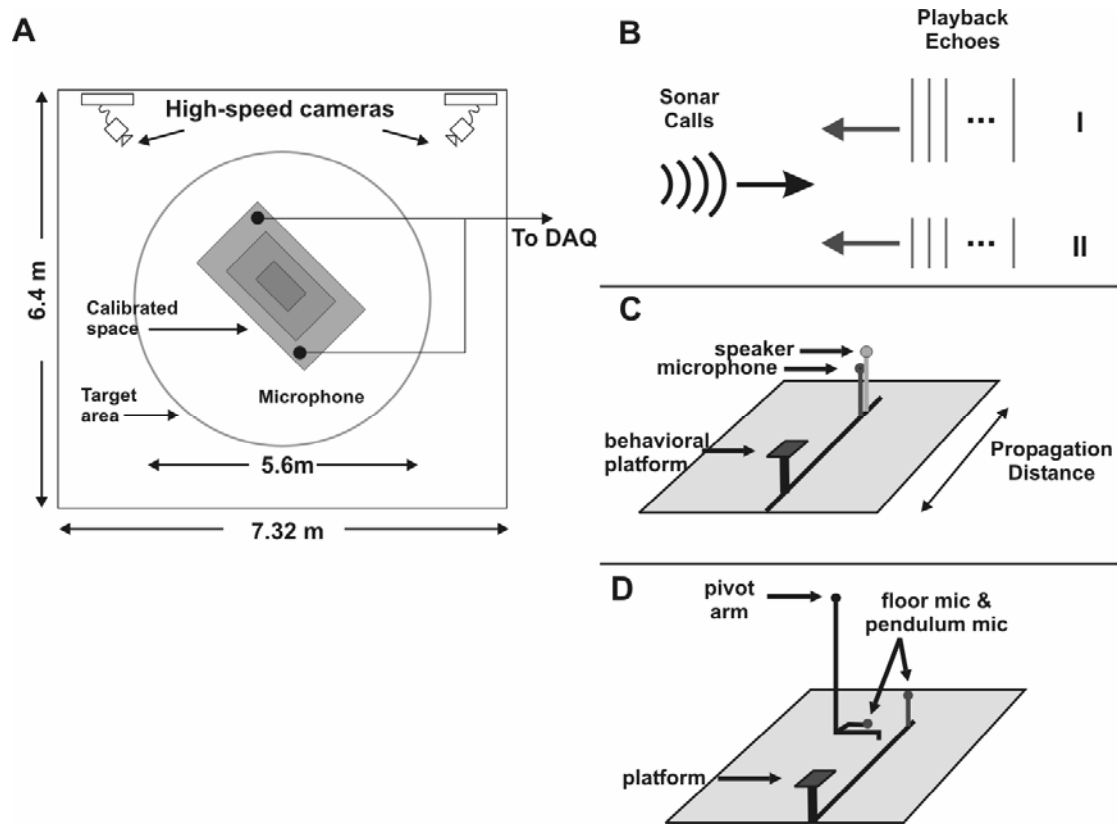

Figure 10 Experimental design for the flight room experiments and the two different behavioral paradigms used for chronic recordings.

A) Top-view of the flight room, showing position of high-speed cameras (240 frames/s). Bats are permitted to fly within the entire room, but the edible target is only hung within the target area. **B)** During trials sonar calls produced by a bat are acquired, modified to simulate sonar echoes, and played back to the bat. Playback echoes are either from a loud intensity group (I) or a soft intensity group (II). The delays of the playback echoes are randomly chosen during the trial from a limited range of values. **C)** Schematic of the echo playback set-up. Bats rest on a behavioral platform and produce sonar vocalizations directed toward an ultrasonic microphone. The signals are modified by a computer and played back to the bat via a speaker positioned above and behind the microphone. **D)** Schematic of the oscillating target set-up. Bats are trained to rest on a platform and use echolocation to track and capture a moving target. The target, positioned on a horizontal arm connected to a vertical pendulum, swings in a single plane intersecting the bat's position.

Video recordings were made with two gen-locked (frame synchronized), high-speed video cameras (Kodak MotionCorder, 640x240 pixels, 240 Hz frame rate, and 1/240-s shutter speed) were positioned just below the ceiling in the corners of the flight room. A calibration frame (Peak Performance Technologies) was placed in the center of the room and filmed by both cameras prior to each recording session. The high-speed video cameras were used to record target position, bat flight path and capture behavior. The resulting images were used in calculation of the three-dimensional positions of the bat, target, and microphones. The video buffer contained 1963 frames, allowing for recording of 8.18 s of data at 240 frames/s. Using an end-trigger on the video, we captured the behavior leading up to and just following successful and unsuccessful insect captures.

Echolocation signals were recorded using two ultrasonic transducers (Ultrasound Advice) placed within the calibrated space. Microphone signals were amplified, bandpass filtered (10–99 kHz, 40-dB gain, Stewart, VBF-7) and recorded digitally on 2 channels of an IoTech Wavebook 512 at a sample rate of 240 kHz/channel. The Wavebook, controlled by a laptop computer (Dell Inspiron 7000), was set to record 8.18 s prior to the trigger; the trigger was set to simultaneously stop the audio and video acquisition. The experimenter triggered the system on each trial after the insect capture was attempted and/or accomplished.

Platform Experiments. Two types of behavioral platform experiments were conducted: echo playback (EPB) and oscillating target (OscT). In both behavioral paradigms bats

were trained to rest on a platform, and remain oriented towards a sound stimulus or target in front of them while freely echolocating. Each behavioral design permitted tethered chronic neuronal recordings. To attain a consistent level of performance one to three weeks of training was required for each animal, with daily sessions to maintain performance. Sonar vocalizations and neuronal activity were simultaneously recorded in both paradigms. On a subset of echo playback trials video recordings of head & pinna movements were recorded. In every experiment low-level, long wavelength lighting, outside the spectral sensitivity range of this bat species was used to eliminate visual cues (Hope and Bhatnagar, 1979b).

In both behavioral paradigms vocal and neural data were recorded digitally and stored to a computer hard disk. All recording devices were synchronously triggered using one master trigger operated by the experimenter. When video recordings were made, the master trigger also controlled acquisition of video recordings. Echo playback experiments were conducted in a double-walled acoustic booth. The room interior was lined with acoustic foam to minimize sound reflection. Oscillating target experiments were conducted in a large, carpeted, laboratory flight room (6.4 x 7.3 x 2.5 m), with ceilings and walls lined with acoustic foam. All large objects were covered with felt cloth to dampen echo returns. Neural recordings methods were identical in the two paradigms and are described at the end of the methods section.

Echo Playback Paradigm. Bats use the time delay between their sonar vocalizations and returning echoes, to determine an object's distance (Hartridge, 1945; Simmons, 1973).

Bats accept as "echoes" computer-generated playback sounds, triggered by the bat's vocalization, and delivered at a specified delay within the operating range of the bat's sonar (echo delays up to 30 ms, corresponding to ~5m distance). Bats seem to perceive these "echoes" as targets at a distance corresponding to the playback delay (Simmons, 1973). These phantom, or virtual, targets can be computer-generated, and thus useful because all features of the echo waveform can be kept constant while manipulating only a single variable (Moss and Schnitzler H-U, 1995).

This experiment used a virtual target playback system. Bats were trained to rest on an elevated platform and produce sonar vocalizations. A horizontally oriented Ultrasound Advice condenser microphone placed 105 cm in front of the bat and in line with the bat's position picked up the bat's sonar vocalizations (Figure 10B,C). The bat's echolocation sounds were hardware filtered (20–99 kHz, due to practical limitations in computer processing), digitized, electronically delayed, attenuated, band-pass filtered (20–99 kHz), and broadcast back to the bat through a custom electrostatic speaker, with flat (± 5 dB) frequency response between 30–100 kHz. The loudspeaker was positioned in front of, and just above, the microphone, to eliminate feedback.

Sonar echoes also return from the microphone, speaker and other objects in the room. In previous experiments using this system, bats have reached behavioral criterion level in phantom echo tasks (Moss and Schnitzler H-U, 1995), suggesting that the bat can learn to respond to electronically delayed sonar signals as target echoes. Steps were

taken to temporally isolate playback echoes from echoes arising from real objects in the recording chamber.

Echo Playback Behavior. The primary aim of this task was to engage the bat in echolocation behavior, and permit the recording of pre-motor activity associated with vocalizations. Therefore, bats were trained in a two alternative forced-choice echo discrimination task. Bats were trained to rest on a platform, produce sonar vocalizations, and attend to virtual playback echoes presented from the centrally placed speaker. They were trained to report ‘loud’ echoes by turning to the right, and trained to report ‘soft’ echoes by turning to the left. Correct responses were rewarded with food. Head aim was tracked (see below) during training, and training trials were aborted if head aim deviated by more than 10° from the centrally placed speaker. Training continued until head movements were less than 10° from center. Each trial consisted of twenty to thirty vocalizations and their corresponding playback echoes. At the end of a trial, playback echoes were terminated and bats were required to make a decision.

Trials with ‘loud’ and ‘soft’ echoes were randomly interleaved. In trials with ‘loud’ echoes, vocalizations were attenuated by 5 dB SPL and trials with ‘soft’ echoes had sonar calls attenuated by 20 dB SPL. In each individual trial, playback signals were either from the ‘loud’ or the ‘soft’ group. The amplitude range of the playbacks fall in the range of behaviorally relevant echo amplitudes for bats (Moss and Schnitzler H-U, 1995). For every vocalization the bat received playback echoes with a small range of delays (1–5 ms). The playback echo values (~6 ms for time-of-flight plus the added

delay of 1–5 ms) were within the range of behaviorally relevant echo delays (4–30 ms; Moss and Schnitzler H-U, 1995). Sonar vocalizations and playback echoes were visually monitored on a digital oscilloscope during sessions. Given the directional sensitivity of the microphones used, and the threshold for triggering of the echo playback system, head aim that deviated by more than $\sim 10^\circ$ failed to trigger the playback system. While monitoring the oscilloscope, if bats vocalized and playbacks were not returned, trials were aborted. For video tracking of head aim an infrared sensitive high-speed video camera (Redlake) was mounted 0.5 m above the bat with a zoom lens to record close-ups of head and pinna movements in the horizontal plane. Video recordings were made of infrared reflective markers positioned on the bat's head (two markers), body (two markers), and pinna (two markers each ear) while on the behavioral platform. These reflective markers were easily distinguished from background in video images. Video data was recorded at rates of 250 Hz (1 frame/4 ms), and immediately transferred to tape. Due to the limitations of our data storage device, video recordings were only made of a subset of trials in a session. Data was analyzed for trials in which bats were on task and all markers were visible. Segments overlapping with and without sonar vocalizations were appropriately marked for later analysis. Custom video analysis software (Matlab, Mathworks, Inc.) was used to track marker positions.

Echo Playback Behavioral Analysis. All sonar vocalizations were analyzed using custom sound analysis software written in Matlab (MathWorks, Inc.). The start and end frequencies, duration, bandwidth, repetition rate, and pulse interval of the fundamental component of the sonar call was manually measured. On trials where video recordings

were made of the head and pinna, trial segments were identified in which all markers were clearly visible. For these segments all six markers were manually digitized. Three measures were used and calculated from the video marker data: angular rotation, angular velocity and angular acceleration, all relative to the body. Data was smoothed using an 8–point sliding window average, to eliminate video marker tracking errors introduced by manual estimation. Segments of video data around the time of occurrence of sonar vocalizations were analyzed to determine possible temporal relationships with sonar calls. Each bat was analyzed separately. For each measure individually, all video segments from a single trial were first aligned by the vocal onset time, and then normalized by calculating the z–score, for all the data, at each time point, preceding and after the sonar call onset, in a time–interval spanning [-80ms,+80ms]. Other time spans were also tested. Trials with periods of inactivity and abortive movements were examined but excluded from summary records. All digitized video segments of head and pinna movements were analyzed with custom video analysis software also written in Matlab (MathWorks, Inc.).

Oscillating Target System. The repertoire of sonar vocalizations in playback experiments is limited and less structured in comparison to those observed in natural settings (Surlykke and Moss, 2000) or in the laboratory flight room. The oscillating target paradigm permits bats to rest on an elevated platform (95cm above ground), while using echolocation to track and capture a moving target, and allow tethered, chronic neural recordings (Figure 2D). Bats were trained to rest on a platform and capture a moving edible target. Mealworms (*Tenebrio molitor*) were used as the edible targets, were pierced with a

sewing needle and held loosely tethered on a 0.2 mm diameter, 5cm long, nylon line. The nylon line was hooked at one end and attached to the sewing needle. The needle was attached to a small diameter (0.3 cm) 54 cm steel arm, connected to a vertically hanging, pendulum arm (170 cm) (Figure 10D). This arrangement ensured that the needle was held securely on the arm, but the nylon line could easily be dislodged if the bat pulled on the target. The target moved along an arc, and the platform position was adjusted to ensure the target intersected the bat's position on the platform. Only at this position was the bat able to capture the food reward. Neural data was continuously recorded during the session. Vocal data was recorded in 10s blocks around the target oscillation time. These 10s blocks constituted the trials. Fifteen to thirty trials were run for each recording session.

Target position relative to the bat was determined using two microphones (Ultrasound Advice). One microphone remained stationary, approximately 250cm in front of the bat, and 40 cm above the ground, referred to as the floor microphone. The second microphone, referred to as the pendulum microphone, was mounted on the swinging pendulum arm, 10cm behind the target and 30cm to the side of the target, closer to the pendulum arm (Figure 10D), and oriented toward the platform. Both microphone signals were simultaneously recorded with a National Instruments 6110 data acquisition card (National Instruments, Austin, TX) at 500 kHz/channel, using custom software written in the C programming language.

Oscillating Target Sonar Analysis. Sonar vocalizations were quantified for each trial. Trials with periods of vocal inactivity and abortive movements were examined but excluded from summary records. Off-line vocal data analysis was performed on the data from the stationary floor microphone. The data was filtered (10kHz–100kHz), rectified, and convolved with a square window (0.5ms). Times that exceeded a set threshold were identified as sonar calls. The threshold was determined as 5x the standard deviation above the mean of a non-vocalization period. Threshold crossings were used to calculate the onset and offset time, duration, repetition rate, and pulse interval of sonar vocalizations within each trial. The recorded vocal signals from the floor microphone were analyzed to determine the start and end frequencies on a subset of trials. Sound analysis was completed using custom sound analysis software written in Matlab (MathWorks, Inc.).

Oscillating Target Position Analysis. Vocal signals from the two microphone channels were filtered (10kHz–100kHz) and cross-correlated. The time-lag at the maximum peak in the cross-correlation was used to estimate the separation distance between the two microphones. On every recording day, calibration measurements were made to determine the relative separations of the oscillating target apparatus. These measurements were used to determine the range of angles the pendulum moved through and the distance to the platform at each point in its swing. From this information and the time delay between the microphones when a vocalization was recorded the distance from the target to bat at the time of vocalization was established.

EMG Recordings. Teflon-coated silver wires (0.12 mm external diameter; Medwire, Co.) were threaded through 30-gauge hypodermic needles, with the ends fashioned into hooks, which protruded from the sharp ends of the needles. Pairs of wires were inserted close together into the muscles of mastication. The wires were placed so that they were close to the SC and above the mid-sagittal sinus. The wires were secured in place using tissue adhesive, and the protruding exposed ends of the wires soldered to gold pins. When recording EMG activity the gold pins were connected to a DAM 80 amplifier (World Precision, Inc), filtered (1Hz–3000Hz), amplified (x 5,000), and the data recorded to computer via a National Instruments 6110 DAQ card for later analysis. For the sonar vocal data, vocal signals were recorded using a Ultrasound Advice microphone, filtered (10kHz–99kHz), amplified (x2–5), and simultaneously recorded with the EMG data on a separate channel of the National Instruments card. The NI DAQ card sampled each channel at 300 kHz. Vocalizations were analyzed as described above. EMG data was analyzed the same manner as neural (described below).

Neural Data Collection. Bats were allowed to recover for several days after surgery before being returned to the behavioral apparatus for recording. On recording days a head-stage board (20mm x 10mm, < 1g) (HS-16M, Neuralynx, AZ) with unity-gain buffers was connected to the implanted EIB. A light-weight, 38-gauge wire tether conveyed a maximum of 16 neural channels to a Cheetah 32 Digital Interface data acquisition system (Neuralynx, AZ). After amplification (5,000–10,000x), and band-pass filtering (0.001–6) kHz, neural activity was recorded continuously along with synchronizing signals by the Neuralynx system. Electrodes were advanced at least 12 hours prior to recording

sessions, and were advanced by (75 μ m –100 μ m) between recording sessions. For each session a new site was recorded from. Recording sessions lasted 30–50 minutes, during which time the bats remained connected. Movement of the bats was not encumbered by the head–stage and tether assembly as they performed in behavioral experiments. After each session, data were archived to CDs, and analyzed off–line.

Data Analysis. For all off–line analysis custom software for use in Matlab (Mathworks, Inc.) was written. The continuously recorded wide–band signals were high–pass filtered (300Hz–6 kHz) digitally. The power (root mean square) of the filtered signal was computed in a sliding window (0.25 msec) for event detection (Bankman et al., 1993). The standard deviation (SD) was calculated to estimate the variance of the baseline noise and to establish a detection threshold. Events were defined as deflections of the continuously sampled voltage records exceeding an event criterion threshold. Events with power of more than two times the SD from the baseline mean were extracted as ‘spikes’. If the power remained above threshold for more than 3 ms the events were rejected. Event waveforms that were not biphasic were rejected. Background periods of activity were measured in a 1 second, non–vocalizing, period preceding the start of a session and the start of selected trials. This was used as a measure of the background event rate. Neural and vocal data were aligned, and epochs of time (generally 60ms before to 20 ms after sonar vocal onset) around each sonar vocalization were inspected for events. Raster plots and PETH (Peri–Event Time Histograms) were constructed for display purposes. PETH were constructed with 1ms and 2ms bin widths. No difference in the PETH pattern was qualitatively observed so 2ms bins were subsequently used.

Bins were identified in which the number of events were above a trial criterion threshold. This trial threshold was set at mean + 2SD above the background event rate. Other trial criterion thresholds were tested (1,3,4 SD) but changed the calculated measures little. Events in bins that exceeded the trial threshold were used for subsequent analyses. Events within over-threshold bins were analyzed using three measures: mean firing rates, the standard deviation of the event times preceding a sonar call, and timing of events relative to sonar vocalizations.

Results

Sonar Vocal Behavior

Insectivorous bats of the species *Eptesicus fuscus* produce sonar vocalizations with a wide range of signal features. When free flying bats attack stationary tethered mealworms in laboratory flight room (6.4 x 7.3 x 2.5 m) (Figure 10A) the variation in sonar features is strongly related to target distance (Figure 11A, left column). [The free flight data was kindly provided by Ms. Chen Chiu]. The flight path and sonar call features used by the bat are representative of the bat's natural behavioral strategy. The dimensions of the room may act to restrict the range of vocalizations features produced by the bat largely by limiting the duration of search calls to 5–6 ms. The data presented in Figure 11A are taken from 14 separate attack sequence trials recorded from four different bats. Figure 11A (top panel) shows the variation in sonar call duration with target distance. The duration decreases approximately linearly with target distance. Bats in the flight room generally do not fly directly toward a target (Figure 11B). Instead, they display a curved intercept flight path with sometimes abrupt changes in distance, and this may account for the curvature observed in the relationship between call duration and distance. The relationship between the pulse interval (PI, the time between the onset of consecutive calls) and the target distance is shown in Figure 11A (bottom panel). The PI, shown on a log₁₀ scale, has a much larger range of values than duration, and shows three different stages, which can be distinguished by a range of PIs used for a given distance. First, for the largest PIs, there is only a weak relationship with distance, which may reflect the case in which the bat is searching for the target.

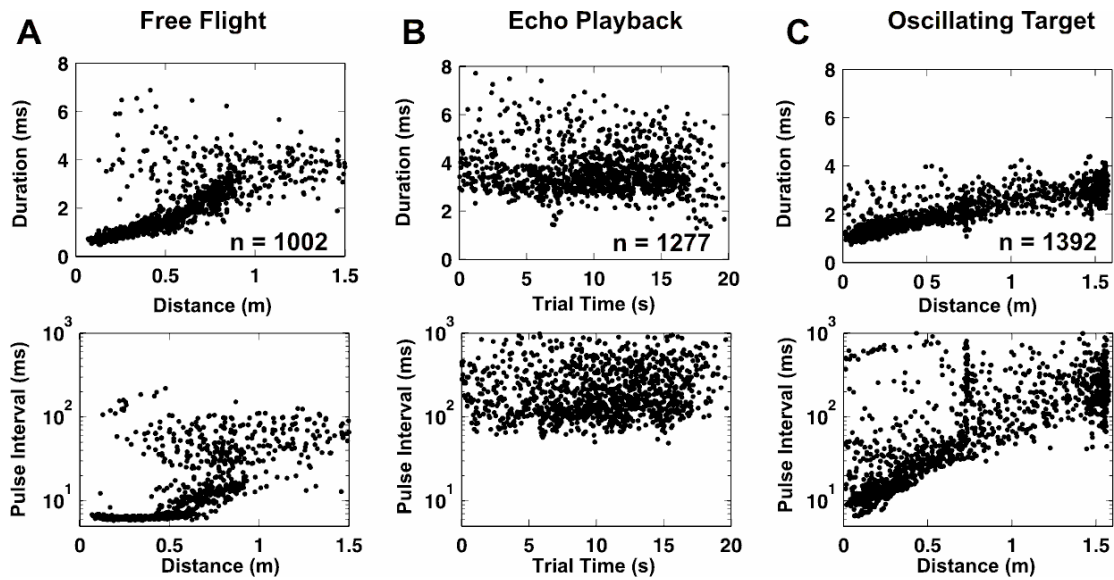

Figure 11 The temporal characteristics of sonar vocal sequences in different behavioral scenarios.

The sonar call duration and pulse interval are shown as a function of target distance or trial time. **A)** Data from two free flying bats attacking a stationary edible target. The call duration (top panel) and pulse interval (bottom panel) of the sonar calls as a function of target distance show distinctive characteristics. **B)** During a non-pursuit directed echo playback experiment, call duration and pulse interval vary widely in a non-patterned fashion over the course of each trial. **C)** In pursuit directed oscillating target trials, during which bats remain stationary and a target oscillates, duration and pulse interval vary closely with target distance. Data in A–C are comprised of sonar calls, from all trials, during one session. The total number of calls for each plot is shown in the top panels.

Next, an intermediate stage is marked by a consistent decrease in PI with decreasing target distance (0.5m – 1.0m). The last stage has the smallest PIs (5–8 ms) and occurs over the shortest distances (0.0m – 0.5m), as the bat closes to capture the target. Overall bats decrease their sonar call duration in a linear fashion and decrease their PI in an approximately exponential manner, when approaching a stationary target in free flight.

In contrast to the dynamic pattern shown for the free flight case, the variation in sonar vocal parameters is more restricted in the echo playback condition (Figure 11B). The data come from 30 trials, from two bats, with trial lengths varying from 6–20 seconds. The range of sonar call durations is more limited across trials in this condition, and is more similar to the longer duration calls used in the free flight case. Additionally, bats use much larger PIs here than in the free flight case, by approximately an order of magnitude. Both the sonar call duration and PI are comparatively constant within each trial, with no overall pattern of variation observed across trials.

The vocal behaviors during the oscillating target experiments (Figure 11C) show both similarities and differences to that observed in the free flight scenario. Similar to the free flight case sonar call duration decreases steadily with target distance, and spans a similar range of call durations over the range of target distances studied (0m – 1.6m). In contrast to the free flight case, the rate of change of call duration with target distance is smaller, and the PI produced by the bat spanned a 10x larger range of values. In addition, the target distance and PI in oscillating target

experiments showed an exponential relationship across a wide range of target distances investigated (Figure 11A, bottom). The extended period of short PI observed at short distances in the free flight case is not evident in the oscillating target trials except at the very shortest distances (< 0.2 m), although the bat employed a similar range of short PIs. The differences in vocal behavior between conditions may be a result of the predictable fixed path of the oscillating target tracked by the stationary bat, in contrast to the stationary target and variable flight paths used by bats in the free flight situation.

Representative data from one oscillating target trial (Figure 12A) shows target distance and call duration over the course of a single trial, and demonstrates the changes in vocal call duration and PI used when the bat tracked the target. In the beginning of the trial the target is held at the start position and the bat consistently uses longer duration calls. When the target was released the bat steadily decreased the call duration it produced, called only a few times when the target receded, and again used a sequence of decreasing call durations during the second approach. This variation in call duration is exponentially related with changes in PI (Figure 12B), evident in the linear relationship in the log–linear plot, and shows the co–variation in these parameters as the target distance decreases.

Thus, the dynamic target–oriented vocal behavior during the oscillating target paradigm closely resembles the vocal behavior observed during free flight insect capture. In both experiments duration and PI co–vary as a function of target distance.

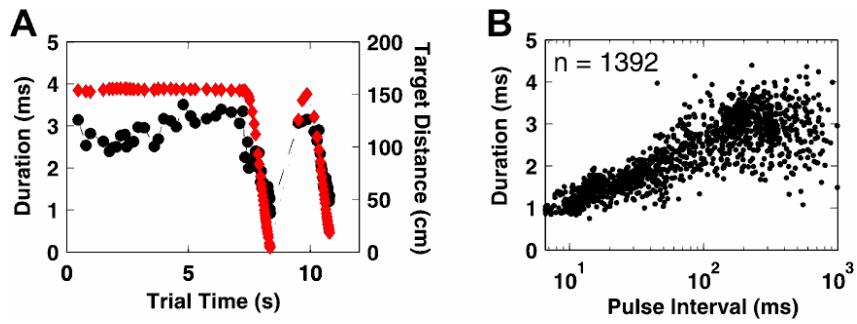

Figure 12 Variation in sonar call durations with target distance and pulse interval in an oscillating target trial.

A) The close coupling between sonar call duration and target distance is highlighted in an oscillating target trial. Target distance (red diamonds) and call durations (black circles) are shown as a function of trial time (12 seconds). Sonar call duration versus pulse interval for all 1392 calls in Figure 11C. **B)** Pulse interval varies over a wide range during both oscillating target and free flight trial conditions. The exponential relationship between call duration and PI is made clear in this log–linear plot.

In contrast, the vocal behavior during the non-target directed echo playback paradigm does not show the dynamic variation in call parameters seen in the free flight case. Instead the call parameters were closer to those employed when the bat was at greater distances relative to the target, and it was potentially still searching for the target.

Pre-motor activity in the Superior Colliculus

Bats in the echo playback (EPB) experiments were trained to spontaneously vocalize, and for each sonar vocalization produced they were presented with an attenuated, delayed playback of that sonar call (see Methods). Bats emitted species-specific downward sweeping, multi-harmonic, short duration sonar vocalizations when using echolocation in the task (Figure 13A). When analyzing SC neural activity, neural activity was consistently observed preceding the onset of sonar vocalizations (Figure 13 B–C, red vertical ticks). Figure 13B shows a filtered (300–3000) Hz, five-second neural trace showing peaks in pre-motor activity close to sonar call onsets (indicated by red ticks). Figure 13C shows the same neural trace as in Figure 13B, with the data rectified and smoothed and demonstrates the near one-to-one correspondence between the SC neural activity and the sonar vocalizations. Neuronal activity recorded in the SC during this task was characterized by a low mean baseline event rate (20 ± 17 events/s, $n=10$ sites, two bats).

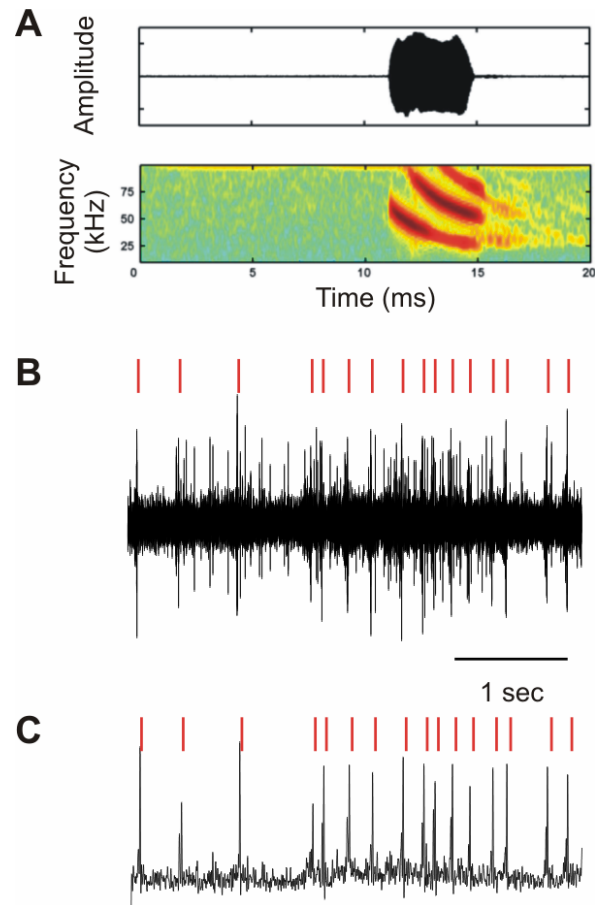

Figure 13 Bat sonar call time waveform, power spectrogram, and time aligned pre-motor neural activity with sonar vocalizations in the SC.

A) Time waveform and spectrogram of a single 3.8 ms duration sonar vocalization produced during an echo playback experiment. **B)** Simultaneously recorded neural activity in the SC. Bouts of neural activity in the superior colliculus consistently precedes sonar vocalizations. Red ticks in B and C are identically placed, and represent the onset of sonar vocalizations. **C)** Rectified waveform of the neural activity in B low-pass filtered (< 100 Hz) with an eighth-order Butterworth filter.

In Figure 14A,B a representative raster and peri-event time histogram (PETH) from a single EPB trial is shown. The plots were constructed by aligning the peri-vocal events relative to sonar call onsets ($t=0$). Raster plots represent consecutive sonar calls from the start to end of a trial. The pre-motor activity is characterized by two brief bouts of activity that are comprised of long lead events (LLE) and short lead events (SLE), separated by a brief return to near baseline event rates. This bimodal distribution in event lead times prompted us to evaluate the two groups of events separately (Figure 14B). The plots in Figure 14A,B illustrate the increase in event rate preceding call onsets, the distinct reduction in event rate between LLE and SLE, and the return to baseline event rates before or shortly after call onset (< 1 ms), which is evident at all our recording sites ($n=44$). Relative to the SLE, the LLE occurs over a larger range of lead times $[-40.6, -8.4]$ ms (10th–90th percentile), have a mean lead time of -22.2 ± 3.9 ms (mean \pm SD) ($n=10$ sites, 2277 calls, two bats). The SLE, by contrast, have a smaller range of lead times, $[-5.1, -2.2]$ ms (10th–90th percentile), a mean lead time of -3.6 ± 0.7 ms, and are precisely time-locked to the call onset ($n=10$ sites, 2277 calls, two bats). These events consistently occur prior to sonar vocalizations (Table 1).

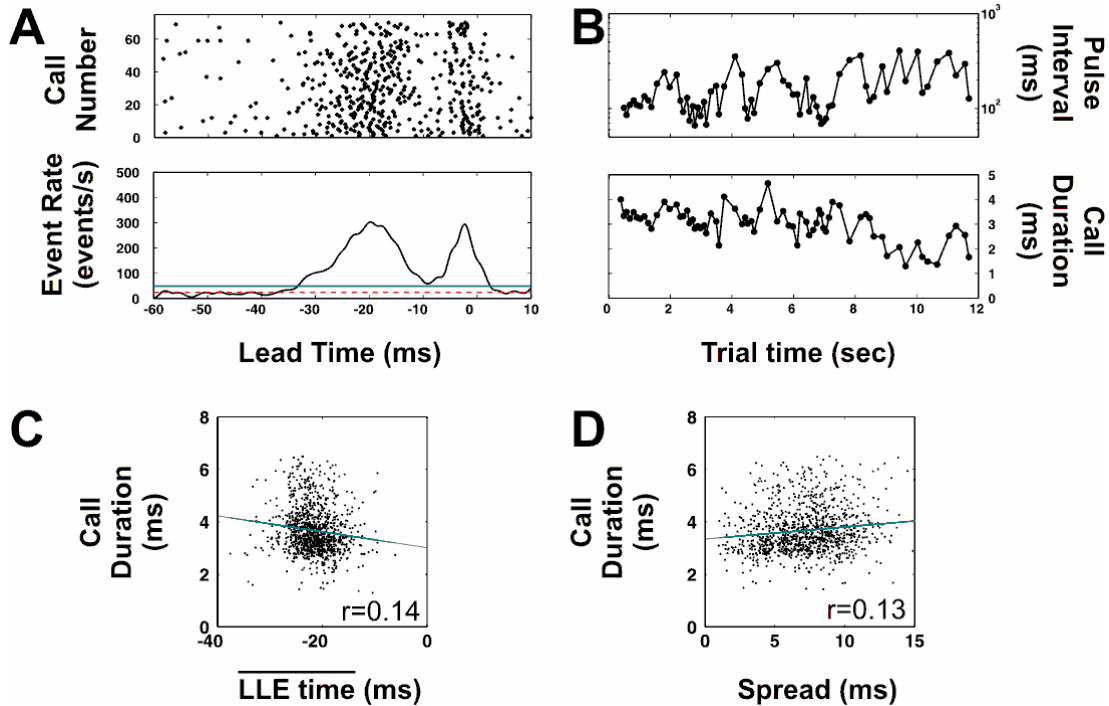

Figure 14 Sonar-related pre-motor activity is consistently observed in all recordings from the superior colliculus.

A) (Top) Raster of events preceding the onset of sonar vocalizations during one trial (bat epb1). Ordinate represents consecutive sonar calls from first to last call in the trial. Call onset is at time = 0, and the raster extends from 60 ms before to 10 ms after sonar vocal onset. During this trial 74 sonar calls were produced. (Bottom) Both long and short lead events are apparent and evident in the peri-event time histogram (A, bottom). The red (dashed) line shows the baseline activity level, and the blue (solid) line represents the criterion threshold (mean \pm 2SD) utilized for determining change from baseline activity. A reduction in event rate is observed between long lead and short lead events, and after call onset. **B)** The pulse interval and sonar call duration of vocalizations produced during the trial shown in A. PI is longer than >60 ms in echo

playback trials. **C)** Linear regression using the mean LLE time as the single predictor for estimating sonar call duration. All events preceding the sonar calls ($n=1026$) from one recording session (including trial in A) are included. Only a gradual increase in mean LLE times is observed with increasing call duration ($y=-0.03x+3.00$, $r=0.14$, $p<0.001$). **D)** Linear regression using the spread (see Methods) of LLE times for each call is used as the single predictor of call duration. The spread shows only a slight increase with call duration ($y=-0.05x+3.34$, $r=0.13$, $p<0.001$).

Three measures were used to characterize the pre-motor activity: the mean LLE time for each call, the spread (1 standard deviation) of LLE times for each call, the LLE event rate for each call. Figure 14C–D, respectively, show the linear regression fit of the mean LLE times and the spread of LLE times versus the corresponding call duration (n=1026 calls, from 14 EPB trials). Both parameters are significantly related to the call duration (mean LLE time: $F(1026)=18.0$, $p < 0.001$; spread in LLE time: $F(1026)=19.5$, $p < 0.001$), but have very low correlation coefficients ($r = 0.14$ for LLE; $r = 0.13$ for SLE). Mean LLE time and spread are not significantly related with PI. Mean event rate is not significantly related to either call duration or call PI.

| Behavior | Events | Occurrence | SE |
|--------------------|---------------|-------------------|-----------|
| Echo Playback | All Events | 0.98 | 0.01 |
| | LLE | 0.98 | 0.00 |
| | SLE | 0.82 | 0.04 |
| Oscillating Target | All Events | 0.93 | 0.00 |
| | LLE | 0.68 | 0.02 |
| | SLE | 0.67 | 0.02 |

Table 1 Occurrence of neural events prior to sonar calls for Echo Playback and Oscillating Target Paradigms.

Neural events were consistently observed to occur prior to sonar vocalizations in both the echo playback and oscillating target behavioral paradigms.

Oscillating Target

Bats trained in the oscillating target (OscT) paradigm produced naturalistic sonar calls and pursuit and capture sequences (Figure 11B, and Figure 12A). This permitted the investigation of changes in pre-motor activity from a chronically implanted bat producing echolocation calls characteristic of a free flying foraging animal. Neuronal activity during OscT trials is characterized by a low mean baseline event rate (23 ± 16 events/s, $n=35$ sites, 3 bats), similar to that observed in EPB trials. LLE occur over a range of lead times $[-29.8, -7.1]$ ms (10^{th} – 90^{th} percentile), and have a mean lead-time of -17.5 ± 9.1 ms (mean \pm SD) ($n=35$ sites, 15724 calls, three bats). For OscT trials, the SLE has lead times that span $[-3.0, +0.4]$ ms (10^{th} – 90^{th} percentile), a mean lead time of -1.2 ± 1.3 ms, and are time-locked to the call onset as in EPB trials ($n=35$ sites, 15724 calls, three bats). The LLE and SLE occur consistently prior to sonar vocal onsets, but with a lower rate of occurrence than in EPB trials (Table 1).

Figure 15 shows a representative example of the observed pre-motor activity pattern in an OscT trial. The pattern of activity evident in the EPB experiments is still evident here, with distinct LLE and SLE activity relative to sonar call onsets ($t=0$), the reduction in event rate between LLE and SLE, and the return to baseline levels after call onset.

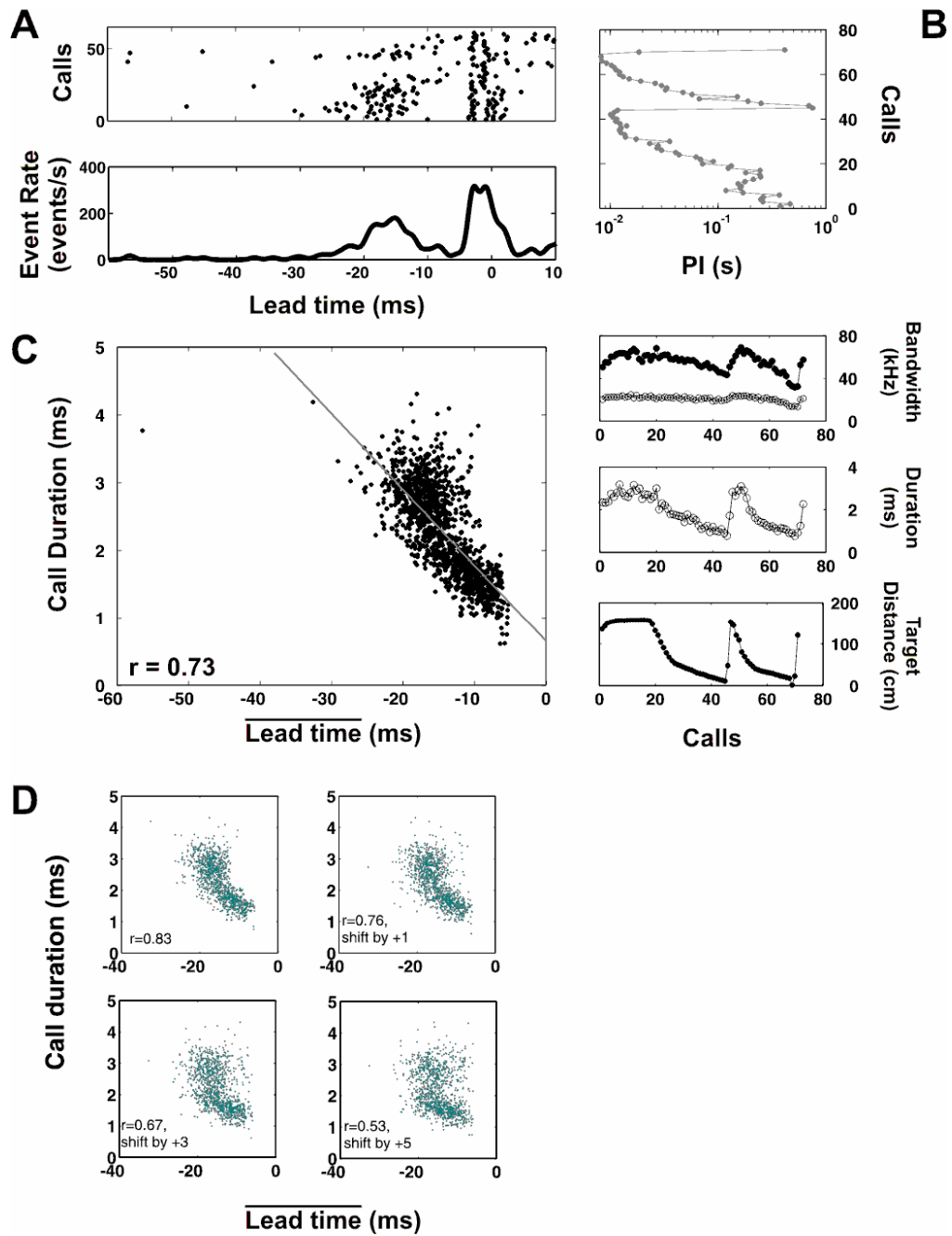

Figure 15 Pre-motor neuronal activity in the SC during an oscillating target trial.

See caption on next page.

Figure 15 Pre-motor neuronal activity in the SC during an oscillating target trial.

A) Raster and peri-event time histogram show a pattern of pre-motor activity similar to that observed in echo playback recordings. LLE and SLE precede sonar vocalizations with a reduction toward baseline between the two event groups. Data is aligned to sonar call onset (lead time = 0). LLE in the raster show a tendency toward shorter lead times during the trial, and correspond to times when the target is approaching the bat. **B)** Pulse interval (PI, gray, filled), start (black, filled) and end (black, open) frequency, calls duration (black, open), and target distance (black, filled) of sonar vocalizations produced during trial shown in A). The oscillating target approaches and recedes from the bat twice in this trial. Each sonar call parameter is modulated as a function of the target distance. Sonar call duration and pulse interval are clearly decreased whenever the target approaches. **C)** Linear regression using the mean LLE time as the single predictor of sonar call duration for all sonar calls in one recording session ($n = 738$ calls). The data shows an increase in mean LLE time for increasing sonar call durations ($y = -0.11x + 0.66$, $r = 0.73$, $F(1231) = 1425$, $p < 0.001$). **D)** Reduction in the relation between sonar call duration and mean LLE time when mean LLE time is not associated with the call it precedes. Each panel shows the sonar call duration versus the mean LLE time (as in C). Except for the top left panel, the other panels show the data with mean LLE time associated with the sonar call duration 1, 3, and 5 calls ahead in the vocal sequence. r is the variance accounted for.

In addition, when examining the raster plots from OscT trials, there is a noticeable decrease in the lead-time of LLE over the course of the trial. When evaluated with respect to target distance, the decreasing LLE lead-times occur when the oscillating target was swinging toward the bat, i.e. approaching the bat.

Based on this observation, the mean of the LLE times for each sonar call was calculated and plotted against the corresponding call duration (Figure 15C). A clear trend is observed in which larger mean LLE times correspond with longer call duration, and shorter mean LLE times correspond with shorter call durations. A linear regression fit of this data shows a significant relationship between these two parameters ($F(1231)=1425$, $p<0.001$), and accounts for a large fraction of the observed variance, $r=0.73$. If the mean LLE time of one call is associated with the call duration of a sonar pulse later in the vocal sequence, and the linear regression analysis is performed, the amount of variance accounted for decreases. Figure 15D shows the results of such an analysis when the mean LLE time of one call is associated with the duration of a call one, three, or five calls forward in the sonar pulse sequence (backward comparisons show similar results). The variance accounted for steadily decreases suggesting the mean LLE times are associated with the upcoming call.

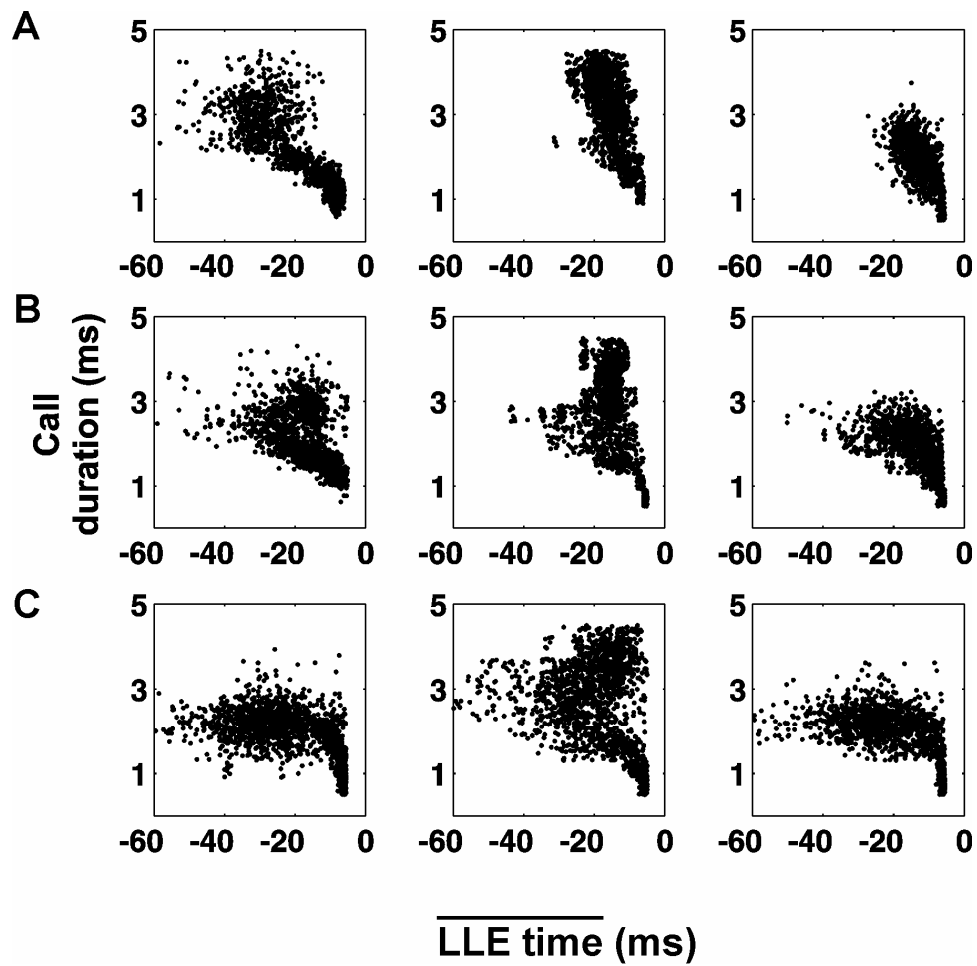

Figure 16 Representative plots of sonar call duration versus mean LLE time.

Each figure is constructed from data taken at different recording channels. **A)** A linear relation is observed at the majority of sites, and three examples are shown here. **B)** A fraction of the recording sites have deviations from a linear relationship and three separate examples are presented. **C)** In a subset of cases there is clearly a departure from a linearity, and the relationship can be better described as piecewise linear.

This relationship was examined across all the OscT sites, and three categories were constructed: 60% (21/35) of sites appeared well approximated by linear trends, 17% (6/35) showed a less clear linear trend, and 23% (8/35) showed a poor linear trend, but in general a piecewise linear trend. Representative plots from these three separate categories are shown in Figure 16A,B,C (linear, linear-like, not linear respectively). For the first two categories single predictor linear regression parameters and r-values were calculated. The distribution of regression values is shown in Figure 17A, and the line fits in Figure 17B. The slopes of the linear fits were in the range [0.017–0.118], with a mean (SD) of 0.065 ± 0.028 . Therefore, a 1 ms increase in call duration corresponds to an approximately 15ms increase in mean LLE time. Mean LLE time was not significantly related to PI when a linear regression analysis was performed.

Event rate and spread were also investigated in OscT trials, and related to sonar call duration. Both these parameters had essentially linear relationships with call duration, but by themselves accounted for only a small amount of the overall variance. Combined with the mean LLE times, these three predictors generally increase the overall variance accounted for in a multiple linear regression analysis. The three predictor r-values are plotted against the single (mean LLE) predictor r-values in Figure 17C.

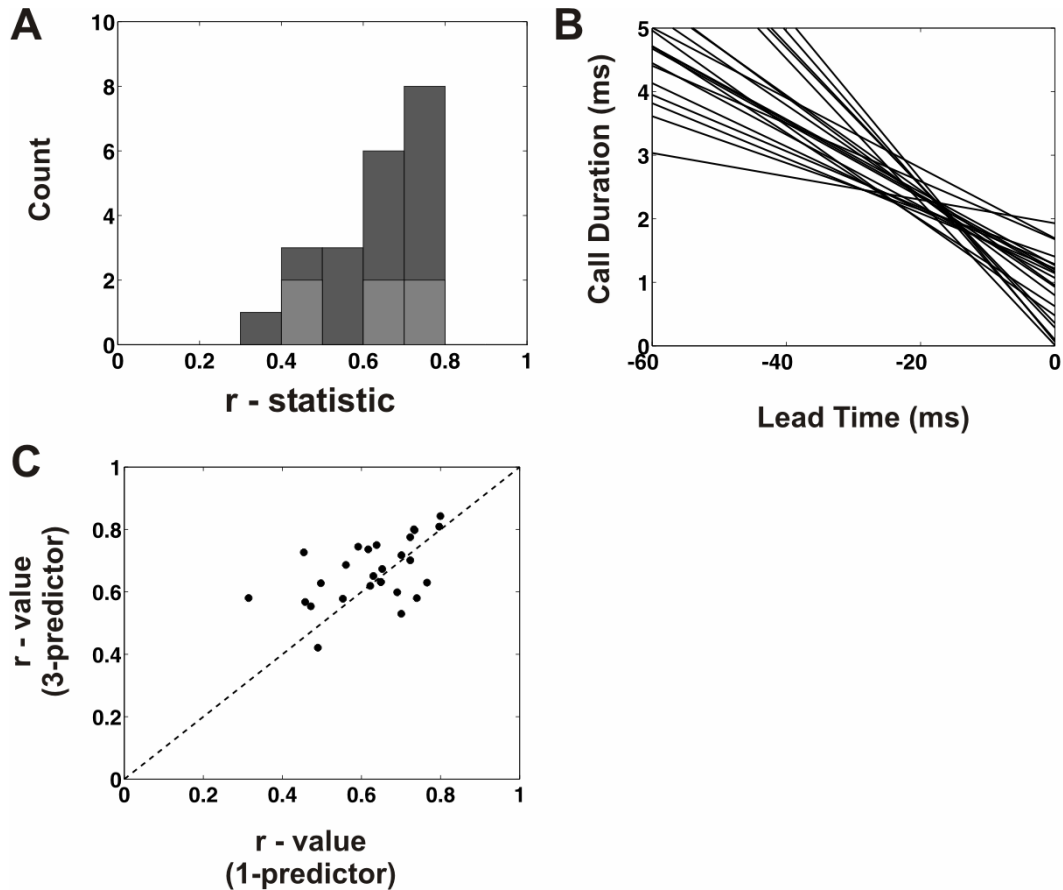

Figure 17 Linear regression analyses using mean LLE time to predict call duration.

Linear regression analyses were performed for all sites ($n=27$) for which sonar call duration and mean LLE time were well approximated by linear relationship. **A)** Histogram of the r -statistic values calculated from the linear regression analyses. At each recording site, the mean LLE time was the single predictor to estimate sonar call duration. This measure generally accounts for $>50\%$ of the variance in sonar call duration. **B)** Linear regression line fits from the 27 sites, in the superior colliculus of three bats. The lines have a mean slope of 0.065 ± 0.028 . **C)** R -statistics from linear regression using event rate, spread, and mean LLE time as predictors of sonar call duration plotted against single predictor (mean LLE time) r -statistic values. A modest increase in the variance-accounted-for is observed at the majority of sites, as demonstrated by most points lying above the unity line.

The sonar call duration versus the SLE activity is shown, in Figure 18, in an eight millisecond window [-6,+2] ms around each call (lead time = 0). The data is taken from three different sites in three different bats, with the n-values in the panels representing the number of calls that contributed to each figure (n=1117, 2260, 2268 calls). The three panels show the range of deviation we observed in our SLE data, with events occurring well-locked to sonar onset and with fairly high precision. No obvious relationship was observed with sonar call duration or PI. Short lead events did not show any statistically significant relationship with call duration or PI when a linear regression analysis was performed. Even when different threshold criteria were used to select events linear regression analysis returned non-significant results.

Neural recordings were made from seventeen separate penetrations, at seven potentially different depths. We did not identify any relationships between the histologically reconstructed recording sites, either in depth or along the medial-lateral or rostral-caudal dimensions, and the pattern of pre-motor neural activity. The question of site-specificity of the vocal pre-motor pattern of activity can be more thoroughly addressed with future improvements in our chronic recording techniques.

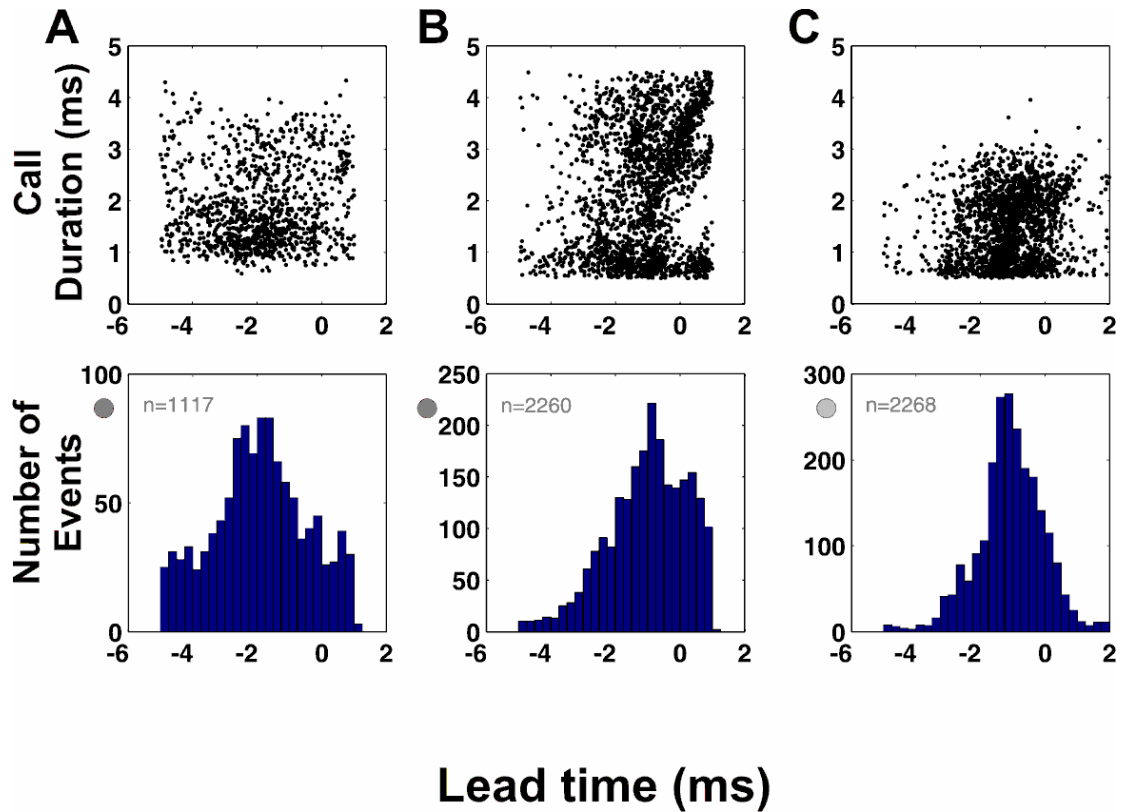

Figure 18 Short lead events are time-locked well to sonar vocal onsets.

Data in A–C is from three different sites in three different bats, and is comprised of all the SLE data from single sessions. The short lead event data was collected while bats used echolocation to track an oscillating target swinging toward and away from the bat. Top panels are sonar call duration versus short-lead event times showing the uniform occurrence of event times with sonar call duration. Bottom panels show histograms of the number of events at each time showing the precision of short-lead events. Time bins are 0.25ms. Values shown in bottom panels represent the number of sonar calls used to construct each plot. Dots at the top of the ordinate in the bottom panels draw attention to the different range of values.

Controls

Four control experiments were conducted to determine whether the observed pre-motor activity in the SC was related to non-sonar vocalizations, potentially to other orienting movements, or to artifacts. Data from all the control experiments are shown in Figure 19.

First, neural activity was recorded in the SC while bats produced non-sonar vocalizations (Figure 19A; n=6 sites total recorded). Raster plots (Figure 19A, top left panels) and their corresponding PETH (Figure 19A, bottom left panels) aligned to vocal onsets ($t=0$) (spanning 60 prior to, until 10 ms after call onset) showed no distinct LLE or SLE pattern of activity. The PIs of these non-sonar vocalizations (Figure 19A, top right) encompassed a similar range of PIs as the sonar vocalizations (Figure 11B,14B). However, the calls produced had much lower start and end frequencies (within the human audible range), and a more variable range of call durations, with many calls > 5 ms in duration (Figure 19A, bottom right). When bats produced sonar vocalizations, pre-motor activity with LLE and SLE were consistently observed at these same sites.

Next, high-speed video recordings were made of the bat on the platform while it was engaged in the echo playback experiment. Infra-red markers on the pinna, head and body were tracked for a subset of trial segments (n=20 trials segments; 50 sonar calls; 3 bats).

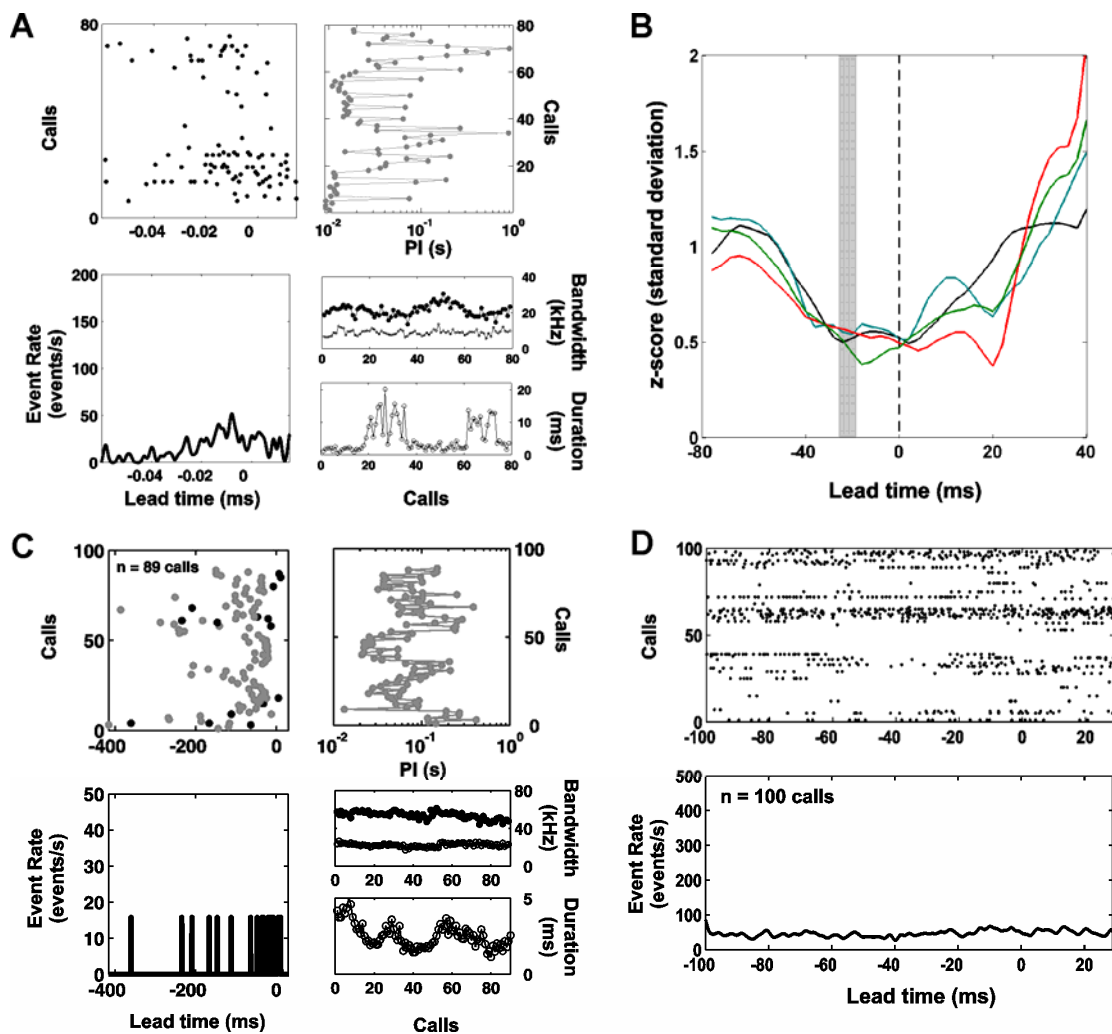

Figure 19 Control experiments conducted to verify relationship between SC pre-motor neural activity and sonar vocalizations.

A) Simultaneous neural recordings were made when bats produced non-sonar calls. (Left Panels) A raster plot and their corresponding peri-event time histograms do not show long-lead events or short-lead events when bats produce non-sonar calls. The raster and peri-event time histogram (PETH) show SC neural activity around vocal onset ($t=0$), for $n=79$ non-sonar calls from a single site. (Right Panels) Pulse interval, bandwidth, and call duration of non-sonar calls. **B)** Head movements were tracked

during the production of sonar vocalizations. The movement trajectories were normalized for comparison using a z-score function. A reduction in the amount of head rotation is seen preceding the expected time of pre-motor activity, and becoming variable at less reliable amounts of time after call onset. Data are from three bats (four sessions), aligned to sonar call onset ($t=0$). Vertical gray bar represents mean time of expected long-lead events $\pm 1SD$. **C)** No pre-vocal neural activity is observed in the inferior colliculus prior to sonar vocalizations. Gray dots represent the time of the last call and black dots are event times. The PETH shows low firing rates. Sonar pulse intervals range from 20–410 ms, similar to the range observed during echo playback experiments. For sonar call bandwidth, start frequencies (black, closed circles), and end frequencies (black, open circles) are shown. **D)** Raster and PETH of electromyogram events recorded from the muscles of mastication on the dorsal surface of the skull. Events around sonar calls ($n=100$ sonar calls) are aligned to call onset (lead time= 0), and do not show deviations in rate before or after call onset. The event rate remains low (50 ± 5 events/s) during the sonar call onsets.

Three measures, head turn angle (θ) with respect to the body, its first derivative (angular velocity), and second derivative (angular acceleration) were calculated for each trial segmented. Eighty millisecond segments of data around each sonar call onset (± 40 ms) were plotted for each measure. Plots of these three measures did not show any consistent pattern relative to the time of sonar vocal onset. Next, we normalized the θ data for each trial segment using a z-score measure, and then reanalyzed the data (Figure 19B). There was evidence in the aligned data of a reduction in the variance of the head movement prior to the occurrence of the LLE (gray bar, centered on mean ± 1 SD). At a variable time after the sonar vocal onset the amount of head movement increased once again. Slight pinna movements were observed, but these were within the noise level of our video marker tracking.

Third, neural activity was recorded from the inferior colliculus (IC) while bats spontaneously produced sonar vocalizations. The IC is located adjacent and immediately caudal to the SC. If the pattern of SC pre-motor activity were not specific to the SC, then we would expect a similar pattern to be evident in the IC as well. Figure 19C shows data recorded during 89 sonar calls from one IC site. Similar data was recorded from four other IC sites. The raster (Figure 19C, top left) and PETH (Figure 19C, bottom left) are aligned to sonar call onset ($t=0$), shows no evidence of LLE or SLE, and have little overall activity prior to call onsets. Figure 19C (right panels) shows the PI, start and end frequency, and duration of emitted calls. The variation in the pulse interval, frequency content, and duration are similar to the range of values observed in the SC recordings (Figure 14B,15B).

Fourth we made EMG recordings from the muscles of mastication that lie on the dorsal surface of the head, adjacent to the chronic implant. These muscles flex when the animal moves its jaw, as during chewing or calling. Vocal and neural recordings were made from 2 bats trained to spontaneously produce sonar vocalizations for variable periods of time (5–20 seconds), while resting on a platform. The peri-vocal raster and PETH (Figure 19D) shows EMG activity in a window spanning 100 ms prior to, until 20 ms after, call onset (n=100 sonar vocalizations). In contrast to the neural recordings in Figure 14,15, we observed no pattern of activity that was similar to the LLE and SLE observed in SC recordings. The firing rate remained essentially constant and low, and did not change in pattern before or after the calls onset (time = 0).

Discussion

This study provides the first detailed description of pre-motor activity in the superior colliculus of echolocating bats. Electrophysiological and behavioral techniques were developed that permit tethered, multi-channel, chronic recordings from unrestrained bats engaged in echolocation. Several features of the pre-motor activity indicate that the bat SC may generate commands that shape sonar vocal parameters. Initial experiments suggest that the SC pre-motor activity precedes sonar onsets at every recording site, and that the temporal dynamics of a distinct subclass of events is related to sonar pulse duration, a vocal parameter that bats adjust with target

distance. These results support the hypothesis that pre-motor activity seen in the bat superior colliculus participates in spatial orienting along the range axis.

Superior Colliculus Activity Related to Sonar Vocalizations

The pre-motor activity we observe in the bat SC is consistently characterized by a temporally broad set of long lead events (LLE) and comparatively precise set of short lead events (SLE). The mean event rate returns to baseline within approximately 1ms of the start of each sonar call. This pre-motor pattern of activity is evident at all SC recording sites. During the pre-motor discharge the mean firing rate increases from 20 events/s at baseline to >300 events/s, in a window of time spanning approximately 30 ms prior to vocal onset. This pre-motor activity precedes sonar vocalizations in both behavioral paradigms over 90% of the time. The pre-motor SLE precedes each sonar vocalization with a particularly short lead-time, ~3ms, and has a discharge pattern with high temporal precision ($SD < 1.5$ ms) (Figure 14A, 15A). No consistent changes in the timing or event rate were observed for the SLE relative to sonar vocal duration or PI. This short lead-time is inconsistent with directly influencing the upcoming sonar vocalization, based on the number of estimated synapses between the SC and the laryngeal motoneurons, but may serve other functions.

Controls

All experiments in the booth and the flight room were conducted using long wavelength light (>650 nm), at low intensity levels (<0.1 lux). Based on electroretinogram recordings (Hope and Bhatnagar, 1979a; Hope and Bhatnagar, 1979b) these wavelengths and intensities would eliminate visual cues available to *Eptesicus fuscus* during the experimental trials.

To further examine the relationship between SC pre-motor activity and sonar vocal production four control experiments were conducted. The first of these control experiments suggest that SC pre-motor activity is related specifically to sonar vocal production and not to the production of non-sonar calls. Peri-vocal neural activity recorded on a subset of trials when the bat produced non-sonar calls did not have the characteristic pattern of LLE or SLE. This is consistent with stimulation experiments in the bat SC that elicit sonar calls but not communication calls (Valentine et al., 2002; Schuller and Radtke-Schuller, 1990). Second, recordings were made from sites in the inferior colliculus while simultaneously recording sonar vocalizations. Pre-motor activity at these IC sites was not observed. Third, neural activity was recorded from the muscles of mastication that are located on the dorsal surface of the skull adjacent to the implant. The EMG neural activity changed < 1SD of the mean around vocalizations, and was not modulated relative to the onset or duration of sonar calls.

Lastly, no clear relationships between the pre-motor SC activity and head or pinna movements in our echo playback paradigm were identified. First, the

occurrence and timing of neural activity with sonar vocalizations is very consistent (>90%). However, the timing of head movements relative to sonar vocalizations is highly variable. A reduction in the size of head movements preceding the occurrence of the LLE, and an increase in the size of head movements at a variable time after the production of sonar calls was observed. The inconsistent relationship between head movements and sonar vocalizations suggests that there is no reliable relationship between head movements and the observed pre-motor activity. No detectable pinna movements, above the measurement-induced errors, were observed in our video recordings. These findings do not exclude the possibility that pre-motor activity related to head or pinna movements is present in the bat SC. Two factors may account for the absence of a relationship between pre-motor activity and head/pinna movements in our data set. The first possibility is that the identified pre-motor activity was not related to the types of head and pinna movements the bat employed in our behavioral paradigms. In both the echo playback and the oscillating target paradigms, bats were trained to attend to locations in front of them. In the echo-playback experiments all stimuli were presented from a single speaker positioned in front of the bat. In the oscillating-target experiments the target only moved in a plane intersecting the bat's position so that the target approached and receded from it. Therefore, both paradigms eliminated the need for lateral movements to perform the task, and also removed any uncertainty related to target position or sound source direction. Those head or pinna movements that were observed were small in amplitude, and not ballistic. As such, it can be said that pre-motor activity was not related to head or pinna movements, at least to the accuracy of our video recording

methods. The second possibility is that movements related to the pre-motor activity was too fast to be identified based on our video sampling rate (250 frames/s) and data smoothing.

Sonar Call Duration and PI

The vocal pre-motor activity in the SC shows a change in temporal dynamics related to the sonar call duration, namely a reduction in the mean LLE time occurs with a decrease in sonar call duration. A similar relationship is not observed, however, between mean LLE time and sonar PI, despite the fact that call duration and PI are coordinated during behavioral trials. There are a few possible explanations for this difference. First, there is a wide range of pulse intervals associated with any given sonar call duration, so a trend evident between LLE activity and call duration, may be obscured when comparing it to the more variable sonar PI. But this seems unlikely since even at the lowest call duration, where the PI shows the least variability, there is no observed relationship between mean LLE time and PI. Second, the decision of when to produce a sonar vocalization is a complex process that is likely based on the integration of information across multiple sonar vocalizations (Moss and Surlykke, 2001), and involves a network of brain areas. This process involves spatial localization of sound sources, target selection, target feature analysis, and target intercept planning. However, once the decision to vocalize is made, the SC may be engaged to orient the bat's gaze by performing body, head, and pinna movements, in coordination with sonar call production.

Latency of Vocal Pre-motor Activity

The event lead-times we observed are shorter than the reported latencies between electrical stimulation of the SC and vocal onset in *Eptesicus fuscus* (170 ± 63 ms, $n=21$ sites) (Valentine et al., 2002) and *Rhinolophus rouxi* (47 ± 22 ms, $n=103$ sites) (Schuller and Radtke-Schuller, 1990). The discrepancy may be due in part to two factors. First, sonar vocal production is coupled with respiration (Fattu and Suthers, 1981; Rübtsamen and Schweizer, 1986; Schuller and Radtke-Schuller, 1990); therefore, eliciting a sonar vocalization requires the coordinated recruitment of both respiratory and vocal motor pathways (Jürgens, 2002). Thus, simple electrical stimulation in a midbrain nucleus may be an imprecise technique to appropriately recruit these two motor pathways, and result in a larger and longer range of latencies between stimulation and vocal onset. Second, bats of both species can produce sonar vocalizations with short pulse intervals ($< 10-50$ ms). For this to occur, circuits that contribute to vocal production must operate on a similar time-scale, in order to generate the appropriate vocalizations. Therefore, the observed pre-motor activity is more consistent with behaviorally observed patterns of vocalizations, and the long latencies observed in electrical stimulation may simply not reflect the temporal dynamics of neural activity when bats are actively vocalizing.

Patterns of Neural Activity in Different Behaviors

The trend observed between the sonar call duration and mean LLE time in the oscillating target paradigm, is not evident in the echo playback paradigm. In both cases the threshold for detecting pre-motor activity was based on the mean

background event rate. This rate was similar in both paradigms, indicating that other factors contributed to the difference. The foremost distinction was the range of call durations utilized by bats in the two behavioral paradigms. Bats in the oscillating target paradigm routinely made calls between 0.5–4.0 ms, in contrast to the 2.5–4.0 ms calls identified in echo playback paradigm. This limited range of call durations may obscure a detectable trend if the slope in the relation is low. At some sites tested in the oscillating target paradigm (Figure 18C) only a weak relation was observed between longer call duration and mean LLE time, and this may contribute to the absence of an effect in the echo playback paradigm. Second, the two behavioral conditions had different goals in order to successfully complete the task. In the oscillating target paradigm bats had (1–2)s intervals in which to produce vocalizations and capture the target, while in the echo playback paradigm bats were given (6–12)s to complete a discrimination task. Future experiments that manipulate task demands in a parametric manner will be necessary in evaluating how neural responses may change due to the behavioral context.

Superior Colliculus Connections for Sonar Vocal Control

Given the importance of sonar call features to echolocation behavior, a number of experiments have sought to identify nuclei involved in the sonar production circuitry. Using electrical and chemical microstimulation and microdialysis techniques several regions involved in sonar vocal production have been identified. Experiments have primarily focused on loci in the ventral tegmentum and hindbrain that elicit and affect properties of sonar vocalizations

(Rübsamen and Schweizer, 1986; Suga and Yajima, 1989; Metzner, 1996; Schuller et al., 1997; Fenzl and Schuller, 2002; Smotherman et al., 2003). These regions have been implicated in both triggering sonar vocalizations, as well as impacting the frequency and intensities of emitted calls.

The SC may in part act as an interface for vocal motor control between higher brain regions and brainstem nuclei. The overall pattern of sonar-related activity in the superior colliculus may be derived in part from other regions. For example, projections have been demonstrated in the mustached bat, *Pteronouts parnellii*, from regions of the frontal cortex (Kobler et al., 1987). These anatomically identified regions receive projections from the auditory cortex and a division of the auditory thalamus, the suprageniculate nucleus. This frontal cortex region contains auditory neurons, and projects heavily to the deep layers of the superior colliculus. This pathway from frontal cortex to the SC may shape the pre-motor activity we observe, and may be homologous to the projections observed in monkeys from the frontal and supplementary eye fields (FEF/SEF) to the SC for mediating eye movements (Segraves and Goldberg, 1987; Stanton et al., 1988). In addition to projections from cortex, the SC receives putative GABAergic projections from two nuclei, the zona incerta in the medial thalamus, and the substantia nigra pars reticulata. Both these projections may act to gate pre-motor activity in the superior colliculus, and thereby control the timing and type of behaviors the animal produces. The inhibitory projections from these two nuclei may underlie the low background firing rates we observe in the SC, and disinhibition may explain the large and comparatively brief

bursts of discharges observed prior to sonar vocalizations used by bats while orienting.

Two auditory input pathways shape the pattern of activity observed in the SC (for review see Huerta and Harting, 1984b). The first is the lemniscal pathway, which projects via the cochlear nucleus to multiple brainstem targets, that in turn terminate in the inferior colliculus (for review see Oertel, 1999) which in turn projects to the SC (Covey et al., 1987; Sinha et al., 2000). This is the best-studied auditory input pathway to the SC, both in mammals and other vertebrates, and provides a basis for the spatial representation of sound source location observed in the SC. The second pathway, identified in two bat species, in two separate families (Casseday et al., 1989; Behrend and Schuller, 2000), involves a pathway known as the central acoustic tract that bypasses the lemniscal pathway altogether. Projections from the CN ascend to the nucleus of the central acoustic tract, and then to the SC and the suprageniculate nucleus in the auditory thalamus. This pathway provides rapid (4–6 ms) auditory input to the SC, and likely contributes to the short latency responses observed in SC auditory units (Jen et al., 1984; Wong, 1984; Reimer, 1991).

In turn the SC projects heavily onto the PLa, one of the largest ventral tegmental targets of SC outputs. The PLa has been intensively studied as a site for temporal and frequency control of emitted sonar vocalizations in bat species that use CF–FM echolocation signals and exhibit DSC behavior (Pillat and Schuller, 1998; Schuller et al., 1997; Metzner, 1989). Experiments have shown that neurons in

this area respond to auditory stimuli, that responses are modulated by the presence or absence of spontaneous vocalizations, and that stimulation of this area elicits sonar when stimulated (Metzner, 1989; Metzner, 1993). However, sonar vocalizations are still produced even when this nucleus is lesioned (Pillat and Schuller, 1998), though the subsequent quality of these vocalizations has not been rigorously evaluated. In addition to this target nucleus, the SC in *E. fuscus* shows anterograde projections to the parabrachial nucleus and the cuneiform nucleus (Sinha et al., 2000), both implicated in vocal production and orienting movements (Metzner, 1996; Smotherman et al., 2003). This indirect tecto–tegmental pathway for influencing sonar vocalizations is similar to the tecto–tegmental pathways observed in other species that are implicated in mediating other species–specific orienting behaviors. Indirect tectal pathways for mediating orienting behaviors have been demonstrated in such disparate species as frogs (Masino and Grobstein, 1990), turtles (Sereno, 1985), snakes (Gruberg et al., 1979; Dacey and Ulinski, 1986), owls (Masino and Knudsen, 1992), cats (Grantyn and Grantyn, 1982), and primates (Scudder et al., 1996a).

Role of Collicular Vocal Pre–motor Activity

Motor Commands for Controlling the Features of Vocalizations

Echolocating bats can carefully control their head aim, and presumably pinna movements, to gather acoustic information from specific directions (azimuths and elevations) in space (Griffin et al., 1962; Griffin et al., 1962; Pye and Roberts, 1970; Ghose and Moss, 2003). Bats use the time delay between sonar emission and

returning echo to determine target distance (Simmons, 1973), a dimension bats must measure accurately to successfully orient in space. This appears crucial when one considers the high flight speeds of bats during insect pursuit (>3 m/s), and the short operating range of sonar due to physical constraints like excess attenuation of high frequencies (Simmons and Lawrence, 1982). In addition, multiple objects exist in the environment at multiple distances from the bat and can have potentially deleterious affects on range discrimination (Simmons et al., 1988; Masters and Raver, 1996), so a mechanism to focus on a limited range of distances would seem beneficial.

The data shows that the LLE occur early enough relative to sonar vocal onset (Figure 14A, 15A) to influence the features of upcoming sonar vocalizations, since the SC is separated from the laryngeal motor neurons by approximately two to four synapses (Covey et al., 1987; Sinha et al., 2000; Schuller et al., 1997). Furthermore, as sonar vocalizations are produced with shorter durations, the lead-time of the LLE decreases (Figure 16C), further supporting the prospect that changes in the pattern of LLE activity contribute to the upcoming sonar vocalization. In addition, when the mean LLE time is related to the duration of calls further forward or backward in time, rather than the upcoming call, the relationship between mean LLE time and call duration deteriorates, again suggesting the LLE influences the upcoming sonar call (Figure 16D). There is also the notable relationship between sonar call duration and the target distance. Thus, one possibility is that the pre-motor LLE activity in the bat SC is related to commands for changing the sonar pulse duration as well as initiating calls. Such adjustment of sonar call duration has parallels with the control of

vergence eye movements in primates. Three mechanisms exist to adjust the depth of focus in primates: accommodation, disconjugate vergence (convergence and divergence) eye movements, and pupillary constriction (Miles, 1985). Recent experiments suggest the rostral pole of the SC in macaques plays a role in the control of vergence eye movements (Gnadt and Beyer, 1998; Chaturvedi and Van Gisbergen, 1999; Chaturvedi and Van Gisbergen, 2000; Suzuki et al., 2004). Therefore, the pre-motor activity observed in the bat SC might influence sonar call duration for the purpose of directing acoustic gaze along the range axis.

Efference Copy

Efference copy motor signals are common in sensori-motor control systems, and are useful for providing information about intended motor activity, to modulate sensory information such as reafferent signals, or used during motor learning as an internal prediction to compare with target reference (Bell et al., 1997; Troyer and Doupe, 2000; Sommer and Wurtz, 2004). The short lead-time of the SLE makes its casual role in sonar vocal production highly unlikely, however its activity may represent a form of efference copy, signaling an impending sonar vocalization. This is important in echolocation behavior in order to process echoes arising from self-generated sonar vocalizations.

Two potential mechanisms whereby SLE activity could act as an efferent copy signal for impending vocalization are described. First, the amplitude of sonar calls emitted by bats like *Eptesicus* are approximately 110 – 120 db SPL (Grinnell, 1963).

Such large amplitude signals would render echoes difficult to detect. A neural mechanism, identified in bat species, involves a central source of attenuation that mitigates the effect of intense sounds (Suga and Schlegel, 1972). This neural attenuation, which acts in addition to the middle ear reflex (MER) (Jen and Suga, 1976), reduces the responses of auditory neurons, arises only when bats vocalize, and is first apparent at the level of lateral lemniscal nuclei (LL) (Suga and Schlegel, 1972). One potential source of this neural attenuation may be the SLE activity observed in the SC. A possible means of testing this proposal is by inactivating the SC and recording in the LL nuclei. By eliminating the SLE activity the magnitude of neural attenuation can be measured at the level of the LL during and after sonar vocal production.

A second potential function for SLE activity may be to act within the SC itself, and affect the response profile of auditory neurons in the SC. The bat SC has auditory neurons with two-dimensional spatial receptive fields (Sun et al., 1983; Jen et al., 1984; Shimozawa et al., 1984; Poussin and Schlegel, 1984; Reimer, 1991), as well as delay-tuned neurons (Valentine and Moss, 1997). Both classes of neurons can respond with short latency (~6ms) to auditory stimuli in passively listening bats. Thus the SLE may serve to modulate the neural response to acoustic stimuli when the bat vocalizes. A potential future experiment could measure the firing rate of SC auditory neurons, and determine if the response to an externally applied auditory stimulus is differentially modulated when the bat does and does not vocalize.

For this report we developed chronic neuronal recording techniques for unrestrained and freely behaving bats. The method permitted us to make multi-channel recordings from the bat superior colliculus a structure involved in orienting behaviors, which includes sonar vocal production in bats. Our data demonstrates that pre-motor activity is evident in the SC and this activity is related specifically to sonar vocal production. In addition, the vocal pre-motor activity shows changes in temporal dynamics related to sonar call duration, a parameter that bats finely adjust with changes in target distance during insect capture.

Chapter 3: Anatomical Connections of the Superior Colliculus for Sonar Vocal Control in the Echolocating Bat, *Eptesicus fuscus*.

Introduction

Echolocating bats are highly successful mammals constituting approximately 25% of extant mammalian species (Jones et al., 2002). Bats have evolved a biological sonar system that supports three-dimensional spatial perception (Griffin, 1958). These nocturnal animals orient in space by producing ultrasonic vocal signals and listening to reflected echoes. The bat's sonar receiver uses binaural differences to estimate the direction of returning echoes (Simmons, 1979), and time delay between outgoing sonar vocalizations and reflected echoes to estimate target distance (Feng et al., 1978; Suga et al., 1978). This acoustic information is used to direct spatial orienting behaviors such as the movements of their wings, body, head and pinna and sonar vocalizations. The production and control of sonar vocalizations is a critical component of the orienting behavior in bats. Bats dynamically change the features of their sonar calls when they search for, approach, and pursue prey by manipulating the frequency content, spectral contour, call duration, and repetition rate (Simmons et al., 1979; Simmons et al., 2001; Moss and Surlykke, 2001; Wilson and Moss, 2004).

The circuits underlying audio-vocal integration are likely to include mesencephalic structures like the superior colliculus (SC). At least two lines of evidence support a role for the SC in the control of species-specific orienting behaviors that for the bat include sonar call production. First, electrical stimulation evokes orienting behaviors whose metrics are generally determined by the site of SC stimulation (monkey: Robinson, 1972; Freedman et al., 1996; Corneil et al., 2002a; Krauzlis et al., 2004; cat: Roucoux and Crommelinck, 1976; bat: Schuller and Radtke-Schuller, 1990; Valentine et al., 2002; rat: Dean et al., 1989; owl: Masino and Knudsen, 1993; fish: Herrero et al., 1998). Second, ablation studies of the entire SC (Sprague and Meikle, 1965; Schneider, 1969; Albano and Wurtz, 1982) or focal pharmacological inactivation of zones within the SC (Hikosaka and Wurtz, 1985a; Hikosaka and Wurtz, 1986) result in selective impairments of sensory processing and orienting behaviors, when appropriate behavioral assays are used to probe for deficits.

The basic structure of the bat SC is similar to that found in other mammals (Cotter, 1985; Covey et al., 1987; Zhang et al., 1987; Sinha et al., 2000), therefore frequently comprised of seven laminae, with alternating lamina of fibers and somata. The SO layer receives direct retinal projections, and combined with the two most superficial layers (SAS, SGS) are involved in visual processing, as determined using tracer injections into the retina or degeneration and autoradiographic techniques (Pentney and Cotter, 1976b; Cotter, 1985; Cotter and Pentney, 1979). In other mammals, these anatomical findings are similar, and in addition the contralateral

visual hemifield is represented in a topographically organized manner (Cynader and Berman, 1972). The intermediate (SAI, SGI) and deep layers (SAP, SGP), i.e. the ventral four layers, have been studied primarily from the perspective of echolocation, and have patterns of projections similar to those described in non-echolocating mammals (Covey et al., 1987; Zhang et al., 1987; Sinha et al., 2000; Huerta and Harting, 1984b in non-bat species).

The SC in the insectivorous bat, *Eptesicus fuscus* (family Vespertilionidae), shows functional specializations related to acoustic orienting via sonar. Namely, two neuronal populations of spatially tuned auditory neurons have been identified. The first population responds to auditory stimuli with specific azimuth and elevation and has a putative role in guiding acoustic orientation (Sun et al., 1983; Shimozawa et al., 1984; Wong, 1984; Reimer, 1991; Jen et al., 1993; Valentine and Moss, 1997). The second population of auditory neurons shows direction selectivity along with enhanced responses to echoes with specific delays relative to emitted vocalizations (Valentine and Moss, 1997). This second class of neurons, referred to as 3-D neurons, is believed to underlie the representation of target distances in echolocating bats (Feng et al., 1978; Suga et al., 1978).

Motor specializations related to sonar vocal production have also been described for the bat. Our previous experiments have shown that chemical and electrical microstimulation of the SC elicits species-specific sonar vocalizations, a component of the overall orienting behavior central to echolocation (Valentine et al.,

2002). In particular, the sonar vocalizations elicited were coupled to head and pinna movements, thus implicating this neural structure in motor commands for the production (sonar vocalization and head movements) and reception (head, body and pinna movements) of echolocation signals. Stimulation of the SC in another bat species, *Rhinolophus rouxi* (family Rhinolophidae) also elicited species-specific sonar vocalizations (Schuller and Radtke-Schuller, 1990).

The goal of the present study was to characterize the efferent pathways of the SC that potentially mediate sonar vocal production in *Eptesicus fuscus*. Two previous studies have looked at the connections of the bat SC but have emphasized the auditory afferent inputs and the role of the SC in head, pinna and body orienting movements (*Eptesicus fuscus*, Zhang et al., 1987; *Pteronotus parnellii*, Covey et al., 1987). We report here on the pattern of SC afferent and efferent connections in *E. fuscus*, and emphasize connections of the SC with pre-motor structures implicated in sonar vocal production (Fenzl and Schuller, 2002; Schuller and Radtke-Schuller, 1990; Metzner, 1993). We identify one circuit potentially involved with audio-vocal control and hypothesize that this circuit plays a role in the adaptive vocal behavior of bats.

A part of this work has previously been reported (Sinha, 2001).

Methods

Animal Subjects. Adult insectivorous bats (*Eptesicus fuscus*) ranging from 13–18 grams were collected from the wild and housed in a bat vivarium at the University of Maryland. Bats were housed under constant 12:12 hour, light:dark, conditions and given food and water *ad libitum*. All procedures described here were approved by an Institutional Animal Care and Use Committee at the University of Maryland. The ten animal subjects that were used for this study, were housed in the lab less than one year prior to use, and were of both sexes.

Surgical Methods. Bats were anesthetized with isoflurane gas (2–3 % / 700 cc / min O₂, NLS Animal Health). Blunt dissection was used make a midline incision, and the muscles of mastication overlying the skull were deflected from the midline. After exposing the skull a metal post was adhered to the skull surface with a biomedical grade cyanoacrylate (Loctite 4113). The superior colliculus is a dorsal structure in this bat species and can be identified using skull landmarks. A craniotomy was performed over one superior colliculus using a sharpened Beaver Eye blade (Becton Dickinson, NJ, USA). The dura was deflected, and small quantities (5–15 nl) of tracer consisting of 10-15% biotinylated dextran amines (BDA, 10,000 MW, Vector Laboratories, CA, USA) were injected through a glass pipette attached to a 0.5 µl Hamilton syringe into the superior colliculus using established skull landmarks. Wounds were closed with Vetbond tissue adhesive (3M, Inc., MN, USA) and bats were returned to the colony room to recover.

After a survival period of 4–5 days, bats were deeply anesthetized with sodium pentobarbital (0.04 ml/bat, intraperitoneal). Perfusion with saline was followed by a 4% buffered paraformaldehyde fixative and the brain tissue removed from the skull and blocked. The brains were subsequently stored in sodium phosphate buffered saline (PBS) (0.1M; pH=7.2) with 30% sucrose overnight, sectioned at 40 μ m on a sliding freezing microtome and processed for BDA using the avidin-biotin method. Sections were washed three times with PBS, incubated with avidin-biotin solution for 1–2 hours (Vector Elite Standard Kit, Vector Laboratories, CA, USA) and processed with diaminobenzidine (DAB) or the blue SG chromogen (Vector Laboratories, CA, USA). Alternate sections were counterstained with neutral red in order to facilitate identification of nuclear boundaries.

Anatomical Analysis Methods. Labeled fibers, prominent processes and retrogradely labeled cell bodies were plotted onto large drawings using a camera lucida. The plots were then transferred to computer with Corel Draw to aid comparison of cases. No published brain atlas exists for the species studied here, so whenever possible journal papers related to neuroanatomy of *Eptesicus fuscus* were consulted to confirm identification of cytoarchitectural boundaries. When information was unavailable, a rat and mouse atlas was consulted to identify regions with label. Selected sections were photographed through a CCD camera mounted to microscope (Zeiss).

Abbreviations

| | | | |
|------|--|------|--|
| BIC | brachium of the IC | PLa | paralemniscal tegmentum area |
| CP | cerebellar peduncle | PAG | periaqueductal gray |
| CUN | cuneiform nucleus | Pt | pretectal nucleus |
| dMRF | deep mesencephalic reticular formation | Pp | peripeduncular nucleus |
| DNLL | dorsal nucleus of the lateral lemniscus | SC | superior colliculus |
| DTD | dorsal tegmental decussation | Sg | suprageniculate nucleus |
| IC | inferior colliculus | SAI | stratum album intermediale |
| ICC | central nucleus of the inferior colliculus | SAP | stratum album profundum |
| ICX | external shell of the inferior colliculus | SGI | stratum griseum intermediale |
| INLL | inferior nucleus of the lateral lemniscus | SGP | stratum griseum profundum |
| MGB | medial geniculate body | SGS | stratum griseum superficiale |
| nBIC | nucleus of the brachium of the IC | SO | stratum opticum |
| | | SZ | stratum zonale |
| | | SNc | substantia nigra pars compacta |
| | | SNr | substantia nigra pars reticulata |
| | | VNLL | ventral nucleus of the lateral lemniscus |
| | | ZI | zona incerta |

Results

As in other mammals, the SC of the echolocating bat *Eptesicus fuscus* is a mesencephalic multi-lamina structure, with six identifiable laminae when studied in Nissl and myelin stained sections. The two superficial layers, the SZ and SGS found in other mammals, are not clearly identifiable in some bat species, including *Eptesicus fuscus* (Cotter, 1985). We have followed conventional subdivisions and nomenclatures in discussing its structure (Kanaseki and Sprague, 1974). The nucleus in *E. fuscus* is located on the dorsal surface of the brain, rostral to the IC, and spans the dorsal border of the PAG located on the midline (Figure 20A,B). The six SC layers, most evident only across the middle third of the SC's rostral-caudal extent is shown in Figure 20C. We used BDA for both anterograde and retrograde tracing, examined all cases, but for our final analysis we only selected cases in which injections of BDA were confined to within the SC (Figure 21). All cases used for analysis demonstrated similar projection patterns. In general the extent of BDA labeling spanned the majority of layers in SC, and thus prevented specific analysis of projection patterns from and to specific SC layers.

Although retrogradely labeled somata were observed in the contralateral SC, these were few in comparison to those found ipsilaterally. The contralateral cell bodies were found in SGI and SGP. In contrast, numerous labeled fibers were found projecting to the contralateral SC, both to medial as well as lateral contralateral SC, and to intermediate and deep layers. The projecting fibers had few branches.

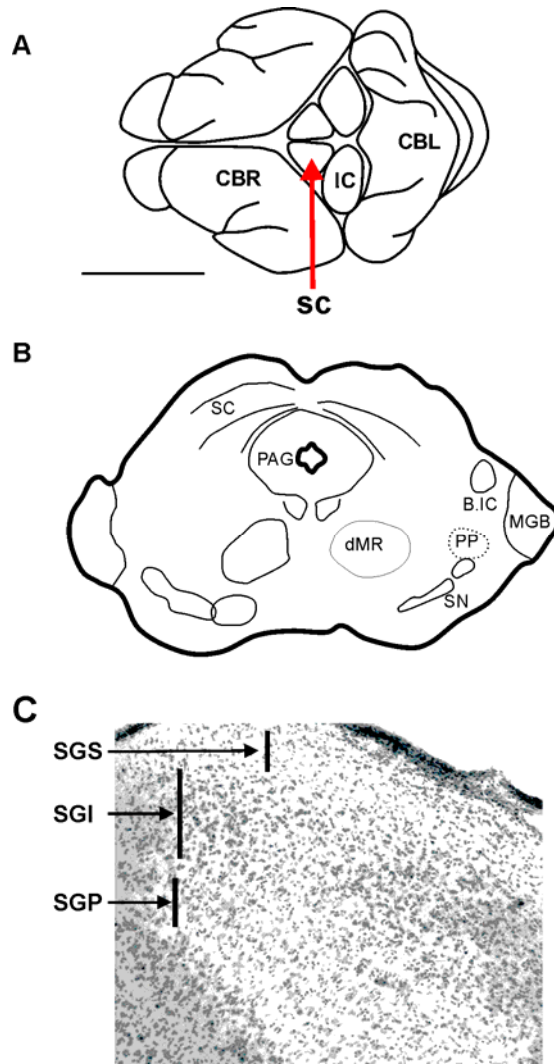

Figure 20 The superior colliculus is a multi-lamina, mesencephalic nucleus.

A) In the bat, *Eptesicus fuscus*, the superior colliculus is located on the dorsal surface, rostral to the inferior colliculus and caudal to the cortical hemispheres. Scale bar is 5 mm. **B)** Sagittal section at a rostral level of the SC. **C)** Nissl-stained sagittal section of the SC delineating the superficial (SGS), and intermediate and deep layers (SGI, SGP). Scale bar = 1mm.

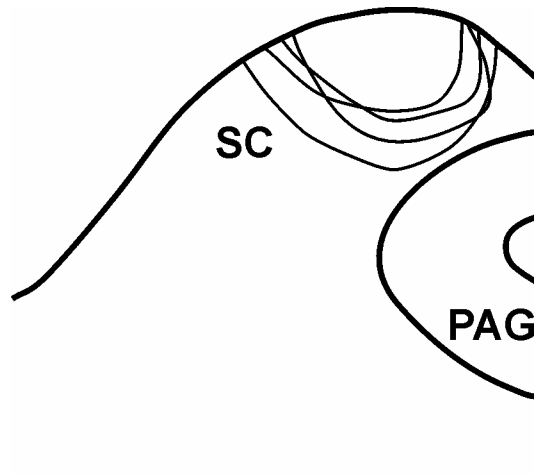

Figure 21 Schematic drawing of the injection sites shown on a representative coronal section through the superior colliculus.

Black traces in the superior colliculus demarcate the estimated extent of injection sites. The extent of the four injection sites used for our analysis never impinged on the PAG. SC, superior colliculus. PAG, periaqueductal gray.

Projection Patterns of Caudal Structures

Retrograde and anterograde connections of the SC were observed in numerous brainstem nuclei. Figure 22 summarizes the results of an exemplar case in which a BDA injection in the SC labeled brainstem nuclei (Figure 22 A–F: A) IC, B) BIC, C) NCAT, D) PAG, E) Cuneiform, F) dMRF). The densest BDA label from the brainstem to the SC originated from auditory nuclei. The most extensive labeling was observed in the ventral region of the ipsilateral ICc, where retrogradely labeled cell bodies and anterogradely labeled fibers and processes formed a well-circumscribed region (Figure 22A). In addition, labeled cell bodies were observed in the ICc dorsally and close to midline, but this label was less dense than that observed in the ventrally located region. A substantial number of labeled fibers were observed projecting mediolaterally through the ipsilateral BIC (Figure 22B), and labeled fibers and cell bodies were also observed in nBIC (Figure 22C).

Label was also identified in a number of non-auditory pathway nuclei. Reciprocal projections were seen to the dorsal PAG (see figure 22D). Numerous fibers extended from SC into the dorsal region of this nucleus, some extending long distances to the underlying third ventricle. A sparse number of large cell bodies were observed in dorsal ipsilateral PAG, close to the border with SC, and had projecting axons into SC. These retrogradely labeled cells were generally observed at the level of the SC injection site. Ipsilateral CUN also showed punctate processes and labeled fibers. The terminations were sparsely distributed across the entire nucleus with more label in the ventral aspect of the nucleus. A few labeled somata were observed in the

medial region of the ipsilateral dMRF (Figure 22F). Anterogradely labeled terminal fields were observed surrounding cell bodies in the medial aspect of the dMRF. In this region of the dMRF small cell bodies were interspersed with larger cell bodies; however, both small and large cell bodies appear to receive putative terminations from SC.

Well-delineated projections to the ventrolateral tegmental region were observed (Figure 23A). This region, referred to as the PLa, is just ventral to caudal SC and IC, and medial and rostral to the dorsal nucleus of the lateral lemniscus. The PLa is most easily distinguished just ventral to the IC, at the head of the lateral lemniscal fiber tract. At this level, in Nissl-stained material, PLa has a circular aspect (Figure 23B), and is encircled by fascicles of the LL that are bifurcating just dorsally at the IC. Cells of PLa form a more loosely organized group of large cell bodies, intermingled with smaller cell bodies, and fusiform magnocellular somata with their major axis oriented mediolaterally (Figure 23C,D). This is in contrast to the cells of the IC and NLL that are more densely packed, smaller, and have more darkly stained somata. In BDA labeled cases this level of PLa had widely branching, thin, distributed labeled processes. BDA labeled fibers and processes medial to the lateral lemniscus extended along the dorsal-ventral extent of the lateral lemniscal tract. Although this label may represent the ventral extension of the PLa, the full ventral extent of the PLa is cytoarchitecturally difficult to discern.

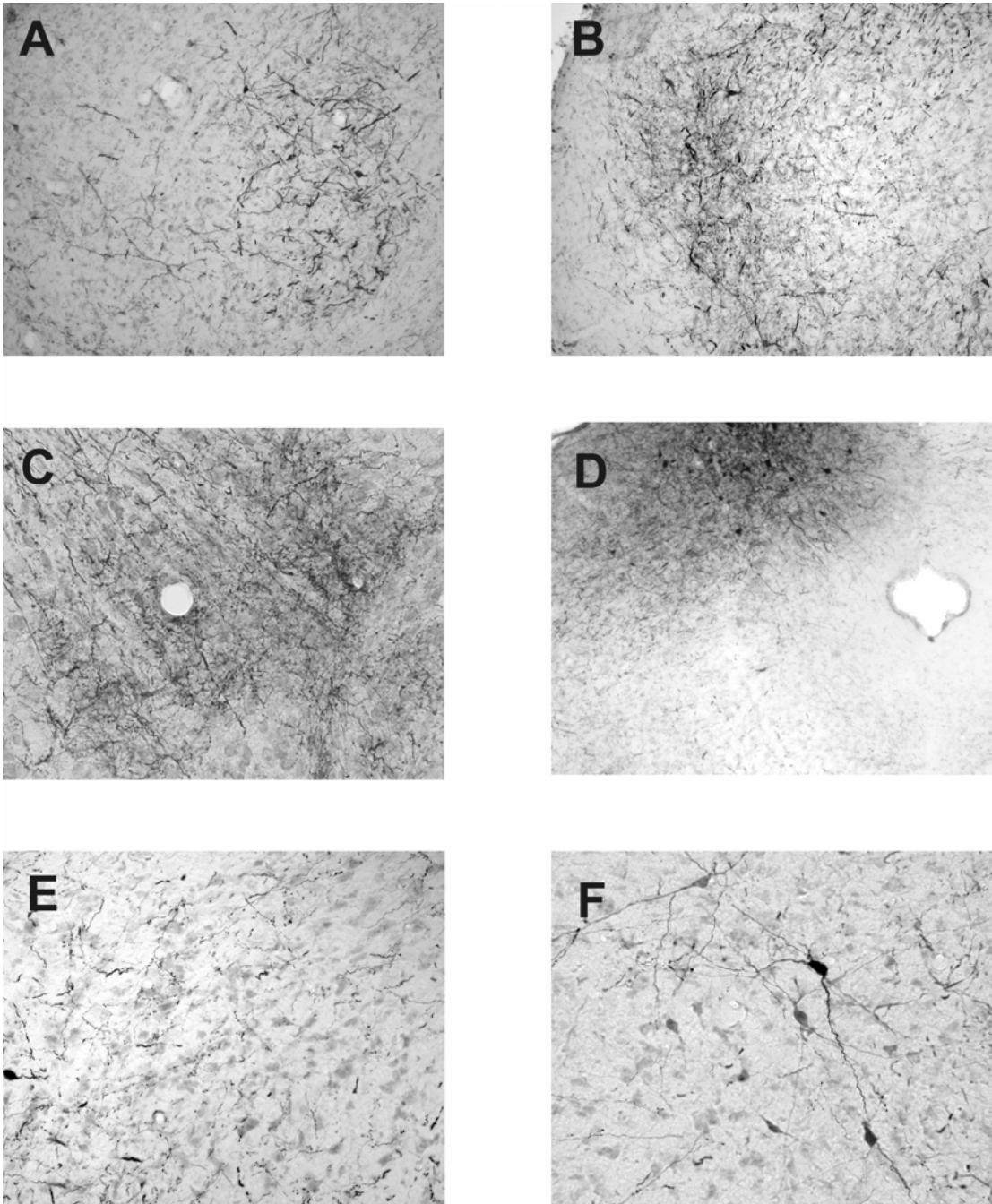

Figure 22 Connections of the superior colliculus with brainstem nuclei.
See caption on next page.

A) Numerous somata and processes were found in the ventral ICc. **B)** The brachium of the IC had many mediolaterally projecting fibers. **C)** Fibers were observed traversing down the lateral lemniscal fiber tract and ending in a region described as the NCAT. **D)** Cell bodies and numerous fibers were found labeled in the dorsal ipsilateral PAG. **E)** Numerous puncta and fibers were found in the CUN. **F)** The region of the dMRF had large labeled somata with well-labeled axons. Photographs in A, B, and C were taken at x20, D at x10, E and F at x40 magnification.

Projections from the SC were strongest to the ipsilateral PLa, while the contralateral PLa showed few retrogradely labeled cell bodies. The region of PLa receiving projections extended approximately 450 μm in the rostrocaudal extent. The rostral boundary of the PLa was conservatively estimated to be 360 μm caudal to injection site.

Other brainstem nuclei had sparse retrograde labeling. Labeled cell bodies were identified in the fastigial and dentate deep cerebellar nuclei, perihypoglossal nucleus and medial vestibular nucleus.

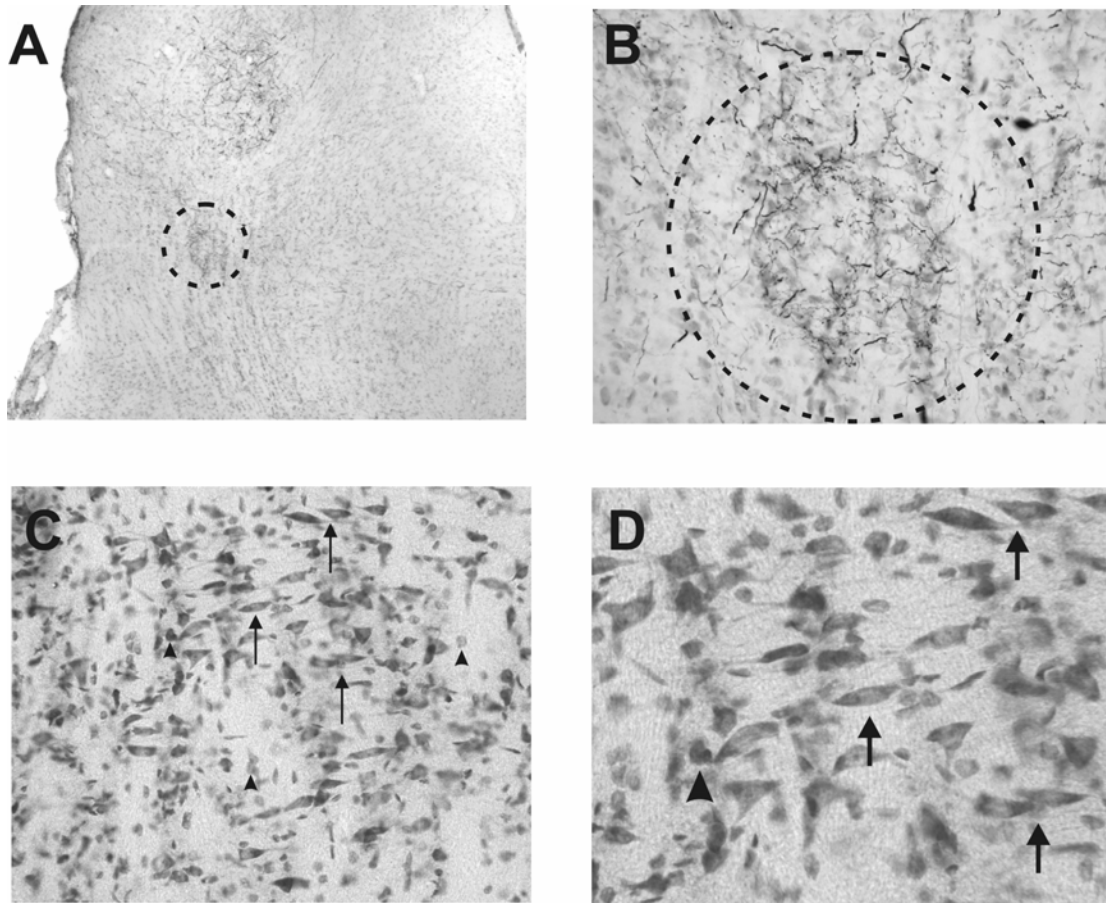

Figure 23 The paralemniscal tegmentum area receives dense innervation from the superior colliculus.

A) Photograph at the level of the IC showing the labeling of the PLa (dashed circle) (x10 magnification). **B)** Increased magnification (x40) of photograph in A, showing the fibers and puncta visible in the PLa. **C)** Both fusiform (vertical arrows) and smaller spherical somata (arrowheads) are found in the PLa (x20). **D)** Magnified (x40) photograph of C showing fusiform somata from C (vertical arrows) and one spherical soma (arrowhead).

Projection Patterns of Rostral Structures

Projections were seen to ventral mesencephalic nuclei, diencephalic nuclei, and auditory cortex. BDA labeled somata were found predominantly in the ipsilateral SN (see figure 24a), with sparse retrograde labeling in the contralateral SN. The cells were Golgi type I neurons, had stellate somata, with thick dendrites and extensive dendritic fields that projected ventrally toward and into the CP. The cells were found in the ventromedial SN, and were cells in SNr and SNc. A few larger-diameter cells with stellate somata were found in the dorsolateral SN, and may represent cells in SNl. These neurons had long dendrites that projected into CP.

The ventral ZI had a large number of labeled somata. Two kinds were observed: the more numerous bipolar fusiform-somata and the smooth spherical somata that were more darkly labeled (see figure 24b). Non-branching dendrites were observed from both types of somata and were oriented along the axis of the ZI. Labeled fibers were observed entering from the medial border.

A large number of fibers were identified in the dorsal thalamus, along with a scattering of cell bodies. Of note were labeled somata in the motor cortex (see figure 24c). These labeled cells were pyramidal cells in layer V. The somata were generally observed across the dorsal extent of motor cortex, but were in assemblies of two or three closely spaced cells. Somata in these assemblies projected dendrites to partner cells, and extended longer dendrites, orthogonal to the layered structure, toward more superficial layers of cortex.

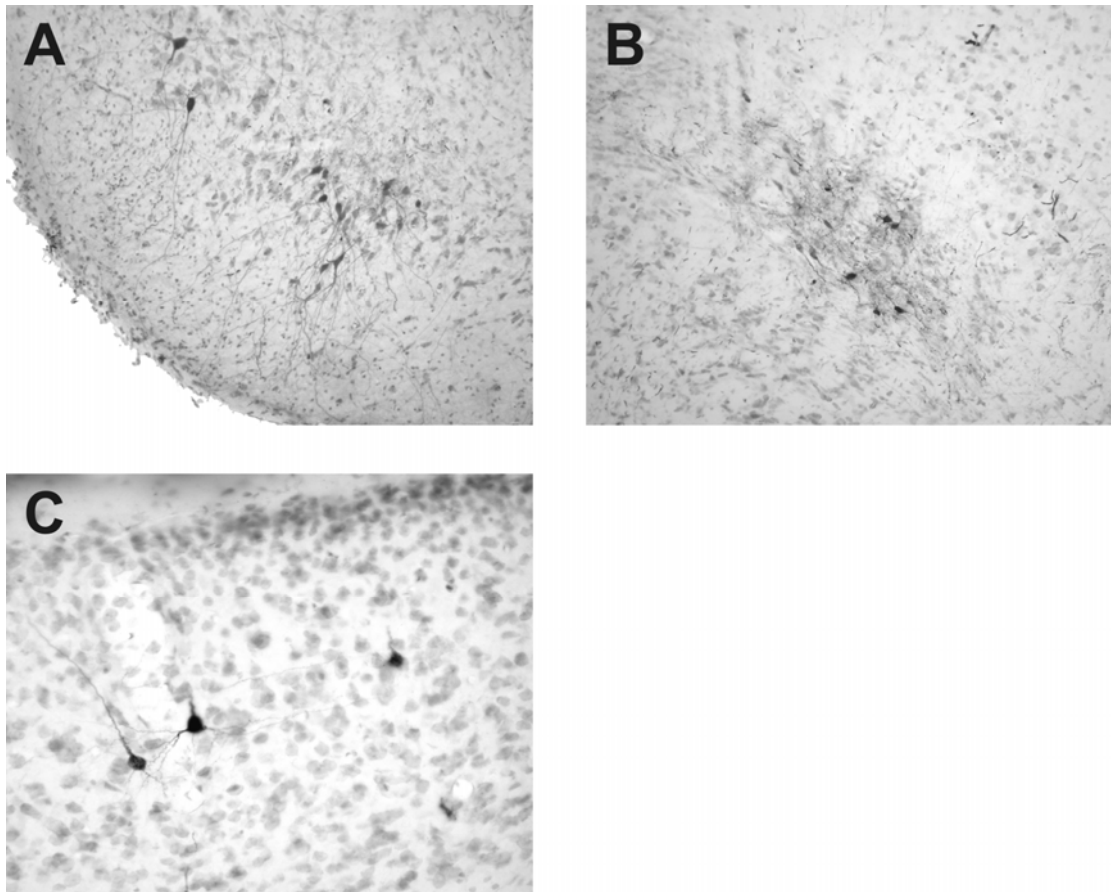

Figure 24 Projections to the SC from basal ganglia, thalamus, and cortex.

A) Large somata, with long aspiny axons were labeled in the SN. **B)** Numerous cell bodies and puncta were localized to the ZI. **C)** Adjacent groups of a two to three somata were labeled in what is likely motor cortex.

Discussion

Echolocating bats are nocturnal, aerial predators that rely primarily on echolocation when foraging and orienting in space (Griffin, 1958). Bats orient in space by adjusting their head, pinna and body aim in flight. In addition, they vary the frequency, harmonic content, call duration and repetition rate of their sonar vocalizations when hunting (Surlykke and Moss, 2000; Wilson and Moss, 2004), and suggests that sonar vocalizations are an integral component of the bats spatial orienting behavior. The control of these sonar vocalizations depends on audio–vocal integration, and one structure implicated in sensori–motor integration is the superior colliculus. In this study we report on the anatomical connections of the midbrain SC in the insectivorous bat, *Eptesicus fuscus*. Specifically we investigated whether the SC in this species had anatomical connections with vocal motor structures. Such efferent connections would provide putative output pathways allowing the SC to influence sonar vocal production. The data from this study provides hodological evidence for a SC projection to vocal pre–motor nuclei, therefore, a tecto–tegmental pathway for influencing sonar vocal production.

The major SC pathways described in this study are schematically illustrated in Figure 25. These pathways can conceptually be organized into three groups: auditory inputs, diencephalic motor control inputs, and outputs to pre–motor nuclei that mediate vocal control. Structures in the first group include the AC, IC, nBIC and DNLL and provide direct auditory input to the SC. The strongest labeling was

observed in the ventral ipsilateral ICc, where labeled cell bodies and terminal fields were identified. Labeling along the BIC was extensive with fibers arrayed in parallel and extending dorsoventrally. The auditory cortex showed labeled somata, with labeled pyramidal cells being in closely spaced groups of two or three. Auditory neurons in the SC of *Eptesicus fuscus* have spatial receptive fields along the three spatial axes: azimuth, elevation, and range (Valentine and Moss, 1997), and this group of projections is likely to contribute to their selectivity. The second group includes dense afferent projections from two diencephalic structures, ZI and SNr, which have been shown to play a role in gating orienting behaviors (Hikosaka and Wurtz, 1983; Hikosaka and Wurtz, 1985b; Basso and Wurtz, 2002; Mitrofanis, 2005; Nicolelis et al., 1992). Further studies will have to be conducted to evaluate the role of these putatively GABAergic projections on the gating of head and pinna movement, and sonar vocal production in bats. The third group includes connections with vocal pre-motor nuclei in the midbrain ventral tegmentum. These include the PLa, where SC projections terminate in a dense field ipsilaterally and sparse terminations contralaterally, and the dMRF, CUN, and dorsal PAG all of which comprise portions of the midbrain vocal-motor circuit in bats.

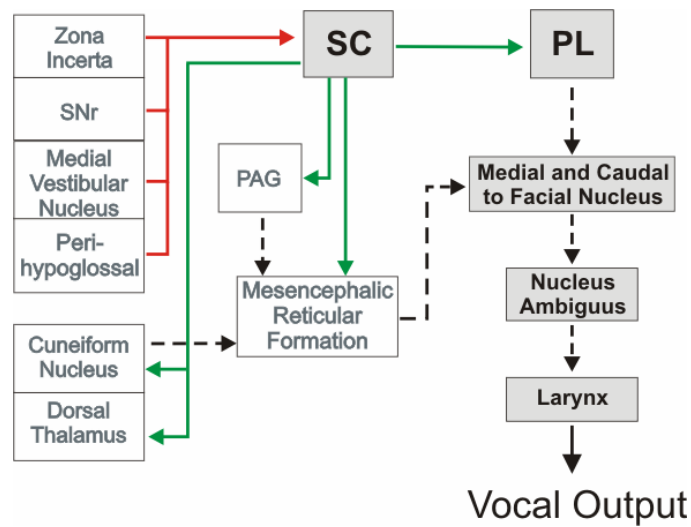

Figure 25 Schematic drawing of the connections identified after tracer injection into the superior colliculus of *Eptesicus fuscus* and vocal motor output pathways.

The primary SC output pathway for influencing sonar vocal production is through anterograde projections onto the PLa and cuneiform nucleus. The PLa in turn projects to the facial nucleus, the vicinity of the where interneurons project to the nucleus ambiguus, and the nucleus ambiguus itself that contains the laryngeal motoneurons. Green arrows are target nuclei identified in this study in *Eptesicus fuscus*. Red arrows are afferent projections to the SC and gate motor control. Black projections are pathways described in other bat species.

An Integrative Role in Vocal Production

Historically, the circuits that underlie sonar vocal production in bats have primarily been investigated at the level of the midbrain ventral tegmentum (Suga et al., 1973; Metzner, 1989; Schuller and Radtke-Schuller, 1990; Metzner, 1996; Pillat and Schuller, 1998; Behrend and Schuller, 2000; Fenzl and Schuller, 2002; Smotherman et al., 2003), the hindbrain (Rübsamen and Schweizer, 1986; Rübsamen and Betz, 1986), and at the level of the larynx (Novick and Griffin, 1961; Schuller and Suga, 1976; Fattu and Suthers, 1981; Rübsamen and Schuller, 1981; Schuller and Rübsamen, 1981; Suthers and Fattu, 1982; Griffiths, 1983; Hartley and Suthers, 1990). These studies have investigated the functional contribution of these midbrain ventral tegmental and hindbrain structures in generating the final spectral and temporal components of sonar vocalizations, their influence and coupling with the respiratory system, and have also attempted to relate them to vocal production pathways in other mammals (Jürgens, 1998; Jürgens, 2002).

By contrast structures like the SC, which has a more integrative function in orienting behavior (Herrero et al., 1998; Isa and Sasaki, 2002; for reviews see, Dean et al., 1989; Sparks, 1999), have received little attention in studies of sonar vocal production, despite its functional role in affecting fundamental aspects of sonar vocal production (Schuller and Radtke-Schuller, 1990; Valentine et al., 2002; Sinha and Moss, 2004). The SC in the echolocating bat could therefore serve as an interface linking cortical and basal ganglia structures involved in auditory, motor control, and

integrative functions with the brainstem vocal control nuclei described above.

Further studies would be required to more fully evaluate this possibility.

Currently, however, some evidence exists to support a role for the SC in sonar vocal production. Two studies have evaluated the potential contribution of non-primary cortical regions in orienting behaviors. The first study (Kobler et al., 1987) identified a region in the frontal cortex of the mustached bat, *Pteronotus parnellii*, which received direct projections from the Sg nucleus of the auditory thalamus and the auditory cortex. In addition this region had direct projections to the SC, which the authors suggested as possible link between the frontal cortex and brainstem motor pathways for mediating control of head, pinna and body orienting behaviors. A second study (Gooler and O'Neill, 1987), also in the mustached bat, *Pteronotus parnellii*, demonstrated that microstimulation of the anterior cingulate cortex elicited both sonar vocalizations and spectrally-complex sounds with audible components (communication-like sounds). These authors used HRP-WGA injections in the anterior cingulate cortex to identify its connections. They primarily found connections with dorsal and ventral thalamic nuclei, and the auditory cortex. However, they did not identify anatomical connections with the superior colliculus, the frontal cortex regions described by Kobler and colleagues, or with the brainstem motor control nuclei. The location of this anterior cingulate region versus the frontal cortex described by Kobler and colleagues is not entirely clear based on their report. Thus while the output pathway from the anterior cingulate region may be indirect and

involve the thalamic target nuclei, it may also be through the frontal cortex as suggested in another study (Kobler et al., 1987).

Another line of evidence supporting SC involvement in sonar vocal production comes from experiments in *Eptesicus fuscus*. In this bat species electrical and chemical microstimulation of the superior colliculus elicits pinna and head movements, similar to those reported in other vertebrate species, with the direction of the evoked behaviors corresponding to the site of stimulation, yielding a map of orienting movements. Stimulation also elicits sonar vocalizations comparable to natural vocalizations of freely echolocating bats (Valentine et al., 2002). Parametric changes in the stimulation parameters result in changes in the number of calls, the repetition rate of the calls, modest variation in call duration, and no changes in call frequency content. Similar findings were made in electrical stimulation experiments of the SC in the horseshoe bat, *Rhinolophus rouxi* (Schuller and Radtke-Schuller, 1990). These results support a role for the superior colliculus in orienting behaviors that also encompasses sonar vocal control.

In further support of a SC role in sonar vocal production are the efferents we observed terminating in the PLa, a structure implicated in sonar vocal production based on anatomical and microstimulation techniques (Metzner, 1989; Schuller and Radtke-Schuller, 1990; Metzner, 1996; Schuller et al., 1997; Fenzl and Schuller, 2002). The PLa has been identified based on its positions in the midbrain ventral tegmentum and in three other bat species: the horseshoe bat, *Rhinolophous rouxi*

(Metzner, 1996), the New World mustached bat, *Pteronotus p. parnellii* (Schuller et al., 1997), and *Phyllostamus discolor* (Fenzl and Schuller, 2002). The regions we have described as the PLa in *Eptesicus fuscus*, is located in the lateral part of the midbrain ventral tegmentum, similar to that described by other authors (Metzner, 1996;Schuller et al., 1997). This region is rostral and medial to DNLL, ventral to the IC, and is characterized by medium and large neurons. Further studies will need to be conducted to verify the pattern of projections of PLa neurons in *Eptesicus fuscus*. Nevertheless, the pattern of PLa projections identified in bat species from different phylogenetic families are consistent; from which we can tentatively infer that the PLa in *Eptesicus* also projects to regions adjacent to the motor nucleus of larynx, the nucleus ambiguus. In addition, the PLa projects to the facial nucleus, probably influencing respiration and orofacial movements (Schuller et al., 1997;Fenzl and Schuller, 2002).

Neurons in the PLa of *R. rouxi* respond to auditory stimuli in an enhanced manner, and electrical microstimulation or pharmacological manipulations influence of PLa neurons elicits sonar vocalizations and pinna movements (Metzner, 1989;Schuller and Radtke-Schuller, 1990;Metzner, 1993). The selectivity of auditory neurons to different spatial stimulus locations was not investigated in these studies. Therefore, while these experiments suggest that the PLa can act as an interface between auditory processing and motor control, they do not address the question of integration of spatial information for initiating and guiding orientation behaviors. The role of initiation and modulation of orienting behaviors could be performed by the

superior colliculus via its sensori–motor integration properties and connections to motor control nuclei.

Control of Orienting Behaviors

The SC in mammals participates in initiating and controlling orienting behaviors via its various connections to brainstem nuclei. SC output is gated both by thalamic and basal ganglia structures associated with motor control, two important structures being the ZI and SNr. In other mammalian species, the ZI and SN send projections to the intermediate and deep layers of the SC, layers with pre–motor neurons. These projections play a permissive role in collicular initiation or modification of orienting responses (Kaelber and Smith, 1979;Hikosaka and Wurtz, 1985b;Chevalier and Deniau, 1990). This has been demonstrated in the ZI of cats using electrical stimulation techniques which elicit distinct eye and head orientating movements (Kaelber and Smith, 1979). In macaques, when SNr cells are pharmacologically inactivated, monkeys produce uncontrolled saccades and cannot fixate a visual target (Hikosaka and Wurtz, 1985b).

Projections of the ZI to SC have been reported previously in macaque, cat and rat (Ficalora and Mize, 1989;Kim et al., 1992;May et al., 1997). In cats and rats these incertotectal projections have been identified as GABAergic neurons projecting to SC, and arises from a cytoarchitectonically distinct ventral subdivision (Grofova et al., 1978;Ficalora and Mize, 1989). The ZI projections terminate primarily within the SGI with a smaller projection in the SGP. In rat, the ZI receives strong projections

from somatosensory structures, and contains a somatotopically-organized representation of body surface. The incertotectal projection is more prominent in the rat, in comparison to the cat, and may be related to the well-developed trigeminal system in rat, and the role that tactile information plays in the initiation of orienting movements in this nocturnal animal. Similarly, echolocating bats are nocturnal, and depend heavily on auditory cues for directing body, head and pinna movements during flight. Consequently, it is possible that the projections of ZI neurons to the SC in bats may provide signals gating or controlling movement and sonar vocal control, or somatosensory information about the body.

Neurons identified in the SNr of non-bat species are GABAergic as well (Vincent et al., 1978; Di Chiara et al., 1979), and project inhibition directly onto SC neurons. The function of these neurons in orienting movements have been well described in the saccadic eye movement system of the macaque (Hikosaka and Wurtz, 1983; Hikosaka and Wurtz, 1985b; Basso and Wurtz, 2002). SNr neurons generally fire at high rates and tonically inhibit saccade-related SC cells in the intermediate and deep SC (Chevalier and Deniau, 1990). However, before saccades to visual targets, these cells briefly reduce their inhibition allowing a burst of spikes in the SC cells that, in turn, leads to initiation of a saccadic eye movement. If the inhibition onto SC cells is removed (by reversibly inactivating the SNr) the monkey makes irrepressible saccades toward the contralateral visual field where cells in the SNr at the injection site have their visual or eye movement field. Also during visual fixation saccadic jerks occur (Hikosaka and Wurtz, 1985a). Thus, the role of the SNr

in the echolocating bat may also be permissive, by controlling when and how much activity in the SC occurs, and thereby gating and controlling the production of head, pinna, and body movements in addition to sonar vocalizations.

The intermediate and deep collicular layers that receive inputs from SNr and ZI, in turn give rise to three major efferent pathways. These pathways innervate ventral tegmentum and hindbrain nuclei involved in control of orienting movements (Masino, 1992). Our injections of BDA into the SC revealed connections with both the ZI and SNr. Thus, the SNr and ZI projections we observe in *Eptesicus fuscus* may serve to gate and control SC activity and thereby influence SC control over orienting movements of the head and pinna, as well as sonar vocal production.

Conclusion

We have shown that the SC of the echolocating bat, *Eptesicus fuscus* (family Vespertilionidae), has projections to pre-vocal nuclei in the midbrain ventral tegmental. These pre-vocal nuclei have been reported to project to motor neurons in the hindbrain. Thus this tecto-tegmental pathway can potentially mediate SC signals for controlling orienting behaviors. These behaviors include head, pinna, and body movements as well as the important sonar vocalizations bat produce for acoustic orienting. This pathway in *E. fuscus* (Vespertilionidae) from the SC via the PLa to brainstem motoneurons, for putatively influencing sonar vocal production, is also observed in three other bat species each from a different phylogenetic family: *Rhinolophous rouxi* (Rhinolophidae), *Pteronotus p. parnellii* (Mormoopidae), and

Phyllostomus discolor (Phyllostomidae). Thus, this pathway appears to be conserved among echolocating bat species, independent of the spectro–temporal structure of their sonar calls, or the degree of specialization observed in their auditory system. Further studies to evaluate the contribution of this pathway to sonar vocal production will prove beneficial to our understanding of audio–motor integration in mammals.

Chapter 4: Conclusion

Gaze in Bats

In the Introduction I referred to gaze in bats and defined it as the locus in space (defined in terms of azimuth, elevation and range) to which bats direct their sensors and sonar beam aim to acquire acoustic information. The echolocating bat adjusts its gaze by changing the direction of its head, pinna, and body during flight. In addition, the bat probes space using discrete sonar vocalizations, and thus the gaze of a bat should also encompass an interval within which echoes are processed. Therefore, the bat's acoustic gaze will refer to a range of times, from a specific location in space, from which the bat receives optimal information.

Echolocating bats contend with echoes from multiple sources in the environment when they forage. By adjusting the spatial component of their acoustic gaze, bats can minimize the interference from clutter echoes. As described in the Introduction, this is accomplished in part by producing a sonar beam pattern with limited spatial extent, and by doing so clutter objects are only weakly ensonified. Since the bat can turn its head, a second method of adjusting spatial gaze is by directing its head aim away from clutter objects. A third possibility is the redirection of the pinna away from clutter echo sources. Since a pinna has acoustic filtering properties, this can minimize the strength of the echo return from specific locations in space. A fourth possibility for the bat is to redirect its flight path away from clutter objects altogether.

Two further possibilities for controlling gaze exist and are related to the production of echolocation pulses. The first involves adjusting the frequency content of the sonar calls. Analysis of the structure of the sonar call itself suggests that it can aid in rejecting clutter echoes, and serve to improve the potential target localization and range estimation accuracy, while reducing the effects of Doppler shifts created by the bats own motion and that of any flying prey (Altes and Titlebaum, 1970; Altes, 1976; Simmons and Stein, 1980). Bats accomplish this by varying the call duration, frequency and harmonic content of their sonar vocalizations. The second method involves changes in the temporal parameters of sonar calls. The temporal features are carefully adjusted during target pursuit sequences, by fine changes in the call duration and the pulse interval, i.e. the time from the onset of one call to the next. We saw evidence for this in Chapter 2 in the oscillating target experiments, where bats reduced the call duration in relation to target distance (Figure 11C, 12; Examples in Appendix 3). Therefore, by measuring the call duration, pulse interval, and the timing of calls relative to target distance we gain insights into where in time the bat is directing its gaze.

Acoustic Gaze Along the Range Axis

One structure involved in orienting gaze is the superior colliculus. The introduction provided an overview of its role in orienting behaviors in echolocating bats. One central question considered in this dissertation is the functional role of the SC in controlling the bat's acoustic gaze. Current models of the SC (Sparks, 2002),

drawing on data related to its involvement in the oculomotor system, suggest that neuronal activity in the SC encodes gaze error, but not the specific behavior to achieve the gaze adjustment. Consequently, activity in the SC orients the axis of the visual fovea, by eye and head movements, in order to direct the visual gaze from the current position to a new location that brings the target onto the visual fovea. If the gaze computations executed by the SC are evolutionarily conserved across organisms and taxa, independent of the specific sensory modalities involved, then it seems reasonable to hypothesize that the bat SC plays a role in the control of acoustic gaze, which for the bat includes vocal production patterns that change with target azimuth, elevation, and distance.

Three lines of evidence support superior colliculus involvement in sonar vocal control. First, the superior colliculus contains populations of auditory neurons that are spatially tuned. These neurons have receptive fields that extend in azimuth and elevation (i.e. direction) or azimuth, elevation and range (i.e. direction and range) (Shimozawa et al., 1984; Reimer, 1991; Valentine and Moss, 1997). They are the putative substrate for an auditory spatial representation within the SC. Second, electrical microstimulation elicits sonar vocalizations (as well as head and pinna movements) and influences the temporal parameters of sonar vocalizations, but not the spectral parameters (Valentine et al., 2002). In addition, chemical microstimulation elicits sonar vocalizations with a larger range of call durations and bandwidths (Valentine et al., 2002) that are part of the natural sonar repertoire of *Eptesicus fuscus* (Surlykke and Moss, 2000). These data suggest that the SC is

sufficiently integrated into a larger vocal circuit to influence the control and production of naturalistic sonar calls recorded. Third, anatomical connections between the superior colliculus and vocal control nuclei have been demonstrated in other bat species (*Pteronotus parnelli*, Covey et al., 1987; *Rhinolophus rouxi*, Schuller et al., 1997) and in *Eptesicus fuscus* (Chapter 3 of this dissertation). These connections serve as a putative output pathway to nuclei that relay or transform SC motor outputs into signals that appropriately drive vocal motor neurons.

The data cited above suggest that the SC is involved in the control and/or production of sonar vocalizations. But what is the nature of this involvement? Does it act solely as a permissive gate for triggering vocalizations (Figure 26A)? Does it control features of sonar vocalizations (Figure 26B)? Can it control both (Figure 26C), therefore, when to vocalize and what type of sonar vocalization to produce?

In support of the gating model in Figure 26A, the electrical microstimulation experiments previously described show a strong coupling between low-level stimulation and the initiation of echolocation calls. In addition, the data presented in Chapter 2 of this dissertation further suggests a role for the SC in triggering calls, as pre-motor activity preceded the vast majority (>93%) of sonar calls. These events occurred in a window of time consistent with, a) previous microstimulation experiments, and b) the range of pulse intervals evident in natural vocal behavior.

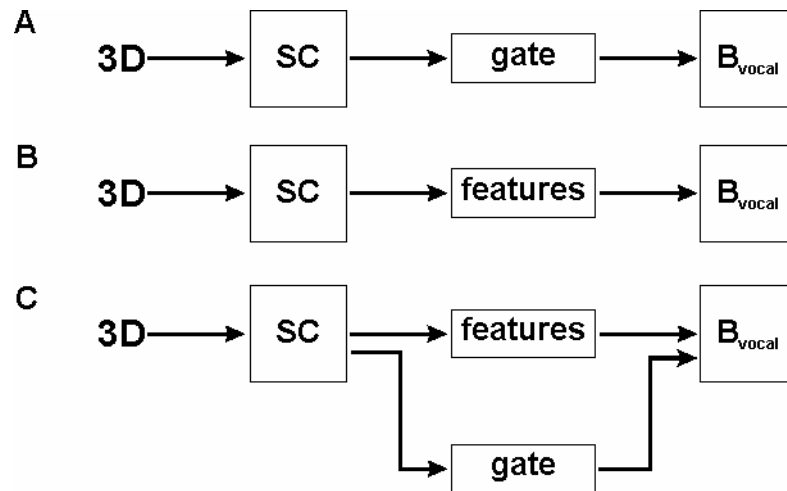

Figure 26 Three potential models depicting the contribution of SC pre-motor commands to sonar vocal production.

Each has a common 3-dimensional input (3D) that represents a separate target-selection mechanism that could arise from within or from outside the SC. B_{VOCAL} represents brainstem vocal control nuclei that interface with other B_{VOCAL} neurons and motor neurons. **A)** In the first model the SC only contributes a gating (WHEN) signal for triggering sonar calls. **B)** In the second model the SC provides a metric-specification (WHAT) signal that specify spectral and temporal sonar call features. **C)** In the third model SC motor commands supply a WHAT signal and a WHEN signal for shaping and gating calls.

The feature model in Figure 26B is supported by data from the oscillating target experiment. The behavioral results convincingly showed that bats carefully adjust the temporal parameters of their sonar calls in relation with target distance (see Chapter 2 of this dissertation, Figure 11C, 12). Second, at many sites in the SC the pre-motor neuronal activity showed changes in timing relative to vocal onset. These changes were related to sonar duration, specifically, the mean long-lead event time preceding each sonar call was linearly related to the call duration. At most recording sites the neural-vocal relationship was linear, with longer mean lead times for longer call durations (Figure 17A). At other sites the relationship only held for a fraction of the total range of call durations produced (Figure 17C). For the remaining call durations, vocal pre-motor activity was present but was not temporally related to call duration or showed other non-linear trends.

Combined, both sets of data support the model presented in Figure 26C, and are consistent with a conceptual model in which the bat SC contributes to acoustic gaze shifts along the range axis by triggering sonar calls and adjusting the call duration to alter the acoustic gaze along the range axis.

Summary

Echolocating bats orient and forage in their environment by producing sonar vocalizations and using the acoustic information in the returning echoes to guide their adaptive orienting behaviors. These behaviors include the production of sonar vocalizations as well as head, pinna and body movements during flight. The variation

in their echolocation behavior while hunting provides insight into the time-scales over which neuronal processes must take place.

This dissertation had three main goals related to the control of sonar vocal production. First, to explore ways in which neuronal activity varies during adaptive behaviors. For this I used the echolocating bat as the model system, and explored the variation in superior colliculus pre-motor activity while bats actively used echolocation. Second, to develop chronic recording techniques to support experiments in unrestrained, freely echolocating bats. And third, to identify putative anatomical pathways by which the superior colliculus can influence sonar vocal control.

For the first goal I designed a behavioral paradigm that permitted tethered, chronic recordings while bats produce realistic sequences of sonar vocalizations in a pseudo-insect capture behavior. The experiments identified vocal pre-motor activity preceding the onset of sonar vocalizations. Furthermore, the activity is specifically related to sonar vocal production and is temporally related to the call duration of the upcoming sonar vocalization. The second goal involved the successful development and integration of light-weight (< 3g), chronic, recording devices and methods. The role of the SC was further supported by tract tracing studies that identified anatomical connections between the SC and pre-vocal motor nuclei. Collectively, these studies provide evidence supporting a role for bat SC in orienting along the range axis. This

has parallels with a function of the SC in primate and feline vision, namely adjusting the depth of focus via vergence eye movements.

Appendices

- Appendix 1 Recording Tools
- Appendix 2 Photographs during an Oscillating Target Trial
- Appendix 3 Oscillating Target Vocal Data Quantification

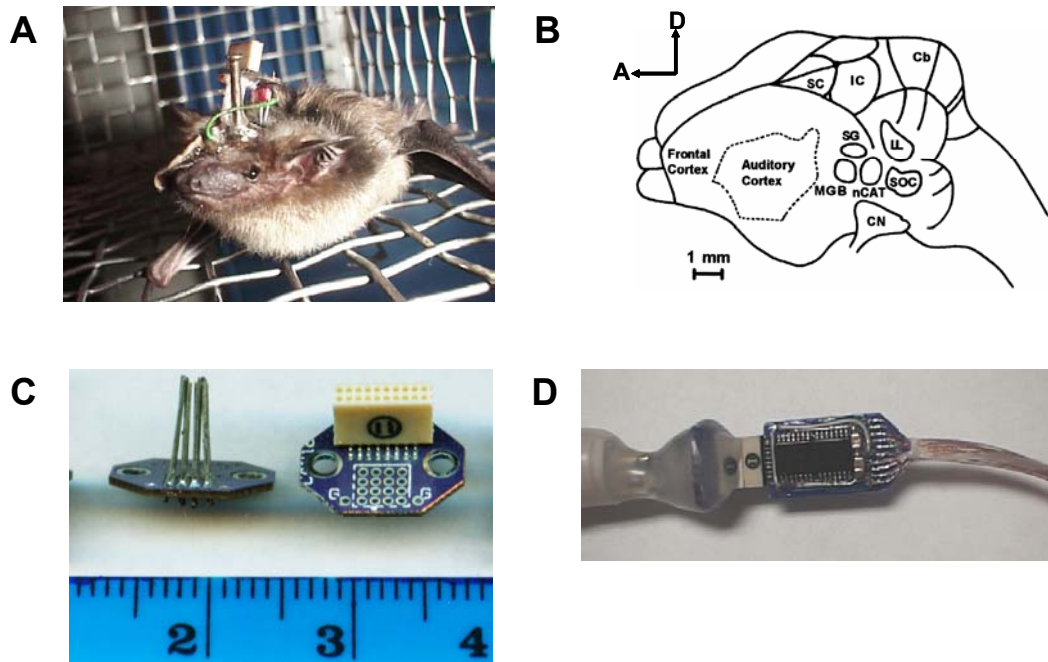

Figure A11 A) Photograph of an echolocating bat, *Eptesicus fuscus*, with implanted electrode interface board (EIB) for neural recordings. B) Schematic of the bat brain showing the physical relationship of the superior colliculus with respect to primary auditory nuclei. C) Electrode interface board with set of 30 gauge cannula. EIB with cannula are <1.2 g. D) Pre-amplifier board that connects the electrode interface board, via a fine gauge wire tether, to recording devices. Scale bar is 1 cm.

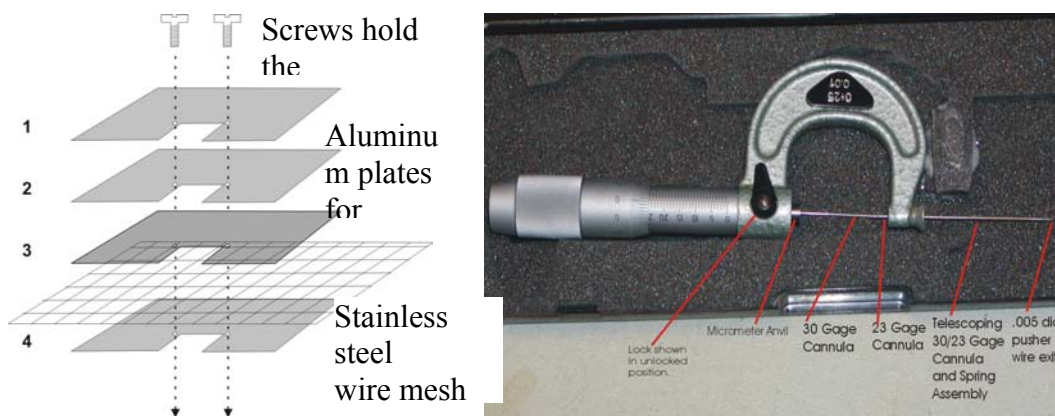

Figure A12 See caption on next page.

Figure AI2 **A)** Schematic of cannula alignment tool used to position, align and hold 30-gauge cannula while assembling the electrode interface board. Screws hold the EIB and screen in alignment with plates. The mesh has a pitch of 178 μm . The cannulae are placed through the EIB and the mesh, to orient them at an angle for subsequent soldering. **B)** A modified micrometer used is used as an electrode pusher to advance electrodes in each penetration.

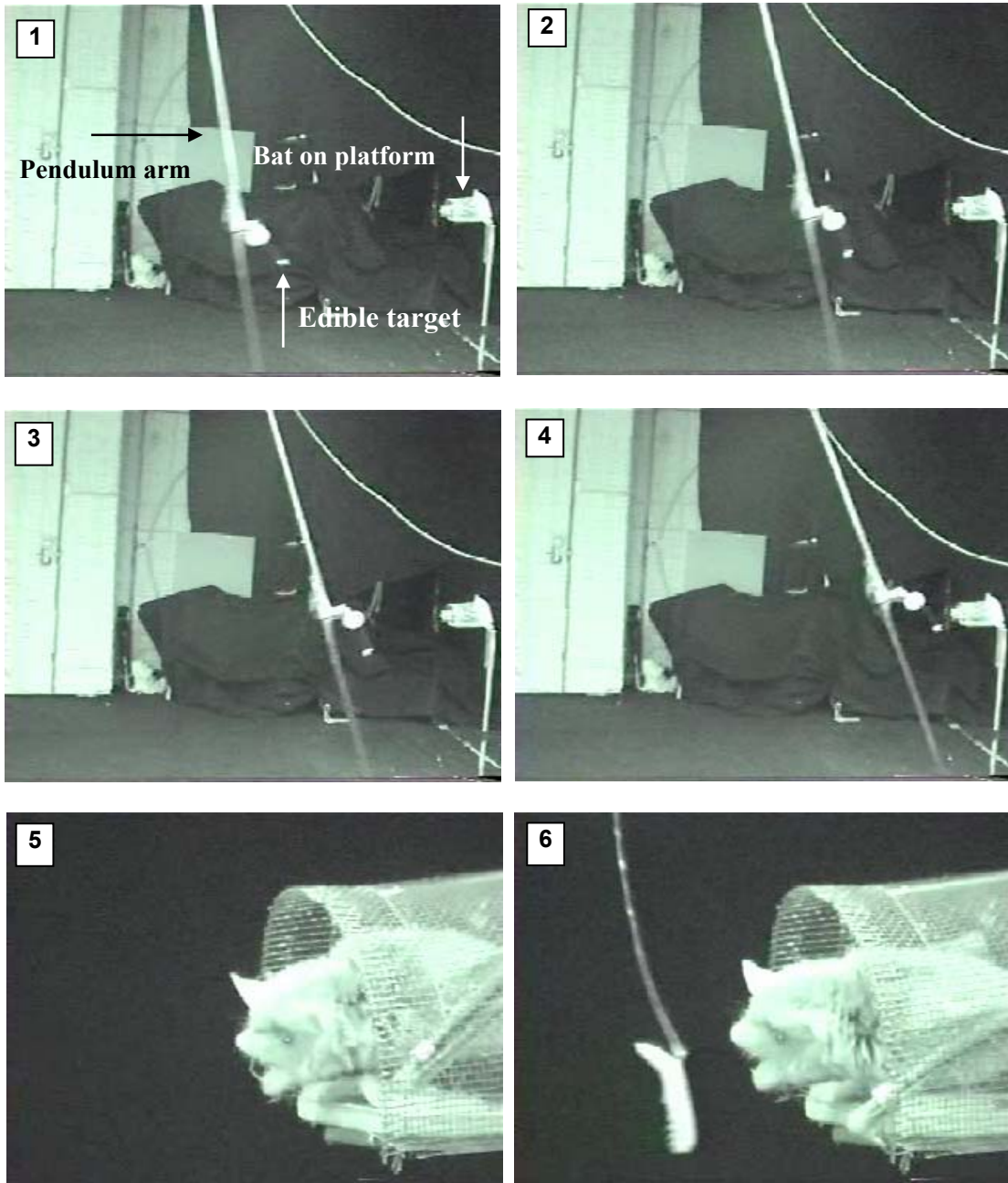

Figure AIII Photographs of oscillating target set-up. (1-4) Bat resting on the platform and use echolocation to capture a swinging tethered edible target. A 30 frame per second camera was used to videotape the bat. Photographs (1-4) are 120 ms apart. All recording sessions are done in low-lighting conditions. (5-6) Close-ups showing bat focusing on target.

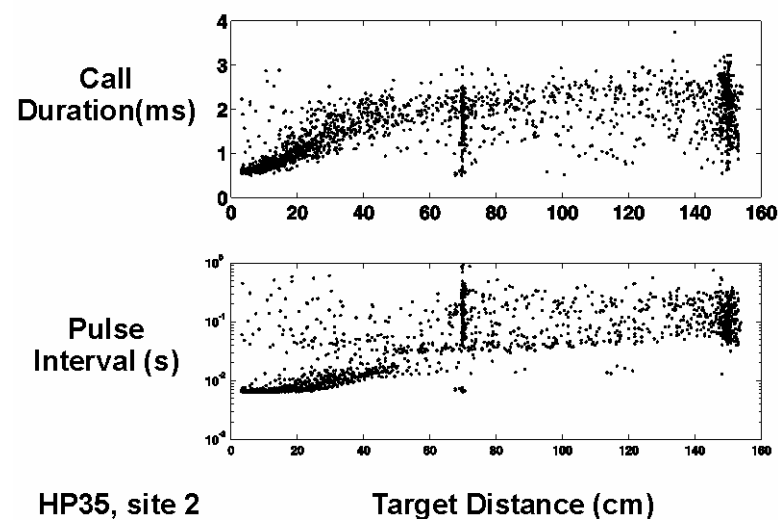
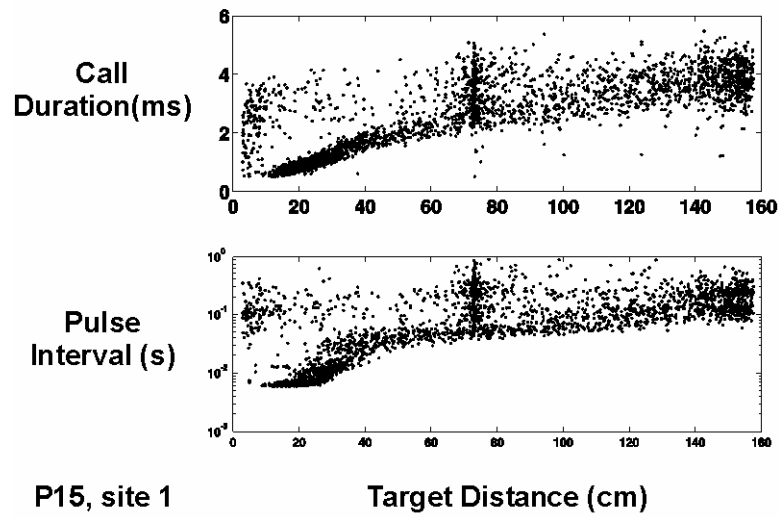
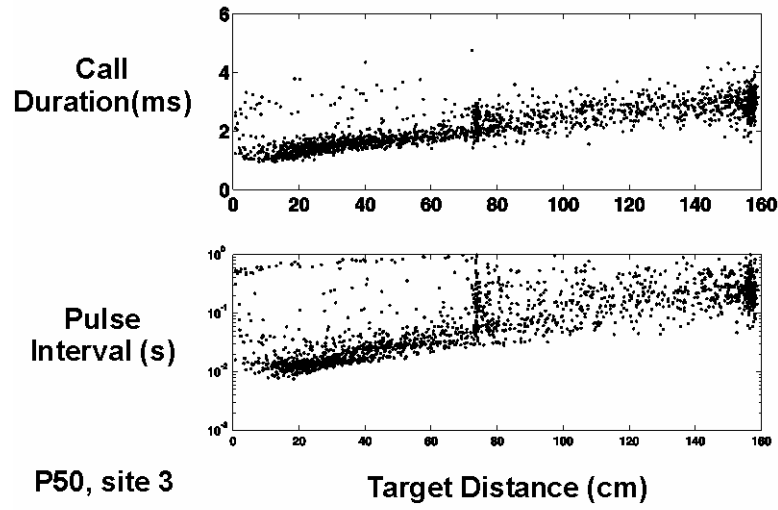
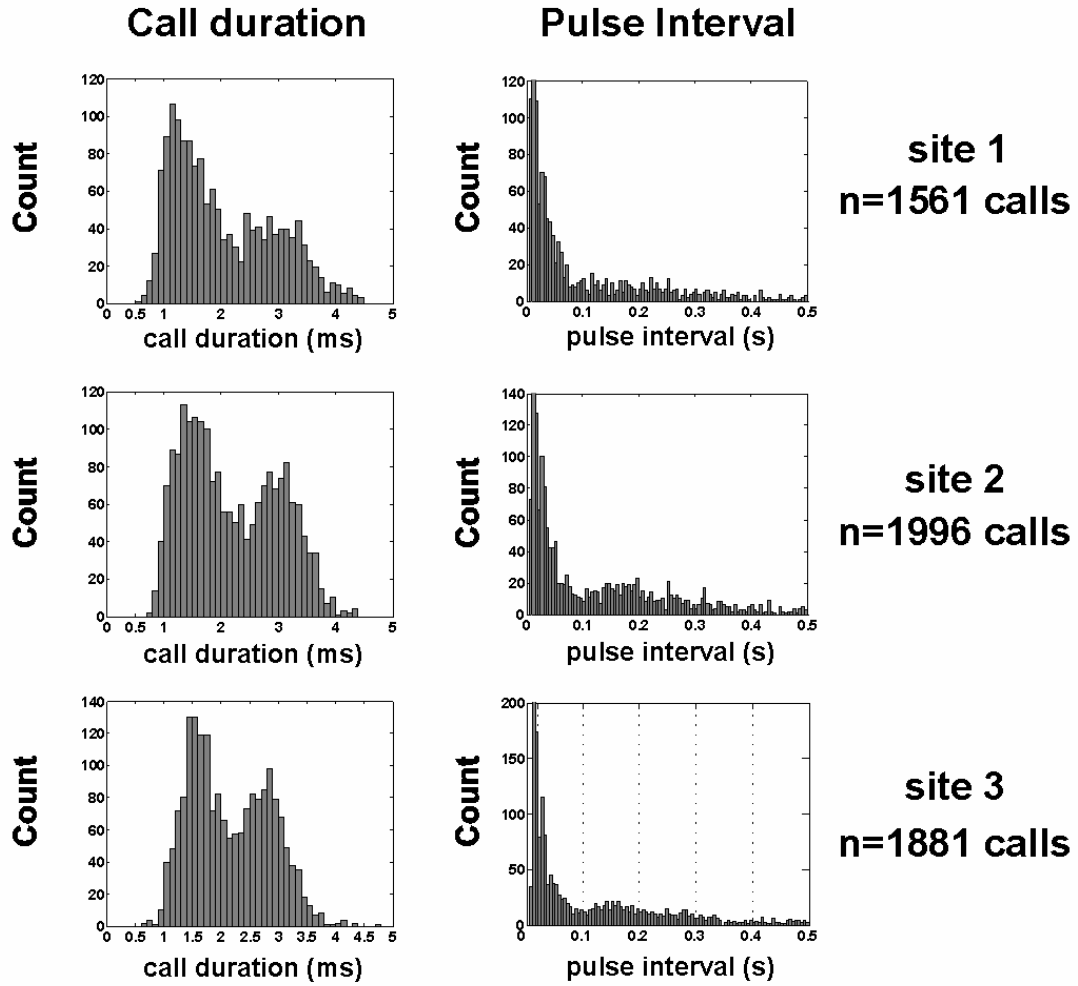

Figure AIII2 Data from three bats that were run in the oscillating target experiment. The sonar call duration and PI respectively are plotted against the PI for all three bats (A, P50, n=1881 calls; B, P15, n=2443 calls; C, HP35, n=1992). Data for each bat is measured from all the sonar calls, from all the trials, during one recordings session. The spread in the call parameters at 70 and 150 cm, represent the resting position and the start position of the pendulum respectively. The pendulum was at rest at these points (before the start of a trial, or before release of the pendulum). All recording sessions are done in low-lighting conditions.

Bat: P50



Bat: P15

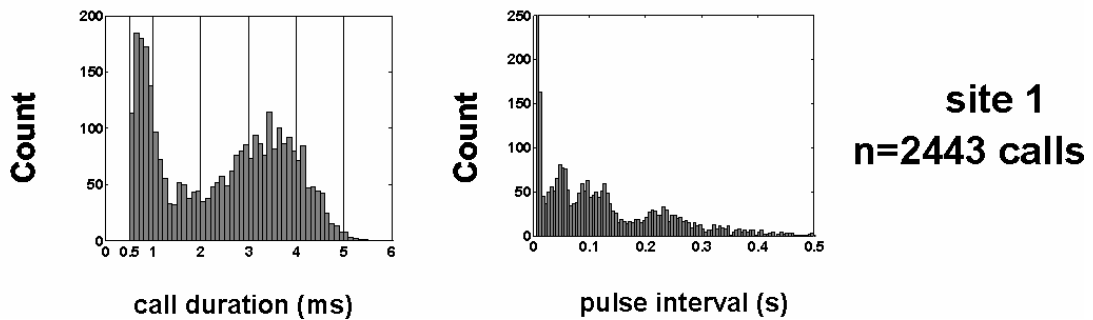
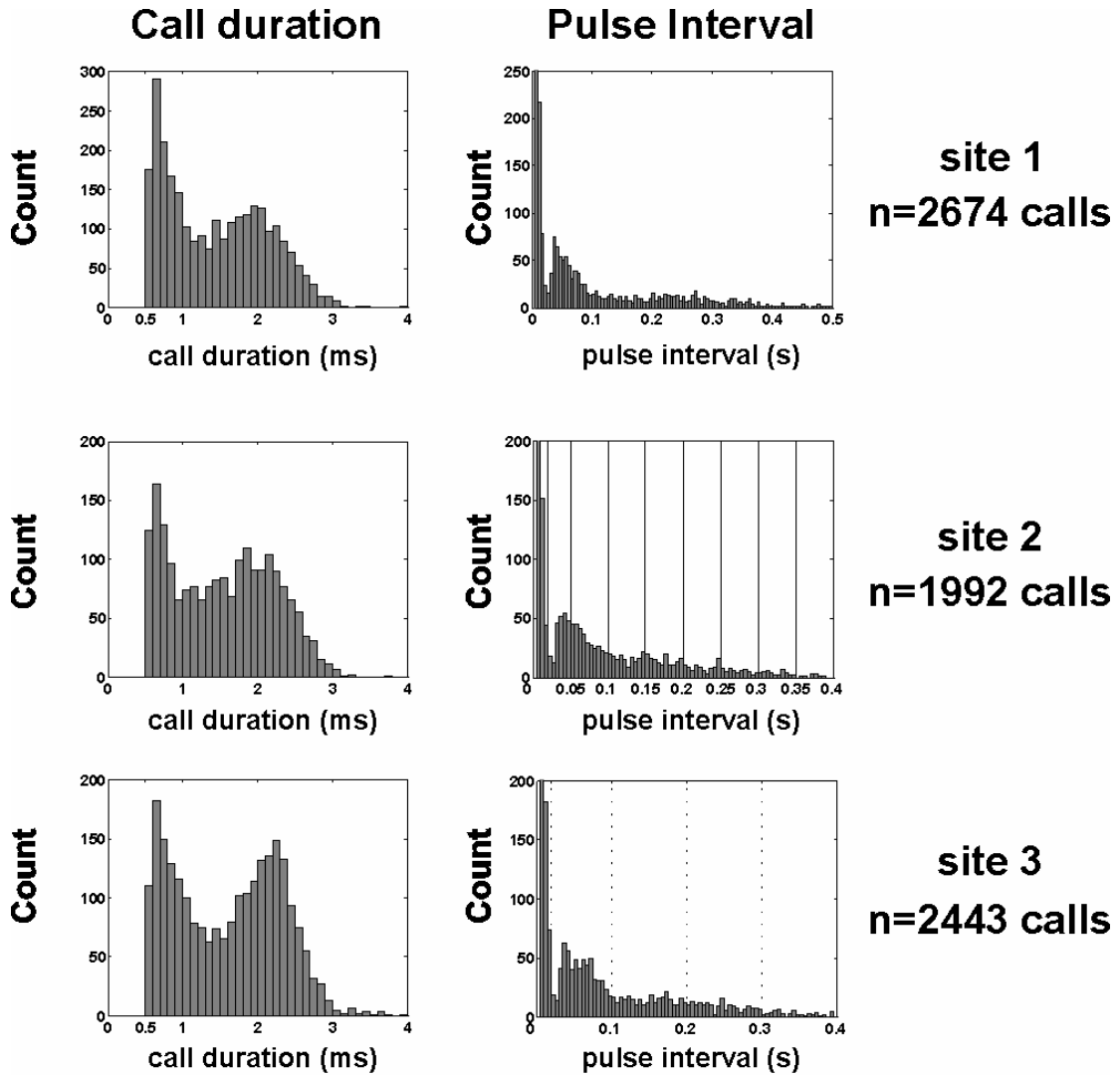

Figure AIII2 Distribution of call duration and PI for all sonar calls, in every trial, for three recording sites in P50, and one site in P15.



Bat: HP35

Figure AIII3 Distribution of call duration and PI for all sonar calls, in every trial, for three recording sites in HP35.

Bibliography

- Ahissar E, Sosnik R, Haidarliu S (2000) Transformation from temporal to rate coding in a somatosensory thalamocortical pathway. *Nature* 406: 302-306.
- Ahissar E, Vaadia E, Ahissar M, Bergman H, Arieli A, Abeles M (1992) Dependence of cortical plasticity on correlated activity of single neurons and on behavioral context. *Science* 257: 1412-1415.
- Aizawa H, Wurtz RH (1998) Reversible inactivation of monkey superior colliculus. I. Curvature of saccadic trajectory. *J Neurophysiol* 79: 2082-2096.
- Albano JE, Wurtz RH (1982) Deficits in eye position following ablation of monkey superior colliculus, pretectum, and posterior-medial thalamus. *J Neurophysiol* 48: 318-337.
- Aldridge HDJN, Rautenback IL (1987) Morphology, echolocation and resource partitioning in insectivorous bats. *J Anim Ecol* 56: 763-778.
- Aloimonos J, Bandopadhyay A, Weiss I (1988) Active vision. *International Journal of Computer Vision* 1: 333-356.
- Altes RA (1976) Sonar for generalized target description and its similarity to animal echolocation systems. *J Acoust Soc Am* 59: 97-105.
- Altes RA, Titlebaum EL (1970) Bat Signals As Optimally Doppler Tolerant Waveforms. *Journal of the Acoustical Society of America* 48: 1014-&.
- Bankman IN, Johnson KO, Schneider W (1993) Optimal detection, classification, and superposition resolution in neural waveform recordings. *IEEE Trans Biomed Eng* 40: 836-841.
- Barber JR, Razak KA, Fuzessery ZM (2003) Can two streams of auditory information be processed simultaneously? Evidence from the gleaner bat *Antrozous pallidus*. *J Comp Physiol A Neuroethol Sens Neural Behav Physiol* 189: 843-855.
- Basso MA, Wurtz RH (2002) Neuronal activity in substantia nigra pars reticulata during target selection. *J Neurosci* 22: 1883-1894.
- Behrend O, Schuller G (2000) The central acoustic tract and audio-vocal coupling in the horseshoe bat, *Rhinolophus rouxi*. *Eur J Neurosci* 12: 4268-4280.
- Bell C, Bodznick D, Montgomery J, Bastian J (1997) The generation and subtraction of sensory expectations within cerebellum-like structures. *Brain Behav Evol* 50 Suppl 1: 17-31.
- Bergeron A, Matsuo S, Guitton D (2003) Superior colliculus encodes distance to target, not saccade amplitude, in multi-step gaze shifts. *Nat Neurosci* 6: 404-413.

- Brecht M, Preilowski B, Merzenich MM (1997) Functional architecture of the mystacial vibrissae. *Behav Brain Res* 84: 81-97.
- Carello CD, Krauzlis RJ (2004) Manipulating intent: evidence for a causal role of the superior colliculus in target selection. *Neuron* 43: 575-583.
- Carvell GE, Simons DJ (1990) Biometric analyses of vibrissal tactile discrimination in the rat. *J Neurosci* 10: 2638-2648.
- Carvell GE, Simons DJ (1995) Task- and subject-related differences in sensorimotor behavior during active touch. *Somatosens Mot Res* 12: 1-9.
- Carvell GE, Simons DJ, Lichtenstein SH, Bryant P (1991) Electromyographic activity of mystacial pad musculature during whisking behavior in the rat. *Somatosens Mot Res* 8: 159-164.
- Casseday JH, Kobler JB, Isbey SF, Covey E (1989) Central acoustic tract in an echolocating bat: an extralemiscal auditory pathway to the thalamus. *J Comp Neurol* 287: 247-259.
- Chaturvedi V, Van Gisbergen JA (1999) Perturbation of combined saccade-vergence movements by microstimulation in monkey superior colliculus. *J Neurophysiol* 81: 2279-2296.
- Chaturvedi V, Van Gisbergen JA (2000) Stimulation in the rostral pole of monkey superior colliculus: effects on vergence eye movements. *Exp Brain Res* 132: 72-78.
- Chevalier G, Deniau JM (1990) Disinhibition as a basic process in the expression of striatal function. *Trends in Neuroscience* 13: 277-280.
- Corneil BD, Olivier E, Munoz DP (2002a) Neck muscle responses to stimulation of monkey superior colliculus. II. Gaze shift and volitional head movements. *J Neurophysiol* 88: 2000-2018.
- Corneil BD, Olivier E, Munoz DP (2002b) Neck muscle responses to stimulation of monkey superior colliculus. I. Topography and manipulation of stimulation parameters. *J Neurophysiol* 88: 1980-1999.
- Cotter JR (1985) Retinofugal projections of the big brown bat, *Eptesicus fuscus*, and the neotropical fruit bat, *Artibeus jamaicensis*. *American Journal of Anatomy* 172: 105-124.
- Cotter JR, Pentney RJP (1979) Retinofugal projection of nonecholocating (*Pteropus giganteus*) and echolocating (*Myotis lucifugus*) bats. *Journal of Comparative Neurology* 184: 381-400.
- Covey E, Hall WC, Kobler JB (1987) Subcortical connections of the superior colliculus in the mustache bat, *Pteronotus parnellii*. *J Comp Neurol* 263: 179-197.
- Cynader M, Berman N (1972) Receptive-field organization of monkey superior colliculus. *J Neurophysiol* 35: 187-201.

- Dacey DM, Ulinski PS (1986) Optic tectum of the eastern garter snake, *Thamnophis sirtalis*. I. Efferent pathways. *J Comp Neurol* 245: 1-28.
- Dean P, Redgrave P, Westby GW (1989) Event or emergency? Two response systems in the mammalian superior colliculus. *Trends Neurosci* 12: 137-147.
- Di Chiara G, Porceddu ML, Morelli M, Mulas ML, Gessa GL (1979) Evidence for a GABAergic projection from the substantia nigra to the ventromedial thalamus and to the superior colliculus of the rat. *Brain Res* 176: 273-284.
- du Lac S, Knudsen EI (1990) Neural maps of head movement vector and speed in the optic tectum of the barn owl. *J Neurophysiol* 63: 131-146.
- du LS, Knudsen EI (1990) Neural maps of head movement vector and speed in the optic tectum of the barn owl. *J Neurophysiol* 63: 131-146.
- Ewert JP (1997) Neural correlates of key stimulus and releasing mechanism: a case study and two concepts. *Trends Neurosci* 20: 332-339.
- Fanselow EE, Sameshima K, Baccala LA, Nicolelis MA (2001) Thalamic bursting in rats during different awake behavioral states. *Proc Natl Acad Sci U S A* 98: 15330-15335.
- Fattu JM, Suthers RA (1981) Subglottic Pressure and the Control of Phonation by the Echolocating Bat, *Eptesicus fuscus*. *Journal of Comparative Physiology* 143: 465-475.
- Feng AS, Simmons JA, Kick SA (1978) Echo detection and target-ranging neurons in the auditory system of the bat *Eptesicus fuscus*. *Science* 202: 645-648.
- Fenton MB (1995) Natural history and biosonar signals. In: *Hearing by Bats* pp 37-86. New York: Springer-Verlag.
- Fenzl T, Schuller G (2002) Periaqueductal gray and the region of the paralemniscal area have different functions in the control of vocalization in the neotropical bat, *Phyllostomus discolor*. *Eur J Neurosci* 16: 1974-1986.
- Ficalora AS, Mize RR (1989) The neurons of the substantia nigra and zona incerta which project to the cat superior colliculus are GABA immunoreactive: a double-label study using GABA immunocytochemistry and lectin retrograde transport. *Neuroscience* 29: 567-581.
- Findlay JM, Gilchrist ID (2003) *Active Vision: The Psychology of Looking and Seeing*. Oxford: Oxford University Press.
- Freedman EG, Standford TR, Sparks DL (1996) Combined eye-head gaze shifts produced by electrical stimulation of the superior colliculus in rhesus monkeys. *J Neurophysiol* 76: 927-952.
- Fuzessery ZM, Buttenhoff P, Andrews B, Kennedy JM (1993) Passive sound localization of prey by the pallid bat (*Antrozous p. pallidus*). *Journal of Comparative Physiology A* 171: 767-777.

- Gamzu E, Ahissar E (2001) Importance of temporal cues for tactile spatial-frequency discrimination. *J Neurosci* 21: 7416-7427.
- Ghazanfar AA, Nicolelis MA (1999) Spatiotemporal properties of layer V neurons of the rat primary somatosensory cortex. *Cereb Cortex* 9: 348-361.
- Ghose K, Moss CF (2003) The sonar beam pattern of a flying bat as it tracks tethered insects. *J Acoust Soc Am* 114: 1120-1131.
- Glimcher PW, Sparks DL (1992) Movement selection in advance of action in the superior colliculus. *Nature* 355: 542-545.
- Gnadt JW, Beyer J (1998) Eye movements in depth: What does the monkey's parietal cortex tell the superior colliculus? *Neuroreport* 9: 233-238.
- Gooler DM, O'Neill WE (1987) Topographic representation of vocal frequency demonstrated by microstimulation of anterior cingulate cortex in the echolocating bat, *Pteronotus parnelli parnelli*. *Journal of Comparative Physiology A* 161: 283-294.
- Gooler DM, O'Neill WE (1992) The central control of biosonar signal production in bats demonstrated by microstimulation of anterior cingulate cortex in the echolocating bat, *Pteronotus parnelli parnelli*. In: *Animal Sonar* pp 153-183.
- Grantyn A, Grantyn R (1982) Axonal patterns and sites of termination of cat superior colliculus neurons projecting in the tecto-bulbo-spinal tract. *Exp Brain Res* 46: 243-256.
- Grantyn R (1988) Gaze control through superior colliculus: structure and function. *Rev Oculomot Res* 2: 273-333.
- Griffin DR (1958) *Listening in the Dark*. Yale University Press.
- Griffin DR, Dunning DC, Cahlander DA, Webster FA (1962) Correlated orientation sounds and ear movements of horseshoe bats. *Nature* 196: 1185-1186.
- Griffin DR, Webster FA, Michael CR (1960) The echolocation of flying insects by bats. *Animal Behavior* 8: 141-154.
- Griffiths TA (1983) Comparative laryngeal anatomy of the big brown bat, *Eptesicus fuscus*, and the mustached bat, *Pteronotus parnelli*. *Mammalia* 47: 377-394.
- Grinnell AD (1963) The neurophysiology of audition in bats: intensity and frequency parameters. *J Physiol* 167: 38-66.
- Grinnell AD, Grinnell VS (1965) Neural correlates of vertical localization by echo-locating bats. *J Physiol* 181: 830-851.
- Grofova I, Ottersen OP, Rinvik E (1978) Mesencephalic and diencephalic afferents to the superior colliculus and periaqueductal gray substance demonstrated by retrograde axonal transport of horseradish peroxidase in the cat. *Brain Res* 146: 205-220.
- Gruberg ER, Kicliter E, Newman EA, Kass L, Hartline PH (1979) Connections of the tectum of the rattlesnake *Crotalus viridis*: an HRP study. *J Comp Neurol* 188: 31-41.

- Guitton D, Munoz DP (1991) Control of orienting gaze shifts by the tectoreticulospinal system in the head-free cat. I. Identification, localization, and effects of behavior on sensory responses. *J Neurophysiol* 66: 1605-1623.
- Gutierrez C, Cox CL, Rinzel J, Sherman SM (2001) Dynamics of low-threshold spike activation in relay neurons of the cat lateral geniculate nucleus. *J Neurosci* 21: 1022-1032.
- Hartley DJ, Campbell KA, Suthers RA (1989) The Acoustic Behavior of the Fish-Catching Bat, *Noctilio-Leporinus*, During Prey Capture. *Journal of the Acoustical Society of America* 86: 8-27.
- Hartley DJ, Suthers RA (1987) The sound emission pattern and the acoustical role of the noseleaf in the echolocating bat, *Carollia perspicillata*. *J Acoust Soc Am* 82: 1892-1900.
- Hartley DJ, Suthers RA (1989) The Sound Emission Pattern of the Echolocating Bat, *Eptesicus-Fuscus*. *Journal of the Acoustical Society of America* 85: 1348-1351.
- Hartley DJ, Suthers RA (1990) Sonar Pulse Radiation and Filtering in the Moustached Bat, *Pteronotus-Parnellii-Rubiginosus*. *Journal of the Acoustical Society of America* 87: 2756-2772.
- Hartline PH, Kass L, Loop MS (1978) Merging of modalities in the optic tectum: infrared and visual integration in rattlesnakes. *Science* 199: 1225-1229.
- Hartridge H (1945) Acoustic control in the flight of bats. *Nature* 156: 490-494.
- Herrero L, Perez P, Nunez AP, Hardy O, Torres B (1999) Tectotectal connectivity in goldfish. *J Comp Neurol* 411: 455-471.
- Herrero L, Rodriguez F, Salas C, Torres B (1998) Tail and eye movements evoked by electrical microstimulation of the optic tectum in goldfish. *Exp Brain Res* 120: 291-305.
- Hess WR, Bürgi S, Bucher VM (1946) Motor function of tectal and tegmental area. *Monatschr Psychiatr Neurol* 112: 1-52.
- Hikosaka O, Wurtz RH (1983) Visual and oculomotor functions of monkey substantia nigra pars reticulata. IV. Relation of substantia nigra to superior colliculus. *J Neurophysiol* 49: 1285-1301.
- Hikosaka O, Wurtz RH (1985a) Modification of saccadic eye movements by GABA-related substances. I. Effect of muscimol and bicuculline in monkey superior colliculus. *J Neurophysiol* 53: 266-291.
- Hikosaka O, Wurtz RH (1985b) Modification of saccadic eye movements by GABA-related substances. II. Effects of muscimol in monkey substantia nigra pars reticulata. *J Neurophysiol* 53: 292-308.
- Hikosaka O, Wurtz RH (1986) Saccadic eye movements following injection of lidocaine into the superior colliculus. *Exp Brain Res* 61: 531-539.

- Hoffmann KP (1973) Conduction velocity in pathways from retina to superior colliculus in the cat: a correlation with receptive fields properties. *J Neurophysiol* 36: 409-424.
- Hollins M, Risner SR (2000) Evidence for the duplex theory of tactile texture perception. *Percept Psychophys* 62: 695-705.
- Hope GM, Bhatnagar KP (1979a) Effect of light adaptation on electrical responses of retinas of four echolocating bats. *Experientia* 35: 1191-1193.
- Hope GM, Bhatnagar KP (1979b) Electrical response of bat retina to spectral stimulation: comparison of four microchiropteran species. *Experientia* 35: 1189-1191.
- Huerta MF, Harting JK (1984a) Connectional organization of the superior colliculus. *Trends in Neuroscience* 286-289.
- Huerta MF, Harting JK (1984b) *The Comparative Neurology of the Optic Tectum*. pp 687-773. New York: Plenum Press.
- Isa T, Sasaki S (2002) Brainstem control of head movements during orienting; organization of the premotor circuits. *Progress in Neurobiology* 66: 205-241.
- Jen PH, Sun X, Kamada T, Zhang S, Shimozawa T (1984) Auditory responses properties and spatial response areas of superior collicular neurons of the FM bat, *Eptesicus fuscus*. *Journal of Comparative Physiology A* 154: 407-413.
- Jen PH, Zhang W, Sun X, Zhang S (1993) Responses of superior collicular neurons of the big brown bat, *Eptesicus fuscus*, to stationary and moving sounds. *Chin J Physiol* 36: 233-243.
- Jen PHS, Suga N (1976) Coordinated activities of middle-ear and laryngeal muscles in echolocating bats. *Science* 191: 950-952.
- Jiang W, Wallace MT, Jiang H, Vaughan JW, Stein BE (2001) Two cortical areas mediate multisensory integration in superior colliculus neurons. *J Neurophysiol* 85: 506-522.
- Jones KE, Purvis A, MacLarnon A, Bininda-Emonds ORP, Simmons NB (2002) A phylogenetic supertree of the bats (Mammalia : Chiroptera). *Biological Reviews* 77: 223-259.
- Jürgens U (1998) Neuronal control of mammalian vocalization, with special reference to the squirrel monkey. *Naturwissenschaften* 85: 376-388.
- Jürgens U (2002) Neural pathways underlying vocal control. *Neurosci Biobehav Rev* 26: 235-258.
- Kaelber WW, Smith TB (1979) Projections of the zona incerta in the cat, with stimulation controls. *Exp Neurol* 63: 177-200.
- Kanaseki T, Sprague JM (1974) Anatomical organization of pretectal nuclei and tectal laminae in the cat. *J Comp Neurol* 158: 319-337.
- Kim U, Gregory E, Hall WC (1992) Pathway from the zona incerta to the superior colliculus in the rat. *J Comp Neurol* 321: 555-575.

- Knierim JJ, McNaughton BL (2001) Hippocampal place-cell firing during movement in three-dimensional space. *J Neurophysiol* 85: 105-116.
- Kobler JB, Isbey SF, Casseday JH (1987) Auditory pathways to the frontal cortex of the mustache bat, *Pteronotus parnellii*. *Science* 236: 824-826.
- Krauzlis R, Dill N (2002) Neural correlates of target choice for pursuit and saccades in the primate superior colliculus. *Neuron* 35: 355-363.
- Krauzlis RJ (2003) Neuronal activity in the rostral superior colliculus related to the initiation of pursuit and saccadic eye movements. *J Neurosci* 23: 4333-4344.
- Krauzlis RJ (2004) Recasting the smooth pursuit eye movement system. *J Neurophysiol* 91: 591-603.
- Krauzlis RJ, Liston D, Carello CD (2004) Target selection and the superior colliculus: goals, choices and hypotheses. *Vision Res* 44: 1445-1451.
- Masino T (1992) Brainstem control of orienting movements: intrinsic coordinate systems and underlying circuitry. *Brain Behav Evol* 40: 98-111.
- Masino T, Grobstein P (1990) Tectal connectivity in the frog *Rana pipiens*: tectotegmental projections and a general analysis of topographic organization. *J Comp Neurol* 291: 103-127.
- Masino T, Knudsen EI (1990) Horizontal and vertical components of head movement are controlled by distinct neural circuits in the barn owl. *Nature* 345: 434-437.
- Masino T, Knudsen EI (1992) Anatomical pathways from the optic tectum to the spinal cord subserving orienting movements in the barn owl. *Exp Brain Res* 92: 194-208.
- Masino T, Knudsen EI (1993) Orienting head movements resulting from electrical microstimulation of the brainstem tegmentum in the barn owl. *J Neurosci* 13: 351-370.
- Masters WM, Raver KAS (1996) The degradation of distance discrimination in big brown bats (*Eptesicus fuscus*) caused by different interference signals. *Journal of Comparative Physiology A* 179: 703-713.
- May PJ, Sun W, Hall WC (1997) Reciprocal connections between the zona incerta and the pretectum and superior colliculus of the cat. *Neuroscience* 77: 1091-1114.
- McCormick DA, von Krosigk M (1992) Corticothalamic activation modulates thalamic firing through glutamate 'metabotropic' receptors. *Proceedings of the National Academy of Science, USA* 89: 2774-2778.
- Meredith MA, Wallace MT, Stein BE (1992) Visual, auditory and somatosensory convergence in output neurons of the cat superior colliculus: multisensory properties of the tecto-reticulo-spinal projection. *Exp Brain Res* 88: 181-186.
- Metzner W (1989) A possible neuronal basis for Doppler-shift compensation in echolocating horseshoe bats. *Nature* 341: 529-532.

- Metzner W (1993) An audio-vocal interface in echolocating horseshoe bats. *J Neurosci* 13: 1899-1915.
- Metzner W (1996) Anatomical basis for audio-vocal integration in echolocating horseshoe bats. *J Comp Neurol* 368: 252-269.
- Metzner W, Zhang S, Smotherman M (2002) Doppler-shift compensation behavior in horseshoe bats revisited: auditory feedback controls both a decrease and an increase in call frequency. *J Exp Biol* 205: 1607-1616.
- Miles FA (1985) Adaptive regulation in the vergence and accommodation control systems. In: *Adaptive mechanisms in gaze control: Facts and Theories* (Berthoz, Jones M, eds), pp 81-94. Elsevier Science Publishers BV.
- Mitrofanis J (2005) Some certainty for the "zone of uncertainty"? Exploring the function of the zona incerta. *Neuroscience* 130: 1-15.
- Mize RR (1996) Neurochemical microcircuitry underlying visual and oculomotor function in the cat superior colliculus. *Prog Brain Res* 112: 35-55.
- Mohler CW, Wurtz RH (1976) Organization of monkey superior colliculus: intermediate layer cells discharging before eye movements. *J Neurophysiol* 39: 722-744.
- Moschovakis AK, Karabelas AB (1985) Observations on the somatodendritic morphology and axonal trajectory of intracellularly HRP-labeled efferent neurons located in the deeper layers of the superior colliculus of the cat. *J Comp Neurol* 239: 276-308.
- Moschovakis AK, Karabelas AB, Highstein SM (1988) Structure-function relationships in the primate superior colliculus. II. Morphological identity of presaccadic neurons. *J Neurophysiol* 60: 263-302.
- Moschovakis AK, Kitama T, Dalezios Y, Petit J, Brandi AM, Grantyn AA (1998) An anatomical substrate for the spatiotemporal transformation. *J Neurosci* 18: 10219-10229.
- Moschovakis AK, Scudder CA, Highstein SM (1996) The microscopic anatomy and physiology of the mammalian saccadic system. *Prog Neurobiol* 50: 133-254.
- Moss CF, Schnitzler H-U (1995) Behavioral studies of auditory information processing. In: *Hearing by Bats* pp 87-145. Berlin: Springer-Verlag.
- Moss CF, Surlykke A (2001) Auditory scene analysis by echolocation in bats. *J Acoust Soc Am* 110: 2207-2226.
- Moss CF, Surlykke A, Bohn K, Gilkenson H (2005) Active listening for spatial orientation in a complex auditory scene. *Public Library of Science*.
- Munoz DP, Guitton D, Pelisson D (1991) Control of orienting gaze shifts by the tectoreticulospinal system in the head-free cat. III. Spatiotemporal characteristics of phasic motor discharges. *J Neurophysiol* 66: 1642-1666.

- Munoz DP, Wurtz RH (1995a) Saccade-related activity in monkey superior colliculus I. Characteristics of burst and buildup cells. *J Neurophysiol* 73: 2313-2333.
- Munoz DP, Wurtz RH (1995b) Saccade-related activity in the monkey superior colliculus. II. spread of activity during saccades. *J Neurophysiol* 73: 2334-2348.
- Munoz DP, Guitton D (1991) Control of orienting gaze shifts by the tectoreticulospinal system in the head-free cat. II. Sustained discharges during motor preparation and fixation. *J Neurophysiol* 66: 1624-1641.
- Neisser U (1976) *Cognition and Reality: Principles and implications of cognitive psychology*. San Francisco: W.H. Freeman and Company.
- Neuweiler G (1990) Auditory Adaptations for Prey Capture in Echolocating Bats. *Physiological Reviews* 70: 615-641.
- Neuweiler G (1993) *The biology of bats*. New York: Oxford University Press.
- Neuweiler G (2003) Evolutionary aspects of bat echolocation. *J Comp Physiol A Neuroethol Sens Neural Behav Physiol* 189: 245-256.
- Nicolelis MA, Chapin JK, Lin RC (1992) Somatotopic maps within the zona incerta relay parallel GABAergic somatosensory pathways to the neocortex, superior colliculus, and brainstem. *Brain Res* 577: 134-141.
- Nicolelis MA, Fanselow EE (2002a) Dynamic shifting in thalamocortical processing during different behavioural states. *Philos Trans R Soc Lond B Biol Sci* 357: 1753-1758.
- Nicolelis MA, Fanselow EE (2002b) Thalamocortical [correction of Thalamocortical] optimization of tactile processing according to behavioral state. *Nat Neurosci* 5: 517-523.
- Novick A, Griffin DR (1961) Laryngeal mechanisms in bats for the production of orientation sounds. *J Exp Zool* 148: 125-145.
- Oertel D (1999) The role of timing in the brain stem auditory nuclei of vertebrates. *Annu Rev Physiol* 61: 497-519.
- Olivier E, Corvisier J, Pauluis Q, Hardy O (2000) Evidence for glutamatergic tectotectal neurons in the cat superior colliculus: a comparison with GABAergic tectotectal neurons. *Eur J Neurosci* 12: 2354-2366.
- Palmer LA, Rosenquist AC (1975) Single-unit studies in the cat. *Neurosci Res Program Bull* 13: 214-220.
- Papez J (1929) Central acoustic tract in cat and man. *Anatomical Records* 42: 60.
- Pentney RJP, Cotter JR (1976a) Retinofugal projections in the echolocating bat. *Brain Research* 115: 479-484.
- Pentney RP, Cotter JR (1976b) Retinofugal projections in an echolocating bat. *Brain Res* 115: 479-484.

- Pettigrew JD, Dreher B, Hopkins CS, McCall MJ, Brown M (1988) Peak density and distribution of ganglion cells in the retinae of microchiropteran bats: implications for visual acuity. *Brain Behav Evol* 32: 39-56.
- Pillat J, Schuller G (1998) Audiovocal behavior of Doppler-shift compensation in the horseshoe bat survives bilateral lesion of the paralemniscal tegmental area. *Exp Brain Res* 119: 17-26.
- Poussin C, Schlegel P (1984) Directional sensitivity of auditory neurons in the superior colliculus of the bat, *Eptesicus fuscus*, using free field sound stimulation. *Journal of Comparative Physiology A* 154: 253-261.
- Pye JD, Roberts LH (1970) Ear movements in a hipposiderid bat. *Nature* 255: 285-286.
- Quaia C, Aizawa H, Optican LM, Wurtz RH (1998) Reversible inactivation of monkey superior colliculus. II. Maps of saccadic deficits. *J Neurophysiol* 79: 2097-2110.
- Rashbass C (1961) the relationship between saccadic and smooth tracking eye movements. *Journal of Physiology* 159: 326-339.
- Reimer K (1991) Auditory properties of the superior colliculus in the horseshoe bat, *Rhinolophus rouxi*. *J Comp Physiol [A]* 169: 719-728.
- Richmond BJ, Wurtz RH (1980) Vision during saccadic eye movements. II. A corollary discharge to monkey superior colliculus. *J Neurophysiol* 43: 1156-1167.
- Robinson DA (1972) Eye movements evoked by collicular stimulation in the alert monkey. *Vision Res* 12: 1795-1808.
- Roucoux A, Crommelinck M (1976) Eye movements evoked by superior colliculus stimulation in the alert cat. *Brain Res* 106: 349-363.
- Rübsamen R, Betz M (1986) Control of echolocation pulses by neurons of the nucleus ambiguus in the rufous horseshoe bat, *Rhinolophus rouxi*. I. Single unit recordings in the ventral motor nucleus of the laryngeal nerves in spontaneously vocalizing bats. *J Comp Physiol [A]* 159: 675-687.
- Rübsamen R, Schuller G (1981) Laryngeal Nerve Activity During Pulse Emission in the Cf-Fm Bat, *Rhinolophus ferrumequinum*. II. The Recurrent Laryngeal Nerve. *Journal of Comparative Physiology* 143: 323-327.
- Rübsamen R, Schweizer H (1986) Control of echolocation pulses by neurons of the nucleus ambiguus in the rufous horseshoe bat, *Rhinolophus rouxi*. II. Afferent and efferent connections of the motor nucleus of the laryngeal nerves. *J Comp Physiol [A]* 159: 689-699.
- Sales GD, Pye JD (1974) *Ultrasonic communication by animals*. London: Chapman and Hall.
- Schiller PH, Malpeli JG (1977) Properties and tectal projections of monkey retinal ganglion cells. *J Neurophysiol* 40: 428-445.

- Schiller PH, Malpeli JG, Schein SJ (1979) Composition of geniculostriate input of superior colliculus of the rhesus monkey. *J Neurophysiol* 42: 1124-1133.
- Schiller PH, Stryker M (1972) Single-unit recording and stimulation in superior colliculus of the alert rhesus monkey. *J Neurophysiol* 35: 915-924.
- Schiller PH, Stryker M, Cynader M, Berman N (1974) Response characteristics of single cells in the monkey superior colliculus following ablation or cooling of visual cortex. *J Neurophysiol* 37: 181-194.
- Schlegel PA, Jen PH, Singh S (1988) Auditory spatial sensitivity of inferior collicular neurons of echolocating bats. *Brain Res* 456: 127-138.
- Schneider GE (1969) Two visual systems. *Science* 163: 895-902.
- Schnitzler HU (1973) Control of Doppler-Shift Compensation in Greater Horseshoe Bat, *Rhinolophus-Ferrumequinum*. *Journal of Comparative Physiology* 82: 79-92.
- Schnitzler HU, Flieger E (1983) Detection of Oscillating Target Movements by Echolocation in the Greater Horseshoe Bat. *Journal of Comparative Physiology* 153: 385-391.
- Schnitzler HU, Kalko EKV (2001) Echolocation by insect-eating bats. *Bioscience* 51: 557-569.
- Schnitzler HU, Moss CF, Denzinger A (2003) From spatial orientation to food acquisition in echolocating bats. *Trends in Ecology & Evolution* 18: 386-394.
- Schuller G, Fischer S, Schweizer H (1997) Significance of the paralemniscal tegmental area for audio-motor control in the moustached bat, *Pteronotus p. parnellii*: the afferent and efferent connections of the paralemniscal area. *Eur J Neurosci* 9: 342-355.
- Schuller G, Radtke-Schuller S (1990) Neural control of vocalization in bats: mapping of brainstem areas with electrical microstimulation eliciting species-specific echolocation calls in the rufous horseshoe bat. *Exp Brain Res* 79: 192-206.
- Schuller G, Rübsamen R (1981) Laryngeal Nerve Activity During Pulse Emission in the Cf-Fm Bat, *Rhinolophus-Ferrumequinum*. I. Superior Laryngeal Nerve (External Motor Branch). *Journal of Comparative Physiology* 143: 317-321.
- Schuller G, Suga N (1976) Laryngeal Mechanisms for Emission of Cf-Fm Sounds in Doppler-Shift Compensating Bat, *Rhinolophus-Ferrumequinum*. *Journal of Comparative Physiology* 107: 253-262.
- Scudder CA, Moschovakis AK, Karabelas AB, Highstein SM (1996a) Anatomy and physiology of saccadic long-lead burst neurons recorded in the alert squirrel monkey. I. Descending projections from the mesencephalon. *J Neurophysiol* 76: 332-352.
- Scudder CA, Moschovakis AK, Karabelas AB, Highstein SM (1996b) Anatomy and physiology of saccadic long-lead burst neurons recorded in the alert squirrel monkey. II. Pontine neurons. *J Neurophysiol* 76: 353-370.

- Segraves MA, Goldberg ME (1987) Functional properties of corticotectal neurons in the monkey's frontal eye field. *J Neurophysiol* 58: 1387-1419.
- Semba K, Komisaruk BR (1984) Neural substrates of two different rhythmical vibrissal movements in the rat. *Neuroscience* 12: 761-774.
- Sereno MI (1985) Tectoreticular pathways in the turtle, *Pseudemys scripta*. I. Morphology of tectoreticular axons. *J Comp Neurol* 233: 48-90.
- Sherman SM (2001) Tonic and burst firing: dual modes of thalamocortical relay. *Trends Neurosci* 24: 122-126.
- Shimozawa T, Suga N, Hendler P, Schuetze S (1974) Directional sensitivity of echolocation system in bats producing frequency-modulated signals. *J Exp Biol* 60: 53-69.
- Shimozawa T, Sun X, Jen PH (1984) Auditory space representation in the superior colliculus of the big brown bat, *Eptesicus fuscus*. *Brain Res* 311: 289-296.
- Simmons J, Fenton MB, O'Farrell MJ (1979) Echolocation and pursuit of prey by bats. *Science* 203: 16-21.
- Simmons J, Lawrence BD (1982) Echolocation in bats: The external ear and perception of the vertical position of targets. *Science* 218: 481-483.
- Simmons JA (1973) The resolution of target range by echolocating bats. *J Acoust Soc Am* 54: 157-173.
- Simmons JA (1979) Perception of echo phase information in bat sonar. *Science* 204: 1336-1338.
- Simmons JA, Eastman KM, Horowitz SS, O'Farrell MJ, Lee DN (2001) Versatility of biosonar in the big brown bat, *Eptesicus fuscus*. *Acoustics Research Letters Online* 2: 43-48.
- Simmons JA, Ferragamo M, Moss CF, Stevenson SB, Altes RA (1990) Discrimination of jittered sonar echoes by the echolocating bat, *Eptesicus fuscus*: the shape of target images in echolocation. *J Comp Physiol [A]* 167: 589-616.
- Simmons JA, Howell DJ, Suga N (1975) Information content of bat sonar echoes. *Am Sci* 63: 204-215.
- Simmons JA, Kick SA, Moffat AJ, Masters WM, Kon D (1988) Clutter interference along the target range axis in the echolocating bat, *Eptesicus fuscus*. *J Acoust Soc Am* 84: 551-559.
- Simmons JA, Lavender WA, Lavender BA, Childs JE, Hulebak K, Rigden MR, Sherman J, Woolman B, O'Farrell MJ (1978) Echolocation by the free-tailed bat (*Tadarida*). *J Comp Physiol* 125: 291-299.
- Simmons JA, Stein RA (1980) Acoustic Imaging in Bat Sonar - Echolocation Signals and the Evolution of Echolocation. *Journal of Comparative Physiology* 135: 61-84.
- Sinha, S. R. and Moss, C. F. Vocal pre-motor activity in the superior colliculus of freely echolocating bats varies with call duration. *Society for Neuroscience* . 2004.

Sinha, S. R., Roberts, T. F., and Moss, C. F. Circuitry for Orienting Behavior in the FM-bat, *Eptesicus fuscus*: Anatomical Connections of the Superior Colliculus. Society for Neuroscience . 2000.

Smotherman M, Metzner W (2004) Auditory-feedback control of temporal call patterns in echolocating horseshoe bats. *J Neurophysiol*.

Smotherman M, Zhang S, Metzner W (2003) A Neural Basis for Auditory Feedback Control of Vocal Pitch. *J Neurosci* 23: 1464.

Sommer MA, Wurtz RH (2004) What the brain stem tells the frontal cortex. II. Role of the SC-MD-FEF pathway in corollary discharge. *J Neurophysiol* 91: 1403-1423.

Sparks DL (1978) Functional properties of neurons in the monkey superior colliculus: coupling of neuronal activity and saccade onset. *Brain Res* 156: 1-16.

Sparks DL (1986) Translation of sensory signals into commands for control of saccadic eye movements: role of primate superior colliculus. *Physiol Rev* 66: 118-171.

Sparks DL (1999) Conceptual issues related to the role of the superior colliculus in the control of gaze. *Curr Opin Neurobiol* 9: 698-707.

Sparks DL (2002) The brainstem control of saccadic eye movements. *Nat Rev Neurosci* 3: 952-964.

Sparks DL, Holland R, Guthrie BL (1976) Size and distribution of movement fields in the monkey superior colliculus. *Brain Res* 113: 21-34.

Sprague JM, Meikle TH Jr (1965) The role of the superior colliculus in visually guided behavior. *Exp Neurol* 11: 115-146.

Stanton GB, Goldberg ME, Bruce CJ (1988) Frontal eye field efferents in the macaque monkey: II. Topography of terminal fields in midbrain and pons. *J Comp Neurol* 271: 493-506.

Stein BE, Clamann HP (1981) Control of pinna movements and sensorimotor register in cat superior colliculus. *Brain Behav Evol* 19: 180-192.

Stein BE, Meredith MA (1993) *The merging of the senses*. Cambridge, Mass: MIT Press.

Steriade M, Deschenes M (1988) Intrathalamic and brainstem-thalamic networks involved in resting and alert states. In: *Cellular thalamic mechanisms* (Bentivoglio M, Spreafico R, eds), pp 37-62. Amsterdam: Elsevier.

Steriade M, Jones EG, Llinas R (1990) *Brainstem control of wakefulness and sleep*. New York: Wiley.

Strother GK, Mogus M (1970) Acoustical beam patterns for bats: some theoretical considerations. *Journal of the Acoustical Society of America* 48: 1430-1432.

- Suga N, O'Neill WE, Manabe T (1978) Cortical neurons sensitive to combinations of information-bearing elements of biosonar signals in the mustache bat. *Science* 200: 778-781.
- Suga N, Schlegel P (1972) Neural attenuation of responses to emitted sounds in echolocating rats. *Science* 177: 82-84.
- Suga N, Schlegel P, Shimozawa T, Simmons J (1973) Orientation sounds evoked from echolocating bats by electrical stimulation of the brain. *J Acoust Soc Am* 54: 793-797.
- Suga N, Yajima Y (1989) Auditory-vocal integration in the midbrain of the mustached bat: Periaqueductal gray and the reticular formation. In: *Animal Sonar* pp 87-107.
- Sun X, Jen PH, Kamada T (1983) Neurons in the superior colliculus of echo-locating bats respond to ultrasonic signals. *Brain Res* 275: 148-152.
- Sur M, Sherman SM (1982) Linear and nonlinear W-cells in C-laminae of the cat's lateral geniculate nucleus. *J Neurophysiol* 47: 869-884.
- Surlykke A, Moss CF (2000) Echolocation behavior of big brown bats, *Eptesicus fuscus*, in the field and the laboratory. *J Acoust Soc Am* 108: 2419-2429.
- Suthers RA (1966) Optomotor responses by echolocating bats. *Science* 152: 1102-1104.
- Suthers RA, Chase J, Braford B (1969) Visual form discrimination by echolocating bats. *Biol Bull* 137: 535-546.
- Suthers RA, Fattu JM (1973) Fishing behaviour and acoustic orientation by the rat (*Noctilio labialis*). *Anim Behav* 21: 61-66.
- Suthers RA, Fattu JM (1982) Selective Laryngeal Neurotomy and the Control of Phonation by the Echolocating Bat, *Eptesicus*. *Journal of Comparative Physiology* 145: 529-537.
- Suzuki S, Suzuki Y, Ohtsuka K (2004) Convergence eye movements evoked by microstimulation of the rostral superior colliculus in the cat. *Neurosci Res* 49: 39-45.
- Troyer TW, Doupe AJ (2000) An associational model of birdsong sensorimotor learning I. Efference copy and the learning of song syllables. *J Neurophysiol* 84: 1204-1223.
- Valentine DE, Moss CF (1997) Spatially selective auditory responses in the superior colliculus of the echolocating bat. *J Neurosci* 17: 1720-1733.
- Valentine DE, Sinha SR, Moss CF (2002) Orienting responses and vocalizations produced by microstimulation in the superior colliculus of the echolocating bat, *Eptesicus fuscus*. *J Comp Physiol A Neuroethol Sens Neural Behav Physiol* 188: 89-108.
- Vincent SR, Hattori T, McGeer EG (1978) The nigrotectal projection: a biochemical and ultrastructural characterization. *Brain Res* 151: 159-164.
- Wadsworth J, Moss CF (2000) Vocal control of acoustic information for sonar discriminations by the echolocating bat, *Eptesicus fuscus*. *J Acoust Soc Am* 107: 2265-2271.

- Wallace MT, Meredith MA, Stein BE (1993) Converging influences from visual, auditory, and somatosensory cortices onto output neurons of the superior colliculus. *J Neurophysiol* 69: 1797-1809.
- Wallace MT, Wilkinson LK, Stein BE (1996) Representation and integration of multiple sensory inputs in primate superior colliculus. *J Neurophysiol* 76: 1246-1266.
- Walls GL (1963) *The vertebrate eye and its adaptive radiation*. New York: Hafner Publishing Company.
- Welker WI (1964) Analysis of sniffing behavior of the albino rat. *Behaviour* 12: 223-244.
- Wilson WW, Moss CF (2004) Sensory-motor behavior of free-flying bats during target capture. In: *Echolocation in bats and dolphins* (Thomas AT, Moss CF, Vater M, eds), pp 22-27. Chicago: The University of Chicago Press.
- Wineski LE (1985) Facial morphology and vibrissal movement in the golden hamster. *J Morphol* 183: 199-217.
- Wong D (1984) Spatial tuning of auditory neurons in the superior colliculus of the echolocating bat, *Myotis lucifugus*. *Hear Res* 16: 261-270.
- Wotton JM, Haresign T, Ferragamo MJ, Simmons JA (1996) Sound source elevation and external ear cues influence the discrimination of spectral notches by the big brown bat, *Eptesicus fuscus*. *J Acoust Soc Am* 100: 1764-1776.
- Wurtz RH, Albano JE (1980) Visual-motor function of the primate superior colliculus. *Annu Rev Neurosci* 3: 189-226.
- Wurtz RH, Goldberg ME (1971) Superior colliculus cell responses related to eye movements in awake monkeys. *Science* 171: 82-84.
- Zhang SQ, Sun XD, Jen PH (1987) Anatomical study of neural projections to the superior colliculus of the big brown bat, *Eptesicus fuscus*. *Brain Res* 416: 375-380.