

ABSTRACT

Title of Thesis: INVESTIGATING A PUTATIVE NON STRUCTURAL
PROTEIN OF THE BIRNAVIRUS DROSOPHILA-X VIRUS

Jason Eric Savage, Master of Science, 2004

Thesis directed by: Dr. Louisa Wu, Center for Biosystems Research, University of
Maryland Biotechnology Institute

Drosophila-X Virus (DXV) is the prototype virus of the *Entomobirnavirus* genera in the family *Birnaviridae*; its genome consists of two double-stranded RNA segments. DXV has two open reading frames on segment A, one encoding a polyprotein and the other capable of encoding a putative 27-kDa non structural protein (DXV-NS).

This project investigated the existence of DXV-NS since this putative protein is unique to *Birnaviridae*. Research into the nature of DXV-NS was furthered by the development of a number of tools: recombinant baculovirus and a stable *Drosophila* cell line expressing DXV-NS; an antibody against NS; a reporter construct to test a potential -1 frameshift signal. Though in the course of this research much was learned about DXV-NS, the greater question as to whether this open reading frame is expressed by DXV or is merely an artifact remains elusive.

INVESTIGATING A PUTATIVE NON STRUCTURAL PROTEIN OF THE
BIRNAVIRUS DROSOPHILA-X VIRUS

by

Jason Eric Savage

Thesis submitted to the Faculty of the Graduate School of the
University of Maryland, College Park in partial fulfillment
of the requirements for the degree of
Master of Science
2004

Advisory Committee:

Professor Wenxia Song, Chair
Professor Vikram N. Vakharia
Professor Louisa Wu

© Copyright by
Jason Eric Savage
2004

ACKNOWLEDGEMENTS

I want to take this opportunity to thank my committee, first and foremost my advisor Dr. Louisa Wu for accepting me into her laboratory as well for her support and encouragement. Many thanks also go to Dr. Vikram N. Vakharia for his invaluable expert advice and collaboration in the Birnavirus field as well as providing the genesis of this project. Finally, thanks to Wenxia Song for agreeing to chair this committee on such short notice as well as for taking the time to provide me with some valuable suggestions despite her extremely busy schedule.

I would like to extend my thanks to the members of my lab, especially Robert Zambon with whom I have worked closely over these years in the study of Drosophila-X Virus. Student researchers Diana Levy and Madhu Nandakumar assisted me with the fly injections.

The investigation into DXV frameshifting was made possible by the support of Dr. Jonathan Dinman as well as material assistance from Jonathan Jacobs and Dr. Ewan Plant. Hamp Edwards gave essential support with Sf9 cell culture as well as with plaque purification of the recombinant baculovirus.

Thank you to the CBMG Virology Program Training Grant committee for selecting me for financial support under NIH T32AI51967.

And finally, thank you so much to my family and friends, especially my parents and Megan Dougherty. I could not have done this without all of your continued support.

TABLE OF CONTENTS

List of Tables.....	v
List of Figures	vi
List of Abbreviations.....	viii
Chapter 1 Introduction and Background	
1.1 Introduction.....	1
1.2 DXV Discovery.....	2
1.3 DXV Taxonomy.....	2
1.4 DXV Physical Properties and Structure.....	6
1.5 Properties of the DXV-NS Putative Protein.....	12
1.6 Putative Mechanisms for NS Expression.....	16
1.7 Infection in Flies.....	18
1.8 Infection in Cell Culture.....	21
Chapter 2 Materials and Methods	
2.1 Cell Lines.....	22
2.2 DXV Growth and Propagation.....	23
2.3 DXV Injections.....	24
2.4 RNA Isolation from Flies.....	24
2.5 Real-time Quantitative PCR.....	25
2.6 Polypeptide Antibody.....	25
2.7 SDS-PAGE and Western Blots.....	27
2.8 Cloning the Putative NS Protein.....	28
2.9 Plasmid Recovery and Sequencing.....	30
2.10 Subcloning into Expression Vectors.....	31
2.11 Expression Vectors.....	31
2.12 Expression in BL21 Bacteria.....	33
2.13 Plasmid Stability Assay.....	34
2.14 Increasing Plasmid Stability.....	34
2.15 Transfection of S2 Cells.....	35
2.16 β -Galactosidase Control Assay.....	36
2.17 Metallothionein Induction in pMT Plasmid.....	36
2.18 Selection of Stable Cell Line Expressing DXV-NS.....	37
2.19 Expression in Baculovirus.....	38
2.20 Frameshift Signal.....	40

Chapter 3	Results	
3.1	Quantitative PCR Detects Relative DXV Titer In Infected <i>Drosophila</i>	42
3.2	Antibodies Developed to Detect of Endogenous and Recombinant DXV-NS.....	43
3.3	Expression of Recombinant DXV-NS in Four Vectors.....	46
3.4	Lack of DXV-NS expression in BL21 <i>E. coli</i>	46
3.5	Lack of DXV-NS expression from pMT metallothionein-driven vector.....	53
3.6	Expression of DXV-NS in stably transfected S2 cells.....	57
3.7	Expression of DXV-NS from recombinant Baculovirus.....	63
3.8	DXV-NS contains a putative upstream frameshift signal.....	66
Chapter 4	Discussion and Conclusions	
4.1	Conclusions.....	70
4.2	Future Study.....	74
References.....		77

LIST OF TABLES

Table 1. Known and projected Drosophila-X Virus proteins.....	13
Table 2. Primers used in the construction of NS expression plasmids.....	29
Table 3. Plasmid stability assay results.....	52

LIST OF FIGURES

Figure 1. Electron micrograph of Drosophila-X Virus.....	3
Figure 2. Comparison of the genome structures of the three prototypical Birnnaviruses.....	5
Figure 3. Sequence of Drosophila-X Virus segment A.....	7
Figure 4. DXV-NS putative protein sequence and bipartite nuclear targeting sequence.....	15
Figure 5. DXV survival curves in Oregon R <i>Drosophila melanogaster</i>	19
Figure 6. Anti-DXV-NS antibody epitope sequence.....	26
Figure 7. His-tagged DXV-NS recombinant expression products from four different vectors.....	32
Figure 8. Frameshift sequence oligonucleotides.....	41
Figure 9. Increase in Drosophila-X Virus titer over time in flies.....	44
Figure 10. Forward and reverse priming sites for pET15b-NS construct.....	48
Figure 11. Multiple cloning site and plasmid diagram for pET15b.....	49
Figure 12. BL21 cells with the pET15b-NS expression construct.....	50
Figure 13. Forward and reverse priming sites for pMT-NS construct.....	55
Figure 14. Multiple cloning site and plasmid diagram for pMT/V5-His.....	56
Figure 15. Priming sites in two-step PCR reaction for pAc5.1-NS construct.....	58
Figure 16. Multiple cloning site and plasmid diagram for pAc5.1/V5-His.....	60
Figure 17. Expression of constitutively active pAc5.1-NS construct in S2 cells.....	62
Figure 18. Forward and reverse priming sites for pBlueBacHis2c construct.....	64

Figure 19. Multiple cloning site and plasmid diagram for pBlueBacHis2c.....65

Figure 20. Expression of DXV-NS/His fusion protein from recombinant
baculovirus..... 67

Figure 21. Portion of DXVA showing -1 PRF site68

LIST OF ABBREVIATIONS

-1 PRF	Programmed -1 ribosomal frameshifting
AMP	Ampicillin
bp	Base Pairs
CARB	Carbenicillin
CEF cells	Chicken Embryo Fibroblast cells
CHSE-214	Chinook Salmon Embryo cells
CPE	Cytopathic Effects
ddH ₂ O	De-ionized Distilled Water
DEPC	Diethyl pyrocarbonate
DES	Drosophila Expression System
dsRNA	Double-stranded Ribonucleic Acid
DXV	Drosophila-X Virus
DXV-NS	DXV Non-structural protein
DXVA	DXV Segment A
ECL	Enhanced Chemiluminescence
FAM	Carboxyfluorescein
FBS	Fetal Bovine Serum
His6	Poly-histidine (6) epitope tag
IBDV	Infectious Bursal Disease Virus
IPNV	Infectious Pancreatic Necrosis Virus
IPTG	isopropyl-beta-D-thiogalactopyranoside

IRES	Internal Ribosome Entry Site
kDa	kilo-Daltons
LB broth	Luria-Bertani Broth
nt	Nucleotide
ORF	Open Reading Frame
PAGE	Polyacrylamide Gel Electrophoresis
PBS	Phosphate Buffered Saline
PCR	Polymerase Chain Reaction
Pen-Strep	Penicillin-Streptomycin
qPCR	Real-time Quantitative Polymerase Chain Reaction
RdRP	RNA-dependent RNA Polymerase
RP49	Ribosomal Protein 49 (large subunit)
RT-PCR	Reverse Transcriptase Polymerase Chain Reaction
S2 cells	Drosophila Schneider-2 cells
SDS	Sodium Dodecyl Sulfate
X-gal	5-bromo-4-chloro-3-indolyl-beta-D-galactopyranoside
XIA	X-gal/IPTG/Ampicillin

Chapter 1

Introduction and Background

1.1 Introduction

Drosophila-X Virus (DXV) is a member of the family *Birnaviridae*, viruses with genomes consisting of two double-stranded RNA segments (dsRNA). DXV has two open reading frames on segment A, one encoding a polyprotein and the other capable of encoding a putative 27-kDa non structural protein (DXV-NS).

Research into DXV offers insight into the Birnaviruses and offers some advantages over other members of the family. The natural host of DXV, *Drosophila melanogaster*, is a model organism with a fully sequenced genome and an abundance of resources and tools already tailor made for use in this system. *Drosophila* are simpler and less expensive to grow and maintain than fish or fowl, the natural hosts of the other prototype viruses in this family. There are well-established *Drosophila* cell lines which are easy to maintain and can support DXV infections. Finally, DXV is the only Birnavirus with an internal overlapping open reading frame (ORF) on segment A with the potential to encode a non-structural protein (DXV-NS), a unique feature which makes this virus an interesting target for investigation.

The research in support of this thesis investigated the existence of DXV-NS. Though we can not yet give a definitive answer as to whether DXV expresses this protein, this thesis will report some new information on DXV-NS as well as present a number of tools and goals for future research.

1.2 DXV Discovery

Drosophila-X Virus (DXV) was first isolated in 1978 as a contaminant in experiments studying the insect rhabdovirus Sigma. While it is common practice to use CO₂ to anesthetize *Drosophila melanogaster* with little to no lasting side effects, Sigma virus produces an anoxia sensitivity phenotype in infected flies distinguished by death within approximately 15 minutes of exposure. In one control run of *Drosophila* uninfected with Sigma, the anoxia sensitivity phenotype was observed. Subsequent electron microscopy of tissue collected from the “uninfected” flies revealed unknown icosahedral unenveloped virus particles (Figure 1) but no rhabdoviruses indicating the presence of a second unrelated virus which exhibited a similar phenotype. The unknown virus was isolated from homogenized flies, characterized, and designated Drosophila-X Virus (Teninges *et al.*, 1979).

1.3 DXV Taxonomy

The *Birnaviridae* family of viruses is grouped by host into three genera—*Aquabirnavirus*, *Avibirnavirus*, and *Entomobirnavirus*—with each genus represented by a prototypical virus. Drosophila-X Virus stands as the prototype and sole known member of *Entomobirnavirus* (Dobos *et al.*, 1995). Perhaps for its isolation, it

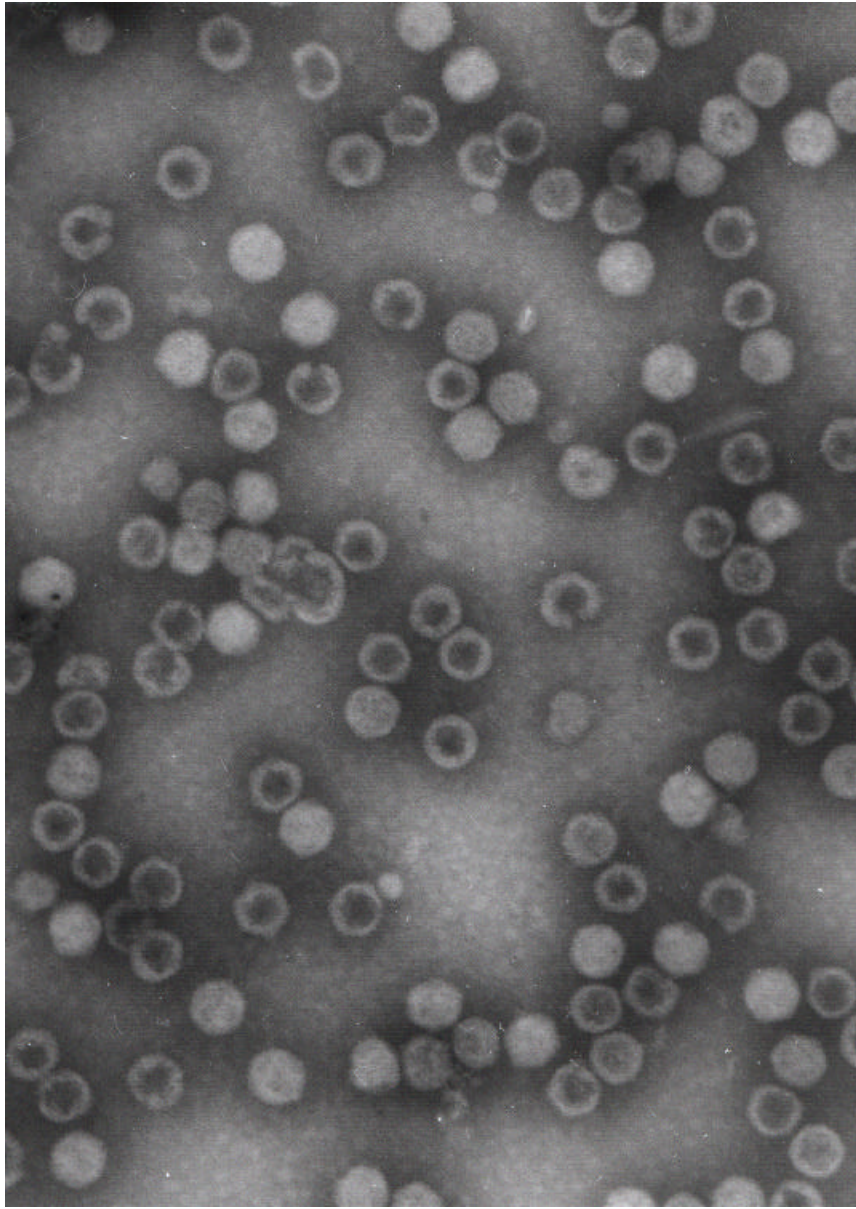

Figure 1. Electron micrograph of Drosophila-X Virus. The icosahedral capsids are 59 nm in diameter. Light colored particles are complete virions. Dark particles are defective, empty capsids lacking genomic material. (Zambon and Edwards, unpublished).

remains the least studied. Infectious pancreatic necrosis virus (IPNV) and infectious bursal disease virus (IBDV) are two well characterized members of *Aqua-* and *Avibirnavirus* respectively and account for much of the current knowledge about the structure and function of birnaviruses. Research into both of these viruses holds a great deal of value to agriculture since each can lead to death of economically valuable hosts. In aquaculture operations, IPNV can kill immature salmonoid fishes such as salmon and trout by destroying the pancreas (Shivappa *et al.*, 2004; Wolf, 1988). IBDV is likewise a threat to poultry farming, causing death to young chickens by necrosis of the bursa of Fabricius, a lymphoid organ and component of the avian immune system (Becht, 1980; Yao and Vakharia, 2001).

The *Birnaviridae* family was first proposed in 1979 based on an analysis of five novel related viruses—including DXV, IPNV and IBDV—which did not fit any known taxonomical classification (Dobos *et al.*, 1979). The family name and characteristics were later codified and accepted by the International Committee on Taxonomy of Viruses in 1986 (Dobos, 1995; Dobos *et al.*, 1995). The family is characterized by unenveloped viruses with a small single layer icosahedral nucleocapsid approximately 60 nm in diameter. The genome is bi-segmented and contains double-stranded RNA (Dobos *et al.*, 1979). The genomes of all members exhibit a strong degree of conservation with regards to structure (Figure 2). At the most basic level of comparison, each encodes a three member polyprotein on the A segment and an RNA-dependent RNA polymerase (RdRP) designated Viral Protein 1 (VP1) on segment B. The polyprotein from the primary reading frame of segment A is processed into viral proteins 2, 3 and 4 (VP2, VP3, and VP4), where VP2 and VP3

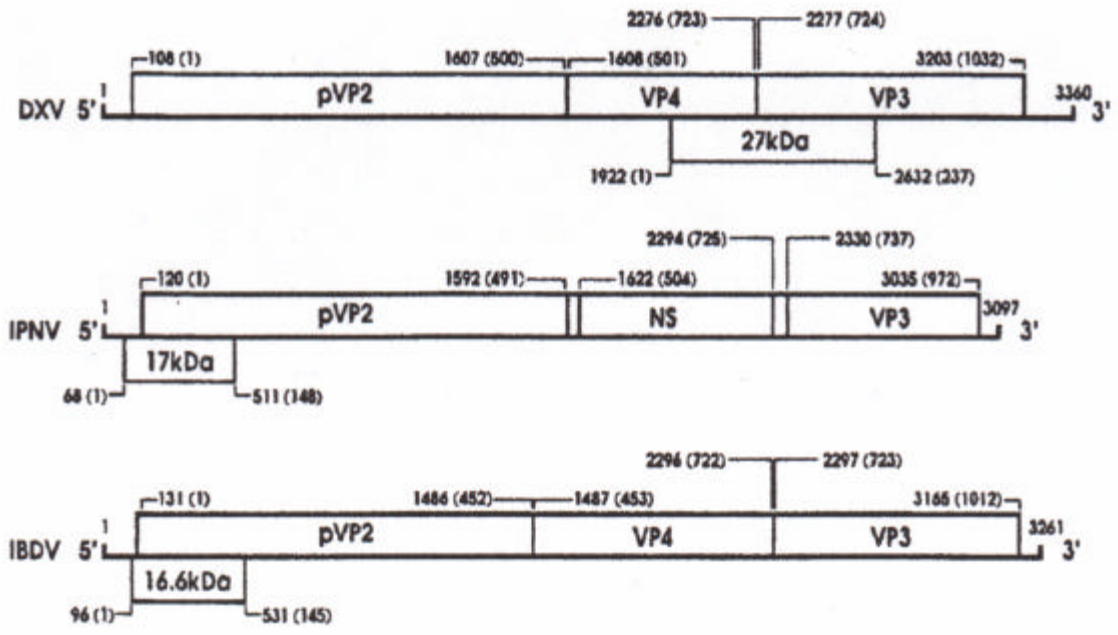

Figure 2. Comparison of the genome structures of the three prototypical Birnaviruses: Drosophila-X Virus (DXV), Infectious Pancreatic Necrosis Virus (IPNV), and Infectious Bursal Disease Virus (IBDV). Note the smaller overlapping reading frame in DXV which encodes the putative non-structural 27-kDa protein (Chung et al., 1996).

are capsid proteins and VP4 is a protease. This pattern of protein expression was confirmed in DXV in 1984 (Nagy and Dobos, 1984a; Nagy and Dobos, 1984b).

1.4 DXV Physical Properties and Structure

Drosophila-X Virus is structurally typical of other members of the *Birnaviridae* family. It consists of a 59 nm icosahedral nucleocapsid and a bi-segmented double-stranded RNA genome. The genome segments A and B have molecular weights of 2.6×10^6 and 2.5×10^6 , respectively. The virions have a density of 1.345 g/mL in a cesium chloride gradient. Defective particles, empty capsids lacking a genome, have a lower density than the complete virions, approximately 1.3 g/mL (Teninges, 1979; Teninges *et al.*, 1979).

DXV segment B is the smaller of the two at 3243 bp. The RNA dependent RNA polymerase VP1 encoded by segment B is 112-kDa. It can be found in both a free and genome-bound form in the virion (Revet and Delain, 1982; Nagy and Dobos, 1984a; Nagy and Dobos, 1984b; Shwed *et al.*, 2002).

Segment A of DXV was first sequenced in 1996 and found to be 3360 bp long. The segment contains two significant overlapping open reading frames, one 3096 nucleotides long starting at position 108 and a smaller 711 nt ORF in the -1 frame beginning at position 1922 (Chung *et al.*, 1996) (Figure 3). The primary open reading frame encodes a 114-kDa polyprotein, consistent with other members of *Birnaviridae*. (Chung *et al.*, 1996; Dobos *et al.*, 1979; Duncan *et al.*, 1987). This

DNA: GGAAAATAAATGGCGGCCGACAAGGCCGACCGATTTATCAGGGTAGAGGGA 51
 0: E N K W R P T R P T D L S G * R D
 -1: G K * M A A D K A D R F I R V E G

DNA: CCTTACAAACCAGTGAAACCTCCAAAATTTTTTAAACTGATACAATACATG 102
 0: L T N Q * N L Q N F L N * Y N T *
 -1: P Y K P V K P P K F F K L I Q Y M

DNA: AATGACAATGAATACGACAAACGAATACTTGAAAACCTCTTTTAAACCCAGC 153
 0: M T M N T T N E Y L K T L L N P A
 -1: N D N E Y D K R I L E N S F K P S

DNA: ACAATTTATCTCAGACATTCCTGATGATATAATGATCCGACACGTAAACAG 204
 0: Q F I S D I P D D I M I R H V N S
 -1: T I Y L R H S * * Y N D P T R K Q

DNA: CGCCCAGACCATCACCTACAACCTGAAGTCAGGGGCCTCTGGCACCGGCCT 255
 0: A Q T I T Y N L K S G A S G T G L
 -1: R P D H H L Q L E V R G L W H R P

DNA: GATCGTGGTCTATCCAAACACCCCGTCGAGTATTAGCGGCTTCCATTACAT 206
 0: I V V Y P N T P S S I S G F H Y I
 -1: D R G L S K H P V E Y * R L P L H

DNA: ATGGGATTCCGCTACCTCGAATTGGGTGTTTGTATCAGTACATCTACACAGC 357
 0: W D S A T S N W V F D Q Y I Y T A
 -1: M G F R Y L E L G V * S V H L H S

DNA: TCAGGAGTTGAAGGACTCATATGACTATGGCAGACTGATTTTCAGGCTCGCT 408
 0: Q E L K D S Y D Y G R L I S G S L
 -1: S G V E G L I * L W Q T D F R L A

DNA: AAGCATTAAAGTCCAGCACCTTACCTGCGGGTGTTTATGCACTGAATGGCAC 459
 0: S I K S S T L P A G V Y A L N G T
 -1: K H * V Q H L T C G C L C T E W H

DNA: ATTCAATGCAGTCTGGTTCCAAGGGACCTTGAGTGAAGTGTCTGACTACTC 510
 0: F N A V W F Q G T L S E V S D Y S
 -1: I Q C S L V P R D L E * S V * L L

DNA: TTACGATAGGATCCTGTCAATAACATCCAATCCTCTGGATAAGGTTGGAAA 561
 0: Y D R I L S I T S N P L D K V G N
 -1: L R * D P V N N I Q S S G * G W K

DNA: TGTGTTGGTTGGAGACGGCATAGAGGTTCTAAGCCTGCCGCAGGGGTTCAA 612
 0: V L V G D G I E V L S L P Q G F N
 -1: C V G W R R H R G S K P A A G V Q

DNA: CAACCCCTACGTTAGGCTGGGTGACAAGTCACCGTCCACTCTATCCTCTCC 663
 0: N P Y V R L G D K S P S T L S S P
 -1: Q P L R * A G * Q V T V H S I L S

DNA: AACCCACATAACCAACTTCCCAGAACTTGGCTACGGGAGGTGCATACAT 714
0: T H I T N T S Q N L A T G G A Y M
-1: N P H N Q H F P E L G Y G R C I H

DNA: GATCCCAGTAACCAAGTTCCTGGGCAAGGATTCCATAACAAGGAATTCAG 765
0: I P V T T V P G Q G F H N K E F S
-1: D P S N H S S W A R I P * Q G I Q

DNA: CATTAATGTGGACTCCGTAGGGCCAGTTGACATCTTGTGGTCTGGTCAAAT 816
0: I N V D S V G P V D I L W S G Q M
-1: H * C G L R R A S * H L V V W S N

DNA: GACTATGCAGGACGAATGGACTGTAAGTCAAAATTATCAACCATTGAACAT 867
0: T M Q D E W T V T A N Y Q P L N I
-1: D Y A G R M D C N C K L S T I E H

DNA: CTCTGGCAGCTAATTGCAAACAGTCAGCGAACCCCTAACATGGTCCAACAC 918
0: S G T L I A N S Q R T L T W S N T
-1: L W H A N C K Q S A N P N M V Q H

DNA: TGGTGTATCCAATGGCAGCCACTACATGAACATGAACAACCTTAATGTCTC 969
0: G V S N G S H Y M N M N N L N V S
-1: W C I Q W Q P L H E H E Q P * C L

DNA: CCTTTTCCATGAGAATCCACCACCTGAACCCGTTGCCGCCATAAAAATAAA 1020
0: L F H E N P P P E P V A A I K I N
-1: P F P * E S T T * T R C R H K N K

DNA: CATCAATTATGAAACAACACCAATGGTGACAGCTCGTTCAGTGTGGACTC 1071
0: I N Y G N N T N G D S S F S V D S
-1: H Q L W K Q H Q W * Q L V Q C G L

DNA: ATCATTTACCATCAATGTCATTGGGGGCGCCACCATTGGCGTCAACTCTCC 1122
0: S F T I N V I G G A T I G V N S P
-1: I I Y H Q C H W G R H H W R Q L S

DNA: AACAGTCGGTGTGGTTACCAAGGAGTAGCTGAGGGCACCGCCATTACAAT 1173
0: T V G V G Y Q G V A E G T A I T I
-1: N S R C W L P R S S * G H R H Y N

DNA: TAGCGGTATCAACAACACTATGAGCTGGTACCCAATCCGGACTTGCAAAAGAA 1224
0: S G I N N Y E L V P N P D L Q K N
-1: * R Y Q Q L * A G T Q S G L A K E

DNA: CCTGCCAATGACATATGGCACTTGTGATCCACATGATTTGACTTACATCAA 1275
0: L P M T Y G T C D P H D L T Y I K
-1: P A N D I W H L * S T * F D L H Q

DNA: GTACATACTGTCAAACCGAGAACAGTTGGGACTTAGGTTCAGTGATGACCTT 1326
0: Y I L S N R E Q L G L R S V M T L
-1: V H T V K P R T V G T * V S D D L

DNA: GGCCGACTACAATAGGATGAAGATGTACATGCATGTACTGACGAACTATCA 1377
0: A D Y N R M K M Y M H V L T N Y H
-1: G R L Q * D E D V H A C T D E L S

DNA: TGTCGATGAGAGGGAAGCATCGAGCTTCGATTTCTGGCAACTACTGAAACA 1428
0: V D E R E A S S F D F W Q L L K Q
-1: C R * E G S I E L R F L A T T E T

DNA: GATAAAAAATGTTGCCGTGCCCTTGGCAGCTACACTTGCCCCCAGTTTCG 1479
0: I K N V A V P L A A T L A P Q F A
-1: D K K C C R A L G S Y T C P P V R

DNA: ACCAATAATCGGTGCTGCCGATGGGTTAGCCAATGCAATATTGGGTGATAG 1530
0: P I I G A A D G L A N A I L G D S
-1: T N N R C C R W V S Q C N I G * *

DNA: CGCCAGCGGAAGGCCTGTTGGCAATTCCGCTAGCGGTATGCCCATTTCAAT 1581
0: A S G R P V G N S A S G M P I S M
-1: R Q R K A C W Q F R * R Y A H F N

DNA: GAGTAGGCGTCTTAGAAAACGCTTACTCAGCTGACTCCCCCTTAGGTGAAGA 1632
0: S R R L R N A Y S A D S P L G E E
-1: E * A S * K R L L S * L P L R * R

DNA: GCATTGGCTGCCAAACGAGAATGAGAACTTCAATAAATTTGACATCATCTA 1683
0: H W L P N E N E N F N K F D I I Y
-1: A L A A K R E * E L Q * I * H H L

DNA: TGACGTATCACATTCATCCATGGCTTTATTTCCAGTCATAATGATGGAACA 1734
0: D V S H S S M A L F P V I M M E H
-1: * R I T F I H G F I S S H N D G T

DNA: TGACAAAGTCATTCCATCCGACCCTGAGGAGCTGTATATTGCTGTATCACT 1785
0: D K V I P S D P E E L Y I A V S L
-1: * Q S H S I R P * G A V Y C C I T

DNA: AACAGAATCCCTCAGGAAGCAAATACCGAACCTCAATGACATGCCATACTA 1836
0: T E S L R K Q I P N L N D M P Y Y
-1: N R I P Q E A N T E P Q * H A I L

DNA: TGAGATGGGTGGCCATAGGGTGTACAACCTCCGTTTCCTCAAACGTAAGATC 1887
0: E M G G H R V Y N S V S S N V R S
-1: * D G W P * G V Q L R F L K R K I

DNA: TGGAAATTTTTTAAGAAGCGATTACATCCTCCTACCATGCTATCAATTATT 1938
0: G N F L R S D Y I L L P C Y Q L L
-1: W K F F K K R L H P P T **M L S I I**

DNA: AGAAGGAAGACTCGCATCGTCGACATCACCAAACAAGGTAACGGGAACGTC 1989
0: E G R L A S S T S P N K V T G T S
-1: **R R K T R I V D I T K Q G N G N V**

DNA: CCACCAGCTTGCCATTTATGCAGCAGACGACTTACTAAAGAGTGGAGTTTT 2040
0: H Q L A I Y A A D D L L K S G V L
-1: **P P A C H L C S R R L T K E W S F**

DNA: GGGGAAGGCACCATTTGCAGCTTTCACAGGATCCGTTGTCCGGTCCAGTGT 2091
0: G K A P F A A F T G S V V G S S V
-1: **G E G T I C S F H R I R C R V Q C**

DNA: GGGAGAAGTTTTTGGCATCAACCTGAAACTCCAATTGACGGACTCTCTTGG 2142
0: G E V F G I N L K L Q L T D S L G
-1: G R S F W H Q P E T P I D G L S W

DNA: GATTCCACTACTTGGGAACCTCACCAGGATTAGTTCAAGTAAAGACCCTGAC 2193
0: I P L L G N S P G L V Q V K T L T
-1: D S T T W E L T R I S S S K D P D

DNA: ATCTCTGGACAAAAAGATAAAAAGATATGGGAGACGTAAAGAGAAGAACCCC 2244
0: S L D K K I K D M G D V K R R T P
-1: I S G Q K D K R Y G R R K E K N P

DNA: AAAACAGACCCTCCCGCACTGGACAGCCGGGTCCGCGAGCATGAACCCATT 2295
0: K Q T L P H W T A G S A S M N P F
-1: K T D P P A L D S R V R E H E P I

DNA: CATGAACACGAACCCATTCTGGAAGAGTTGGACCAGCCGATACCAAGCAA 2346
0: M N T N P F L E E L D Q P I P S N
-1: H E H E P I P G R V G P A D T K Q

DNA: CGCTGCAAAGCCAATCTCCGAGGAGACTCGGGATTTGTTTCTATCGGACGG 2397
0: A A K P I S E E T R D L F L S D G
-1: R C K A N L R G D S G F V S I G R

DNA: TCAAACCATCCCAAGCTCTCAAGAGAAGATTGCCACAATACACGAGTACCT 2448
0: Q T I P S S Q E K I A T I H E Y L
-1: S N H P K L S R E D C H N T R V P

DNA: CCTGGAACACAAGGAGTTAGAGGAGGCAATGTTTCAGCTTGATAAGCCAAGG 2499
0: L E H K E L E E A M F S L I S Q G
-1: P G T Q G V R G G N V Q L D K P R

DNA: GAGAGGCCGGTCTCTTATCAACATGGTAGTAAAAAGCGCTCTGAACATCGA 2550
0: R G R S L I N M V V K S A L N I E
-1: E R P V S Y Q H G S K K R S E H R

DNA: AACCCAGTCTCGAGAAGTCACCGGCGAAAGAAGGCAAAGACTAGAACGAAA 2601
0: T Q S R E V T G E R R Q R L E R K
-1: N P V S R S H R R K K A K T R T K

DNA: ACTTCGAAACTTGGAAAATCAAGGGATATATGTTGATGAGAGCAAATAAT 2652
0: L R N L E N Q G I Y V D E S K I M
-1: T S K L G K S R D I C * * E Q N N

DNA: GTCAAGAGGAAGAATATCGAAAGAAGACACGGAACCTAGCAATGAGGATTGC 2703
0: S R G R I S K E D T E L A M R I A
-1: V K R K N I E R R H G T S N E D C

DNA: TCGGAAGAACCAAAAGGATGCAAAGTTACGGAGAATCTATAGCAATAACGC 2754
0: R K N Q K D A K L R R I Y S N N A
-1: S E E P K G C K V T E N L * Q * R

DNA: CTCGATCCAAGAGTCGTACACTGTGGATGACTTTGTATCCTATTGGATGGA 2805
0: S I Q E S Y T V D D F V S Y W M E
-1: L D P R V V H C G * L C I L L D G

DNA: GCAGGAGTCATTGCCTACTGGCATACAAATCGCAATGTGGTTAAAGGGTGA 2856
0: Q E S L P T G I Q I A M W L K G D
-1: A G V I A Y W H T N R N V V K G *

DNA: CGATTGGTCCCAGCCAATACCACCTCGTGTCCAAAGACGACACTATGACAG 2907
0: D W S Q P I P P R V Q R R H Y D S
-1: R L V P A N T T S C P K T T L * Q

DNA: CTACATTATGATGCTTGGGCCGTACCAACCCAAGAACAAGCCGATGCTGT 2958
0: Y I M M L G P S P T Q E Q A D A V
-1: L H Y D A W A V T N P R T S R C C

DNA: TAAGGACCTTGTGACGACATATACGACAGAAATCAAGGGAAGGGCCATC 3009
0: K D L V D D I Y D R N Q G K G P S
-1: * G P C R R H I R Q K S R E G A I

DNA: CCAGGAACAAGCTCGGGAATTAAGTCATGCTGTCCGCAGGCTTATTTTCGCA 3060
0: Q E Q A R E L S H A V R R L I S H
-1: P G T S S G I K S C C P Q A Y F A

DNA: CTCACTTGTCAACCAACCGGCAACTGCTCCTAGAGTCCCCCACGCCGAAT 3111
0: S L V N Q P A T A P R V P P R R I
-1: L T C Q P T G N C S * S P P T P N

DNA: TGTATCAGCTCAGACTGCTCAAACCTGATCCCCCGGAAGGAGGGCCGCACT 3162
0: V S A Q T A Q T D P P G R R A A L
-1: C I S S D C S N * S P R K E G R T

DNA: TGACCGATTGCGAAGAGTGCCTGGAGAGGACAATGACATTGTATAAGTCCA 3213
0: D R L R R V R G E D N D I V * V H
-1: * P I A K S A W R G Q * H C I S P

DNA: CCCATGAACTCATGACTCATGGGCCGTGAGAGAGAGGGGTGAGGAGAAT 3264
0: P * T H D S W A V R E R R V R R I
-1: P M N S * L M G R Q R E E G E E N

DNA: TTTAGAGGGTAGTGCCAACCTACACTAACAACCACTAGACTATTGAAGTCG 3315
0: L E G S A N Y T N K P L D Y * S R
-1: F R G * C Q L H * Q T T R L L K S

DNA: CCTGGTCTCATTAGCCAGGAAATCACGGTATCGAATCCGTGGTGGTTCCC 3365
0: L V S L A R K S R Y R I R G G S
-1: P G L I S Q E I T V S N P W W F

Figure 3. Sequence of Drosophila-X Virus segment A. The sequence of our full-length DXV segment A cDNA clone is given along with the translations of the 0 and -1 reading frames. The zero frame encodes the polyprotein starting at nt 104 and NS is encoded in the -1 frame (bold) starting at nt 1924 and ending at 2635 (Chung *et al.*, 1996; Zambon, unpublished).

protein is arranged in the order NH₂-preVP2-VP4-VP3-COOH (Nagy and Dobos, 1984b). Pulse-chase experiments revealed the sequence of processing events, initially self-cleavage by the protease VP4 (27-kDa) producing preVP2 (67-kDa) and VP3 (34-kDa). The precursor protein preVP2 undergoes further processing to pVP2 (49-kDa) which matures into VP2 (45-kDa). All of these proteins have been detected in the virion. VP2 and VP3 are both known structural proteins, while pVP2 is detectable in capsids and therefore may also play a role in capsid formation (Nagy and Dobos, 1984a). VP3 associates with the genome and is known as the inner capsid protein while VP2 does not appear to do so and is considered the outer capsid protein (Table 1).

The smaller 711 bp ORF on segment A has the potential to encode a 27-kDa protein that has not been detected in virions. This putative protein is called Drosophila-X Virus Non-Structural Protein (DXV-NS, or simply NS) (Chung *et al.*, 1996).

1.5 Properties of the DXV-NS Putative Protein

The sequence for DXV-NS codes for 237 residues. A very high proportion (27%) of the amino acid residues comprising NS are basic including 31 arginines, which gives the projected protein a calculated pI value of 11 (Chung *et al.*, 1996). It has been theorized that the highly basic nature of NS could indicate a nucleic acid binding function which is bolstered by the fact that the C-terminal end contains a

Name	Size (kDa)	Function
Polyprotein	114	precursor to VP2-4
preVP2	67	precursor to pVP2
pVP2	49	precursor to VP2; capsid?
VP2	45	outer capsid
VP3	34	inner capsid
VP4	27	protease
NS	27	unknown
VP1	112	RNA dependent RNA Polymerase

Table 1. Known and projected Drosophila-X Virus proteins. The polyprotein is cleaved into preVP2, VP4, and VP3. The precursor preVP2 gives rise to pVP2 which is in turn processed to pVP2.

bipartite nuclear targeting sequence characterized by two adjacent basic residues, a ten residue spacer, and five basic residues (Figure 4).

Both IPNV and IBDV also encode small non-structural arginine-rich peptides in a separate overlapping reading frame on segment A (Figure 2). These peptides are similarly low in methionine, each containing two residues, while DXV-NS contains only a single one. However in these related viruses, the peptide is located near the 5' end, not overlapping the junction between VP4 and VP3 as is the case in DXV (Chung *et al.*, 1996; Magyar and Dobos, 1994; Mundt *et al.*, 1995).

The function of these small proteins—17-kDa in IPNV and 16.6-kDa in IBDV—is not entirely known, but there is evidence that both may play some role in the apoptosis mechanism of infected cells. In IBDV, the virus is known to cause apoptosis in chicken embryo fibroblast (CEF) cells (Jungmann, *et al.*, 2001) and a mutant strain lacking the 17-kDa NS protein was demonstrated to have reduced apoptotic effects (Yao *et al.*, 1998). *In vitro* expression of the IBDV-NS protein from a plasmid containing the gene was shown to induce apoptosis in CEF cells (Yao and Vakharia, 2001).

IPNV infection has a similar pro-apoptotic effect in Chinook salmon embryo cells (CHSE-214) (Hong *et al.*, 1998; Hong *et al.*, 1999) although it has been reported that in this virus the 17-kDa protein (known as VP5) shares some sequence features with anti-apoptotic factors (Hong *et al.*, 2002). Mutant IPNV strains that eliminate VP5 expression demonstrate that the protein is not essential to replication or virulence (Song, 2003).

Like DXV, IPNV strains of the Sp serotype group also have an internal ORF

MLSIIRRKTRIVDITKQGNGNVPPACHLCSRRLTKEWSFG	1-40
EGTICSFHRIRCRVQCGRSFWHQPETPIDGLSWDSTTWEL	41-80
TRISSSKDPDISGQKDKRYGRRKEKNPKTDPPALDSRVRE	81-120
HEPIHEHEPIPGRVGPADTKQRCKANLRGDSGFVSIGRSN	121-160
HPKLSREDCHNTRVPPGTQGVRGGNVQLDKPRERPVSYPQH	161-200
GSK KR <i>SEHRNPVSR</i> SHRRKK AKTRTKTSKLGKSRDIC	201-237

Figure 4. DXV-NS putative protein sequence and bipartite nuclear targeting sequence (residues 204 to 220). The motif is defined by two basic residues (bold), a spacer sequence of ten amino acids (italics), and at least three basic residues out of the next five (bold).

in segment A capable of encoding a second putative non-structural protein. The putative 25-kDa protein (IPNV-Sp-NS) is highly basic and contains a nuclear targeting signal, just like DXV-NS. The two putative proteins share a 12.7% identity and a 44% similarity. (Shivappa *et al.*, 2004; Song, 2003). However, the protein has not been detected *in vivo* and a mutant IPNV virus eliminating the reading frame for the 25-kDa protein does not appear to have an effect on the virus replication in CHES cells. The existence and function of IPNV-Sp-NS are still unknown (Song, 2003).

A comparison of the amino acid sequences for IPNV-VP5, IBDV 17-kDa, and DXV-NS show a biochemical similarity. The three sequences exhibit a 23% overall residue homology which rises to 44% if you consider similarity between any two of the three viruses (Chung *et al.*, 1996). This high degree of similarity is striking since the DXV-NS ORF is found in a different area of segment A from the basic IPNV and IBDV proteins. The significance of the similarities between the small basic proteins, DXV-NS, and the 25-kDa putative protein of IPNV-Sp is unknown. Based on the importance of IPNV-VP5 and IBDV 17-kDa in their respective viruses, DXV-NS could be a factor in DXV virulence and host interaction.

1.6 Putative Mechanisms for NS Expression

The DXV-NS ORF is located in the middle of segment A, its start sequence overlapping the coding region for the polyprotein. If the NS protein is made by Drosophila-X Virus, the mechanism for translation is unknown. The polyprotein

ORF and the start codon of the DXV-NS ORF are both preceded by an identical motif consisting of sequences at the -34 and -13 positions. The motif 5'-AAATTTTTTAA-3' is located 34 nt upstream from both ORFs and a 5'-TACAT-3' sequence is found at the -13 position. Other groups have speculated that these identical motifs could represent a promoter sequence (Chung *et al.*, 1996). Perhaps there is an unknown internal ribosome entry site (IRES). However based on analysis of the sequence around the start of the NS ORF, we investigated the alternate possibility that NS could be expressed through -1 frameshifting from the polyprotein. A fusion with a portion of the polyprotein would result in a much larger band, and could explain why we do not find NS at 27-kDa in DXV infections.

Programmed -1 ribosomal frameshifting (-1 PRF) is a known mechanism for expression in some viruses, the prototype being gag-pol fusion proteins found in *Saccharomyces cerevisiae* virus L-A and many retroviruses (Brierley *et al.*, 1989; Dinman *et al.*, 1991; Plant *et al.*, 2003). A -1 PRF signal consists of three components: a slippery site, spacer region, and pseudoknot. Slippery sites are heptameric signals in RNA that conform to the motif X XXY YYZ, where X=A,U,G; Y=A,U; Z=A,U,C (Brierley *et al.*, 1989; Brierley *et al.*, 1992; Dinman *et al.*, 1991; Plant *et al.*, 2003). They are separated from a downstream pseudoknot-forming stem-loop structure by a short spacer about 10 nucleotides long. A pseudoknot is a structure formed by base pairing of a stem loop with downstream bases (Brierley *et al.*, 1989, Plant *et al.*, 2003)

During translation, a ribosome reading in the zero frame comes up against the pseudoknot while the slippery site is in the ribosomal P and A tRNA sites. The

ribosome pauses while the secondary structure of the pseudoknot is resolved, allowing simultaneous slippage of both tRNAs in the -1 direction. When the ribosome resumes translation, it continues reading in the -1 frame. The frameshifting efficiency allows the virus to regulate the rate of expression of the downstream protein (Brierley *et al.*, 1989; Dinman *et al.*, 1991; Plant *et al.*, 2003).

At the time that DXV segment A was sequenced, Chung reported that they did not find a slippery site (Chung *et al.*, 1996). However, we will report new results utilizing the most recent search algorithms which indicate a slippery site may exist, opening the possibility that -1 frameshifting may be used to express DXV-NS.

1.7 Infection in Flies

Drosophila-X Virus exhibits an anoxia sensitivity phenotype in *Drosophila melanogaster*, its only known host. *Drosophila* become immobilized under anoxic conditions, usually induced in the laboratory by exposure to CO₂. The flies can normally tolerate long periods of anoxia without suffering any pronounced effects once oxygen is restored, but DXV infected flies die off at a high rate after only an anoxic period of approximately 15 minutes (Figure 5). Up until day five, DXV injected flies have a similar mortality rate after 15 minutes exposure to CO₂ when compared to a control group injected with sterile water. After the fifth day post-infection, mortality increases and by day seven the infected flies have a 70% mortality rate compared to only 20% in uninfected flies. By day 10, nearly all

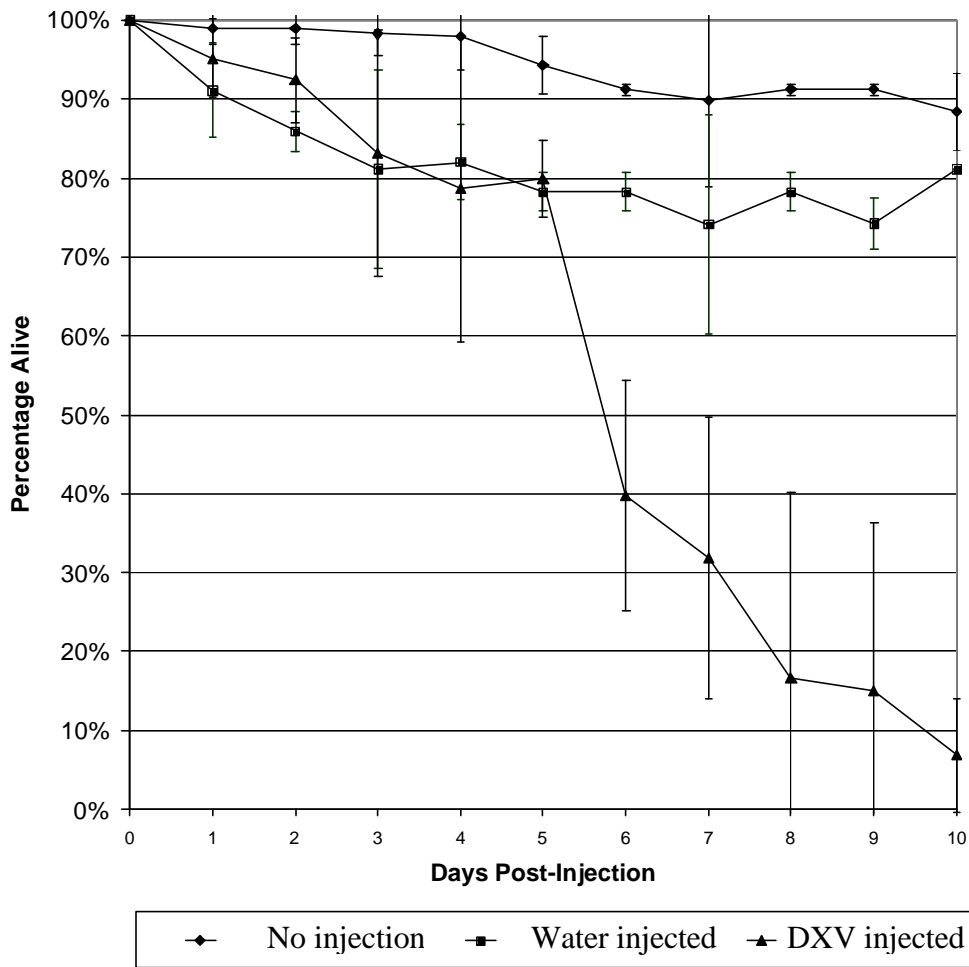

Figure 5. DXV survival curves in Oregon R *Drosophila melanogaster*. Control flies were not injected. Water injected flies received only sterile water and food coloring. DXV flies were injected with 10^{-4} dilution of Drosophila-X Virus stock in sterile water and food coloring. Graph shows percent surviving after 15 minutes exposure to CO_2 . The anoxia sensitivity phenotype appears after day 5. By day 10, nearly 95% of infected flies die after 15 minutes exposure (Zambon, unpublished).

infected flies fail to recover from anoxia (Zambon, unpublished). The mechanism of this phenotype is unknown.

Drosophila infected with DXV have a shorter lifespan than flies injected with sterile water, living approximately two weeks even without anoxia exposure. Infected flies that do survive exposure to anoxia appear to exhibit a higher instance of defects in motility such as staggering, falling, and uncoordinated flying. These defects are purely anecdotal and have not been quantified to any degree (Zambon, unpublished).

DXV propagates to a moderate titer, accounting for approximately 0.1% of total protein in flies 5 days post-infection. The primary experimental route of infection is injection. The earliest experiments demonstrated that a 10^{-3} dilution of a filtered homogenate from infected flies was capable of producing infected flies that were anoxia sensitive after five days (Teninges *et al.*, 1979). In our laboratory, we have determined that injecting a 10^{-4} dilution is optimal when using a density gradient purified viral stock (Zambon, unpublished).

Early attempts to demonstrate contact transmission appeared to show an effect. Previously uninfected flies housed with those injected with DXV were homogenized. The extracts were injected into other flies and 49 out of 130 were shown to produce anoxia sensitivity (Teninges *et al.*, 1979). More recently, using a more sensitive quantitative real-time PCR detection, we have been unable to demonstrate horizontal transmission (Zambon R, unpublished). Injection/injury remains the only proven route of infection and is the method used in all our experiments.

Thin section staining of DXV infected flies with a polyclonal antibody against the virus has shown that the virus proliferates quickly throughout the hemolymph but does not appear to infiltrate the surrounding tissue such as the gut to a significant degree. Virus injected in the abdomen will spread to the thorax and head by 3-5 days. (Zambon, unpublished).

1.8 Infection in Cell Culture

Drosophila-X Virus can propagate easily in cultures of Schneider-2 cells (S2), a line derived from Drosophila embryos. Cells inoculated with DXV from either infected media or purified stock usually begin to exhibit typical cytopathic effects (CPE) after three days and viral proteins can be detected through western blotting. The CPE is characterized by blebbing of the cell membranes, cell death, debris, and occasionally a granular appearance to the cells.

DXV can sometimes maintain a persistent infection in S2 cells which does not exhibit the typical cytopathic effects. Though these cells appear uninfected, they are resistant to super-infection, failing to produce productive infections when inoculated with more virus (Teninges *et al.*, 1979). When subjected to western blotting with anti-DXV antibodies, persistently infected cells are shown to contain significant levels of viral proteins (Zambon, unpublished). The mechanism for this protection is unknown.

Chapter 2

Materials and Methods

2.1 Cell Lines

Schneider-2 (S2) cells are derived from *Drosophila melanogaster* Oregon R strain embryos and were obtained from ATCC (American Type Culture Collection, Manassas, VA). S2 cells were maintained in Schneider's Drosophila Medium with L-glutamine (Invitrogen Corporation, Carlsbad, CA) supplemented with 10% fetal bovine serum (FBS) (Invitrogen). Penicillin-Streptomycin (Invitrogen) was added for contamination control at a concentration of 50 units/L. S2 cells were carried in 30 mL of media in sealed-cap 75 cm² tissue culture flasks at ambient temperature (~25°C). Cultures were passaged every 3-5 days by washing confluent cells into the spent media. An aliquot of S2 cells in this conditioned media was transferred into new flasks at a 1:5 dilution with fresh media.

To obtain log phase cells for most experiments, confluent flasks were split 1:5 and allowed to grow for approximately 72 hours. After 72 hours of growth, the confluent log phase S2 cells were gently washed from the bottom of the flask and transferred to a sterile 50 mL centrifuge tube. One flask typically provided around 10⁷ or 10⁸ cells, over 99% viable.

All baculovirus experiments were carried out in Sf9 cells, a line derived from *Spodoptera frugiperda* which grows in Grace's Insect Media (Sigma-Aldrich Inc., St. Louis, MO) supplemented with 5% FBS (Invitrogen). Sf9 cells are usually kept as 30

mL cultures in 75 cm² flasks at 28°C. Cultures would be washed from the bottom of the flasks and diluted 1:3 with fresh media each week to maintain the line. As the cells do not grow to an adequately high titer under these conditions, suspension cultures were used to obtain large numbers of cells for experiments. These were grown over several days as 150 mL cultures in spinner flask growth chambers at 28°C. The Sf9 cells reach log phase around 1-2x10⁶ cells/mL and have better than 99% viability.

2.2 DXV Growth and Propagation

All viral stocks were obtained from Robert Zambon and had been previously isolated and purified from infected S2 cells using CsCl density gradients (Zambon and Edwards, unpublished). DXV stocks were stored in concentrated purified form in aliquots at -80°C. Growth and propagation was carried out in S2 cells.

Primary viral inoculation stocks were produced by adding 50 µL concentrated DXV stock to fresh S2 cells in 25 cm² tissue culture flasks. At 7 days post-infection, once cytopathic effects (CPE) were observed, these cultures were centrifuged at 1000 x g to remove most cellular material, and the DXV laden media was drawn off and stored at -20°C. This inoculum was used a concentration of 1:60 to infect future flasks of cells.

2.3 DXV Injections

Adult *Drosophila melanogaster* were selected from stocks of the Oregon R strain. Flies were taken approximately 1-5 days from eclosion and sedated on a porous pad connected to a CO₂ supply. Injections were by micropipette, held in an instrument crafted from a Leica Microsystems micromanipulator and a syringe that produces positive pressure. Pipettes were pulled on a Kopf Model 730 Needle/Pipette Puller. DXV was diluted to 10⁻⁵ in a solution of food coloring and water. All injections were abdominal.

2.4 RNA Isolation from Flies

Total RNA, host and viral, was extracted from *Drosophila* and purified using RNA STAT-60 according to the published protocol (Isotex Diagnostics, Friendswood, TX). In brief, samples were homogenized with an RNase-free pestle in 500 µL of the phenol-based RNA STAT-60 reagent and incubated at room temperature. 100 µL of chloroform was added and the sample centrifuged to recover the aqueous portion. RNA was precipitated with 250 µL isopropanol and recovered by centrifugation. The RNA was dried and resuspended in 20 µL sterile DEPC treated water. Samples were quantified on a Thermo Spectronic BioMate3 spectrophotometer.

A 3 µg sample of total RNA from each infected and control fly pool was transcribed to cDNA using reverse transcriptase PCR (RT-PCR) with 250 ng of

random hexamer primers. This cDNA was resuspended in DEPC treated water and quantified (Sambrook *et al.*, 1989).

2.5 Real-time Quantitative PCR

Real-time quantitative PCR (qPCR) was performed in an ABI PRISM 5700 DNA Analyzer (Applied Biosystems) with data output to a Windows based computer. The qPCR reactions were carried out in optical 96-well 0.5mL plates. FAM (carboxyfluorescein) fluorophore-labeled probes and primers were mixed with sterile water and qPCR Mastermix (Applied Biosystems, Foster City, CA) and aliquoted so each well received 10 pmol of each primer, 10 pmol of probe, and 12.5 μ L of the mastermix in a total volume of 24 μ L. The cDNA from the previous reverse transcription was added in triplicate wells, and the reaction run for 30 cycles. The data was analyzed in Excel (Microsoft Corporation, Redmond, CA).

2.6 Polypeptide Antibody

The polypeptide sequence NH₂-SRSHRRKKAKTRTKTSK-COOH from Drosophila-X Virus non structural protein was synthesized by Biosynthesis Incorporated (Lewisville, TX) and used to raise antibodies in rabbits (Figure 6). The NS antisera were verified by the manufacturer against the polypeptide by ELISA.

MLSIIRRKTRIVDITKQGNGNVPPACHLCSRRLTKEWSFG	1-40
EGTICSFHRIRCRVQCGRSFWHQPETPIDGLSWDSTTWEL	41-80
TRISSKDPDISGQKDKRYGRRKEKNPKTDPPALDSRVRE	81-120
HEPIHEHEPIPGRVGPADTKQRCKANLRGDSGFVSIGRSN	121-160
HPKLSREDCHNTRVPPGTQGVRGGNVQLDKPRERPVSYPQH	161-200
GSKKRSEHRNPV SRSHRRKKAKTRTKTSKLGKSRDIC	201-237

Figure 6. Anti-DXV-NS antibody epitope sequence. The peptide epitope used to produce anti-NS antiserum in rabbits is highlighted in bold, residues 213 through 239.

Antiserum was obtained from bleeds ten weeks after inoculation and was used in all experiments.

2.7 SDS-PAGE and Western Blots

Polyacrylamide gel electrophoresis (PAGE) and western blots were produced through standard methods described here in brief. SDS (Sodium Dodecyl Sulfate) denaturing gels were poured as 5%/10% stacking/resolving gels using a 30% mixture of acrylamide/bis 29:1 (Bio-Rad Laboratories, Hercules, CA). Samples were heat-denatured in PAGE loading buffer containing SDS and β -mercaptoethanol (BME) by boiling for 5 minutes. The protein samples were loaded and resolved by electrophoresis at 120 volts (Sambrook *et al.*, 1989).

Those gels intended for total protein visualization were rinsed, stained with GelCode blue stain reagent (Pierce Biotechnology, Rockford, IL) for one hour, and destained with water for one hour.

Samples intended for western blotting were transferred overnight at 40 volts onto nitrocellulose filters (Amersham Biosciences Corp, Piscataway, NJ). Gel transfers were rinsed briefly in PBS and blocked in PBS with 0.1% Tween 20 and 5% nonfat milk for at least one hour or as long as overnight. The primary antibody was diluted in PBS/Tween/5% milk and applied for one hour with gentle agitation on an orbital shaker. The filters were washed four times in PBS/Tween for 5 minutes each followed by an incubation for one hour with the secondary antibody. The horseradish

peroxidase (HRP) conjugated secondary antibody (Novagen) was diluted in PBS/Tween/5% milk. The nitrocellulose filters were washed once again four times, 5 minutes each, in PBS/Tween (Sambrook *et al.*, 1989).

For visualization, the nitrocellulose filters were treated with enhanced chemiluminescent reagent (ECL) (Amersham) for one minute and exposed in a film cassette to ECL photographic film (Amersham) for one minute. If necessary, additional exposures were carried out for 20 seconds to overnight, depending on signal strength (Sambrook *et al.*, 1989).

2.8 Cloning the Putative NS Protein

All cloning was carried out using standard molecular biology protocols (Sambrook *et al.*, 1989). Polymerase chain reactions (PCR) were performed for 30 cycles in an MJ Research PTC-200 thermal cycler (South San Francisco, CA) using custom primers containing restriction enzyme cut sites and flanking the NS open reading frame. Custom primers were obtained from both Gene Probe Technologies Inc. (Gaithersburg, MD) and Invitrogen (Table 2). The template for these reactions was a clone of DXV segment A (DXVA) in a pUC19 vector previously engineered in our laboratory from our common DXV stock (Zambon R, unpublished).

All PCR transcripts were first cloned into the TOPO TA cloning kit (Invitrogen) according to the published protocol before being subcloned into an expression vector. In brief, approximately 2 μ g PCR product was combined with 1

Plasmid	Primer Name	Primer Sequence (5'-3')
pMT	DXVA-NS-Top	GGAATTCCATCCTCCTACCATGCTATCAAT
	DXVA-NS-Rev#2	GCTCTAGAGCACATATATCCCTTGATTTTCC
pAc5.1	pAc51-F-KpnI-NS	GGTACCAAGCGATTACATCCTCCTA
	pAc51-R-ApaI-NS	GGGCCCTTTATATCCCTTGATTTTCCAAG
	pAc51-F-mut-Koz	CCTCCTACCATGGTATCAATTA
pET15b	DXVA-Bgl2-F	AGATCTCATGCTATCAATTATTAGAAGGAAG
	DXVA-Bgl2-R	AGATCTTCAACATATATCCCTTGATTTTCC
pBlueBacHis2	DXVA-Bgl2-F	AGATCTCATGCTATCAATTATTAGAAGGAAG
	DXVA-EcoRI-R	GAATTCTCAACATATATCCCTTGATTTTCC

Table 2. Primers used in the construction of NS expression plasmids. Sequences for the primers used to clone the DXV-NS inserts for each expression vector are given in the 5' to 3' direction along with the name.

μL pCR2.1-TOPO vector which comes linearized and activated with covalently bound topoisomerase vector. The reaction volume was brought to 6 μL with sterile ddH₂O and incubated at room temperature for 5 minutes to ligate.

A 2 μL aliquot of the reaction was used to transform chemically competent TOP10F' *E. coli* (Invitrogen). Cells were incubated on ice for 30 minutes with the target plasmid, heat-shocked at 42°C for 30 seconds, and incubated with 250 μL SOC media at 37°C for 1 hour. Cultures were spread onto XIA agar plates and incubated overnight. White colonies were selected and cultured in 4 mL of Luria-Bertani broth with 50 $\mu\text{g}/\mu\text{L}$ ampicillin (LB/AMP).

2.9 Plasmid Recovery and Sequencing

Plasmids were recovered with the Promega Wizard Plus Kits (Madison, WI) according to the published protocols. The Mini kits were used for 3 mL of cultured material, while the Midi kits were used for cultures of 100 mL. Final products were screened for the presence of the NS insert through restriction digest or PCR verification before being sequenced.

All DNA sequencing was performed on-site by the staff of the Center for Biosystems Research DNA sequencing facility (College Park, MD) on a model 3100 Applied Biosystems DNA sequencer.

2.10 Subcloning into Expression Vectors

DXV-NS inserts were excised from pCR2.1 by enzyme digest at flanking restriction sites designed into the primers. Vectors were linearized by restriction digest at the intended insertion site and if necessary, Calf Intestine Alkaline Phosphatase (CIAP) treated (Promega). Cut vector and insert were gel purified from a 1% agarose gel using the QIAquick Gel Extraction Kit (Qiagen, Valencia, CA). Ligations were carried out according to standard protocol for T4 Ligase (Promega) and incubated overnight at 14°C. Transformations were performed as described above in TOP10F' cells and streaked onto LB/AMP agar plates. Colonies were grown in LB/AMP as previously described. Cultures were plasmid prepped and verified for the NS insert again as previously described.

2.11 Expression Vectors

DXV-NS was expressed as epitope tagged fusion proteins in four commercially available vectors (Figure 7). The pET15b vector (Novagen) was used for DXV-NS expression in bacteria. Expression in S2 cells was with pAc5.1/v5-His and pMT/v5-His which were provided as part of the Drosophila Expression System (DES) along with pAc5.1-lacZ control and pCoHygro selection plasmids (Invitrogen). The pBlueBacHis2 transfer vector was used as described below to make the recombinant baculovirus expressing NS (Invitrogen).

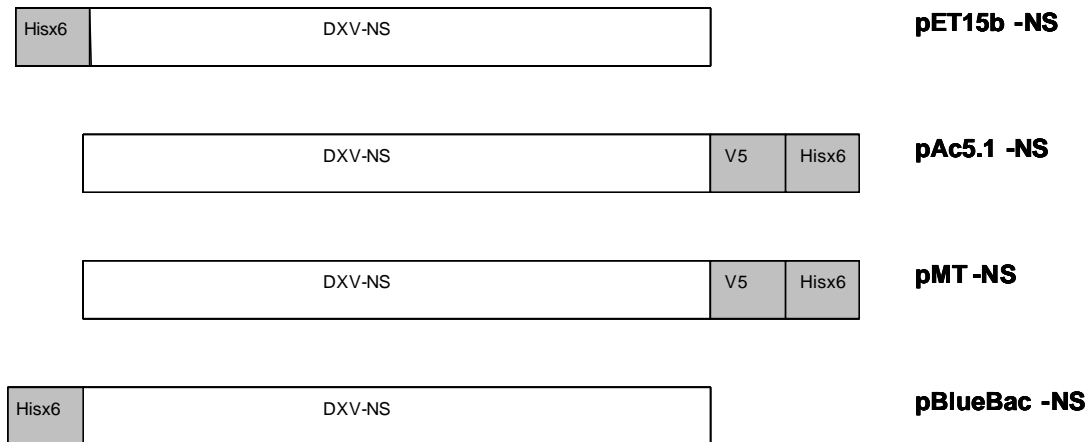

Figure 7. His-tagged DXV-NS recombinant expression products from four different vectors. The V5 epitope was not used in these experiments. The pET15b vector was designed for expression in *E. coli*. The pAc5.1 and pMT plasmids were constitutive and metal-inducible insect expression vectors for *Drosophila* cells, respectively. The transfer plasmid pBlueBac recombines with baculovirus genomic DNA in the construction of recombinant baculovirus expressing the gene of interest.

2.12 Expression in BL21 Bacteria

Chemically competent BL21(DE3)pLysS expression strain *E. coli* (Stratagene, La Jolla, CA) were transformed with pET15b-NS expression vector. In brief, approximately 1 μg of plasmid was added to a 50 μL aliquot of competent BL21 and incubated on ice for 5 minutes. The reaction was heat shocked at 42°C for 30 seconds and returned to ice with the addition of 250 μL SOC media. After shaking in a 37°C incubator for one hour, 50 μL and 100 μL aliquots were spread onto LB/AMP agar plates and allowed to grow overnight at 37°C.

Colonies were picked from the plates and used to inoculate 50mL cultures of LB/AMP in 250 mL Erlenmeyer flasks. The cultures were grown in a 37°C orbital shaker incubator to an optical density at 600 nm of 0.6. Presence of the plasmid was confirmed by removing a small sample and assaying by PCR with the original primers. Cultures were induced with the addition of either 0.4 mM or 1 mM IPTG and grown for an additional 3 hours.

The cultures were removed and placed on ice for five minutes, then pelleted at 5000 x *g* for 5 minutes. The cells were resuspended in 12 mL of ice cold 20 mM Tris HCl pH 8.0 and centrifuged again for 5 minutes at 5000 x *g*. The pelleted cells were frozen at -70°C and thawed to self-lyse. Samples were run on SDS-PAGE gels and either stained for protein or used for western blots as described previously (Sambrook *et al.*, 1989).

2.13 Plasmid Stability Assay

Plasmid stability was tested as outlined in the pET expression system literature (Novagen). 50 mL cultures of pET15b-NS in BL21(DE3)pLysS were grown in LB containing carbenicillin. After reaching OD₆₀₀ 0.6, a sample from each was diluted to 10⁻⁶ and spread on LB agar plates with and without carbenicillin. A 10⁻⁵ dilution of each culture was streaked onto LB agar plates containing IPTG, again with or without carbenicillin.

2.14 Increasing Plasmid Stability

The protocols for increasing plasmid stability were outlined in the pET expression system literature (Novagen). A 2 mL starter culture was prepared with 200 µg/mL carbenicillin and grown for 3 hours at 37°C until the OD₆₀₀ reached 0.6. The culture was centrifuged at 5000 x g for 5 minutes and resuspended in 2 mL fresh media. A 100 µL aliquot was taken and added to 8 mL of LB containing 500 µg/mL carbenicillin. The fresh culture was grown for 2.5 hours to OD₆₀₀ 0.45 and once again spun down. The pellet was resuspended in 8 mL LB with 500 µg/mL carbenicillin and 1 mM IPTG. The cells were incubated at 30°C for 2 hours before harvest.

2.15 Transfection of S2 Cells

Drosophila S2 cells were transfected using the lipid-based reagent CellFectin in a protocol adapted from the published procedure (Invitrogen). Log phase cells of at least 95% viability were centrifuged at 1000 x g and the supernatant removed from the cell pellet by aspiration. Cells were resuspended in serum-free media without antibiotics and quantified using a hemacytometer and trypan blue stain to determine viability.

Cells suspended in serum-free Schneider's media were added to 6-well plates at approximately 3×10^6 cells per well. The total volume per well was 3 mL. The S2 cells were placed in a sealed container to maintain humidity and prevent evaporation and incubated at 28°C for at least one hour to allow attachment.

Plasmid DNA was sterilized by ethanol precipitation. In brief, 3M sodium acetate was added to the DNA the previous day at a ratio of 1/10 the total volume and mixed well. Three volumes of ethanol were added to the DNA and mixed. The solution was precipitated overnight at -20°C and the DNA recovered by centrifugation. The DNA pellet was dried, resuspended in sterile ddH₂O and quantified. The concentration was brought to 1 µg/µL with more sterile water.

For each transfection, 2 µg of the plasmid DNA was added to 250 µL of serum-free media. In a separate tube, 8 µL of the CellFectin reagent was diluted in 250 µL serum-free media. The two solutions were mixed well separately, combined, and mixed well together. The solution was incubated at room temperature for 20 minutes. The transfection mixture was then diluted with a further 800 µL of serum-

free media. Media was aspirated from the wells and the dilute transfection mixture slowly overlaid on the cells.

The cells were incubated at 28°C for 3-4 hours and the transfection mixture aspirated from the wells. The cells were washed once with serum-free media and then left overnight at 28°C in fresh serum-free media.

2.16 β -Galactosidase Control Assay

S2 cells were transfected as previously indicated with pAc5.1-lacZ. Two days after transfection, the media was aspirated and the cells rinsed with PBS. The cells were fixed at room temperature for ten minutes in a 2% solution of glutaraldehyde in PBS. The fixing agent was removed by aspiration and the cells rinsed twice with PBS. A solution of 1 mg/mL X-gal in stain solution (0.01 M sodium phosphate buffer pH 7.2, 0.15 M NaCl, 1 mM MgCl₂, 3.1 mM K₄[Fe^{II}(CN)₆], 3.1 mM K₃[Fe^{III}(CN)₆], 0.3% Triton X-100) (Wu et al., 2001), was added to the cells and incubated for 1 hour at 37°C. Cells were visualized using bright field on an inverted microscope for blue staining.

2.17 Metallothionein Induction in pMT Plasmid

At one day after transfection, a solution of sterile CuSO₄ was added to the

media at a concentration of 500 μ M as indicated in the DES literature (Invitrogen). Copper-induced cells were collected 2, 3 and 4 days post-induction. The cells were collected by washing them from the wells and centrifuging them in microcentrifuge tubes. The media was removed and saved while the pellets were washed once with PBS. Both media and cell pellets were flash-frozen and stored at -80°C.

2.18 Selection of Stable Cell Line Expressing DXV-NS

Drosophila S2 cells were dual-transfected with pAc5.1 vector containing the DXV-NS insert and pCoHygro hygromycin-B selection plasmid in a 20:1 ratio. The transfection protocol was as indicated before except using 8 μ g of the pAc5.1/pCoHygro mixture and 16 μ L CellFectin reagent. Following transfection, the cells were switched to Schneider's media with 10% serum and incubated at 28°C for 5 days.

On the fifth day, the media was aspirated and replaced with selection media, Schneider's media with serum and 500 μ g/mL hygromycin-B. The selection media was replaced every 3-5 days until resistant cells began to grow. Once the wells were confluent, resistant cells were expanded to a 25cm² flask and eventually to 75 cm² flasks. Once established, cells were maintained as other S2 cells except in media containing 500 μ g/mL hygromycin.

2.19 Expression in Baculovirus

Transfections were carried out according to the protocols in the Bac and Blue system (Invitrogen). In brief, log phase Sf9 cells from a spinner culture approximately a week old were plated in 6-well plates, 2×10^6 cells per well. The cells were incubated for 15-60 minutes at 28°C to allow attachment.

The transfection reaction was prepared by adding 1 µg of ethanol precipitated pBlueBacHis2-NS transfer vector to one tube containing 0.5 µg Bac-and-Blue DNA from the transfection kit (Invitrogen). A 20 µL aliquot of CellFectin transfection reagent and 1 mL Grace's media without serum were added to the genetic material and the reaction was incubated at room temperature for 15 minutes. The cells were washed once with Grace's media without serum and the media removed and replaced with the transfection reaction. The Sf9 cells were incubated at room temperature for 4 hours on a side-to-side rocker at which time 1 mL of complete Grace's media containing 5% serum was added to the wells. The plate was placed in a sealed container to prevent evaporation and incubated for 72 hours at 28°C.

On the third day post infection, the media was removed and saved and 3 mL of fresh media placed on the cells for an additional day. This was repeated at day 4 and the final aliquot of media collected at day 5. When compared to a control well of uninfected cells, the baculovirus infected Sf9 cells will begin to exhibit cytopathic effects between days 3-5 post transfection characterized by swelling, granular appearance and eventually lysis.

The day 3, 4 and 5 media inoculates contained shed baculovirus and were

plaque purified and selected for expression of the DXV-NS insertion gene. Each inoculate was initially tested in tenfold serial dilutions from 10^{-2} to 10^{-9} , each on a single dish to determine the optimum concentration range to get proper plaque formation.

Sf9 cells were grown to log phase as described before and plated into 100 mm culture dishes at 50% confluence—approximately 5×10^6 cells per dish—in 5 mL of Grace's Insect Media containing 5% FBS. The cells were allowed to attach for approximately one hour and 3 mL of the media were removed and replaced with 1 mL of the serial baculovirus inoculate dilution. The virus was allowed to infect the cells for one hour.

The overlay media was prepared while the cells were being infected. Sterile 2.4% low temperature melting agarose was melted and equilibrated to a temperature of 47°C in a water bath. An equal volume of 2x Graces Insect media (Invitrogen) was prepared and supplemented with 5% serum and 150 µg/mL of sterile X-gal chromogenic substrate. Once the infection incubation was complete, the media was aspirated from the dishes as thoroughly as possible. The overlay was prepared by mixing 5 mL each of the 2x agarose and the 2x Graces media and pipetting it gently over the cells.

Once the agarose had set, the dishes were incubated in a sealed container at 28°C and checked daily. Excess moisture in the container was removed to prevent disruption of the cell monolayer and the plates were visualized under an inverted microscope for presence of plaque formation and blue coloration that would indicate the presence of recombinant plaques.

Once optimal dilutions were established, the assay was repeated using 5-8 dishes at the optimum recombinant baculovirus concentration for proper plaque formation. The protocol was as described above. Recombinant plaques with a blue-green indicator color were selected and transferred into 25cm² flasks of log phase Sf9 cells. The infectious media was removed and saved while the cells were assayed by western blotting for presence of the DXV-NS protein.

2.20 Frameshift Signal

Analysis for a “slippery site” sequence upstream from the DXV-NS open reading frame was with PERL script software search algorithms written by Jonathan Jacobs. An oligonucleotide segment containing the putative signal was synthesized by Integrated DNA Technologies, Inc (Coralville, IA) (Figure 8). The pJC175f dual luciferase reporter plasmid was donated by Jonathan Dinman.

The complementary strands of the signal oligonucleotide, 4.5 µg of each, were heated to 70°C in annealing buffer (20 mM Tris-HCl pH 7.4, 2 mM MgCl₂, and 50 mM NaCl₂) and cooled to room temperature. The annealed insert was purified from a 5% gel of low boiling point agarose. The purified insert was ligated into pJC175f and the final product isolated and verified as described above.

DXVNS shift F

5' -TCGACTGG**AAATTTTTTA**AGAAGCGATTACATCCTCCTAC
CATGCTATCAATTATTAGAAGGAAGACTCGCATCG-3'

DXVNS shift R

5' -GATCCGATGCGAGTCTTCCTTCTAATAATTGATAGCATGG
TAGGAGGATGTAATCGCTTCTTAAAAAATTTCCAG-3'

Figure 8. Frameshift sequence oligonucleotides. Two complementary 75-mer oligonucleotides were designed incorporating the dual overlapping slippery sites (bold) and stem loop found upstream from the DXV-NS ORF (underlined start codon). When annealed, the two oligonucleotides form an insert with sticky ends for insertion into a vector.

Chapter 3

Results

3.1 Quantitative PCR Detects Relative DXV Titer In Infected *Drosophila*

Previous attempts by our group to quantify *Drosophila*-X Virus titer through the common plaque assay method had been unsuccessful; the S2 cells did not maintain fixed monolayers in plaque assays. Instead, quantitative real time PCR (qPCR) was developed as an alternative method to quantify increases in infection based on viral genome load. We designed a custom primer-probe set (Applied Biosystems) which targeted a sequence towards the center of the DXVA segment.

Wild-type Oregon R *Drosophila melanogaster* were injected with a 10^{-4} dilution of DXV in a mixture of sterile water and food coloring. This concentration was previously determined to be an optimal viral load for infection, leading to onset of symptoms at approximately five days post infection and eventually maximum anoxia sensitivity die-off at ten days (Zambon, unpublished). The control group received an injection of water and dye only. Both groups consisted of 60 adult flies.

Five live flies were collected, pooled, and flash frozen from both the infected and control group on days 0, 1, 3, 5, 7. Total RNA was extracted as described previously and subjected to RT-PCR. The cDNA was run through qPCR in two sets, one with the primers and FAM phosphor labeled probes against DXV segment A and the other with a control probe set against the *Drosophila* gene RP49 (Applied Biosystems). Each data point was run in triplicate.

An equal amount of RNA isolate from each data point had been used in the RT-PCR, but obviously the proportion of viral to host RNA would vary greatly. Each sample had to be normalized, and that was accomplished by comparing the quantification of RP49 gene expression, the large ribosomal subunit. This gene is used as a standard for expression in *Drosophila* since it is expressed at a relatively constant level. By equilibrating to a standard count of host cDNA, a more accurate measure of DXV signal between samples could be taken. DXV counts at time-point zero, which are flies harvested immediately following injection, served as the baseline from which to measure fold induction of viral titer.

The results show the dramatic progression of DXV in the fly. Viral titer increases dramatically after the first day of infection, peaking at day five. Even though we can see the titer has reached approximately 80% of maximum by day three, the anoxia sensitivity phenotype does not begin to show until day five (Figure 9).

Although this method does not provide an absolute quantification of viral titer—we have not been able to assign a numerical value such as infectious units—it does allow us to assess relative levels of virus in the fly over the course of an infection. This enables us to correlate anoxia sensitivity to virus load in flies.

3.2 Antibodies Developed to Detect Endogenous and Recombinant DXV-NS

As no commercially available antibody exists against *Drosophila-X* Virus, suitable antisera was developed by Robert Zambon, a graduate student in our lab.

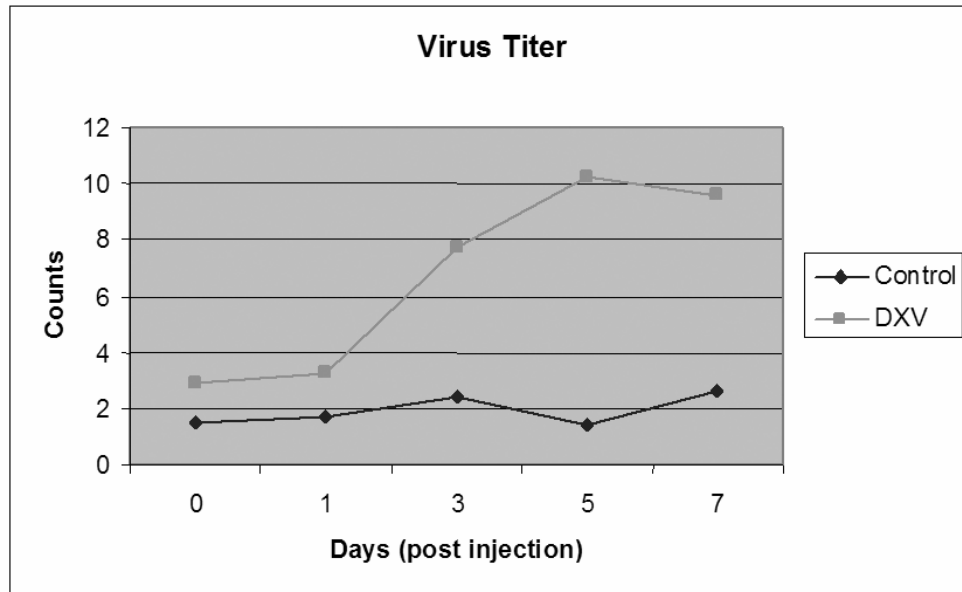

Figure 9. Increase in Drosophila-X Virus titer over time in flies. Control flies were injected with water and DXV infected flies were injected with a 10^{-4} dilution of virus. Flies were collected at day zero immediately following injection and again at days 1, 3, 5, and 7. RNA was extracted from a pool of 5 flies at each time point and passed through RT-PCR and qPCR with primers against DXV and Drosophila RP49. Samples were normalized against RP49 levels and the arbitrary DXV signal counts graphed against time.

The anti-DXV serum contains polyclonal antibodies raised against whole and fractionated DXV in rabbits. When used in western blotting to detect infection, anti-DXV detects three distinctive bands—49, 45, and 34-kDa. These correspond to the known sizes of pVP2, VP2, and VP3 respectively and provide an accurate indicator of DXV infection.

Two anti-His tag antibodies were used. Anti-His(c-term)-HRP was the first used, a horseradish peroxidase conjugated monoclonal antibody raised in mouse against a c-terminal His6 tag (Invitrogen). This was eventually found to be of poor quality, and later experiments used a mouse anti-His antibody from Novagen.

Since *Drosophila-X* Virus Non-structural protein had never been detected, there were no available anti-NS antibodies. The projected amino acid sequence for DXV-NS was analyzed for antigenicity and a portion towards the C-terminus (residues 212 to 228) of the putative protein was selected for immunization. This antiserum was used in concert with anti-His antibodies in attempts to identify recombinant DXV-NS as well as evidence of the protein in infected S2 cells.

The anti-NS antibody was unable to detect NS in infected S2 cells or infected homogenized *Drosophila* in western blots. Despite assaying infected cells and homogenized infected flies at a number of time points up to seven days, there were no discernable differences in protein band staining between lanes containing uninfected material and those lanes with infected material. DXV-NS was also not detected in the media of infected cells.

3.3 Expression of Recombinant DXV-NS in Four Vectors

Drosophila-X Virus NS is a putative protein, never detected in virions or infected flies or cells. It was necessary to produce a recombinant form of the protein to use as a tool in our research. A purified, tagged form of the protein would be useful as a standard as well as a possible antigen for production of an antibody. Forms of DXV-NS suitable for expression in Drosophila cells could be useful to examine the effects of the protein in the host as well as subcellular localization.

Four constructs were produced; each designed to express a His-tagged form of DXV-NS in different hosts or under various promoters. The pET15b vector was designed for high-yield expression in *E. coli*. The pMT and pAc5.1 plasmids were metal-inducible and constitutive insect expression vectors respectively. The transfer plasmid pBlueBac was used for the construction of recombinant baculovirus expressing DXV-NS.

3.4 Lack of DXV-NS expression in BL21 *E. coli*

High-yield expression of DXV-NS was first attempted in *Escherichia coli*. Successful expression would have provided a purified form of the protein to use as a standard to test the efficacy of the DXV-NS antiserum as well as material that could potentially be used as inoculum to generate a new antibody. The NS ORF was cloned into pET15b (Novagen) a β -galactosidase/*lac* driver system vector which also

appends an N-terminal His6 tag. The ORF was PCR amplified from DXVA and ligated into pCR2.1 TOPO as described above. The NS insert was excised with *BglII* at restriction sites designed into the flanking primers (Figure 10) and gel-purified using the QIAquick Gel Extraction Kit (Qiagen, Valencia, CA). The insert was non-directionally ligated into a complementary *BamHI* site in pET15b (Figure 11).

The presence and orientation of the NS insert was verified through differential cutting restriction enzyme digestion using an *EcoRI* site in the vector and a *BamHI* site in the 146 base pair position of the 714 bp insert. The correct orientation would yield an 889 bp piece, while the reverse would produce a 467 bp cut. Properly oriented pET15b-NS constructs were confirmed through sequence analysis and transformed into BL21(DE3)pLysS *E. coli*.

The pET15b system alters the N-terminal end of the target protein with the His tag and uses its own promoter and initiation site, therefore eliminating one variable from protein expression. However, initial attempts at expression failed to produce any over-expressed proteins. Comparison on a protein stained PAGE gel of untransformed BL21 cells and cells induced with either 0.4 or 1 mM IPTG showed no difference in banding and no over-expressed band typical of such high yield protein expression systems (Figure 12). Subsequent ECL western blotting with anti-His antibody (Novagen) failed to produce anything except background.

Initial troubleshooting failed to produce different results. IPTG dosage from 0.4 mM to 1 mM had no effect; neither did varying the method of culture inoculation. 50 mL cultures were initiated from glycerol stocks, colonies on freshly streaked plates, and starter cultures to no avail. One inconsistency was noticed; though the

pET15b Forward priming site

```
5' - AGATCT CATGCTATCAATTATTAGAAGGAAG - 3'
5' - AAATTTTTTAAGAAGCGATTACATCCTCCTACCCATGCTATCAATTATTAGAAGGAAGACT - 3'
3' - TTTAAAAAATTCTTCGCTAATGTAGGAGGATGGTACGATAGTTAATAATCTTCCTTCTGA - 5'
```

pET15b Reverse priming site

```
5' - CTTGGAAAATCAAGGGATATATGTTGA TGAGAGCAAATAATGTCAAGAGGAAGAATATC - 3'
3' - GAACCTTTTAGTTCCCTATATACAACACTCTCGTTTTTATTACAGTTCTCCTTCTTATAG - 5'
3' - CCTTTTAGTTCCCTATATACAACTCTAGA - 5'
```

Figure 10. Forward and reverse priming sites for pET15b-NS construct. The forward and reverse primers insert BglII restriction sites (boxes) flanking the DXV-NS ORF (bold). When inserted in the proper orientation at complementary overhangs produced at a BamHI restriction site in pET15b, this maintains an in-frame fusion with the upstream His6 epitope tag contained in the vector.

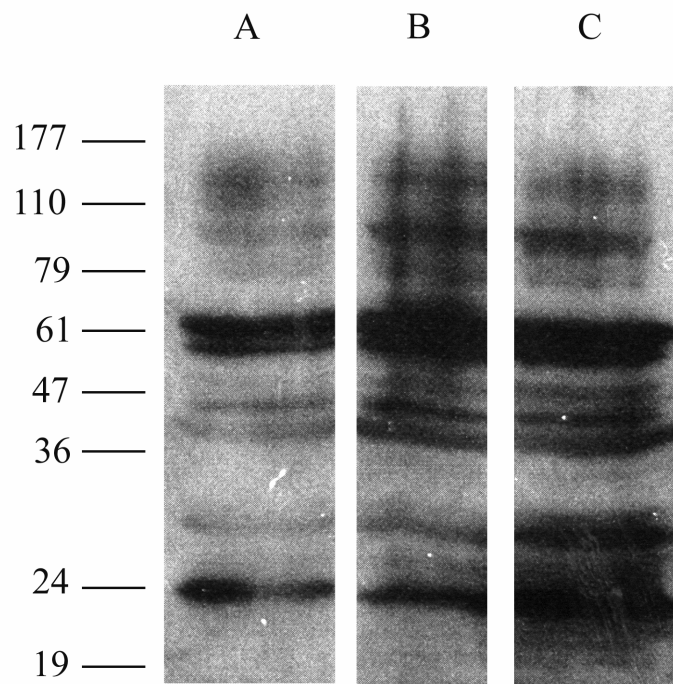

Figure 12. BL21 cells with the pET15b-NS expression construct. This ECL western blot with 1:750 concentration of anti-His antibody (Novagen) fails to show any difference between the control and induced cells. Lane A: Untransformed BL21. Lane B: BL21 with pET15b-NS, induced with 0.4 mM IPTG. Lane C: BL21 with pET15b-NS, induced with 1 mM IPTG. Protein molecular weight standards are in kDa. The predicted size of NS is 27-kDa

established protocol expected a 50 mL culture from a single colony to reach OD₆₀₀ by 3 hours, cultures of pET15b-NS were taking five hours or longer to reach the target density. This retardation of growth could have been a result of plasmid instability due to toxicity of the expressed protein.

To test for plasmid instability, two new 50 mL cultures were grown for pET15b-NS in BL21(DE3)pLysS using more stable carbenicillin as the selection agent rather than ampicillin. The cultures were inoculated directly from a colony on a freshly streaked plate and from a 2 mL starter culture. After growing to OD₆₀₀ 0.6, a sample from each was diluted to 10⁻⁶ and spread on LB agar plates with and without carbenicillin. A 10⁻⁵ dilution of each culture was streaked onto LB agar plates containing IPTG, again with or without carbenicillin.

For a typical culture suitable for high yield expression, nearly all cells should grow on plates containing antibiotic as well as the plain agar plates. Less than 2% should grow on the IPTG plate since only cells that have lost the plasmid should grow. The plate with both IPTG and antibiotic restricts growth to cells that have retained the plasmid and selection marker but lost ability to express the target gene and should allow less than 0.01% to grow.

From the results, it would initially appear that the plasmid is relatively stable (Table 3). Both the plain agar plate and the one containing carbenicillin have greater than a thousand colonies, while the IPTG and IPTG/CARB plates number in the hundreds. However, pET15b-NS is a T7/*lac* promoter construct and was grown in a BL21 strain containing the pLysS plasmid, both of which are factors which can interfere with the interpretation of the IPTG plates. The plasmid stability protocol

Plate	Inoculation Method		Expected results
	Plate	Starter Culture	
agar only	++	++	>99%
CARB	++	++	>99%
IPTG	650	233	<2%
IPTG/CARB	405	169	<0.01%

Table 3. Plasmid stability assay results. BL21 cells with pET15b-NS showing number of colonies per plate. The notation ++ indicates several thousand, too numerous to count. In a culture suitable for overexpression of the target gene, nearly all cells are expected to grow on agar and carbenicillin only plates. Less than 2% should form colonies on plates containing only IPTG and less than 0.01% should grow on plates with both IPTG and the selection agent.

was carried out despite the ambiguous results to see if it had any effect on the NS expression.

The plasmid stability assay, as described in the methods, is designed to replace the growth media several times with increasing levels of carbenicillin, up to five-fold of the standard protocol. Carbenicillin is a more stable analog of ampicillin and changing the media gets rid of the secreted β -lactamase, the enzyme which breaks down the selection antibiotics and confers resistance.

Despite following this protocol, results were identical. There were no changes in protein expression compared with control BL21 cells. Since other DXV-NS expression vectors were in development, this path of investigation was abandoned as unproductive.

3.5 Lack of DXV-NS expression from pMT metallothionein-driven vector

Expression of DXV-NS in *Drosophila* S2 cells was first attempted using pMT/V5-His (Invitrogen), an insect vector driven by the metallothionein promoter and designed to express the gene of interest as a fusion protein with C-terminal V5 and His6 epitope tags. Since it was unknown whether NS would be toxic to the cell or degraded quickly, it was important that expression in S2 cells first be attempted with a vector that allowed inducible expression.

NS was PCR amplified from DXVA with a forward primer containing an *EcoRI* site. The reverse primer was designed to eliminate the double stop codons at

the end of the NS reading frame as well as adding an *XbaI* cut site (Figure 13). The reverse primer also maintained the same frame with the C-terminal tags and stop codon in the vector. The final NS fusion protein would retain its original sequence with the addition of 29 residues from the vector at the C-terminal end (Figure 14).

The NS insert was directionally ligated into pMT at corresponding *EcoRI* and *XbaI* restriction sites. The final product was verified by sequencing. The pMT-NS plasmid was transfected into S2 cells according to the standard protocol alongside wells containing pAc5.1-lacZ reporter plasmid as a transfection positive control. Staining of the reporter wells with X-gal indicated approximately 20-30% efficiency in the transfection, a value which we would find consistent throughout experiments with S2 cells.

The transfected cells were induced with the addition of 500 μ M CuSO₄ and collected for three days. Western blotting with both anti-His (Invitrogen) and anti-NS antibodies revealed only background, no change in comparison to untransfected S2 cells.

Since this plasmid was an inducible vector this added an additional complication to the expression of DXV-NS. It could not be determined whether the lack of expression was in some flaw of design, a problem with induction, or that the cells simply had difficulty expressing this protein. With too many variables, a constitutively active insect vector, pAc5.1 was investigated to eliminate the induction step and remove a variable from the equation.

pMT-NS Forward priming site

5'-GGAATTCCATCCTCCTACCATGCTATCAAT-3'
5'-AAATTTTTTAAGAAGCGATTACATCCTCCTACCAT**ATGCTATCAATTATTAGAAGGAAGACT**-3'
3'-TTTTAAAAATTCTTCGCTAATGTAGGAGGATGGTACGATAGTTAATAATCTTCCTTCTGA-5'

pMT-NS Reverse priming site

5'-CTTGAAAATCAAGGGATATATGTTGATAGAGAGCAAATAATGTCAAGAGGAAGAATATC-3'
3'-GAACCTTTTAGTTCCCTATATACAACTACTCTCGTTTTATTACAGTTCTCCTTCTTATAG-5'
3'-CCTTTTAGTTCCCTATATACACGAGATCTG-5'

Figure 13. Forward and reverse priming sites for pMT-NS construct. The priming sites flank the DXV-NS ORF (bold). The forward primer inserts an EcoRI restriction site (box). The reverse primer removes the double stop codon (underlined) at the end of the DXV-NS ORF and adds an XbaI restriction site (box). When inserted at the corresponding XbaI restriction site in pMT(b), this maintains an in-frame fusion with the downstream epitope tags and stop codon contained in the vector.

```

                                Kpn I Spe I                               BstX I* EcoR I                               EcoR V
                                CCT ACT AGT CCA GTG TGG TGG AAT TCT GCA GAT ATC
                                Pro Thr Ser Pro Val Trp Trp Asn Ser Ala Asp Ile

BstX I* Not I Xho I Xba I Apa I Sac II BstB I
CAG CAC AGT GGC GGC CGC TCG AGT CTA GAG GGC CCG CGG TTC GAA GGT AAG CCT
Gln His Ser Gly Gly Arg Ser Ser Leu Glu Gly Pro Arg Phe Glu Gly Lys Pro

V5 epitope Age I Polyhistidine region
ATC CCT AAC CCT CTC CTC GGT CTC GAT TCT ACG CGT ACC GGT CAT CAT CAC CAT
Ile Pro Asn Pro Leu Leu Leu Gly Leu Asp Ser Thr Arg Thr Gly His His His His

Pme I BGH Reverse priming site
CAC CAT TGA GTTTA AACCCGCTGA TCAGCCTCGA CTGTGCCTTC TAAGATCCAG ACATGATAAG
His His ***

```

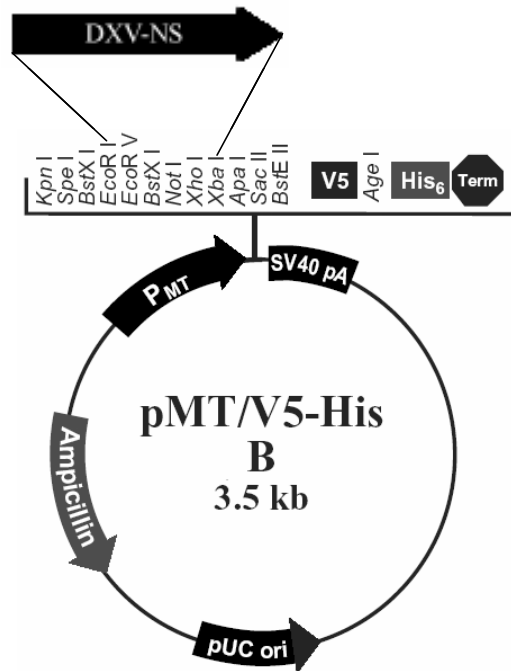

Figure 14. Multiple cloning site and plasmid diagram for pMT/V5-His. DXV-NS inserts in a directional manner at EcoRI and XbaI restriction sites, creating a C-terminal fusion with the V5-His6 epitope tags and stop codon. Expression is driven by the pMT promoter.

3.6 Expression of DXV-NS in stably transfected S2 cells

The use of a constitutively active insect vector was important to eliminate the variable of induction from attempts to express DXV-NS protein. The pAc5.1/V5-His vector is designed to express a gene of interest as a fusion protein with a C-terminal tag containing the V5 and His6 epitopes (Invitrogen). The promoter is constitutively active in all *Drosophila* cell types, including S2. Eventually, this expression construct was scaled up by producing a stable line. As with pMT, the pAc5.1 system has the advantage of expressing DXV-NS in *Drosophila*, its natural host.

Initial cloning into pCR2.1-TOPO was as described previously, but modified with an additional mutation step (Figure 15). The pAc5.1 plasmid required a Kozak sequence in the form 5'-G/A-NNATGG-3' to enhance expression, but the NS sequence had a cytosine instead of a guanine in the +4 position. To ensure proper expression, the NS start sequence was first point-mutated from 5'-ACC-ATG-CTA-3' to 5'-ACC-ATG-GTA-3' at the +4 bp position with a second forward primer. The change results in a substitution of a valine for a leucine that, while not a silent mutation, is a relatively neutral alteration of two biochemically similar residues.

The altered insert in pCR2.1 was used as a template for the second round of PCR with the second forward primer that added an upstream *KpnI* cut site outside the start codon. The reverse primer eliminated the double stop codons at the 3' end of the NS ORF and inserted an *ApaI* restriction site, in frame with the C-terminal fusion epitopes and stop codon. The NS insert was excised from pCR2.1 with a *KpnI/ApaI*

pAc5.1 Kozak sequence mutation

5' - CCTCTACCATG G TATCAATTA - 3'
5' - AAATTTTTTAAGAAGCGATTACATCCTCTACC **ATGGTATCAATTATTAGAAGGAAGACT** - 3'
3' - TTTAAAAAATTCTTCGCTAATGTAGGAGGATGGTACGATAGTTAATAATCTTCCTTCTGA - 5'

pAc5.1-NS Forward priming site

5' - GGTACCA AAGCGATTACATCCTCTA - 3'
5' - AAATTTTTTAAGAAGCGATTACATCCTCTACC **ATGGTATCAATTATTAGAAGGAAGACT** - 3'
3' - TTTAAAAAATTCTTCGCTAATGTAGGAGGATGGTACCATAGTTAATAATCTTCCTTCTGA - 5'

pAc5.1-NS Reverse priming site

5' - CTTGGAAAATCAAGGGATATATGTTGA TGAGAGCAAATAATGTCAAGAGGAAGAATATC - 3'
3' - GAACCTTTTAGTTCCCTATATACA AACTACT CTCGTTTTTATTACAGTTCTCCTTCTTATAG - 5'
3' - GAACCTTTTAGTTCCCTATATTT CCCCGGG - 5'

Figure 15. Priming sites in two-step PCR reaction for pAc5.1-NS construct. The mutation primer first creates a point mutation at the +4 position, changing the Kozak sequence to a form that fits the required 5'-G/A-NNATGG-3' motif. In the second step, the priming sites flank the DXV-NS ORF (bold). The forward primer inserts a *KpnI* restriction site (box). The reverse primer removes the double stop codon (underlined) at the end of the DXV-NS ORF and adds an *Apal* restriction site (box). When inserted at the corresponding *Apal* restriction site in pAc5.1(b), this maintains an in-frame fusion with the downstream epitope tags and stop codon contained in the vector.

double digest and directionally subcloned into the corresponding restriction sites in pAc5.1 (Figure 16). The completed plasmid was sequenced for verification.

Wells of S2 cells were transfected with either pAc5.1-NS or the pAc5.1-lacZ control plasmid. When stained, the control indicated approximately 30% transfection efficiency. The cells were harvested and flash frozen over several days and analyzed through western blotting with anti-His (Novagen) and anti-NS antibodies. Once again, there was only background and no discernable difference between cells with and without the plasmid.

It seemed possible that expression was occurring in only a few cells or at extremely low levels since despite the successful transfection, no protein could be detected. Since individual transfections were an inefficient method of producing protein, the process was scaled up by creating a stable cell line with the pAc5.1-NS construct.

The stable line was created with a co-transfection of S2 cells with pCoHygro and an excess of pAc5.1-NS. The pCoHygro is a selection plasmid conferring resistance to hygromycin-B and is transfected in a 1:20 proportion with the vector so as to ensure that nearly all cells that receive the selection plasmid also receive the expression vector. Cells were selected and expanded according to the protocol indicated previously for approximately 6 weeks, resulting in a confluent 75cm² flask of S2 cells with the pAc5.1-NS plasmid. These cells were used as a polyclonal culture since dilution to single cells to create a monoclonal culture was not possible with the S2 line. The S2 cells require a minimum concentration for growth and when

```

      KpnI          BstXI EcoRI          EcoRV          BstXI NotI
GTA CCT ACT AGT CCA GTG TGG TGG AAT TCT GCA GAT ATC CAG CAC AGT GGC GGC
Val Pro Thr Ser Pro Val Trp Trp Asn Ser Ala Asp Ile Gln His Ser Gly Gly

      XhoI      XbaI          ApaI Sac II  BstBI          V5 epitope
CGC TCG AGT CTA GAG GGC CCG CGG TTC GAA GGT AAG CCT ATC CCT AAC CCT CTC
Arg Ser Ser Leu Glu Gly Pro Arg Phe Glu Gly Lys Pro Ile Pro Asn Pro Leu

                                     Polyhistidine region
CTC GGT CTC GAT TCT ACG CGT ACC GGT CAT CAT CAC CAT CAC CAT TGA
Leu Gly Leu Asp Ser Thr Arg Thr Gly His His His His His His ***

```

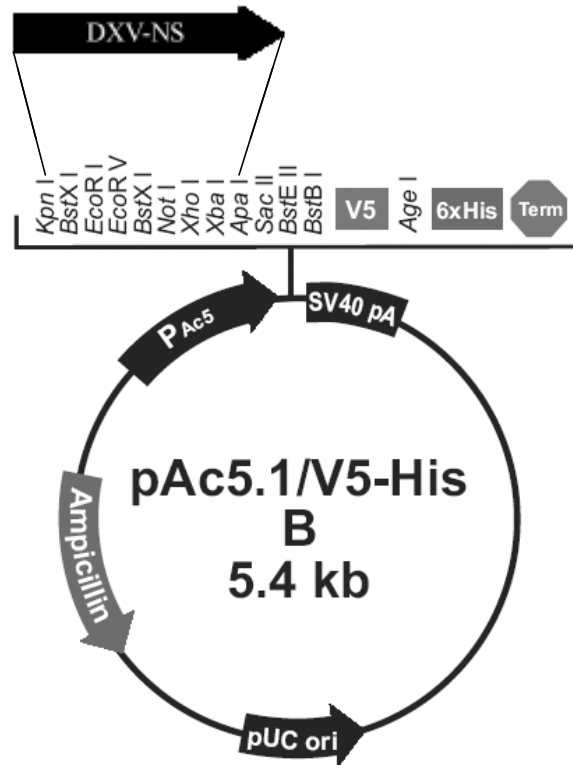

Figure 16. Multiple cloning site and plasmid diagram for pAc5.1/V5-His. DXV-NS inserts in a directional manner at KpnI and ApaI restriction sites, creating a C-terminal fusion with the V5-His6 epitope tags and stop codon. Expression is driven by the pAc5 promoter.

spread too thin will not grow and divide. It took several attempts before successful polyclonal stable cultures were established after the initial die-off.

These cells were maintained in Schneider's complete media containing 500 µg/mL hygromycin-B. These cells, while apparently healthy with no changes in growth, do appear to have some physical changes. Compared to normal S2 cells, the stable NS line cells tend to clump a bit more and have poor adhesion to the surface of a flask or well, though this may be an effect of the selection agent.

A large number of cells (10 mL of a confluent flask or approximately 10^7 cells) were centrifuged and lysed to form a cell concentrate. Denatured by boiling and resolved on a PAGE gel, this concentrate was blotted with anti-His (Novagen) and anti-NS. A distinct band was revealed at approximately 30-kDa with both antibodies, consistent with the epitope tagged fusion NS protein (Figure 17).

It appears that NS is being produced by the pAc5.1-NS construct, but at very low levels. The reason for this result is unknown. Toxicity is a possible answer, but if so, the protein does not appear at these low levels to be lethal enough to cause widespread death in S2 cells since the stable line appears to maintain the same greater than 99% viability as normal cells. Perhaps high expression is toxic and this has selected for variants which express NS only at low levels. Without determining what percentage of cells express protein, it is also possible that most have lost the expression plasmid while retaining the selection plasmid. It is possible that future immunofluorescent staining of these cells with anti-His or anti-NS could provide an answer.

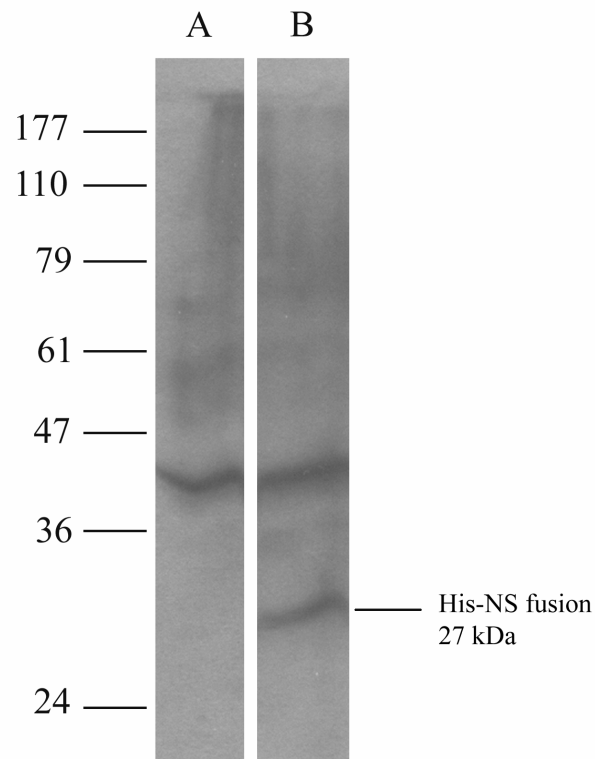

Figure 17. Expression of constitutively active pAc5.1-NS construct in S2 cells. ECL Western blot with a 1:1000 dilution of anti-His antibody (Novagen). Lane A: Untransfected S2 cells. Lane B: S2 cells, stable transfected line with pAc5.1-NS. Protein standards are in kDa. There is an expressed protein in the transfected cells which appears at the predicted 27-kDa size for DXV-NS.

3.7 Expression of DXV-NS from recombinant Baculovirus

Expression of DXV-NS using a recombinant baculovirus system was developed concurrently with the pAc5.1 constitutively expressing system. The vector pBlueBacHis2 is a transfer vector designed for use with the Bac-and-Blue transfection kit as a complete system for the cloning and expression of a gene of interest in a recombinant baculovirus (Invitrogen). The system expresses this gene as an N-terminus fusion with the His6 tag for easy identification. Recombinant baculoviruses containing the inserted gene of interest will also have an active β -galactosidase indicator gene and will result in blue plaques in the presence of X-gal.

The NS reading frame was PCR amplified from the DXVA clone using flanking primers designed with *BglIII* and *EcoRI* directional restriction sites (Figure 18). As described before, the insert was ligated into pCR2.1-TOPO and excised at the restriction sites. The NS ORF was cloned in frame into pBlueBacHis2, lining up with the vector-provided initiation site and His tag (Figure19). Vectors were grown and isolated as indicated before and verified by restriction digest and sequencing.

During transfection, the pBlueBacHis2 transfer plasmid carrying the DXV-NS/His fusion gene recombines with the baculovirus genomic DNA from the kit at homologous transfer points designed into the two pieces of DNA. The resulting recombinant baculovirus is collected from the media and plaque purified.

Recombinant virus with the inserted gene of interest will express β -galactosidase and stain blue in the presence of media containing X-gal. Blue staining of plaques and surrounding agarose in the plates was observed, indicating successful

pBlueBacHis2C Forward priming site

```
5' - AGATCT CATGCTATCAATTATTAGAAGGAAG - 3'
5' - AAATTTTTTAAGAAGCGATTACATCCTCCTACCAATGCTATCAATTATTAGAAGGAAGACT - 3'
3' - TTTAAAAAATTCTTCGCTAATGTAGGAGGATGGTACGATAGTTAATAATCTTCCTTCTGA - 5'
```

pBlueBacHis2C Reverse priming site

```
5' - CTTGGAAAATCAAGGGATATATGTTGAT GAGAGCAAATAATGTCAAGAGGAAGAATATC - 5'
3' - GAACCTTTTAGTTCCCTATATACTACTCTCGTTTTATTACAGTTCTCCTTCTTATAG - 3'
3' - CCTTTTAGTTCCCTATATACTCTTAAG - 5'
```

Figure 18. Forward and reverse priming sites for pBlueBacHis2c construct. The priming sites flank the DXV-NS ORF (bold). The forward primer inserts a BglII restriction site (box) and the reverse primer adds an EcoRI restriction site (box). When inserted at the corresponding BglII restriction site in pBlueBacHis2c, this maintains an in-frame fusion with the upstream epitope tags contained in the vector.

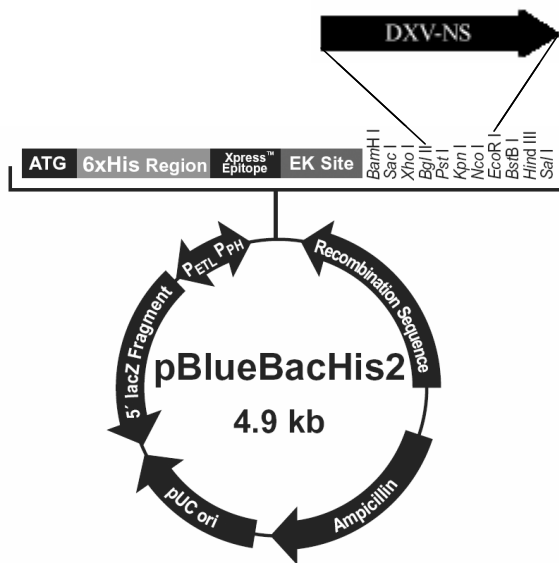
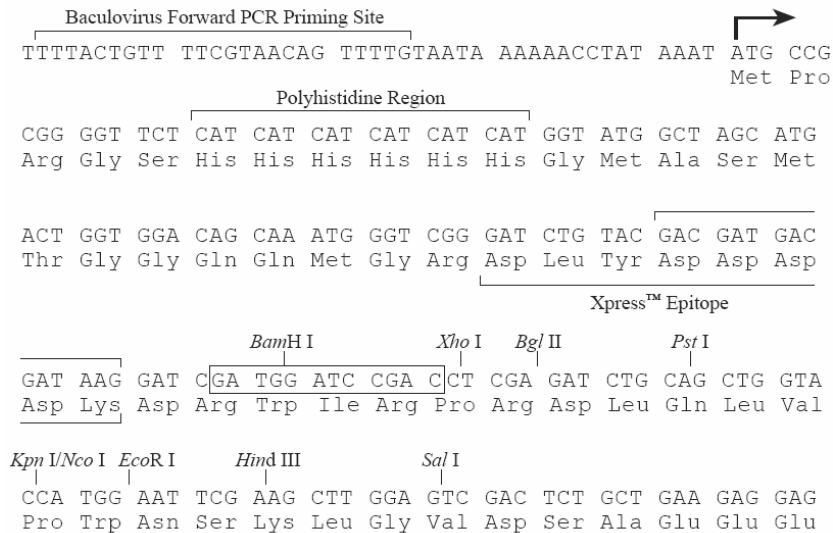

Figure 19. Multiple cloning site and plasmid diagram for pBlueBacHis2c. DXV-NS inserts in a directional manner at BglIII and EcoRI restriction sites, creating an N-terminal fusion with the His6 epitope tag. The BlueBac transfer vector recombines with genomic baculovirus DNA in the Bac and Blue kit (Invitrogen) to form baculovirus expressing the NS gene.

recombination. Six plaques were isolated and expanded in 25 cm² flasks of Sf9 cells. Western blots of these infected cells with a 1:1000 dilution of anti-His antibody (Novagen) and 1:750 anti-NS revealed an identical strong band at approximately 27-kDa, the expected size for the His-DXV-NS fusion protein (Figure 20).

3.8 DXV-NS contains a putative upstream frameshift signal

The DXV-NS ORF is located in the middle of segment A, its start sequence overlapping the coding region for the polyprotein. If the NS protein is made by Drosophila-X Virus, it is possible that this is accomplished through programmed -1 frameshifting. We investigated whether the sequence upstream from NS contained a -1 PRF site.

The nearest upstream stop codon in the -1 frame is -72 bases from the DXV-NS ORF, so any slippery site must be downstream of this point. The region was analyzed using software and search algorithms designed by Jonathan Jacobs. Two overlapping slippery sites were found upstream from the start of the NS ORF: 5'-A AAU UUU-3' at the -33 position and 5'-U UUU UUA-3' starting at -30. This signal was followed by a spacer (7 or 4 nucleotides for the respective sites) and a substantial stem-loop (Figure 21). Although no RNA modeling configuration was found in which the stem-loop formed a pseudoknot, this does not necessarily mean that such a structure does not exist. The relative strength of the slippery site combined with the proper position of the stem-loop warranted further investigation.

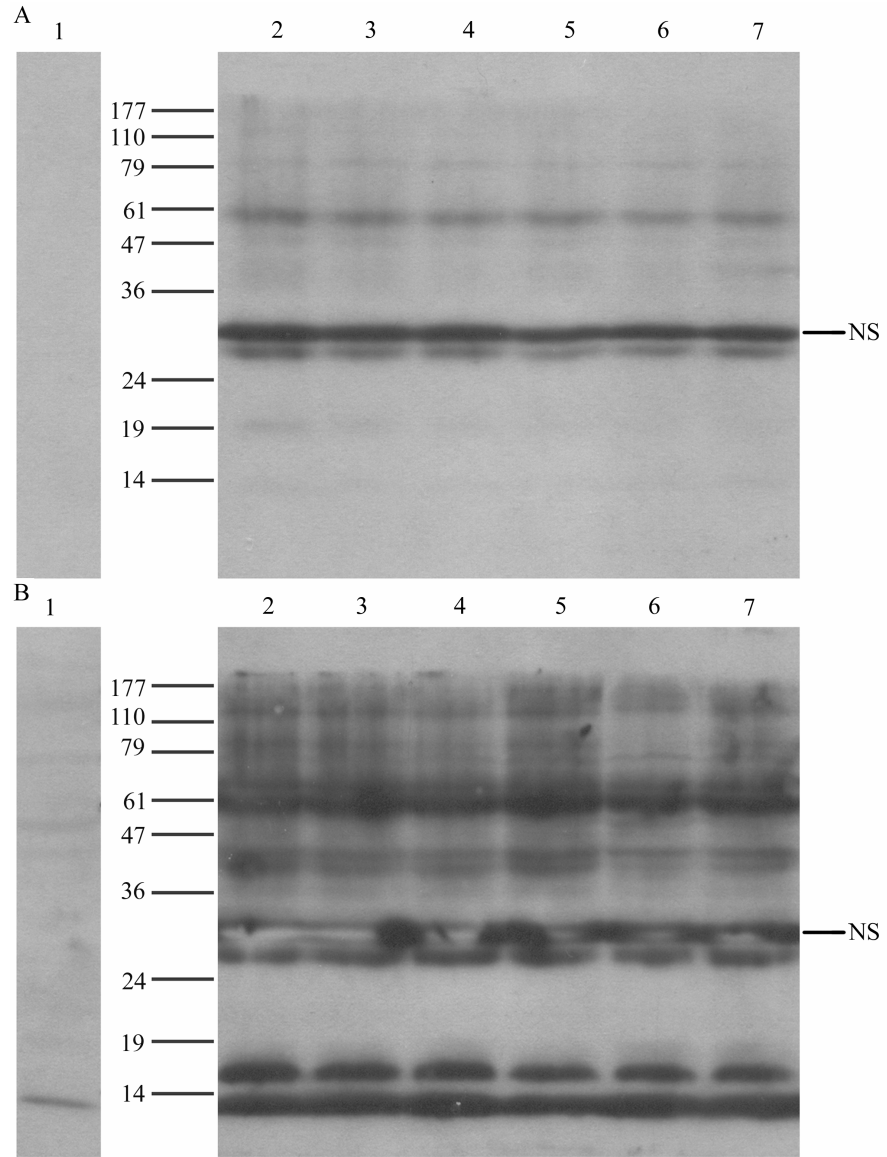

Figure 20. Expression of DXV-NS/His fusion protein from recombinant baculovirus. Lane 1: Uninfected Sf9 control. Lanes 2-7: Recombinant Baculovirus isolates 1-6. Part A: Western blot with 1:1000 anti-His (Novagen). Part B: Western blot with 1:750 anti-NS. Both blots show identical bands at the predicted 27-kDa size for DXV-NS.

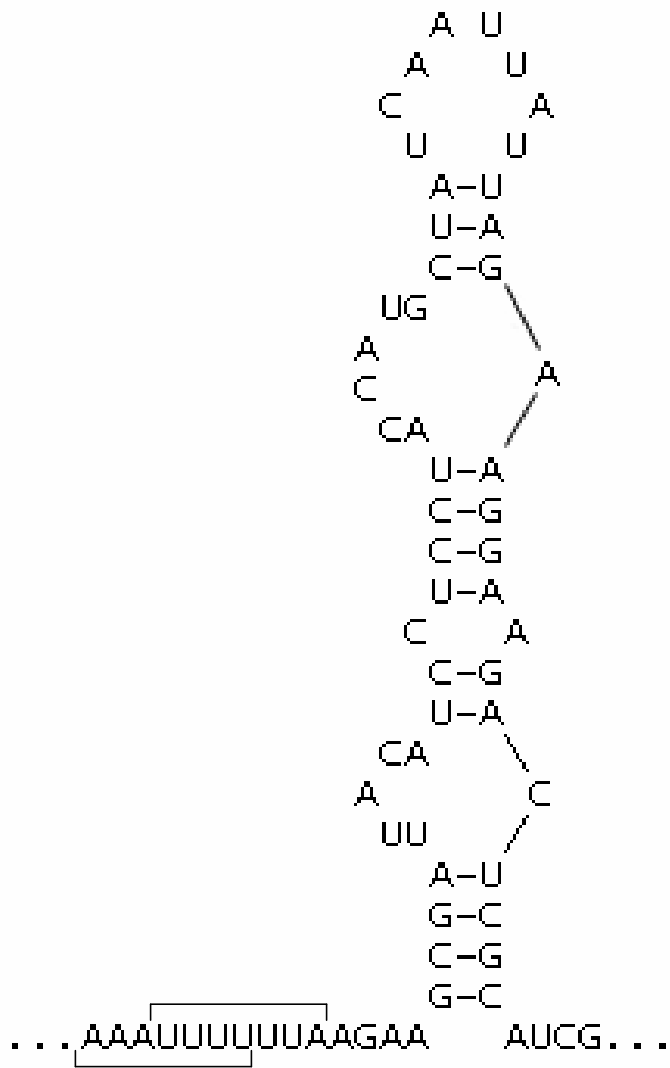

Figure 21. Portion of DXVA genome showing -1 PRF site. The 5'-A AAU UUU-3' slippery site (bottom bracket) is separated from the stem loop by a 7 nt spacer and is -33 nt upstream from the start of the DXV-NS ORF. The 5'-U UUU UUA-3' slippery site (top bracket) is separated from the stem loop by a 4 nt spacer and is -30 nt upstream from the start of the DXV-NS ORF.

The sequence for the slippery site and stem loop discovered in this search was incorporated into a pair of 75-mer oligonucleotides from Integrated DNA Technologies Inc. (Coralville, AI) which were complementary but with overhanging ends that matched restriction enzyme sites in a *Sall* to *BamHI* direction. The two oligonucleotides were annealed and gel purified to form the slippery site insert.

The plasmid pJD175f was used for the frameshifting reporter. Obtained from the laboratory of Jonathan Dinman, it consists of a modified p2luc vector (Grentzmann et al, 1998). A T7 promoter drives expression of sequential *Renilla* luciferase (*rluc*) and firefly luciferase (*fluc*) genes. A polylinker site between the two allows insertion of the slippery site sequence so that *fluc* is in a -1 frame from *rluc* and requires -1 frameshifting to be expressed. The ratio of firefly to *Renilla* luciferase reveals what percentage of translation events result in a slip and -1 frameshift.

The pJD175f reporting vector was cut at the polylinker with *Sall* and *BamHI*. The insert containing the putative slippery site and stem loop upstream from DXV-NS was directionally ligated into the vector and the completed reporter construct transformed and grown in TOP10F' *E. coli* as described above. Plasmids were purified from culture and verified via sequencing.

This frameshifting construct will be a useful future tool in the further study of DXV-NS. If the slippery site does not produce a -1 frameshift, it is unlikely that this is the method of expression for NS and other translation schemes involving motifs such as an IRES should be investigated.

Chapter 4

Discussion and Conclusions

4.1 Conclusions

In the course of this thesis work, there were some successes which resulted in the creation of a number of useful tools for the further study of Drosophila-X virus and the putative non-structural protein. These experiments have also tested and rejected some avenues of research.

We now have a method for measuring the change in virus titer over the course of DXV infection. Though qPCR has not been shown to be strictly quantitative in this case, it can however be used to measure relative levels of the virus in flies. This technique has proven useful to other members of our laboratory who are investigating the effects that RNA interference (RNAi) and Drosophila innate immune system pathway mutants have on DXV growth. They have been able to show variations in the rate of DXV proliferation in these mutants which correlate to increased susceptibility to DXV.

The initial impetus for creating a recombinant form of DXV-NS was that there was no source of the natural protein. Though existence of this non-structural protein was theorized and backed by circumstantial structural evidence, NS had never been detected in infected flies or cells, nor did it appear in *in vitro* transcription-translation systems with the viral genome. We sought to circumvent this problem by producing two forms of epitope tagged NS protein. One would come from a high-yield

expression vector suitable for purification which could serve as a detection control and aid in production of a DXV-NS antibody. The other form would be capable of expression in a *Drosophila* cell line to study the effects of NS in the natural host of DXV. Both forms would be created as His-tagged fusion proteins for dual identification and possibly for purification.

The *E. coli* expression plasmid pET15b was initially selected for high-yield expression, but despite numerous attempts to troubleshoot this system and compensate for suspected plasmid instability, we were unable to produce DXV-NS. Problems also arose with the first *Drosophila* expression vector, the metal-inducible plasmid pMT. The copper induction step added a variable which made it difficult to determine why the NS protein was failing to express at detectable levels. With the lessons learned by the later success with pAc5.1-NS, it may now be worthwhile to go back and produce a stable transfection line with pMT-NS.

The first system to successfully produce His-tagged DXV-NS was pAc5.1, a vector specifically designed for the constitutive expression of proteins of interest in the Schneider-2 *Drosophila* cell line. Eliminating the induction step necessary for expression in pMT removed that variable from the system. This construct was parlayed into a successful S2 stable line which, although it produced only a small amount of the recombinant protein, clearly produced a band at the correct position for a 27-kDa protein.

The success with a *Drosophila* expression vector was soon followed by the creation of several isolates of recombinant baculovirus which expressed another form of the His-NS fusion protein. The baculovirus version of NS was expressed at high

levels and was easily detectable in western blots with both anti-His and anti-NS antibodies.

The successful production of recombinant DXV-NS has direct applications to the ongoing study of the putative protein. The anti-NS serum produced from an artificial linear peptide found in the NS sequence is an imperfect tool. We have found it to be effective yet highly non-specific, but at the time, it was the only option for an antibody since we did not have a source of NS protein. Now with His-tagged recombinant NS from the baculovirus expression isolates, we can affinity purify the anti-NS serum and create a more highly refined product. If the linear peptide based NS antibody still proves inadequate following purification, the recombinant protein can also be used to inoculate and create a new antibody against the entire NS protein.

The problems encountered with the expression of recombinant forms of DXV-NS can offer some insight into the role this putative protein could play. The low levels of expression with the constitutively active vector could be indicative of some degree of toxicity to the cell. If NS does exist in natural infection, this apparent toxicity may mean that it plays a role in the virus' interaction with the host and that like the other small basic proteins in IPNV and IBDV, it may be pro-apoptotic in its natural form. Perhaps DXV-NS is being produced at very low levels and/or only briefly during the course of infection. Its highly basic nature makes it an ideal candidate for nucleic acid interactions as does the presence of the nuclear targeting signal. It may also very well be the agent responsible for the anoxia sensitivity phenotype through an as yet unknown host interaction.

The position of the DXV-NS ORF, overlapping the polyprotein frame, is

unusual and would require a yet unknown scheme for translation. The detection of -1 frameshifting slippery sites upstream from NS could be the answer. If NS is produced as a fusion with a portion of the polyprotein at a very low frameshift/read-through ratio during translation, then the miniscule amount of this protein might elude detection and would run at a larger size. It might even be a time-dependent event, only produced at a certain point in the DXV infection cycle. We now have a construct which could be used to test the frameshifting theory.

We can test for -1 frameshifting events and quantify the frameshifting efficiency using the dual-luciferase reporter construct. Evidence of an active -1 frameshifting motif directly upstream from the NS ORF would give clues as to how NS may be expressed. This would be a strong indicator that this protein does exist and is expressed as a fusion protein. If the results are positive, this could also indicate that other Birnaviruses may have a similar overlapping reading frame expressing a non structural protein that has not been recognized because it lacks a start codon.

If the -1 frameshift results are negative, it is still possible that the upstream sequence contains a previously undetected IRES motif. This model can also be investigated by a modification the same dual-luciferase construct. By inserting a stop codon after the *rluc* gene and splicing the putative IRES region between the two luciferase reporters, this creates a construct in which the second *fluc* signal would only be expressed if the inserted sequence contained an IRES motif.

4.2 Future Study

The work outlined in this thesis has further developed our knowledge of the putative DXV non structural protein. Viruses tend to be very economical; rarely do they carry material in their genome which does not serve a purpose. The number of significant features related to NS which have now been identified begin to add up and make it increasingly unlikely that this is merely an artifact. The tools developed through this thesis research open up a number of future opportunities, not just for the continued study of the NS putative protein but also to more generalized study of DXV, other Birnaviruses, and even host response to virus in *D. melanogaster*.

Our group has been developing a reverse genetics system for Drosophila-X Virus, a construct capable of producing virus from a cDNA clone. This approach, while technically challenging, has been successfully accomplished with both IPNV and IBDV (Song, 2003). From these reverse genetics constructs, we hope to produce viable DXV following transfection into host S2 cells and provide us with a tool to manipulate the DXV genome. A genetic approach can be used to study the effects of mutations on the virus; in particular, a mutant that eliminates the NS ORF could inform us as to the function of NS *in vivo*. If an NS-deleted mutant virus replicated slower, failed to proliferate, or produced a change in the anoxia sensitivity phenotype, this would be an excellent indicator that the non-structural protein does play a role in the DXV lifecycle. In addition, we could see if defects in an NS deletion mutant could be rescued by growing the mutant in the S2 cell line expressing NS.

There are three possible roles for the DXV-NS function which arise from what we know of NS sequence, its homology to IPNV and IBDV small basic proteins, and the *Drosophila* innate immune response to DXV. First, the bipartite nuclear targeting signal found in the DXV-NS sequence could be an indication that the protein is localized in the nucleus of infected cells. We now have tools to be able to investigate this. The stable line expresses His-tagged NS in S2 cells and could be immunofluorescence stained with anti-His or anti-NS antibodies to determine whether the recombinant NS is localizing to the nucleus. If a future “next generation” anti-NS antibody is produced using recombinant protein, this could also be used to look at localization in the course of DXV infection. If NS is in the nucleus, this indicates that it may be involved in gene regulation.

The second possibility is that DXV-NS may be involved in apoptosis. Its similarity to the small basic proteins of IPNV and IBDV lead to questions as to whether NS could also be implicated in apoptosis. We might be able to test this model for NS function by looking for apoptotic effects in flies and cells. Programmed cell death is an important part of development, and apoptosis in tissues of *Drosophila* embryos is well studied (White *et al.*, 1994). With purified recombinant NS protein, we could inject embryos and look for changes in the normal pattern of cell death in the developing embryo. If cell death effects are seen, then this may indicate that DXV-NS is linked to the apoptotic effects seen in IPNV and IBDV.

Finally, NS may suppress RNAi mechanisms. We have found that *Drosophila* mutants affecting RNAi are more susceptible to DXV infection (Zambon, unpublished). RNAi is thought to be the primary defense against dsRNA viruses (Li

et al., 2002) Many viruses have evolved mechanisms to suppress RNAi and we can now test whether NS might play a role in DXV suppression of silencing. We can also examine if RNAi mechanisms that normally function in S2 cells are perturbed in the stable line expressing DXV-NS and determine if NS affects the cells' use of RNAi to degrade double stranded RNA. The use of the tools developed in this research may lead to discoveries reaching far beyond DXV and could give us clues into the innate immune response to viruses.

References

- Becht, H. (1980). Infectious bursal disease virus. *Current Topics in Microbiology and Immunology*. 90: 107-121.
- Brierley, I., Dingard, P., Inglis, S. C. (1989). Characterization of an efficient coronavirus ribosomal frameshifting signal: Requirement for an RNA pseudoknot. *Cell*. 57: 537-547.
- Brierley, I. A., Jenner, A. J., Inglis, S. C. (1992). Mutational analysis of the 'slippery sequence' component of a coronavirus ribosomal frameshifting signal. *Journal of Molecular Biology*. 227: 463-479.
- Chung, H. K., Kordyban, S., Cameron, L., Dobos, P. (1996). Sequence analysis of the bicistronic Drosophila-X virus genome segment A and its encoded polypeptides. *Virology*. 225: 359-368.
- Dinman, J., Icho, T., Wickner, R. (1991). A -1 ribosomal frameshift in a double-stranded RNA virus of yeast forms a gag-pol fusion protein. *Proceedings of the National Academy of Sciences*. 88: 174-178.
- Dobos, P. (1995). The molecular biology of infectious pancreatic necrosis virus. *Annual Review of Fish Diseases*. 5: 25-54.
- Dobos, P., Hill, B. J., Hallett, R., Kells, D. T. C., Becht, H., Teninges, D. (1979). Biophysical and biochemical characterization of five animal viruses with bisegmented double-stranded RNA genomes. *Journal of Virology*. 32(2): 593-605.
- Dobos, P., Berthiaume, L., Leong, J. A., Kibenge, F. S. B., Muller, H., Nicholson, B. L. (1995). Birnaviridae. In "Virus Taxonomy—Classification and Nomenclature of Viruses: Sixth Report of the International Committee on Taxonomy of Viruses" (R. I. B. Francki, C. M. Faquet, D. L. Knudson, and F. Brown, Eds.), pp. 240-244. Springer-Verlag, Wien/New York.
- Duncan, R., Nagy, E., Krell, P. J., and Dobos, P. (1987). Synthesis of the infectious pancreatic necrosis virus polyprotein, detection of a virus-encoded protease, and the fine structure mapping of the genome segment A coding regions. *Journal of Virology*. 61(12): 3655-3664.
- Greutzmann, G., Ingram, J. A., Kelly, P. J., Gesteland, R. F., Atkins, J. F. (1998). A dual-luciferase reporter system for studying recoding signals. *RNA*. 4: 479-486.

- Hong, J. R., Gong, H. Y., Wu, J. L. (2002). IPNV VP5, a novel anti-apoptosis gene of the Bcl-2 family, regulates Mcl-1 and viral protein expression. *Virology*. 295(2): 217-229.
- Hong, J. R., Hsu, Y. L., Wu, J. L. (1999). Infectious pancreatic necrosis virus induces apoptosis due to down-regulation of survival factor MCL-1 protein expression in a fish cell line. *Virus Research*. 63(1-2): 75-83.
- Hong, J. R., Lin, T. L., Hsu, Y. L., Wu, J. L. (1998). Apoptosis precedes necrosis of fish cell line with infectious pancreatic necrosis virus infection. *Virology*. 250(1): 76-84.
- Jungmann, A., Nieper, H., Muller, H. (2001). Apoptosis is induced by infectious bursal disease virus replication in productively infected cells as well as in antigen-negative cells in their vicinity. *Journal of General Virology*. 82:1107-1115.
- Li, H., Li, W. X., Ding, S. W. (2002). Induction and suppression of RNA silencing by an animal virus. *Science*. 296(5571):1319-1321.
- Magyar, G. and Dobos, P. (1994). Evidence for the detection of the infectious pancreatic necrosis virus polyprotein and the 17-kDa polypeptide in infected cells and of the NS protease in purified virus. *Virology*. 204: 580-589.
- Mundt, E., Beyer, J., Muller, H. (1995). Identification of a novel viral protein in infectious bursal disease virus-infected cells. *Journal of General Virology*. 76: 437-443.
- Nagy, E. and Dobos, P. (1984a). Synthesis of Drosophila-X virus proteins in cultured Drosophila cells. *Virology*. 134: 358-367.
- Nagy, E. and Dobos, P. (1984b). Coding assignments of Drosophila-X virus genome segments: *in vitro* translation of native and denatured virion dsDNA. *Virology*. 137: 58-66.
- Plant, E. P., Jacobs, K. L., Harger, J. W., Meskauskas, A., Jacobs, J. L., Baxter, J. L., Petrov, A. N., Dinman, J. D. (2003). The 9-angstrom solution: how mRNA pseudoknots promote efficient programmed -1 ribosomal frameshifting. *RNA*. 9(2):168-174.
- Revet, B. and Delain, E. (1982). The Drosophila X virus contains a 1 mM double-stranded RNA circularized by a 67-kDa terminal protein: high resolution denaturation mapping of its genome. *Virology*. 123: 29-44.
- Sambrook, J., Fritsch, E. F., Maniatis, T. (1989). *Molecular Cloning: A laboratory manual*, 2nd ed. Cold Spring Harbor Laboratory, Cold Spring Harbor, NY.

- Shivappa, R. B., Song, H., Yao, K., Aas-Eng, A., Evensen, O., Vakharia, V. N. (2004). Molecular characterization of Sp serotype strains of infectious pancreatic necrosis virus exhibiting difference in virulence. *Diseases of Aquatic Organisms*. *In press*.
- Shwed, P. S., Dobos, P., Cameron, L. A., Vakharia, V. N., Duncan, R. (2002). Birnavirus VP1 proteins form a distinct subgroup of RNA-dependent RNA polymerases lacking a GDD motif. *Virology*. 296(2): 241-250.
- Song, H. (2003). Functional studies of infectious pancreatic necrosis virus proteins and mechanism of virus-induced apoptosis. Doctoral dissertation, University of Maryland, College Park, MD.
- Teninges, D., Ohanessian, A., Richard-Molard, C., Contamine, D. (1979). Isolation and biological properties of Drosophila-X virus. *Journal of General Virology*. 42: 241-254.
- Teninges, D. (1979). Protein and RNA composition of the structural components of Drosophila-X virus. *Journal of General Virology*. 45: 641-649.
- White, K., Grether, M. E., Abrams, J. M., Young, L., Farrell, K., Steller, H. Genetic control of programmed cell death in Drosophila. *Science*. 264(5159):677-683.
- Wolf, K. (1988). Fish viruses and fish viral diseases. Canstock Publishing Associates, Cornell University Press, Ithaca, NY.
- Wu, L. P., Choe, K. M., Lu, Y., Anderson, K. V. (2001). Drosophila immunity: genes on the third chromosome required for the response to bacterial infection. *Genetics*. 159: 189-199.
- Yao, K., Goodwin, M. A., Vakharia, V. N. (1998). Generation of a mutant infectious bursal disease virus that does not cause bursal lesions. *Journal of Virology*. 72: 2647-2654.
- Yao, K. and Vakharia, V. N. (2001). Induction of apoptosis in vitro by the 17-kDa nonstructural protein of infectious bursal disease virus: possible role in viral pathogenesis. *Virology*. 285(1): 50-58.