



# LUND UNIVERSITY

## Clinical and genetic studies of patients and families with ataxia

Gorcenco, Sorina

2023

*Document Version:*

Publisher's PDF, also known as Version of record

[Link to publication](#)

*Citation for published version (APA):*

Gorcenco, S. (2023). *Clinical and genetic studies of patients and families with ataxia*. [Doctoral Thesis (compilation), Department of Clinical Sciences, Lund]. Lund University, Faculty of Medicine.

*Total number of authors:*

1

### General rights

Unless other specific re-use rights are stated the following general rights apply:

Copyright and moral rights for the publications made accessible in the public portal are retained by the authors and/or other copyright owners and it is a condition of accessing publications that users recognise and abide by the legal requirements associated with these rights.

- Users may download and print one copy of any publication from the public portal for the purpose of private study or research.
- You may not further distribute the material or use it for any profit-making activity or commercial gain
- You may freely distribute the URL identifying the publication in the public portal

Read more about Creative commons licenses: <https://creativecommons.org/licenses/>

### Take down policy

If you believe that this document breaches copyright please contact us providing details, and we will remove access to the work immediately and investigate your claim.

LUND UNIVERSITY

PO Box 117  
221 00 Lund  
+46 46-222 00 00



# Clinical and genetic studies of patients and families with ataxia

SORINA GORCENCO

DEPARTMENT OF CLINICAL SCIENCES LUND | FACULTY OF MEDICINE | LUND UNIVERSITY

*Dona Simoes*

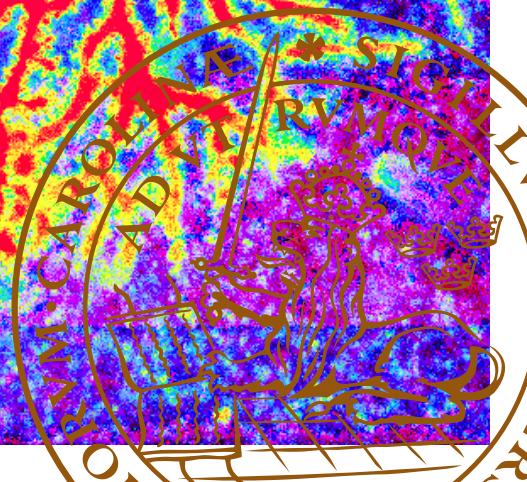



# Clinical and genetic studies of patients and families with ataxia

Sorina Gorcenco



**LUND**  
UNIVERSITY

DOCTORAL DISSERTATION

Doctoral dissertation for the degree of Doctor of Philosophy (PhD) at the Faculty of Medicine at Lund University to be publicly defended on 24<sup>th</sup> of March 2023 at 13.00 in Belfrage Hall, Biomedical Centre, Klinikgatan 32, 222 42 Lund

*Faculty opponent*

Prof. Dr. Matthis Synofzik



**Organization:** LUND UNIVERSITY

**Document name:**

**Doctoral Dissertation**

**Date of issue 2023-03-24**

**Author(s):**

Sorina Gorcenco

**Sponsoring organization:**

**Title and subtitle: Clinical and genetic studies of patients and families with ataxia**

**Abstract:**

The idea for this project was born due to the many patients at our outpatient clinic who had a clear pattern of hereditary ataxia but lacked a genetic diagnosis. Thus, the study aimed to systematically compile clinical and genetic data from as many patients with the diagnosis of hereditary ataxia as possible and to describe in detail the phenotype and genotype of the patients and families diagnosed within our study. Additionally, we investigated ataxia patients' quality of life, what improves their well-being, and how satisfied they are with the provided disease-related information.

We identified patients with hereditary cerebellar ataxia through the diagnosis register at Skåne University Hospital. They were contacted by mail and asked to complete a survey designed by us. We booked research visits with a trained doctor and a research nurse and examined all patients according to a standardized checklist; the nurse collected blood samples for further analyses with Next Generation Sequencing methods for patients who did not yet have a genetic diagnosis. We used the American College of Medical Genetics diagnostic criteria to interpret the results. We performed bioinformatical and renewed clinical analyses for patients with variants of uncertain significance.

Our study showed that genetic forms of ataxia were highly variable within our group of patients. In total, we included 87 patients from 76 families with 18 types of confirmed genetic diagnoses. We identified the exact genetic cause of the disease in 11 additional families by our methods.

With the advancement of genetic testing technology, the rate of finding genetic variants for complex neurogenetic diseases is continuously increasing. However, detailed neurological phenotyping by clinicians and close collaboration with medical geneticists are necessary to avoid false positive results and improve the diagnostic yield.

**Key words: hereditary ataxia; Next Generation Sequencing; diagnostic yield; quality of life**

Classification system and/or index terms (if any)

Supplementary bibliographical information

**Language**

English & Swedish

**ISSN and key title:** 1652-8220

**ISBN:** 978-91-8021-382-0

Recipient's notes

**Number of pages:**

Price

Security classification

I, the undersigned, being the copyright owner of the abstract of the above-mentioned dissertation, hereby grant to all reference sources permission to publish and disseminate the abstract of the above-mentioned dissertation.

Signature



Date 2023-02-09

# Clinical and genetic studies of patients and families with ataxia

Sorina Gorcenco



**LUND**  
UNIVERSITY

Coverphoto by Dana Simmons

Copyright pp 1-60 Sorina Gorcenco

Paper 1 © The Authors (Manuscript unpublished)

Paper 2 © Springer Nature

Paper 3 © American Association for the Advancement of Science

Paper 4 © Wolters Kluwer Health, Inc

Faculty of Medicine

Department of Clinical Sciences Lund

Lund University

Lund

Sweden

ISBN 978-91-8021-382-0

ISSN 1652-8220

Lund University, Faculty of Medicine Doctoral Dissertation Series 2023:43

Printed in Sweden by Media-Tryck, Lund University

Lund 2023



Media-Tryck is a Nordic Swan Ecolabel certified provider of printed material. Read more about our environmental work at [www.mediatryck.lu.se](http://www.mediatryck.lu.se)

**MADE IN SWEDEN** 

*“The brain is the last and grandest biological frontier, the most complex thing we have yet discovered in our universe...The brain boggles the mind” James D. Watson*



# Table of Contents

Abstract .....	8
Populärvetenskaplig sammanfattning.....	9
List of Papers.....	11
Author's contribution to the papers.....	12
Abbreviations .....	13
<b>Introduction .....</b>	<b>15</b>
Aetiology.....	15
Epidemiology .....	15
Classification.....	16
Symptoms and signs of ataxia.....	18
Neuroanatomy of ataxia .....	19
Clinical and genetic diagnosis.....	20
Treatment .....	21
Future perspective .....	22
<b>Aims .....</b>	<b>23</b>
<b>Methods and Results .....</b>	<b>25</b>
Ethical considerations .....	26
Paper I: Clinical and genetic studies of a Swedish patient series diagnosed with ataxia .....	26
Paper II: Patient's perspective in hereditary ataxia .....	31
Paper III: Toward allele-specific targeting therapy and pharmacodynamic marker for spinocerebellar ataxia type 3 .....	36
Paper IV: Ataxia-Pancytopenia syndrome with <i>SAMD9L</i> mutations.....	41
<b>Discussion .....</b>	<b>45</b>
<b>Conclusions .....</b>	<b>51</b>
<b>Acknowledgments.....</b>	<b>53</b>
<b>Funding.....</b>	<b>55</b>

**References .....57**

## Abstract

The idea for this project was born due to the many patients at our outpatient clinic who had a clear pattern of hereditary ataxia but lacked a genetic diagnosis. Thus, the study aimed to systematically compile clinical and genetic data from as many patients with the diagnosis of hereditary ataxia as possible and to describe in detail the phenotype and genotype of the patients and families diagnosed within our study. Additionally, we investigated ataxia patients' quality of life, what improves their well-being, and how satisfied they are with the provided disease-related information.

We identified patients with hereditary cerebellar ataxia through the diagnosis register at Skåne University Hospital. They were contacted by mail and asked to complete a survey designed by us. We booked research visits with a trained doctor and a research nurse and examined all patients according to a standardized checklist; the nurse collected blood samples for further analyses with Next Generation Sequencing methods for patients who did not yet have a genetic diagnosis. We used the American College of Medical Genetics diagnostic criteria to interpret the results. We performed bioinformatical and renewed clinical analyses for patients with variants of uncertain significance.

Our study showed that genetic forms of ataxia were highly variable within our group of patients. In total, we included 87 patients from 76 families with 18 types of confirmed genetic diagnoses. We identified the exact genetic cause of the disease in 11 additional families by our methods.

With the advancement of genetic testing technology, the rate of finding genetic variants for complex neurogenetic diseases is continuously increasing. However, detailed neurological phenotyping by clinicians and close collaboration with medical geneticists are necessary to avoid false positive results and improve the diagnostic yield.

# Populärvetenskaplig sammanfattning

Cerebellär ataxi är ett samlingsbegrepp för många olika sjukdomar som påverkar lillhjärnan eller dess förbindelser och som yttrar sig med balansstörning och nedsatt koordination i samband med rörelse; även sluddrigt tal och ofrivilliga ögonrörelser är typiska. Ataxisjukdomar kan vara förvärvade eller ärftliga. Förvärvad cerebellär ataxi uppstår på grund av en skada i lillhjärnan, eller i nervbanor till eller från lillhjärnan, som till exempel en blodpropp som orsakar stroke, en inflammation eller en tumör. Ärftliga cerebellära ataxisjukdomar uppstår vid förändringar i arvsmassans kodning som antingen ärvs från föräldrarna på olika sätt eller kan uppstå på nytt hos en person. En tidigare studie uppskattade att cirka 6 av 100 000 personer i Sverige har diagnosen ärftlig cerebellär ataxi, därför räknas sjukdomen som sällsynt. [1].

Under tiden har möjligheterna till den genetiska diagnostiken utvecklats enormt. Syftet med vårt forskningsprojekt var att samla en stor grupp av personer med diagnosen ärftlig ataxi från södra Sverige, att noggrant undersöka deras arvs massa genom olika avancerade moderna metoder och att försöka hitta orsaken hos de som inte hade fått någon diagnos än.

För andra arbetet i avhandlingen var syftet att titta närmare på patienternas livskvalitet jämfört med allmänsvensk befolkning, vilka svårigheter dagligen upplevs av patienterna, vad patienterna finner ökar deras välmående, och hur välinformerade de känner sig om sin sjukdom. För tredje arbetet var syftet att samla sjukdomsinformation, blodprover och ryggvätska hos patienter med diagnosen spinocerebellär ataxi typ 3 (SCA3) för ett internationellt forskningssamarbete. Inom denna multicenterstudie har forskarna tagit fram en metod att undersöka det muterade proteinet polyQ ATXN3 i kroppsvätskor från patienter med SCA3. I det fjärde arbetet beskriver jag i detalj olika fynd från neurologisk, röntgen- och ögonundersökning hos patienter med en sjukdom som heter ataxi-pancytopeni syndrom (ATXPC - pancytopeni betyder brist på blodceller) i en svensk och en finsk familj. Förändringen i arvs massan som leder till denna sjukdom upptäcktes först år 2016 [2].

Inom vårt projekt har vi kunnat konstatera sjukdomsorsak hos ytterligare femton patienter från elva familjer utöver dem tjugonio som redan hade fått information om deras sjukdomsorsak innan de deltog i studien. Hos två familjer var fynden i arvs massan oklara och vi behövde gå igenom deras genetiska och kliniska undersökningsresultat en gång till, hitta specifika sjukdomsegenskaper och det som fanns tidigare beskrivet i litteraturen samt diskutera med specialister inom området för att komma fram till rätt diagnos. Hos åtta patienter är vi fortfarande osäkra kring det vi har hittat och undersökningar pågår. Slutligen var det 44 patienter (från 30 familjer) av totalt 87 (från 76 familjer) som medverkade i studien som hade fått reda på deras sjukdomsorsak.

Vanligaste diagnoserna i vår patientserie var SCA3 – 7 familjer, spinocerebellär ataxi typ 2 (SCA2) – 3 familjer och cerebellär ataxi med neuropati och vestibulär arreflexi syndrom (CANVAS) – 3 familjer, ataxia telangiectasia (AT) – 2 familjer, ATXPC – 2 familjer, övriga diagnoser har hittats hos enstaka familjer (diagram, sida 22). Detta överensstämmer överlag väl med tidigare forskningsrapporter hos patienter med ärftlig ataxi i Europeisk befolkning [3], trots att det finns markanta skillnader mellan länder och regioner [4].

Vi har kunnat konstatera att patienter med ataxi i Sverige har tydligt nedsatt livskvalitet jämfört med allmänbefolkningen. Deras största svårighet i vardagen var nedsatt balans och gångsvårigheter samt dålig koordination. Patienterna upplevde ökad välmående av att röra på sig och spendera tid med familj och vänner. Patienterna tyckte att den bästa och mest pålitliga sjukdomsinformationen de fick var av deras läkare. De som hade en genetiskt bekräftad sjukdomsorsak var yngre och kände sig mer välinformerade jämfört med patienter som inte visste vad orsaken till deras sjukdom var. Att de var yngre kan förklaras av att läkare är mer frikostiga med att undersöka arvsmassan hos yngre patienter, det finns fortfarande många patienter som får första sjukdomstecken senare i livet och där det har varit svårt hittills att ställa rätt diagnos.

Proteinet som heter polyQ ATXN3 och neurofilament light chain (NFL) kan mätas i kroppsvätskor från patienter med SCA3 och kan skilja dem från patienter med andra typer av ärftlig ataxi, andra neurologiska sjukdomar eller friska individer. Man kunde se skillnad även mellan de som hade utvecklat sjukdomen och de som hade förändringen i arvsmassan men inte hunnit utveckla några sjukdomstecken. Dessa fynd kan stå till grund för framtida forskning kring behandling av patienter med SCA3, då man kommer kunna mäta proteinmängden innan och efter behandlingen för att se om behandlingen har någon effekt och proteinmängden faktiskt minskar.

Vi tycker att det är ytterst viktigt och intressant för en patient med ärftlig ataxi att veta exakt vad sjukdomsorsaken är. Trots att för det mesta finns inget botemedel för dessa sjukdomar så är faktiskt ett fåtal ataxisjukdomar behandlingsbara. Att veta exakt orsak kan också hjälpa att förebygga komplikationer som kan förekomma. Patienterna känner sig mer informerade och kan få hjälp med familjeplanering. Neurologispecialisternas expertis är viktig när det kommer till att bekräfta eller avskriva en ataxidiagnos och förse patienterna med nödvändig sjukdomsinformation.

# List of Papers

## *Paper I*

**Gorcenco S**, Kafantari E, Wallenius J, Karremo C, Alinder E, Dobloug S, Landqvist Waldö M, Englund E, Ehrencrona H, Karrman K, Wictorin K, Puschmann A. **Clinical and genetic analyses of a Swedish patient series diagnosed with ataxia.** 2023 (Manuscript).

## *Paper II*

**Gorcenco S**, Karremo C, Puschmann A. **Patients' Perspective in Hereditary Ataxia.** Cerebellum. 2022 Dec 16. Epub ahead of print. doi: 10.1007/s12311-022-01505-1. PMID: 36525215.

## *Paper III*

Prudencio M, Garcia-Moreno H, Jansen-West KR, Al-Shaikh RH, Gendron TF, Heckman MG, Spiegel MR, Carlomagno Y, Daugherty LM, Song Y, Dunmore JA, Byron N, Oskarsson B, Nicholson KA, Staff NP, **Gorcenco S**, Puschmann A, Lemos J, Januário C, LeDoux MS, Friedman JH, Polke J, Labrum R, Shakkottai V, McLoughlin HS, Paulson HL, Konno T, Onodera O, Ikeuchi T, Tada M, Kakita A, Fryer JD, Karremo C, Gomes I, Caviness JN, Pittelkow MR, Aasly J, Pfeiffer RF, Veerappan V, Eggenberger ER, Freeman WD, Huang JF, Uitti RJ, Wierenga KJ, Marin Collazo IV, Tipton PW, van Gerpen JA, van Blitterswijk M, Bu G, Wszolek ZK, Giunti P, Petrucelli L. **Toward allele-specific targeting therapy and pharmacodynamic marker for spinocerebellar ataxia type 3.** Sci Transl Med. 2020 Oct 21;12(566):eabb7086. doi: 10.1126/scitranslmed.abb7086. PMID: 33087504; PMCID: PMC7927160.

## *Paper IV*

**Gorcenco S**, Komulainen-Ebrahim J, Nordborg K, Suo-Palosaari M, Andréasson S, Krüger J, Nilsson C, Kjellström U, Rahikkala E, Turkiewicz D, Karlberg M, Nilsson L, Cammenga J, Tedgård U, Davidsson J, Uusimaa J, Puschmann A. **Ataxia-pancytopenia syndrome with SAMD9L mutations.** Neurol Genet. 2017 Aug 24;3(5):e183. doi: 10.1212/NXG.000000000000183. PMID: 28852709; PMCID: PMC5570676.

## Author's contribution to the papers

### *Paper I*

Study conception and design, ethical application, acquisition and documentation of clinical data, analysis, and interpretation of data, drafting and revision of the manuscript.

### *Paper II*

Study conception and design including design of questionnaire, study organization, material preparation, collection, analysis, and interpretation of data, drafting and revision of the manuscript as corresponding author.

### *Paper III*

Study conception and design, collection of data from our centre, revision of the manuscript.

### *Paper IV*

Study conception and design, acquisition and documentation of clinical data, analysis, and interpretation of data, drafting and revision of the manuscript.



## Abbreviations

ACMG	American College of Medical Genetics
ADCA	Autosomal dominant cerebellar ataxia
ADCADN	Autosomal dominant cerebellar ataxia, deafness, and narcolepsy
ADL	Activities of daily living
AOA	Ataxia oculomotor apraxia
ARCA	Autosomal recessive cerebellar ataxia
AT	Ataxia telangiectasia
ATXPC	Ataxia-pancytopenia syndrome
BVVLS2	Brown-Vialetto-Van Laere Syndrome
CANVAS	Cerebellar ataxia, neuropathy and vestibular areflexia syndrome
CSF	Cerebrospinal fluid
EA	Episodic ataxia
FRDA	Friedreich's ataxia
HCA	Hereditary cerebellar ataxia
NFL	Neurofilament light chain
NGS	Next generation sequencing
SARA	Scale for the assessment and rating of ataxia
SCA	Spinocerebellar ataxia
SCAR	Spinocerebellar ataxia, recessive
SPG	Spastic paraplegia
WES	Whole exome sequencing
WGS	Whole genome sequencing



# Introduction

The term ataxia, borrowed from Ancient Greek, means “lack of order” and is a clinical finding of impaired coordination. It is usually a sign of cerebellar dysfunction or impaired vestibular or proprioceptive afferent connections to the cerebellum. It can be a patient’s main complaint or one of many other signs and symptoms. The unique combination of clinical symptoms characteristic of a particular disease is often helpful in diagnosing. The challenge in clinical practice is to be up to date on all the possible disorders that should be considered and build a suitable diagnostic strategy.

## Aetiology

Disorders with ataxia are usually divided into hereditary cerebellar ataxias (HCA), which are caused by genetic variants; acquired ataxias, which can be caused by different factors including infection, injury, stroke, or neurological conditions such as multiple sclerosis, and idiopathic ataxias with unknown aetiology. The causes of ataxia are extensive; however, most forms of ataxia have a genetic cause, and thus the focus of this thesis will be on hereditary cerebellar ataxias. This form of ataxia is characterized by an insidious onset with symmetrical symptoms, a chronically progressive character (months to years), and can be inherited in an autosomal dominant (AD), autosomal recessive (AR), mitochondrial or X-linked pattern [3, 5].

## Epidemiology

The global epidemiology of HCA is very uncertain. Data is limited to a few studies of isolated geographical regions and probably does not mirror the actual distribution of the disease. As HCA is a group of highly heterogeneous diseases, the prevalence of specific subtypes varies between ethnic and continental populations. The prevalence of autosomal dominant ataxia was estimated to be up to 5.6/100000, and that of autosomal recessive ataxia up to 7.2/100000, according to the most recent systematic review [3]. Spinocerebellar ataxia type 3 (SCA3)/Machado-Joseph

disease was found as the most common type of autosomal dominant ataxia in most prevalence studies, except for Italy [6] and Wales [7], with the highest prevalence in Brazil [8]. SCA2 was the most common subtype in Spain [9] and the second most common in Italy [6], Norway [10], and Singapore [11]. SCA6 was the second most common in the Netherlands [12] and Japan [13]. Friedreich ataxia (FRDA) was the most frequent form of autosomal recessive ataxia, with an exception for southeast Norway [10] where ataxia-telangiectasia (AT) reached a higher prevalence. Ataxia with oculomotor apraxia (AOA) was the second most common in Portugal [14] and France [15]. Founder effects in some of the world's populations such as Cuba (SCA2), or Portugal and Brazil (SCA3), are considered responsible for these regional variations [16].

## Classification

The clinical use of the term ataxia goes back to the mid of the 19th century when Duchenne used the expression “locomotor ataxia” for tabes dorsalis. Until now, there have been different strategies to classify cerebellar ataxias. The first approach was to make a detailed clinical description, hoping that classification could be based on the clinical differences between patients. Nevertheless, as more information became available about patients and their families, their clinical classification became more complicated.

The second approach was neuropathological, based on structural differences in the brains of deceased patients. Cerebellar ataxias were then classified as olivopontocerebellar atrophy, cerebellar cortical atrophy, or spinocerebellar degeneration.

The British neurologist Anita Harding suggested the third approach to genetic ordering of ataxias in the early eighties of the 20th century (1952-1995). She noticed the discrepancies in the neuropathological classifications when members of a family with a hereditary disease were included in at least two neuropathological categories. In contrast, clinically and genetically distinct diseases were put in the same category. Therefore, Harding proposed a new classification and emphasized the potential value of a genetic classification system (Figure 1) [17, 18]. She classified the different forms of ataxia based on the mode of inheritance. She sorted out the Autosomal Dominant Cerebellar Ataxias (ADCAs) as a separate group. Her observations and suggestions significantly impacted the advancements of the ataxia classification system. They led to the subsequent identification of genes and causative variants.

Moreover, the progress of genetic techniques in the last decades has increased the possibilities for precise diagnosis and improved classification based on genetic testing. Recently a new system for naming genetically determined movement

disorders was proposed by the Movement Disorder Society Task Force for the Nomenclature of Genetic Movement Disorders. This system is applied only for disorders where the causative gene is known. A level of evidence for a genotype-phenotype association must be achieved. The genes are assigned the prefix of the movement disorder if the phenotype (e.g., ataxia for ATX) is a predominant feature associated with the pathogenic variant in that gene in most cases. An example is *ATX-RFC1*, designated for cerebellar ataxia, neuropathy, and vestibular areflexia syndrome (CANVAS), or *ATX-SAMD9L* for ataxia-pancytopenia syndrome (ATXPC) [19].

Both past and present classification systems played a significant role in a better understanding of the HCA and beautifully demonstrated the heterogeneity of the disease. However, the new classification system is more accurate than previous systems, avoids misunderstanding around the diagnosis, and is easier to use in clinical practice. The challenge for the clinician and the medical geneticist remains to identify the causative variant correctly and effectively in a patient and to understand the underlying molecular pathophysiology as a foundation for the future development of appropriate treatments.

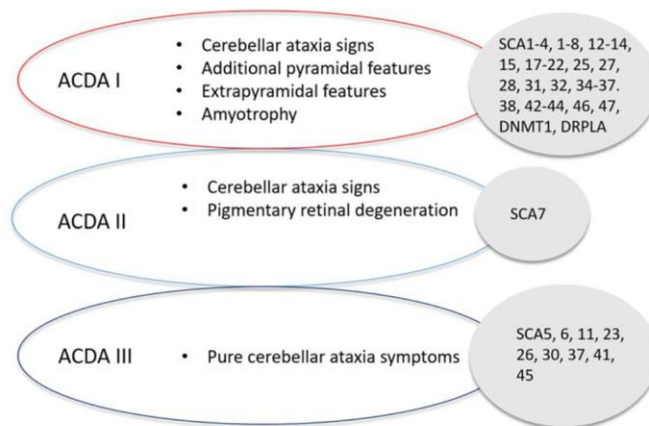

**Figure 1 Harding's classification system of Spinocerebellar Ataxia**

The classification of SCA based on symptom presentation and the associated SCAs with that classification (picture from Sullivan et al 2019 [20] under creative commons license 4.0)

## Symptoms and signs of ataxia

The following clinical terms are often used to describe ataxia.

**Impaired stance**, the ability to stand with feet together, on one foot, or walk in a straight line is reduced.

**Gait ataxia** results from poor coordination of the lower limbs because of cerebellar dysfunction or diminished proprioception. Patients frequently feel insecure and must use support and walk with their feet apart. When visual cues are removed, an accentuated gait impairment is suggestive of vestibular or sensory ataxia. In cerebellar ataxia, the gait is not influenced by visual cues.

**Sensory ataxia** is characterized by gait disturbance. Furthermore, individuals with sensory ataxia will have a positive Romberg sign. They will walk with a high-stepping gait associated with motor weakness or a feet-slapping gait for sensory feedback. Pseudo athetosis can occur in sensory neuronopathy affecting the upper limbs.

**Truncal ataxia** can result from midline cerebellar dysfunction. Patients can present with truncal instability in the form of swaying the body while sitting or standing.

**Limb ataxia** is often used to describe ataxia of the upper limbs resulting from incoordination, tremor, impaired muscle tone, and decomposition of movement, giving the patient a clumsy appearance. Simple activities such as writing, eating, picking up small objects, or buttoning clothes may become challenging. To increase the movement precision, the patient must slow down the movement.

**Dysdiadochokinesia** is tested by rapidly alternating hand movements. Impairment can be seen with the inconsistency of the rhythm and amplitude.

**Intention tremor** manifests by increasing amplitude of oscillation at the end of a voluntary movement because of instability of the proximal part of the limb. It is often tested by finger-to-nose or heel-to-shin tests. On the other hand, essential tremor occurs in the distal portion of the limb.

**Dysmetria** is when the patient misses the target either because of hypermetria or hypometria. It is tested by finger-chasing and shin-tap test and can be quantified by the missed distance (cm). Dysmetria is also seen in eye movements, such as hypometric or hypermetric saccades.

**Dysarthria** is usually described by the patient or relatives as slurred speech. Words are often broken into separate syllables, and the speech is scanned with a nasal character.

**Nystagmus** is a characteristic sign of cerebellar dysfunction. It can present as lateral gaze-evoked nystagmus, upbeat and downbeat nystagmus. Upbeat is seen in lesions

of the anterior vermis. Downbeat nystagmus is usually seen in lesions in the foramen magnum area.

**Saccades** often have an average speed in cerebellar disorders. However, there is typically an overshoot or undershoot (ocular dysmetria) followed by a corrective eye movement in the relevant direction.

**Square-wave jerks/ocular flutter/opsoclonus** are terms that describe other ocular disruptions in cerebellar disease. Square-wave jerks are present as two saccades in opposite directions, separated by a short pause. Large amplitude square-wave jerks are characteristic of cerebellar ataxia. Ocular flutters are repeated saccades without any pauses. Opsoclonus is continuously mixed saccades in different directions in a chaotic manner. Ocular flutter and opsoclonus suggest paraneoplastic or postinfectious syndromes affecting the cerebellum.

Some forms of ataxia can be associated with cognitive impairment, impaired executive and visuospatial functions, agrammatism, and inappropriate behaviour. Muscle weakness, sensory loss, or dysautonomia can also appear in patients with ataxia. The severity of symptoms, age of onset, and the disease course can differ between individuals and the many different types of ataxias [21, 22].

## Neuroanatomy of ataxia

The cerebellum and its afferent and efferent connections, the vestibular system, and the proprioceptive sensory pathway are all associated with ataxia. Based on the location of the underlying dysfunction, ataxia may be categorized as cerebellar, vestibular, or sensory ataxia.

The cerebellum comprises the midline cerebellum or vermis and the cerebellar hemispheres. Lesions in each region can result in a different presentation of ataxia. For example, damage of the vermis causes truncal, and gait ataxia with limbs relatively spared, whereas lesions in the cerebellar hemisphere produce limb ataxia. Damage to the unilateral cerebellar hemisphere usually causes ipsilateral symptoms and signs. Diffuse cerebellar lesions are causing more generalized symmetric symptoms.

Vestibular ataxia spares speech but causes disequilibrium, vertigo, and gait ataxia. Sensory ataxia also spares speech, has no vertigo but worsens when eyes are closed, and is associated with decreased vibration and proprioception.

Understanding the neuroanatomy and its correlation to coordination can help with localization.



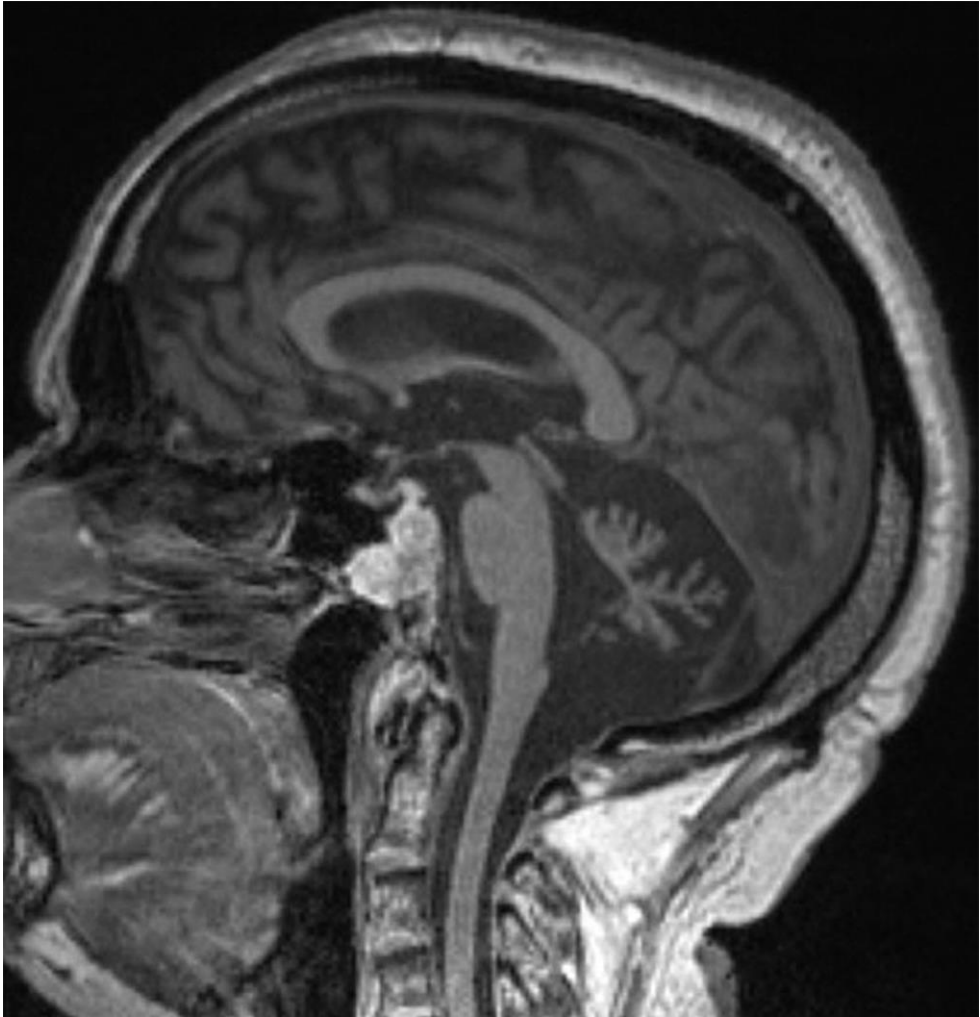

**Figure 2** Sagittal MRI of one of our patients with ataxia-pancytopenia syndrome showing atrophy of the cerebellum and the brainstem.

## Clinical and genetic diagnosis

Diagnosis of hereditary ataxia consists of a medical examination based on a detailed medical and family history, neurological examination, imaging studies, laboratory data, and genetic tests. Potentially treatable underlying causes may need to be ruled

out first, such as toxicity, vitamin deficiencies, and infectious, autoimmune, or paraneoplastic disorders [21, 23]. At our clinic, genetic testing has traditionally been performed in the following order: CAG repeats expansion panels, sequencing of individual ataxia genes based on the clinical phenotype, targeted gene panels, whole exome sequencing (WES), or whole genome sequencing (WGS). The most common autosomal dominant, autosomal recessive, and X-linked ataxias are repeat expansions which usually are not identified by WES. Thus, the first step was to exclude repeat expansion disorders.

New Generation Sequencing (NGS) includes WES and WGS. It has become a great diagnostic tool that facilitates the clinical workup for patients with complex neurogenetic conditions or where family history is suggestive of genetic disease. The difference between these two methods is that WES focuses on sequencing only the exome, which is the protein-coding region of the genome (1-2%), while WGS sequences almost the entire genome (3 billion base pairs). WES is cheaper and faster but has limited information compared to WGS. WES reads the exons, which contain data of coding regions of the DNA; WGS analyses both the exons and the introns, which means both coding and non-coding regions in the DNA. NGS has significantly increased the possibility of finding a genetic diagnosis for monogenic disorders. Test strategies have evolved. By the end of this study, WGS, with various subsequent bioinformatic analyses as detailed in our first paper, has become the standard for genetic examination within the health services in Sweden. Nevertheless, the diagnostic yield for hereditary ataxias was reported to be only 12-52%, as documented in our review from 2020 [24]. The high genetic complexity and phenotypic variability of overlapping disease phenotypes make it sometimes difficult to interpret the genetic test results.

Our outpatient clinic in Lund has around 100 patients diagnosed with hereditary ataxia. In the Scania region, 191 individuals were diagnosed with hereditary ataxia in their contacts with neurology services over five years, 2012-2016, according to a previously published study [1]. Many of these patients had yet to receive a genetic diagnosis which was an incentive to do this work.

## Treatment

There is no cure for most forms of hereditary ataxia yet, but symptom management and rehabilitation can improve quality of life. Management of ataxia consists of medication, physical, occupational, and speech therapies, and monitoring for known complications. There is some evidence that physical therapy and whole-body controlled video games can improve balance and mobility in hereditary and degenerative cerebellar ataxias [25, 26]. Patients should also be encouraged to

perform home exercises or engage in any preferred physical activity as tolerated since it can improve their balance, gait, and well-being [27, 28].

Pharmacologic treatment includes both symptomatic and possibly disease-modifying therapies. The evidence is usually based on clinical trials with a small number of patients. A few autosomal recessive ataxias have targeted therapies such as chenodeoxycholic or cholic acid for cerebrotendinous xanthomatosis [29], miglustat for Niemann-Pick type C and vitamin E for abetalipoproteinemia. The ketogenic diet for GLUT-1 deficiency [21]. Among symptomatic treatments, riluzole has been shown to improve gait and speech in different types of cerebellar ataxias [30, 31]. There is some evidence that valproic acid [32] and varenicline [33] may improve symptoms in SCA3 patients. Coenzyme Q10 supplementation has been associated with a better clinical outcome for some forms of spinocerebellar ataxias [34], but no randomized clinical trials are yet to support the evidence. Carbamazepine reduces attacks in episodic ataxia type 1 (EA1), and similarly, acetazolamide and 4-aminopyridine can reduce attacks in EA2 [35]. As both SCA6 and EA2 are caused by variants in *CACN1A* gene, acetazolamide may improve the episodic symptoms in SCA6 [36]. Parkinsonism present in SCA2, SCA3, SCA8 and SCA17 may respond to levodopa, but compared to patients with Parkinson's disease the effect is less prominent and temporary. Benzodiazepines may help attenuate vertigo [21]. Symptomatic treatment with 4-aminopyridine may improve nystagmus [37]. For depression and anxiety, cognitive behavioural therapy and pharmacological treatment should be offered when necessary. According to some recent studies, deep brain and transcranial magnetic stimulation may help alleviate cerebellar ataxia symptoms [38-40]. Nevertheless, discussing the therapeutic options individually with each patient is essential since the side effects, the safety, and the high price may outweigh the benefit in some cases.

## Future perspective

With Next Generation Sequencing (NGS) methods constantly evolving, the possibility of finding the genetic cause and the underlying pathophysiology for patients with HCA will probably increase. Especially, disorders caused by variants outside of exons are expected still to be discovered, and/or caused by types of variants that have been more difficult to detect. Some of these may be relatively common causes of ataxia. Recent additions include intronic repeat expansions in *RFC1* or *FGF14* [41, 42]. These findings will further lay the foundation for developing gene therapies to treat HCA. There is ongoing research for gene therapy and antisense oligonucleotide targeting some specific forms of genetic ataxias [43, 44], which amplifies the need for reliable disease-specific markers to help measure the treatment outcome in clinical trials. Disease-specific markers in SCA3 are discussed in Paper III of the thesis.

# Aims

The overarching aims of this project were to systematically include up to 100 patients with chronically progressive ataxia from the Scania region in Sweden for clinical and genetic investigations and to summarize the occurrence of monogenetic forms of ataxia in our case series, to implement detailed genetic testing (known trinucleotide expansion repeats and WES or WGS) for patients who did not have an established genetic diagnosis yet, to create a database with clinical and genetic data from clinical and research analyses, a blood sample collection and for some patient's cell-lines and to identify the genetic cause in some families with unusual or unique features of ataxia.

In *Paper I*, the aims were to clinically and genetically examine a patient series with ataxia with known or unknown genetic cause from southern Sweden, describe the findings, investigate the molecular aetiology in previously undiagnosed cases, and thus determine how reliable the current genetic testing methods are in the diagnosing process.

In *Paper II*, the aims were to analyse how the quality of life of patients with ataxia is impacted by the disease, where patients search for and where they experience that they find the most trustworthy information about their disease, what the most significant difficulties encountered in everyday life are and if there is anything that improves their wellbeing.

In *Paper III*, the aims were to investigate polyQ ATXN3 as a pharmacodynamic marker using CSF and plasma from ATXN3 CAG repeats expansion carriers and noncarriers to perform validations on an independent cohort of plasma samples from ATXN3 CAG repeats expansion carriers and controls, to evaluate whether polyQ ATXN3 proteins associate with clinical features of SCA3, to determine the value of NFL as a marker for SCA3, to validate reported associations between ATXN3 CAG repeat length and clinical features in the study cohort, to determine the association of a particular single nucleotide polymorphism with ATXN3 CAG-expanded allele, and to assess whether polyQ ATXN3 may serve to determine patients' varying responses to ATXN3-targeted therapies using human fibroblasts.

In *Paper IV*, the aim was to describe in detail the neurological, neuroradiological and neuroophthalmological phenotypes of one Swedish and one Finnish family with autosomal dominant ataxia-pancytopenia (ATXPC) syndrome.



# Methods and Results

The study designs used for the papers in this thesis can be classified as descriptive case series and case reports for *papers I and IV*, and observational cross-sectional studies for *papers II and III*.

*Paper I* presents retrospective data from a case series of patients with hereditary ataxia, with or without a genetic diagnosis, who were recruited through the diagnosis register of the department of neurology at Skåne University Hospital, through family members, referrals from other neurologists or through contact with SCA-Network, a Swedish patient organization.

*Paper II* presents the patient-reported outcome from a survey I designed, with 32 multiple-choice or open-ended questions, applied to the ataxia patients in our study. For this study, we used the EQ-5D-3L instrument to measure the quality of life in five domains: mobility, self-care, usual daily activities, pain/discomfort, and anxiety/depression. The results obtained from the patients with ataxia were compared to the EQ-5D-3L results from a randomly selected group from the general Swedish population [45].

**Table 1. A summary of the study designs of all papers in the thesis**

Paper	Study Design	Recruitment	N
I: Clinical & genetic studies	Descriptive, case series	Outpatient clinic, SCA-Network	87
II: Patient's perspective	Observational, cross-sectional	Outpatient clinic, SCA-Network	75
III: Pharmacodynamic marker for SCA3	Observational, cross-sectional	SCA-Network	189*
IV: Ataxia-Pancytopenia Syndrome	Descriptive, case report	Outpatient clinic	27

SCA3, spinocerebellar ataxia type 3; N, number of study participants

\*12 patients with SCA3 from Lund

In *paper III*, an observational cross-sectional study, we recruited patients with SCA3 for a multicentre study. The patients were recruited through SCA-Network, a Swedish patient organization. We collected clinical data and blood and cerebrospinal fluid samples from the participants following standardized study protocols. Measurements of polyQ ATXN3 proteins in CSF and plasma for this

study were performed by individuals blinded to the genotype and disease status (symptomatic versus asymptomatic) of the samples.

In *paper IV*, a case (family)-report study, I presented in detail the neurological, neuroradiological, and neuroophthalmological phenotypes of one Swedish and one Finnish family with autosomal dominant ataxia-pancytopenia syndrome (ATXPC).

The statistical analyses of *paper III* were performed at Mayo Clinic in Florida, USA. *Paper I-II's* statistical analyses were performed with collaborators' and co-authors' support. IBM SPSS Statistics version 25.0, R statistical software version 3.6.1, and GraphPad Prism were used for statistical tests. The statistical significance *P*-value for a specific test is presented in the table's footnote, showing the test results.

## Ethical considerations

The studies presented in this thesis were approved by the Regional Ethics Review Board, Lund, Sweden (ref. 2013/516). All patients signed a written and informed consent prior to the inclusion in the study. Biological samples were collected and analysed according to ethics committee approval and applicable laws and regulations. Genetic data from clinical studies was retrieved for our research with the patients' written consent as approved by the Swedish Ethical Review Authority (ref. 2021-00884).

## Paper I: Clinical and genetic studies of a Swedish patient series diagnosed with ataxia

*Are Next Generation Sequencing methods a good enough tool to find an exact diagnosis? What is the diagnostic yield in our study group? What is the frequency of different genetic diagnoses in our population?*

This retrospective study describes a case series of patients with ataxia from southern Sweden. Patients were recruited in various ways, mainly by searching for the ICD-10 diagnostic code for hereditary ataxia (G11.1-3, G11.7-9, <https://icd.who.int/browse10/2019/en>) in the diagnosis register of the department of neurology at Skåne University Hospital for the years 2011-2020. Several patients were recruited through family members or referrals from other neurologists. Also, we have contacted SCA-Network, a Swedish patient organization, to recruit patients with SCA3 diagnosis for participation in a multicentre study. A few patients with Friedreich ataxia from our clinic were already included in a previous study [46], to avoid overwhelming them with different research studies, they were not asked to participate again. All patients found to have a diagnosis of hereditary ataxia were



sent a letter with detailed study information. They were asked to send back a form stating whether they were interested/not interested in participating. A trained doctor examined all patients during a research visit at our clinic or during home visits. Each patient was interviewed according to a standardized familial and medical history checklist. Results from brain imaging, nerve conduction studies, analysis of cerebrospinal fluid, and genetic testing were retrieved from clinical records. Every patient was examined following a standardized protocol for examination of patients with ataxia, addressing the coordination of movement, gait, speech, and eye movement. We used the scale for the assessment and rating of ataxia (SARA) to evaluate the disease severity for each patient [47]. Family pedigrees were drawn based on information obtained from the patients and relatives. A research nurse collected blood samples from each patient after the clinical examination; the samples were then stored in the biobank for future genetic analyses.

Additionally, we collected CSF from patients with SCA3 who agreed to participate in the multicentre study [48, 49]. Several patients included in the study had already undergone genetic analyses for repeat expansions SCA1,2,3,6 and 7 or for specific genes based on their clinical phenotype within a clinical setting. A few had even been tested with gene panel analyses based on targeted sequencing or Whole Exome Sequencing (WES) since it became increasingly available for clinical use. Within our study, all patients without a confirmed diagnosis were tested using WES, whole genome sequencing (WGS) or by reanalysing the existing raw data from previous clinical WES analyses. The choice of the method was based on the mode of inheritance, clinical phenotype, and availability at the time of the study. Most WES or WGS analyses were conducted at the Centre for Translational Genomics at Lund University, as well as at Centogene, Rostock, Germany or BluePrint genetics, Helsinki, Finland. The obtained raw data from the research analyses was analysed by bioinformaticians for single nucleotide variants, copy number variants, repeat expansions, and short insertions and deletions, as outlined in greater detail in Paper I. Variant classification was performed based on the guidelines published by the American College of Medical Genetics and Genomics (ACMG) in 2015.[50] Sporadic variants in ataxia-related genes that were classified as pathogenic, likely pathogenic, or as variants of uncertain significance by the classifiers used (Varsome, Franklin by Genoox) or reported in ClinVar database, with a high likelihood of pathogenicity were discussed in rounds of conferences with clinicians, bioinformaticians and a medical geneticist. These results were then evaluated critically using post-NGS phenotyping. All new genetic findings were re-evaluated concerning the presenting clinical phenotype, genetic databases, and reported cases in the literature. The following criteria made us consider a variant compatible with the patient's/family's phenotype:

- (I) family history is consistent with the mode of inheritance of the disorder.
- (II) the patient and the affected family members had a well-defined syndrome; we were looking for a specific signature of neurological and non-

neurological disease phenotypes and compared between the patient and previous publications about the disorder, and, in the case of families, between affected individuals of a family.

- (III) careful re-appreciation of the genetic results and database findings (variant frequency in the population, prediction tools, genotype, quality of sequencing, the validity of bioinformatics methods).

### *Results*

For the ataxia project a total of 158 patients were identified with the diagnosis of hereditary ataxia and were contacted [27]. A relatively significant part of them was not included because they were not alive at the time of the study, not interested in participation, or because of scheduling difficulties. We managed to include 87 patients from 76 families diagnosed with hereditary ataxia. Initially, we examined 91 patients, but four of them were excluded because of alternative diagnoses that were found during clinical examination and re-evaluation of clinical records: one with multiple system atrophy (MSA), one with a para malignant syndrome, one with an adult form of spinal muscular atrophy, and one with functional dystonia. Before inclusion, 27 patients from 19 different families had a genetic diagnosis, and 2 of their relatives were pre-symptomatic carriers. Additionally, 15 patients from 11 families received a genetic diagnosis within our study. For two families, the initial genetic results found a variant of uncertain significance according to ACMG criteria. After using methods such as post-NGS clinical phenotyping and assessment of familial co-segregation of the variants with the disease phenotype, we became confident that these variants were disease-causing in these families.

As a result of this study, we were able to find nine different genetic diagnoses: Ataxia-Pancytopenia syndrome in two families, Spinocerebellar ataxia 34 in one family, Brown-Vialetto-Van-Laere syndrome in one proband, Spinocerebellar ataxia 48 in one proband, Autosomal recessive spinocerebellar ataxia 16 in one proband, Spastic paraplegia 4 in one proband, Spastic paraplegia 76 in one proband, Cerebellar ataxia neuropathy and vestibular areflexia in two probands, Huntington's disease in one proband (Figure 1).

For eight patients we had important genetic findings but were not able to set a clear diagnosis for different reasons (Figure 1). In several families, further examination of the proband's relatives is ongoing and may result in a diagnosis. In one patient (P1086, Figure 1), we found a confirmed, clearly pathogenic variant (*RFC1* repeat expansion) but we were unsure if it can entirely explain the patient's and the family's clinical phenotype.

Finally, there were 44 (50.6%) of 87 patients from 30 (39.5 %) of 76 families that had a confirmed genetic diagnosis (Figure 2). All our results are illustrated in the family pedigrees from Figure 1 and the diagram showing the distribution of the different diagnoses in our patient series in Figure 2.

**A: P1017\_P1018\_P1027**  
 SAMD9L c.2640C>A p.(His880Gln), het  
 Ataxia-pancytopenia syndrome

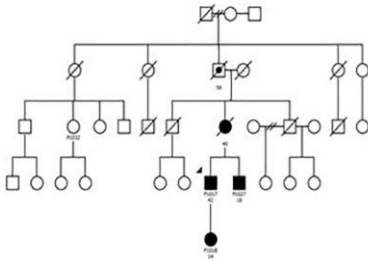

**B: P1073\_P1091\_P1093**  
 ELOVL4 c.511A>C p.(Ile171Leu), het  
 SCA34

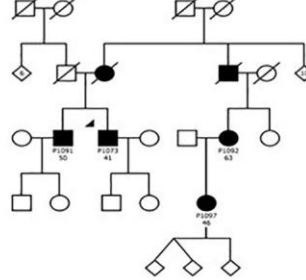

**C: P1040**  
 STUB1 c.107T>C p.(Leu36Pro), het  
 SCA48

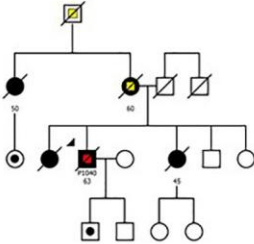

**D: P1002**  
 STUB1 c.761G>A p.(Arg254His), hom  
 SCAR16

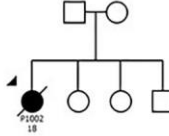

**F: P1048**  
 CAPN1 c.759+1G>A, hom  
 SPG76

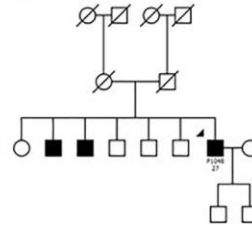

**E: P1058**  
 SPAST c.722del p.(His241ProfsTer13), het  
 SPG4

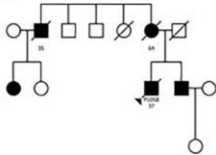

**G: P1070**  
 RFC1 repeat expansion, biallelic  
 CANVAS

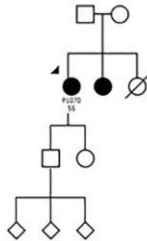

**H: P1095**  
 RFC1 repeat expansion, biallelic  
 CANVAS

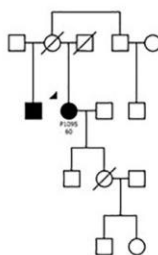

**I: P1089**  
 HTT 36 CAG repeats, monoallelic  
 HD with reduced penetrance

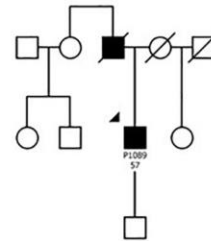

**J: P1066**  
 POLG/AFG3L2/SPG7 variants  
 SCA28? SPG7-AFG3L2 digenic interaction?

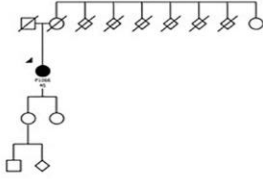

**K: P1054**  
 SPAST duplication of 9 exons, het  
 No diagnosis established

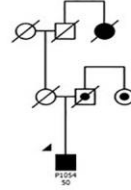

**L: P129**  
 IRF2BPL c.2356G>A p.(Gly786Arg), het  
 Possible Neurodevelopmental disorder with regression,  
 abnormal movements, loss of speech, and seizures

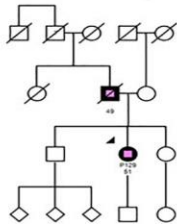

**M: P1051**  
 SPTBN2 c.73C>T p.(Arg25Cys), het  
 Possible SCA5

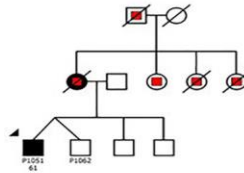

**N: P1050**  
 RFC1 repeat expansion, biallelic  
 No diagnosis established



**O: P1063**  
 NIPA1 deletion of exon 1, het  
 No diagnosis established

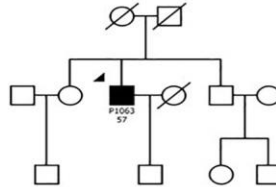

**P: P1008**  
 POLR3B c.1568T>A p.(Val523Glu), het  
 No diagnosis established

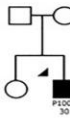

**Q: P1086**  
 RFC1 repeat expansion, biallelic  
 Probable CANVAS, but additional autosomal  
 dominant neurological phenotype remains  
 unexplained.

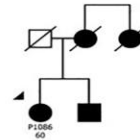

**Figure 1 Pedigrees of patients and families examined genetically within this study**

Round symbols indicate females, square symbols males. Diagonal line indicates that the individual is deceased. Patient identifiers and age at onset in years are provided below symbols. Solid black symbols indicate ataxia, black dots indicate possible ataxia (acc. to family history). Yellow color indicates possible dementia, red dementia.

CANVAS-cerebellar ataxia, neuropathy and vestibular areflexia; HD-Huntington's disease; het-heterozygosity; hom-homozygosity; SCA28-spinocerebellar ataxia 28; SCA34-spinocerebellar ataxia 34; SCA48-spinocerebellar ataxia 48; SCA5-spinocerebellar ataxia 5; SCAR16-autosomal recessive spinocerebellar ataxia 16; SPG4-spastic paraplegia 4; SPG7-spastic paraplegia 7; SPG76-spastic paraplegia 76

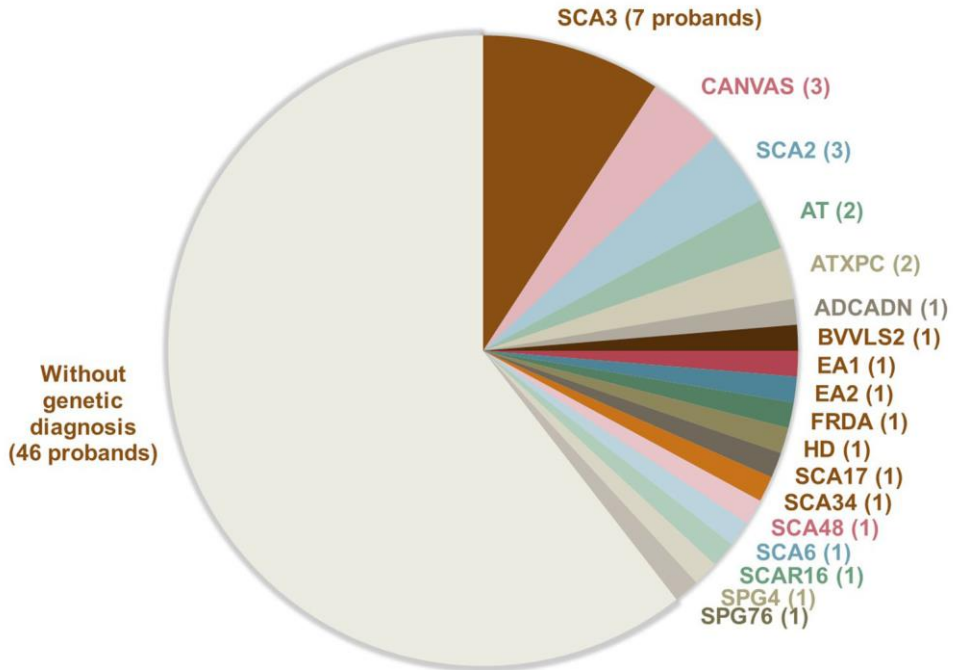

**Figure 2 Representation of the 18 different subtypes of ataxia from our patient population**

Established molecular ataxia diagnoses in study participants. Patients with SCA3 were recruited from a larger geographical area because they were included in multi-center studies on this disease. Nine additional patients with Friedreich ataxia from 7 families from our hospital's uptake area had previously been included in another study and were not contacted again.

ADCADN-Autosomal dominant cerebellar ataxia, deafness, and narcolepsy; AT-ataxia telangiectasia; ATXPC-ataxia-pancytopenia syndrome; BVVLS2-Brown-Vialetto-Van Laere syndrome-2; CANVAS-cerebellar ataxia, neuropathy and vestibular areflexia syndrome; EA-episodic ataxia; FRDA-Friedreich's ataxia; HD-Huntington's disease; SCA-spinocerebellar ataxia; SCAR-autosomal recessive spinocerebellar ataxia autosomal recessive 16; SPG-spastic paraplegia.

## Paper II: Patient's perspective in hereditary ataxia

*How is the quality of life of patients with ataxia compared to general population? Are patients feeling well-informed about their diagnosis? What is most difficult for patients in everyday life? What improves patients' well-being?*

This observational, cross-sectional study is based on survey reports from patients included in our ataxia study. The patients were recruited through the diagnosis register at our outpatient clinics in Lund and Malmö, through direct referrals from

other neurologists, family members, or SCA-Network, a Swedish patient organization. The author designed the survey with 32 multiple-choice or open-ended questions, including the EQ-5D-3L, a validated and standardized instrument for assessing the quality of life in five domains (mobility, self-care, daily life activities, pain, and anxiety). The remaining questions focused on patients' perspectives on their well-being, limitations in daily life activities, supportive care, disease-related medical information, and coping strategies. We decided to use EQ-5D-3L because it was previously used for patients with ataxia [51]. We wanted to compare the results from our patients with a randomly selected group of 534 Swedish citizens that underwent the testing through a self-applied postal survey [45]. The EQ-5D-3L questionnaire is validated and available for use in Swedish language <https://euroqol.org/eq-5d-instruments/eq-5d-3l-about/>. A letter was sent with detailed information about our study, and patients were asked to send back a filled form in which they stated if they were interested or not to be part of the study. Besides the study information, the letter also contained the survey. The patients were asked to fill the survey before the research visit. Questionnaire responses were collected and stored in SUNET survey, a digital tool from Lund University that made it possible to easily retrieve and analyse the data. During the clinical examination, all patients were interviewed using open questions and standardized checklists for medical and familial history. If available, their genetic records were retrieved. Blood samples were collected from each patient after the examination and stored in the biobank for further genetic testing.

### *Results*

From a total of 158 identified patients with a diagnosis of hereditary ataxia in the outpatient clinic and hospital register, study information letters were sent to 96 patients who were alive and living in the uptake area of our hospital and who had not received a different diagnosis. Additionally, 48 letters were sent to patients recruited through a patient organization, contact with families, or direct referrals. Five patients with Friedreich ataxia were not asked to participate because they were already recruited for another study at our department. Four patients were excluded because clinical examination within the study indicated another diagnosis. We invited 87 patients with ataxia, of whom 75 returned the self-administered questionnaire.

We divided patients into two groups, one group with a genetic diagnosis and the other with no genetic diagnosis. Statistical analyses showed that the group with a genetic diagnosis was significantly younger and had an earlier disease onset than the group of patients that did not have a diagnosis ( $P < 0.05$ ).

The most reported symptoms at disease onset were, as expected, "poor balance" (N=46; 61.3%) and "gait impairment" (N=12; 16%). Moreover, "dysarthria" (N=23; 30.7%), "poor coordination" (N=23; 30.7%), "poor fine motor skills" (N=22;

29.3%) and “impaired vision” (N=17; 22.7%) were the most reported symptoms at the time of the study.

Below is a visual illustration of the difficulties and restrictions that patients with ataxia experience daily.



**Figure1 Ataxia patients'perceived restrictions and difficultiesin everyday life.**

Word cloud image of ataxia patients' answers to the open question, “What is most difficult for you in your everyday life? What restrictions do you experience?” Forty-eight patients responded to these questions. Letter sizes corresponds with the number of patients who mentioned this topic, from 19 patients stating difficulties walking to 1 patient each for several topics shown in the smallest print. Image created with WordClouds.com

Several patients reported severe limitation or inability to perform physical activities such as walking long distances (N=18; 24%), cycling (N=11; 14.7%), and playing sports (N=8; 10.7%).

On the question about the perceived effects of different therapeutic or supportive alternatives (physiotherapy, counselling, speech therapy, symptomatic treatment),

almost half of the respondents reported improvement (N=34; 45.3%), and 30 patients (40%) did not experience improvement with any approach. However, the answers to the open-ended question “What gives results or helps you feel better?” showed that exercise prevailed as an answer (Figure 2).



**Figure 2 Ataxia patients’ answers to “What gives results or helps you feel better?”**

Word cloud image of ataxia patients’ answers to the open question, “What gives results or helps you feel better?” Fifty-five patients responded to this question. Letter size corresponds with the number of patients who mentioned this topic, from 19 patients stating exercise to 1 patient each for several topics shown in the smallest print. Image created with Word-Clouds.com

Interestingly, our study results showed that patients usually seek information by talking to their doctor (N=42; 56%) or searching the internet (N=30; 40%). Nevertheless, the majority (N=50; 66.7%) answered that the most reliable source of information was their doctor. For disease-related questions and moral support, patients turn to close family (N=59; 78.7%), close friends (N=22; 29.3%), and healthcare professionals (N=15; 20%).



In total, 57 patients from our group reported having children, and 54 of them were worried that the next generations might be affected by the disease.

A total of 43 patients (57.3%) recalled genetic testing and were informed about the results. Twenty-eight of them had received a genetic diagnosis. The most common diagnosis was SCA3 and SCA2 with complex ataxias, almost all patients had additional, non-cerebellar signs, and all genetically confirmed forms were complex ataxia forms. Among the 28 patients with a genetic diagnosis, 23 (82.1%) felt well-informed or partly well-informed about their diagnosis, compared to 28 (59.6%) among 47 patients with no genetic diagnosis. Statistical analyses showed a significant association between having a genetic diagnosis and feeling informed ( $P=0.02$ ; Figure 3).

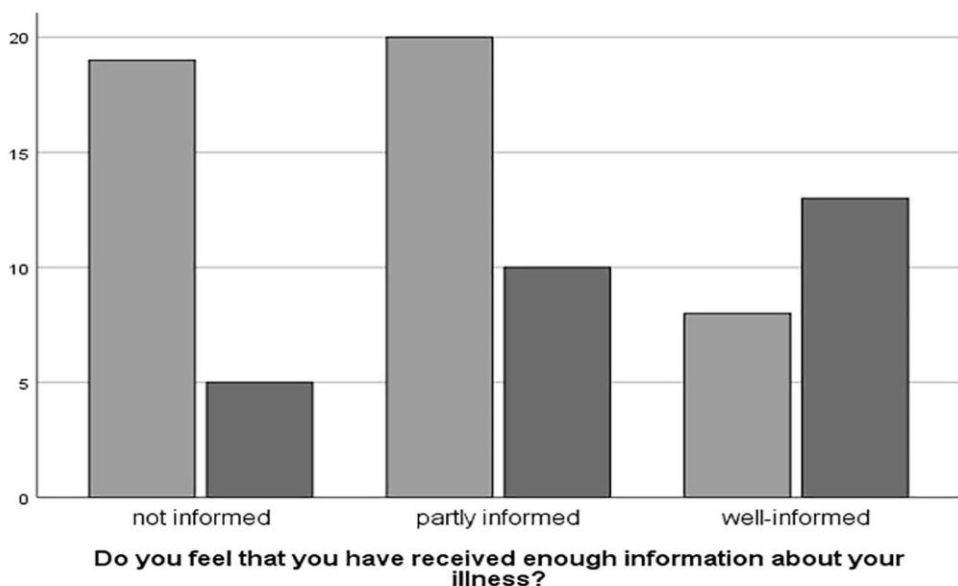

**Figure 3 Having a genetic diagnosis and the degree of feeling informed.**

Patients were divided in two different groups as follows: one group had an established genetic diagnosis (dark gray bars), and the other group did not (light gray bars). Patients in both groups were asked how well-informed they felt about their disease ("well-informed," "partly well-informed," and "not well-informed"). Patients who had received a genetic diagnosis felt better informed than those who had not ( $p = 0.015$ ). Y-axis signifies the number of responses

The EQ-5D-3L questionnaire showed that most patients were affected by the disease to some degree for all five dimensions. Self-care and usual daily activities were the domains where most of our patients reported issues. A significant number of patients did not answer the question on mobility ( $N=20$ ). Thus, we wanted to investigate if this was possibly associated with a higher disability score. The result of the statistical analysis confirmed our hypothesis, patients who did not answer had a

significantly higher SARA score ( $P < 0.005$ ). Comparison analyses between patients affected by ataxia and the general population showed that the quality of life in patients with ataxia was statistically more affected for mostly all age groups and all five domains of EQ-5D-3L. Only for the age group “65 years and older,” no statistically significant difference was seen for the pain and discomfort domain. We compared our data with published EQ-5D-3L data from the Swedish population from individuals selected randomly from the nationwide address register [45]. The test results showed that the quality of life in patients with ataxia is more affected for all five domains of EQ-5D-3L except for pain and discomfort in the age group of 65 years and older compared to the average population.

## Paper III: Toward allele-specific targeting therapy and pharmacodynamic marker for spinocerebellar ataxia type 3

*Is PolyQ ATXN3 a reliable marker that can be measured in CSF and plasma from individuals with SCA3 and can discriminate SCA3 patients from controls?*

This retrospective, cross-sectional study examined patients with an established diagnosis of SCA3 and pre-symptomatic CAG repeat expansion carriers. A trained neurologist from different centres documented all the clinical findings that contributed to the study. The following instruments were used for neurological evaluations:

- the Scale for the Assessment and Rating of Ataxia (SARA)[47]
- the Inventory of Non-Ataxia Signs (INAS) [52]
- Activities of Daily Living (ADL) [53]
- the SCA Functional Index (SCAFI) [54]
- the Composite Cerebellar Functional Severity Score (CCFS) [55]
- a gait mobility score based on Schon et al scale [56]

The Schon et al. scale is divided into five levels of motor functionality: 0- asymptomatic, 1- impaired gait (no assistance required), 2- impaired gait (utilizes cane when ambulating), 3- requires walker, 4- wheelchair bound, 5- bedridden. Family history of neurological conditions, history of falls, vision impairment, dysphagia, presence/absence of paraesthesia, and urine and faeces incontinence were reviewed for each participant. The clinical examination focused on eye movement impairment, nystagmus, frontal lobe release signs, cognitive and behavioural dysfunction, ataxia, pyramidal signs and lower motor dysfunction,

peripheral neuropathy, and parkinsonism. *ATXN3* CAG-repeat length was measured to evaluate the correlation between the age of onset and other disease characteristics described previously in the literature; patient biofluids (blood, plasma, and cerebrospinal fluid) and skin biopsies were collected according to standardized protocols from patients with SCA3 and control with other forms of ataxia, *C9orf72* carriers, and healthy individuals from 6 different contributing centres: Mayo Clinic in Florida and Arizona, Lund University (Sweden), University College of London (United Kingdom), University of Coimbra (Portugal) and the Massachusetts General Hospital and Washington University through their Dominantly Inherited ALS (DIALS) Network study. An immunoassay was specially developed for this study to assess if polyQ *ATXN3* proteins accumulate in biofluids. Neurofilament light chain (NFL) was measured in the cerebrospinal fluid (CSF) and blood of participants since increased NFL has been previously associated with various neurological conditions, including SCA3.

### *Results*

For the CSF series, samples from *ATXN3* CAG-expansion carriers were obtained from the Mayo Clinic in Florida (N=24) or Arizona (N=1), the Lund University in Sweden (N=12), the University College of London in the United Kingdom (N=11) and the University of Coimbra in Portugal (N=1). For the primary plasma cohort, samples from *ATXN3* CAG-expansion carriers were obtained from the Mayo Clinic in Florida (N=31) or Arizona (N=1), the Lund University in Sweden (N=12) and the University of Coimbra in Portugal (N=1). Samples from non-SCA3 ataxia patients in the CSF series and primary plasma cohort were collected at Mayo Clinic Florida. In contrast, biofluids from healthy individuals and *C9orf72* repeat expansion carriers were collected at the Mayo Clinic Florida or the Massachusetts General Hospital and Washington University through their Dominantly Inherited ALS (DIALS) Network study. A second plasma cohort with samples from 30 healthy individuals, 40 SCA3 patients, and two pre-symptomatic SCA3 patients was collected from the University College of London to validate the study results.

The study results showed that both in the CSF series and the primary plasma cohort, polyQ *ATXN3* was elevated in patients with SCA3 compared to the control groups (no *ATXN3* CAG-expansion) both in unadjusted and adjusted analyses for age and sex (median concentration in CSF: 0.13 pg/ $\mu$ l for SCA3 participants, 0.00 pg/ $\mu$ l for controls; median concentration in plasma: 1.28 pg/ $\mu$ l for SCA3 participants, 0.00 pg/ $\mu$ l for controls; Figure 1A and 1B). Although there were only four asymptomatic *ATXN3* CAG-expansion carriers, which decreases the power to detect the differences between the groups, CSF-polyQ *ATXN3* levels were higher in symptomatic SCA3 patients compared to pre-symptomatic SCA3 individuals (median concentration, 0.07 pg/ $\mu$ l) in unadjusted analysis ( $P=0.01$ ; Figure 1A) and in analysis adjusted for age and sex ( $P=0.035$ ). The latter did not meet the threshold of statistical significance, which was considered  $P<0.01$ . However, no difference was observed in plasma levels of polyQ *ATXN3* between symptomatic and pre-

symptomatic SCA3 patients (Figure 1B). In the independent validation group of plasma samples, polyQ ATXN3 was also significantly higher in patients with SCA3 (median concentration, 1.08 pg/μl; N = 40) compared with healthy controls (median concentration, 0.0 pg/μl; N = 30;  $P < 0.001$ ; Figure 1B). The ability of polyQ ATXN3 to differentiate patients with SCA3 from controls was evaluated by approximating the area under the receiver operating characteristic curve (AUC). In the CSF series and the primary plasma cohort, polyQ ATXN3 completely differentiated patients with SCA3 from controls, with AUC values equal to 1.00 (Figure 1C). Likewise, plasma polyQ ATXN3 differentiated patients with SCA3 from controls in the independent validation cohort (AUC, 1.00; Figure 1C). CSF polyQ ATXN3 also showed good differentiating ability when comparing SCA3 from asymptomatic ATXN3 CAG expansion carriers, with an AUC value of 0.89 (Figure 1D). In contrast, plasma polyQ ATXN3 only moderately differentiated between patients with SCA3 and asymptomatic ATXN3 CAG expansion carriers with an AUC of 0.70 [with 95% confidence intervals (CIs) ranging from 0.38 to 1.00; Figure 1D].

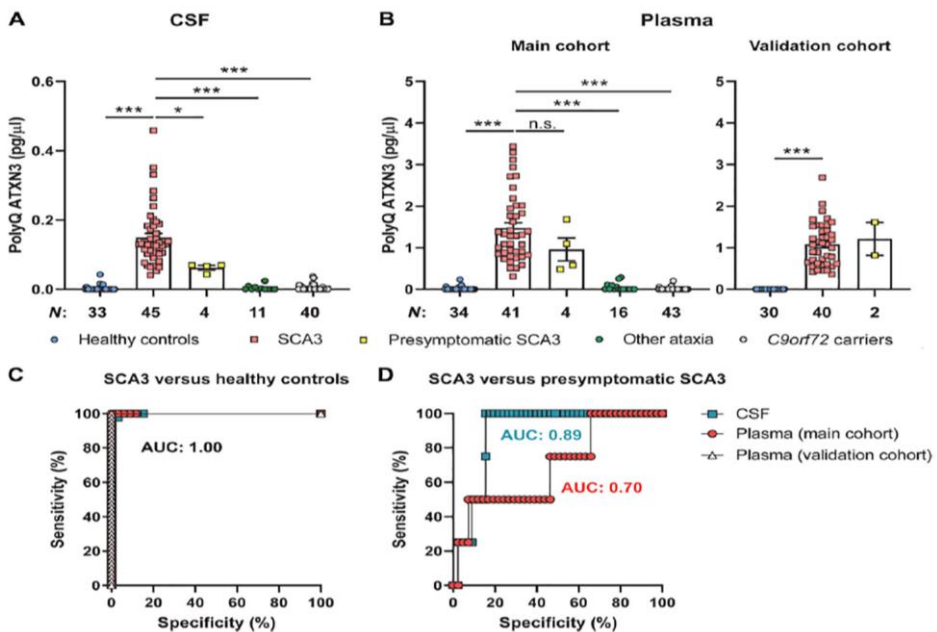

**Figure 1 PolyQ ATXN3 proteins in plasma and CSF from individuals with SCA3 can distinguish patients with SCA3 from controls.**

(A and B) PolyQ ATXN3 in CSF (A) and plasma (B) was measured using an immunoassay as described in Materials and Methods in the published article. The number of cases per study group is included below the graphs. Graphs represent means  $\pm$  SD (standard deviation). Statistical differences represent unadjusted and adjusted analyses \* $P < 0.05$  and \*\*\* $P < 0.001$ ; n.s., nonsignificant differences. (C and D) Area under the receiver operating characteristic curve (AUC) for polyQ ATXN3 between SCA3 and healthy controls (C) or presymptomatic SCA3 carriers (D) in both the CSF and plasma.

This study also showed that the neurofilament light chain (NFL) could differentiate patients with SCA3 from controls. NFL was significantly increased compared to healthy controls or patients with other forms of ataxia ( $P < 0.01$ ; Figure 2A and 2B) in CSF and plasma from patients with SCA3. Interestingly CSF and plasma NFL levels were lower in pre-symptomatic carriers of *ATXN3* CAG expansions compared to symptomatic carriers ( $P < 0.01$ ; Figure 2A and 2B). Additionally, AUC analyses confirmed these findings (Figure 2C), CSF NFL has the perfect differentiating ability (AUC, 1.00) between pre-symptomatic *ATXN3* CAG expansion carriers and symptomatic SCA3 patients, and plasma had a lower AUC of 0.87 (Figure 2D).

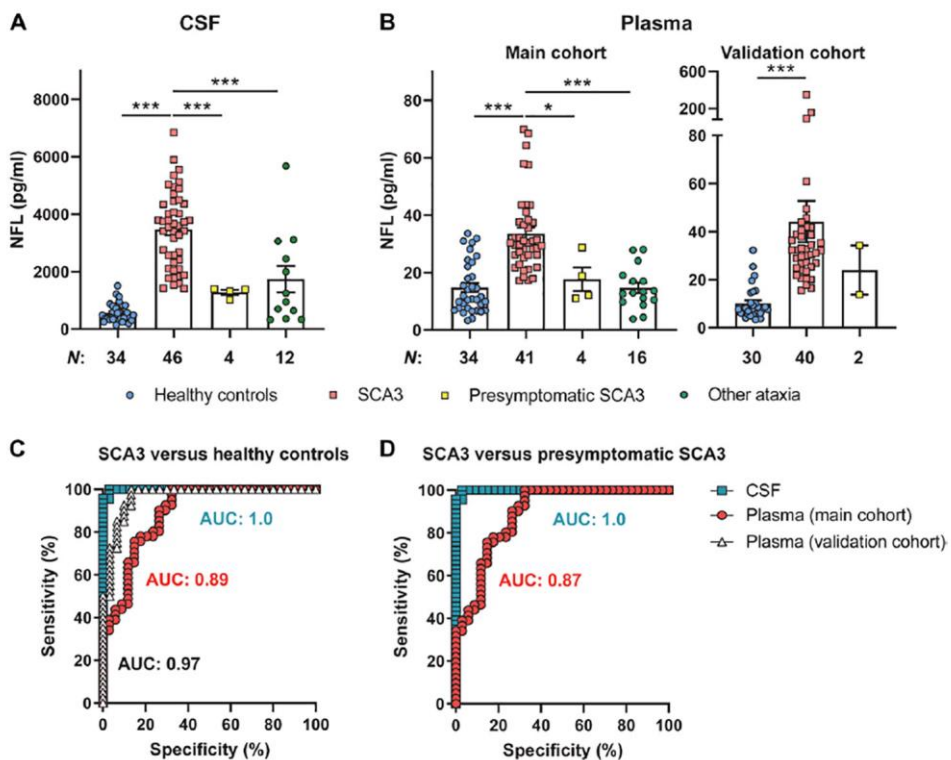

**Figure 2 Neurofilament light can also differentiate patients with SCA3 from controls.**

NFL in the CSF (A) and plasma (B). The number of cases per study group is included below the graphs. Graphs represent means  $\pm$  SEM. Statistical differences represent unadjusted and adjusted analyses. \* $P < 0.05$  and \*\*\* $P < 0.001$ . (C and D) AUC for NFL between SCA3 and healthy controls (C) or presymptomatic SCA3 carriers (D) in both the CSF and plasma.

After that, the association between plasma and CSF polyQ ATXN3 and clinical features such as age at ataxia onset, disease duration, gait mobility, SARA score, and *ATXN3* CAG repeat length was evaluated. For the measurements in CSF, no such associations were seen ( $P>0.05$ ). The analyses in the primary plasma cohort and the validation cohort showed a weak association of PolyQ ATXN3 with earlier disease onset ( $P=0.02$ ), increased gait disability ( $P=0.03$ ), and a longer *ATXN3* CAG repeat length ( $P=0.03$ ); these weak associations were no longer available when adjusted for sex, age, and disease duration. Data from tests such as INAS, SCAFI, CCFS, and ADL were available for 40 patients with SCA3 in the validation group, but no association could be seen between the test scores and plasma polyQ ATXN3 of these patients.

There was no association between CSF or plasma NFL and clinical features (age at onset, disease duration, gait impairment, INAS, ADL, SCAFI, and CCFS scores). Even though both polyQ ATXN3 and NFL are reliable markers for differentiating SCA3 patients from healthy controls, no statistically significant correlation was observed between them in CSF or plasma ( $P>0.05$ ).

Although no association could be found between polyQ ATXN3 and NFL levels and clinical features, there was a clear inverse association between *ATXN3* CAG expansion length and age of ataxia onset ( $P<0.01$ ) in line with results from previous studies[57, 58]. The association between repeat length and SARA score was weak ( $P=0.02$ ). Also, patients with a longer repeat length tended to perform worse on INAS, ADL, SCAFI, and CCFS scores.

In this study a single nucleotide polymorphism (SNP), rs7158733 located ~132 nucleotides downstream the CAG repeat in the *ATXN3* gene, was closely assessed. It appears that this SNP turns a tyrosine codon into a stop codon ( $TAC^{1118} > TAA^{1118}$ ) which precipitates the termination of the ATXN3 protein. The short protein is more susceptible to aggregation, when combined with CAG repeats expansions. The conclusion of the analyses was that the  $TAA^{1118}$  allele strongly correlates with *ATXN3* CAG repeat expansions ( $P<0.01$ ) and increases the risk of SCA3 compared to all the control individuals without an *ATXN3* mutation. These findings may be helpful information for developing future therapeutic strategies for SCA3. There were five lines of fibroblasts from SCA3 patients and four lines of fibroblasts from controls that were treated with an *ATXN3* siRNA to experiment with this. The polyQ ATXN3 levels were measured before and after treatment. The results showed that the response to treatment was different between individuals.

## Paper IV: Ataxia-Pancytopenia syndrome with *SAMD9L* mutations

*What is the neurological, neuroradiological, and ophthalmological presentation of ataxia-pancytopenia syndrome?*

This descriptive case report study presents two larger families with a particular disorder, the genetic cause of which had been described a short time before our work. Both affected and unaffected family members were neurologically and genetically examined to map the typical features of this condition. A trained doctor interviewed and examined all the individuals following a structured template that covered characteristic clinical signs for autosomal dominant ataxia-pancytopenia (ATXPC) syndrome previously described in the literature. The Scale for the Assessment and Rating of Ataxia (SARA) was used to assess the disease severity.[47] Images from neuroradiologic examination and medical files were retrieved if available. A specialized neuro-otologist evaluated and recorded eye-movements. Several patients who reported vision impairment were examined ophthalmologically with optical coherence tomography, multifocal electroretinography, and full-field electroretinography. Previous blood test results on cell counts were analysed and new blood samples were collected. DNA was extracted through conventional methods from the peripheral blood or buccal swabs. Some of these families' hematologic findings and genetic results in these families have been published earlier [59]. For this study, we had the opportunity to examine additional members from the Swedish family neurologically and genetically.

### *Results*

We examined 21 members from a Swedish family (F1) and six from a Finnish family (F2). The pedigrees from both families are presented below in Figure 1. It was possible to extract and analyse the DNA from 18 members in F1 and from six members in F2. The results showed that all mutation carriers presented neurological symptoms during the examination. All 13 individuals that did not carry the *SAMD9L* mutation lacked neurological signs at examination.

F1: III-4 presented at our outpatient clinic at age 53 because of modest balance problems. During the clinical interview, he reported that his mother and his maternal grandmother had similar symptoms that advanced slowly. (Figure 1). Initially, no *SAMD9L* mutation was identified in the peripheral blood, but analysis of DNA from a buccal swab showed that he was a heterozygous carrier of *SAMD9L* c.2956C.T (p.Arg986Cys) mutations. No other members of his family were known to have neurological symptoms. However, when examined, all carriers of the same variant reported problems with gaze fixation, for example, when reading, or mild balance problems when practicing sports.

F2: II-4 had a seizure during sleep at age 7; during neurologic examinations, he presented balance impairment, nystagmus, dysmetria, increased tendon reflexes, and muscle stiffness in the lower extremities. His mother F2: I-2 was simultaneously investigated neurologically at the age of 32 years for memory impairment, nystagmus, weakness of lower extremities, and balance impairment. His brother F2: II-1 had only mild neurological symptoms. In this family, the neurologic phenotype varied from mild to severe impairment. The variant found in the three affected individuals from this family was a heterozygous *SAMD9L* c.2672T>C (p.Ile891Thr). Interestingly history of cytopenia was positive in all affected members. F1: III-5 died from a severe infection in the context of a myelodysplastic syndrome. Two individuals underwent hematopoietic stem cell transplantation for myelodysplastic syndrome at an early age. One of them, F1: V-1, did not present any neurological symptoms before the treatment, but gait ataxia and nystagmus were noted on the three months follow-up post-treatment. For the other patient, F2: II-4, the treatment did not cause any neurological decline.

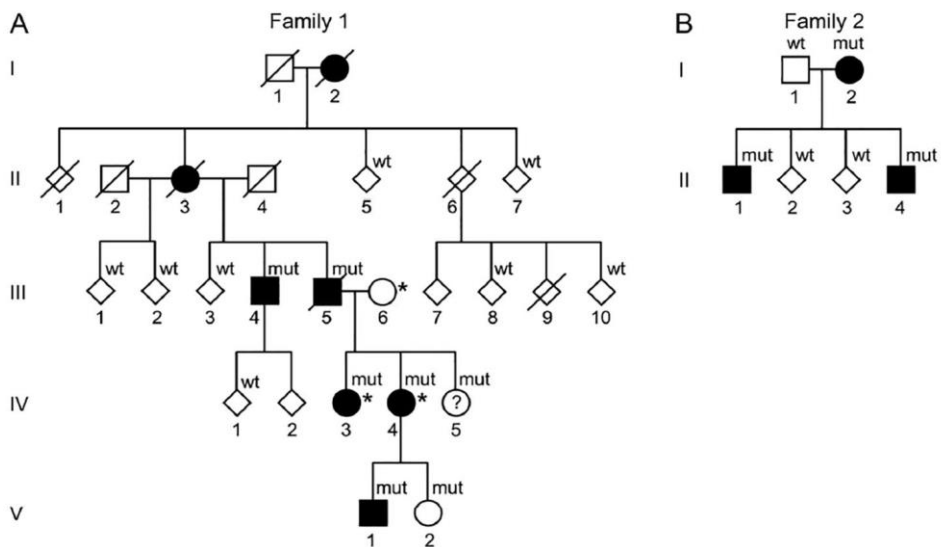
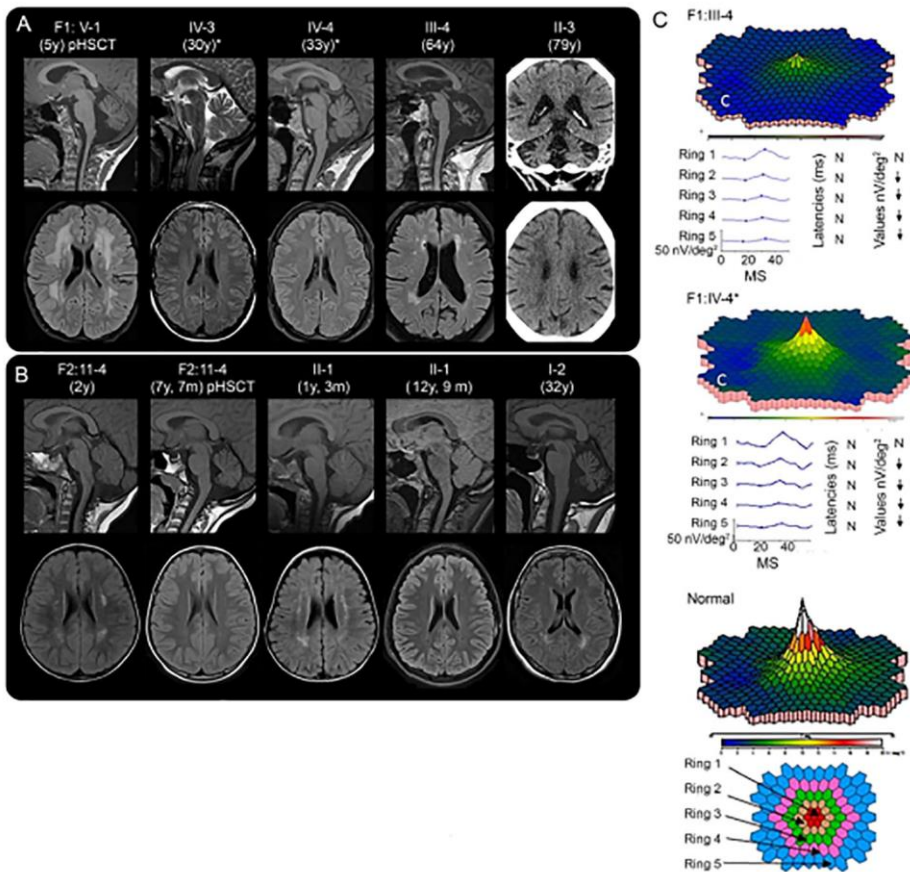

**Figure 1 Pedigrees of the Swedish and Finnish families with ataxia-pancytopenia syndrome and *SAMD9L* mutations**

Standard symbols are used. Several members' sex is disguised (diamond-shaped symbols) and some family members are not included for reasons of confidentiality or lack of consent for this study. Solid symbols indicate neurologic signs or symptoms. (A) Family 1 (Swedish): mut: heterozygote *SAMD9L* c.2956C.T, p.Arg986Cys mutations in DNA from buccal swabs. Wt: wild-type. Asterisk (\*): 3 individuals also carry the rare variant c.689C.A p.Thr233Asn, located in trans in IV-3 and IV-4. The c.2956C.T mutation leads to a gain of function of *SAMD9L*'s inhibitory functions on cell-cycle regulation, whereas c.689C.A was hypothesized to ameliorate this effect through a loss of function. (B) Family 2 (Finnish): mut: heterozygote *SAMD9L* c.2672T.C, p.Ile891Thr mutations. Wt: wild-type in DNA extracted from the peripheral blood.



The neuroradiological images of affected adult patients showed marked cerebellar atrophy and white matter hyperintensities in the frontoparietal periventricular areas on T2-FLAIR images. The results of mfERG for the patients with visual problems revealed a paramacular cone dysfunction that had not previously been described in this syndrome (Figure 2C).



**Figure 2 Neuroimaging and multifocal electroretinography (mfERG)**

(A and B) Neuroradiologic findings in affected members of family 1 (A) and family 2 (B); Age at examination in parentheses; pHST, posthematopoietic stem cell transplantation; \*Also carry the rare variant *SAMD9L* c.689C.A in trans; Sagittal MRIs reveal cerebellar atrophy in all examined individuals; Bilateral hyperintense signal changes were visible in the frontoparietal periventricular white matter on T2-FLAIR images to a variable degree in all patients, except the 2 adults with the rare variant *SAMD9L* c.689C.A (A and B); F1: V-1 had prominent white matter changes after hematologic malignancy and 3 months post-HSCT (A), in contrast, white matter changes in F2: II-4, who also had hematologic malignancy and HSCT, decreased (B); mfERG of 2 patients, compared to normal findings in an adult, shows reduced paracentral function in both patients, to a different degree. N, normal; Y, significantly reduced function (C); ms and MS, milliseconds.



# Discussion

HCAAs are a group of highly heterogeneous and chronically progressive diseases. The idea for this project was initiated because many patients at our clinic with a history or clinical phenotype suggestive of hereditary ataxia did not yet have an established genetic diagnosis. However, many of them have moderate or severe symptoms.

The rapid expansion of genomics has led to the discovery of hundreds of genes associated with diseases that have ataxia as the predominant clinical phenotype or where ataxia may present as a symptom. This information can be easily accessed, for example, through the Human Phenotype Ontology (HPO) online database. The challenge for clinicians remains to interpret the genetic results and find an affected gene that can confirm the cause of the disease.

For this project, we have systematically included patients diagnosed with hereditary ataxia. Most of them were already examined for CAG repeats expansions, a routine test at our clinic for many years. We additionally analysed the DNA of patients lacking a genetic diagnosis, using WES or WGS and searching for genes associated with ataxia when the availability of these methods was still limited in a clinical setting. Short read WES was the most used method for the genetic analyses of blood samples from our patients because this was the method available for clinical testing and most financially affordable at the time of the study, which represents a limitation since variants with intronic locations causing ataxia to have more recently been identified, that are not found by WES. Towards the end of the study, we shifted towards WGS, based on the evidence that intronic *RFC1* variants were a common cause of recessive ataxia with a unique combination of features [41], and because WGS has emerged as the new standard examination in the clinical setting. Only weeks before this thesis was compiled, intronic repeat expansions in *FGF14* that are difficult to detect directly, even by (short read) WGS, were reported [42, 60]. It is difficult to estimate how many more patients could have been diagnosed if we had used more advanced NGS methods for the whole group. In a few patients, even though we had some critical genetic findings, they did not meet the ACMG diagnosing criteria, and we remained unsure about the final diagnosis because of insufficient clinical or genetic evidence. Genetic analyses of family members for some of these individuals are ongoing and might help us eventually find an accurate diagnosis.

Fifteen patients from 11 families received a genetic diagnosis during our study. In the end, 44 patients (50.6%) had an established genetic diagnosis. As a result, we have summarized the genetic forms of ataxia present in the Swedish population. We have been able to find and describe new forms of ataxia with distinct characteristics for some individuals and families. Our results are based on a selected patient group and thus may not represent Sweden's distribution of genetic ataxia subtypes. The most common type of autosomal dominant ataxia in our study was SCA3 which is consistent with previous reports for the European population [3, 61]. However, it must be mentioned that we actively recruited patients with SCA3 for a multicentre study [48, 49], which might have influenced the final number if we had avoided that. The most common diagnosis for the autosomal recessive forms was Cerebellar Ataxia, Neuropathy, Vestibular Areflexia Syndrome, and Ataxia-Telangiectasia. It has previously been reported that biallelic expansion of AAGGG in the *RFC1* gene is a common cause of late-onset ataxia in Europeans [41]. Friedreich ataxia could have been the most common autosomal recessive form of ataxia, but most patients have already been included in a previous research study at our clinic [46]. In a few patients, we found diagnoses that are typically not considered genetic ataxias. Two patients had spastic paraplegia, one had Huntington's disease, and one had Brown-Vialetto-Van-Laere Syndrome. All these patients presented signs of ataxia on examination, leading to clinicians setting the diagnosis of hereditary ataxia. Moreover, it is well-known that HCAs and hereditary spastic paraplegias share overlapping phenotypes and common pathogenic mechanisms, which makes the clinical distinction sometimes challenging [62].

We reclassified two genetic variants to be disease-causing that, according to the ACMG classification system, were considered variants of uncertain significance. A heterozygous *ELOVL4* variant, NM\_022726.4 c.511A>C p.(Ile171Leu), was identified in all four affected family members, which supported the probability of it being pathogenic [63]. All affected individuals had a constellation of signs characteristic of the diagnosis of SCA34: ataxia, cognitive impairment, marked cerebellar atrophy on brain imaging, and features of dry skin [64, 65]. With this additional information, this variant was reclassified as likely pathogenic.

A heterozygous *STUB1* variant, NM\_005861.2 c.107T>C p.(Leu36Pro), was identified in a patient who showed unique clinical features of ataxia with frontotemporal cognitive dysfunction. The pathological examination confirmed a macroscopic cerebellar atrophy, a subtotal loss of Purkinje cells, and atrophy of the molecular layer microscopically. The cerebral tissue showed tau-positive neurites, neuronal bodies, and astrocytes, with degenerative changes in the cortex and more pronounced degenerative changes in the thalamus, mesencephalon, and pons. Additionally, p62-positive intraneuronal inclusions have previously been described in patients with SCA48 [66]. However, there is not enough evidence if these intraneuronal inclusions are pathognomonic for the diagnosis. Based on the

characteristic clinical phenotype in combination with the genetic result and characteristic histopathologic observations, we considered that our findings were consistent with the diagnosis SCA48. These cases highlight the importance of a repeated detailed clinical examination post-NGS and close collaboration with patients, their families, and clinical and medical geneticists to help accept or reject a diagnosis. In *paper I*, we discuss the potential risk that clinicians may overinterpret genetic findings of uncertain significance but weigh this against the additional diagnostic yield that may be achieved.

Having an exact genetic diagnosis is essential for many different reasons. It allows us to establish a diagnosis, identify treatable disorders, and select high-risk patients for trials of new disease-modifying treatments. It offers the opportunity to provide information on the inheritance pattern, inform patients and families about the prognosis and influence treatment decisions. Ataxia-pancytopenia syndrome is a perfect example of the importance of having an exact genetic diagnosis to monitor and prevent eventual serious complications [67]. Another example is our patient with Brown-Vialetto-Van-Laere syndrome, diagnosed in his thirties; we noticed that treatment with high doses of riboflavin slowed down the worsening of symptoms [68]. However, there are situations when a genetic test can give rise to ethical dilemmas and lead to conflict. Ethical issues are frequent in neurogenetic conditions with consequences for healthcare and decision-making that involves not only the patient but also the relatives, particularly first-degree blood relatives. For example, when there is a known family history of genetic disease and children decide to find out if they carry the disease, the parents do not want to know. Also, when parents decide to know if their minor child will develop an adult-onset genetic disease. These kinds of decisions may violate individuals' autonomy and freedom of choice.

Within our study, we sometimes were in situations that required us to contact patients' family members (with the patient's consent) to help verify the familial segregation of a genetic variant. For this purpose, we used carefully worded letters approved by the ethics review board that informed the relatives about the aim of our investigation and offered them the choice of disclosure or non-disclosure of test results and genetic information in case they were willing to be tested. In our population, we had two pre-symptomatic carriers of *ATXN3* CAG expansions who had been genetically tested and informed about the result before the study. The testing of asymptomatic family members is called predictive genetic testing and may pose a series of problems if not handled adequately. Individuals in this situation might have good reasons for wanting to get tested for a neurogenetic disease, such as career and family planning or getting help with preventing disease-specific complications. The question is, of course, if they had received enough information and were prepared to face the consequences of testing because of the psychological stress they are exposed to while seeing their family members decline and become disabled inevitably. Also, in some patients, the disease might have incomplete penetrance or a variable expression, with milder symptoms or later onset than in its

relatives. The risk of genetic discrimination should be considered when testing patients for HCA. For example, suppose a person is diagnosed with a debilitating genetic disease. In that case, employers may discriminate against them against other candidates, which can be avoided if the testing results remain anonymous and employers are not allowed access to such information. Many neurologic and genetics clinics are in academic medical centres. Access to high-end genetic testing methods may be limited for some individuals residing outside these areas or in economically disadvantaged regions. Inviting patients to participate in research studies, expanding the role of telemedicine, and training primary care physicians and other healthcare providers to know when genetic testing is suitable and how to educate and inform patients and families competently, may reduce these inequalities [69].

In our survey-based study, we could establish that patients with ataxia had a significantly lower overall quality of life compared to age-matched population data from the general Swedish population [45]. This study sheds light on the differences between patients with disabilities and the society they live in and is the first of a such kind in Sweden. Exercise and support from family and close friends were among the essential strategies that improved patients' overall well-being. Personal information provided by doctors was considered the most trustworthy. Patients with a verified genetic diagnosis had a lower average age at onset and felt more informed about their disease than those without a genetic diagnosis. We consider that an early symptom onset is more suggestive of a genetic cause of the disease and that in many forms of late-onset hereditary ataxia, the genetic cause remains unknown. In the future, this could be changed by advancements in genetic testing. Walking and balance impairment were some of daily life's most frequently reported difficulties. As a result of this study, we found that any physical activity benefits our patients. There is also scientific evidence that sustained intensive physiotherapy and video games can improve the balance and gait of patients with ataxia [25]. Based on these findings, all patients diagnosed with ataxia should be recommended to engage in daily physical activities. Of course, an assessment of risks and limitations should be done first with the help of a physiotherapist to avoid injuries. There are resources where evidence-based exercises for patients with ataxia are explained and accessible online (<https://www.ataxia.org/11-exercises-for-ataxia-patients/>). These strategies have been shown to affect even patients with a greater degree of disability positively. Another important aspect is to provide adjusted assistive devices to each patient, which increases the freedom of mobility. Getting support from family and close friends was an aspect that played an essential role in the quality of life of patients. So, what to do when some patients are living alone? Participation in organized social activities, patient organizations, or supportive communities should be promoted. Providing appropriate medical information about the disease was as essential and beneficial. Healthcare providers should be trained to offer adequate education and counselling to patients and families.

The multicentre study on polyQ ATXN3 and NFL as markers in SCA3 showed promising results on the discriminatory ability between symptomatic patients with SCA3 and controls (other types of ataxia or healthy individuals). Also, the markers could differentiate between symptomatic and pre-symptomatic carriers even though the number of pre-symptomatic individuals was minimal. These findings may lay the foundation for future research studies and clinical trials for developing SCA3 treatments.





# Conclusions

Having symptoms of ataxia without knowing the underlying cause may be very frustrating for the patient, who does not know what the future holds, and for the clinician for not being able to establish a diagnosis or provide the patient and the family with appropriate information. The expanding role of NGS technology in genomics and continuously adjusted methods for bioinformatical analyses of vast sequencing data may facilitate the finding of a genetic cause in the future. New disease-causing genes for HCA are constantly discovered, emphasizing the importance of updating the gene lists available when performing tests for clinical and research purposes. Also, in the future, there may be more evidence for some genes that have been wrongly associated with ataxia and will need to be removed from the gene lists. Meanwhile, the role of the examining neurologists and collaborative discussions with colleagues from the department of clinical genetics can help to interpret the genetic test results and confirm or reject a diagnosis.

When setting the diagnosis of HCA, clinicians should be trained to provide thorough disease-related information and relevant educational resources to help patients navigate life from their perspective. Pharmacologic therapies addressing different symptoms should be discussed individually with patients. The healthcare providers should focus on the patient's access to physiotherapy, appropriate assistive devices, and physical or social activities that may improve the quality of life. Contact should be established with a physiotherapist or a rehabilitation team to help tailor an exercise and lifestyle program adapted to each patient and their home environment. This approach may improve not only the physical but also the mental health and quality of life of each patient, which in turn will probably make the patients feel more included in society and willing to be active and continue working for as long as possible, sparing money and energy from frequent medical visits.



# Acknowledgments

This journey started in 2016 when my supervisor, Andreas, asked me if I would be interested in being part of his research project. I had a vague knowledge of hereditary ataxia then, and the subject seemed complex. Nevertheless, I was curious and accepted the challenge with some scepticism. Thank you, Andreas, for believing in me and offering me this great opportunity. Thank you for your kindness, understanding, and endless support and for making amusing observations on my drafts.

Klas, my co-supervisor, thank you for your support and clever insights.

Jan, thank you for offering me my first medical doctor job in Sweden and for your kind support.

Christer, thank you for hiring me to finally become a neurologist. Thank you for your excellent guidance during all these years.

Christin, thank you for taking care so nicely of every patient and for helping me out when I didn't know where to find things. I appreciate all the stories and laughs we shared during our breaks.

Joel and Effie, thank you for your support and effort in going through all the genetic data. You both had a significant role in this project.

To all the co-authors and editors of the papers included in this thesis for the fruitful collaboration that made this work's accomplishment possible.

Thank you to all the teachers from Lund University for sharing your knowledge and skills and pointing out available resources that made my work easier.

A big thank you to my advisor and mentor, Irina. Your kindness and encouragement paved the road to where I am now. You're a true inspiration to me.

Thank you to all my colleagues at the Clinic of Neurology in Lund for your support and patience with all my questions and reflections during the residency program. For always making me laugh at your hilarious stories during lunch breaks.

To Linnea, you helped me see behind bars and changed my perspective many times. You're so intelligent and funny. You're a great friend and colleague.

Thank you to ALF Sweden, SCA-Network, and Fysiografen for the financial support of my work.

Thank you to all the patients and their families who participated in this research study. Without your significant contribution this work would not have been possible.

Thank you to my parents, Emilia, and Nicolai, for always being there for me and cheering for my success.

To my wonderful sister, Alina, for sharing so many lovely moments and beautiful memories together. You make my life so colourful; I love you so much.

To Johan, Lidia, Ulla, and Bengt, thank you so much for making me acquainted with the Swedish culture and being always so generous and supportive.

To my bestie, Vicky, we have been friends since our student days, and I feel so lucky to have you in my life. Every moment spent with you has been filled with joy, from our late-night study sessions to our adventures and travels. Your compassion and kindness have helped me through some of the most challenging times in my life. Thank you for always being there for me and such a wonderful friend.

To Kety, Emma, Becca, and Katharina, your friendship has been a source of joy and comfort for me. Thank you for being such kind and loving friends.

To Bex, I still vividly remember the day we met at that picnic in Lund's botanical garden. I am so grateful for the bond we have formed since then. Thank you for your kind generosity and support. It means a lot to me.

To Oli, Dali, Mare, Teo, Vali, Tayla, and Farouq, my international family, thank you so much for your encouragements and support. I am so happy to have you all in my life. I can't wait for us to meet again.

Finally, thank you to everyone who has crossed my path and helped me become who I am.

# Funding

This study was funded by the Swedish government (through the ALF agreement), Region Skåne, Skåne University Hospital research funds and donations, open access funding provided by Lund University, MultiPark, a strategic research environment at Lund University, The Swedish Parkinson Academy, Bundy Academy and SCA network, all in Sweden.



# References

1. Hellberg, C., et al., Nationwide prevalence of primary dystonia, progressive ataxia and hereditary spastic paraplegia. *Parkinsonism Relat Disord*, 2019. **69**: p. 79-84.
2. Chen, D.H., et al., Ataxia-Pancytopenia Syndrome Is Caused by Missense Mutations in SAMD9L. *Am J Hum Genet*, 2016. **98**(6): p. 1146-1158.
3. Ruano, L., et al., The global epidemiology of hereditary ataxia and spastic paraplegia: a systematic review of prevalence studies. *Neuroepidemiology*, 2014. **42**(3): p. 174-83.
4. Schöls, L., et al., Autosomal dominant cerebellar ataxias: clinical features, genetics, and pathogenesis. *Lancet Neurol*, 2004. **3**(5): p. 291-304.
5. Perlman, S., Hereditary Ataxia Overview, in *GeneReviews*(®), M.P. Adam, et al., Editors. 1993, University of Washington, Seattle. All rights reserved.: Seattle (WA).
6. Zortea, M., et al., Prevalence of inherited ataxias in the province of Padua, Italy. *Neuroepidemiology*, 2004. **23**(6): p. 275-80.
7. Wardle, M., et al., The genetic aetiology of late-onset chronic progressive cerebellar ataxia. A population-based study. *J Neurol*, 2009. **256**(3): p. 343-8.
8. Jardim, L.B., et al., A survey of spinocerebellar ataxia in South Brazil - 66 new cases with Machado-Joseph disease, SCA7, SCA8, or unidentified disease-causing mutations. *J Neurol*, 2001. **248**(10): p. 870-6.
9. Infante, J., et al., Autosomal dominant cerebellar ataxias in Spain: molecular and clinical correlations, prevalence estimation and survival analysis. *Acta Neurol Scand*, 2005. **111**(6): p. 391-9.
10. Erichsen, A.K., et al., Prevalence of hereditary ataxia and spastic paraplegia in southeast Norway: a population-based study. *Brain*, 2009. **132**(Pt 6): p. 1577-88.
11. Zhao, Y., et al., Prevalence and ethnic differences of autosomal-dominant cerebellar ataxia in Singapore. *Clin Genet*, 2002. **62**(6): p. 478-81.
12. van de Warrenburg, B.P., et al., Spinocerebellar ataxias in the Netherlands: prevalence and age at onset variance analysis. *Neurology*, 2002. **58**(5): p. 702-8.
13. Tsuji, S., et al., Sporadic ataxias in Japan--a population-based epidemiological study. *Cerebellum*, 2008. **7**(2): p. 189-97.
14. Coutinho, P., et al., Hereditary ataxia and spastic paraplegia in Portugal: a population-based prevalence study. *JAMA Neurol*, 2013. **70**(6): p. 746-55.
15. Anheim, M., et al., Epidemiological, clinical, paraclinical and molecular study of a cohort of 102 patients affected with autosomal recessive progressive cerebellar ataxia from Alsace, Eastern France: implications for clinical management. *Neurogenetics*, 2010. **11**(1): p. 1-12.

16. Schöls, L., et al., Autosomal dominant cerebellar ataxias: clinical features, genetics, and pathogenesis. *The Lancet Neurology*, 2004. **3**(5): p. 291-304.
17. Harding, A.E., Classification of the hereditary ataxias and paraplegias. *Lancet*, 1983. **1**(8334): p. 1151-5.
18. Klockgether, T. and H. Paulson, Milestones in ataxia. *Mov Disord*, 2011. **26**(6): p. 1134-41.
19. Lange, L.M., et al., Nomenclature of Genetic Movement Disorders: Recommendations of the International Parkinson and Movement Disorder Society Task Force - An Update. *Mov Disord*, 2022. **37**(5): p. 905-935.
20. Sullivan, R., et al., Spinocerebellar ataxia: an update. *J Neurol*, 2019. **266**(2): p. 533-544.
21. Radmard, S., T.A. Zesiewicz, and S.H. Kuo, Evaluation of Cerebellar Ataxic Patients. *Neurol Clin*, 2023. **41**(1): p. 21-44.
22. Ashizawa, T. and G. Xia, Ataxia. *Continuum (Minneapolis, Minn)*, 2016. **22**(4 Movement Disorders): p. 1208-26.
23. Rosenthal, L.S., Neurodegenerative Cerebellar Ataxia. *Continuum (Minneapolis, Minn)*, 2022. **28**(5): p. 1409-1434.
24. Gorcenco, S., et al., New generation genetic testing entering the clinic. *Parkinsonism Relat Disord*, 2020. **73**: p. 72-84.
25. Synofzik, M. and W. Ilg, Motor training in degenerative spinocerebellar disease: ataxia-specific improvements by intensive physiotherapy and exergames. *Biomed Res Int*, 2014. **2014**: p. 583507.
26. Miyai, I., et al., Cerebellar ataxia rehabilitation trial in degenerative cerebellar diseases. *Neurorehabil Neural Repair*, 2012. **26**(5): p. 515-22.
27. Gorcenco, S., C. Karremo, and A. Puschmann, Patients' Perspective in Hereditary Ataxia. *Cerebellum*, 2022.
28. Keller, J.L. and A.J. Bastian, A home balance exercise program improves walking in people with cerebellar ataxia. *Neurorehabil Neural Repair*, 2014. **28**(8): p. 770-8.
29. Mandia, D., et al., Cholic acid as a treatment for cerebrotendinous xanthomatosis in adults. *J Neurol*, 2019. **266**(8): p. 2043-2050.
30. Ristori, G., et al., Riluzole in cerebellar ataxia: a randomized, double-blind, placebo-controlled pilot trial. *Neurology*, 2010. **74**(10): p. 839-45.
31. Romano, S., et al., Riluzole in patients with hereditary cerebellar ataxia: a randomised, double-blind, placebo-controlled trial. *Lancet Neurology*, 2015. **14**(10): p. 985-91.
32. Lei, L.F., et al., Safety and efficacy of valproic acid treatment in SCA3/MJD patients. *Parkinsonism Relat Disord*, 2016. **26**: p. 55-61.
33. Zesiewicz, T.A., et al., A randomized trial of varenicline (Chantix) for the treatment of spinocerebellar ataxia type 3. *Neurology*, 2012. **78**(8): p. 545-50.
34. Lo, R.Y., et al., Coenzyme Q10 and spinocerebellar ataxias. *Mov Disord*, 2015. **30**(2): p. 214-20.



35. Jen, J.C., et al., Primary episodic ataxias: diagnosis, pathogenesis and treatment. *Brain*, 2007. **130**(Pt 10): p. 2484-93.
36. Yabe, I., et al., Clinical trial of acetazolamide in SCA6, with assessment using the Ataxia Rating Scale and body stabilometry. *Acta Neurol Scand*, 2001. **104**(1): p. 44-7.
37. Tsunemi, T., et al., The effect of 3,4-diaminopyridine on the patients with hereditary pure cerebellar ataxia. *J Neurol Sci*, 2010. **292**(1-2): p. 81-4.
38. Manor, B., et al., Repetitive Transcranial Magnetic Stimulation in Spinocerebellar Ataxia: A Pilot Randomized Controlled Trial. *Front Neurol*, 2019. **10**: p. 73.
39. Cury, R.G., et al., Safety and Outcomes of Dentate Nucleus Deep Brain Stimulation for Cerebellar Ataxia. *Cerebellum*, 2022. **21**(5): p. 861-865.
40. Chen, T.X., et al., The Efficacy and Safety of Transcranial Direct Current Stimulation for Cerebellar Ataxia: a Systematic Review and Meta-Analysis. *The Cerebellum*, 2021. **20**(1): p. 124-133.
41. Cortese, A., et al., Biallelic expansion of an intronic repeat in RFC1 is a common cause of late-onset ataxia. *Nat Genet*, 2019. **51**(4): p. 649-658.
42. Pellerin, D., et al., Deep Intronic FGF14 GAA Repeat Expansion in Late-Onset Cerebellar Ataxia. *N Engl J Med*, 2023. **388**(2): p. 128-141.
43. Toonen, L.J., et al., Antisense oligonucleotide-mediated exon skipping as a strategy to reduce proteolytic cleavage of ataxin-3. *Sci Rep*, 2016. **6**: p. 35200.
44. Keita, M., et al., Friedreich ataxia: clinical features and new developments. *Neurodegener Dis Manag*, 2022. **12**(5): p. 267-283.
45. Björk, S. and A. Norinder, The weighting exercise for the Swedish version of the EuroQol. *Health Econ*, 1999. **8**(2): p. 117-26.
46. Ygland, E., et al., Atypical Friedreich ataxia in patients with FXN p.R165P point mutation or comorbid hemochromatosis. *Parkinsonism Relat Disord*, 2014. **20**(8): p. 919-23.
47. Schmitz-Hübsch, T., et al., Scale for the assessment and rating of ataxia: development of a new clinical scale. *Neurology*, 2006. **66**(11): p. 1717-20.
48. Prudencio, M., et al., Toward allele-specific targeting therapy and pharmacodynamic marker for spinocerebellar ataxia type 3. *Sci Transl Med*, 2020. **12**(566).
49. Garcia-Moreno, H., et al., Tau and neurofilament light-chain as fluid biomarkers in spinocerebellar ataxia type 3. *Eur J Neurol*, 2022. **29**(8): p. 2439-2452.
50. Richards, S., et al., Standards and guidelines for the interpretation of sequence variants: a joint consensus recommendation of the American College of Medical Genetics and Genomics and the Association for Molecular Pathology. *Genet Med*, 2015. **17**(5): p. 405-24.
51. Schmitz-Hübsch, T., et al., Self-rated health status in spinocerebellar ataxia--results from a European multicenter study. *Mov Disord*, 2010. **25**(5): p. 587-95.
52. Jacobi, H., et al., Inventory of Non-Ataxia Signs (INAS): validation of a new clinical assessment instrument. *Cerebellum*, 2013. **12**(3): p. 418-28.
53. Mlinac, M.E. and M.C. Feng, Assessment of Activities of Daily Living, Self-Care, and Independence. *Arch Clin Neuropsychol*, 2016. **31**(6): p. 506-16.

54. Schmitz-Hübsch, T., et al., SCA Functional Index: a useful compound performance measure for spinocerebellar ataxia. *Neurology*, 2008. **71**(7): p. 486-92.
55. du Montcel, S.T., et al., Composite cerebellar functional severity score: validation of a quantitative score of cerebellar impairment. *Brain*, 2008. **131**(Pt 5): p. 1352-61.
56. Schon, K., et al., Genotype, extrapyramidal features, and severity of variant ataxia-telangiectasia. *Ann Neurol*, 2019. **85**(2): p. 170-180.
57. Dürr, A., et al., Spinocerebellar ataxia 3 and Machado-Joseph disease: clinical, molecular, and neuropathological features. *Ann Neurol*, 1996. **39**(4): p. 490-9.
58. Maciel, P., et al., Correlation between CAG repeat length and clinical features in Machado-Joseph disease. *Am J Hum Genet*, 1995. **57**(1): p. 54-61.
59. Tesi, B., et al., Gain-of-function SAMD9L mutations cause a syndrome of cytopenia, immunodeficiency, MDS, and neurological symptoms. *Blood*, 2017. **129**(16): p. 2266-2279.
60. Rafehi, H., et al., An intronic GAA repeat expansion in FGF14 causes the autosomal-dominant adult-onset ataxia SCA50/ATX-FGF14. *Am J Hum Genet*, 2023. **110**(1): p. 105-119.
61. Salman, M.S., Epidemiology of Cerebellar Diseases and Therapeutic Approaches. *The Cerebellum*, 2018. **17**(1): p. 4-11.
62. Synofzik, M. and R. Schüle, Overcoming the divide between ataxias and spastic paraplegias: Shared phenotypes, genes, and pathways. *Mov Disord*, 2017. **32**(3): p. 332-345.
63. Jarvik, G.P. and B.L. Browning, Consideration of Cosegregation in the Pathogenicity Classification of Genomic Variants. *Am J Hum Genet*, 2016. **98**(6): p. 1077-1081.
64. Beaudin, M., et al., Characterization of the phenotype with cognitive impairment and protein mislocalization in SCA34. *Neurol Genet*, 2020. **6**(2): p. e403.
65. Ozaki, K., et al., A Novel Mutation in ELOVL4 Leading to Spinocerebellar Ataxia (SCA) With the Hot Cross Bun Sign but Lacking Erythrokeratoderma: A Broadened Spectrum of SCA34. *JAMA Neurol*, 2015. **72**(7): p. 797-805.
66. Mol, M.O., et al., Clinical and pathologic phenotype of a large family with heterozygous STUB1 mutation. *Neurol Genet*, 2020. **6**(3): p. e417.
67. Gorcenco, S., et al., Ataxia-pancytopenia syndrome with SAMD9L mutations. *Neurol Genet*, 2017. **3**(5): p. e183.
68. Gorcenco, S., et al., Oral therapy for riboflavin transporter deficiency - What is the regimen of choice? *Parkinsonism Relat Disord*, 2019. **61**: p. 245-247.
69. Roberts, J.S., A.K. Patterson, and W.R. Uhlmann, Genetic testing for neurodegenerative diseases: Ethical and health communication challenges. *Neurobiol Dis*, 2020. **141**: p. 104871.



## About the Author

---



Originally from Moldova, I lived in Romania and France before moving to Sweden to pursue a career in neurology and a Ph.D. in clinical neurology. I find joy and inspiration by spending time in breathtaking natural places when not at work. I recently became a specialist in neurology, which makes me proud but somewhat humbled by the responsibility. My research activity motivates me to continue learning about rare neurogenetic diseases, mainly hereditary ataxias, and I hope for many exciting discoveries.