

Under Water Discharge in Bubbles in Very Low Conductive Solutions

P. Vanraes¹, A. Nikiforov^{1,3}, Ch. Leys¹, L. Němcová^{1,2}, F. Krčma²

¹Department of Applied Physics, Ghent University, Jozef Plateaustraat 22, Gent 9000, Belgium

²Institute of Physical and Applied Chemistry, Brno University of Technology,
Purkyňova 118, Brno 612 00, Czech Republic

³Institute of Solution Chemistry RAS, Laboratory of Non-Linear Plasma Processes,
Academicheskaya, Ivanovo 153045, Russia

e-mail: xcnemcova@fch.vutbr.cz

Abstract

This contribution presents experimental results obtained with underwater electric discharge created in rising gas bubbles. This discharge configuration is relatively new, and combines both gas and liquid phase discharges. The properties and mechanism of bubble discharge generation were investigated using a single pulsed high voltage. The electric discharge was generated in a pin-to-plate electrode configuration submerged in deionized water with conductivity of 2.0–5.0 $\mu\text{S/m}$. The gas bubbles were formed by injecting the gas through a glass filter disc at the bottom of the water tank. Air and helium were used as inlet gas. A spark gap pulse generator triggered the single negative high voltage pulses with rise times below 10 ns and peak voltages of 15–20 kV. The bubble position at the moment of high voltage application was accidental. The measured spectra were qualitatively reproducible, but significant quantitative differences were observed. We observed two types of discharge inside the bubble: delayed and direct spark discharge. The emission spectra of these two discharge kinds were qualitatively very similar.

Keywords: Underwater discharge, bubble discharge, pulsed voltage, spectral characterization, electrical characterization.

Introduction

In the past few years, the scientific community has a high interest in underwater electric discharges, especially because of their possible versatile applications in practical life. A number of papers show their efficiency in different areas of human functioning – biology (extermination of microorganisms) [1], ecology, medicine (destruction of kidney stones by shock waves) [2], electrochemistry and also chemistry (degradation of dangerous toxic compounds in water) [3]. Application of electric discharges for water treatment is called AOP's technology (advanced oxidation processes). These methods seem to be promising answers for future problems concerning waste water. However, they are still more expensive than conventional waste water treatment technologies [4].

Electric discharge in liquid phase is generated by application of high electric energy into liquid medium. The electric energy is accumulated between two submerged electrodes, and consecutively electric discharge occurs. The energy which is supplied into the liquid phase causes the formation of a plasma channel in between the electrodes where highly reactive particles are generated. For water treatment, the most important of these particles are hydroxyl radicals and hydrogen peroxide because they efficiently oxidize harmful compounds in water due to their short lifetime [5–7]. Moreover, the generated strong electric field, shock waves, UV radiation and ozone (in case when oxygen is presented) induces the synergetic effect.

Three kinds of electrode configuration are common for the discharge breakdown in liquid phase. The first configuration consists of two parallel plane electrodes (Figure 1a), the second one is pin-to-plate configuration (Figure 1b) and the third configuration is available for the so called diaphragm discharge (Figure 1c); in the latter, a dielectric plate with a small hole is placed in between two electrodes. The high voltage applied to the electrodes can be DC, AC, HF or pulsed voltage. This contribution is focused on the pin-to-plate electrode configuration. The intensity of the electric field is accumulated on the top of the pin electrode.

In spite of increased research in this area of plasma physics, there is only very limited knowledge about the initiating mechanism and development of plasma discharges in pure water. One proposed theory says that plasma is created in water by means of bubble generation due to heating of the water.

Beside this, an alternative approach is to introduce gas or vapor bubbles in between the electrodes submerged in water in order to generate plasma inside the bubbles. The mechanism of this discharge, so-called bubble discharge, is poorly understood as well. We would like to fill this gap in understanding by researching pulsed plasma discharge in free rising bubbles in water.

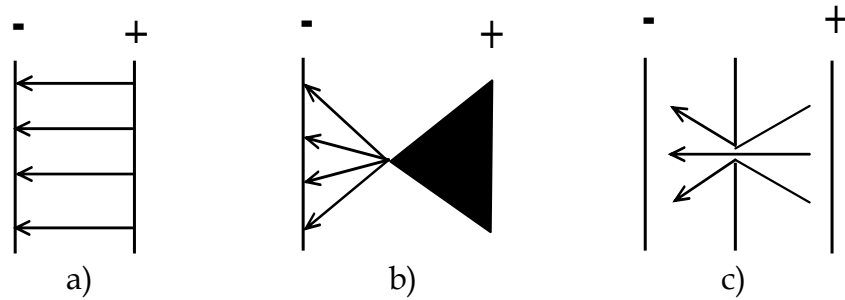

Fig. 1. Possible electrode configurations for the underwater discharge creation: a) two plane electrodes, b) pin-to-plate, c) dielectric diaphragm with a small hole in between the two electrodes. The arrows correspond to the electric intensity vector.

Experimental technique

The principal scheme of the set-up for the underwater discharge generation in gas bubbles is presented in Fig. 2. The discharge reactor consists of a discharge chamber (solution volume is 3.6 l). The distance between the pin electrode and the plate electrode is 6 mm. Both electrodes are made of stainless steel. The plate electrode (with a diameter of 3 cm) is grounded. The pulsed negative high voltage has been supplied on the pin electrode, which is 4 mm in length and has the shape of a right circular cone with an aperture of 10° . The helium and air are injected into the water at the bottom of the water tank underneath the electrodes through a glass filter disc in order to produce multiple bubbles. The filter disc was made by ROBU (standard filter with a diameter of 40 mm, a thickness of 4.5 mm and porosity class 3). The gas flow of 1.4 slm has been regulated by a mass flow control system (MSK 4000). The multiple bubbles are estimated to be approximately 2 mm in diameter. The pulsed high voltage with rise times below 10 ns has been applied to the pin in parallel with a resistor of 1 M Ω . The optical emission spectra were measured with an Ocean Optics HR2000 spectrometer.

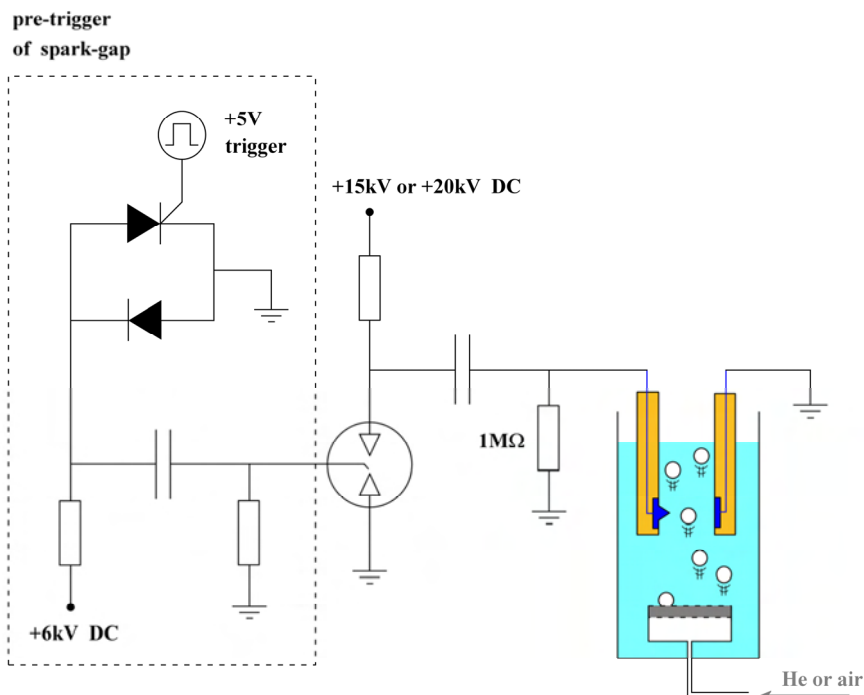

Fig. 2. Scheme of experimental set-up.

Results and discussion

The electric discharge was generated after applying pulsed high voltage to the system while gas was bubbling. It was found that two kinds of discharges in bubbles are generated: delayed and direct spark discharge. The main difference between these discharges is demonstrated in Figs. 3, and 4. The delay between the start of the high voltage pulse and the start of the discharge inside the bubble varied in wide range from very small delays of less than one hundred nanoseconds to more than ten microseconds. The electric characterization of discharge generated without bubbles is shown in Fig. 5.

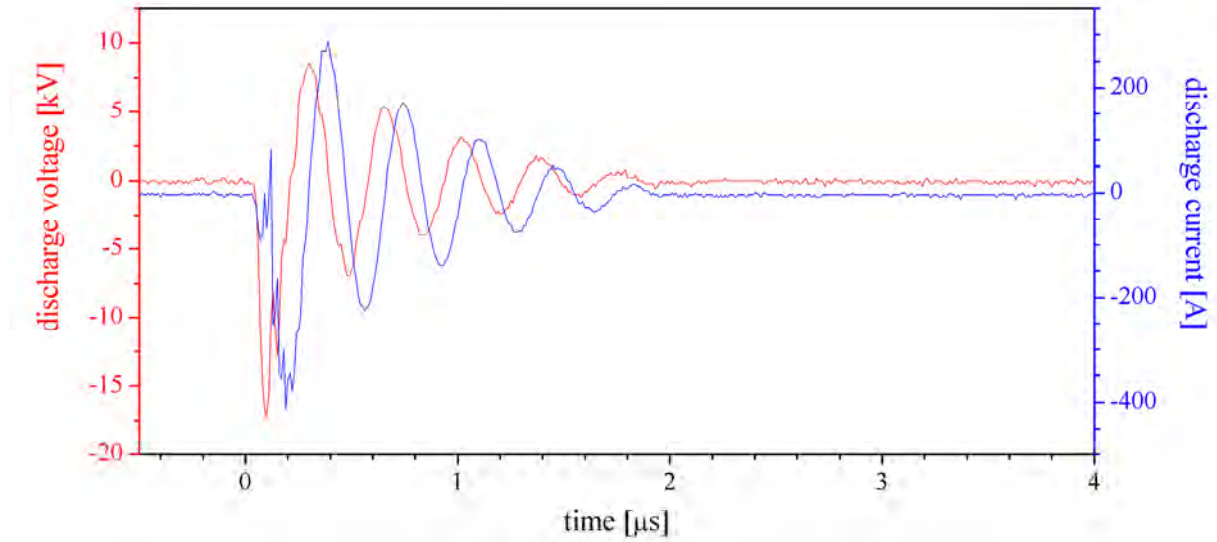

Fig. 3. The current and voltage waveforms of direct spark discharge in air bubbles (applied voltage of 20 kV).

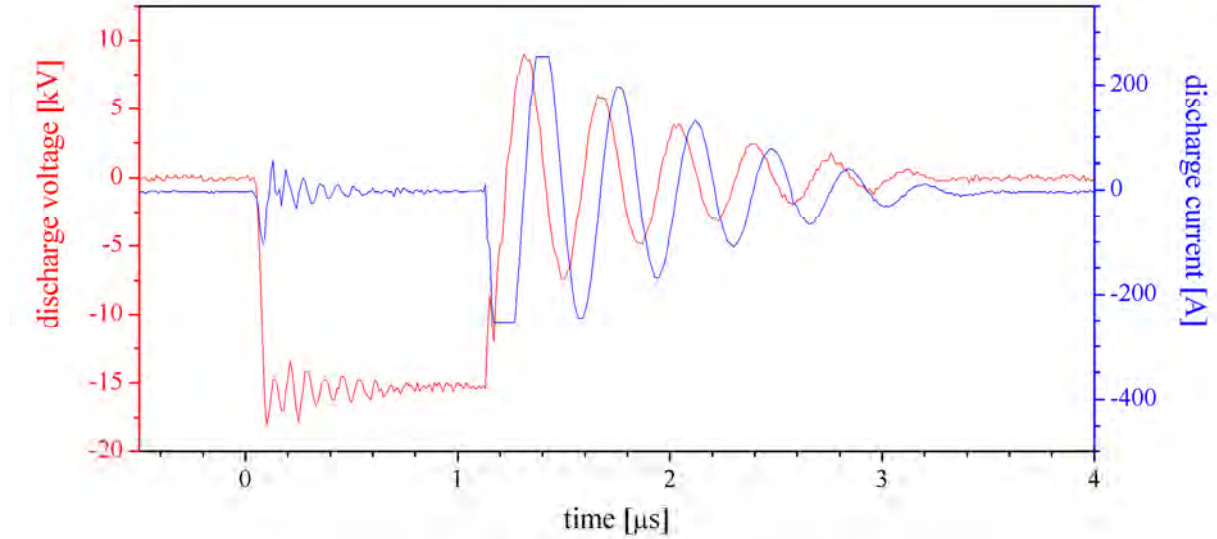

Fig. 4. The current and voltage waveforms of delayed spark discharge in air bubbles (applied voltage of 20 kV).

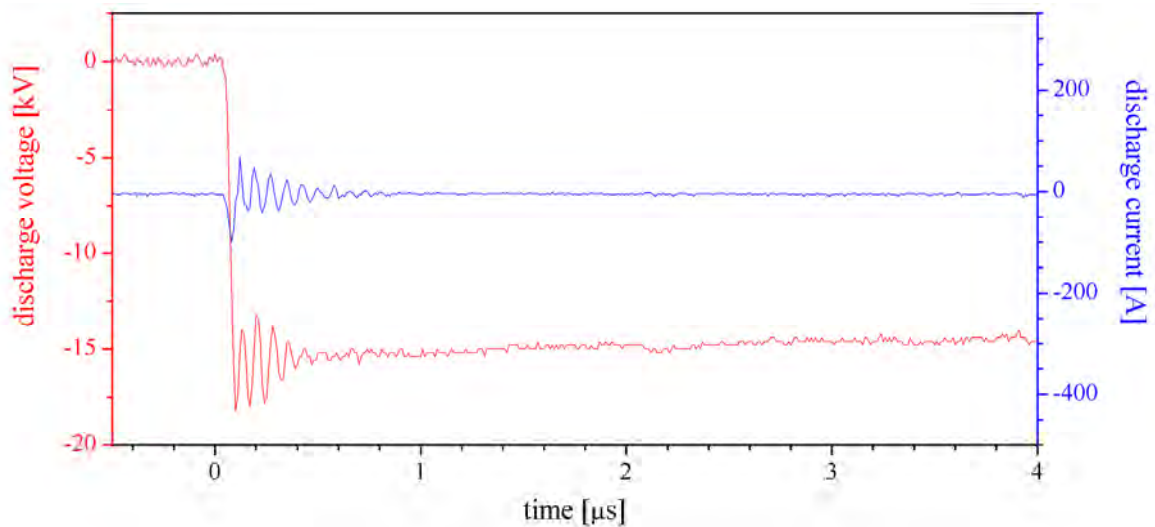

Fig. 5. The current and voltage waveforms of discharge without bubbles (applied voltage of 20 kV).

Examples of optical emission spectra recorded for discharge inside an air bubble at 15 kV are shown in Figs. 6–7 for both discharge kinds at two applied voltages. The most obvious lines are from hydrogen, oxygen, and lines corresponding to the bubbling gas (i.e. helium or nitrogen in case of helium or air bubbles, respectively). The OH radical bands that are usually observed in underwater discharges [8] were not observed. On the other hand, some small peaks of nickel and chromium were recorded because of erosion of the stainless steel electrodes. Spectra of both discharges are qualitatively similar, but the line intensities significantly differ. These differences are probably due to the difference of bubble position at the moment of the discharge, as they are also observed for two different direct spark discharges with the same experimental settings. Changing the value of the applied voltage had a similar effect: the same spectral lines have been observed, but their intensities were not reproducible.

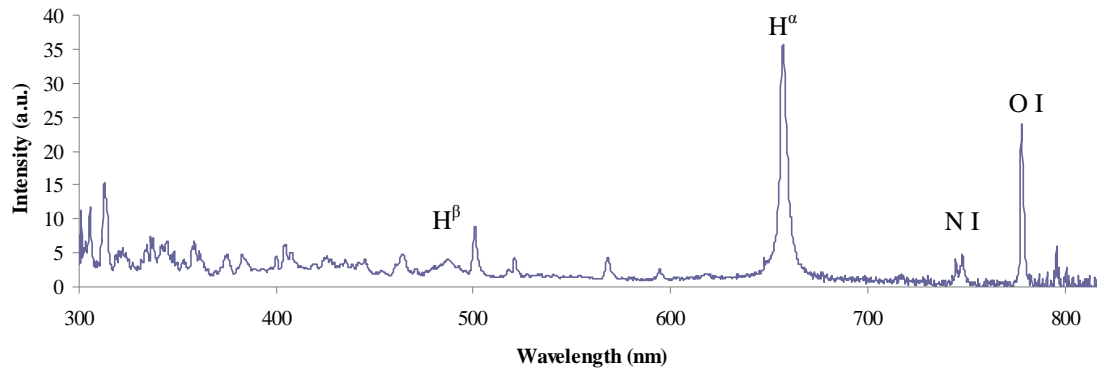

Fig. 6. The spectrum of delayed spark discharge in air bubbles (applied voltage of 15 kV).

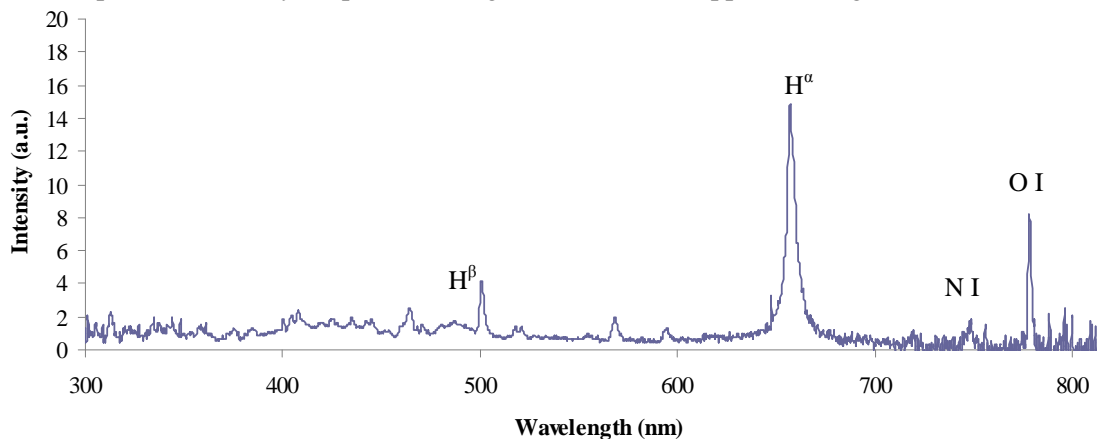

Fig. 7. The spectrum of direct spark discharge in air bubbles (applied voltage of 15 kV).

Conclusions

Two different types of bubble discharge were observed: direct and delayed spark discharge inside the bubble. This is expected to be due to the variable position of the bubble during the high voltage application. The delay between direct and delayed discharge is expected to be dependent on this position. Further experiments using also a fast camera will be used for this hypothesis confirmation. The hydrogen and oxygen lines are dominant in the spectra. The lines of the most common species present in the bubbling gas (neutral nitrogen atomic lines in case of air, neutral helium lines in case of helium) were recorded, too. Besides them, some weak lines of elements originating from the electrodes were recognized, but no OH bands were found. Spectra of bubble discharge are qualitatively reproducible for the same experimental settings, and they do not change qualitatively when the applied voltage increases. The differences in the spectra of bubble discharge for the same peak voltage and the same bubbling gas for direct spark discharge inside the bubble are expected to be due to the variable position of the bubble during discharge.

Acknowledgement

This work was done as part of 'Plasma Generation' (WPKI) in the framework of the Interuniversity attraction poles program, Belgian state - Belgian Science Policy, and it was partially supported by Czech Ministry of Education, Youth and Sports, research plan No. 0021630501.

References

- [1] A.M. Anpilov, et al., *Lett. Appl. Microbiol.* 35 (2002) 90.
- [2] Ch. Chaussy, W. Brendel, and E. Schmiedt., *Lancet* 2, (1980) 1265.
- [3] A. Brablec., P. Slavíček., P. Stáhel., T. Čimžmár, and D. Trunec., *Czech. J. Phys.* 52 (2002) 491.
- [4] K. Sato, K. Yasuoka, and S. Ishii., *Electric. Eng. Japan* 170 (2010) 1.
- [5] T. Miichi., N. Hayashi., S. Ihara., S. Satoh, and Ch. Yababe., *Rep. Fac. Sci. Eng., Saga Univ.* 31 (2002) 1.
- [6] A. Yamatake., H. Katayama, K. Yasuoka, and S. Ishii., *Int. J. Plasma Environ. Sci. Technol.* 1 (2007) 1.
- [7] S. Ihara., T. Miichi., S. Satoh., Ch. Yamabe, and E. Sakai., *J. Appl. Phys.* 38 (1999) 4601.
- [8] J. Procházková, Z. Stará, and F. Krčma, *Czech. J. Phys.* 56 (2006) B1314.