

Marine macroalgae are a prolific source of pharmacologically important secondary metabolites. However, many species used in pharmacognosy and in biomedical experiments are severely understudied biologically. *Portieria*, an Indo-Pacific red seaweed, is one of those understudied species found to harbor an abundance of halogenated monoterpenes. Halomon, a halogenated monoterpene with anti-tumor properties has been isolated in a *Portieria* population in Batanes, Philippines. Unfortunately, the absence of sufficient biological knowledge about *Portieria* has placed halomon in a drug development bottleneck. The motivations for this thesis are to test the hypotheses that the variation in halomon content among *Portieria* populations could be due to cryptic diversity, seasonality or geographical variation on the secondary metabolite production. Given these three conditions: differential production of pharmacologically important monoterpenes, lack of biological knowledge on *Portieria*, and the possibility of the presence of cryptic species, this thesis specifically aimed to examine cryptic diversity in *Portieria*; determine how this genetic diversity is expressed on the phenotypic level (morphology and chemistry) and in doing so determine the role of cryptic diversity, life-history stages, seasonality and geographical location on the differential production of secondary metabolites.

## Diversity of the marine red alga *Portieria* in the Philippines, an integrative approach



Diversity of the marine red alga *Portieria* in the Philippines, an integrative approach

Dioli Ann Payo

2011

Dioli Ann Payo

**Diversity of the marine red alga *Portieria*  
in the Philippines,  
an integrative approach**

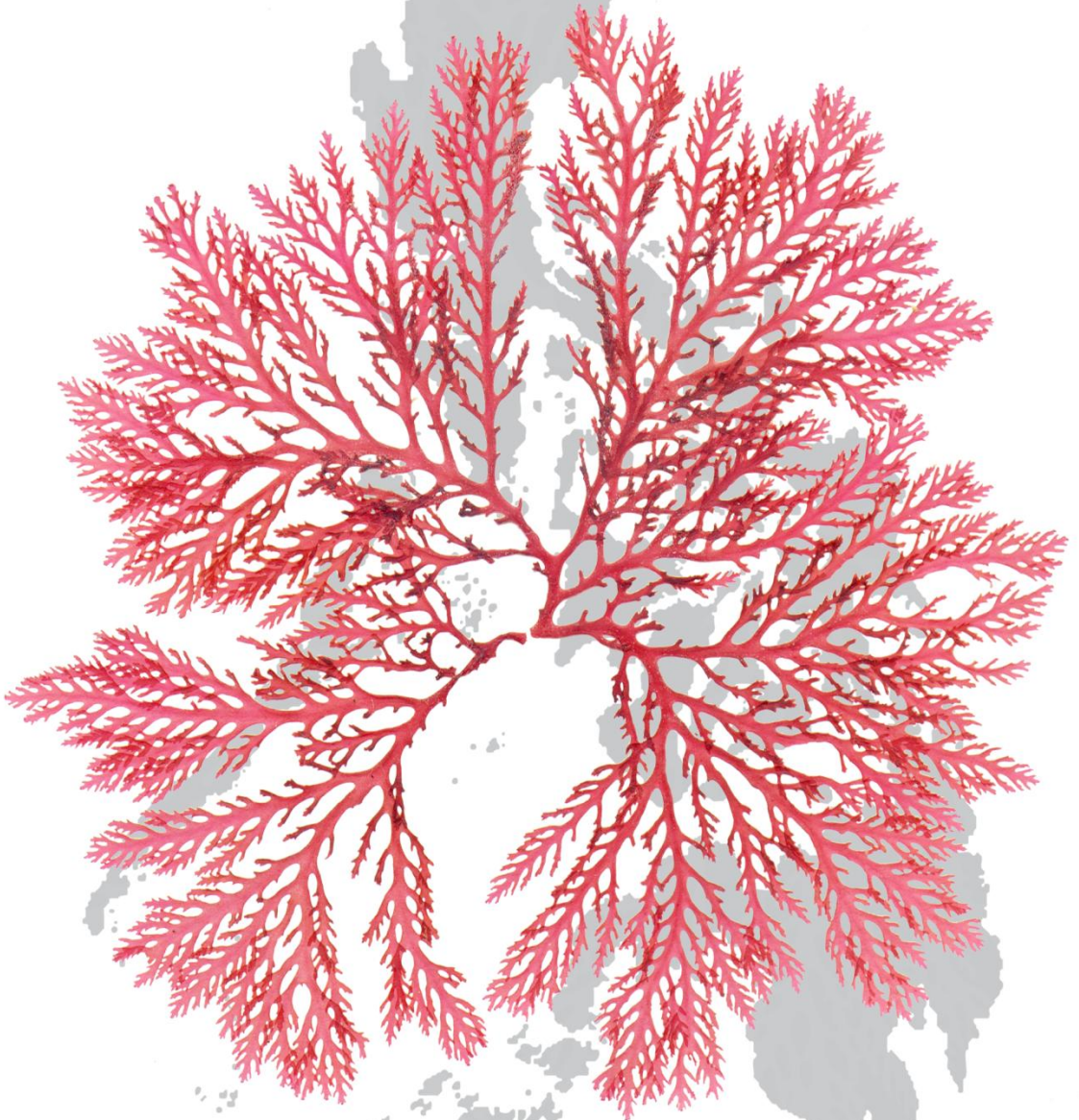

**Dioli Ann Payo**



Ghent University  
Faculty of Sciences, Department of Biology  
Phycology Research group

# Diversity of the marine red alga *Portieria* in the Philippines, an integrative approach

**Dioli Ann Payo**

Promotor: Prof. Dr. O. De Clerck

Thesis submitted in partial fulfillment

Co-Promotors: Prof. Dr. H. Calumpong

of the requirements for the degree of

Dr. F. Leliaert

Doctor (PhD) of Sciences (Biology)

26 September 2011



# EXAM COMMITTEE

---

---

## Members of the reading committee

Dr. Line Le Gall (Muséum National d'Histoire Naturelle, Paris)

Prof. Dr. Ludwig Triest (Vrije Universiteit Brussel)

Dr. Yves Samyn (Koninklijk Belgisch Instituut voor Natuurwetenschappen)

## Members of the examination committee

Prof. Dr. Dominique Adriaens (Chairman Pre-Defense, Ghent University)

Prof. Dr. Koen Sabbe (Chairman Public Defense, Ghent University)

Prof. Dr. Olivier De Clerck (Promotor, Ghent University)

Prof. Dr. Hilconida Calumpang (Co-Promotor, Silliman University, Philippines)

Dr. Frederik Leliaert (Co-Promotor, Ghent University)

Prof. Dr. Annemieke Verbeken (Ghent University)

Dr. Heroen Verbruggen (Ghent University)

---

The research reported in this thesis was funded by the Flemish Interuniversity Council (VLIR) and the Global Taxonomy Initiative, Royal Belgian Institute of Natural Sciences. This was performed at the Phycology Research Group ([www.phycology.ugent.be](http://www.phycology.ugent.be)) and at the Institute of Environment & Marine Sciences, Silliman University, Philippines.



## ACKNOWLEDGEMENTS

---

First of all, I would like to acknowledge the people who made it possible so I could start with this PhD project on *Portieria*. It all started from **Prof. Olivier De Clerck**'s discussion with **Prof. John West** about this alga. Next thing that happened was the endorsement of Prof. West and **Prof. Lawrence Liao** of my application for VLIR PhD scholarship. **Prof. Dr. Eric Coppejans** has supported my PhD application and has always welcomed me in his lab since 2003 when I started to work on *Dictyota*. A good number of Prof. Coppejans' *Portieria* collections had been included in this work.

I would also like to thank my co-promoter in the Philippines **Prof. Dr. Hilconida Calumpong**, for her confidence in me. Despite of not knowing me in 2005, she accepted my proposal and supported my PhD scholarship application. Prof. Calumpong's support on this research ranged from advice on experimental design and field work, reserving an exclusive room and an outdoor space for my experimental work at the Silliman laboratory, and reviewing my manuscript drafts. Prof. Calumpong also gave me opportunities for exposure by inviting me to present during the Friday laboratory meetings. I would also like to mention the help extended by her entire staff, especially **Jacinta Lucañas**, **Julieta Echaves** and Mrs. **Pacita Raterte** for lab equipment and research fund concerns, and the generally friendly lab atmosphere created by her entire staff and PhD students. **Annalie Candido**, **Rio Naguit**, **Wilson Tisera**, **Amida Diwata Macansantos** also helped to collect *Portieria* at Apo Island, Bunaken Island, Indonesia, and Spratley Islands. **Zaccharias "Nong Iyas" Generoso** has been a great assistance in the field, in my grazing experiments and who entertained me with his amusing field research stories in the old days. I am also indebted to **Abner Bucol** who assisted me for two years even during rough seas in my monthly surveys in Siquijor and Siaton and during my first trip to Batanes. Apart from allowing me to hire their boats, keen **fishermen from Siquijor** suggested good sites for *Portieria*. Some friends from college and NGO days also got dragged into this affair of collecting *Portieria*, like **Rey Ladio**, **Florabel Fumar**, **Bernie Calañajan**, **William Villaver**, **Peddy Caet** and **Nonoy of Liloan, Cebu**. Thanks are also due to Basco, Batanes **Mayor Manuel Viola** who forwarded my letter of intent to collect to the Municipal Environment Officer, **Francis Domingo**, who in turn assisted during the Batanes collections.

Generous phycologists from different institutions have also enriched the number of my samples such as **Alison Sherwood**, **Tom Cowling**, **Max Hommersand**, **Willem Prud'homme Van Reine**, **Stefano Draisma**, **Tom Schils**, **Diane** and **Mark Littler**. **David Reid Wiseman** generously sent a copy of his PhD thesis of 1973 on *Ochtodes* and *Chondrococcus*.



In Ghent, despite of all the scheduling difficulties and the technical troubles, **Renaat Dasseville** made it possible that I could use the GC-MS. I am also indebted to him for the GC-MS knowledge that he imparted. **Joannamel Colo**, the Ecomama thesis student I supervised, performed the traditional measurements on *Portieria* and also a portion of the chemical work. **Frederic Lynen** of the chemistry department also welcomed me in his lab and allowed me to use HPLC and GC-MS machines during the exploratory period of my *Portieria* extracts.

I am also sincerely thankful to all the members of the **Phycology Research Group** for the generosity with their time, knowledge and all the help of any form extended to me during my PhD years. My DNA extraction, PCR and DNA sequencing work had been greatly assisted by **Caroline Vlaeminck** and **Sofie D'hondt**. **Klaas Pauly** and **Heroen Verbruggen** have also contributed to my *Portieria* samples. Special thanks are also due to the members of the brainstorming team who helped shape the direction of the molecular aspect of this research composed of **Heroen Verbruggen**, **Frederik Leliaert** and **Olivier De Clerck**. I greatly appreciate the administrative help provided by **Christelle Vankerckhove** but most of all her kindness, warmth and motherly demeanor. I shall also thank **Agnieszka Lipinska**, **Frédérique Steen**, and **Ana Tronholm**, my lab roommates, for bringing fun and the wonderful and comforting conversations.

I greatly appreciate all the kindness and help in the analyses and manuscript writing of my co-promoter **Frederik Leliaert**, from whom I learned a lot. I admire his effective way of transferring knowledge. Finally, I am greatly indebted to my promoter, **Olivier De Clerck** for believing that I can do a PhD, for all these learning opportunities (too many to mention) that he made possible for me, the supervision since my master's thesis period (which resulted to a best thesis award from VLIZ), during the thesis proposal writing and for always pushing me to do better. I appreciate the keenness he gave in every aspect of my work and also that "hands-on" training. I leave my sincerest thanks to these promoters and will take with me all the lessons I have learned from them here in Ghent.

I thank my **thesis committee** for the academic dedication exercised on reviewing the pre-defense version of this manuscript. It has made me realize the important role of a critique committee in improving the quality of an academic work.

*Portieria* research would not have been possible without the PhD scholarship provided by the **Flemish Interuniversity Council (VLIR)** from 2006 to 2010. VLIR also funded my scholarship for a master's degree in Ecological Marine Management at the Free University of Brussels (VUB) from 2002 to 2004. The **Global Taxonomy Initiative** under the Royal Belgian Institute of Natural Sciences came to the rescue through **Dr. Yves Samyn** by providing fund for my trip back to and living allowance in Belgium in 2011.

**Claire Van Maercken**, my landlady of four years in Ghent, deserves sincere appreciation for a service to foreign students, homely accommodation and the conversations. My **family** gave inspiration and extended much needed help during the sampling and labwork in Silliman.

-D.A. Payo-

September 2011

Ghent, Belgium

*This academic work was performed in collaboration with Silliman University – Institute of Environmental and Marine Studies, Filipino biologists and locals of sampling sites in the Philippines. Prior informed consent was obtained from the mayor and the municipal environment natural resources officer of Basco. Portieria species have no economic value and are not classified by CITES (IUCN) as threatened or endangered. Export permit has been granted by the Bureau of Fisheries and Aquatic Resources. All other Indo-Pacific specimens have been generously donated by phycologists from different institutions.*



# CONTENTS

---

Exam Committee.....	ii
Acknowledgements .....	iv
Contents.....	viii
Abbreviations and Acronyms .....	xii
List of Tables.....	xiv
List of Figures .....	xvi
1 General introduction.....	1
1.1 Marine biodiversity and secondary metabolites .....	1
1.2 <i>Portieria</i> : a taxonomic perspective.....	5
1.3 <i>Portieria bornemannii</i> .....	7
1.4 Cryptic species diversity.....	10
1.4.1 Species delimitation approaches .....	12
1.4.2 Molecular markers.....	14
1.5 Temporal and geographic variation in secondary metabolites .....	14
1.6 Aims and outline of this thesis .....	15
1.7 Author contributions .....	17
1.8 References.....	19
2 Morphology, vegetative and reproductive development of the red alga <i>Portieria</i> (Gigartinales: Rhizophyllidaceae) <sup>1</sup> .....	23
Abstract.....	23
2.1 Introduction.....	24
2.2 Materials and methods .....	25
2.2.1 Morphological analysis .....	25
2.2.2 Molecular analysis .....	26
2.3 Results.....	27
2.3.1 <i>Portieria</i> .....	27
2.3.2 Description.....	27
2.3.3 Reproductive morphology.....	31
2.3.4 Molecular phylogenetics.....	35
2.4 Discussion.....	38

2.5	Acknowledgements .....	40
2.6	References .....	41
3	The red algal genus <i>Portieria</i> in the Philippines: species delimitation and diversity pattern <sup>1</sup> .....	45
	Abstract .....	45
3.1	Introduction.....	46
3.2	Materials and methods .....	49
3.2.1	Taxon sampling .....	49
3.2.2	DNA sequencing and alignment .....	49
3.2.3	Species delimitation and phylogeny .....	57
3.2.4	Species ranges and total species richness .....	60
3.3	Results.....	61
3.3.1	Single locus GMYC approach.....	61
3.3.2	Multilocus species delimitation .....	63
3.3.3	Species richness and distributions .....	67
3.4	Discussion.....	70
3.4.1	Species delimitation .....	70
3.4.2	Diversity and conservation.....	72
3.5	Acknowledgements .....	74
3.6	References .....	75
4	Evolution of the red seaweed <i>Portieria</i> in the tropical Indo-Pacific <sup>1</sup> .....	79
	Abstract .....	79
4.1	Introduction.....	80
4.2	Materials and methods .....	82
4.2.1	Taxon sampling .....	82
4.2.2	DNA extraction, amplification and sequencing.....	82
4.2.3	DNA-based species delimitation .....	83
4.2.4	Phylogenetic analysis .....	84
4.3	Results.....	85
4.3.1	Species diversity and geographical distribution.....	85
4.3.2	Species-level phylogeny.....	88
4.4	Discussion.....	90
4.4.1	Diversity, distribution and endemism.....	90
4.4.2	Evolutionary history of <i>Portieria</i> in the Indo-Pacific.....	92
4.5	Conclusions .....	94

4.6	Acknowledgements .....	95
4.7	Supplementary figures.....	96
4.8	Supplementary tables .....	99
4.9	References.....	111
5	Morphometric characterization of the <i>Portieria</i> -complex in the Philippines <sup>1</sup> .....	115
	Abstract.....	115
5.1	Introduction.....	116
5.2	Materials and methods.....	117
	5.2.1 Specimen sampling, image preparation and acquisition .....	117
	5.2.2 DNA-based species assignment .....	121
	5.2.3 Fractal analysis.....	121
	5.2.4 Conventional morphometric measurements .....	123
	5.2.5 Statistical analyses.....	125
5.3	Results.....	125
	5.3.1 Phylogenetic Analyses .....	125
	5.3.2 Form variation between genetic clusters .....	127
5.4	Discussion.....	138
5.5	Acknowledgements .....	139
5.6	References.....	141
6	Variability of non-polar secondary metabolites in the red alga <i>Portieria</i> <sup>1</sup> .....	143
	Abstract.....	143
6.1	Introduction.....	144
6.2	Materials and methods.....	146
	6.2.1 Collection and Storage .....	146
	6.2.2 Extraction.....	147
	6.2.3 Phylogenetic Analysis.....	149
	6.2.4 Metabolite analysis, data processing and multivariate analysis ..	149
6.3	Results.....	151
	6.3.1 Delimitation of species.....	151
	6.3.2 Identification of compounds in non-polar extracts.....	151
	6.3.3 Metabolite Fingerprinting .....	153
6.4	Discussion.....	163
6.5	Acknowledgements .....	165
6.6	References.....	167
6.7	Supplementary tables .....	170

7	Seasonal dynamics of <i>Portieria</i> populations in the Philippines <sup>1</sup> .....	185
	Abstract .....	185
	7.1 Introduction.....	186
	7.2 Materials and methods .....	187
	7.2.1 Study sites.....	187
	7.2.2 Sampling.....	188
	7.2.3 Statistical analyses.....	189
	7.3 Results.....	189
	7.3.1 Biophysical parameters.....	189
	7.3.2 Density, cover and biomass.....	191
	7.3.3 Thallus height .....	196
	7.3.4 Reproductive thalli.....	199
	7.4 Discussion.....	199
	7.5 Acknowledgements .....	201
	7.6 References .....	203
8	General discussion .....	205
	8.1 Seaweed species diversity: the red alga <i>Portieria</i> as a case study.....	205
	8.1.1 Importance of correctly delimiting species .....	205
	8.1.2 Species concepts and species delimitation .....	205
	8.1.3 DNA-based species delimitation .....	206
	8.1.4 Cryptic diversity.....	208
	8.1.5 Unveiling cryptic diversity in <i>Portieria bornemannii</i> .....	208
	8.2 Diversity and evolution of marine Indo-Pacific species.....	211
	8.2.1 Macroalgal diversity in the Philippines .....	211
	8.2.2 Speciation within the Philippines .....	212
	8.2.3 Natural product variability in macroalgae .....	214
	8.3 Future prospects .....	215
	8.4 Taxonomic implications .....	217
	8.5 Significance of the study in the Philippine setting.....	219
	8.6 Conclusions .....	219
	8.7 References.....	223
	Summary .....	229
	Samenvatting.....	233
	Curriculum vitae.....	237

## ABBREVIATIONS AND ACRONYMS

---

AIC.....	Akaike Information Criterion
BEAST.....	Bayesian Evolutionary Analysis by Sampling Trees
BI.....	Bayesian Inference
BP&P.....	Bayesian Phylogenetics and Phylogeography
CI.....	Confidence Interval
CM.....	Conventional Morphometric Analysis
COX.....	Cytochrome Oxidase
CV.....	Coefficient of Variation
DA/DFA.....	Discriminant Function Analysis
D <sub>B</sub> .....	Box Counting Dimension
DCM.....	Dichloromethane
EF2.....	Elongation Factor 2
FA.....	Fractal Analysis
GC-MS.....	Gas Chromatography-Mass Spectrometry
GMYC.....	General Mixed Yule Coalescent Model
GTR.....	General Time Reversible Model
GTR + I + G.....	GTR model with a proportion of Invariant sites and Gamma distributed rate heterogeneity
HPD.....	Highest Posterior Density
ILS.....	Incomplete Lineage Sorting
IMA.....	Indo-Malay Archipelago
IWP.....	Indo-West Pacific
KI.....	Kovats Index
LR.....	Likelihood Ratio
LSU nrDNA.....	Large Subunit of the Nuclear Ribosomal RNA Gene
matK.....	Megakaryocyte-Associated Tyrosine Kinase Gene
MCMC.....	Markov Chain Monte Carlo
ML.....	Maximum Likelihood
Ma.....	Million Years Ago
NCI.....	National Cancer Institute
nrDNA.....	Nuclear Ribosomal RNA Gene
PCA.....	Principle Component Analysis
PCR.....	Polymerase Chain Reaction
PP.....	Posterior Probability
PSR.....	Phylogenetic Species Recognition
<i>rbL</i> .....	Ribulose-1,5-bisphosphate carboxylase oxygenase
.....	Large Subunit
<i>rbS</i> .....	Ribulose-1,5-bisphosphate carboxylase oxygenase
.....	Small Subunit
rjMCMC.....	Reversible Jump Markov Chain Monte Carlo
SE.....	Standard Error
SPE.....	Solid Phase Extraction
tRNA.....	Transfer RNA
UCLN.....	Uncorrelated Lognormal
Λ.....	Lacunarity





# LIST OF TABLES

---

Table 2.1. List of specimens used in morphological analyses. ....	28
Table 2.2. List of species used in the <i>rbcL</i> and LSU nrDNA analyses with accession numbers. ....	37
Table 3.1. Specimens used in the phylogenetic analysis with indication of their identity, herbarium number (Voucher) and collecting information. ....	51
Table 3.2. List of genes sequenced and primer sequences and amplification conditions used. ....	57
Table 3.3. Lineage branching patterns fit to single- and multiple-threshold variants of the GMYC model. Model outputs include the threshold genetic distance from the branch tips where transition occurred (T, presented for single-threshold models), the number of putative species as the sum of sequence clusters and singletons (NGMYC), and confidence intervals (CI). Likelihoods are presented for null (L0) and GMYC (LGMYC) models, where null likelihoods are the same for single and multiple threshold model comparisons. Significance of the likelihood ratio (LR) was evaluated using a $\chi^2$ test with 3 degrees of freedom to compare GMYC and null models. * $p < 0.001$ . ....	61
Table 3.4. Occurrence of 21 <i>Portieria</i> species in the Philippines. Species collected from a single site only are indicated in bold. Numbers indicate the number of specimens collected from each site. ....	68
Table 5.1. List of <i>Portieria</i> specimens used in fractal (FA) and conventional morphometric (CM) analyses. DNA sequences of the <i>cox2-3</i> gene were also obtained from the samples. The symbol (*) indicates presence of data or availability of a sequence. ....	118
Table 5.2. Definition of fractal and FraCLac-derived (non-conventional) parameters. ....	122
Table 5.3. Definition of conventional measurements. ....	124
Table 5.4. Summary of the Stepwise Discriminant Function Analysis of fractal and non-conventional parameters showing the independent contributions of each variable to the overall discrimination of groups. Wilks lambda values ranges from 0.0 (indicating perfect discriminatory power) to 1.0 (indicating the absence of discriminatory power). Partial Wilks' Lambda indicates for the unique contribution of a variable to group discrimination. The lower the value of Partial Wilks', the greater is the unique discriminatory power of the respective variable. ....	130
Table 5.5. Standardized b coefficients derived from canonical analysis of fractal and non-conventional variables, showing the optimal combination of variables so that the first function provides the most overall discrimination between groups. The larger the standardized b coefficient, the larger the respective variable's unique contribution to the discrimination specified by the respective discriminant function. ....	131
Table 5.6. Means of canonical variables (from canonical analysis of fractal and non-conventional variables) indicating which groups are best distinguished in each function or root. ....	131
Table 5.7. Classification matrix (from DA of fractal and non-conventional variables) indicating the percentage of cases correctly classified for each group when a priori classification probabilities are the same for all groups. ....	133
Table 5.8. Means of the 25 conventional measurements measured. Length and width measurements are in mm. ....	134
Table 5.9. Summary of the Stepwise Discriminant Function Analysis of conventional parameters showing the independent contributions of each variable to the overall discrimination of groups. ....	135
Table 5.10. Standardized b coefficients derived from canonical analysis of conventional variables, showing the optimal combination of variables so that the first function provides the most overall discrimination between	

groups. The larger the standardized  $b$  coefficient, the larger is the respective variable's unique contribution to the discrimination specified by the respective discriminant function. ....136

Table 5.11. Means of canonical variables (conventional) indicating which groups are best distinguished in each function or root composed of conventional variables. ....136

Table 5.12. Classification matrix (from DA of conventional variables) indicating the percentage of cases correctly classified for each group when a priori classification probabilities are the same for all groups. ....136

Table 5.13. Classification matrix derived from combined variables indicating the percentage of cases correctly classified for each group when a priori classification probabilities are the same for all groups. ....137

Table 6.1. Frequency of compounds that are unique to or common to several species of *Portieria* found in Batanes. Values in parenthesis indicate total number of compounds found in a species, while 1 indicates presence and 0 absence of a compound. ....158

Table 6.2. Compound peaks detected from GC-MS analysis of samples used for evaluation of temporal and spatial patterns of non-polar metabolites of 3 cryptic species of *P. bornemannii* found in the Visayas. Identifications based on comparison of either Kovats Indices (KI) of compounds retrieved from the Retention Index Calculator (Lucero et al. 2009) or mass spectral comparison of compounds retrieved from NIST or MassBase. Asterisk (\*) indicates compounds with parent ions showing halogenated mass spectral patterns. ....160

## LIST OF FIGURES

- Fig. 1.1. Cyclic and acyclic halogenated monoterpenes isolated from *Portieria bornemannii* (adapted from Fuller et al. 1992 and Andrianasolo et al. 2006). Halomon has been found to have specific cytotoxicity towards a broad range of tumor cells. Compounds 1-4 were isolated from *Portieria* populations in Batanes, Philippines. Compounds 1 and 5-8 were extracted from Madagascar specimens. .... 2
- Fig. 1.2. Marine drug-producing invertebrates (adapted from Molinski et al. 2008) (a) Textile cone snail *Conus magus* is the source of anti-chronic pain Ziconotide (Prialt; Elan Pharmaceuticals) (Photo credit: Alan J. Kohn). (b) The Caribbean sea-squirt *Trididemnum solidum* is the source of the antitumor compound Trabectedin (Molinski et al., 2008). .... 3
- Fig. 1.3. Distribution of natural products obtained from marine organisms based on a study in 2002 (adapted from Blunt et. al 2004). .... 3
- Fig. 1.4. Biogenetic scheme for the origin of marine algal monoterpenes involving bromonium or chloronium ion-initiated additions and cyclizations (adapted from Wise et al. 2002) ..... 4
- Fig. 1.5. Distribution of *Portieria* in the Indo-Pacific (violet– *P. bornemannii*, orange– *P. spinulosa*, red – *P. japonica*, blue – *P. tripinnata*, green – *P. harveyii*). Distribution patterns are based on unverified literature reports listed in Algaebase (Guiry and Guiry, 2011). .... 7
- Fig. 1.6. Gross morphology and morphological variation of *Portieria*. (a) Underwater photograph of *P. bornemannii* from South Africa (Photo credit: O. De Clerck). (b) Habit *in situ* of *P. bornemannii* from Sri Lanka (Photo credit: Olivier Dargent in Coppejans et al., 2009). (c-d) Pressed herbarium specimen from Kwazulu-Natal, South Africa. (e) Fresh specimen from Siquijor, Philippines. (f) Fresh specimen from Batanes, Philippines. (g) Fresh specimen from Guianan, Eastern Samar, Philippines (Photo credit: R. Ladio). (h) Fresh specimen from Batanes, Philippines. 8
- Fig. 1.7. Tri-phasic life-history of *Portieria*. .... 9
- Fig. 1.8. Possible scenarios of morphological convergence and variation confounding species delimitation (adapted from Cianciola et. al. 2010). (a) Scenario in which morphology is congruent with molecular data. (b) Convergent morphological evolution of distantly related species. (c) Convergent evolution scenario is observed in species that exhibit large degree of environmentally-influenced morphological plasticity. .... 10
- Fig. 2.1. General morphology of *P. bornemannii*. Scale bar: 10mm. (a) DAP703, Dapdap, Siquijor, Siquijor. (b) Sawang, Siquijor. (c) DAP337, White Beach, Mahatao, Batanes (d) DAP345, White Beach, Mahatao, Batanes (e) DAP368, Chanaryan, Basco, Batanes (f) DAP336, White Beach, Mahatao, Batanes. .... 29
- Fig. 2.2. Vegetative morphology of *P. bornemannii*. (a) Typically inrolled tip of a major axis. Scale bar: 100  $\mu$ m. (b) Newly developing flat apex. Scale bar: 100  $\mu$ m. (c) Detail of a haptere anastomosing separate branches. Scale bar: 0.5 mm. (d) Longitudinal optical section of the axial filament and the alternating distichous pattern of primary lateral periaxial cells. Scale bar: 100  $\mu$ m. (e) Detail of the apex and the abaxial branching pattern of the distichous primary lateral filaments. Scale bar: 10  $\mu$ m. (f) Surface view of cortical cells. Scale bar: 10  $\mu$ m. (g) Medullary cells in cross sectional view. Scale bar: 100  $\mu$ m. .... 29
- Fig. 2.3. Vegetative morphology of *P. bornemannii*. (a) Surface view of a conspicuously depressed, large gland cell surrounded by a ring of cortical cells. Scale bar: 10  $\mu$ m. (b, c) Detail of a barrel-shaped, multinucleate axial cell. In (c) arrow points to a nucleus. Scale bar: 100  $\mu$ m. (d) Dumb-bell-shaped axial cells observed at the thallus base. Scale bar: 100  $\mu$ m. (e) Arrow points to rhizoidal filaments found at the thallus base. Scale bar: 100  $\mu$ m. (f) Detail of the rhizoidal cells. Scale bar: 10  $\mu$ m. .... 31
- Fig. 2.4. Development of male reproductive structures in *P. bornemannii*. (a) Surface view of a sessile nemathecium. Scale bar: 100  $\mu$ m. (b) Transverse section of elongated daughter cells originating from a basal cell during the early development of spermatangial filaments. Scale bar: 10  $\mu$ m. (c) Daughters cells formed from subsequent peri- and

anticalinal cell division of the elongated cells. Scale bar: 10  $\mu\text{m}$ . (d) Fully developed spermatangial branches. Scale bar: 100  $\mu\text{m}$ . (e) A mature spermatangial branch bearing spermatia. Scale bar: 10  $\mu\text{m}$ . .....32

Fig. 2.5. Female reproductive structures and carposporophyte development in *P. bornemannii*. (a) Unfertilized carpogonial branch - trichogyne (tr) and carpogonium (cp). Scale bar: 50  $\mu\text{m}$ . (b) Several auxiliary branches in a nemathecium. Scale bar: 50  $\mu\text{m}$ . (c) Auxilliary branch - basal cell (bc), auxilliary cell (aux), and terminal cell (tc) and a sterile nemathecial filament (nf). Scale bar: 10  $\mu\text{m}$ . (d) Fertilized carpogonium. Scale bar: 10  $\mu\text{m}$ . (e) and (f) A connecting filament (cf) connects the carpogonium to the auxilliary cell. Scale bar: 10  $\mu\text{m}$ . (g) Gonimoblast initial (gi) developing from auxilliary cell. Scale bar: 10  $\mu\text{m}$ . (h) A developing carposporophyte. Scale bar: 50 $\mu\text{m}$ . (i) Cross section of a cystocarp with fully developed gonimoblasts. Scale bar: 100  $\mu\text{m}$ . (j) Carpospores (cps). Scale bar: 10  $\mu\text{m}$ . (k) Hair cell from a sterile nemathecial filament. Scale bar: 10  $\mu\text{m}$ . .....33

Fig. 2.6. Tetrasporore development in *P. bornemannii*. (a) Surface view of a tetrasporangial nemathecium. Scale bar: 100  $\mu\text{m}$ . (b) Compact arrangement of tetrasporangia covered in transverse section. Scale bar: 100  $\mu\text{m}$ . (c) Detail of zonately divided tetrasporangia. Scale bar: 10  $\mu\text{m}$ . .....35

Fig. 2.7. Maximum likelihood phylogeny of family Rhizophyllidaceae based from combined *rbcL* and LSU nrRNA gene sequences. Node support values are given at each ramification (ML and BI). The log-likelihood value of the tree is - 10542.80329. Base frequencies are A = 0.26209, C = 0.19951, G = 0.27892, T = 0.25949. The substitution rates are AC = 0.67945, AG = 2.29698, AT = 2.49003, CG = 0.88817, CT = 6.35790, GT = 1.0000. The proportion of invariable sites in the alignment is 0.504 and the shape parameter of the gamma distribution among site rate heterogeneity is 0.735.....36

Fig. 3.1. Sampling locations of *Portieria* within the Philippines.....50

Fig. 3.2. (a) Ultrametric tree of the *Portieria* based on a Bayesian analysis of *cox2-3* spacer sequence data with divergence times estimated under a relaxed molecular clock in BEAST. (b) The graph represents the corresponding lineage-through-time plot. The dotted vertical line indicates the maximum likelihood transition point of the switch in branching rates from interspecific to intraspecific events, as estimated by a general mixed Yule-coalescent (GMYC) model. The blue color indicates the confidence interval in the estimated number of species. ....62

Fig. 3.3. Gene trees inferred from (a) *cox2-3* spacer (b) elongation factor 2 (EF2) (c) *rbcL* -spacer. Colors correspond to *cox2-3* GMYC clusters to which a sample belongs. Branch support (posterior probabilities > 0.50 and bootstrap support >70 are indicated on the branches.....64

Fig. 3.4. Bayesian species tree inferred using \*BEAST with numbers above branches representing posterior probability values. This 19-species guide tree was used as reference tree for the Bayesian species delimitation of *Portieria* using BP&P. The speciation probabilities are provided for each node under each combination of priors for  $\Theta$  and  $\tau_0$ : top,  $\Theta \sim G(1, 10)$  and  $\tau_0 \sim G(1, 10)$ , middle,  $\Theta \sim G(2, 2000)$  and  $\tau_0 \sim G(2, 2000)$ , bottom  $\Theta \sim G(1, 10)$  and  $\tau_0 \sim G(2, 2000)$ . .....65

Fig. 3.5. Bayesian species delimitation results after further splitting four V1 clades into 11 species. Only the nodes leading to the four main clades are strongly supported while remaining speciation events are not supported. ....66

Fig. 3.6. Distribution of *Portieria* species in the Philippines. Number of samples (n) is indicated for each sampling site. (a) Location of sampling sites. (b) Species found in the Batanes sites. (c) Species found in the Visayas, Sorsogon and Camiguin.....69

Fig. 3.7. Total species richness estimates of *Portieria* in the Philippines derived using the first order Jackknife estimator. Extrapolation of extant diversity involves use of existing frequency data of species per site and the fitting of various asymptotic functions to determine diversity beyond current sample size. ....70

Fig. 4.1. Map showing the location of collecting sites (black dots). The blue area illustrates the known distribution range of *Portieria* (Guiry & Guiry, 2011), and the five coloured areas show the geographical regions used in this study: orange (Western and Central Indian Ocean), dark green (Indo-Malay Archipelago), light green (Japan), cyan (E Australia), purple (Hawaii).....83

Fig. 4.2. Ultrametric tree of the *Portieria* based on a Bayesian analysis of *cox2-3* spacer sequence data with divergence times estimated under a relaxed molecular clock in BEAST. The dotted vertical line indicates the maximum likelihood transition point of the switch in branching rates from interspecific to intraspecific events, as estimated by a general mixed Yule-coalescent (GMYC) model. ....86

Fig. 4.3. Map of the Philippines illustrating the geographical distributions of species within the archipelago. Most species exhibit intra-archipelagic endemism, with only three species being more widely distributed within the archipelago (S6, S39 and V32). ....87

Fig. 4.4. Time-calibrated phylogeny of *Portieria* based on Bayesian analysis of a five-locus data set with divergence times estimated under a relaxed molecular clock in BEAST. Support values are posterior probabilities (PP); only values > 0.90 are shown. Uncertainty in divergence times are indicated by grey bars on internal nodes, corresponding to the 95% highest posterior density (HPD) of node ages. Time is given in millions of years before present. Stars indicate significant diversification shifts using the relative cladogenesis statistic (see key in figure). ..89

Fig. 4.5. Lineage through time (LTI) plot based on the chronogram in Fig. 4.4, showing a near constant rate of diversification. ....90

Fig. 5.1. Collection of conventional parameter measurements. (a) General branching pattern of *Portieria*. (b) A 10-mm branch tip with the gray area marking the measurement spot. (c) Numbers assigned to branchlets. (d) Length and width measurements collected. (e) Location of angles measured. Numbers on (d) and (e) are further defined in Table 5.3. ....120

Fig. 5.2. Phylogenetic tree reconstructed using Bayesian inference based on the mitochondrial *cox2-3* spacer of *Portieria* specimens collected from Batanes (B) and Visayas (V) Islands in the Philippines. ML analysis generated identical groupings. Posterior probabilities  $\geq 0.5$  are indicated at the branches. ....126

Fig. 5.3. Boxplot of mean values for all measured parameters for each clade and for all the clades. ....128

Fig. 5.4. Images of branches demonstrating an increasing box-counting dimension ( $D_B$ ) with lacunarity. ....129

Fig. 5.5. Scatter plots of discriminant scores derived from significant discriminant (canonical) roots. (a) Scatter plot of discriminant scores derived from fractal and non-conventional (FracLac-derived) variables. (b) Scatter plot of discriminant scores derived from conventional variables. (c) Scatter plot of discriminant scores derived from combined FracLac-derived and conventional variables. ....132

Fig. 6.1. Map of sampling sites. (a) Map of the Philippines indicating location of Batanes and Visayas. (b) Sampling sites in Batan and Sabtang Islands in Batanes. (c) Sampling sites in Siquijor, Negros, and Cebu Islands in the Visayas. ....147

Fig. 6.2. Phylogenetic tree reconstructed using Bayesian inference based on the *cox2-3* gene of *Portieria* specimens collected from Batanes (B) and Visayas (V) Islands in the Philippines. Branch support (posterior probabilities)  $\geq 0.5$  are indicated at the branches. The eleven clades represent cryptic species. Species B34 and B38 were not included in the chemical analysis. ....152

Fig. 6.3. Portion of GC-MS total ion chromatograms of non-polar extracts of *Portieria* samples (a) male gametophyte from Bantayan (Dumaguete), V1 (b) White Beach, Batanes, B21 (c) Liloan, V32.  $\beta$ -myrcene, a precursor of many halogenated monoterpenes, was detected only in the Bantayan specimens. Naphthalene is used as an internal standard. ....154

Fig. 6.4. Frequency distribution indicating number of shared and unique non-polar secondary metabolites. (a) within life-history stages of Bantayan specimens (b) species V32 of the Visayas specimens. ....155

Fig. 6.5. Principal component analysis of GC-MS standardized relative abundance datasets which includes the compounds detected in a 67-minute run of *Portieria* extracts. (a) Male gametophyte (M1-2) samples are clearly discriminated occurring at the positive end of the plane while female gametophyte (F2-7) and tetrasporophyte samples (T1-2) are only partially discriminated by Factor 1. (b) Batanes dataset includes 5 cryptic species. The

clustering of B35 replicates and the scattered pattern of B5 suggest variation in component compounds exists between species but at the same time suggested that variation within species can occur. ....157

Fig. 6.6. Principal component analysis of GC-MS standardized relative abundance datasets for detecting possible spatial and temporal patterns in (a) the Visayas species (b) the Visayas samples belonging to species V32. Letters indicate sampling site (DAP: Dapdap; PAG: Pagubagubaa; SAW: Sawang; SIA: Siaton) and numbers indicate month and year of sampling. ....162

Fig. 7.1a-b. Maps showing the location of the four survey sites (Siaton, Dapdap, Pagubagubaa and Sawang) of *Portieria*, the species found and the location of the PAGASA Station (Dumaguete) where rainfall data was obtained. ....187

Fig. 7.2. Temporal variation in environmental parameters. Temperature and salinity measurements during the surveys in (a) Siaton (b) Dapdap (c) Sawang (d) Pagubagubaa. ....190

Fig. 7.3. Mean monthly rainfall ( $\pm$  SE) measured at the PAGASA station closest to the sampling sites. NE and SW monsoon months are indicated by light and dark gray bars, respectively. ....191

Fig. 7.4. Temporal variation in monthly mean abundance (individuals.m<sup>-2</sup>) ( $\pm$  SE) and percent cover ( $\pm$  SE) from 2007-2009 in 4 surveyed sites (a) Siaton (b) Dapdap (c) Sawang (d) Pagubagubaa. The symbol \* indicates absence of sampling data due to site inaccessibility during extreme wave actions and bad weather. Pagubagubaa has only been surveyed for 1 year as this site was a later discovery. ....192

Fig. 7.5. Temporal variation in monthly mean biomass ( $\pm$  SE) of *Portieria* from 2007-2009 in 4 surveyed sites (a) Siaton (b) Dapdap (c) Sawang (d) Pagubagubaa. The symbol \* indicates absence of sampling data due to site inaccessibility during extreme wave actions and bad weather. Pagubagubaa has only been surveyed for 1 year as this site was a later discovery. ....193

Fig. 7.6. Monthly mean thallus height ( $\pm$  SE) of *Portieria* from 2007-2009 in 4 surveyed sites (a) Siaton (b) Dapdap (c) Sawang (d) Pagubagubaa. ....197

Fig. 7.7. Percentage of cystocarpic plants in Siaton (n=10-23) and Dapdap (n=5-51) from 2007 to 2009. ....198









# 1 GENERAL INTRODUCTION

---

## 1.1 Marine biodiversity and secondary metabolites

Marine biodiversity offers a rich resource of secondary metabolites with biomedical and pharmacological potentials. These compounds do not play an essential role in the basic metabolic processes of an organism (Dixon, 2001). They appear to function as defense mechanisms against consumers, pathogens and competitors and therefore, may influence the organization and structure of marine systems at the genetic, population and ecosystem levels (Hay and Fenical, 1996; Hay, 2009). Marine secondary metabolites generally have low molecular weights (<3000 Daltons), diverse chemical structures, often halogenated, and exist in low abundance (often <1% of total carbon) (Fenical, 1975; Hay and Fenical, 1996; Barahona and Rorrer, 2003; Andrianasolo et al., 2006) (Fig. 1.1). In contrast to primary metabolites, such as nucleotides and amino acids, they do not play an essential role in the growth and development of the organisms (Croteau et al., 2000). Thousands of marine secondary metabolites have been identified from sponges, ascidians, soft corals, bryozoans, polychaetes, seaweeds, marine microbes and other benthic and pelagic organisms (Hay and Fenical, 1996; Jha and Zi-rong, 2004; Paul et al., 2011). Among the compounds isolated from this wide array of organisms are terpenes, acetogenins, alkaloids, polyphenolics, fatty acids, sterols, and carotenoids (Hay and Fenical, 1996; Cardozo et al., 2007). Those chemicals are appreciated for their antibiotic properties, their effect on cellular growth, or their influence on cell agglutination (Smit, 2004). Some examples of recently approved medicines derived from marine organisms are the anti-chronic pain Ziconotide (Prialt; Elan Pharmaceuticals) and the antitumor compound Trabectedin (Molinski et al., 2008). These drugs were derived from a tropical marine gastropod and a sea squirt, respectively (Fig. 1.2).

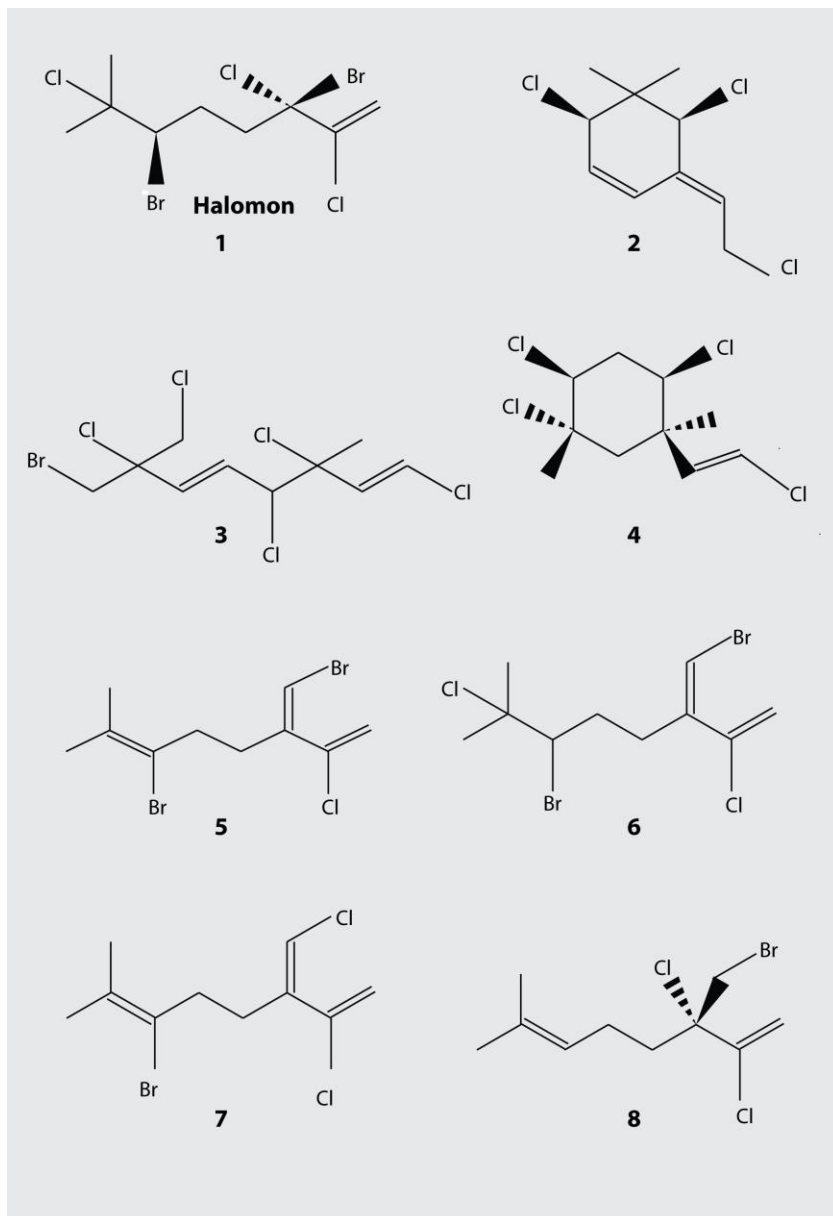

Fig. 1.1. Cyclic and acyclic halogenated monoterpenes isolated from *Portieria hornemannii* (adapted from Fuller et al. 1992 and Andrianasolo et al. 2006). Halomon has been found to have specific cytotoxicity towards a broad range of tumor cells. Compounds 1-4 were isolated from *Portieria* populations in Batanes, Philippines. Compounds 1 and 5-8 were extracted from Madagascar specimens.



Fig. 1.2. Marine drug-producing invertebrates (adapted from Molinski et al. 2008) (a) Textile cone snail *Conus magus* is the source of anti-chronic pain Ziconotide (Prialt; Elan Pharmaceuticals) (Photo credit: Alan J. Kohn). (b) The Caribbean sea-squirt *Trididemnum solidum* is the source of the antitumor compound Trabectedin (Molinski et al., 2008).

Macroalgae or seaweeds supply about 9% of these marine biomedical compounds (Blunt et al., 2004) (Fig. 1.3). One such group of compounds, halogenated monoterpenes (Fig. 1.1), is exclusively found in three genera of macrophytic red algae, including *Plocamium*, *Portieria* and *Ochtodes* (Polzin et al., 2003). Monoterpenes are a class of terpenes that consist of two isoprene units and have the molecular formula  $C_{10}H_{16}$ .

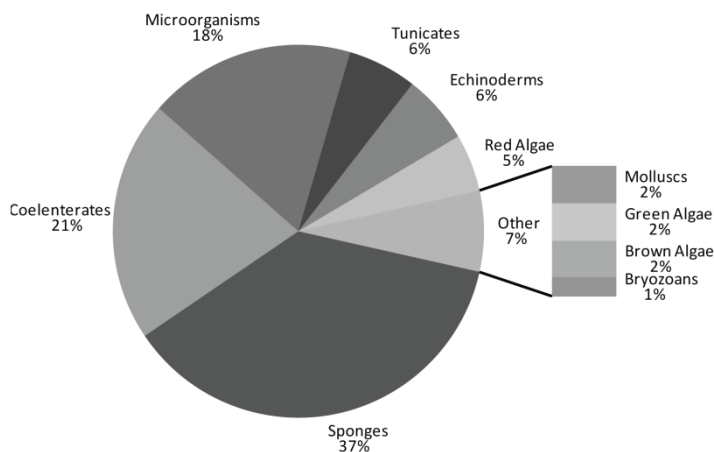

Fig. 1.3. Distribution of natural products obtained from marine organisms based on a study in 2002 (adapted from Blunt et. al 2004).

Monoterpenes may be linear (acyclic) or contain rings (Wise et al., 2002). The biosynthesis of halogenated monoterpenes in macrophytic red algae is not very well understood (Wise and Croteau, 1999). Wise et al. (2002) proposed a biogenenic scheme involving bromonium and chloronium ion-initiated additions and cyclizations (Fig. 1.4). Naylor et al. (1983) suggest that ocimene is the common

monoterpene precursor to all the halogenated monoterpenes found in *Plocamium*, while myrcene is common precursor to all the halogenated monoterpenes found in *Portieria* (Polzin et al., 2003). The halogenation of monoterpenes with bromine and chlorine ions in seawater is most likely promoted by a vanadium-dependent bromoperoxidase (Butler and Walker, 1993; Butler and Carter-Franklin, 2004).

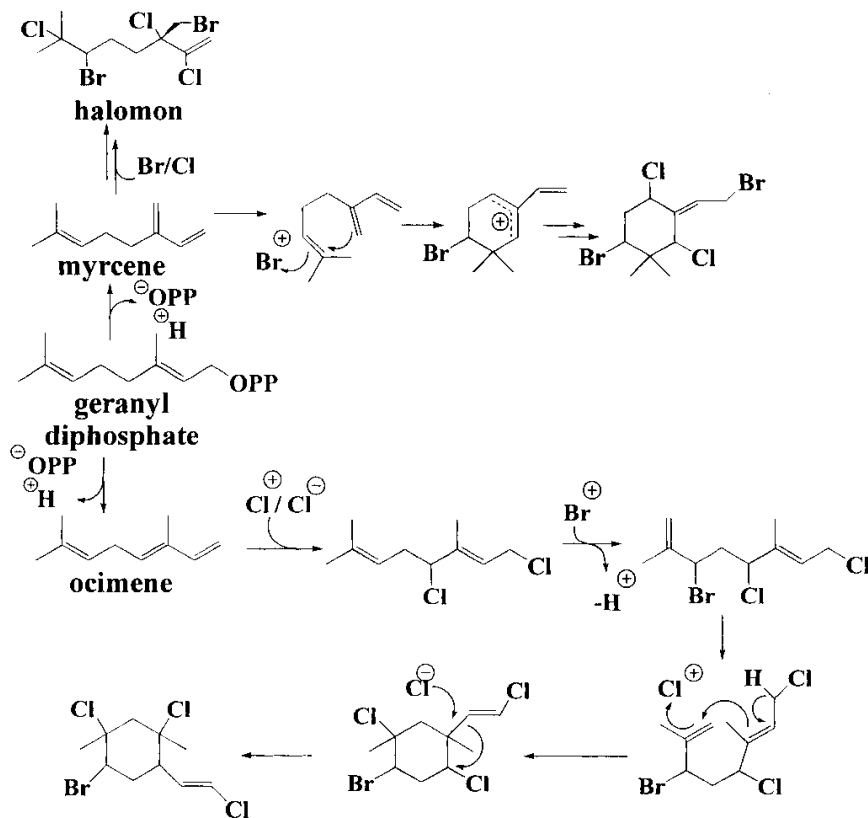

Fig. 1.4. Biogenetic scheme for the origin of marine algal monoterpenes involving bromonium or chloronium ion-initiated additions and cyclizations (adapted from Wise et al. 2002)

**Halomon**, a pentahalogenated monoterpene, was isolated from the red alga *Portieria bornemannii* from Batan Island in the Philippines by Füller et al. (1992) (Fig. 1.1). The compound was initially screened in anti-HIV assays but proved to be inactive. Instead Füller et al. (1992) discovered that halomon showed one of the most extreme cases of differential cytotoxicity observed so far. The compound acts as vigorous anti-tumor agent against a broad range of tumor cells when subjected to the National Cancer Institute (NCI) Human disease-oriented drug screen (see

---

<http://www.cancer.gov/>). Subsequently halomon was selected for drug development by NCI Decision Network Committee (Fuller et al., 1992; Carté, 1996). The isolation of **halomon** and the discovery of its anti-tumour potential in the 1990s initiated research interests on this taxon (Fuller et al., 1992; Fuller et al., 1994; Meñez et al., 1996; Egorin et al., 1997; Puglisi and Paul, 1997). Apart from publications on halogenated monoterpene isolation from *Portieria* (Barahona and Rorrer, 2003; Kuniyoshi et al., 2003; Andrianasolo et al., 2006), interest on this taxon especially even on its pharmacological potential appear to have waned leaving large gaps on our existing knowledge of *Portieria*. The absence of sufficient biological knowledge about *Portieria* has placed halomon in a drug development bottleneck. The motivation for this thesis is the hypothesis that the variation in halomon content among *Portieria* populations could be due to cryptic diversity, seasonality and geographical variation on the secondary metabolite production.

## 1.2 *Portieria*: a taxonomic perspective

*Portieria* is a marine red algal genus that belongs to the family Rhizophyllidaceae under the order Gigartinales. The family Rhizophyllidaceae was erected by Schmitz (1889), based from the type genus *Rhizophyllis*, whose currently accepted name is *Contarinia*. Wiseman (1975) proposed the retention of the family against Denizot's Contarinaceae on the basis that *Rhizophyllis* is a legitimate synonym and is the basionomic stem of the family. The family Rhizophyllidaceae currently includes four genera: *Contarinia*, *Ochtodes*, *Portieria* and more recently, *Nesophila*.

The genus *Portieria* Zanardini has a complex nomenclatural history. The nomenclature of this genus was discussed by Silva et al. (1987). Silva et al. (1987) declared preference over *Portieria* because of its unequivocal status over other synonyms. *Portieria*, named after a French collector Portier, initially included a single species, *P. coccinea*, from the Red Sea. Among its synonyms was *Desmia*, established by Lyngbye (1819). This referred to three species with narrow and compressed branches. Two of these referred to the types of *Herbacea* Stackhouse (1809) and *Hippurina* Stackhouse (1809) which are both referable to *Desmarestia* Lamouroux. The third species was *Desmia bornemannii*, which according to Silva et al (1987), signifies the beginning of a valid nomenclature. This was based on a specimen named *Fucus bornemannii* from Mertens which was earlier published as nomen nudum. Kutzing also established independently the genus *Chondrococcus* based on two species now currently placed in the genera *Melanthalia* Montagne and *Callophyllis* Kützing. He also applied *Chondrococcus lambertii* to species belonging to *Callophyllis*

and *Chondrococcus* as described recently. The erroneous attachment of a name to several species by Lyngbye and Kützing, thus, favored the retention of Zanardini's *Portieria*. Thus, *P. coccinea*, *Chondrococcus lambertii* and *Desmia bornemannii* are listed as synonyms of *P. bornemannii* in Silva et al., 1996.

There are about seven currently recognized species of *Portieria*: *Portieria dichotoma* (Hauck) P.C. Silva, *P. harveyi* (J. Agardh) P.C. Silva, *P. bornemannii* (Lyngbye) P.C. Silva, *P. japonica* (Harvey) P.C. Silva, *P. kilneri* (J. Agardh) P.C. Silva, *P. spinulosa* (Kützing), P.C. Silva, *P. tripinnata* (Hering) De Clerck (listed in Guiry and Guiry 2011; Silva and Menez 1987). Wiseman (1973) expressed doubt on the membership of *P. dichotoma* under this genus based on the absence of inrolled tips, non-paraphysial tetrasporangial nemathecia, and gland cells. My examination of the type material of *P. dichotoma* deposited at the Leiden Herbarium (Netherlands) confirms that this species is probably not a member of *Portieria*.

Previous authors have failed to set clear morphological boundaries between *Portieria* species. Wiseman's (1973) taximetric studies on branching pattern, thallus height, branch width, length and width of tetrasporangia of *Chondrococcus* specimens from the Indo-Pacific proved that these morphological characters are futile in defining species boundaries. He recognized the existence of a continuum of forms and concluded that all recognized taxa of *Chondrococcus* are conspecifics of *Chondrococcus bornemannii* (Lyngbye) Schmitz. Millar and Van Reine (2005) further suggested that *P. spinulosa* and *P. bornemannii* are conspecific. Guiry and Guiry (2011) noted these taxonomic views but opted to recognize Silva's species list which was based on nomenclatural decisions. Nevertheless, the presence of a morphological continuum and the absence of clear delimiting characters suggest of a species complex in *P. bornemannii*.



### 1.3 *Portieria hornemannii*

*Portieria hornemannii* (Lyngbye) P. C. Silva is a marine red macroalga reaching about 15 cm. It grows in intertidal and subtidal areas of the Indo-Pacific. Its wide distribution includes coasts of North Africa (Red Sea), East Africa and South Africa, India, Indian Ocean Islands, South East Asia, East Asia, Australia, New Zealand and the Pacific Islands (Guiry and Guiry, 2011). They are generally attached to rocky or dead coral substrates but can be epiphytic on other macroalgae. The general habit and morphology includes a thallus that is recumbent to erect arising from an encrusting base or a discoid holdfast (Fig. 1.6). Thallus color may vary from greenish pink to dark red with older specimens turning orange to brown. Compressed axes branch up to about 5 orders with apices that are slightly to strongly incurved.

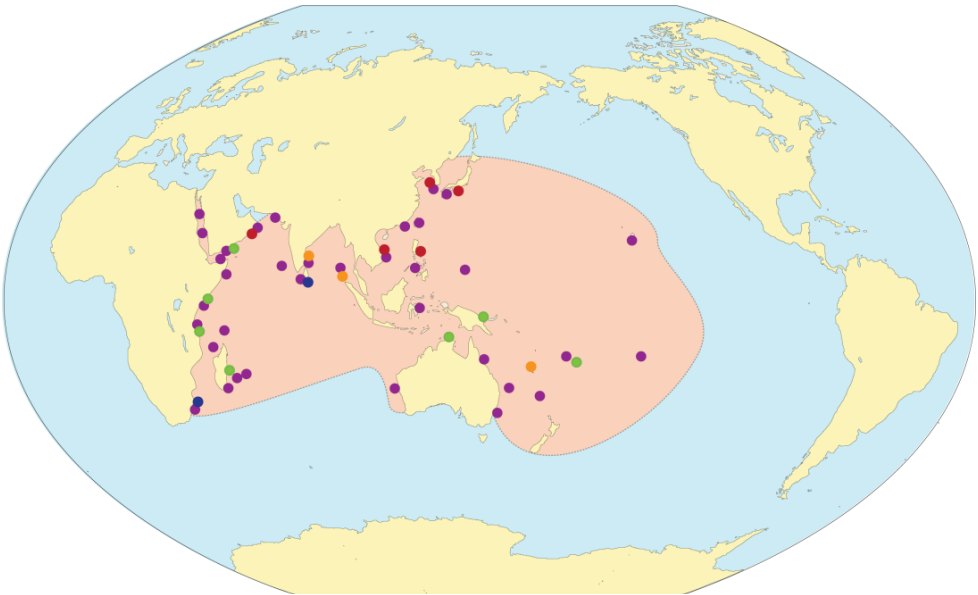

Fig. 1.5. Distribution of *Portieria* in the Indo-Pacific (violet– *P. hornemannii*, orange– *P. spinulosa*, red – *P. japonica*, blue – *P. tripinnata*, green – *P. barveyii*). Distribution patterns are based on unverified literature reports listed in Algaebase (Guiry and Guiry, 2011).

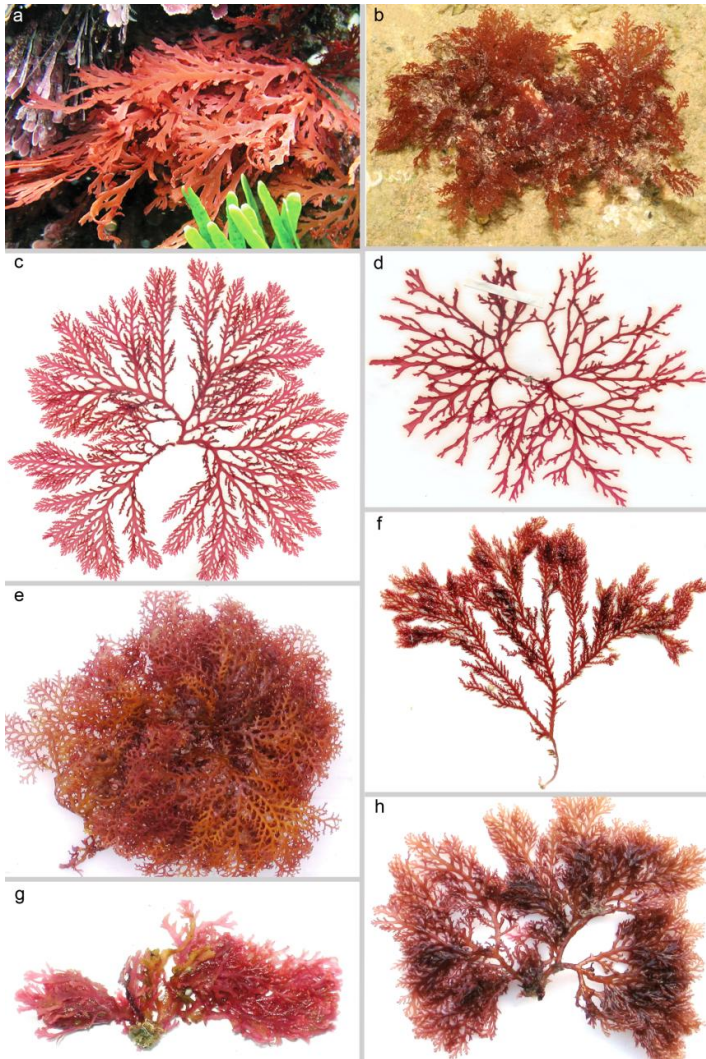

Fig. 1.6. Gross morphology and morphological variation of *Portieria*. (a) Underwater photograph of *P. bornemannii* from South Africa (Photo credit: O. De Clerck). (b) Habit *in situ* of *P. bornemannii* from Sri Lanka (Photo credit: Olivier Dargent in Coppejans et al., 2009). (c-d) Pressed herbarium specimen from Kwazulu-Natal, South Africa. (e) Fresh specimen from Siquijor, Philippines. (f) Fresh specimen from Batanes, Philippines. (g) Fresh specimen from Guiuan, Eastern Samar, Philippines (Photo credit: R. Ladio). (h) Fresh specimen from Batanes, Philippines.

Internal morphology reveals a uniaxial thallus and gland cells that are ubiquitous in both nemathecial and cortical tissues. *Portieria* has a tri-phasic life cycle typical for florideophycean red algae (Fig. 1.7). The free-living haploid gametophytes and diploid tetrasporophytes are isomorphic. All life-history stages enclose reproductive structures in nemathecia, mound-like growths of specialized filaments produced by the further growth of superficial cells and which contains reproductive bodies (Rao, 1956; Wiseman, 1973). *P. hornemannii* has been described as early as 1819 by Lyngbye. Knowledge about this taxon has been limited to general descriptions, and therefore has remained largely understudied until now. However, the presence of intermediate forms has long been observed by earlier workers (Wiseman, 1973 and authors cited therein).

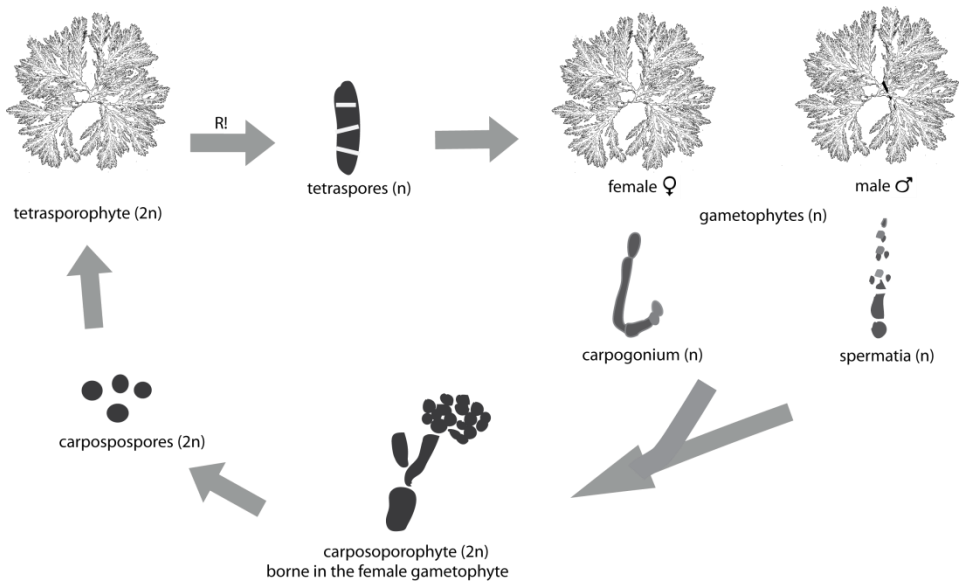

Fig. 1.7. Tri-phasic life-history of *Portieria*.

## 1.4 Cryptic species diversity

Macroalgal systematics has been dominated by the morphological species concept, a criterion that uses discontinuities in the pattern of morphological variation to distinguish species. Morphological delimitation of algal species is, however, contentious; especially in groups that are morphologically depauperate and exhibit convergent evolution towards reduced morphologies (Cianciola et al., 2010) (Fig. 1.8).

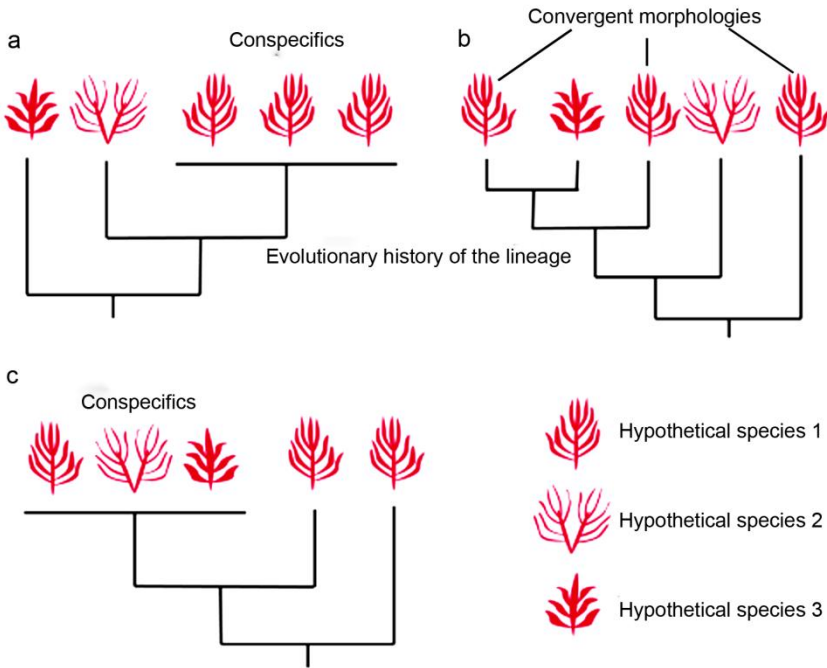

Fig. 1.8. Possible scenarios of morphological convergence and variation confounding species delimitation (adapted from Cianciola et. al. 2010). (a) Scenario in which morphology is congruent with molecular data. (b) Convergent morphological evolution of distantly related species. (c) Convergent evolution scenario is observed in species that exhibit large degree of environmentally-influenced morphological plasticity.

---

Molecular data are increasingly used to explore species boundaries in algae. One of the most remarkable outcomes of molecular studies is the discovery of cryptic and pseudo-cryptic species. Cryptic species are defined as species that are morphologically indistinguishable, while pseudo-cryptic species are species that are readily distinguished morphologically once the appropriate characters are considered (Knowlton, 1993; Verbruggen et al., 2005; Bickford et al., 2007; Maggs et al., 2007). Cryptic species (sometimes called sibling species) have been found to be common in the marine environment where chemical recognition systems (e.g. chemically-mediated recognition) play a dominant role (Knowlton, 1993). Detection of cryptic species is particularly challenging especially among marine organisms with simple body plans like macroalgae. These organisms lack diagnosable morphological differences probably because their relevance is reduced. It now becomes clear that in several algal groups (including red algae) species diversity has been underestimated due to the presence of cryptic and pseudo-cryptic species (Zuccarello et al., 2002; Zuccarello and West, 2004; Leliaert et al., 2009). A distinction between cryptic and pseudo-cryptic species will always be arbitrary to a certain extent since this is inherently linked to the effort made by researchers to search for diagnostic characters. However, true cryptic species may probably, best refer to those entities that have not undergone sufficient morphological differentiation to create functional importance for the organism. Such that, these entities remain morphologically quasi-identical, but genetically different. In addition, morphologically identical species may display various other phenotypic differences, such as ecophysiological or biochemical differences.

The generic concept of *Portieria* has been solely based on observations of structural characters (Zanardini, 1851). Furthermore, status of species boundaries between *P. hornemannii* and other currently accepted species are highly ambiguous. Absence of clear diagnostic characters and apparent continuum of forms led authors to suggest that *Portieria* is a monospecific genus. Under this scenario *P. harveyi*, *P. japonica*, *P. spinulosa* and *P. tripinnata* all become synonyms of *P. hornemannii* (Wiseman, 1973; Millar and Van Reine, 2005).

The use of molecular data to investigate *Portieria*'s diversity is a form of reverse taxonomy. Reverse taxonomy first identifies species boundaries based on molecular data, and then uses these species circumscriptions to analyse morphological, biogeographical and ecological variation (Blaxter 2004, Markmann and Tautz 2005, and Vogler 2007). In addition, we employed an integrative taxonomy approach, including morphometrics (e.g. fractal dimension) and chemical characterization of *Portieria* specimens. Integrative taxonomy aims to delimit the

units of life's diversity from multiple and complementary perspectives (phylogeography, comparative morphology, population genetics, ecology, development, behaviour, etc. (Dayrat 2005).

#### 1.4.1 *Species delimitation approaches*

The ease by which genetic data are generated nowadays has propelled the use of gene sequences to identify species and to infer species boundaries (Knowles and Carstens, 2007). Over the past 15 years, different empirical methods for delimiting species based on DNA sequence data have been described (reviewed in Sites and Marshall, 2003). Species delimitation approaches can be differentiated into tree based and non-tree-based methods. The latter category focuses on indirect inferences of the presence or absence of gene flow while tree-based methods delimit species based on properties related to phylogenetic tree topologies (monophyly, concordance with geography, exclusivity, etc.). Regardless of whether these methods are tree or non-tree based, they all apply some sort of exclusivity criterion, e.g. unique nucleotide differences (Cracraft, 1989; Davis and Nixon, 1992; Wiens and Penkrot, 2002; Monaghan et al., 2005) or discontinuities in sequence variation associated with species boundaries (Hudson and Coyne, 2002).

For example **phylogenetic species recognition** (PSR) recognizes species based on the presence of monophyletic genealogical groups supported by a consensus of the majority of the loci used or the presence of a high support by one locus but not contradicted by the rest (Dettman et al., 2003). **DNA barcoding** utilizes short, standardized and group specific DNA sequences, e.g. cytochrome c oxidase 1 (*cox1*) for animals and *rbcL* and *matK* for flowering plants, to identify specimens using a DNA barcode reference library (Hebert et al., 2003, Frézal and Leblois, 2008; Borisenko et al., 2009; CBOL plant working group, 2009). Barcoding also aims to enhance the discovery of new species based on the notion of low divergence within species versus high divergence between species (Hebert et al., 2003; Frézal and Leblois, 2008). However, the utility of DNA barcoding as a species delimitation tool is still under debate (Vogler and Monaghan, 2007). Empirical as well as simulation studies demonstrate that traditional barcoding studies often fail to correctly delimit species, especially in understudied groups of organisms (Meyer and Paulay, 2005; Hickerson et al., 2006; Meier et al., 2006; Bittner et al., 2010). Still applying exclusivity criteria but aiming to reduce arbitrariness in delimiting species, the **General Mixed Yule Coalescent Model** (GMYC) determines the point of transition of evolutionary processes from species

---

level (speciation and extinction) to population level (coalescence) (Pons et al., 2006). This point of transition is detectable as an increase of branching rate between speciation (macroevolution) and coalescence processes at population level (microevolution). The transition in branching rates is best demonstrated by a sudden increase in the slope in a lineage through time plot (LTT). Monaghan et al. (2009) developed a multi-threshold model of the GMYC where speciation-coalescent transition is allowed to vary along individual branches of a phylogenetic tree. It is suggested that the GMYC should be supported with congruent results from additional genetic loci or traditional means.

However, a fundamental criticism applies to the techniques outlined above. Single-gene barcoding studies assume that the inferred gene tree is representative for the true species phylogeny. A number of processes, such as lineage sorting, introgression, undetected gene duplication may cause gene trees to disagree with the true tree of species (Heled and Drummond, 2010; O'Meara, 2010). Genetic loci undergo a transition from an initial state of polyphyly or paraphyly upon lineage splitting toward monophyly as the time since speciation increases (Avice and Ball, 1990). So even though eventually all taxa might be delimited with a criterion like reciprocal monophyly, recently diverged species will only rarely meet this assumption. Therefore, a number of alternative species delimitation methodologies, relying on multiple loci, have been developed which model the relationship between the gene trees and the species history probabilistically (Maddison, 1997; Hickerson et al., 2006; Knowles and Carstens, 2007; Heled and Drummond, 2010; O'Meara, 2010). Coalescent theory allows modelling gene genealogies by going backwards in time while utilizing population genetic models in the calculation of probabilities and likelihood analyses of polymorphism data (Nordborg, 2003; Degnan and Rosenberg, 2009). The basic coalescent model considers several assumptions which are the following: large and panmictic populations, a neutral mutation process, and constant population sizes within populations. Additional assumptions include absence of recombination within genes, absence of migration, and horizontal gene transfers across the species phylogeny (Meng and Kubatko, 2009).

Apart from recent species divergence, exclusivity criterion (e.g. reciprocal monophyly) cannot always be satisfied in all loci because forms of balancing selection such as heterosis or frequency dependent selection may keep alleles polymorphic for long periods of time (Hudson and Coyne 2002). A strict monophyly of 15 loci can only be achieved after more than 1 million years in a species with an effective population size ( $N_e$ ) of 250000 and with a generation rate of one per year (Knowles and Carstens 2007). With this method, a speciation event

can only be recognized after the lengthy period of sorting ancestral polymorphisms. Therefore, relaxing the stringent criterion of exclusivity (for example, multispecies coalescent approaches) might be necessary to allow recognition of more species which can go unnoticed.

#### 1.4.2 *Molecular markers*

Molecular markers frequently used for species-level phylogenetic inference in red macroalgae include mitochondrial *cox2-3* spacer, *cox1* and plastid *rbcL* or *rbcL-rbcS* spacer markers (Zuccarello et al., 1999; Saunders, 2005; Robba et al., 2006; Maggs et al., 2007). These organellar DNA markers are ideal for lower-level phylogeny because they are uniparentally inherited, nonrecombining, and have smaller effective population size than nuclear markers (Provan et al., 2004). The *cox2-3* spacer has been demonstrated to be variable within species and populations in the red algae (Zuccarello et al., 1999). Recently, the *cox1* has been found successful in resolving species complexes in several red algal genera (Saunders, 2005; Robba et al., 2006). The same has also been observed in the chloroplast gene *rbcL* (Freshwater et al., 2010). Although, nuclear markers such as 18s and 28s nrDNA are exploited to resolve relationships at higher taxonomic levels (Maggs et al., 2007), we utilized the nuclear gene elongation factor 2 (EF2) for species delimitation purposes. The enzyme EF2 catalyzes the coordinated movement of the two tRNA molecules, the mRNA and the conformational changes in the ribosome during the elongation cycle of protein synthesis (Jørgensen et al., 2006). The use of EF2 marker in red algae is rather recent and has been first used to resolve supraordinal relationships in the red algal class Floridophyceae (Le Gall and Saunders, 2007). We, however, examined the utility of this gene in resolving species relationships and in extracting clues for hybridization.

### 1.5 Temporal and geographic variation in secondary metabolites

Earlier studies largely failed to explain the qualitative and quantitative variation of secondary metabolites in *Portieria* (Matlock et al., 1999). Meñez et al. (1996) observed that halomon-producing populations of *P. hornemannii* were grazed by the sea hare, *Aplysia parvula*. The cause of differential production of secondary metabolites has been addressed in a limited number of studies. The influences of nutrient availability on secondary metabolite production as well as site to site differences were studied among *P. hornemannii* populations in Guam. Puglisi and Paul (1997) tested the so-called carbon/nutrient hypothesis which postulates that



---

the secondary metabolites produced by a certain alga are dependent on the nutrient availability. Quantitative analysis of ochtodene (a monoterpene related to halomon) and triglyceride concentrations were investigated among 6 sites in Guam, but the variation in the ochtodene concentration could not be attributed to the availability of nitrogen or phosphorus, hence refuting the carbon/nutrient hypothesis. In addition, site to site variation in apakaochtodene levels was observed among populations in Guam (Matlock et al., 1999). However, these investigations have not taken cryptic diversity into consideration. None has also addressed possible seasonal differential production of these metabolites.

## 1.6 Aims and outline of this thesis

Successful utilization of a marine drug resource results from an extensive biological and chemical research that can last for decades. This is exemplified by the two decades of research that produced Ziconotide (Prialt), an anti-chronic pain drug from the cone snail *Conus*. Initially, this thesis has been conceptualized to address the possible causes of variation in monoterpene signature in *Portieria* which restrained further drug development research. A large part of the lack of understanding on this differential production of monoterpenes stems from a knowledge gap on the biology of *Portieria*. We hypothesized that this variation might in part be due to the existence of cryptic species. Given these three conditions: differential production of pharmacologically important monoterpenes, lack of biological knowledge on *Portieria*, and the possibility of the presence of cryptic species, this thesis specifically aimed to:

1. examine cryptic diversity in *Portieria*;
2. determine how this genetic diversity is expressed on the phenotypic level (morphology and chemistry) and in doing so ;
3. determine the role of cryptic diversity, life-history stages, seasonality and geographical location on the differential production of secondary metabolites.

To achieve these goals, we conducted the following investigations and report the results on six research chapters:

**Chapter 2** provides a more detailed account of *Portieria* vegetative and reproductive development, with an emphasis on post fertilization development. I interpret the developmental relationships among genera within Rhizophyllidaceae and relate them to phylogenetic observations.

**Chapter 3** describes the unprecedented cryptic species diversity in the *P. bornemannii* complex in the Philippines and delineates species using the General Mixed-Yule Coalescent Model Approach and Bayesian species delimitation.

**Chapter 4** infers the evolutionary history of *Portieria* based on the existing Indo-Pacific diversity and geological history.

**Chapter 5** morphometrically characterizes and distinguishes *Portieria* species using conventional and fractal parameters given a seemingly continuum of forms.

**Chapter 6** examines the variability of non-polar secondary metabolites in *Portieria* by determining if variation is due to the different life-history stages in *Portieria*, presence of phylogenetically distinct cryptic species and spatial and temporal factors.

**Chapter 7** examines the seasonal dynamics of *Portieria* populations in the Philippines given the local structure of the diversity of *Portieria*-complex. It investigates how this diversity is maintained and how differences in phenology among different cryptic species may reinforce isolation.

**Chapter 8** offers a general discussion on the significance of the conducted research and the implications of the results. Prospects for future research and conclusion are also provided.

---

## 1.7 Author contributions

**Chapter 1.** D.A. Payo wrote the general introduction. O. De Clerck and F. Leliaert commented on the manuscript.

**Chapter 2.** D.A. Payo carried out microscopy observations and the manuscript writing with guidance from O. De Clerck. H.P. Calumpong and O. De Clerck commented on the manuscript.

**Chapter 3.** D.A. Payo conducted field collections and the molecular work. O. De Clerck provided guidance on the molecular experiments. Data analyses and writing of the manuscript were shared by D.A. Payo, O. De Clerck and F. Leliaert. H. Verbruggen provided samples and important insights in the direction of the data analyses. H.P. Calumpong provided samples and advice regarding important field collection sites and commented on the manuscript.

**Chapter 4.** D.A. Payo conducted field collections and the molecular work. O. De Clerck provided guidance on the molecular experiments. Data analyses and writing of the manuscript were shared by F. Leliaert, D.A. Payo and O. De Clerck. H. Verbruggen provided samples and important insights in the direction of the data analyses. H.P. Calumpong and S.M. Lin provided samples and commented on the manuscript.

**Chapter 5.** D.A. Payo designed the study, carried out field work, fractal and non-conventional measurements, data analyses and the manuscript writing. J. Colo performed the conventional morphometric measurements. O. De Clerck provided guidance. O. De Clerck, H.P. Calumpong and F. Leliaert commented on the manuscript.

**Chapter 6.** D.A. Payo designed the study, carried out field work and laboratory experiments, data analyses and the manuscript writing. J. Colo participated in the processing of samples in the laboratory. O. De Clerck provided guidance. O. De Clerck, H.P. Calumpong and F. Leliaert commented on the manuscript.

**Chapter 7.** D.A. Payo designed the study, carried out field work, data analyses and the manuscript writing. A. Bucol performed the field work in the absence of DAP. O. De Clerck, H.P. Calumpong and F. Leliaert commented on the manuscript.

**Chapter 8.** D.A. Payo wrote the general discussion. F. Leliaert and O. De Clerck commented on the manuscript.



---

## 1.8 References

- Andrianasolo, E.H., France, D., Cornell-Kennon, S., Gerwick, W.H., 2006. DNA methyl transferase inhibiting halogenated monoterpenes from the Madagascar red marine alga *Portieria bornemannii*. *J. Nat. Prod* 69, 576-579.
- Barahona, L.F., Rorrer, G.L., 2003. Isolation of halogenated monoterpenes from bioreactor-cultured microplantlets of the macrophytic red algae *Ochtodes secundiramea* and *Portieria bornemannii*. *J. Nat. Prod.* 66, 743.
- Bickford, D., Lohman, D.J., Sodhi, N.S., Ng, P.K.L., Meier, R., Winker, K., Ingram, K.K., Das, I., 2007. Cryptic species as a window on diversity and conservation. *Trends Ecol. Evol.* 22, 148-155.
- Bittner, L., Halary, S., Payri, C., Cruaud, C., de Reviers, B., Lopez, P., Bapteste, E., 2010. Some considerations for analyzing biodiversity using integrative metagenomics and gene networks. *Biology Direct* 5, 47.
- Blaxter, M., Elsworth, B., Daub, J., 2004. DNA taxonomy of a neglected animal phylum: an unexpected diversity of tardigrades. *Proc. R. Soc. Lond. B. Biol. Sci.* 271, S189.
- Blunt, J.W., Copp, B.R., Munro, M.H.G., Northcote, P.T., Prinsep, M.R., 2004. Marine natural products. *Nat. Prod. Rep.* 21, 1-49.
- Borisenko, A.V., Sones, J.E., Hebert, P.D.N., 2009. The front end logistics of DNA barcoding: challenges and prospects. *Molecular Ecology Resources* 9, 27-34.
- Butler, A., Carter-Franklin, J.N., 2004. The role of vanadium bromoperoxidase in the biosynthesis of halogenated marine natural products. *Nat. Prod. Rep.* 21, 180-188.
- Butler, A., Walker, J.V., 1993. Marine haloperoxidases. *Chem. Rev.* 93, 1937-1944.
- Cardozo, K.H.M., Guaratini, T., Barros, M.P., Falcão, V.R., Tonon, A.P., Lopes, N.P., Campos, S., Torres, M.A., Souza, A.O., Colepicolo, P., 2007. Metabolites from algae with economical impact. *Comparative Biochemistry and Physiology Part C: Toxicology & Pharmacology* 146, 60-78.
- Carté, B.K., 1996. Biomedical potential of marine natural products. *Bioscience* 46, 271-286.
- CBOL plant working group (2009).** A DNA barcode for land plants. *PNAS* 106 (21): 12794–12797.
- Cianciola, E.N., Papolizio, T.R., Schneider, C.W., Lane, C.E., 2010. Using Molecular-Assisted Alpha Taxonomy to Better Understand Red Algal Biodiversity in Bermuda. *Diversity* 2, 946-958.
- Coppejans, E., Leliaert, F., Dargent, O., Gunasekara, R., De Clerck, O. 2009. Sri Lankan Seaweeds - Methodologies and field guide to the dominant species. *Abc Taxa*, vol 6: i-viii, 265 pp.
- Cracraft, J., 1989. Speciation and its ontology: the empirical consequences of alternative species concepts for understanding patterns and processes of differentiation. *Speciation and its Consequences*, 28-59.
- Croteau, R., Kutchan, T.M., Lewis, N.G., 2000. Natural products (secondary metabolites). *Biochemistry and molecular biology of plants*, 1250–1318.
- Davis, J.J., Nixon, K.C., 1992. Populations, genetic variation, and the delimitation of phylogenetic species. *Syst. Biol.* 41, 421.
- Dayrat, B., 2005. Towards integrative taxonomy. *Biol. J. Linn. Soc.* 85, 407-416.
- Degnan, J.H., Rosenberg, N.A., 2009. Gene tree discordance, phylogenetic inference and the multispecies coalescent. *Trends Ecol. Evol.* 24, 332-340.
- Dettman, J.R., Jacobson, D.J., Taylor, J.W., 2003. A multilocus genealogical approach to phylogenetic species recognition in the model eukaryote *Neurospora*. *Evolution* 57, 2703-2720.
- Dixon, R.A., 2001. Natural products and plant disease resistance. *Nature* 411, 843-847.
- Egorin, M.J., Rosen, D.M., Benjamin, S.E., Callery, P.S., Sentz, D.L., Eiseman, J.L., 1997. In vitro metabolism by mouse and human liver preparations of halomon, an antitumor halogenated monoterpene. *Cancer Chemother. Pharmacol.* 41, 9-14.
- Fenical, W., 1975. Halogenation in the Rhodophyta: a review. *J. Phycol.* 11, 245-259.

- Freshwater, D.W., Tudor, K., O'Shaughnessy, K., Wysor, B., 2010. DNA barcoding in the red algal order Gelidiales: comparison of COI with *rbcL* and verification of the barcoding gap. *Cryptogamie. Algologie* 31, 435-449.
- Frézal, L., Leblois, R., 2008. Four years of DNA barcoding: current advances and prospects. *Infect., Genet. Evol.* 8, 727-736.
- Fuller, R.W., Cardellina, J.H., Jurek, J., Scheuer, P.J., Alvaradolindner, B., McGuire, M., Gray, G.N., Steiner, J.R., Clardy, J., Menez, E., Shoemaker, R.H., Newman, D.J., Snader, K.M., Boyd, M.R., 1994. Isolation and structure activity features of halomon-related antitumor monoterpenes from the red alga *Portieria bornemannii* *J. Med. Chem.* 37, 4407-4411.
- Fuller, R.W., Cardellina, J.H., Kato, Y., Brinen, L.S., Clardy, J., Snader, K.M., Boyd, M.R., 1992. A pentahalogenated monoterpene from the red alga *Portieria bornemannii* produces a novel cototoxicity profile against a diverse panel of human tumor cell lines *J. Med. Chem.* 35, 3007-3011.
- Guiry, M.D., Guiry, G.M., 2011. AlgaeBase. World-wide electronic publication, National University of Ireland, Galway. <http://www.algaebase.org>; searched on 19 June 2011.
- Hay, M.E., 2009. Marine chemical ecology: Chemical signals and cues structure marine populations, communities, and ecosystems. *Annual Review of Marine Science* 1, 193-212.
- Hay, M.E., Fenical, W., 1996. Chemical ecology and marine biodiversity: insights and products from the sea. *Oceanography* 9.
- Hebert, P.D.N., Cywinska, A., Ball, S.L., DeWaard, J.R., 2003. Biological identifications through DNA barcodes. *Proceedings of the Royal Society of London Series B-Biological Sciences* 270, 313-321.
- Heled, J., Drummond, A.J., 2010. Bayesian Inference of Species Trees from Multilocus Data. *Mol. Biol. Evol.* 27, 570-580.
- Hickerson, M.J., Meyer, C.P., Moritz, C., 2006. DNA barcoding will often fail to discover new animal species over broad parameter space. *Syst. Biol.* 55, 729-739.
- Hudson, R.R., Coyne, J.A., 2002. Mathematical consequences of the genealogical species concept. *Evolution* 56, 1557-1565.
- Jha, R.K., Zi-rong, X., 2004. Biomedical compounds from marine organisms. *Mar. Drugs* 2, 123-146.
- Jørgensen, R., Merrill, A.R., Andersen, G.R., 2006. The life and death of translation elongation factor 2. *Biochem. Soc. Trans.* 34, 1-6.
- Knowles, L.L., Carstens, B.C., 2007. Delimiting species without monophyletic gene trees. Symposium on Species Delimitation - New Approaches for Discovering Diversity, Stony Brook, NY, pp. 887-895.
- Knowlton, N., 1993. Sibling species in the sea. *Annu. Rev. Ecol. Syst.* 24, 189-216.
- Kuniyoshi, M., Oshiro, N., Miono, T., Higa, T., 2003. Halogenated monoterpenes having a cyclohexadienone from the red alga *Portieria bornemannii*. *J. Chin. Chem. Soc.* 50, 167-170.
- Le Gall, L., Saunders, G.W., 2007. A nuclear phylogeny of the Florideophyceae (Rhodophyta) inferred from combined EF2, small subunit and large subunit ribosomal DNA: Establishing the new red algal subclass Corallinophycidae. *Mol. Phylogen. Evol.* 43, 1118-1130.
- Leliaert, F., Verbruggen, H., Wysor, B., De Clerck, O., 2009. DNA taxonomy in morphologically plastic taxa: Algorithmic species delimitation in the *Boodlea* complex (Chlorophyta: Cladophorales). *Mol. Phylogen. Evol.* 53, 122-133.
- Lyngbye, H.C., 1819. Tentamen hydrophytologiae danicae continens omnia hydrophyta cryptogama Daniae, Holsatae, Faeroae, Islandiae, Groenlandiae hucusque cognita, systematice disposita, descripta et iconibus illustrata, adjectis simul speciebus norvegicis. typis Schultzianis, in commissis Librariae Gyldendaliae., Hafniae [Copenhagen].
- Maddison, W.P., 1997. Gene trees in species trees. *Syst. Biol.* 46, 523-536.
- Maggs, C.A., Verbruggen, H., De Clerck, O. (Eds.), 2007. 6 Molecular systematics of red algae: building future structures on firm foundations.
- Markmann, M., Tautz, D., 2005. Reverse taxonomy: an approach towards determining the diversity of meiobenthic organisms based on ribosomal RNA signature sequences. *Philosophical Transactions of the Royal Society B: Biological Sciences* 360, 1917.

- Matlock, D.B., Ginsburg, D.W., Paul, V.J., 1999. Spatial variability in secondary metabolite production by the tropical red alga *Portieria bornemannii*. *Hydrobiologia* 399, 267-273.
- Meier, R., Shiyang, K., Vaidya, G., Ng, P.K.L., 2006. DNA barcoding and taxonomy in Diptera: a tale of high intraspecific variability and low identification success. *Syst. Biol.* 55, 715-728.
- Meñez, E.G., Calumpong, H.P., Newman, D.J., West, J.A., 1996. An account of the red alga *Portieria bornemannii* (Gigartinales, Rhodophyllidaceae) from the Philippines. *Nova Hedwigia* 112, 161-170.
- Meng, C., Kubatko, L.S., 2009. Detecting hybrid speciation in the presence of incomplete lineage sorting using gene tree incongruence: A model. *Theor. Popul. Biol.* 75, 35-45.
- Meyer, C.P., Paulay, G., 2005. DNA barcoding: Error rates based on comprehensive sampling. *PLoS Biol.* 3, 2229-2238.
- Millar, A.J.K., Van Reine, W.F.P., 2005. Marine benthic macroalgae collected by Vieillard from New Caledonia and described as new species by Kützinger. *Phycologia* 44, 536-549.
- Molinski, T.F., Dalisay, D.S., Lievens, S.L., Saludes, J.P., 2008. Drug development from marine natural products. *Nature Reviews Drug Discovery* 8, 69-85.
- Monaghan, M.T., Balke, M., Gregory, T.R., Vogler, A.P., 2005. DNA-based species delineation in tropical beetles using mitochondrial and nuclear markers. *Philosophical Transactions of the Royal Society B-Biological Sciences* 360, 1925-1933.
- Monaghan, M.T., Wild, R., Elliot, M., Fujisawa, T., Balke, M., Inward, D.J.G., Lees, D.C., Ranaivosolo, R., Eggleton, P., Barraclough, T.G., Vogler, A.P., 2009. Accelerated species inventory on Madagascar using coalescent-based models of species delineation. *Syst Biol* 58, 298-311.
- Naylor, S., Hanke, F.J., Manes, L.V., Crews, P., 1983. Chemical and biological aspects of marine monoterpenes. *Fortschritte Der Chemie Organischer Naturstoffe, LXIV.* 44, 189.
- Nordborg, M., 2003. Coalescent Theory. In: Balding, D., Bishop, M., Cannings, C. (Eds.), *Handbook of Statistical Genetics*. John Wiley and Sons Ltd, New York, pp. 602-635.
- O'Meara, B.C., 2010. New Heuristic Methods for Joint Species Delimitation and Species Tree Inference. *Syst. Biol.* 59, 59-73.
- Paul, V.J., Ritson-Williams, R., Sharp, K., 2011. Marine chemical ecology in benthic environments. *Nat. Prod. Rep.*
- Polzin, J.J., Rorrer, G.L., Cheney, D.P., 2003. Metabolic flux analysis of halogenated monoterpene biosynthesis in microplantlets of the macrophytic red alga *Ochtodes secundiramea*. *Biomol. Eng.* 20, 205-215.
- Pons, J., Barraclough, T.G., Gomez-Zurita, J., Cardoso, A., Duran, D.P., Hazell, S., Kamoun, S., Sumlin, W.D., Vogler, A.P., 2006. Sequence-based species delimitation for the DNA taxonomy of undescribed insects. *Syst. Biol.* 55, 595-609.
- Provan, J., Murphy, S., Maggs, C.A., 2004. Universal plastid primers for Chlorophyta and Rhodophyta. *Eur. J. Phycol.* 39, 43-50.
- Puglisi, M.P., Paul, V.J., 1997. Intraspecific variation in the red alga *Portieria bornemannii*: Monoterpene concentrations are not influenced by nitrogen or phosphorus enrichment. *Mar. Biol.* 128, 161-170.
- Rao, C. S. P. The life-history and reproduction of *Polyides caprinus* (Gunn.) Papenf. *Ann. Bot.*, 2, 20, 211-230.
- Robba, L., Russell, S.J., Barker, G.L., Brodie, J., 2006. Assessing the use of the mitochondrial *cox1* marker for use in DNA barcoding of red algae (Rhodophyta). *Am. J. Bot.* 93, 1101-1108.
- Saunders, G.W., 2005. Applying DNA barcoding to red macroalgae: a preliminary appraisal holds promise for future applications. *Philosophical Transactions of the Royal Society B-Biological Sciences* 360, 1879-1888.
- Silva, P.C., Meñez, E.G., Moe, R.L., 1987. *Catalog of the benthic marine algae of the Philippines*. Smithsonian Institution Press, Washington, D.C.
- Silva, P.C., Basson, P.W., Moe, R.L., 1996. *Catalogue of the benthic marine algae of the Indian Ocean*. Univ of California Pr.

- Sites, J.W., Marshall, J.C., 2003. Delimiting species: a Renaissance issue in systematic biology. *Trends Ecol. Evol.* 18, 462-470.
- Smit, A.J., 2004. Medicinal and pharmaceutical uses of seaweed natural products: a review. *J. Appl. Phycol.* 16, 245-262.
- Verbruggen, H., De Clerck, O., Kooistra, W., Coppejans, E., 2005. Molecular and morphometric data pinpoint species boundaries in *Halimeda* section *Rhipsalis* (Bryopsidales, Chlorophyta). *J. Phycol.* 41, 606-621.
- Vogler, A.P., Monaghan, M.T., 2007. Recent advances in DNA taxonomy. *J. Zool. Syst. Evol. Res.* 45, 1-10.
- Wiens, J.J., Penkrot, T.A., 2002. Delimiting species using DNA and morphological variation and discordant species limits in spiny lizards (*Sceloporus*). *Syst. Biol.* 51, 69.
- Wise, M.L., Croteau, R., 1999. Monoterpene biosynthesis. *Comprehensive natural products chemistry* 2, 97-153.
- Wise, M.L., Rorrer, G.L., Polzin, J.J., Croteau, R., 2002. Biosynthesis of marine natural products: isolation and characterization of a myrcene synthase from cultured tissues of the marine red alga *Ochtodes secundiramea*. *Arch. Biochem. Biophys.* 400, 125-132.
- Wiseman, D.R., 1973. Morphological and taxonomic studies of the red algal genera *Ochtodes* and *Chondrococcus*. Department of Botany. Duke University, p. 234.
- Wiseman, D.R., 1975. On the status of the red algal family, the Rhizophyllidaceae (Gigartinales). *Taxon* 24, 489-490.
- Zanardini, G., 1851. Algae novae vel minus cognitae in mari Rubro a Portiero collectae. *Flora* 34, 33-38.
- Zuccarello, G.C., Sandercock, B., West, J.A., 2002. Diversity within red algal species: variation in world-wide samples of *Spyridia filamentosa* (Ceramiaceae) and *Murrayella pericladus* (Rhodomelaceae) using DNA markers and breeding studies. *Eur. J. Phycol.* 37, 403-417.
- Zuccarello, G.C., West, J.A., 2004. Multiple cryptic species: molecular diversity and reproductive isolation in the *Bostrychia radicans*/*B. moritziana* complex (Rhodomelaceae, Rhodophyta) with focus on North American isolates (vol 39, pg 948, 2003). *J. Phycol.* 40, 226-226.
- Zuccarello, G.C., West, J.A., Kamiya, M., King, R.J., 1999. A rapid method to score plastid haplotypes in red seaweeds and its use in determining parental inheritance of plastids in the red alga *Bostrychia* (Ceramiaceae). *Hydrobiologia* 401, 207-214.



## 2 MORPHOLOGY, VEGETATIVE AND REPRODUCTIVE DEVELOPMENT OF THE RED ALGA *PORTIERIA* (GIGARTINALES: RHIZOPHYLLIDACEAE)<sup>1</sup>

---

### Abstract

Earlier descriptions of the Indo-Pacific red alga *Portieria bornemannii* lacked detailed information on its vegetative and reproductive development and morphology. An in-depth treatment is presented on the development of the uniaxial thallus and the formation of male, female and tetrasporangial nemathecium. Post fertilization events and carposporophyte development are described, confirming Kylin's presumption on the development of connecting filaments between the carpogonium and the auxiliary cell following fertilization. Phylogenetic analysis using chloroplast encoded *rbcL* and nuclear ribosomal LSU gene sequences, including members of Rhizophyllidaceae and their close relatives suggests a monophyletic family. *Contarinia* is resolved as the sister taxon of a clade uniting *Nesophila*, *Ochtodes* and *Portieria*. The relationships among the latter genera remain largely unresolved.

Keywords: *Portieria*; Rhizophyllidaceae; Indo-Pacific; Morphology; Vegetative; Reproductive; Phylogeny

<sup>1</sup> Published as: Payo, D.A., Calumpong, H., De Clerck, O., 2011. Morphology, vegetative and reproductive development of the red alga *Portieria bornemannii* (Gigartinales: Rhizophyllidaceae). *Aquat. Bot.* 95, 94-102.

## 2.1 Introduction

*Portieria* Zanardini is a small red algal genus with seven currently accepted species that are widely distributed in tropical and subtropical waters of the Indo-West Pacific Ocean (Guiry and Guiry, 2010, Silva and Menez 1987). *Portieria* belongs to the family Rhizophyllidaceae. The family, erected by Schmitz (1889), was based on the genus *Rhizophyllis*, which is currently regarded as a synonym of *Contarinia* (Denizot, 1968). Wiseman (1975) proposed the retention of the family Rhizophyllidaceae against Denizot's Contariniaceae on the basis that *Rhizophyllis* is a legitimate synonym of *Contarinia* and is the basionymic stem of the family. Its members are characterized with flattened or cylindrical thalli, uniaxial or biaxial, prominent or not so prominent central axis, large gland cells, spermatangia and tetrasporangia in sessile nemathecia and female globular nemathecia (Kylín, 1956; Wiseman, 1975; Millar, 1990; Abbott, 1999; Oliveira et al., 2005). Rhizophyllidaceae is among the nemathecia-bearing families of the order Gigartinales which now only includes 28 members as more recently, Peyssonelliaceae, became an order of its own (Saunders et al., 2004; Krayesky et al., 2009; Verbruggen et al., 2010). The family includes 4 genera: *Contarinia*, *Ochtodes*, *Nesophila* and *Portieria*. The genera have interesting biogeographic distributions with each genus exhibiting a near exclusive distribution. The genus *Contarinia* is known with certainty only from the Mediterranean Sea and Atlantic coast of northwestern Morocco, Portugal, and Spain (Feldmann, 1939; Benhissoune et al., 2002; Berecibar et al., 2009; Peña and Bárbara, 2010). Two additional species, *C. okamurae* Segawa and *C. pacifica* (Børgesen) Denizot have been reported from Japan and in Easter Island respectively but their identity requires confirmation. *Ochtodes*, *Portieria* and *Nesophila* are endemic to the Caribbean, Indo-Pacific, and New Zealand, respectively. The generic concept of *Portieria* has been solely based on observations of structural characters (Zanardini, 1851).

The vegetative and reproductive developments have been studied in detail only for a few members of the Rhizophyllidaceae. Detailed treatments of the structure of *Ochtodes secundiramea* were provided by Joly and Ugadim (1966) and Wiseman (1976, 1977). *Contarinia squamariae* was studied by Denizot (1968) and more recently by Berecibar et al. (2009). All other species remain largely unstudied. This includes the genus *Portieria*. The earliest accounts on *Portieria* (often as *Desmia* and *Chondrococcus*; see Silva et al. 1987 for details on the generic synonymy) were limited to general descriptions (Lyngbye, 1819; Zanardini, 1851; Kützing, 1867; Agardh, 1876). Kylín (1930, 1956) provided a more detailed account of the

vegetative and the reproductive structures of *Portieria* which included illustrations of the male reproductive structures, auxiliary filaments in the female nemathecium and tetrasporangia. Fine details of early post fertilization events, however, were not presented. The genus was studied in detail by D. Reid Wiseman (1973) but these results were never published.

In this paper, we provide a more detailed account of *Portieria bornemannii*'s vegetative and reproductive development, with an emphasis on post fertilization development. We will interpret the developmental relationships among genera and relate them to phylogenetic observations.

## 2.2 Materials and methods

### 2.2.1 Morphological analysis

Reproductive and non-reproductive *P. bornemannii* samples were collected from different locations in the Indo-Pacific from 1980 to 1997. Observations were made on specimens preserved in 5% formalin-seawater solution. Fine cross sections of the thallus were made by hand using a single or double-edged blade. To observe reproductive structures, nemathecium-bearing tissues were squashed. Whole axial cells were observed by making a slight longitudinal cut along the axis of a piece of thallus and pressing it with cover slip to split the tissue which further reveals the cells. Whole-mount and sectioned materials were stained with 1% aniline blue solution, fixed with a drop of 10% HCl, rinsed with distilled water and mounted in Karo syrup for preservation. To reveal presence of nuclei, bleached tissue sections were stained with Wittmann's aceto-iron-haematoxylin-chloral-hydrate solution. Excess water was removed from tissue sections before application of staining solution. The stain was allowed to stay on the material for at least 30 minutes before adding 45% acetic acid on one edge of the cover slip to destain. Excess acid was drained from the opposite side of the cover slip using an absorbent paper. Hoyer's mounting medium (1:1 distilled water) was applied next from one side of the cover slip and was allowed to stand for about an hour. The mounting medium was removed with acetic acid and finally, mounted using Karo syrup. Further details of this procedure are described in Wittmann (1965) and Hommersand et al. (1992). Photographs were taken with an Olympus DP50 digital camera or Olympus Colorview IIIu digital color camera mounted on a Leitz Diaplan or BX51 Olympus compound microscope, or Leica Wild M10 stereo microscope. Specimens are housed at the herbarium of Ghent University (GENT).

### 2.2.2 *Molecular analysis*

DNA sequences were either retrieved from Genbank or generated for this study. DNA was extracted from silica dried material and informative loci amplified and sequenced according to De Clerck et al. (2005). Primers used for amplification were derived from Wang et al. (2000) and Wilkes et al. (2005) for *rbcL* gene and Harper and Saunders (2001) for the LSU nrRNA gene. Generated sequences were edited using BIOEDIT 7.0.9.0 (Hall, 1999) and were aligned together with Genbank sequences using MAFFT (**M**ultiple **A**lignment using **F**ast **F**ourier **T**ransform) (Kato and Toh, 2008). The alignments included 7 taxa consisting four members of Rhizophyllidaceae and three genera of closely related families (Dumontiaceae, Kallymeniaceae, and Polyidaceae). The initial alignment of the LSU nrRNA gene contained 2817 bases but was finally reduced to 2659 bases, excluding 158 positions from regions difficult to align. The *rbcL* alignment included 1430 bases. The concatenated alignment of the two genes included 4088 positions. Phylogenetic analyses were performed on three datasets: DNA sequences of the LSU nrRNA gene, *rbcL* gene, and concatenated sequences of the two. The three datasets were exported for phylogenetic analysis to MEGA 4.0.2 (Tamura et al., 2007) for initial Neighbour Joining (NJ) analyses. The concatenated dataset was exported to PhyML (Guindon et al., 2009) for Maximum Likelihood (ML) analyses, and to MrBayes 3.0 (Huelsenbeck and Ronquist, 2001) for Bayesian Inference (BI). The model of nucleotide substitution used for ML was General Time Reversible (GTR), determined using Modeltest 3.7 (Posada and Crandall, 1998) according to the Akaike information criterion (Posada and Buckley, 2004). PhyML was set to estimate the proportion of invariable sites, consider 4 substitution rate categories, estimate the gamma distribution parameter, use BIONJ as an input tree, and to conduct a non-parametric bootstrap analysis of 100 replicates. Bayesian analysis was performed using a GTR + I +  $\Gamma$  model. The data set was divided in two partitions, corresponding to the *rbcL* and LSU nrRNA genes, with all model parameters uncoupled between the partitions. Posterior probabilities were estimated using a Metropolis-coupled Markov chain Monte Carlo approach with sampling according to the Metropolis–Hastings algorithm. The analysis used four chains, one cold and three incrementally heated. Each run consisted of 1000000 generations and was sampled every 1000 generation. Burnin value was determined using TRACER V1.4 (Rambaut and Drummond, 2007) and was set at 100 generations.

---

## 2.3 Results

### 2.3.1 *Portieria*

Forty-two *P. bornemannii* specimens spanning the Indo-Pacific were morphologically examined for its vegetative and reproductive development (Table 2.1).

### 2.3.2 *Description*

Thallus erect, color varying from greenish pink to dark red, older specimens becoming orange to brown. Freshly collected specimens exhibiting a strong pungent smell. Thalli attached with a discoid holdfasts or with a crust like base, sometimes entangled among other seaweeds lacking a clear holdfast. One to several axes arising from the base, growing to a height of 3- 15 cm (Fig. 2.1a-e). Main axes compressed, 300- 1800  $\mu\text{m}$  wide near the base, gradually narrowing towards the apices, up to 1100  $\mu\text{m}$  thick near the base; alternately branched up to four to five orders. Apices typically incurved, sometimes straight in newly developing axes (Fig. 2.2a and b). Epiphytic specimens often with curled, entwined axes, secondarily attached to one another by hapteres (Fig. 2.2c).

Table 2.1. List of specimens used in morphological analyses.

Specimen number	Place of collection	Date of collection	Habitat	Collector
DAP102, DAP210, DAP211, DAP212, DAP213, DAP299, DAP713	Dapdap, Siquijor, Siquijor, Philippines	17.02.2007 14.04.2007	Found from 1 to 1.5 m depth on rocks and dead corals exposed to waves	D.A. Payo
DAP167	Daang-Lungsod, Alcoy, Cebu, Philippines	14.03.2007	Found in a site with patchy dead corals	D.A. Payo
DAP202, DAP203, DAP204, DAP378, DAP389	Takot Sawang, Tambisan, San Juan, Siquijor, Philippines	17.03.2007	In an offshore reef either epilithic, epiphytic or unattached	D.A. Payo
DAP247, DAP249, DAP251	Airport side, Silliman Beach, Dumaguete, Negros Oriental, Philippines	30.03.2007	Epilithic on rocks by the airport	D.A. Payo
DAP285, DAP288	Pasig Reef, Maydolong, Eastern Samar, Philippines	08.04.2007	In an offshore reef exposed to strong waves	D.A. Payo
DAP333, DAP337, DAP338, DAP339, DAP342, DAP344, DAP345, DAP346	White Beach, Mahatao, Batanes, Philippines	21.04.2007	In a furrowed intertidal area exposed to strong waves	D.A. Payo
DAP363, DAP366, DAP368	Chanaryan, Basco, Batanes, Philippines	22.04.2007	In an intertidal area exposed to strong waves	D.A. Payo
HEC4217	Laing Island, Hansa Bay, Bogia, Madang Province, Papua New Guinea	05.1980	Found at the base of a coral, among <i>Halimeda</i> at 2 m depth	E. Coppejans
HV584	Logon Bay, Malapascua Is., Philippines	22.01.2004	Epiphytic located in an intertidal flat	H. Verbruggen
HV646	Olango, Cebu, Philippines,	25.01.2004	Intertidal flat, epiphytic	H. Verbruggen
KZN027	Zinkwazi, Black Rock Park, South Africa, KZN1485 Port O'Call, Trafalgar, Kwazulu-Natal, South Africa	23.12.1999	Intertidal rock pools	O. De Clerck
KZN2027	Palm Beach, Kwazulu-Natal, South Africa	07.02.2001	Intertidal	O. De Clerck
KZN2056	Trafalgar, Kwazulu-Natal, South Africa	08.02.2001	Intertidal	O. De Clerck
MAS264	Masirah Is., Oman		Epilithic at 2.5 m depth	T. Schils
ODC906	Kaalawai, Oahu, Hawaii	26.04.2003	Shallow subtidal	O. De Clerck
ODC1077	Mzamba, Eastern Cape Province	21.08.2005	Intertidal rock pools and shallow subtidal	O. De Clerck
ODC1160, ODC1164	Palm Beach, Kwazulu-Natal, South Africa	22.08.2005		O. De Clerck
SOC030	Nojid, Rhiy di-Qatanhin, Socotra Archipelago, Socotra, Yemen		Fossil reef rock platform, epilithic, shallow subtidal,	F. Leliaert
SOC154	Rhiy di-Irisalepilithic, Socotra Archipelago, Socotra, Yemen		Epilithic, subtidal, and exposed	F. Leliaert

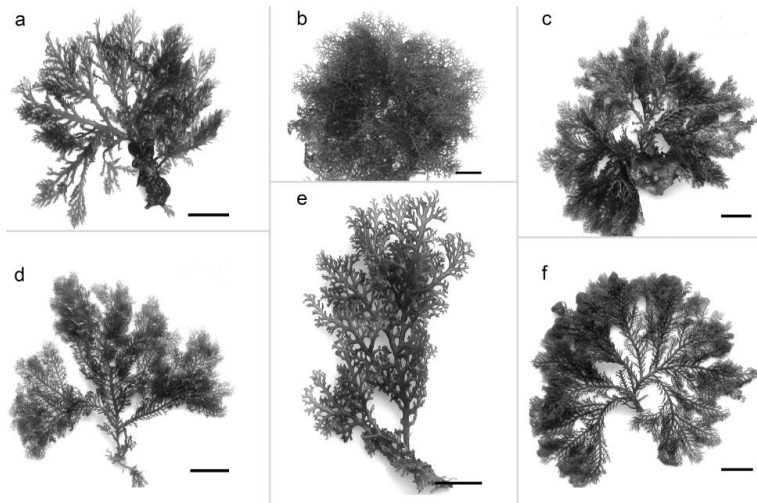

Fig. 2.1. General morphology of *P. bornemannii*. Scale bar: 10mm. (a) DAP703, Dapdap, Siquijor, Siquijor. (b) Sawang, Siquijor. (c) DAP337, White Beach, Mahatao, Batanes (d) DAP345, White Beach, Mahatao, Batanes (e) DAP368, Chanaryan, Basco, Batanes (f) DAP336, White Beach, Mahatao, Batanes.

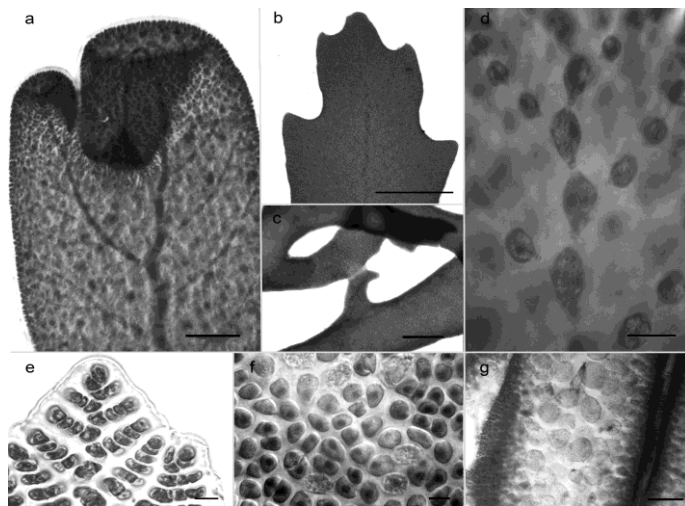

Fig. 2.2. Vegetative morphology of *P. bornemannii*. (a) Typically inrolled tip of a major axis. Scale bar: 100  $\mu\text{m}$ . (b) Newly developing flat apex. Scale bar: 100  $\mu\text{m}$ . (c) Detail of a haptere anastomosing separate branches. Scale bar: 0.5 mm. (d) Longitudinal optical section of the axial filament and the alternating distichous pattern of primary lateral periaxial cells. Scale bar: 100  $\mu\text{m}$ . (e) Detail of the apex and the abaxial branching pattern of the distichous primary lateral filaments. Scale bar: 10  $\mu\text{m}$ . (f) Surface view of cortical cells. Scale bar: 10  $\mu\text{m}$ . (g) Medullary cells in cross sectional view. Scale bar: 100  $\mu\text{m}$ .

Thallus uniaxial; apical cell conspicuous, dome-shaped, 5- 6  $\mu\text{m}$  x 4-7  $\mu\text{m}$  dimensions. Growth of an indeterminate axis takes place by oblique division of the apical cell with the high side of successive axial cells alternating in a single plane (1/2 divergence). Each axial cell cuts off a first periaxial cell (the initial of a lateral filament) 1 – 2 cells below the apex, in an alternating distichous pattern (Fig. 2.2d and e). A second periaxial cell is cut off towards the dorsal surface (i.e. away from the inrolled apex) approximately 7- 9 cells below the apex. Two additional periaxial cells, one situated below the first periaxial cell and another one at the ventral surface are then cut off. The first periaxial cell forms a lateral determinate filament. The other periaxial cells do not develop so extensively and contribute mostly to the thickness of the axes. There seems to be no strict pattern in the sequence of periaxial cell formation nor are there always four periaxial cells formed per segment. At least three periaxial cells are produced from each axial cell. The first periaxial cells divide to produce a lateral determinate filament, up to 10 cells long, which are largely responsible for the lateral expansion of the axes. Each of the cells of a lateral filament cuts off up a dorsal, ventral and abaxial cell. The abaxial cell forms a dominant filament, resulting to a secund pattern (Fig. 2.2e). The dorsal and ventral cell form comparatively shorter filaments, contributing only to the thickness of the thallus. Peripheral cells will differentiate to form a small-celled cortical layer up to 3 layers thick. Cortical cells measure 5 x 10.3  $\mu\text{m}$  in surface view (Fig. 2.2f). Internal cells enlarge and will form a medulla, up to 3 layers thick in the central part of the thallus (Fig. 2.2g). Medullary cells are up to 160  $\mu\text{m}$  in diameter. Gland cells, 8 - 25  $\mu\text{m}$  in diameter, are formed from the subcortical cells and abound all throughout the thallus (Fig. 2.3a). They can also be found in the nemathecium. Gland cells are situated just below the surface and are surrounded by a ring of 5- 7 cortical cells (Fig. 2.3a). The shape of the axial cell changes markedly in older portions of the thallus. About 3 segments below the apex, the axial cell elongates, becoming 3.5 times longer than broad. At the middle part of the thallus, the axial cell becomes barrel-shaped (210- 270  $\mu\text{m}$  x 50- 90  $\mu\text{m}$ ), and the pit connections separating successive axial cells become very prominent (Fig. 2.3b). The enlarged axial cell contain up to 10 nuclei which stain prominently with aniline blue and haematoxylin solution (Fig. 2.3c). In the basal portions of the thallus, the midsection of the axial cell shrinks, becoming barbell-shaped (Fig. 2.3d).



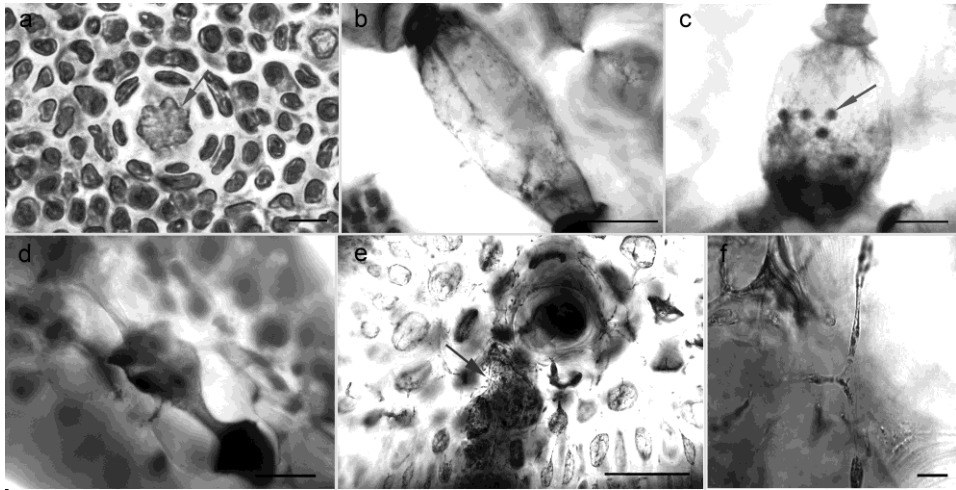

Fig. 2.3. Vegetative morphology of *P. bornemannii*. (a) Surface view of a conspicuously depressed, large gland cell surrounded by a ring of cortical cells. Scale bar: 10  $\mu\text{m}$ . (b, c) Detail of a barrel-shaped, multinucleate axial cell. In (c) arrow points to a nucleus. Scale bar: 100  $\mu\text{m}$ . (d) Dumb-bell-shaped axial cells observed at the thallus base. Scale bar: 100  $\mu\text{m}$ . (e) Arrow points to rhizoidal filaments found at the thallus base. Scale bar: 100  $\mu\text{m}$ . (f) Detail of the rhizoidal cells. Scale bar: 10  $\mu\text{m}$ .

At the base of the thallus, multinucleated narrow rhizoidal filaments are issued from the axial cells, extending towards the medullary cells, finally passing between cortical cells towards the periphery of the thallus (Fig. 2.3e and f). Secondary pit connections are not formed. Indeterminate branches are formed every 2- 10 mm. Similar to the formation of determinate laterals, indeterminate branches are also formed in the same plane. Indeterminate branches originate in a holoblastic manner, i.e. being formed in addition to the periaxial cells. The branching pattern of the newly formed axes repeats that of the main axes.

### 2.3.3 Reproductive morphology

Gametophytes are dioecious. Spermatangial branches are borne in sessile nematocia which vary in size and shape (258- 864  $\mu\text{m}$  x 129- 748  $\mu\text{m}$ ) and are produced on the thallus surface (Fig. 2.4a). Spermatangial filaments are compactly arranged in the nematocia. Sterile paraphyses are absent but gland cells may be observed. Fully developed spermatangial branches are enveloped in a mucilaginous coating and reach 30- 147  $\mu\text{m}$  long. The spermatangial branches cut off at least 9-

10 spermatia (3- 5 $\mu$ m). Development of the branch begins with a round basal cell cutting off two cells that elongate and divide into a 4 to 6-celled filament (Fig. 2.4b and c). The cells forming the new spermatangial filament serve as the initials for the spermatia. Up to 3 spermatia are formed per cell (Fig. 2.4d and e).

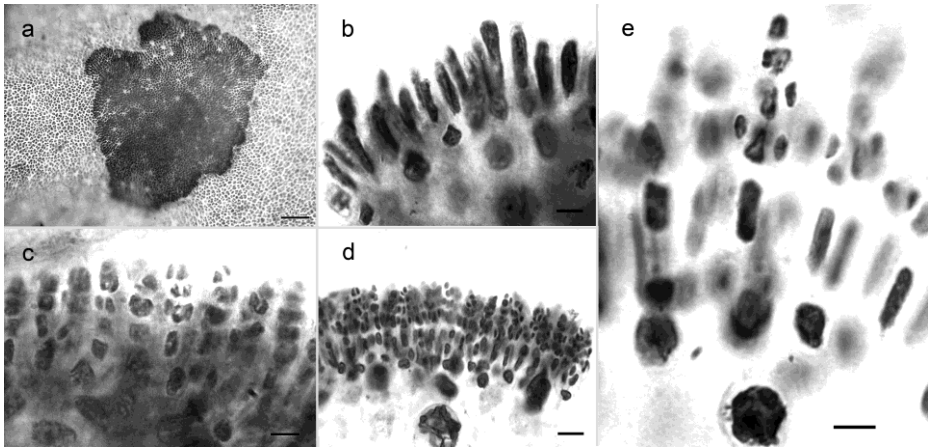

Fig. 2.4. Development of male reproductive structures in *P. bornemannii*. (a) Surface view of a sessile nemathecium. Scale bar: 100  $\mu$ m. (b) Transverse section of elongated daughter cells originating from a basal cell during the early development of spermatangial filaments. Scale bar: 10  $\mu$ m. (c) Daughters cells formed from subsequent peri- and anticlinal cell division of the elongated cells. Scale bar: 10  $\mu$ m. (d) Fully developed spermatangial branches. Scale bar: 100  $\mu$ m. (e) A mature spermatangial branch bearing spermatia. Scale bar: 10  $\mu$ m.

Globular cystocarps (300- 500  $\mu$ m) are borne on either side of the thallus at the base of the ultimate or penultimate lateral branchlets. Carpogonial and auxiliary branches occur in the same nemathecium (Fig. 2.5a-Fig. 2.5c). The carposporophyte development is non-procarpic (Fig. 2.5d-j). Early development of a nemathecium starts with cortical cells cutting off two initials from which auxiliary filaments, carpogonial branches and sterile paraphyses develop. Every mature auxiliary and carpogonial branch is paired with a sterile filament. Paraphyses, 60- 80  $\mu$ m long, are unbranched except for the distal end. In the development of the auxiliary branch, an apical initial undergoes two or three periclinal divisions to form a three or sometimes four-celled branch, consisting of a darkly staining basal cell (7- 18  $\mu$ m x 3- 7  $\mu$ m), an auxiliary cell (4- 7  $\mu$ m x 4- 7  $\mu$ m) and a terminal cell (6- 8  $\mu$ m x 4-6  $\mu$ m). The basal cell is markedly broader and longer compared to the auxiliary and terminal cells.

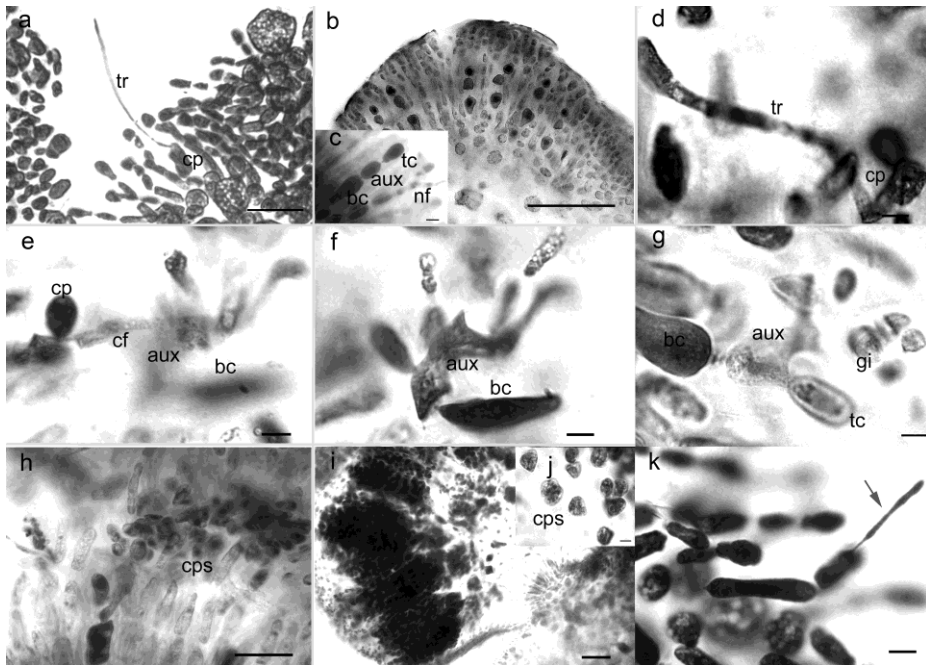

Fig. 2.5. Female reproductive structures and carposporophyte development in *P. bornemannii*. (a) Unfertilized carpogonial branch - trichogyne (tr) and carpogonium (cp). Scale bar: 50  $\mu$ m. (b) Several auxiliary branches in a nemathecium. Scale bar: 50  $\mu$ m. (c) Auxilliary branch - basal cell (bc), auxilliary cell (aux), and terminal cell (tc) and a sterile nemathecium filament (nf). Scale bar: 10  $\mu$ m. (d) Fertilized carpogonium. Scale bar: 10  $\mu$ m. (e) and (f) A connecting filament (cf) connects the carpogonium to the auxilliary cell. Scale bar: 10  $\mu$ m. (g) Gonimoblast initial (gi) developing from auxilliary cell. Scale bar: 10  $\mu$ m. (h) A developing carposporophyte. Scale bar: 50  $\mu$ m. (i) Cross section of a cystocarp with fully developed gonimoblasts. Scale bar: 100  $\mu$ m. (j) Carpospores (cps). Scale bar: 10  $\mu$ m. (k) Hair cell from a sterile nemathecium filament. Scale bar: 10  $\mu$ m.

The basal cell and terminal cell may have nutritive purposes for the developing gonimoblasts after fertilization. Carpogonial branches were only rarely observed. Four-celled carpogonial branches which include a basal cell, a subhypogynous cell, a hypogynous cell, and a terminal carpogonium with trichogyne (133  $\mu$ m long) reach a length of about 178  $\mu$ m. The formation of the branch begins with periclinal division of an apical initial. The resulting two cells undergo substantial elongation with the upper cell subsequently forming a long extension. The initial further undergoes anticlinal division resulting to a 3 or 4-celled branch with the terminal cell becoming the carpogonium with a trichogynal extension. Only a short receptive portion of the trichogynal process projects above the rest of the nemathecium filaments. Hair cells can also be found in the nemathecium and can be mistaken as a trichogyne of a carpogonial branch (Fig. 2.5k). Following fertilization,

subhypogynous and hypogynous cells fuse with the carpogonium and produce a non-septate connecting filament (Fig. 2.5d-e). The connecting filament fuses with an auxiliary cell which then begins to extend at its upper tip, reorienting obliquely evading the terminal cell. From the expanded auxiliary cell, several gonimoblast initials are issued from which carpospores develop (Fig. 2.5g). After fertilization and before fusing with the connecting filament of a carpogonial branch, the auxiliary cell appears completely stretched and loses its deep staining character. Even after the appearance of gonimoblast initials, auxiliary cell remains attached to the basal and terminal cells. The basal cell of the auxiliary branch forms a distinctive stalk and does not participate in the carpospore development. Succeeding divisions of carpospores occurs in all directions, which explains the irregularly globular structure of a nemathecium. A well-documented post-fertilization pattern reported in other genera within Gigartinales (e.g. *Dudresnaya*, *Gigartina*, *Kallymenia*, and *Waernia*) (Robins and Kraft, 1985; Hommersand and Fredericq, 1990; Hommersand et al., 1992; Wilce et al., 2003, Rodriguez-Prieto and Hommersand, 2009) is suggested in *Portieria*. The presence of a conspicuous number of auxiliary branches within a nemathecium compared to a rather obscure presence of a carpogonial branch most likely suggests that a single carpogonial branch when fertilized, produces several copies of the now diploid nucleus, forms several connecting filaments, and deposits a nucleus to a number of auxiliary branches, such that a single fertilization can produce several gonimoblasts. As observed, a single connecting filament can form a continuous link among succeeding auxiliary cells forming a long chain. Within the nemathecium, clusters of carpospores are separated into pockets by a thin layer of sterile cells. The entire nemathecium is covered by a mucilaginous coating.

Tetrasporangial nemathecium are initially formed on the surfaces of the ultimate and penultimate branches and later spread out in the entire thallus with only small surfaces free of tetrasporangia (Fig. 2.6a). They are enclosed in a flat, sessile nemathecium (258- 903  $\mu\text{m}$  x 129- 194  $\mu\text{m}$ ). Similar to the spermatangial nemathecium, sterile paraphyses are lacking. The entire nemathecium is also enclosed in a mucilaginous coating (Fig. 2.6b). Tetrasporangia (L - 25.6 -32.0  $\mu\text{m}$ ) are zonate and are transversely to obliquely divided. They develop from a basal cell originating from the cortex, which cuts off two tetrasporangial mother cells. These undergo meiosis and giving rise to four (sometimes 3- 6) haploid spores (Fig. 2.6b and c).

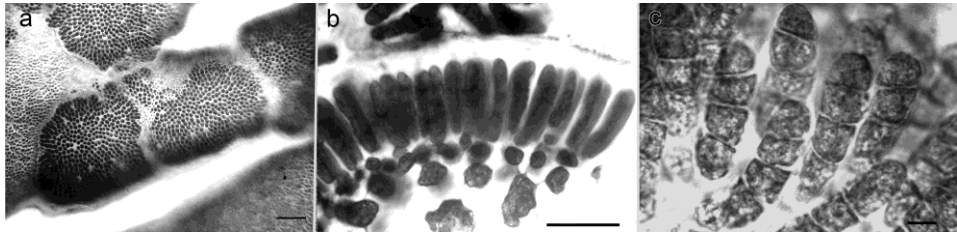

Fig. 2.6. Tetrasporore development in *P. bornemannii*. (a) Surface view of a tetrasporangial nemathecium. Scale bar: 100  $\mu\text{m}$ . (b) Compact arrangement of tetrasporangia covered in transverse section. Scale bar: 100  $\mu\text{m}$ . (c) Detail of zonately divided tetrasporangia. Scale bar: 10  $\mu\text{m}$ .

#### 2.3.4 Molecular phylogenetics

The molecular data set consisted of *rbcL* (1430 bp) and LSU nrRNA gene (2659 bp) sequences consisting of 4 Rhizophyllidacean genera and 3 closely related families (Dumontiaceae, Kallymeniaceae, and Polyidaceae) (Table 2.2). The two datasets were concatenated to include a total of 4088 characters, 997 of which were parsimony informative. The placements of the different genera within the Rhizophyllidacean clade were also inconsistent in the datasets. BI and ML trees inferred from the concatenated datasets of *rbcL* and LSU nrRNA genes showed an identical topology with an exclusive Rhizophyllidacean clade (Fig. 2.7). Bootstrap and BI support values of the family were high (100% for both) with *Kallymenia cribrosa* as the closest relative. Bootstrap and BI support values for intrageneric relationships were high (99- 100%) except for the low support on the node separating *Ochtodes* and *Nesophila* (46% and 75%, respectively). Branch lengths separating *Portieria*, *Nesophila* and *Ochtodes* are relatively short compared to the branch leading to *Contarinia*.

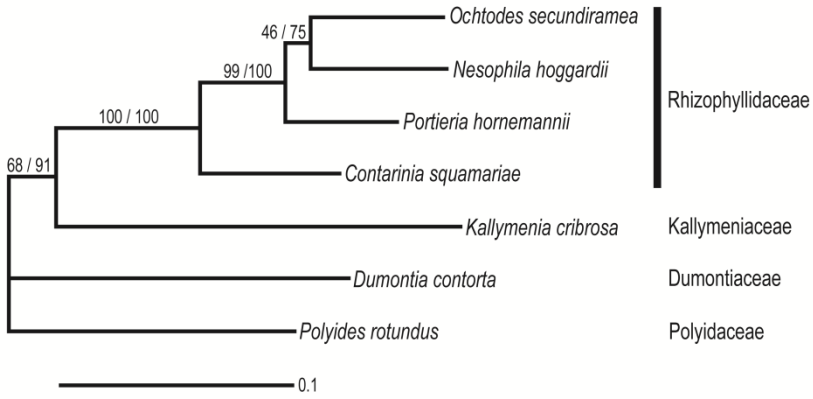

Fig. 2.7. Maximum likelihood phylogeny of family Rhizophyllidaceae based from combined *rbcL* and LSU nrRNA gene sequences. Node support values are given at each ramification (ML and BI). The log-likelihood value of the tree is -10542.80329. Base frequencies are A = 0.26209, C = 0.19951, G = 0.27892, T = 0.25949. The substitution rates are AC = 0.67945, AG = 2.29698, AT = 2.49003, CG = 0.88817, CT = 6.35790, GT = 1.0000. The proportion of invariable sites in the alignment is 0.504 and the shape parameter of the gamma distribution among site rate heterogeneity is 0.735.

Table 2.2. List of species used in the *rbcL* and LSU nrDNA analyses with accession numbers.

Species	Gene	Location	Collector, date	Accession	Specimen number	Source
<i>Portieria hornemannii</i> (Lyngbye) P.C. Silva	LSU nrDNA	Dapdap, Siquijor, Siquijor, Philippines	DA Payo, 15.03.2007		DAP213	This study
	<i>rbc L</i>	South Africa	S. Fredericq	AF212185		Fredericq et al., 1999
<i>Ochtodes secundiramea</i> (Montagne) M.A. Howe	LSU nrDNA	Rocher du Diamant, Martinique	D. and M. Littler		DML30919	This study
	<i>rbc L</i>	Baie Olive, Guadeloupe	A. Renoux	EU349209		Krayesky et al., 2007
<i>Nesophila hoggardii</i> W.A.Nelson & N.M.Adams	LSU nrDNA	Matu Kapiti I., New Zealand	W. Nelson 20.12.1994	EU349089		Krayesky et al., 2007
	<i>rbc L</i>	Matu Kapiti I., New Zealand	W. Nelson 20.12.1994	EU349210		Krayesky et al., 2007
<i>Contarinia squamariae</i> (Meneghini) Denizot	LSU nrDNA	Begur, Catalunya, Spain	O. De Clerck, 18.01.2008		ODC1498	This study
	<i>rbc L</i>	Begur, Catalunya, Spain	O. De Clerck, 18.01.2008		ODC1498	This study
<i>Kallymenia cribrosa</i> Harvey	LSU nrDNA	-	J.T Harper and G.W. Saunders	AY171611		Harper and Saunders, 2002
	<i>rbc L</i>	Australia: Tarcoola Beach	M.H. & F. Hommersand 21.09.1995	EU349216		Krayesky et al., 2007
<i>Polyides rotundus</i> (Hudson) Gaillon	LSU nrDNA	Pointe du Nid de Corbet, Audresselles, Nord-Pas de Calais, France	O. De Clerck, 16.09.2004		ODC1014	This study
	<i>rbc L</i>	Penmaich, Brittany, France	D.W. Freshwater	U04214		Fredericq et al., 1996
<i>Dumontia contorta</i> (S.G. Gmelin) Ruprecht	LSU nrDNA	Manomet Bluffs, Plymouth Co., MA, USA	M.H. Hommersand, 23.04.1993	EU349094		Krayesky et al., 2007
	<i>rbc L</i>	USA: Manomet Bluffs, Plymouth Co, MA	M.H. Hommersand, 23.04.1993	AY294378		Gavio and Fredericq, 2003

## 2.4 Discussion

Detailed observations of the vegetative morphology and reproductive structures are presented for the genus *Portieria* (formerly *Chondrococcus* and *Desmia*). Despite considerable variation in external morphology, all genera of the Rhizophyllidaceae share a similar basic structure, differing only in minor details. All genera are pseudoparenchymatous with inner cells differentiated into a cellular medulla while peripheral cells form a small-celled, pigmented cortical layer. Thin rhizoidal filaments are interspersed in the medullary region of all four genera. Secondary pit connections, although reported for the Rhizophyllidaceae by Millar (1990) as cited from Wiseman (1973), appear to be absent. Wiseman, however, did not mention presence of secondary pit connections in both *Ochtodes* and *Portieria*. Studies on *Nesophila* and *Contarinia* do not mention presence or absence of this character (Denizot, 1968; Nelson and Adams, 1996; Berecibar et al., 2009). Its absence might be a uniform characteristic of the family but this will need confirmation.

Another consistent vegetative character is the presence of large prominent gland cells located in the cortex. In *Portieria*, these cells are suspected to harbor halogenated monoterpenes (Meñez et al., 1996). The uniaxial growth pattern is shared with *Nesophila* and *Contarinia*, but not with *Ochtodes* in which growth is initiated by a pair of apical cells which give rise to a helicoid biaxis (Joly and Ugadim, 1966; Wiseman, 1976). A truly biaxial organization as observed in *Ochtodes* is unique within the red algae, but despite the fact that 2 axial filaments are formed the fundamental structure of the thallus is very similar to that observed in *Portieria*. The most important difference is presented by the number of periaxial cells which is cut off from each axial cell. In *Portieria* 3 or 4 periaxial cells are formed, compared to only 2 in *Ochtodes*. Unfortunately, this information is lacking for both *Contarinia* and *Nesophila*. The axial cells are large and prominent in all genera but the shape of the cells varies. In *Portieria*, the axial cells are barrel-shaped, multinucleate and possess conspicuously broad pit connections. The axial cells of *Nesophila*, *Ochtodes* and *Contarinia* appear long and cylindrical (Nelson and Adams, 1996; Berecibar et al., 2009).

Reproductive features are conserved in the Rhizophyllidaceae as suggested by Kylin (1956) and confirmed by the works of Wiseman (1977), Nelson & Adams (1996), Berecibar *et al.* (2009) and this study. Although Wiseman (1977) reports that *Ochtodes* can be procarpic and non-procarpic, members of the family are generally and perhaps, exclusively non-procarpic. The non-procarpic character as exhibited in



*Portieria* and the rest of the family, which permits a series of diploid nuclei transfer from a single fertilization, increases the certainty of successful continuation of a set of genetic characteristics. This reproductive strategy may be partially limiting in terms of genetic diversity compared to a procarpic one where carporsporophytes are potentially offsprings of different male gametes. This limitation is however compensated by the possibility of increased genetic recombination by meiosis during sporangial development (Hawkes, 1990).

The presence of male, female and tetrasporangial nemathecia are consistent throughout Rhizophyllidaceae. In *Portieria*, nemathecia are borne in both surfaces of the thallus. The upright habit of *Portieria* probably permits its presence on both surfaces as opposed to the creeping habit of *Contarinia* where nemathecia are formed on dorsal surfaces (Berecibar et al., 2009). This is probably particularly important for female gametophytes in achieving a greater settling surface for spermatia. While for tetrasporophytes and male gametophytes, the increased surface also allow for a greater number of spores. Tetrasporangia and spermatia are formed in nemathecia lacking sterile paraphyses. Tetrasporangia are zonately to irregularly zonately divided. Spermatia are formed by means of anticlinal divisions from a 4 to 6-celled filament. The female reproductive structures are likewise very similar among all four genera. Auxiliary and carpogonial cell filaments are produced in the same nemathecia interspersed with sterile nutritive filaments. The auxiliary cell filaments are usually 3 to 4-celled with a large basal cell subtending the auxiliary cell. Kylin (1956) was unable to observe the early post fertilization events in *Portieria*. From the structural observations, however, he hypothesized that the transfer of the diploid nucleus from carpogonium to the auxiliary cell would be mediated by means of a connecting filament. Wiseman in his unpublished thesis was also unable to follow the details of post-fertilization development with certainty in *Portieria*. Our observations clearly demonstrate that a connecting filament, issued from a fusion cell which includes the carpogonium, hypogynous and subhypogynous cell, fuses with a nearby auxiliary cell. These observations are congruent with those from *Ochtodes* (Wiseman, 1977) and *Contarinia* (Berecibar et al., 2009).

While the taxonomic position of the Rhizophyllidaceae in the order Gigartinales has been confirmed using small subunit (SSU) rDNA gene sequences (Tai et al., 2001; Saunders et al., 2004) and combined multi-gene datasets (Verbruggen et al., 2010), phylogenetic relationships within Rhizophyllidacean genera have not been examined. The close relationship of the genera of the Rhizophyllidaceae is confirmed by means of molecular sequence analyses, which resolves *Contarinia* as the sister taxon of a clade uniting *Nesophila*, *Ochtodes* and

*Portieria*. The relationships among the latter genera remain largely unresolved. In this respect, it is important that the genus *Contarinia* was represented in the analysis by *C. squamariae* and not by the type of the genus *Contarinia peyssonneliaeformis* Zanardini, which was unfortunately unavailable for the study. Especially the latter genus, with currently 5 species, remains highly understudied at present, and its monophyletic nature is all but certain. Future studies may reveal that *Contarinia* is present only in the Mediterranean Sea and warm temperate Eastern Atlantic Ocean, while all other species attributed to the genus belong to widely divergent lineages.

## 2.5 Acknowledgements

We are grateful to the following for samples provided: E. Coppejans, F. Leliaert, H. Verbruggen, W. Prud'homme Van Reine, M. Hommersand, D. and M. Littler, T. Cowling, A. Sherwood, W. Villaver, R. Ladio, F. Fumar, J. Lucañas and A. Bucol. Thanks are also due to Prof. D. Reid Wiseman who generously sent a copy of his PhD thesis on *Ocbtodes* and *Chondrococcus* to us. We also thank two anonymous reviewers for their valuable comments and suggestions. The research is funded by the Flemish Interuniversity Council (VLIR) as part of the PhD grant to D.A. Payo.

---

## 2.6 References

- Abbott, I.A., 1999. Marine Red Algae of the Hawaiian Islands. Bishop Museum Press, Honolulu, Hawaii.
- Agardh, J.G., 1876. Species genera et ordines algarum, seu descriptiones succinctae specierum, generum et ordinum, quibus algarum regnum constituitur. Volumen tertium: de Florideis curae posteriores. Part 1. C.W.K. Gleerup, Lipsiae [Leipzig].
- Benhissoune, S., Boudouresque, C.F., Perret-Boudouresque, M., Verlaque, M., 2002. A checklist of the seaweeds of the Mediterranean and Atlantic coasts of Morocco. III. Rhodophyceae (excluding Ceramiales). *Bot. Mar.* 45, 391-412.
- Berecibar, E., Wynne, M.J., Santos, R., 2009. First record of *Contarinia squamariae* (Rhizophyllidaceae, Rhodophyta) from Portugal: description of morphological and reproductive structures. *Bot. Mar.* 52, 15-23.
- De Clerck, O., Gavio, B., Fredericq, S., Cocquyt, E., Coppejans, E., 2005. Systematic reassessment of the red algal genus *Phyllymenia* (Halymeniaceae, Rhodophyta). *Eur. J. Phycol.* 40, 169-178.
- Denizot, M., 1968. Les algues Floridées Encrustantes (à l'exclusion des Corallinacées). Laboratoire de Cryptogamie, Muséum National d'Histoire Naturelle, Paris.
- Feldmann, J., 1939. Les algues marines de la côte des Albères. IV. Rhodophycées. *Revue Algologique* 11, 247-330.
- Fredericq, S., Hommersand, M., Freshwater, D.W., 1996. The molecular systematics of some agar-and carrageenan-containing marine red algae based on *rbcL* sequence analysis. *Hydrobiologia* 326, 125-135.
- Guindon, S., Dufayard, J.F., Hordijk, W., Lefort, V., Gascuel, O., 2009. PhyML: fast and accurate phylogeny reconstruction by maximum likelihood. *Infect. Genet. Evol.* 9, 384-385.
- Guiry, M.D., Guiry, G.M., 2010. Algaebase. World-wide electronic publication, National University of Ireland, Galway. searched on 07 April 2010. <http://www.algaebase.org>.
- Hall, T.A., 1999. BioEdit: a user-friendly biological sequence alignment editor and analysis program for Windows 95/98/NT. *Nucl. Acids. Symp. Ser.* 41, 95-98.
- Harper, J.T., Saunders, G.W., 2001. Molecular systematics of the Florideophyceae (Rhodophyta) using nuclear large and small subunit rDNA sequence data. *J. Phycol.* 37, 1073-1082.
- Hawkes, M.W., 1990. Reproductive strategies. In: Cole, K.M., Sheath, R.G. (Eds.), *Biology of the red algae*. Cambridge University Press, New York, pp. 455-476.
- Harper, J.T., Saunders, G.W., 2002. Using molecular data to resolve the taxonomic limits of the genera *Callophyllis*, *Euthora* and *Pugetia* (Kallymeniaceae, Rhodophyta). *Phycol. Res.* 50, 275-281.
- Hawkes, M.W., 1990. Reproductive strategies. In: Cole, K.M., Sheath, R.G. (Eds.), *Biology of the red algae*. Cambridge University Press, New York, pp. 455-476.
- Hommersand, M., Fredericq, S., 1990. Sexual reproduction and cystocarp development. In: Cole, K.M., Sheath, R.G. (Eds.), *Biology of the red algae*. Cambridge University Press, New York, pp. 305-345.
- Hommersand, M., Fredericq, S., Cabioch, J., 1992. Developmental morphology of *Gigartina pistillata* (Gigartinaceae, Rhodophyta). *Phycologia* 31, 300-325.
- Huelsenbeck, J.P., Ronquist, F., 2001. MRBAYES: Bayesian inference of phylogenetic trees. *Bioinformatics* 17, 754-755.
- Joly, A.B., Ugadim, Y., 1966. The reproduction of *Ochtodes secundiramea* (Montagne) (Gigartinales, Rhizophyllidaceae). *Bo. Ins. Oceanogr.* 15, 55-64.
- Katoh, K., Toh, H., 2008. Improved accuracy of multiple ncRNA alignment by incorporating structural information into a MAFFT-based framework. *BMC Bioinformatics* 9, 212.

- Krayesky, D.M., Norris, J.N., Gabrielson, P.W., Gabriela, D., Fredericq, S., 2009. A new order of red algae based on the Peyssonneliaceae, with an evaluation of the ordinal classification of the Florideophyceae (Rhodophyta). *Proc. Biol. Soc. Wash.* 122, 364-391.
- Kützing, F.T., 1867. *Tabulae phycologicae; oder, Abbildungen der Tange.* Gedruckt auf kosten des Verfassers (in commission bei W. Köhne). Nordhausen.
- Kylin, H., 1930. Über die Entwicklungsgeschichte der Florideen, von Harald Kylin. CWK Gleerup.
- Kylin, H., 1956. Die Gattungen der Rhodophyceen. CWK Gleerups Förlag, Lund.
- Lyngbye, H.C., 1819. Tentamen hydrophytologiae danicae continens omnia hydrophyta cryptogama Daniae, Holsatiae, Faeroae, Islandiae, Groenlandiae hucusque cognita, systematice disposita, descripta et iconibus illustrata, adjectis simul speciebus norvegicis. typis Schultzeianis, in commissis Librariae Gyldendaliae., Hafniae [Copenhagen].
- Meñez, E.G., Calumpong, H.P., Newman, D.J., West, J.A., 1996. An account of the red alga *Portieria bornemannii* (Gigartinales, Rhodophyllidaceae) from the Philippines. *Nova Hedvigia* 112, 161-170.
- Millar, A.J.K., 1990. Marine red algae of the Coffs Harbour region, northern New South Wales. *Aust. Syst. Bot.* 3, 293-593.
- Nelson, W.A., Adams, N.M., 1996. *Nesophila boggardii* gen. et sp. nov. (Rhizophyllidaceae, Rhodophyta) from offshore islands of northern New Zealand. *Museum N.Z. Te Papa Tongarewa* 5, 1-8.
- Oliveira, E., Österlund, K., Mtolera, M.S.P., 2005. Marine Plants of Tanzania. A Field Guide to the Seaweeds and Seagrasses. Botany Department, Stockholm University, Stockholm.
- Peña, V., Bárbara, I., 2010. New records of crustose seaweeds associated with subtidal maerl beds and gravel bottoms in Galicia (NW Spain). *Bot. Mar.* 53, 41-61.
- Posada, D., Buckley, T.R., 2004. Model selection and model averaging in phylogenetics: advantages of Akaike information criterion and Bayesian approaches over likelihood ratio tests. *Syst. Biol.* 53, 793-808.
- Posada, D., Crandall, K.A., 1998. MODELTEST: testing the model of DNA substitution. *Bioinformatics* 14, 817-818.
- Robins, P.A., Kraft, G.T., 1985. Morphology of the type and Australian species of *Dudresnaya* (Dumontiaceae, Rhodophyta). *Phycologia* 24, 1-34.
- Rodríguez-Prieto, C., Hommersand, M., 2009. Behaviour of the nuclei in pre- and postfertilization stages in *Kallymenia* (Kallymeniaceae, Rhodophyta). *Phycologia* 48, 138-155.
- Rambaut, A., Drummond, A.J., 2007, Tracer v1.4.  
Available free from <http://beast.bio.ed.ac.uk/Tracer>.
- Saunders, G., Chiovitti, A., Kraft, G., 2004. Small-subunit rDNA sequences from representatives of selected families of the Gigartinales and Rhodymeniales (Rhodophyta) 3. Delineating the Gigartinales sensu stricto. *Botany* 82, 43-74.
- Schmitz, F., 1889. Systematische Übersicht der bisher bekannten Gattungen der Florideen. *Flora oder Allgemeine botanische Zeitung* 72, 435-456, pl. XXI.
- Silva, P.C., Meñez, E.G., Moe, R.L., 1987. Catalog of the Benthic Marine Algae of the Philippines. Smithsonian Institution Press, Washington, D.C.
- Tai, V., Lindstrom, S.C., Saunders, G.W., 2001. Phylogeny of the Dumontiaceae (Gigartinales, Rhodophyta) and associated families based on SSU rDNA and internal transcribed spacer sequence data. *J. Phycol.* 37, 184-196.
- Tamura, K., Dudley, J., Nei, M., Kumar, S., 2007. MEGA 4: molecular evolutionary genetics analysis (MEGA) software version 4.0. *Mol. Biol. Evol.* 24, 1596-1599.
- Verbruggen, H., Maggs, C., Saunders, G., Le Gall, L., Yoon, H., De Clerck, O., 2010. Data mining approach identifies research priorities and data requirements for resolving the red algal tree of life. *BMC Evol. Biol.* 10, 16.
- Wang, H.W., Kawaguchi, S., Horiguchi, T., Masuda, M., 2000. Reinstatement of *Grateloupia catenata* (Rhodophyta, Halymeniaceae) on the basis of morphology and *rbcL* sequences. *Phycologia* 39, 228-237.

- 
- Wilce, R.T., Maggs, C.A., Sears, J.R., 2003. *Waernia mirabilis* gen. nov., sp nov (Dumontiaceae, Gigartinales): A new noncoralline crustose red alga from the Northwestern Atlantic Ocean and its relationship to *Gainia* and *Blinksia*. *J. Phycol.* 39, 198–212.
- Wilkes, R.J., McIvor, L.M., Guiry, M.D., 2005. Using rbcL sequence data to reassess the taxonomic position of some *Grateloupia* and *Dermocorynus* species (Halymeniaceae, Rhodophyta) from the North-Eastern Atlantic. *Eur. J. Phycol.* 40, 53-60.
- Wiseman, D.R., 1973, Morphological and Taxonomic Studies of the Red Algal Genera *Ochtodes* and *Chondrococcus*. Department of Botany. Duke University, p. 234.
- Wiseman, D.R., 1975. On the status of the red algal family, the Rhizophyllidaceae (Gigartinales). *Taxon* 24, 489-490.
- Wiseman, D.R., 1976. Observations of the vegetative morphology of the red algal genus *Ochtodes* J. Agardh (Rhizophyllidaceae, Gigartinales). *Phycologia* 15, 143-147.
- Wiseman, D.R., 1977. Observations of the reproductive morphology of the red algal genus *Ochtodes* J. Agardh (Rhizophyllidaceae, Gigartinales). *Phycologia* 16, 1-8.
- Wittmann, W., 1965. Aceto-iron-haematoxylin-chloral hydrate for chromosome staining. *Biotech Histochem* 40, 161-164.
- Zanardini, G., 1851. Algae novae vel minus cognitae in mari Rubro a Portiero collectae. *Flora* 34, 33-38.



### 3 THE RED ALGAL GENUS *PORTIERIA* IN THE PHILIPPINES: SPECIES DELIMITATION AND DIVERSITY PATTERN<sup>1</sup>

---

#### Abstract

In this paper we address the diversity of the red algal genus *Portieria* in the Philippines. Traditionally, only one or two species are recognized. We apply gene sequence data to delimit species and compare methods that rely on a single locus with multilocus species delimitation approaches. Single-locus approach, applied to a mitochondrial *cox2-3* spacer, makes use of a General Mixed Yule Coalescent model to detect species boundaries. The multilocus approach uses a Bayesian modelling approach to generate the posterior probabilities of species assignments taking account of uncertainties due to incongruence between individual gene trees caused by the ancestral coalescent process. The outcomes of both analyses are highly congruent and result in the recognition of 21 species of *Portieria* in the Philippines. This finding is important with respect to the use of *cox2-3* gene sequence for species delimitation in this group of algae. Species distributions are highly structured with the great majority of species being confined to a small geographic range (<100 km). Assessment of total species number indicates that more species ( $45 \pm 5$ ) are to be expected in the study area. Contrary to a wide held belief that predicts large ranges of many marine organisms, our results indicate that diversification in the marine environment may take place at very small spatial scales, and therefore has important consequences for marine management and conservation efforts.

#### Keywords

*Portieria*, Philippines, diversification, species delimitation

<sup>1</sup> Unpublished manuscript: Payo D.A., Leliaert F., Verbruggen H., Calumpong H. & De Clerck O. The red algal genus *Portieria* in the Philippines: species delimitation and diversity pattern.

### 3.1 Introduction

Species are fundamental units of natural diversity. Correctly delimiting and identifying these units is of interest not only for systematists and evolutionary biologists, but also to ecologists, conservation biologists and natural product chemists (Harrison, 1998; Pietra, 2002). Correctly assessing species-level diversity and the geographic ranges of the respective species has direct consequences for management and policy making. Despite its relevance, the delimitation of species is far from clear-cut and the application of different criteria may result in widely diverging estimates of species richness and profoundly influence our understanding of diversity patterns at regional as well as global scales (Wiens and Penkrot, 2002; Sites and Marshall, 2003; Agapow et al., 2004; Sites and Marshall, 2004; Wiens, 2007).

Delimitation of species is closely tied to conceptual issues on what a species precisely is and how they should be defined (Mayden, 1997). The literature on species concepts is vast and a fair number of systematists spend the good latter half of the 20th century disagreeing on which concept to apply (Mayden, 1997; De Queiroz, 1998; Lee, 2003; Sites and Marshall, 2003). A remarkably simple and elegant consensus, however, emerged by decoupling a primary from secondary species concepts. The primary concept, known as the species lineage concept or unified species concept, regards a species as a separately evolving metapopulation lineage. The existence of separately evolving lineages is treated as the only necessary property of a species and conflict resulting from the application of different species concepts arises because secondary species concepts are manifested at different points in time during the process of speciation. Hence, these secondary criteria (e.g. reproductive isolation, diagnosability, niche differentiation, monophyly, etc.) are relevant only to assess lineage separation (De Queiroz, 1998, 2007). Applying the lineage species concept then becomes a matter of identifying separately evolving lineages.

The ease by which genetic sequences are generated nowadays has propelled the use of such data to identify separately evolving lineages and to infer species boundaries (Knowles and Carstens, 2007). Over the past 15 years, a whole suite of methods have been proposed to delimit species based on gene sequence data (reviewed in Sites and Marshall, 2003). These methods differ conceptually in being tree-based or not, requiring prior knowledge on group membership or not, relying on a single locus or examining the signal in multiple independent loci. The most popular approach equates the species boundary with the identification of



---

reciprocally monophyletic groups which have noticeably diverged from other such groups. Commonly a threshold of sequence divergence, the “barcoding gap”, arbitrarily defined as 10 times the mean intraspecific variation for the group under study, is applied (Hebert *et al.*, 2003; Hebert *et al.*, 2004). Exclusivity criteria, such as a barcoding gap for species delimitation are intuitively appealing for a variety of reasons. Perhaps most notably, they provide a utilitarian approach of broad applicability across disparate taxa (Knowles and Carstens, 2007). In addition most methodologies which apply the exclusivity criterion use a single locus, which make their application considerably easier from a practical point of view. This approach, however, has been criticized on various grounds. Empirical as well as simulation studies demonstrated that traditional barcoding studies often fail to correctly delimit species, especially in understudied groups of organisms (Meyer and Paulay, 2005; Hickerson *et al.*, 2006; Meier *et al.*, 2006; Bittner *et al.*, 2010). However, a more fundamental criticism applies. Single-gene barcoding studies assume that the inferred gene tree is representative for the true species phylogeny. A number of processes, such as lineage sorting, introgression and undetected gene duplication may cause gene trees to disagree with the species tree (Heled and Drummond, 2010; O'Meara, 2010). Genetic loci undergo a transition from an initial state of polyphyly or paraphyly upon lineage splitting toward monophyly as the time since speciation increases (Avice and Ball, 1990). So even though eventually all taxa might be delimited with a criterion like reciprocal monophyly, recently diverged species will only rarely meet this assumption. Analytical expectations derived from population genetic theory indicate that a substantial amount of time is required after the initial divergence of species before there will be a high probability of observing reciprocal monophyly (Hudson and Coyne, 2002). The time needed to obtain reciprocally monophyletic lineages is proportional to the effective population size as well as the origin of molecular markers used (e.g., organelle versus nuclear DNA or coding versus non-coding sequences) (Hudson and Turelli, 2003). Given the time needed to achieve reciprocal monophyly a growing number of systematists consider it an unrealistic assumption and a number of alternative species delimitation methodologies, relying on multiple loci, have been developed which model the relationship between the gene trees and the species history probabilistically (Maddison, 1997; Hickerson *et al.*, 2006; Knowles and Carstens, 2007; Heled and Drummond, 2010; O'Meara, 2010).

In this paper, we compare techniques which rely on some sort of exclusivity criterion with recently developed multilocus methods that do not require reciprocal monophyly. We use the red algal genus *Portieria* in the Philippines as a

test case. *Portieria* is fairly common on coral reefs where it occurs from the shallow subtidal down to 40 m deep. Two species are reported in the Philippines: *P. hornemannii* and *P. japonica*. Due to its secondary metabolic compounds, halogenated monoterpenes, this seaweed persists even in areas with extensive grazing by herbivorous fish (Meyer et al., 1994a, b; Puglisi and Paul, 1997; Matlock et al., 1999), although their secondary metabolites apparently do not protect them from being grazed by the sea hare *Aplysia parvula* (Ginsburg and Paul, 2001). Six species are flagged as currently accepted (Guiry and Guiry, 2010), but there is considerable uncertainty on the number *Portieria* species to be recognized. Wiseman (1973), who conducted the only comprehensive study on the morphology and diversity of *Portieria*, applied a particularly broad species concept by recognizing only one species, *P. hornemannii*. Other authors have expressed doubts on this highly restricted view and have variously recognized a varying number of species (Silva et al., 1996; De Clerck et al., 2005a). Species diversity, however, has up to now not been assessed using DNA sequence data. We compare species delimitation based on a single locus dataset with multilocus coalescent-based approaches. A first delimitation is based on a single locus, the mitochondrial *cox2-3* spacer (Zuccarello et al., 1999). We apply a general mixed Yule-coalescent (GMYC) model (Pons et al., 2006; Monaghan et al., 2009) on a mitochondrial *cox2-3* spacer dataset, aiming to detect species boundaries based on differences in branching rates at the level of species and populations. We then test if the GMYC clusters correspond to separately evolving lineages by applying Bayesian species delimitation on a multilocus sequence dataset using a coalescent-based method developed by Yang & Rannala (2010). The method uses reversible-jump Markov chain Monte Carlo (rjMCMC) to estimate the posterior distribution for species delimitation models. Models assume different numbers of species, with each species composed of three key parameters:  $\theta$  (the product of effective population size  $N$  and mutation rate  $\mu$  per site),  $\tau_A$  (the time at which the species arose) and  $\tau_D$  (the time at which the species splits into two descendent species). Our delimitation models included the GMYC lineages which were either lumped in the more encompassing or subdivided into less exclusive lineages. Subsequently, we assess the geographic range of the respective species and discuss the observed diversity patterns.

---

## 3.2 Materials and methods

### 3.2.1 *Taxon sampling*

A total of 265 *Portieria hornemannii* specimens were collected in 25 sites throughout the Philippines. Extensive sampling took place in the northern islands of Batanes, in the Visayas, and Sorsogon (Fig. 3.1). Samples were collected in the intertidal and shallow subtidal by snorkeling or SCUBA diving. Specimens are vouchered in the Ghent University Herbarium and the Institute of Environmental and Marine Sciences at Silliman University. A complete list of specimens and collection data is provided in Table 3.1.

### 3.2.2 *DNA sequencing and alignment*

Total genomic DNA was extracted from silica-dried or ethanol preserved specimens using a modified CTAB method (De Clerck *et al.*, 2005b). We amplified mitochondrial, chloroplast and nuclear genes specifically targeting the mitochondrial *cox2-3* spacer, chloroplast *rbcl*-spacer and a section of the nuclear encoded elongation factor 2 (EF2), respectively. PCR conditions and primer sequences are detailed in Table 3.2.

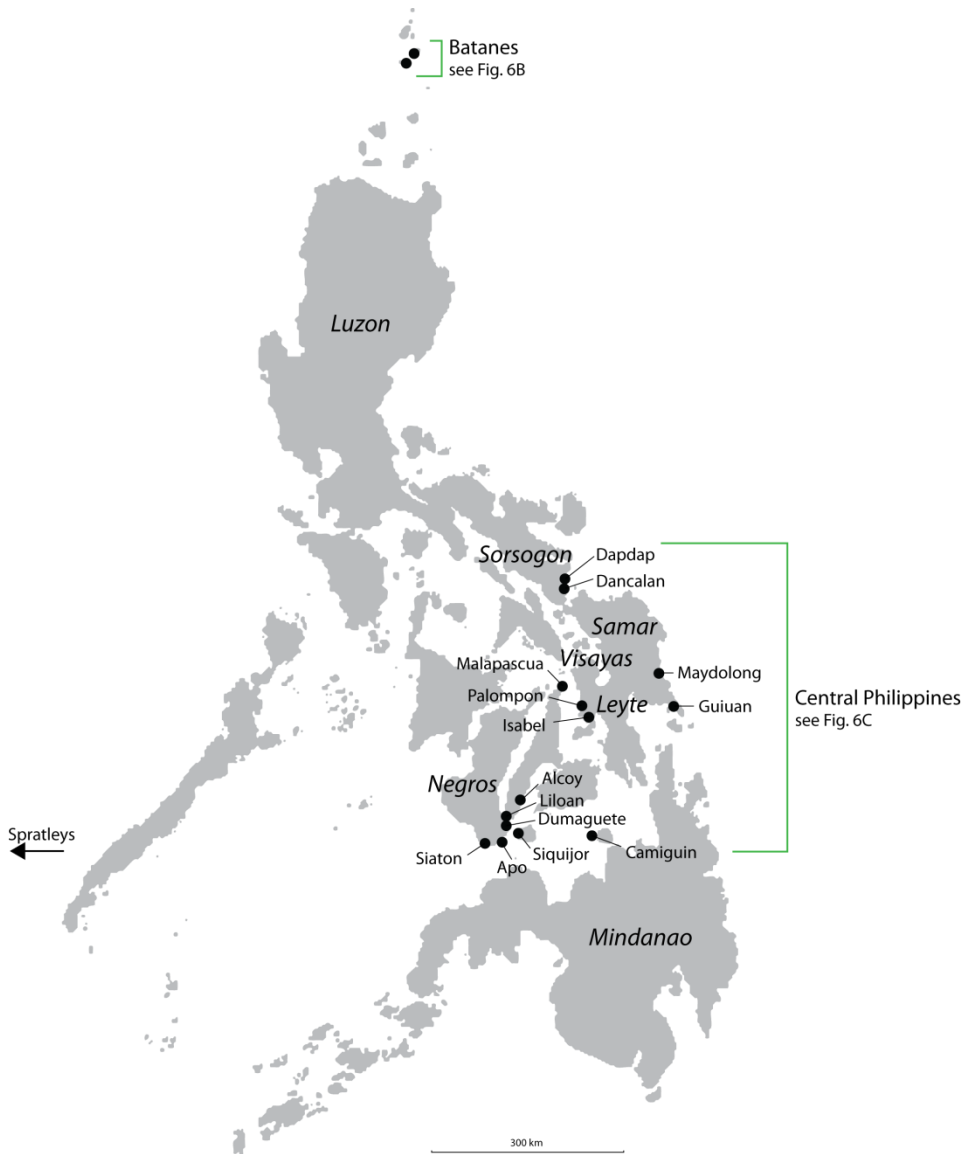

Fig. 3.1. Sampling locations of *Portieria* within the Philippines.

Table 3.1. Specimens used in the phylogenetic analysis with indication of their identity, herbarium number (Voucher) and collecting information.

Species	Number	Locality	Date of Collection	Collector
B21	DAP1434	Pier, Basco, Batanes	25.04.2009	D.A. Payo and O. De Clerck
B21	DAP1422	Coral, Basco, Batanes	25.04.2009	D.A. Payo and O. De Clerck
B21	DAP1434	White Beach, Mahatao, Batanes	26.04.2009	D.A. Payo and O. De Clerck
B21	DAP1437	White Beach, Mahatao, Batanes	26.04.2009	D.A. Payo and O. De Clerck
B21	DAP1442	White Beach, Mahatao, Batanes	26.04.2009	D.A. Payo and O. De Clerck
B21	DAP1449	Pier, Mahatao, Batanes	26.04.2009	D.A. Payo and O. De Clerck
B21	DAP1466	Chavayan, Sabtang Island, Batanes	27.04.2009	D.A. Payo and O. De Clerck
B21	DAP1471	Chavayan, Sabtang Island, Batanes	27.04.2009	D.A. Payo and O. De Clerck
B21	DAP1472	Chavayan, Sabtang Island, Batanes	27.04.2009	D.A. Payo and O. De Clerck
B21	DAP339	White Beach, Mahatao, Batanes	21.04.2007	D.A. Payo, A. Bucol, J. Lucañas
B21	DAP364	Chanaryan, Basco, Batanes	22.04.2007	D.A. Payo, A. Bucol, J. Lucañas
B21	DAP367	Chanaryan, Basco, Batanes	22.04.2007	D.A. Payo, A. Bucol, J. Lucañas
B21	DAP369	Chanaryan, Basco, Batanes	22.04.2007	D.A. Payo, A. Bucol, J. Lucañas
B21	DAP374	Chanaryan, Basco, Batanes	22.04.2007	D.A. Payo, A. Bucol, J. Lucañas
B21	DAP375	Chanaryan, Basco, Batanes	22.04.2007	D.A. Payo, A. Bucol, J. Lucañas
B33	DAP1419	Coral, Basco, Batanes	25.04.2009	D.A. Payo and O. De Clerck
B33	DAP1420	Coral, Basco, Batanes	25.04.2009	D.A. Payo and O. De Clerck
B33	DAP1424	Coral, Basco, Batanes	25.04.2009	D.A. Payo and O. De Clerck
B33	DAP1425	Coral, Basco, Batanes	25.04.2009	D.A. Payo and O. De Clerck
B33	DAP1426	Coral, Basco, Batanes	25.04.2009	D.A. Payo and O. De Clerck
B33	DAP1428	Coral, Basco, Batanes	25.04.2009	D.A. Payo and O. De Clerck
B33	DAP1429	Coral, Basco, Batanes	25.04.2009	D.A. Payo and O. De Clerck
B33	DAP1430	Coral, Basco, Batanes	25.04.2009	D.A. Payo and O. De Clerck
B33	DAP1431	Coral, Basco, Batanes	25.04.2009	D.A. Payo and O. De Clerck
B33	DAP1432	White Beach, Mahatao, Batanes	26.04.2009	D.A. Payo and O. De Clerck
B33	DAP366	Chanaryan, Basco, Batanes	22.04.2007	D.A. Payo, A. Bucol, J. Lucañas
B34	DAP337	White Beach, Mahatao, Batanes	21.04.2007	D.A. Payo, A. Bucol, J. Lucañas
B34	DAP338	White Beach, Mahatao, Batanes	21.04.2007	D.A. Payo, A. Bucol, J. Lucañas
B35	DAP1393	Pier, Basco, Batanes	25.04.2009	D.A. Payo and O. De Clerck
B35	DAP1394	Pier, Basco, Batanes	25.04.2009	D.A. Payo and O. De Clerck
B35	DAP1395	Pier, Basco, Batanes	25.04.2009	D.A. Payo and O. De Clerck
B35	DAP1398	Pier, Basco, Batanes	25.04.2009	D.A. Payo and O. De Clerck
B35	DAP1399	Pier, Basco, Batanes	25.04.2009	D.A. Payo and O. De Clerck
B35	DAP1400	Pier, Basco, Batanes	25.04.2009	D.A. Payo and O. De Clerck
B35	DAP1403	Pier, Basco, Batanes	25.04.2009	D.A. Payo and O. De Clerck
B35	DAP1404	Pier, Basco, Batanes	25.04.2009	D.A. Payo and O. De Clerck
B35	DAP1405	Pier, Basco, Batanes	25.04.2009	D.A. Payo and O. De Clerck
B35	DAP1409	Pier, Basco, Batanes	25.04.2009	D.A. Payo and O. De Clerck
B35	DAP1410	Pier, Basco, Batanes	25.04.2009	D.A. Payo and O. De Clerck
B35	DAP1412	Pier, Basco, Batanes	25.04.2009	D.A. Payo and O. De Clerck
B35	DAP1413	Pier, Basco, Batanes	25.04.2009	D.A. Payo and O. De Clerck
B35	DAP1414	Pier, Basco, Batanes	25.04.2009	D.A. Payo and O. De Clerck
B35	DAP1415	Pier, Basco, Batanes	25.04.2009	D.A. Payo and O. De Clerck
B35	DAP1417	Pier, Basco, Batanes	25.04.2009	D.A. Payo and O. De Clerck

Table 3.1. Continued.

Species	Number	Locality	Date of Collection	Collector
B35	DAP1421	Coral, Basco, Batanes	25.04.2009	D.A. Payo and O. De Clerck
B35	DAP1423	Coral, Basco, Batanes	25.04.2009	D.A. Payo and O. De Clerck
B35	DAP1433	White Beach, Mahatao, Batanes	26.04.2009	D.A. Payo and O. De Clerck
B35	DAP1443	White Beach, Mahatao, Batanes	26.04.2009	D.A. Payo and O. De Clerck
B35	DAP1447	White Beach, Mahatao, Batanes	26.04.2009	D.A. Payo and O. De Clerck
B35	DAP1450	Pier, Mahatao, Batanes	27.04.2009	D.A. Payo and O. De Clerck
B35	DAP145	Tolingon, Isabel, Leyte	03.03.2007	D.A. Payo
B35	DAP1467	Chavayan, Sabtang Island, Batanes	27.04.2009	D.A. Payo and O. De Clerck
B35	DAP340	White Beach, Mahatao, Batanes	21.04.2007	D.A. Payo, A. Bucol, J. Lucañas
B35	DAP342	White Beach, Mahatao, Batanes	21.04.2007	D.A. Payo, A. Bucol, J. Lucañas
B35	DAP347	White Beach, Mahatao, Batanes	21.04.2007	D.A. Payo, A. Bucol, J. Lucañas
B35	DAP363	Chanaryan, Basco, Batanes	22.04.2007	D.A. Payo, A. Bucol, J. Lucañas
B35	DAP368	Chanaryan, Basco, Batanes	22.04.2007	D.A. Payo, A. Bucol, J. Lucañas
B35	DAP371	Chanaryan, Basco, Batanes	22.04.2007	D.A. Payo, A. Bucol, J. Lucañas
B35	DAP372	Chanaryan, Basco, Batanes	22.04.2007	D.A. Payo, A. Bucol, J. Lucañas
B35	DAP377	Chanaryan, Basco, Batanes	22.04.2007	D.A. Payo, A. Bucol, J. Lucañas
B38	DAP1427	Coral, Basco, Batanes	25.04.2009	D.A. Payo and O. De Clerck
B5	DAP1435	White Beach, Mahatao, Batanes	26.04.2009	D.A. Payo and O. De Clerck
B5	DAP1436	White Beach, Mahatao, Batanes	26.04.2009	D.A. Payo and O. De Clerck
B5	DAP1438	White Beach, Mahatao, Batanes	26.04.2009	D.A. Payo and O. De Clerck
B5	DAP1440	White Beach, Mahatao, Batanes	26.04.2009	D.A. Payo and O. De Clerck
B5	DAP1441	White Beach, Mahatao, Batanes	26.04.2009	D.A. Payo and O. De Clerck
B5	DAP1445	White Beach, Mahatao, Batanes	26.04.2009	D.A. Payo and O. De Clerck
B5	DAP1446	White Beach, Mahatao, Batanes	26.04.2009	D.A. Payo and O. De Clerck
B5	DAP1451	Chavayan, Sabtang Island, Batanes	27.04.2009	D.A. Payo and O. De Clerck
B5	DAP1452	Chavayan, Sabtang Island, Batanes	27.04.2009	D.A. Payo and O. De Clerck
B5	DAP1453	Chavayan, Sabtang Island, Batanes	27.04.2009	D.A. Payo and O. De Clerck
B5	DAP1454	Chavayan, Sabtang Island, Batanes	27.04.2009	D.A. Payo and O. De Clerck
B5	DAP1455	Chavayan, Sabtang Island, Batanes	27.04.2009	D.A. Payo and O. De Clerck
B5	DAP1456	Chavayan, Sabtang Island, Batanes	27.04.2009	D.A. Payo and O. De Clerck
B5	DAP1457	Chavayan, Sabtang Island, Batanes	27.04.2009	D.A. Payo and O. De Clerck
B5	DAP1458	Chavayan, Sabtang Island, Batanes	27.04.2009	D.A. Payo and O. De Clerck
B5	DAP1459	Chavayan, Sabtang Island, Batanes	27.04.2009	D.A. Payo and O. De Clerck
B5	DAP1460	Chavayan, Sabtang Island, Batanes	27.04.2009	D.A. Payo and O. De Clerck
B5	DAP1462	Chavayan, Sabtang Island, Batanes	27.04.2009	D.A. Payo and O. De Clerck
B5	DAP1463	Chavayan, Sabtang Island, Batanes	27.04.2009	D.A. Payo and O. De Clerck
B5	DAP1464	Chavayan, Sabtang Island, Batanes	27.04.2009	D.A. Payo and O. De Clerck
B5	DAP1465	Chavayan, Sabtang Island, Batanes	27.04.2009	D.A. Payo and O. De Clerck
B5	DAP1469	Chavayan, Sabtang Island, Batanes	27.04.2009	D.A. Payo and O. De Clerck
B5	DAP1470	Chavayan, Sabtang Island, Batanes	27.04.2009	D.A. Payo and O. De Clerck
B5	DAP318	White Beach, Mahatao, Batanes	21.04.2007	D.A. Payo, A. Bucol, J. Lucañas
B5	DAP346	White Beach, Mahatao, Batanes	21.04.2007	D.A. Payo, A. Bucol, J. Lucañas
B5	DAP321	White Beach, Mahatao, Batanes	21.04.2007	D.A. Payo, A. Bucol, J. Lucañas
B5	DAP333	White Beach, Mahatao, Batanes	21.04.2007	D.A. Payo, A. Bucol, J. Lucañas
B5	DAP334	White Beach, Mahatao, Batanes	21.04.2007	D.A. Payo, A. Bucol, J. Lucañas

Table 3.1. Continued.

Species	Number	Locality	Date of Collection	Collector
B5	DAP343	White Beach, Mahatao, Batanes	21.04.2007	D.A. Payo, A. Bucol, J. Lucañas
B5	DAP344	White Beach, Mahatao, Batanes	21.04.2007	D.A. Payo, A. Bucol, J. Lucañas
B5	DAP352	Chanaryan, Basco, Batanes	22.04.2007	D.A. Payo, A. Bucol, J. Lucañas
B5	DAP365	Chanaryan, Basco, Batanes	22.04.2007	D.A. Payo, A. Bucol, J. Lucañas
B5	DAP370	Chanaryan, Basco, Batanes	22.04.2007	D.A. Payo, A. Bucol, J. Lucañas
B5	DAP373	Chanaryan, Basco, Batanes	22.04.2007	D.A. Payo, A. Bucol, J. Lucañas
B8	DAP345	White Beach, Mahatao, Batanes	21.04.2007	D.A. Payo, A. Bucol, J. Lucañas
B8	DAP1396	Pier, Basco, Batanes	25.04.2009	D.A. Payo and O. De Clerck
B8	DAP1397	Pier, Basco, Batanes	25.04.2009	D.A. Payo and O. De Clerck
B8	DAP1401	Pier, Basco, Batanes	25.04.2009	D.A. Payo and O. De Clerck
B8	DAP1402	Pier, Basco, Batanes	25.04.2009	D.A. Payo and O. De Clerck
B8	DAP1406	Pier, Basco, Batanes	25.04.2009	D.A. Payo and O. De Clerck
B8	DAP1407	Pier, Basco, Batanes	25.04.2009	D.A. Payo and O. De Clerck
B8	DAP1408	Pier, Basco, Batanes	25.04.2009	D.A. Payo and O. De Clerck
B8	DAP1416	Pier, Basco, Batanes	25.04.2009	D.A. Payo and O. De Clerck
B8	DAP1418	Pier, Basco, Batanes	25.04.2009	D.A. Payo and O. De Clerck
B8	DAP1439	White Beach, Mahatao, Batanes	26.04.2009	D.A. Payo and O. De Clerck
B8	DAP1444	White Beach, Mahatao, Batanes	26.04.2009	D.A. Payo and O. De Clerck
B8	DAP1448	Pier, Mahatao, Batanes	26.04.2009	D.A. Payo and O. De Clerck
B8	DAP1461	Chavayan, Sabtang Island, Batanes	27.04.2009	D.A. Payo and O. De Clerck
B8	DAP1468	Chavayan, Sabtang Island, Batanes	27.04.2009	D.A. Payo and O. De Clerck
B8	DAP336	White Beach, Mahatao, Batanes	21.04.2007	D.A. Payo, A. Bucol, J. Lucañas
S2	DAP1501	Dapdap, Bulusan, Sorsogon	30.04.2009	D.A. Payo and O. De Clerck
S36	DAP1482	Dancalan, Bulusan, Sorsogon	29.04.2009	D.A. Payo and O. De Clerck
S36	DAP1487	Dancalan, Bulusan, Sorsogon	29.04.2009	D.A. Payo and O. De Clerck
S36	DAP1490	Dancalan, Bulusan, Sorsogon	29.04.2009	D.A. Payo and O. De Clerck
S39	GUI010	Binuthan Reef, Guiuan, Eastern Samar	13.04.2009	R. Ladio
S39	GUI013	Binuthan Reef, Guiuan, Eastern Samar	13.04.2009	R. Ladio
S39	GUI016	Binuthan Reef, Guiuan, Eastern Samar	13.04.2009	R. Ladio
S39	GUI017	Binuthan Reef, Guiuan, Eastern Samar	13.04.2009	R. Ladio
S39	GUI019	Binuthan Reef, Guiuan, Eastern Samar	13.04.2009	R. Ladio
S39	GUI004	Binuthan Reef, Guiuan, Eastern Samar	13.04.2009	R. Ladio
S39	DAP1476	Dancalan, Bulusan, Sorsogon	29.04.2009	D.A. Payo and O. De Clerck
S39	DAP1480	Dancalan, Bulusan, Sorsogon	29.04.2009	D.A. Payo and O. De Clerck
S39	DAP1483	Dancalan, Bulusan, Sorsogon	29.04.2009	D.A. Payo and O. De Clerck
S39	DAP1491	Dancalan, Bulusan, Sorsogon	29.04.2009	D.A. Payo and O. De Clerck
S39	DAP1492	Dancalan, Bulusan, Sorsogon	29.04.2009	D.A. Payo and O. De Clerck
S39	DAP290	Pasig Reef, Maydolong, Eastern Samar	08.04.2007	D.A. Payo and R. Ladio
S39	DAP297	Pasig Reef, Maydolong, Eastern Samar	08.04.2007	D.A. Payo and R. Ladio
S40	DAP1473	Dancalan, Bulusan, Sorsogon	29.04.2009	D.A. Payo and O. De Clerck
S40	DAP1493	Dapdap, Bulusan, Sorsogon	30.04.2009	D.A. Payo and O. De Clerck
S6	DAP1474	Dancalan, Bulusan, Sorsogon	29.04.2009	D.A. Payo and O. De Clerck
S6	DAP1475	Dancalan, Bulusan, Sorsogon	29.04.2009	D.A. Payo and O. De Clerck
S6	DAP1484	Dancalan, Bulusan, Sorsogon	29.04.2009	D.A. Payo and O. De Clerck

Table 3.1. Continued.

Species	Number	Locality	Date of Collection	Collector
S6	DAP1502	Dapdap, Bulusan, Sorsogon	30.04.2009	D.A. Payo and O. De Clerck
S6	DAP1503	Dapdap, Bulusan, Sorsogon	30.04.2009	D.A. Payo and O. De Clerck
S6	DAP1504	Dapdap, Bulusan, Sorsogon	30.04.2009	D.A. Payo and O. De Clerck
S6	DAP1505	Dapdap, Bulusan, Sorsogon	30.04.2009	D.A. Payo and O. De Clerck
S6	DAP1506	Dapdap, Bulusan, Sorsogon	01.05.2009	D.A. Payo and O. De Clerck
S6	DAP1507	Dapdap, Bulusan, Sorsogon	01.05.2009	D.A. Payo and O. De Clerck
S6	DAP1508	Dapdap, Bulusan, Sorsogon	01.05.2009	D.A. Payo and O. De Clerck
S6	DAP1509	Dapdap, Bulusan, Sorsogon	01.05.2009	D.A. Payo and O. De Clerck
S6	DAP1510	Dapdap, Bulusan, Sorsogon	01.05.2009	D.A. Payo and O. De Clerck
S6	DAP1511	Dapdap, Bulusan, Sorsogon	01.05.2009	D.A. Payo and O. De Clerck
S6	DAP1512	Dapdap, Bulusan, Sorsogon	01.05.2009	D.A. Payo and O. De Clerck
S6	MAY002	Pasig Reef, Maydolong, Eastern Samar	09.04.2009	R. Ladio
S6	POR003	Dapdap, Bulusan, Sorsogon	22.04.1998	M. Hommersand
S7	DAP1477	Dancalan, Bulusan, Sorsogon	29.04.2009	D.A. Payo and O. De Clerck
S7	DAP1478	Dancalan, Bulusan, Sorsogon	29.04.2009	D.A. Payo and O. De Clerck
S7	DAP1479	Dancalan, Bulusan, Sorsogon	29.04.2009	D.A. Payo and O. De Clerck
S7	DAP1481	Dancalan, Bulusan, Sorsogon	29.04.2009	D.A. Payo and O. De Clerck
S7	DAP1485	Dancalan, Bulusan, Sorsogon	29.04.2009	D.A. Payo and O. De Clerck
S7	DAP1488	Dancalan, Bulusan, Sorsogon	29.04.2009	D.A. Payo and O. De Clerck
S7	DAP1489	Dancalan, Bulusan, Sorsogon	29.04.2009	D.A. Payo and O. De Clerck
S7	POR002	Dancalan, Bulusan, Sorsogon	21.04.1998	M. Hommersand
SP3	SCS105	Spratley Islands, Philippines	.04.2007	H. Calumpong and A.D. Macansantos
SP3	SCS109	Spratley Islands, Philippines	.04.2007	H. Calumpong and A.D. Macansantos
V1A	DAP058	Malo, Siaton	27.01.2007	D.A. Payo and A. Bucol
V1A	DAP070	Malo, Siaton	27.01.2007	D.A. Payo and A. Bucol
V1A	DAP102	Dapdap, Siquijor, Siquijor	17.02.2007	D.A. Payo and A. Bucol
V1A	DAP103	Dapdap, Siquijor, Siquijor	17.02.2007	D.A. Payo and A. Bucol
V1A	DAP104	Dapdap, Siquijor, Siquijor	17.02.2007	D.A. Payo and A. Bucol
V1A	DAP108	Bukabok Reef, San Juan, Siquijor	17.02.2007	D.A. Payo and A. Bucol
V1A	DAP210	Dapdap, Siquijor, Siquijor	15.03.2007	D.A. Payo and A. Bucol
V1A	DAP213	Dapdap, Siquijor, Siquijor	15.03.2007	D.A. Payo and A. Bucol
V1A	DAP214	Dapdap, Siquijor, Siquijor	15.03.2007	D.A. Payo and A. Bucol
V1A	DAP439	Dapdap, Siquijor, Siquijor	14.05.2007	D.A. Payo and A. Bucol
V1A	DAP442	Dapdap, Siquijor, Siquijor	14.05.2007	D.A. Payo and A. Bucol
V1A	DAP445	Dapdap, Siquijor, Siquijor	14.05.2007	D.A. Payo and A. Bucol
V1A	DAP450	Dapdap, Siquijor, Siquijor	14.05.2007	D.A. Payo and A. Bucol
V1A	DAPSTN1	Malo, Siaton, Negros Oriental	2008	D.A. Payo and A. Bucol
V1B	DAP087	Bantayan, Dumaguete, Negros Oriental	31.01.2007	D.A. Payo
V1B	DAP088	Bantayan, Dumaguete, Negros Oriental	31.01.2007	D.A. Payo
V1B	DAP247	Bantayan, Dumaguete, Negros Oriental	30.03.2007	D.A. Payo
V1B	DAP248	Bantayan, Dumaguete, Negros Oriental	30.03.2007	D.A. Payo
V1B	DAP249	Bantayan, Dumaguete, Negros Oriental	30.03.2007	D.A. Payo
V1B	DAP250	Bantayan, Dumaguete, Negros Oriental	30.03.2007	D.A. Payo
V1B	DAP251	Bantayan, Dumaguete, Negros Oriental	30.03.2007	D.A. Payo
V1C	DAP167	Daang-Lungsod, Alcoy, Cebu	14.03.2007	D.A. Payo and W. Villaver
V1C	DAP168	Daang-Lungsod, Alcoy, Cebu	14.03.2007	D.A. Payo and W. Villaver



Table 3.1. Continued.

Species	Number	Locality	Date of Collection	Collector
V1C	DAP170	Daang-Lungsod, Alcoy, Cebu	14.03.2007	D.A. Payo and W. Villaver
V1C	DAP171	Daang-Lungsod, Alcoy, Cebu	14.03.2007	D.A. Payo and W. Villaver
V1C	DAP185	Daang-Lungsod, Alcoy, Cebu	14.03.2007	D.A. Payo and W. Villaver
V1C	DAP186	Daang-Lungsod, Alcoy, Cebu	14.03.2007	D.A. Payo and W. Villaver
V1C	DAP211	Dapdap, Siquijor, Siquijor	15.03.2007	D.A. Payo and A. Bucol
V1D	HV584	Malapascua, Cebu	22.01.2004	H. Verbruggen
V1E	PAL001	Palompon, Leyte	.05.2009	D.G. Payo
V1E	PAL002	Palompon, Leyte	.05.2009	D.G. Payo
V1E	DAP144	Tolingon, Isabel, Leyte	03.03.2007	D.A. Payo
V1E	DAP146	Tolingon, Isabel, Leyte	03.03.2007	D. A. Payo
V1E	DAP148	Tolingon, Isabel, Leyte	03.03.2007	D.A. Payo
V1E	DAP151	Tolingon, Isabel, Leyte	03.03.2007	D.A. Payo
V1E	DAP152	Tolingon, Isabel, Leyte	03.03.2007	D.A. Payo
V1E	DAP153	Tolingon, Isabel, Leyte	03.03.2007	D.A. Payo
V1E	DAP154	Tolingon, Isabel, Leyte	03.03.2007	D.A. Payo
V1E	DAP155	Tolingon, Isabel, Leyte	03.03.2007	D.A. Payo
V1E	DAP156	Tolingon, Isabel, Leyte	03.03.2007	D.A. Payo
V26	DAP052	Malo, Siaton	27.01.2007	D.A. Payo and A. Bucol
V26	DAP054	Malo, Siaton	27.01.2007	D.A. Payo and A. Bucol
V26	DAP055	Malo, Siaton	27.01.2007	D.A. Payo and A. Bucol
V26	DAP184	Daang-Lungsod, Alcoy, Cebu	14.03.2007	D.A. Payo and W. Villaver
V26	DAPSTN2	Malo, Siaton, Negros Oriental	2008	D.A. Payo and A. Bucol
V26	DAPSTN5	Malo, Siaton, Negros Oriental	2008	D.A. Payo and A. Bucol
V27	DAP187	Apo, Dauin, Negros Oriental	24.03.2007	D.A. Payo and A. Candido
V27	DAP188	Apo, Dauin, Negros Oriental	24.03.2007	D.A. Payo and A. Candido
V27	DAP189	Apo, Dauin, Negros Oriental	24.03.2007	D.A. Payo and A. Candido
V27	DAP190	Apo, Dauin, Negros Oriental	24.03.2007	D.A. Payo and A. Candido
V27	DAP191	Apo, Dauin, Negros Oriental	24.03.2007	D.A. Payo and A. Candido
V27	DAP468	Paliton, San Juan, Siquijor	14.05.2007	D.A. Payo and A. Bucol
V31	MAY010	Pasig Reef, Maydolong, Eastern Samar	09.04.2009	R. Ladio
V31	MAY011	Pasig Reef, Maydolong, Eastern Samar	09.04.2009	R. Ladio
V31	MAY012	Pasig Reef, Maydolong, Eastern Samar	09.04.2009	R. Ladio
V31	MAY013	Pasig Reef, Maydolong, Eastern Samar	09.04.2009	R. Ladio
V31	MAY014	Pasig Reef, Maydolong, Eastern Samar	09.04.2009	R. Ladio
V31	MAY015	Pasig Reef, Maydolong, Eastern Samar	09.04.2009	R. Ladio
V31	MAY016	Pasig Reef, Maydolong, Eastern Samar	09.04.2009	R. Ladio
V31	MAY017	Pasig Reef, Maydolong, Eastern Samar	09.04.2009	R. Ladio
V31	MAY018	Pasig Reef, Maydolong, Eastern Samar	09.04.2009	R. Ladio
V31	MAY019	Pasig Reef, Maydolong, Eastern Samar	09.04.2009	R. Ladio
V31	MAY001	Pasig Reef, Maydolong, Eastern Samar	09.04.2009	R. Ladio
V31	MAY003	Pasig Reef, Maydolong, Eastern Samar	09.04.2009	R. Ladio
V31	MAY004	Pasig Reef, Maydolong, Eastern Samar	09.04.2009	R. Ladio
V31	MAY006	Pasig Reef, Maydolong, Eastern Samar	09.04.2009	R. Ladio
V31	MAY007	Pasig Reef, Maydolong, Eastern Samar	09.04.2009	R. Ladio

Table 3.1. Continued.

Species	Number	Locality	Date of Collection	Collector
V31	MAY008	Pasig Reef, Maydolong, Eastern Samar	09.04.2009	R. Ladio
V31	MAY009	Pasig Reef, Maydolong, Eastern Samar	09.04.2009	R. Ladio
V31	DAP286	Pasig Reef, Maydolong, Eastern Samar	08.04.2007	D.A. Payo and R. Ladio
V31	DAP288	Pasig Reef, Maydolong, Eastern Samar	08.04.2007	D.A. Payo and R. Ladio
V31	DAP291	Pasig Reef, Maydolong, Eastern Samar	08.04.2007	D.A. Payo and R. Ladio
V31	DAP293	Pasig Reef, Maydolong, Eastern Samar	08.04.2007	D.A. Payo and R. Ladio
V31	DAP294	Pasig Reef, Maydolong, Eastern Samar	08.04.2007	D.A. Payo and R. Ladio
V31	DAP295	Pasig Reef, Maydolong, Eastern Samar	08.04.2007	D.A. Payo and R. Ladio
V31	DAP296	Pasig Reef, Maydolong, Eastern Samar	08.04.2007	D.A. Payo and R. Ladio
V31	DAP298	Pasig Reef, Maydolong, Eastern Samar	08.04.2007	D.A. Payo and R. Ladio
V32	CAM001	Camiguin	.04.2009	H. Calumpong
V32	DAP1388	Liloan, Santander, Cebu	18.04.2009	D.A. Payo
V32	DAP1389	Liloan, Santander, Cebu	18.04.2009	D.A. Payo
V32	DAP1390	Liloan, Santander, Cebu	18.04.2009	D.A. Payo
V32	DAP1391	Liloan, Santander, Cebu	18.04.2009	D.A. Payo
V32	DAP1392	Liloan, Santander, Cebu	18.04.2009	D.A. Payo
V32	DAP1394a	Liloan, Santander, Cebu	18.04.2009	D.A. Payo
V32	DAP1393a	Liloan, Santander, Cebu	18.04.2009	D.A. Payo
V32	GUI011	Binuthan Reef, Guiuan, Eastern Samar	13.04.2009	R. Ladio
V32	GUI014	Binuthan Reef, Guiuan, Eastern Samar	13.04.2009	R. Ladio
V32	GUI018	Binuthan Reef, Guiuan, Eastern Samar	13.04.2009	R. Ladio
V32	GUI001	Binuthan Reef, Guiuan, Eastern Samar	13.04.2009	R. Ladio
V32	GUI002	Binuthan Reef, Guiuan, Eastern Samar	13.04.2009	R. Ladio
V32	GUI003	Binuthan Reef, Guiuan, Eastern Samar	13.04.2009	R. Ladio
V32	GUI005	Binuthan Reef, Guiuan, Eastern Samar	13.04.2009	R. Ladio
V32	GUI006	Binuthan Reef, Guiuan, Eastern Samar	13.04.2009	R. Ladio
V32	GUI007	Binuthan Reef, Guiuan, Eastern Samar	13.04.2009	R. Ladio
V32	GUI008	Binuthan Reef, Guiuan, Eastern Samar	13.04.2009	R. Ladio
V32	GUI009	Binuthan Reef, Guiuan, Eastern Samar	13.04.2009	R. Ladio
V32	DAP1338	Pagubagubaaan Reef San Juan, Siquijor	30.06.2008	D.A. Payo and A. Bucol
V32	DAP1346	Pagubagubaaan Reef San Juan, Siquijor	14.07.2008	D.A. Payo and A. Bucol
V32	DAP1351	Pagubagubaaan Reef San Juan, Siquijor	14.07.2008	D.A. Payo and A. Bucol
V32	DAP1352	Pagubagubaaan Reef San Juan, Siquijor	14.07.2008	D.A. Payo and A. Bucol
V32	DAP202	Sawang Reef, San Juan, Siquijor	17.03.2007	D.A. Payo and A. Candido
V32	DAP204	Sawang Reef, San Juan, Siquijor	17.03.2007	D.A. Payo and A. Candido
V32	DAP205	Sawang Reef, San Juan, Siquijor	17.03.2007	D.A. Payo and A. Candido
V32	DAP455	Paliton, San Juan, Siquijor	14.05.2007	D.A. Payo and A. Bucol
V32	DAP480	Sawang Reef, San Juan, Siquijor	15.05.2007	D.A. Payo and A. Bucol
V32	DAP482	Sawang Reef, San Juan, Siquijor	15.05.2007	D.A. Payo and A. Bucol
V32	DAP533	Sawang Reef, San Juan, Siquijor	17.06.2007	D.A. Payo and A. Bucol
V32	DAP544	Sawang Reef, San Juan, Siquijor	17.06.2007	D.A. Payo and A. Bucol
V32	DAP1342	Pagubagubaaan Reef San Juan, Siquijor	30.06.2008	D.A. Payo and A. Bucol

Table 3.2. List of genes sequenced and primer sequences and amplification conditions used.

Genomic compartment	Target	Primer name	Primer sequence (5'–3')	Reference	PCR program
Mitochondria	cox2-3 spacer	cox2F	GTACCWTCITTTDRGRRKDAATGTGATGC	Zuccarello 1999	one cycle of 4 min at 94 °C; five cycles of 1 min at 93 °C, 1 min at 45 °C and 1 min at 72 °C, 30 cycles of 30s at 93 °C, 30s at 50 °C and 30s at 72 °C and a final cycle of 5 min at 72 °C
		cox3R	GGATCTACWAGATGRAAWGGATGTC	Zuccarello 1999	
Chloroplast	rbcL+spacer	F993F	GGTACTGTTGTAGGTAATTAGAAGG	Freshwater and Rueness 1994	one cycle of 3 min at 94 °C, 35 cycles of 1 min at 94 °C, 1 min at 46 °C and 1.5 min at 72 °C and a final cycle of 10 min at 72 °C
		F993nF	TTCCGTGTTATTGTAAATGG	This study	
		rbc3R	TGTGTTGCGGCCGCCCTTGTTAGTCTCA	Freshwater and Rueness 1994	
Nucleus	EF2	L3L12F	CGYACNCTBCTBATGATGGG	Le Gall 2007	one cycle of 4 min at 94 °C, 38 cycles at 94 °C for 4 min, 38 cycles of 1 min at 94 °C, 1 min at 50 °C, 2 min at 72 °C, and a final cycle of 7 min at 72 °C. PCR success improved at an annealing of 55 °C
		R2R	GGRCRAARACACAGATCTT	Le Gall 2007	
		518F	CGACCCCTTCTCATGATGGG	This study	
		722R	GGTCACTGGGTTCTTCGGTTC	This study	
		1046R	ATCACGAGGAGTGACCTTGC	This study	

PCR products were verified by gel electrophoresis and successful amplicons were purified using exonuclease I/shrimp alkaline phosphatase ExoSAP-ITs (USB Corp., Cleveland, OH, USA). Sequencing reactions were performed using the PCR primers with the Bigdye Terminator v3.1 Cycle Sequencing Kit from Applied Biosystems following manufacturer's instructions. Sequencing products were analyzed with an ABI 3100 Prism Genetic Analyzer (PE Applied Biosystems, Foster City, CA, USA). DNA sequences were corrected by eye and aligned using CLUSTAL X in BioEdit v.7.09 (Hall, 1999).

### 3.2.3 Species delimitation and phylogeny

#### General Mixed Yule Coalescent Model

As a first step *Portieria* species were delimited based on mitochondrial *cox2-3* spacer sequences of 68 specimens. We used a maximum likelihood approach developed by Pons et al. (2006) and Monaghan et al. (2009). The method, using a Generalized Mixed Yule Coalescent (GMYC) model, aims to detect the transition between micro- and macroevolutionary branching patterns in an ultrametric tree and hence define the species boundary. A maximum likelihood approach is used to optimise the shift in branching rates in an ultrametric gene tree from interspecific branches (Yule model) to intraspecific branches (neutral coalescent model). This shift is recognizable as a sudden increase of diversification rate when ultrametric node height is plotted against the number of nodes in a lineage-through-time plot.

To obtain an ultrametric tree, a Bayesian phylogenetic analysis was conducted in BEAST v1.6.1 (Drummond and Rambaut, 2007) under a GTR + I + G model with an uncorrelated lognormal (UCLN) relaxed molecular clock model (Drummond et al., 2006) and using a coalescence tree prior. A Markov Chain Monte Carlo (MCMC) analysis was run for 10 million generations, sampling every 1000 generations. The output was diagnosed for convergence using Tracer v1.5, and summary statistics and trees were generated using the last five million generations with TreeAnnotator v1.5.3 (Rambaut and Drummond, 2007). GMYC analyses were performed under single- and multiple-threshold models (Monaghan et al., 2009), using the SPLITS package for R (<http://r-forge.r-project.org/projects/splits/>). GMYC-lineages from the single-threshold model were used as the basis to test if these entities reflect distinct evolutionary lineages by analyzing species boundaries using multilocus data (described below).

### **Gene trees and species tree estimation**

Gene trees were estimated for the *rbcL*-spacer, EF2 and *cox2-3* sequences using maximum likelihood (ML) and Bayesian inference (BI). The datasets contained the same 68 specimens initially used for the GMYC analyses and contained no missing data. The ML tree and associated rapid bootstrap support were obtained using the GTR + CAT model in the program RAxML v.7.2.8 (Stamatakis, 2006; Stamatakis *et al.*, 2008) at the Cyberinfrastructure for Phylogenetic Research (CIPRES; <http://www.phylo.org>). Bayesian trees and posterior probabilities were estimated using MrBayes 3.1 (Ronquist and Huelsenbeck, 2003). Two parallel runs, each consisting of four incrementally heated chains were run for 5 million generations, sampling every 1000th generation. Convergence of log-likelihoods and parameter values was assessed in Tracer v1.4 (Rambaut and Drummond, 2007). A burnin sample of 1000 trees was removed before constructing the majority rule consensus tree. The individual gene trees were visually inspected to identify reciprocal monophyletic groups that were concordantly supported by the three loci, or were well supported by at least one locus but not contradicted by any other locus (Dettman et al., 2003).

We used a recently developed Bayesian method to delimit species (Yang & Rannala 2010). The technique calculates posterior probabilities of potential species delimitations given a user-supplied species tree and multilocus sequence data. Because, methods that fail to take into account incomplete lineages sorting are likely to produce an erroneous estimate of a species tree of recently diverged species (e.g. Degnan and Rosenberg, 2006; Kubatko and Degnan, 2007; Degnan

---

and Rosenberg, 2009; Leache and Rannala, 2011), a species tree was estimated using a recently developed method by Heled & Drummond (2010). \*BEAST, based on the multispecies coalescent estimates, coestimates multiple gene trees embedded in a shared species tree along with the effective population size of both extant and ancestral and allows for intraspecies polymorphism and incomplete lineage sorting. Specimens were a priori assigned to species based on the results of the *cox2-3* GMYC analyses. We unlinked all models for the three loci: GTR + I + G substitution model, uncorrelated lognormal relaxed molecular clock model, and Yule species tree model. Two independent MCMC analyses were run for 20 million generations (sampling 1000 steps). Convergence of the runs was assessed by visual examination of parameter traces and marginal densities using Tracer v.1.4 (Rambaut & Drummond 2007), and the posterior distribution of trees was summarized from the MCMC output excluding the first 10% as burn-in. Bayesian species delimitation was performed using Bayesian Phylogenetics and Phylogeography, BP&P v.2.0 (Yang & Rannala 2010) with the 68 taxon datasets of the three loci. Because at present BP&P can only handle 15 species at the most, we performed the analyses separately for the two main clades of the species tree. Each species delimitation model was assigned equal prior probability, and we used algorithm 0 (Yang & Rannala 2010) with the fine-tuning parameter  $\epsilon = 5$ . Because the prior distributions on the ancestral population size ( $\Theta$ ) and root age ( $\tau_0$ ) can affect the posterior probabilities for models, with large values for  $\Theta$  and small values for  $\tau_0$  favouring conservative models containing fewer species (Yang & Rannala 2010), we ran the analyses with three different combinations of prior as proposed by Leach & Fujita (2010). The first combination of priors assumed relatively large ancestral population sizes and deep divergences:  $\Theta \sim G(1, 10)$  and  $\tau_0 \sim G(1, 10)$ . The second combination of priors assumed relatively small ancestral population sizes and shallow divergences among species:  $\Theta \sim G(2, 2000)$  and  $\tau_0 \sim G(2, 2000)$ . The third combination assumed large ancestral populations sizes  $\Theta \sim G(1, 10)$  and relatively shallow divergences among species  $\tau_0 \sim G(2, 2000)$ , which is a conservative combination of priors that should favour models containing fewer species (Leache & Fujita 2011). The rjMCMC analyses were run for 100000 generations (sampling frequency of five) with a burn-in of 50000. Each analysis was performed twice (initiated with different starting seeds) to check for consistency of the results. In order to verify whether the GMYC analysis of the *cox2-3* dataset might underestimate species diversity, we reran the BP&P analyses using the same settings, but with the GMYC clusters of clade V1 subdivided into multiple entities.

#### 3.2.4 *Species ranges and total species richness*

Species ranges were estimated using the entire *cox2-3* dataset, containing 265 specimens. Total species richness of *Portieria* in the Philippines was estimated using the incidence based first-order jackknife estimator implemented in EstimateS 8.2 (Colwell, 2009). The values derive from an extrapolation of diversity based on the frequency of observing species restricted to a single locality. Diversity beyond the current sample size is estimated by fitting various asymptotic functions through the data. Model selection was based on the Akaike Information Criterion (AIC) (see Dengler, 2009; Williams *et al.*, 2009). Non-linear regressions and model comparison were carried out in R (R Development Core Team, 2010).

### 3.3 Results

#### 3.3.1 *Single locus GMYC approach*

We analysed branch length dynamics in the ultrametric *cox2-3* tree to delimit species. The alignment was 320 bp long and contained 136 variable positions. The likelihood of the GMYC model was significantly higher than that of the null model of uniform (coalescent) branching rates (Table 3.3., Fig. 3.2). Using the single-threshold GMYC, the depth (T) from the branch tips at which the transition occurred was 0.00529 substitutions per site and a lineage- through-time plot exhibited a pronounced increase in branching rates at the tips of the linearized tree (Fig. 3.2).

The single threshold model estimates 22 putative species, with a confidence interval ranging from 19 to 24. The multiple-threshold model detected 25 species, although with a broader confidence interval, from 20-30. Differences between both analyses consisted of 3 clusters that were split under a multiple-threshold model (B5, V26 and V32). In the following analyses we used the most conservative estimate for the number of species in the complex, the lineages resulting from the single-threshold analysis, as our testable hypothesis. Although V32b (DAP1342) resulted to a separate species in the GMYC analysis (Fig. 3.2a), we instead considered this as an entity belonging to lineage V32. Gene trees on Fig. 3.3 reflect DAP1342 co-occurring in the same clade with samples of V32, and not independently, as expected. Thus, only 21 GMYC clusters are considered species.

Table 3.3. Lineage branching patterns fit to single- and multiple-threshold variants of the GMYC model. Model outputs include the threshold genetic distance from the branch tips where transition occurred (T, presented for single-threshold models), the number of putative species as the sum of sequence clusters and singletons (NGMYC), and confidence intervals (CI). Likelihoods are presented for null (L0) and GMYC (LGMYC) models, where null likelihoods are the same for single and multiple threshold model comparisons. Significance of the likelihood ratio (LR) was evaluated using a  $\chi^2$  test with 3 degrees of freedom to compare GMYC and null models. \* $p < 0.001$ .

Model	T	NGMYC	CI	L0	LGMYC	LR
GMYC single threshold	0.00529	22	19-24	4492557	4629208	27.32824*
GMYC multiple threshold	—	25	20-30	4492567	4634238	28.33409*

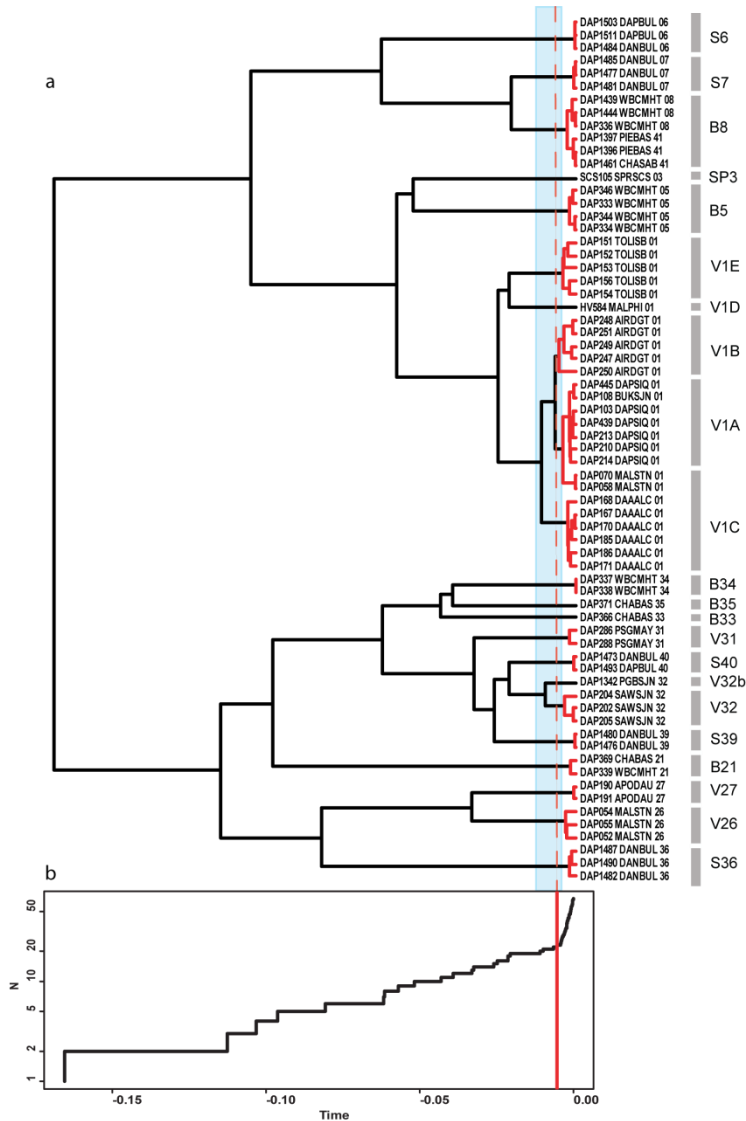

Fig. 3.2. (a) Ultrametric tree of the *Portiera* based on a Bayesian analysis of *cox2-3* spacer sequence data with divergence times estimated under a relaxed molecular clock in BEAST. (b) The graph represents the corresponding lineage-through-time plot. The dotted vertical line indicates the maximum likelihood transition point of the switch in branching rates from interspecific to intraspecific events, as estimated by a general mixed Yule-coalescent (GMYC) model. The blue color indicates the confidence interval in the estimated number of species.



---

### 3.3.2 *Multilocus species delimitation*

Comparison of the gene trees, estimated separately for the *rbcL*-spacer, EF2 and *cox2-3* datasets, resulted in the detection of 12 reciprocal monophyletic clades that were concordant among the three unlinked loci (Fig. 3.3). Incongruence was mainly situated in the topology of the V1-clade. Several of the *cox2-3* lineages delineated by the GMYC analyses (V1A, V1B, V1C) were either para- or polyphyletic in the EF2 and *rbcL* spacer trees. Bayesian inference of a species trees from the three-locus data, using the 21 GMYC clusters as pre-defined species, resulted in a highly supported phylogeny (Fig. 3.4), which was used as a guide tree for the Bayesian species delimitation analysis. The Bayesian species delimitation results are shown in Fig. 3.4. When assuming that the 21 GMYC clusters correspond to species, the Bayesian species delimitation supported the guide tree with high speciation probabilities (0.99 or 1.0) on all nodes. Changing prior distributions for  $\Theta$  and  $\tau_0$  did have a major effect on the outcome of the analysis. The prior combinations that assumed large ancestral population sizes (prior combinations 1 and 3), resulted in a slight decrease of speciation probabilities on some nodes.

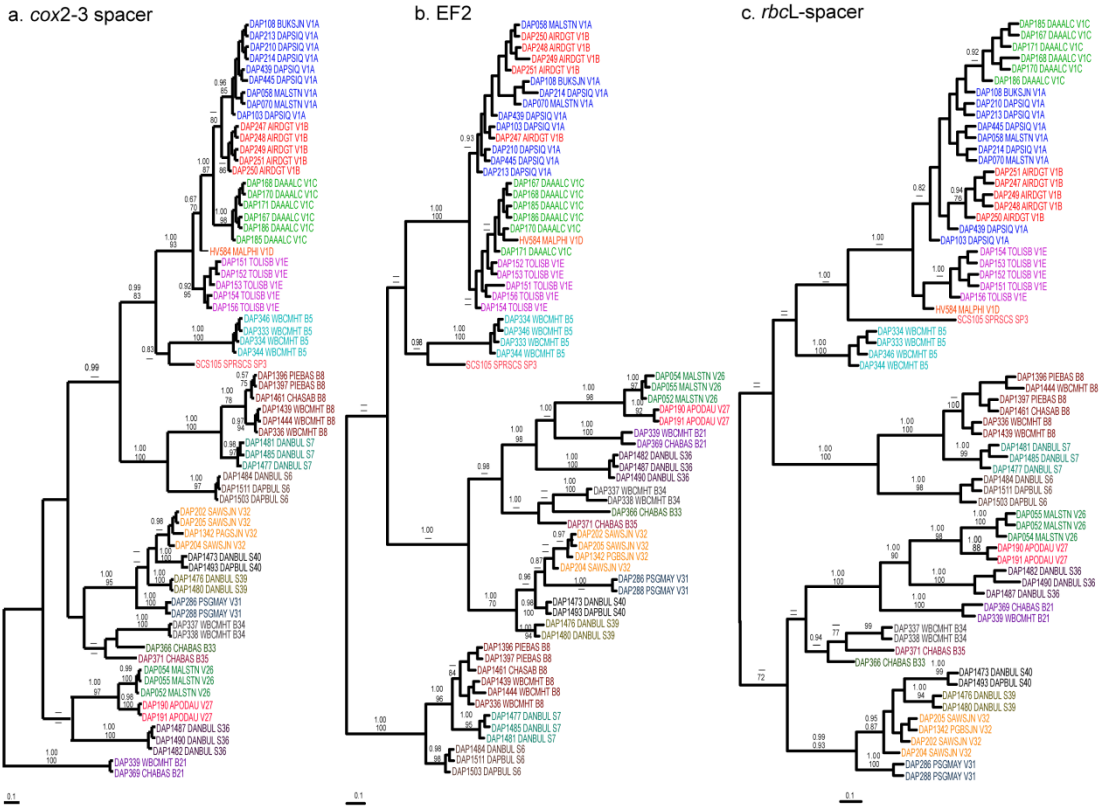

Fig. 3.3. Gene trees inferred from (a) *cox2-3* spacer (b) elongation factor 2 (EF2) (c) *rbcL*-spacer. Colors correspond to *cox2-3* GMYC clusters to which a sample belongs. Branch support (posterior probabilities > 0.50 and bootstrap support > 70) are indicated on the branches.

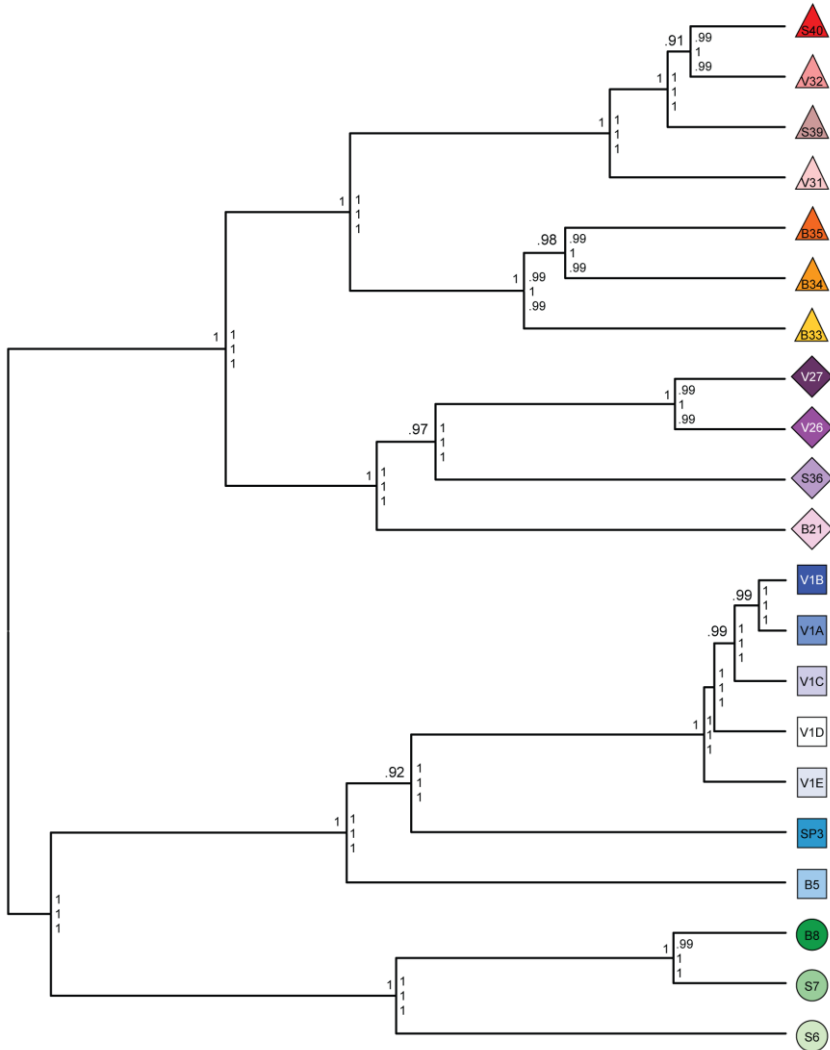

Fig. 3.4. Bayesian species tree inferred using \*BEAST with numbers above branches representing posterior probability values. This 19-species guide tree was used as reference tree for the Bayesian species delimitation of *Portieria* using BP&P. The speciation probabilities are provided for each node under each combination of priors for  $\theta$  and  $\tau_0$ : top,  $\theta \sim G(1, 10)$  and  $\tau_0 \sim G(1, 10)$ , middle,  $\theta \sim G(2, 2000)$  and  $\tau_0 \sim G(2, 2000)$ , bottom  $\theta \sim G(1, 10)$  and  $\tau_0 \sim G(2, 2000)$ .

The Bayesian species delimitation did not support guide trees where the number of species had been increased. For example, when subdividing the four species in clade V1 into 11 species, the BP&P analysis of the 11-species guide tree only supported the nodes leading to the four main clades, while the remaining speciation events were weakly supported and strongly influenced by the priors (Fig. 3.5).

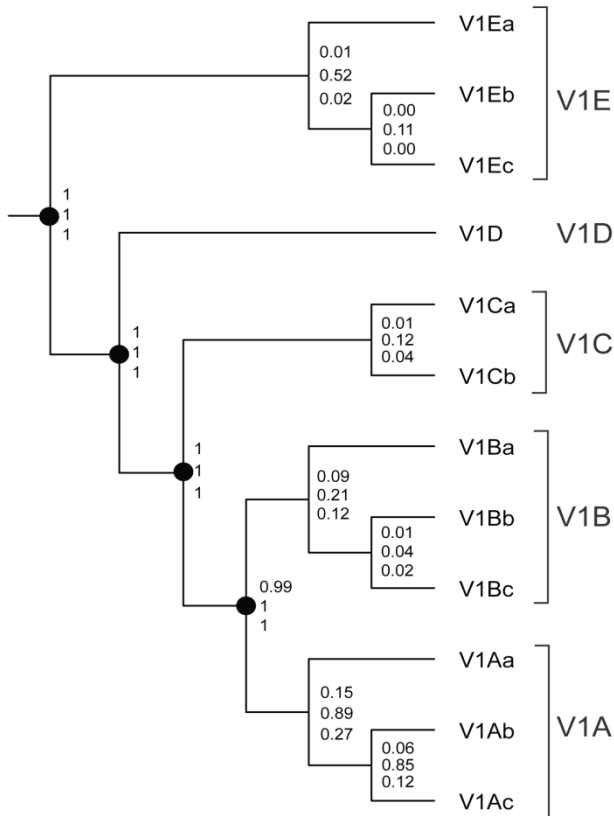

Fig. 3.5. Bayesian species delimitation results after further splitting four V1 clades into 11 species. Only the nodes leading to the four main clades are strongly supported while remaining speciation events are not supported.

---

### 3.3.3 *Species richness and distributions*

Species delimitation analyses resulted in the discovery of at least 21 *Portieria* species in the Philippines. Not a single species was found throughout the study area. Twelve out of 21 species are confined to one or two localities, while only four species were found on more than three localities (Table 3.4). The islands of Batanes appear very distinct from the other sites in the Philippines, with none of the species being found outside the area (Fig. 3.6). Likewise, none of the species found along the Central Pacific coast (Samar and Sorsogon) or the Central Visayas is found in Batanes. The Visayas share a single species (V32). Two species (S6 and S39) are shared between collecting sites on Sorsogon and Samar. Although difficult to state with certainty due to uneven sampling size, the individual collecting sites appear more species rich in Batanes with 3-6 species occurring at each site. In the Visayas most sites harbour only a single, maximum two, species. Richness is intermediate in Luzon mainland, with a maximum of 5 species being found in Dapdap, Sorsogon. Given the small scale spatial distribution of most species, it is unlikely that our sampling strategy resulted in a complete coverage of *Portieria* diversity in the Philippines. Using the first-order jackknife estimator total richness was estimated to be 33 ( $\pm 3$ ) species.

Table 3.4. Occurrence of 21 *Porteria* species in the Philippines. Species collected from a single site only are indicated in bold. Numbers indicate the number of specimens collected from each site.

	Central Visayas											Min danao	Central Pacific Coast				Batanes						Spratleys	Localities/ species		
	Alicey	Apo	Liloan	Mali	Dumaguete	Dapdap	Sawang	Pagubagubahan	Palilon	Bukabok	Siaton	Isabel	Palompon	Camiguin	Guluan	Maydolong	Dancian, Bulisan	Dadap, Bulusan	Pier Basco	Coral, Basco	Pier Mahatato	Chavayan, Sabtang	White Beach	Chanayan	Spratleys	
SP3																									2	1
B21																			1	1	3	4	5			5
B33																			9			1	1			3
B34																						2				1
B35																			17	2	1	1	6	5		6
B5																					16	15	4			3
B8																			9		1	2	3			4
S36																	3									1
S39															6	2	5									3
S40																	1	1								2
S6																1	3	12								3
S7																	8									1
V31															25											1
V32		7				7	4	1					1	11												6
V1A						1				1	3															3
V1B					7																					1
V1C	6					1																				2
V1D				1																						1
V1E											1	2														2
V26	1										5															2
V27		5							1																	2
<b>species/ site</b>	<b>2</b>	<b>1</b>	<b>1</b>	<b>1</b>	<b>1</b>	<b>2</b>	<b>1</b>	<b>1</b>	<b>2</b>	<b>1</b>	<b>1</b>	<b>1</b>	<b>1</b>	<b>2</b>	<b>3</b>	<b>5</b>	<b>2</b>	<b>2</b>	<b>3</b>	<b>3</b>	<b>4</b>	<b>6</b>	<b>4</b>	<b>1</b>		

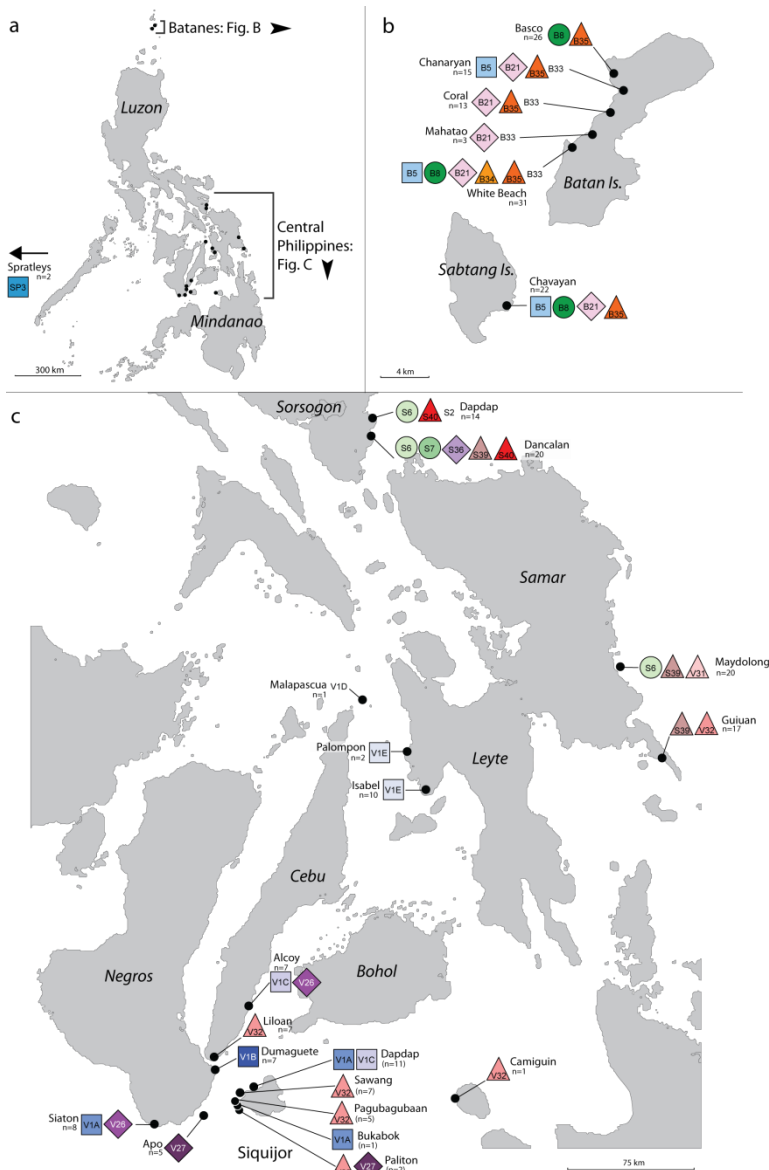

Fig. 3.6. Distribution of *Portieria* species in the Philippines. Number of samples (n) is indicated for each sampling site. (a) Location of sampling sites. (b) Species found in the Batanes sites. (c) Species found in the Visayas, Sorsogon and Camiguin.

Fitting a curve through these points (rational function) to extrapolate to obtain an estimate beyond the current sample resulted in 45 ( $\pm 5$ ) species (Fig. 3.7).

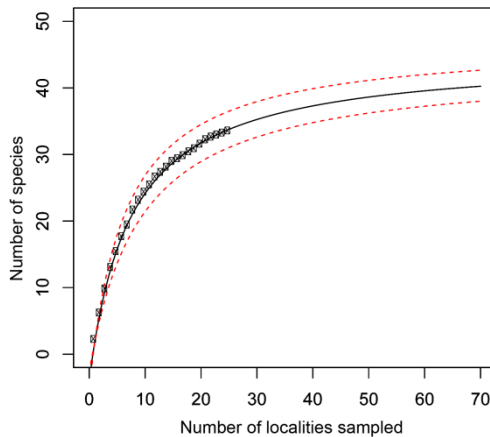

Fig. 3.7. Total species richness estimates of *Portieria* in the Philippines derived using the first order Jackknife estimator. Extrapolation of extant diversity involves use of existing frequency data of species per site and the fitting of various asymptotic functions to determine diversity beyond current sample size.

### 3.4 Discussion

#### 3.4.1 *Species delimitation*

A reassessment of the diversity of the red algal genus *Portieria* in the Philippines based on gene sequence data demonstrates that previous morphology-based species circumscriptions dramatically underestimate the diversity in the respective region. Out of more than 31 literature records, all but two refer to *P. bornemannii* (Lynbye) Silva (references cited in Silva et al. 1987). Only Cordero (1977, 1984) recorded *P. japonica* (Harvey) Silva from Batanes, Luzon and Negros Oriental. The latter species, originally described from Shimoda (Japan), is reported from several locations in South East Asia (Korea, Japan, Vietnam and the Philippines; Lee & Kang 2001; Silva et al. 1987; Tsutsui et al. 2005; Yoshida 1998) as well as Oman (Wynne 1999), but these records are obviously in need of a critical re-examination following the insights on diversity in the genus presented in this paper.



---

Unveiling cryptic diversity in algae does not come as a surprise, but the degree to which we do so here is unprecedented. The single-locus approach based on the mitochondrial encoded *cox2-3* spacer region using a single threshold mixed Yule coalescent model resulted in 21 clusters of specimens which were reciprocally monophyletic and sufficiently distinct from other such lineages to regard them as separately evolving lineages ('species'). Applying the multiple threshold option increased the number of species to 24, but also resulted in an increase of the confidence interval (20-30). Comparing the lineages that were delineated using the *cox2-3* dataset in the chloroplast encoded *rbcL*-spacer gene trees, we observed a large degree of congruence. Nearly all mitochondrial GMYC clusters are resolved as monophyletic lineages in the chloroplast dataset. The only incongruence between both gene trees concerns the specimens from the Visayas labelled 'V1'. In the mitochondrial gene tree 5 monophyletic clades (V1A-E) can be observed, while the V1A lineage is paraphyletic with respect to V1B and V1C in the plastid dataset. Comparing the nuclear encoded EF2 gene tree with the organelle gene trees incongruence is also restricted to the V1 clade. In the EF2 gene tree however none of the V1 GMYC clusters is resolved as a monophyletic lineage. These results indicate that coalescence is faster for organelle data compared to nuclear encoded loci, an observation that is congruent with population genetic theory which predicts that the effective population size of nuclear DNA is twice as high for diploid organisms compared to organelle DNA which is uniparentally inherited (Hudson & Coyne 2002). Bayesian species delimitation using the multilocus dataset confirmed the species boundaries based on the *cox2-3* dataset. These results are evident for the clusters for which there was no conflict among the individual gene trees, but more importantly they support the splitting of the V1 clade into 5 individual species, which did not meet the criterion of reciprocal monophyly over all markers. These results are stable over a broad range of prior settings relating to effective population size and root ages. Further subdividing these lineages was strongly rejected. Posterior probabilities were significantly lower and analyses became highly sensitive to prior settings.

The congruence that we observe between the single-locus and multilocus species delimitation analyses is an important finding. First it gives credit to popular barcoding initiatives which mostly rely on some sort exclusivity criterion and single marker datasets only. It is most likely safe to ignore problems relating to incomplete lineage sorting and ancestral polymorphism in lineages which diverged long enough from one another. Given enough time, these species will be recognized using the genetic exclusivity criteria of reciprocal monophyly at each of the sampled loci

(Avice & Ball 1990; Hudson & Coyne 2002; Knowles & Carstens 2007). Recently diverged taxa, however, are more likely to go unnoticed using exclusivity criteria, i.e. they have a higher false-negative rate. In such cases it is of paramount importance to select markers which coalesce fast. In our data sets, the mitochondrial genome appeared to have a somewhat higher coalescent rate compared to the chloroplast genome, but these results are perhaps entirely stochastic since there appears to be no differences in heritability of both organelle genomes.

### 3.4.2 *Diversity and conservation*

The various species of *Portieria* are not distributed randomly over the study area. For example none of the species occurring in Batanes is shared with the more centrally located collecting sites. In bird's eye view these sites are separated approximately 800 and 1300 km. Likewise, there is limited species overlap between Visayan collecting sites, which share only a single species (V32), and Sorsogon-Samar collecting sites which share two species (S6 and S39). The distribution of species V32 presents the largest geographical range of an individual *Portieria* species in the region, which stretches slightly over 300 km from Dumaguete (Negros) in the West to Guiuan (south of Samar Island) in the East. At smaller spatial scales, i.e. within each of the three regions, similarity in species composition is higher. In the Batanes region none of the species is confined to single locations, which are between 2 and 20 km apart. Likewise, in the Visayas all but two species are shared between localities that are 2 to 100 km apart. Only two species (V1B and V1D) have been collected at a single location. Local diversity and geographic ranges of the species are more difficult to assess for the central Pacific coastline, which has not been sampled as exhaustively.

Our findings may have important consequences for marine conservation management in tropical regions. A traditional view holds that marine species are more resilient to extinction because of their large geographic ranges (Roberts and Hawkins, 1999; Roberts et al., 2002) and therefore, conserving a limited number of biodiversity hotspots suffices to save most species from extinction (Myers *et al.*, 2000). The lack of apparent dispersal barriers in the marine environment and planktonic larval stages or propagules that characterize many species are thought to promote large geographic ranges (Norton, 1992; Palumbi, 1994; Carr et al., 2003; Paulay and Meyer, 2006). Particularly wide ranges and low archipelagic endemism are characteristic for the Indo-West Pacific, extending from the East African coast to the Hawaiian archipelago and Easter Island in the east-central Pacific (Randall, 1998). Most species are characterized by subbasinal distributions, being widespread

---

in either Indian or Pacific Ocean basin, while a substantial fraction spans the entire IWP. There are relatively few local endemics and most are confined to the most isolated island groups in the central-eastern Pacific Ocean. This traditional view, however, is increasingly being challenged. There is now overwhelming evidence from gene sequence data that the traditional application of morphological species concepts resulted in inappropriate species delineation irrespective of taxonomic group or biogeographical region (Knowlton, 1993; Palumbi, 1994; Bickford et al., 2007; Pfenninger and Schwenk, 2007). While, a number of studies reveal that the cryptic species themselves are wide-ranging (e.g. Colborn *et al.*, 2001; Lessios *et al.*, 2001), there is accumulating evidence for the prevalence of geographically restricted cryptic species in many allegedly widely distributed marine organisms. Proportions of range restricted species are highest in the remote peripheral archipelagos (Eble et al., 2009; Malay and Paulay, 2009), but archipelagic endemism in the central IWP was revealed by Paulay & Meyers (2002) and Meyers & Paulay (2005). In the latter study the authors demonstrated that the single morphospecies, *Astraliium rhodostomum*, consists of nearly 30 cryptic species, all but one confined to a single archipelago. Similar observations in at least two other groups of marine gastropods (Paulay and Meyer, 2002; Kirkendale and Meyer, 2004) indicate that archipelagic endemism may be more common than previously anticipated. The diversity pattern of *Portieria* in the Philippines demonstrates that species level diversity may be structured at a much smaller scale (<100 km). These results are even more interesting when taking the topography of the Philippines into consideration. The Philippines consist of over 7100 islands with a total of 33900 km of shoreline (Balgos, 2005). This dense setting of islands and near continuity of coastlines intuitively should facilitate dispersal for shallow water marine coastal organisms. Nevertheless we observe a fine-scale diversity structure and apparent dispersal limitation which is paradoxical to the geographic setting.

A sound interpretation of this apparent paradox is tentative still. For example it is not clear given our present taxon sampling if *Portieria* actually diversified within the Philippines at such small spatial scales. An identical diversity pattern may have arisen also by founder effects whereby occasional long distance dispersal of propagules results in peripatric speciation (Paulay and Meyer, 2002). In order to gain insight in the mechanisms that resulted in these extremely high levels of cryptic diversity, we should sample the entire biogeographic region of *Portieria* and determine the relationships of Philippine versus non-Philippine species. A comprehensive phylogeny if calibrated in time can also shed important insights on the tempo and mode of speciation. Finally, the extent to which the various cryptic

species are ecologically differentiated from another is of interest, since competitive theory predicts that species that compete for the same resource cannot stably coexist if other ecological factors are constant (Amarasekare, 2003). So, how similar are those species in terms of their ecology, demography or interactions with other species?

### **3.5 Acknowledgements**

The authors are grateful to A. Bucol, B. Calañaan, A. Candido, F. Fumar, Z. Generoso, J. Lucañas, R. Ladio, A.D. Macansantos, D. Payo and W. Villaver for field sampling assistance, Batanes MENRO Francis Domingo for field and dive assistance, and to M. Hommersand, D. and M. Littler for samples provided. We greatly appreciate the assistance of Caroline Vlaeminck and Sofie D'hondt on PCR and sequencing work. Funding for this research was provided by the Flemish Interuniversity Council (VLIR) as part of the PhD Grant to D.A. Payo. Completion of this work was made possible by a grant to D.A. Payo from the Belgian National Focal Point to the Global Taxonomy Initiative through Dr. Yves Samyn of the Royal Belgian Institute of Natural Sciences (RBINS).

### 3.6 References

- Agapow, P.M., Bininda-Emonds, O.R.P., Crandall, K.A., Gittleman, J.L., Mace, G.M., Marshall, J.C., Purvis, A., 2004. The impact of species concept on biodiversity studies. *Q. Rev. Biol.* 79, 161-179.
- Amarasekare, P., 2003. Competitive coexistence in spatially structured environments: a synthesis. *Ecol. Lett.* 6, 1109-1122.
- Avise, J.C., Ball, R.M., 1990. Principles of genealogical concordance in species concepts and biological taxonomy. *Oxf Surv Evol Biol* 7, 45-67.
- Balgos, M.C., 2005. Integrated coastal management and marine protected areas in the Philippines: Concurrent developments. *Ocean Coast. Manage.* 48, 972-995.
- Bickford, D., Lohman, D.J., Sodhi, N.S., Ng, P.K.L., Meier, R., Winker, K., Ingram, K.K., Das, I., 2007. Cryptic species as a window on diversity and conservation. *Trends Ecol. Evol.* 22, 148-155.
- Bittner, L., Halary, S., Payri, C., Cruaud, C., de Reviers, B., Lopez, P., Baptiste, E., 2010. Some considerations for analyzing biodiversity using integrative metagenomics and gene networks. *Biology Direct* 5, 47.
- Carr, M.H., Neigel, J.E., Estes, J.A., Andelman, S., Warner, R.R., Largier, J.L., 2003. Comparing marine and terrestrial ecosystems: Implications for the design of coastal marine reserves. *Ecol. Appl.* 13, S90-S107.
- Colborn, J., Crabtree, R.E., Shaklee, J.B., Pfeiler, E., Bowen, B.W., 2001. The evolutionary enigma of bonefishes (*Albula* spp.): Cryptic species and ancient separations in a globally distributed shorefish. *Evolution* 55, 807-820.
- Colwell, R.K., 2009. EstimateS: Statistical estimation of species richness and shared species from samples. Version 8.2. User's Guide and application published at: <http://purl.oclc.org/estimates>.
- Cordero, P.A.J., 1977. Studies on Philippine marine red algae. Special Publications from the Seto Marine Biological Laboratory 4, pp. 258, 268 figs, 227 plates.
- Cordero, P.A.J., 1984. Phycological observations, XX: marine algae in the vicinity of the Bureau of Fisheries and Aquatic Resources Marine Station, Bobon Bay, Ilocos Norte. *Ilocos Fisheries Journal* 1, 67-117.
- De Clerck, O., Bolton, J.J., Anderson, R.J., Coppejans, E., 2005a. Guide to the algae of Kwazulu-Natal. *Sr. Bot. Belg.* 33, 294.
- De Clerck, O., Gavio, B., Fredericq, S., Barbara, I., Coppejans, E., 2005b. Systematics of *Grateloupia filicina* (Halymeniaceae, Rhodophyta), based on *rbcL* sequence analyses and morphological evidence, including the reinstatement of *G. minima* and the description of *G. capensis* sp. nov. *J. Phycol.* 41, 391-410.
- De Queiroz, K., 1998. The general lineage concept of species, species criteria, and the process of speciation. In: Howard, D.J., Berlocher, S.H. (Eds.), *Endless Forms: Species and Speciation*. Oxford University Press, Oxford, pp. 57-75.
- De Queiroz, K., 2007. Species concepts and species delimitation. *Symposium on Species Delimitation - New Approaches for Discovering Diversity*, Stony Brook, NY, pp. 879-886.
- Degnan, J.H., Rosenberg, N.A., 2006. Discordance of species trees with their most likely gene trees. *PLoS Genetics* 2, 762-768.
- Degnan, J.H., Rosenberg, N.A., 2009. Gene tree discordance, phylogenetic inference and the multispecies coalescent. *Trends Ecol. Evol. (Personal edition)* 24, 332-340.
- Dengler, J., 2009. Which function describes the species-area relationship best? A review and empirical evaluation. *J. Biogeogr.* 36, 728-744.
- Dettman, J.R., Jacobson, D.J., Taylor, J.W., 2003. A multilocus genealogical approach to phylogenetic species recognition in the model eukaryote *Neurospora*. *Evolution* 57, 2703-2720.

- Drummond, A., Rambaut, A., 2007. BEAST: Bayesian evolutionary analysis by sampling trees. *BMC Evol. Biol.* 7, 214.
- Drummond, A.J., Ho, S.Y.W., Phillips, M.J., Rambaut, A., 2006. Relaxed Phylogenetics and Dating with Confidence. *PLoS Biol.* 4, e88.
- Eble, J.A., Toonen, R.J., Bowen, B.W., 2009. Endemism and dispersal: comparative phylogeography of three surgeonfishes across the Hawaiian Archipelago. *Mar. Biol.* 156, 689-698.
- Ginsburg, D.W., Paul, V.J., 2001. Chemical defenses in the sea hare *Aplysia parvula*: importance of diet and sequestration of algal secondary metabolites. *Mar. Ecol. Prog. Ser.* 215, 261-274.
- Guiry, M.D., Guiry, G.M., 2010. Algaebase. World-wide electronic publication, National University of Ireland, Galway. <http://www.algaebase.org>; searched on 07 April 2010.
- Hall, T.A., 1999. BioEdit: a user-friendly biological sequence alignment editor and analysis program for Windows 95/98/NT. *Nucl. Acids. Symp. Ser.* 41.
- Harrison, R.G., 1998. Linking evolutionary pattern and process: the relevance of species concepts for the study of speciation. In: Howard, D.J., Berlocher, S.H. (Eds.), *Endless Forms, Species and Speciation*. Oxford University Press, Oxford, pp. 19-31.
- Hebert, P.D.N., Cywinska, A., Ball, S.L., DeWaard, J.R., 2003. Biological identifications through DNA barcodes. *Proc. R. Soc. Lond. Biol.* 270, 313-321.
- Hebert, P.D.N., Penton, E.H., Burns, J.M., Janzen, D.H., Hallwachs, W., 2004. Ten species in one: DNA barcoding reveals cryptic species in the neotropical skipper butterfly *Astraptus fulgerator*. *Proc. Natl. Acad. Sci. U. S. A.* 101, 14812-14817.
- Heled, J., Drummond, A.J., 2010. Bayesian Inference of Species Trees from Multilocus Data. *Mol. Biol. Evol.* 27, 570-580.
- Hickerson, M.J., Meyer, C.P., Moritz, C., 2006. DNA barcoding will often fail to discover new animal species over broad parameter space. *Syst. Biol.* 55, 729-739.
- Hudson, R.R., Coyne, J., 2002. Mathematical consequences of the genealogical species concept. *Evolution* 56, 1557-1565.
- Hudson, R.R., Turelli, M., 2003. Stochasticity overrules the "three-times rule": Genetic drift, genetic draft, and coalescence times for nuclear loci versus mitochondrial DNA. *Evolution* 57, 182-190.
- Kirkendale, L.A., Meyer, C.P., 2004. Phylogeography of the *Patelloida profunda* group (Gastropoda : Lottidae): diversification in a dispersal-driven marine system. *Mol. Ecol.* 13, 2749-2762.
- Knowles, L.L., Carstens, B.C., 2007. Delimiting species without monophyletic gene trees. *Symposium on Species Delimitation - New Approaches for Discovering Diversity*, Stony Brook, NY, pp. 887-895.
- Knowlton, N., 1993. Sibling species in the sea. *Annu. Rev. Ecol. Syst.* 24, 189-216.
- Kubatko, L.S., Degnan, J.H., 2007. Inconsistency of phylogenetic estimates from concatenated data under coalescence. *Syst. Biol.* 56, 17-24.
- Leache, A.D., Fujita, M.K., 2010. Bayesian species delimitation in West African forest geckos (*Hemidactylus fasciatus*). *Proc. R. Soc. Lond. [Biol.]* 277, 3071-3077.
- Leache, A.D., Rannala, B., 2011. The accuracy of species tree estimation under simulation: A comparison of methods. *Syst. Biol.* 60, 126-137.
- Lee, M.S.Y., 2003. Species concepts and species reality: Salvaging a Linnaean rank. *J. Evol. Biol.* 16, 179-188.
- Lee, Y., Kang, S., 2001. *A catalogue of the seaweeds in Korea*. Cheju National University Press, Jeju.
- Lessios, H.A., Kessing, B.D., Pearse, J.S., 2001. Population structure and speciation in tropical seas: Global phylogeography of the sea urchin *Diadema*. *Evolution* 55, 955-975.
- Maddison, W.P., 1997. Gene trees in species trees. *Syst. Biol.* 46, 523-536.
- Malay, M.C.D., Paulay, G., 2009. Peripatric speciation drives diversification and distributional pattern of reef hermit crabs (Decapoda: Diogenidae: *Calcinus*). *Evolution* 64, 634-662.
- Matlock, D.B., Ginsburg, D.W., Paul, V.J., 1999. Spatial variability in secondary metabolite production by the tropical red alga *Portieria hornemannii*. *Hydrobiologia* 399, 267-273.

- Mayden, R.L., 1997. A hierarchy of species concepts: the denouement in the saga of the species problem. In: Claridge, M.F., Dawah, H.A., Wilson, M.R. (Eds.), *Species: The Units of Biodiversity*. Chapman and Hall, pp. 381–424.
- Meier, R., Shiyang, K., Vaidya, G., Ng, P.K.L., 2006. DNA barcoding and taxonomy in *Diptera*: A tale of high intraspecific variability and low identification success. *Syst. Biol.* 55, 715–728.
- Meyer, C.P., Geller, J.B., Paulay, G., 2005. Fine scale endemism on coral reefs: Archipelagic differentiation in turbinid gastropods. *Evolution* 59, 113–125.
- Meyer, C.P., Paulay, G., 2005. DNA barcoding: Error rates based on comprehensive sampling. *PLoS Biol.* 3, 2229–2238.
- Meyer, K.D., Paul, V.J., Sanger, H.R., Nelson, S.G., 1994b. Effects of seaweed extracts and secondary metabolites on feeding by the herbivorous surgeonfish *Naso lituratus*. *Coral Reefs* 13, 105–112.
- Monaghan, M.T., Wild, R., Elliot, M., Fujisawa, T., Balke, M., Inward, D.J., Lees, D.C., Ranaivosolo, R., Eggleton, P., Barraclough, T.G., Vogler, A.P., 2009. Accelerated species inventory on Madagascar using coalescent-based models of species delineation. *Syst. Biol.* 58, 298–311.
- Myers, N., Mittermeier, R.A., Mittermeier, C.G., da Fonseca, G.A.B., Kent, J., 2000. Biodiversity hotspots for conservation priorities. *Nature* 403, 853–858.
- Norton, T.A., 1992. Dispersal by macroalgae. *Eur. J. Phycol.* 27, 293–301.
- O'Meara, B.C., 2010. New heuristic methods for joint species delimitation and species tree inference. *Syst. Biol.* 59, 59–73.
- Palumbi, S.R., 1994. Genetic divergence, reproductive isolation, and marine speciation. *Annu. Rev. Ecol. Syst.* 25, 547–572.
- Paulay, G., Meyer, C., 2002. Diversification in the tropical Pacific: Comparisons between marine and terrestrial systems and the importance of founder speciation. *Integrative and Comparative Biology* 42, 922–934.
- Paulay, G., Meyer, C., 2006. Dispersal and divergence across the greatest ocean region: Do larvae matter? *Integr. Comp. Biol.* 46, 269–281.
- Pfenninger, M., Schwenk, K., 2007. Cryptic animal species are homogeneously distributed among taxa and biogeographical regions. *BMC Evol. Biol.* 7, 121.
- Pietra, F., 2002. Biodiversity and natural product diversity. Pergamon, Trento.
- Pons, J., Barraclough, T.G., Gomez-Zurita, J., Cardoso, A., Duran, D.P., Hazell, S., Kamoun, S., Sumlin, W.D., Vogler, A.P., 2006. Sequence-based species delimitation for the DNA taxonomy of undescribed insects. *Syst. Biol.* 55, 595–609.
- Puglisi, M.P., Paul, V.J., 1997. Intraspecific variation in the red alga *Portieria bornemannii*: Monoterpene concentrations are not influenced by nitrogen or phosphorus enrichment. *Mar. Biol.* 128, 161–170.
- Rambaut, A., Drummond, A., 2007. Tracer v1.4. Available from <http://beast.bio.ed.ac.uk/Tracer>
- Randall, J.E., 1998. Zoogeography of shore fishes of the Indo-Pacific region. *Zool. Stud.* 37, 227–268.
- Roberts, C.M., Hawkins, J.P., 1999. Extinction risk in the sea. *Trends Ecol. Evol.* 14, 241–246.
- Roberts, C.M., McClean, C.J., Veron, J.E.N., Hawkins, J.P., Allen, G.R., McAllister, D.E., Mittermeier, C.G., Schueler, F.W., Spalding, M., Wells, F., Vynne, C., Werner, T.B., 2002. Marine biodiversity hotspots and conservation priorities for tropical reefs. *Science* 295, 1280–1284.
- Ronquist, F., Huelsenbeck, J.P., 2003. MrBayes 3: Bayesian phylogenetic inference under mixed models. *Bioinformatics* 19, 1572–1574.
- Schmitz, F., 1889. Systematische Übersicht der bisher bekannten Gattungen der Florideen. *Flora oder Allgemeine botanische Zeitung* 72, 435–456, pl. XXI.
- Silva, P.C., Basson, P.W., Moe, R.L., 1996. Catalogue of the Benthic Marine Algae of the Indian Ocean. University of California press, London, p. 1259.
- Silva, P.C., Meñez, E.G., Moe, R.L., 1987. Catalog of the Benthic Marine Algae of the Philippines. Smithsonian Institution Press, Washington, D.C.
- Sites, J.W., Marshall, J.C., 2003. Delimiting species: a Renaissance issue in systematic biology. *Trends Ecol. Evol.* 18, 462–470.

- Sites, J.W., Marshall, J.C., 2004. Operational criteria for delimiting species. *Annu. Rev. Ecol. Evol. Syst.* 35, 199-227.
- Stamatakis, A., 2006. RAxML-VI-HPC: Maximum likelihood-based phylogenetic analyses with thousands of taxa and mixed models. *Bioinformatics* 22, 2688-2690.
- Stamatakis, A., Hoover, P., Rougemont, J., 2008. A rapid bootstrap algorithm for the RAxML web servers. *Syst. Biol.* 57, 758-771.
- Tsutsui, I., Huybh, Q.N., Nguyễn, H.D., Arai, S., Yoshida, T., 2005. The Common Marine Plants of Southern Vietnam. Japan Seaweed Association, USA.
- Wiens, J.J., 2007. Species delimitation: New approaches for discovering diversity. *Syst. Biol.* 56, 875-878.
- Wiens, J.J., Penkrot, T.A., 2002. Delimiting species using DNA and morphological variation and discordant species limits in spiny lizards (*Sceloporus*). *Syst. Biol.* 51, 69-91.
- Williams, M.R., Lamont, B.B., Henstridge, J.D., 2009. Species-area functions revisited. *J. Biogeogr.* 36, 1994-2004.
- Wiseman, D.R., 1973. Morphological and taxonomic studies of the red algal genera *Ochtodes* and *Chondrococcus*. Department of Botany. Duke University, Durham, p. 223.
- Wynne, M.J., 1999. New records of benthic marine algae from the Sultanate of Oman. *Contr. Univ. Mich. Herb* 22, 189-208.
- Yang, Z., Rannala, B., 2010. Bayesian species delimitation using multilocus sequence data. *Proc. Natl. Acad. Sci. U.S.A.* 107, 9264-9269.
- Yoshida, T., 1998. Marine Algae of Japan. Uchida Rokakuho Publishing Co., Ltd, Tokyo.
- Zuccarello, G.C., Burger, G., West, J.A., King, R.J., 1999. A mitochondrial marker for red algal intraspecific relationships. *Mol. Ecol.* 8, 1443-1447.



## 4 EVOLUTION OF THE RED SEAWEED

### *PORTIERIA* IN THE TROPICAL INDO-PACIFIC<sup>1</sup>

---

#### Abstract

A wide range of tropical shallow water organisms reach their greatest species richness in the Indo-Malay Archipelago (IMA) or Coral Triangle. Several models have been proposed to explain the origins of this biodiversity hotspot, including the center of origin and center of accumulation hypotheses. We examined species diversity, distributions and phylogenetic relationships within the red alga *Portieria* to determine how historical processes have contributed to present-day biodiversity patterns across the marine tropical Indo-Pacific. DNA-based species delimitation analysis revealed rampant cryptic diversity. Forty-nine *Portieria* species were delineated, which were all restricted to a single Ocean basin. Within the Philippines, several species display fine scale archipelagic and intra-archipelagic endemism, suggesting low dispersal capacity. The highest diversity was recovered in the IMA, with declining species numbers when moving away, both longitudinally and latitudinally, from the center. A species phylogeny implies a long term persistence of ancient lineages within confined regions of the Indo-Pacific, including the IMA. These results suggest that the long and complex geological history of the IMA played an important role in shaping the diversity of *Portieria* in the IMA. The taxonomic richness in the IMA may have resulted from a combination of species accumulation via island integration through tectonic movement, in combination with diversification at small spatial scales within the IMA as a result of increased geographical complexity of the region during the Oligo-Miocene and Pleistocene periods of glacially lowered sea level. This study thus supports both the center of origin and center of accumulation hypothesis, and highlights that there may be not one unifying model to explain the biological diversity within the IMA.

**Keywords:** *Portieria*, evolution, Indo-Pacific, Indo-Malayan Archipelago, center of origin, accumulation

<sup>1</sup> Unpublished manuscript: Payo D.A., Leliaert F., Verbruggen H., Lin, S.M., Calumpong H. & De Clerck O. Evolution of the red seaweed *Portieria* in the tropical Indo-Pacific

## 4.1 Introduction

A global maximum of marine biodiversity is observed in the Indo-Malay Archipelago (IMA, also known as Coral Triangle), a region in the central Indo-West Pacific bounded by the Philippines, Indonesia and Papua New Guinea (Hoeksema, 2007, Briggs, 2009, Bellwood & Meyer, 2009b, Barber, 2009, Connolly *et al.*, 2003). A broad range of tropical coastal organisms, including corals, coastal fishes, several gastropod and crustacean groups, marine angiosperms and some seaweeds, reach their greatest species richness here, with declining diversity gradients when moving away, both longitudinally and latitudinally, from the center (Briggs, 1999, Bellwood & Hughes, 2001, Hoeksema, 2007, Williams & Reid, 2004, Kerswell, 2006, Tittensor *et al.*, 2010).

The IMA biodiversity hotspot has intrigued ecologists and evolutionary biologists for years. Multiple hypotheses, which are not mutually exclusive, have been proposed to explain the origins of taxonomic richness in the IMA, including the center of origin, center of (bio)accumulation and area of overlap hypotheses (Halas & Winterbottom, 2009, Barber, 2009, Connolly *et al.*, 2003).

The center of origin hypothesis posits that the high diversity arises through high local speciation rates, followed by dispersal to the periphery (Ekman, 1953, Briggs, 2000, Mora *et al.*, 2003). In this view, the IMA is regarded as a source (speciation pump) supplying species throughout the remainder of the Indo-Pacific. Pleistocene sea-level changes and the complex geography of the region have been regarded as important drivers of speciation (Briggs, 2000, Hoeksema, 2007, Mora *et al.*, 2003).

The center of accumulation hypothesis states that speciation occurs mostly outside the biodiversity hotspot, such as peripheral islands in the Indian and Pacific Oceans, and that the high diversity within the IMA is a consequence of accumulation of species via dispersal towards the IMA (Ladd, 1960, Connolly *et al.*, 2003). This hypothesis is based on the notion that several central Pacific islands date back to at least the Cretaceous, allowing for a long history of species formation, and that dispersal via prevailing westward ocean currents results in accumulation of species within the IMA (Jokiel & Martinelli, 1992). Because the IMA encompasses one of the most extensive and heterogeneous tropical shallow water environments with large reef areas, many marine taxa may have found refuge in this region (Bellwood & Hughes, 2001, Bellwood & Meyer, 2009b, Hoeksema, 2007, Gaston, 2000). Accumulation of species may also have resulted from integration of distinct biotas by tectonic movement (Rosen & Smith, 1988, Renema

*et al.*, 2008). The IMA is a geologically complex region, formed by several tectonic elements that arrived from different directions over the past 50 million years (Hall, 1998, Hall, 2002). Closely related to the center of accumulation hypothesis is the area of overlap hypothesis, which suggests that the high biodiversity within the IMA is a consequence of overlap as a result range expansion of Pacific and Indian Ocean sister taxa (Woodland, 1983, Bellwood & Meyer, 2009b).

The relative importance of the different processes in contribution to the high diversity in the IMA is hotly debated (Briggs, 2009, Bellwood & Meyer, 2009a). Molecular phylogenies in combination with distribution data of Indo-Pacific species have provided valuable insights into the mechanisms that have contributed to the IMA diversity hotspot. Genetic data, mainly from benthic and coastal pelagic animals, have provided evidence for both the center of origin (e.g., Barber *et al.*, 2006) and center of accumulation hypothesis (e.g., Drew *et al.*, 2008). Several molecular phylogenetic studies indicate that speciation occurs throughout the Indo-Pacific region, both within and outside the IMA (Santini & Winterbottom, 2002, Williams & Reid, 2004, Meyer *et al.*, 2005, Barber & Bellwood, 2005).

Seaweeds are highly diverse and important components of tropical coastal ecosystems but, compared to marine metazoan groups, their phylogenetic relationships and geographical distributions within the Indo-Pacific have been notoriously understudied. In this study we focus on the red seaweed *Portieria*, which is commonly found in coral reefs and is widely distributed in the Indo-Pacific, ranging from the East African coast to the Hawaiian archipelago. Although traditionally, only a single species (*P. hornemannii*) has been recognized based on a broad morphological species concept (Wiseman, 1975), DNA sequence data has indicated extremely high cryptic diversity, with at least 21 species occurring in the Philippines (see chapter 3).

In this study we expanded our Philippine dataset by including specimens sampled from the entire geographical range of *Portieria*. We used a mitochondrial *cox2-3* spacer dataset of 319 specimens to examine species diversity and geographical patterns of species richness. Phylogenetic reconstructions of species divergences were inferred from a five-locus dataset, and a temporal framework for species divergence times was based on molecular clock estimates. We were especially interested to know whether the high diversity observed within the IMA resulted from recent speciation events within the hotspot (center of origin hypothesis), or resulted from speciation outside the IMA and dispersal towards the diversity hotspot (center of accumulation hypothesis).

## 4.2 Materials and methods

### 4.2.1 *Taxon sampling*

A total of 319 *Portieria* specimens were collected from South Africa, Tanzania, Kenya, Socotra, Oman, Sri Lanka, the Maldives, Japan, Taiwan, the Philippines, Indonesia, Papua New Guinea, Pacific Australia and Hawaii, providing good geographical coverage throughout the distribution of *Portieria* (Fig. 4.1). Samples were collected by snorkelling or SCUBA diving and were preserved as herbarium specimens and in silica gel. Herbarium vouchers are deposited in the Ghent University Herbarium. A complete list of specimens and collection data is provided in Table S4.1.

### 4.2.2 *DNA extraction, amplification and sequencing*

DNA was extracted from silica- or herbarium-dried specimens as described in chapter 3. For each specimen, the mitochondrial *cox2-3* spacer was amplified and sequenced. In addition, the mitochondrial *cox1* gene, the plastid encoded *rbcL* and *rbcL-rbcS* spacer and the nuclear encoded elongation factor 2 (EF2) were sequenced for a selection of the samples (Table S4.1). The EF2 gene was sequenced in two parts. PCR conditions and primer sequences are detailed in Table S4.2. PCR amplification and sequencing was performed as described in chapter 3. DNA sequences were edited by eye and aligned using CLUSTAL X in BioEdit v.7.09 (Hall 1999).

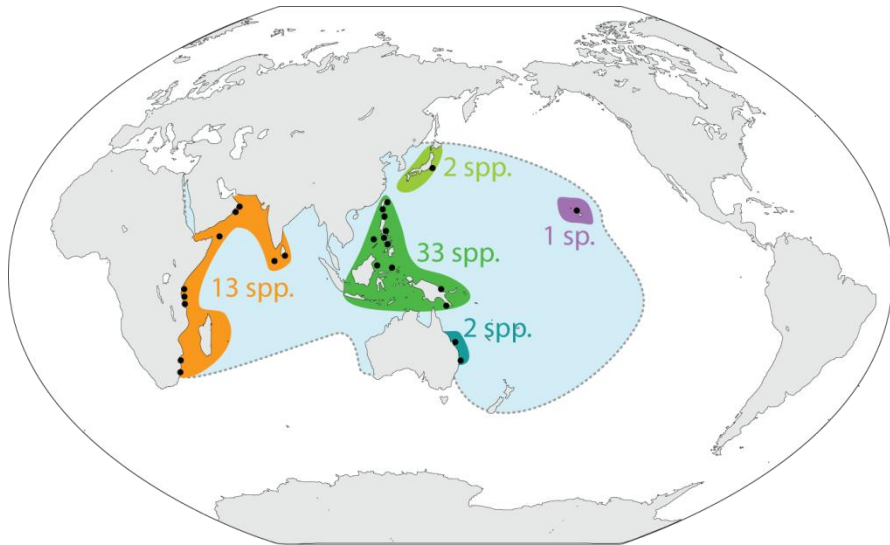

Fig. 4.1. Map showing the location of collecting sites (black dots). The blue area illustrates the known distribution range of *Portieria* (Guiry & Guiry, 2011), and the five coloured areas show the geographical regions used in this study: orange (Western and Central Indian Ocean), dark green (Indo-Malay Archipelago), light green (Japan), cyan (E Australia), purple (Hawaii).

#### 4.2.3 DNA-based species delimitation

Because *Portieria* species are notoriously difficult to distinguish morphologically (chapters 5), species were delimited based on DNA-sequence analysis. General mixed Yule-coalescent (GMYC) model analysis of *cox2*-3 spacer sequences has been shown to provide accurate delimitation of species in *Portieria* (chapter 4). This approach estimates species boundaries directly from branching rates in mixed population-phylogenetic ultrametric trees without the need for any prior definition of populations or species (Monaghan *et al.*, 2009, Pons *et al.*, 2006, Leliaert *et al.*, 2009). An ultrametric tree was obtained by Bayesian phylogenetic analysis of an alignment of unique sequences in BEAST v.1.6.1 (Drummond & Rambaut, 2007), under a GTR + I + G model with an uncorrelated lognormal relaxed molecular clock model and a coalescence tree prior. A Markov Chain Monte Carlo (MCMC) analysis was run for 10 million generations, sampling every 1000 generations. The output was diagnosed for convergence using Tracer v.1.5, and summary statistics and trees were generated using the last 9 million generations with TreeAnnotator v1.5.3 (Rambaut & Drummond, 2007a). GMYC analyses were

performed under single-threshold models (Monaghan *et al.*, 2009), using the SPLITS package for R (<http://r-forge.r-project.org/projects/splits/>).

#### 4.2.4 Phylogenetic analysis

A species-level phylogeny was inferred from a multilocus alignment consisting of a single representative of each GMYC cluster. Five loci (*cox1*: 639 bp; *cox2-3* spacer: 345 bp; *rbcL*: 1044 bp; *rbcL*-spacer: 555 bp; EF2: 1199 bp) were concatenated, yielding an alignment of 3782 positions. Table S4.3 graphically represents the data matrix. Maximum likelihood (ML) analysis and Bayesian phylogenetic inference (BI) were performed using five partitions [*cox1*, *cox2-3* spacer, *rbcL*, *rbcL*-spacer, EF2]. Maximum likelihood (ML) analysis was performed using RAxML rapid bootstrapping (Stamatakis *et al.*, 2008), using a GTR + CAT model for each partition. Bayesian phylogenetic inference was carried out with MrBayes 3.1.2 (Ronquist & Huelsenbeck, 2003) with unlinked GTR models with gamma distribution and four rate categories (GTR + G) selected for each partition. Two parallel runs, each consisting of four incrementally heated chains, were run for 5 million generations, sampling every 1000 generations. Convergence of log-likelihoods and parameter values was assessed in Tracer v1.4 (Rambaut & Drummond, 2007b). A burn-in sample of 1 million generations was removed before constructing a majority rule tree including all compatible bipartitions. *Ochtodes* was selected as outgroup based on molecular phylogenetic data, showing that this genus represents the sister genus of *Portieria* (Chapter 2).

The phylogeny was calibrated in time using two independent methods. First, divergence times were estimated based on the ‘universal’ *cox2-3* calibration reported in Zuccarello & West, 2002, being 0.25- 0.3 % divergence/Ma. Secondly, a time-calibrated phylogeny was inferred using BEAST based on the same matrix used for the ML and BI analyses. In the absence of reliable *Portieria* fossils, two nodes in the tree were constrained in geological time based on a red algal time-calibrated phylogeny, which was constructed as follows. First an ML tree of *Portieria* representatives and related genera (*Ochtodes*, *Nesophila* and *Contarinia*) was constructed based on a concatenated dataset of EF2 and *rbcL* sequences using PhyML (Guindon & Gascuel, 2003), under a GTR + G model. This tree was grafted into the red algal multilocus phylogeny of Verbruggen *et al.* (2010), followed by ML branch optimization in RAxML. Divergence times were estimated using r8s v1.7 (Sanderson, 2002) by rate-smoothing the ML tree using penalized likelihood and a log-smoothing parameter of 3. Eight fossil calibration points were used, which are detailed in Table S4.4. Based on these results, the split between *Portieria*

---

and *Ochtodes* was constrained at 100 Ma and the root of the *Portieria* clade was constrained at 40 Ma (Fig S4.2), both using normal priors with a standard deviation of 5. Shifts in diversification rates across the chronogram were tested using the relative cladogenesis statistic implemented in GEIGER (Harmon *et al.*, 2008). Lineage through time (LTI) plots were generated using APE (Paradis *et al.*, 2004). Both packages run in the R environment for statistical computing and graphics (R Development Core Team, 2009).

### 4.3 Results

#### 4.3.1 *Species diversity and geographical distribution*

The GMYC model analysis of 319 *cox2-3* spacer sequences showed that the likelihood of the GMYC model was significantly higher than that of the null model of uniform (coalescent) branching rates ( $L0 = 805.5$ ,  $LGMYC = 822.6$ ,  $LR = 34.2$ ,  $p < 0.001$ ). The single-threshold GMYC analysis estimated 49 putative *Portieria* species (Fig. 4.2), with a confidence interval of 38-52 species. Two additional species were identified based on specimens for which only *rbcL* sequences were available (Table S4.1).

Thirty-three species were found in the Indo-Malay Archipelago (including Taiwan), 13 species in the Western Indian Ocean, 2 in Japan, 2 in Australia and 1 in Hawaii (Fig. 4.1). All species were entirely restricted to these five regions. Within the regions, most species appeared to have very narrow geographical ranges, being restricted to a single island, island group or short coastal stretch (Table S4.1). Only three species are more widely distributed in the Indian Ocean: species 18 occurs in Kenya, Socotra and Oman, species 20 ranges from Kenya to Sri Lanka, and species 22 was found in Tanzania and Sri Lanka. Fine scale endemism was observed within the Philippines, with most species having very narrow ranges or even occurring in localized populations. Only three species (V32, S39 and S6) were more widely distributed within the Philippines (Fig. 4.2).

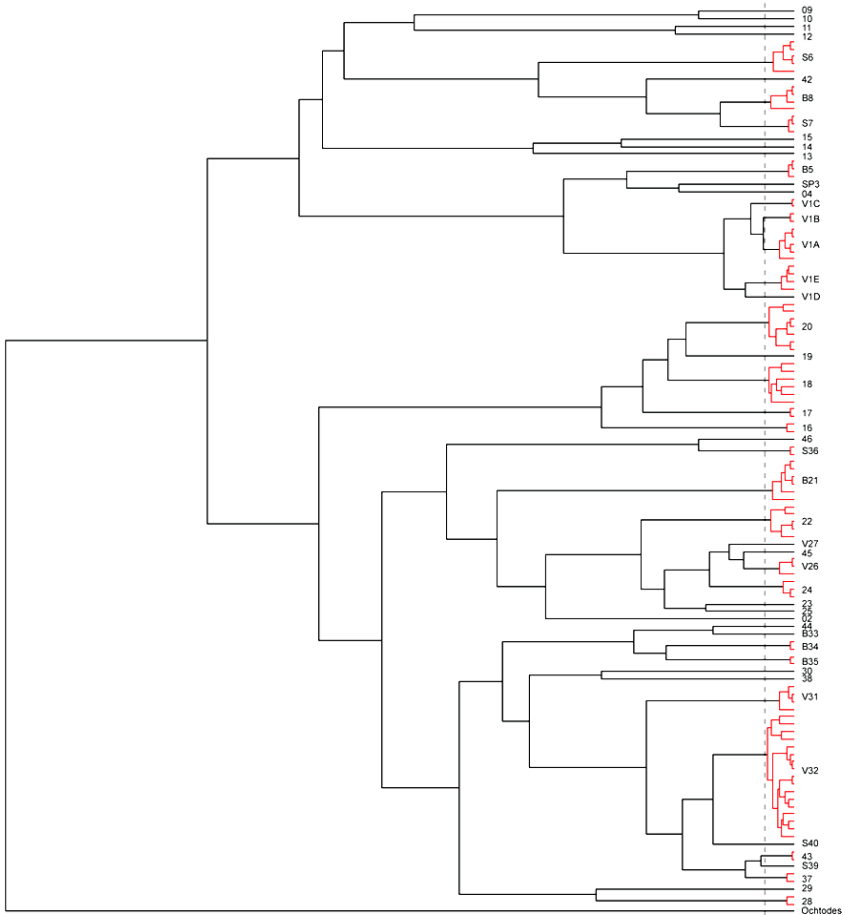

Fig. 4.2. Ultrametric tree of the *Portieria* based on a Bayesian analysis of *cox2-3* spacer sequence data with divergence times estimated under a relaxed molecular clock in BEAST. The dotted vertical line indicates the maximum likelihood transition point of the switch in branching rates from interspecific to intraspecific events, as estimated by a general mixed Yule-coalescent (GMYC) model.



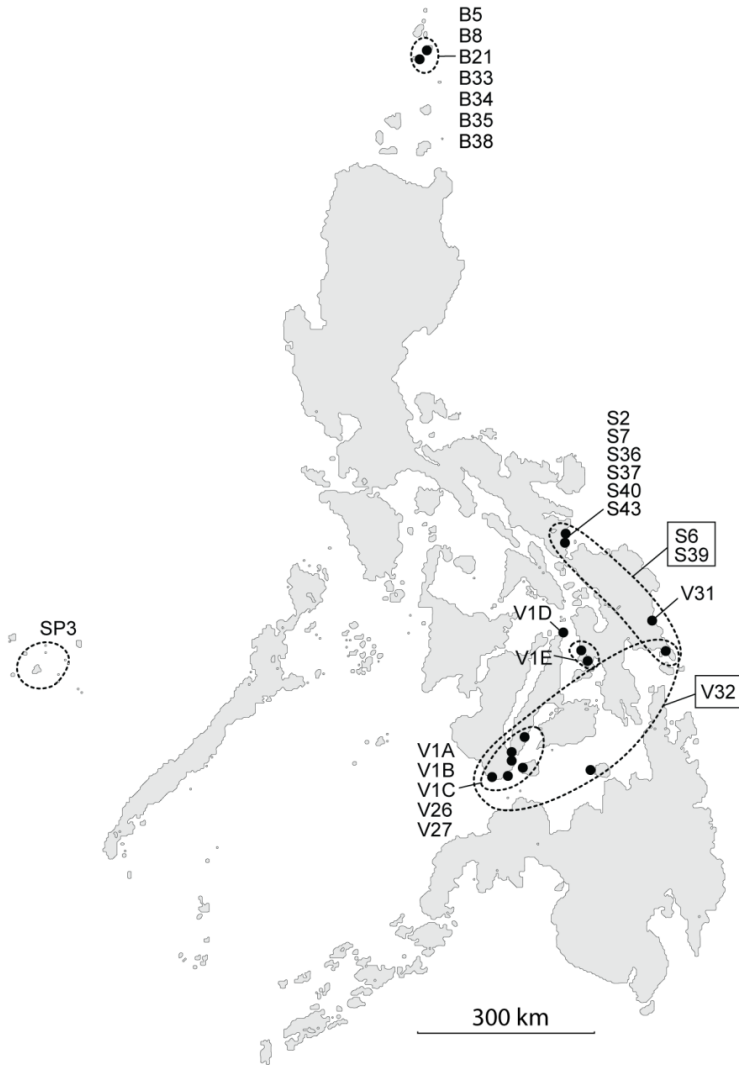

Fig. 4.3. Map of the Philippines illustrating the geographical distributions of species within the archipelago. Most species exhibit intra-archipelagic endemism, with only three species being more widely distributed within the archipelago (S6, S39 and V32).

### 4.3.2 *Species-level phylogeny*

The concatenated alignment of 5 loci consisted of 51 species and 3782 positions and was 73% filled (Table S4.3). ML and BI yielded almost identical tree topologies with general good nodal support, except for the basal divergences, which received moderate to low support in both analyses. The phylogenetic tree obtained from the ML analysis, with indication of ML bootstrap values and BI posterior probabilities, is shown in Fig S4.1. The time-calibrated phylogeny (Fig 4.4 and Fig. 4.5) differed only in the basal divergences of clade 1 and in the position of clade 5; these relationships were poorly supported in all analyses.

Phylogenetic analyses recovered nine main, well supported clades (Fig S4.1 and Fig. 4.4). A strong biogeographical signal was recovered with five clades (2, 3, 5, 8, 9) being confined to a single geographical region. Three large clades (3, 6 and 8) were exclusively, or almost exclusively, composed of species from the IMA.

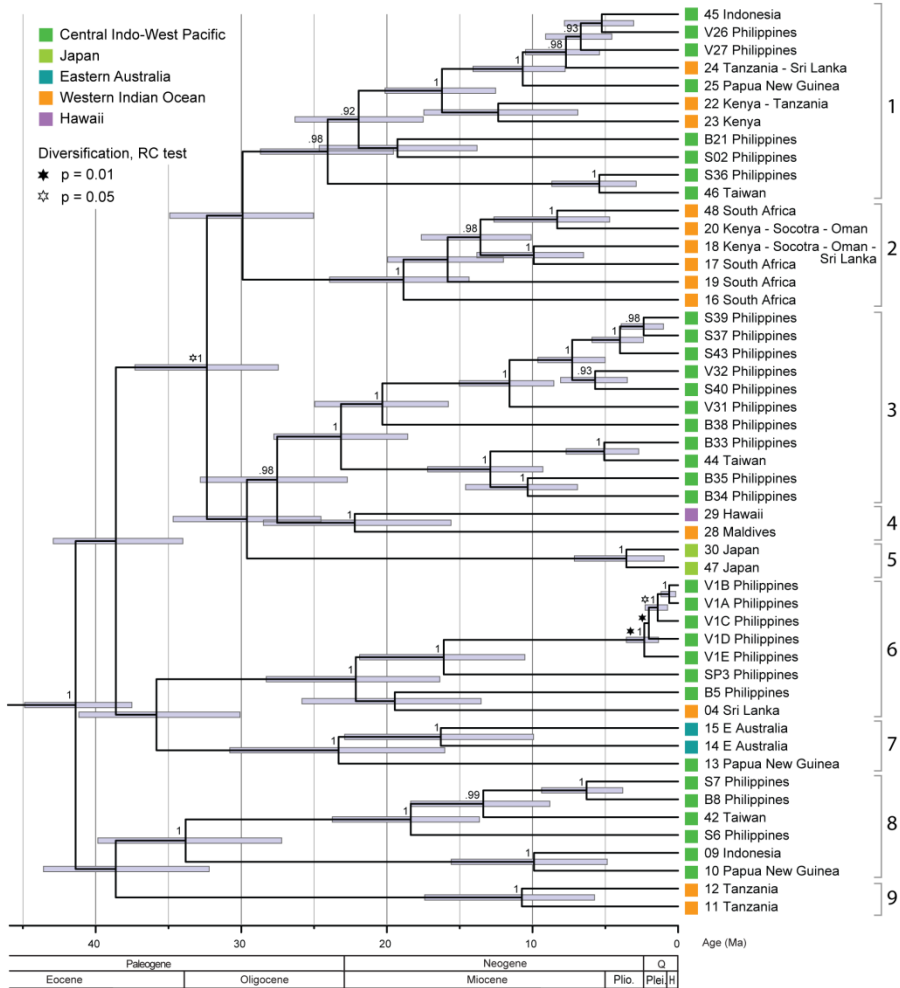

Fig. 4.4. Time-calibrated phylogeny of *Portieria* based on Bayesian analysis of a five-locus data set with divergence times estimated under a relaxed molecular clock in BEAST. Support values are posterior probabilities (PP); only values > 0.90 are shown. Uncertainty in divergence times are indicated by grey bars on internal nodes, corresponding to the 95% highest posterior density (HPD) of node ages. Time is given in millions of years before present. Stars indicate significant diversification shifts using the relative cladogenesis statistic (see key in figure).

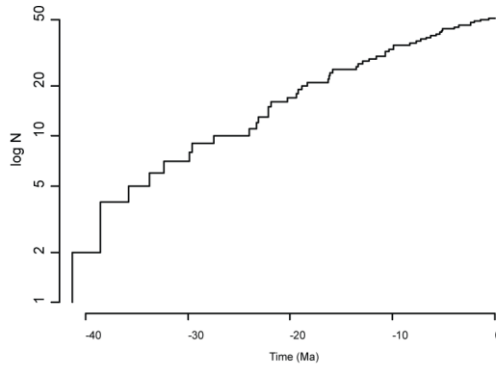

Fig. 4.5. Lineage through time (LTI) plot based on the chronogram in Fig. 4.4, showing a near constant rate of diversification.

The origin of the genus *Portieria* was inferred to be in the middle to late Eocene, around 40 Ma (Fig. 4.4). The nine main clades originated mainly in the Oligocene, and diversification within these clades occurred largely in the Miocene. More recent diversification events (late Miocene to Pleistocene) occurred within IMA clusters in clades 1, 3 and 6. Widely distributed species in the Indian Ocean or within the Philippines were not necessarily older than species with more narrow distributions (Fig S4.1 and Fig. 4.4). Divergence times estimated based on the ‘universal’ *cox2-3* calibration reported in (Zuccarello & West, 2002) were slightly younger, but fell in the same range (Fig S4.3).

The only significant increases in diversification rate ( $p=0.01$ ), estimated using the relative cladogenesis statistic, were identified in a relatively young clade comprising species V1A-V1E (Fig. 4.4). An additional shift in diversification rate ( $p=0.05$ ) was identified on the branch leading to clades 1-5.

## 4.4 Discussion

### 4.4.1 Diversity, distribution and endemism

A striking observation is the high observed species diversity within *Portieria*. Species boundaries within the genus have long been unclear (Chapters 3 and 5). Seven species are currently accepted (Guiry & Guiry, 2011, Silva and Menez, 1987), although Wiseman (1975) recognized only a single, polymorphic species, *P. bornemannii*. The DNA-based species delimitation approach applied in this study identifies 51 species, thereby revealing a much greater diversity than previously envisaged. Morphometric analyses indicate that a few species (e.g. V32, B21, B5 and

V1) can be distinguished by subtle morphological differences, while most other species reveal a morphological continuum (Chapter 5). The 51 species can therefore be regarded as cryptic or pseudocryptic species.

Cryptic speciation results from decoupling of morphological and genetic divergence and is prevalent in a wide variety of marine organisms, including seaweeds (Knowlton, 1993, Bickford et al., 2007, Saunders, 2005, Leliaert et al., 2009, Verbruggen et al., 2007, Zuccarello & West, 2003, Saunders, 2008, Le Gall & Saunders, 2010). Cryptic diversity may be more common in organisms with a simple body plan, such as algae (Verbruggen et al., 2009). In addition, cryptic species have been predicted to be particularly frequent in the sea because many marine organisms, including seaweeds, rely on chemical (i.e., non-visual) signals for gamete recognition, thereby reducing the role of sexual selection in driving morphological divergence (Palumbi, 1994, Knowlton, 1993). Cryptic species that occur sympatrically often display niche partitioning, either by exhibiting distinct ecological preferences (e.g., depth, exposure or substrate) or by displaying temporal partitioning of resources in response to seasonality (Knowlton, 1993). For example, co-occurring cryptic species of the brown seaweed *Dictyota* have been found to exhibit ecological differences related to wave exposure as well as seasonal differences in growth and gamete release (Tronholm et al., 2010). In *Portieria*, spatial or temporal niche partitioning is for now only partly revealed (Chapter 7).

Our study shows that the allegedly widespread morpho-species *P. bornemannii* consists of multiple species with much narrower geographical distributions. All *Portieria* species are confined to a single Ocean basin, and most are restricted to a single archipelago or short coastal stretch. Similar patterns of geographically restricted cryptic species in allegedly widely distributed marine organisms have been reported in other taxa (e.g. Leliaert et al., 2009, Kooistra et al., 2008, Verbruggen et al., 2005, Xavier et al., 2010). Studies focusing on marine invertebrates and fishes have shown that range restricted species are most commonly found in remote peripheral archipelagos (Eble et al., 2009, Malay & Paulay, 2009), but similar to the situation in *Portieria*, endemism has also been shown in the central IWP, indicating that archipelagic endemism may be more common than previously anticipated (Paulay & Meyer, 2002, Meyer et al., 2005, Kirkendale & Meyer, 2004). Nonetheless, the extreme small range sizes found in some *Portieria* species are striking. Within the Philippines, fine-scale endemism was observed for several species and some even appear to occur in localized populations (chapter 3 and this study). This contrasts with most marine shallow-water organisms in the reef rich Indo-West Pacific, which have wider species ranges

(Paulay & Meyer, 2002, Kerswell, 2006). The range sizes found in the Philippine *Portieria* species are unseen for marine benthic organisms and seaweeds in particular, and are reminiscent of the distribution patterns in many groups of terrestrial organisms where examples of intra-island and intra-archipelagic endemism abound (e.g., Cowie & Holland, 2008, Sarnat & Moreau, 2011).

Compared to most marine invertebrates and fish, seaweeds are considered poor dispersers (Shanks *et al.*, 2003, Kinlan & Gaines, 2003). Although the dispersal capacity likely shows variation coinciding with the taxonomic and ecological diversity of seaweeds, the spores or zygotes of most marine seaweeds are typically short-lived and often negatively buoyant (Lüning, 1990, Destombe *et al.*, 1992). In the absence of detached and rafting reproductive thalli, this limited dispersal capacity may reflect strongly on the spatial scale at which speciation takes place. Although, a drifting *Portieria* has been observed in the field in two occasions (particularly, the more widespread species V32), there are no known reports for large scale drifting or any means of dispersal for this macroalga. Our results show that genetic divergence and speciation in the sea can occur over much finer spatial scales than generally accepted.

A clear pattern of maximum diversity of *Portieria* species was observed in the IMA, with declining diversity when moving away from the central Indo-Pacific. This species richness pattern is similar across many other tropical coastal organisms, including several seaweeds (Briggs, 1999, Bellwood & Hughes, 2001, Hoeksema, 2007, Williams & Reid, 2004, Kerswell, 2006, Tittensor *et al.*, 2010). However, the distributions of *Portieria* species contrast to that many other tropical seaweeds, where small-ranged taxa are mostly clustered in peripheral locations and the high diversity in the central Indo-West Pacific is a consequence of overlap of widespread tropical taxa (Kerswell, 2006).

#### 4.4.2 *Evolutionary history of Portieria in the Indo-Pacific*

Our phylogenetic analyses indicate that the early diversification of the *Portieria* clade took place around 30-45 Ma, predating the physical separation of the Indo-West Pacific from other biogeographical regions through the final closure of the Tethys Sea (18-19 Ma). Similar results have been found in other Indo-West Pacific marine organisms (Williams, 2007, Williams & Duda, 2008).

A clear biogeographical signal was observed in our phylogeny, reflecting the limited dispersal of *Portieria* species over long evolutionary time scales. Three main clades are almost entirely restricted to the IMA, and one clade consists exclusively of Indian Ocean species. The estimate ages of these clades range

---

between 15 and 40 Ma, a time frame which is consistent to the long term geological formation of the IMA (Hall, 2002, Hall, 1998), and the emergence of the IMA biodiversity hotspot (Renema et al., 2008). Phylogenetic analyses of several other marine groups show similar patterns, in which lineages and diversification events within IMA clades pre-date the geological formation of the IMA (Renema et al., 2008, Hall, 2002).

Our *Portieria* phylogeny provides evidence relevant to the mechanisms that produced the IMA diversity hotspot. The ancientness of the main *Portieria* clades and the presence of more recent diversifications within these clades suggest that the high diversity of *Portieria* species in the IMA resulted from two processes: 1) accumulation and diversification over a geological time frame of tens of millions of years and 2) more recent speciation events within the IMA. Our findings are thus consistent with both the center of origin and center of accumulation models, acting over long temporal scales. Similar long evolutionary histories within the central Indo-Pacific have been found in fishes and invertebrates (Bellwood *et al.*, 2004, Barber & Bellwood, 2005, Williams, 2007, Williams & Duda, 2008).

Accumulation of species possibly resulted through integration and collision of varied tectonic plate elements from Eurasia, Australia and the Philippines over the last 50 million years (Hall, 2002). Similar accumulation models through integration of multiple distinct biotas by tectonic movement have been proposed for marine invertebrates and fishes (Rosen & Smith, 1988, Renema et al., 2008, Santini & Winterbottom, 2002, Carpenter & Springer, 2005). The long and complex geological history of the region likely also provided opportunities for diversification within the main *Portieria* clades. Several important tectonic events during the Oligo-Miocene caused significant geological changes in the central IWP along with changes in ocean currents (Hall, 1998). These geological changes resulted in the emergence of a broad zone of shallow water, and likely increased the rate of emergence of islands in the IMA. The increased geographical complexity of the region, formation of island barriers and the increased availability of habitats (e.g., coral-carbonate platforms) during the Neogene likely provided opportunities for isolation and speciation (Wilson & Rosen, 1998, Williams & Duda, 2008, Carpenter & Springer, 2005).

Concentrated speciation at small spatial scales within the IMA possibly took place during the Pleistocene periods of glacially lowered sea level when seas (e.g., the South China, Sulu, Philippine, Celebes, Molucca, and Banda seas) or large lagoons became landlocked (Palumbi, 1994, Carpenter & Springer, 2005). During these periods, *Portieria* populations may have experienced prolonged geographical

isolation, which may have led to speciation (Sobel *et al.*, 2010, Dawson & Hamner, 2005). In addition, creation and colonization of empty niches associated with Pleistocene cycles of sea level rise-and-fall likely accelerated speciation rates. Our results are concordant with a large number of studies, which demonstrate that genetic differentiation and speciation in the sea occur over much smaller spatial scales than previously thought (Worheide *et al.*, 2008, Meyer *et al.*, 2005). Overall, our results are in agreement with several studies on marine invertebrates, which show that speciation events are concentrated in the central IWP over long geological time frames, starting in the late Eocene or Oligocene (Williams & Duda, 2008, Alfaro *et al.*, 2007).

The center of origin hypothesis posits that the large-scale gradient in species richness in the Indo-Pacific is the result of speciation within the IMA, followed by dispersal towards other regions (Briggs, 1999, Mora *et al.*, 2003). Although our study partly supports the center of origin model, we did not find evidence for recent or ongoing dispersal of *Portieria* species from the IMA center of origination towards the rest of the Indo-Pacific. Instead the diversity in the other Indo-Pacific regions, such as the central and western Indian Ocean, likely resulted from ancient diversifications, which took place independently from speciation events within the IMA.

## 4.5 Conclusions

Although several tropical taxa exhibit highly congruent patterns of biodiversity, with a prominent hotspot in the IMA, there may be no single explanation for this pattern. Given the age and complex geological history, along with the vast biological diversity of the IMA, it is likely that multiple processes have probably been at work over long temporal scales (Barber, 2009, Halas & Winterbottom, 2009). Our phylogenetic analysis of *Portieria* in the Indo-Pacific reflect the long and complex evolutionary history of this seaweed and suggests that the observed biogeographical patterns are a combination of long-term persistence of ancient lineages within confined geographical regions, including the IMA, along with more recent speciation events, possibly related to the climatic changes in the Pleistocene.

The IMA biodiversity hotspot has provided a focus for numerous evolutionary and ecological studies, which have in their turn supported strategies for conservation efforts (Carpenter *et al.*, 2008). Our study adds to the growing body of evidence that the present-day species richness within the IMA hotspot results from long and intricate evolutionary trajectories. For many organismal



---

groups, the IMA likely serve as both a species pump and a cradle of biodiversity, harbouring ancient lineages that were formed prior to the geological formation of the coral triangle. This study shows the importance of species boundaries in elucidating cryptic species and how it can impact our understanding on the distribution and diversification of tropical seaweeds. Given this understanding, it is therefore, of utmost necessity that clarification on the boundaries of conservation-candidate entities has to be made, including its ranges, so that effective conservation measures and policies are launched.

#### 4.6 Acknowledgements

The authors are grateful to A. Bucol, B. Calañañan, F. Fumar, Z. Generoso, J. Lucañas, R. Ladio, A.D. Macansantos, D.G. Payo and W. Villaver for field sampling assistance, Batanes MENRO Francis Domingo for field and dive assistance, and to T. Cowling, E. Coppejans, S. Draisma, M. Hommersand, D. and M. Littler, R. Naguit, A. Sherwood, W. Tisera, W. Prud'homme Van Reine for samples provided. We greatly appreciate the assistance of Caroline Vlaeminck and Sofie D'hondt on PCR and sequencing work. Funding for this research was provided by the Flemish Interuniversity Council (VLIR) as part of the PhD Grant to D.A. Payo. Completion of this work was made possible by a grant to D.A. Payo from the Belgian National Focal Point to the Global Taxonomy Initiative through Dr. Yves Samyn of the Royal Belgian Institute of Natural Sciences (RBINS).

4.7 Supplementary figures

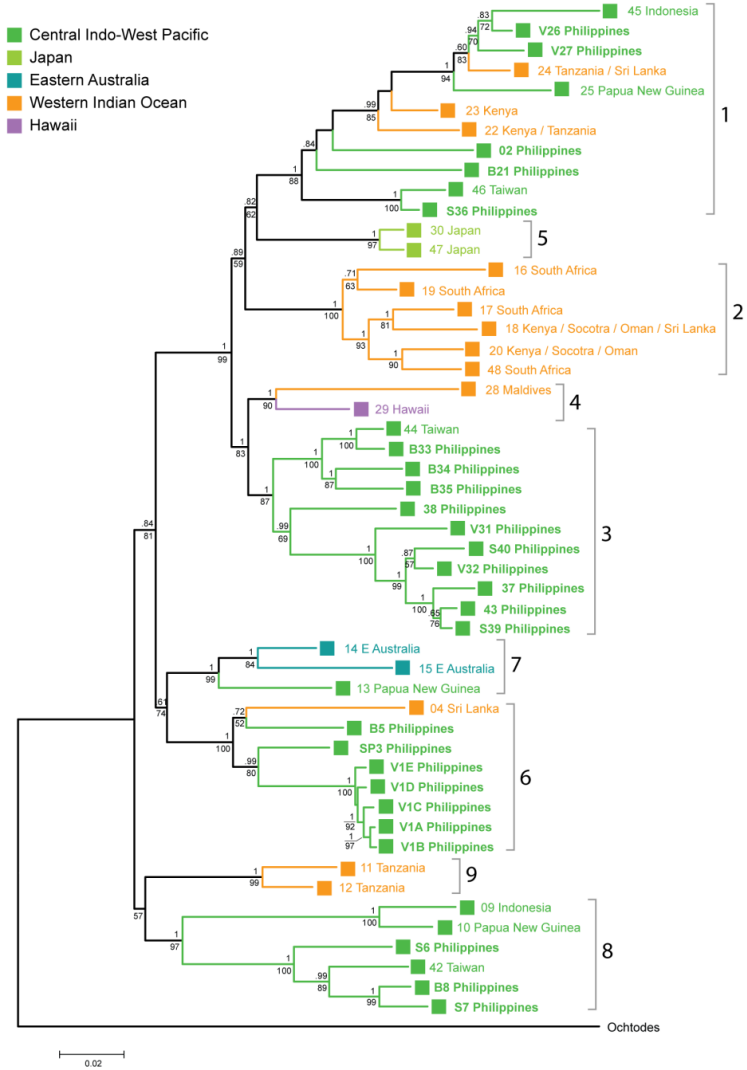

Fig. S4.1. ML species tree of *Portieria*, with indication of ML bootstrap values (above branches) and BI posterior probabilities (below branches).

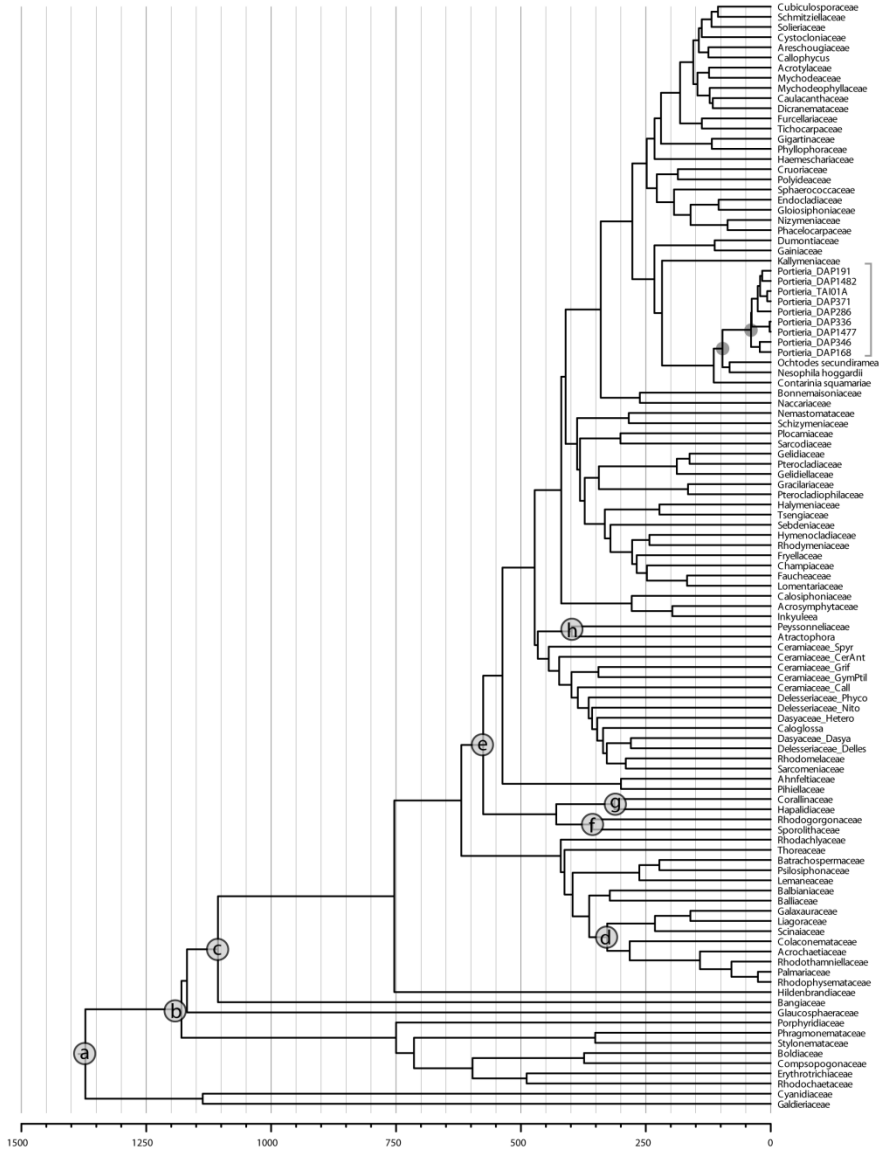

Fig. S4.2. Time-calibrated phylogeny of the red algae.

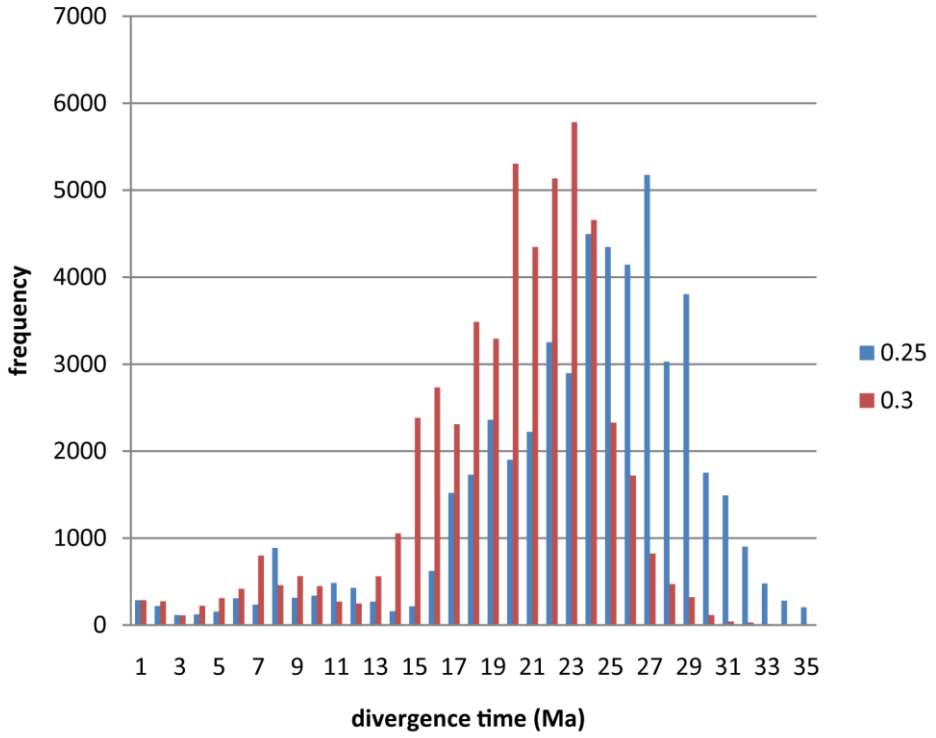

Fig. S4.3. *Portieria* divergence based on the 'universal' *cox2-3* calibration reported in Zuccarello & West (2002), being 0.25-0.3 % divergence/Ma.

## 4.8 Supplementary tables

Table S4.1. List of specimens, site of collection and available sequence data.

Species	Voucher	Field ID	Location	cox 1	cox 23	EF2_1	EF2_3	rbc L	rbc L-sp
4	HEC11802	<i>Portieria hornemannii</i>	Beruwela, Sri Lanka	x	x			x	x
9	BER16	<i>Portieria hornemannii</i>	Maratua, N.E. Coast, Borneo, Indonesia	x	x			x	x
9	BER17	<i>Portieria hornemannii</i>	Maratua, N.E. Coast, Borneo, Indonesia	x	x			x	x
10	HEC6584	<i>Portieria hornemannii</i>	Boisa Island, Madang Province, Papua New Guinea		x				x
11	HEC12085	<i>Portieria hornemannii</i>	Zanzibar - Matemwe, Tanzania	x	x			x	x
12	HEC12155	<i>Portieria hornemannii</i>	Borabo reef, Tanzania		x			x	
13	HEC4280	<i>Portieria hornemannii</i>	Laing Island, Besalpap, Papua New Guinea		x			x	x
13	HEC13421B	<i>Portieria hornemannii</i>	Madang - Pig Island, Papua New Guinea						x
14	HEC12499	<i>Portieria hornemannii</i>	Arrawarra beach - drift specimens, Australia	x	x			x	x
15	POR004	<i>Portieria hornemannii</i>	North Keppel Is., Australia	x	x				x
16	ODC1160	<i>Portieria triplinnata</i>	Palm Beach, Kwazulu-Natal, South Africa	x	x		x	x	x
16	KZN27	<i>Portieria triplinnata</i>	Zinkwazi, Black Rock Park, South Africa	x	x			x	x
17	KZN2310	<i>Portieria hornemannii</i>	Isipingo, South Africa	x	x		x	x	x
17	HEC11004	<i>Portieria hornemannii</i>	Mission Rocks, St. Lucia, Kwazulu-Natal, South Africa		x				x
17	KZN852	<i>Portieria hornemannii</i>	Palm Beach, South Africa		x				x
18	HEC8490	<i>Portieria hornemannii</i>	Diani, Kenya		x				
18	MAS5050	<i>Portieria hornemannii</i>	Masirah, Oman		x				x
18	ODC1609	<i>Portieria hornemannii</i>	McKenzie Pt, Nyali, Mombasa, Kenya	x	x				x
18	SOC030	<i>Portieria hornemannii</i>	Socotra, Yemen		x				
18	SOC154	<i>Portieria hornemannii</i>	Socotra, Yemen		x			x	x
18	HEC14316	<i>Portieria hornemannii</i>	Tangalle, Sri Lanka		x				x
19	KZN24	<i>Portieria hornemannii</i>	Mabibi, Kwazulu Natal, South Africa	x	x			x	x
20	BAH4012	<i>Portieria hornemannii</i>	Barr Al Hikman, Ash Sharqiyah, Oman		x				x
20	SOC394	<i>Portieria hornemannii</i>	Bidhola, Najid, Socotra Archipelago, Yemen		x			x	
20	ODC1589	<i>Portieria hornemannii</i>	Kinondo Reef, Kenya	x	x			x	x
20	ODC1592	<i>Portieria hornemannii</i>	Kinondo Reef, Kenya		x		x		x
20	ODC1595	<i>Portieria hornemannii</i>	Kinondo Reef, Kenya		x				x
20	ODC1596	<i>Portieria hornemannii</i>	Kinondo Reef, Kenya		x			x	x
20	MAS5060	<i>Portieria hornemannii</i>	Masirah, Oman		x				x
20	HEC7191	<i>Portieria hornemannii</i>	McKenzie Pt., Mombasa, Kenya		x				
20	SOC374	<i>Portieria hornemannii</i>	Steroh, Najid, Socotra Archipelago, Yemen		x				
22	ODC1590	<i>Portieria hornemannii</i>	Kinondo Reef, Kenya	x	x		x	x	x
22	ODC1591	<i>Portieria hornemannii</i>	Kinondo Reef, Kenya	x	x			x	x
22	ODC1593	<i>Portieria hornemannii</i>	Kinondo Reef, Kenya		x			x	x
22	ODC1597	<i>Portieria hornemannii</i>	Kinondo Reef, Kenya		x				x
22	HEC12055	<i>Portieria hornemannii</i>	Zanzibar - Matemwe - Mhemba Reef, Kichwani, Tanzania		x				x
23	ODC1665	<i>Portieria hornemannii</i>	Gazi, Chale Island, Kenya		x				x
24	HEC16081	<i>Portieria hornemannii</i>	Beruwela, Sri Lanka		x			x	x
24	HEC15980	<i>Portieria hornemannii</i>	Kalpitiya Reef, Sri Lanka		x				x
24	HEC11748	<i>Portieria hornemannii</i>	Mafia Island, Chole Bay, Tanzania		x				
25	HEC10175	<i>Portieria hornemannii</i>	Port Moresby area, Motupore Island, Papua New Guinea	x	x				x
28	HEC6120	<i>Portieria hornemannii</i>	Bi Ya Doo Island, The Maldives		x				
28	HEC12561	<i>Portieria hornemannii</i>	Elaidhoo, Maldives		x			x	x
29	ODC906	<i>Portieria hornemannii</i>	Kaalawai, Oahu, Hawaii	x	x			x	x

Table S4.1. Continued.

Species	Voucher	Field ID	Location	cox 1	cox 23	EF2_1	EF2_3	rbc L	rbc L-sp
29	HAW001	<i>Portieria hornemannii</i>	Waikiki, Haw aii	x	x		x	x	x
30	POR001	<i>Portieria japonica</i>	Tokawa, Choshi, Chiba, Japan	x	x			x	x
31	MAY011	<i>Portieria hornemannii</i>	Pasig reef, Maydolong, Eastern Samar, Philippines		x		x		
31	MAY012	<i>Portieria hornemannii</i>	Pasig reef, Maydolong, Eastern Samar, Philippines		x		x		
35	DAP1393	<i>Portieria hornemannii</i>	Pier Basco, Batanes, Philippines		x				
35	DAP1394	<i>Portieria hornemannii</i>	Pier Basco, Batanes, Philippines		x				
35	DAP1450	<i>Portieria hornemannii</i>	Pier Mahatao, Batanes, Philippines		x				
38	DAP1427	<i>Portieria hornemannii</i>	Coral, Basco, Batanes, Philippines	x	x	x		x	x
42	TAI04B	<i>Portieria hornemannii</i>	Sail Rook, Kenting National Park, Southern Taiwan		x		x		
44	TAI01A	<i>Portieria hornemannii</i>	Ho Ping Island, Keelung City, N.E. Taiwan	x	x	x	x	x	x
44	TAI02A	<i>Portieria hornemannii</i>	Ho Ping Island, Keelung City, N.E. Taiwan	x	x	x	x	x	x
44	TAI03A	<i>Portieria hornemannii</i>	Ho Ping Island, Keelung City, N.E. Taiwan	x	x	x	x	x	x
44	TAI04A	<i>Portieria hornemannii</i>	Ho Ping Island, Keelung City, N.E. Taiwan		x				
44	TAI05A	<i>Portieria hornemannii</i>	Ho Ping Island, Keelung City, N.E. Taiwan		x				
44	TAI06A	<i>Portieria hornemannii</i>	Ho Ping Island, Keelung City, N.E. Taiwan		x				
45	BUN001	<i>Portieria hornemannii</i>	Bunaken Island, Manado, Indonesia		x				
45	BUN002	<i>Portieria hornemannii</i>	Bunaken Island, Manado, Indonesia		x				
45	BUN003	<i>Portieria hornemannii</i>	Bunaken Island, Manado, Indonesia		x				
46	TAI01B	<i>Portieria hornemannii</i>	Sail Rook, Kenting National Park, Southern Taiwan	x	x	x	x		x
46	TAI02B	<i>Portieria hornemannii</i>	Sail Rook, Kenting National Park, Southern Taiwan	x	x	x	x		x
46	TAI03B	<i>Portieria hornemannii</i>	Sail Rook, Kenting National Park, Southern Taiwan	x	x		x		x
46	TAI05B	<i>Portieria hornemannii</i>	Sail Rook, Kenting National Park, Southern Taiwan		x				
46	TAI06B	<i>Portieria hornemannii</i>	Sail Rook, Kenting National Park, Southern Taiwan		x				
47	U04215	<i>Portieria hornemannii</i>	NCBI					x	
48	AF212185	<i>Portieria hornemannii</i>	NCBI					x	
B21	DAP364	<i>Portieria hornemannii</i>	Chanaryan, Basco, Batanes, Philippines		x				x
B21	DAP367	<i>Portieria hornemannii</i>	Chanaryan, Basco, Batanes, Philippines	x	x			x	x
B21	DAP369	<i>Portieria hornemannii</i>	Chanaryan, Basco, Batanes, Philippines	x	x	x	x	x	x
B21	DAP374	<i>Portieria hornemannii</i>	Chanaryan, Basco, Batanes, Philippines		x				x
B21	DAP375	<i>Portieria hornemannii</i>	Chanaryan, Basco, Batanes, Philippines		x				x
B21	DAP1466	<i>Portieria hornemannii</i>	Chavayan, Sabtang, Batanes, Philippines		x	x	x		
B21	DAP1471	<i>Portieria hornemannii</i>	Chavayan, Sabtang, Batanes, Philippines		x	x	x		
B21	DAP1472	<i>Portieria hornemannii</i>	Chavayan, Sabtang, Batanes, Philippines		x				
B21	DAP1422	<i>Portieria hornemannii</i>	Coral, Basco, Batanes, Philippines		x		x		
B21	DAP1449	<i>Portieria hornemannii</i>	Pier Mahatao, Batanes, Philippines		x	x	x		
B21	DAP1434	<i>Portieria hornemannii</i>	White Beach, Mahatao, Batanes, Philippines		x		x		
B21	DAP1437	<i>Portieria hornemannii</i>	White Beach, Mahatao, Batanes, Philippines		x		x		
B21	DAP1442	<i>Portieria hornemannii</i>	White Beach, Mahatao, Batanes, Philippines		x	x			
B21	DAP339	<i>Portieria hornemannii</i>	White Beach, Mahatao, Batanes, Philippines		x		x	x	x
B33	DAP1419	<i>Portieria hornemannii</i>	Coral, Basco, Batanes, Philippines		x		x		
B33	DAP1420	<i>Portieria hornemannii</i>	Coral, Basco, Batanes, Philippines		x		x		
B33	DAP1424	<i>Portieria hornemannii</i>	Coral, Basco, Batanes, Philippines		x				
B33	DAP1425	<i>Portieria hornemannii</i>	Coral, Basco, Batanes, Philippines		x		x		
B33	DAP1426	<i>Portieria hornemannii</i>	Coral, Basco, Batanes, Philippines		x				
B33	DAP1428	<i>Portieria hornemannii</i>	Coral, Basco, Batanes, Philippines		x				
B33	DAP1429	<i>Portieria hornemannii</i>	Coral, Basco, Batanes, Philippines		x				
B33	DAP1430	<i>Portieria hornemannii</i>	Coral, Basco, Batanes, Philippines		x		x		
B33	DAP1431	<i>Portieria hornemannii</i>	Coral, Basco, Batanes, Philippines		x				
B33	DAP1432	<i>Portieria hornemannii</i>	White Beach, Mahatao, Batanes, Philippines		x				
B34	DAP337	<i>Portieria hornemannii</i>	White Beach, Mahatao, Batanes, Philippines	x	x	x	x	x	x
B34	DAP338	<i>Portieria hornemannii</i>	White Beach, Mahatao, Batanes, Philippines	x	x	x		x	x

Table S4.1. Continued.

Species	Voucher	Field ID	Location	cox 1	cox 23	EF2_1	EF2_3	rbc L	rbc L-sp
B33	DAP1428	<i>Portieria hornemannii</i>	Coral, Basco, Batanes, Philippines		x				
B33	DAP1429	<i>Portieria hornemannii</i>	Coral, Basco, Batanes, Philippines		x				
B33	DAP1430	<i>Portieria hornemannii</i>	Coral, Basco, Batanes, Philippines		x		x		
B33	DAP1431	<i>Portieria hornemannii</i>	Coral, Basco, Batanes, Philippines		x				
B33	DAP1432	<i>Portieria hornemannii</i>	White Beach, Mahatao, Batanes, Philippines		x				
B34	DAP337	<i>Portieria hornemannii</i>	White Beach, Mahatao, Batanes, Philippines	x	x	x	x	x	x
B34	DAP338	<i>Portieria hornemannii</i>	White Beach, Mahatao, Batanes, Philippines	x	x	x		x	x
B35	DAP363	<i>Portieria hornemannii</i>	Chanaryan, Basco, Batanes, Philippines	x	x		x	x	
B35	DAP368	<i>Portieria hornemannii</i>	Chanaryan, Basco, Batanes, Philippines	x	x			x	x
B35	DAP371	<i>Portieria hornemannii</i>	Chanaryan, Basco, Batanes, Philippines	x	x		x	x	x
B35	DAP372	<i>Portieria hornemannii</i>	Chanaryan, Basco, Batanes, Philippines		x				x
B35	DAP377	<i>Portieria hornemannii</i>	Chanaryan, Basco, Batanes, Philippines		x				x
B35	DAP1467	<i>Portieria hornemannii</i>	Chavayan, Sabtang, Batanes, Philippines		x				
B35	DAP1421	<i>Portieria hornemannii</i>	Coral, Basco, Batanes, Philippines		x	x			
B35	DAP1423	<i>Portieria hornemannii</i>	Coral, Basco, Batanes, Philippines		x				
B35	DAP1395	<i>Portieria hornemannii</i>	Pier Basco, Batanes, Philippines		x				
B35	DAP1398	<i>Portieria hornemannii</i>	Pier Basco, Batanes, Philippines		x				
B35	DAP1399	<i>Portieria hornemannii</i>	Pier Basco, Batanes, Philippines		x				
B35	DAP1400	<i>Portieria hornemannii</i>	Pier Basco, Batanes, Philippines		x		x		
B35	DAP1403	<i>Portieria hornemannii</i>	Pier Basco, Batanes, Philippines		x		x		
B35	DAP1404	<i>Portieria hornemannii</i>	Pier Basco, Batanes, Philippines		x		x		
B35	DAP1405	<i>Portieria hornemannii</i>	Pier Basco, Batanes, Philippines		x				
B35	DAP1409	<i>Portieria hornemannii</i>	Pier Basco, Batanes, Philippines		x				
B35	DAP1410	<i>Portieria hornemannii</i>	Pier Basco, Batanes, Philippines		x				
B35	DAP1411	<i>Portieria hornemannii</i>	Pier Basco, Batanes, Philippines		x				
B35	DAP1412	<i>Portieria hornemannii</i>	Pier Basco, Batanes, Philippines		x		x		
B35	DAP1413	<i>Portieria hornemannii</i>	Pier Basco, Batanes, Philippines		x				
B35	DAP1414	<i>Portieria hornemannii</i>	Pier Basco, Batanes, Philippines		x				
B35	DAP1415	<i>Portieria hornemannii</i>	Pier Basco, Batanes, Philippines		x				
B35	DAP1417	<i>Portieria hornemannii</i>	Pier Basco, Batanes, Philippines		x				
B35	DAP1443	<i>Portieria hornemannii</i>	White Beach, Mahatao, Batanes, Philippines		x		x		
B35	DAP1447	<i>Portieria hornemannii</i>	White Beach, Mahatao, Batanes, Philippines		x				
B35	DAP340	<i>Portieria hornemannii</i>	White Beach, Mahatao, Batanes, Philippines		x			x	x
B35	DAP342	<i>Portieria hornemannii</i>	White Beach, Mahatao, Batanes, Philippines		x				
B35	DAP347	<i>Portieria hornemannii</i>	White Beach, Mahatao, Batanes, Philippines		x				x
B5	DAP352	<i>Portieria hornemannii</i>	Chanaryan, Basco, Batanes, Philippines		x				
B5	DAP365	<i>Portieria hornemannii</i>	Chanaryan, Basco, Batanes, Philippines		x				
B5	DAP370	<i>Portieria hornemannii</i>	Chanaryan, Basco, Batanes, Philippines		x				
B5	DAP373	<i>Portieria hornemannii</i>	Chanaryan, Basco, Batanes, Philippines		x				
B5	DAP1451	<i>Portieria hornemannii</i>	Chavayan, Sabtang, Batanes, Philippines		x		x		
B5	DAP1452	<i>Portieria hornemannii</i>	Chavayan, Sabtang, Batanes, Philippines		x		x		
B5	DAP1453	<i>Portieria hornemannii</i>	Chavayan, Sabtang, Batanes, Philippines		x				
B5	DAP1454	<i>Portieria hornemannii</i>	Chavayan, Sabtang, Batanes, Philippines		x				
B5	DAP1455	<i>Portieria hornemannii</i>	Chavayan, Sabtang, Batanes, Philippines		x		x		
B5	DAP1456	<i>Portieria hornemannii</i>	Chavayan, Sabtang, Batanes, Philippines		x				
B5	DAP1457	<i>Portieria hornemannii</i>	Chavayan, Sabtang, Batanes, Philippines		x				
B5	DAP1458	<i>Portieria hornemannii</i>	Chavayan, Sabtang, Batanes, Philippines		x				
B5	DAP1459	<i>Portieria hornemannii</i>	Chavayan, Sabtang, Batanes, Philippines		x		x		
B5	DAP1460	<i>Portieria hornemannii</i>	Chavayan, Sabtang, Batanes, Philippines		x				
B5	DAP1462	<i>Portieria hornemannii</i>	Chavayan, Sabtang, Batanes, Philippines		x				
B5	DAP1463	<i>Portieria hornemannii</i>	Chavayan, Sabtang, Batanes, Philippines		x				

Table S4.1. Continued.

Species	Voucher	Field ID	Location	cox 1	cox 23	EF2_1	EF2_3	rbc L	rbc L-sp
B5	DAP1464	<i>Portieria hornemannii</i>	Chavayan, Sabtang, Batanes, Philippines		x		x		
B5	DAP1465	<i>Portieria hornemannii</i>	Chavayan, Sabtang, Batanes, Philippines		x				
B5	DAP1469	<i>Portieria hornemannii</i>	Chavayan, Sabtang, Batanes, Philippines		x				
B5	DAP1470	<i>Portieria hornemannii</i>	Chavayan, Sabtang, Batanes, Philippines		x				
B5	DAP1435	<i>Portieria hornemannii</i>	White Beach, Mahatao, Batanes, Philippines		x				
B5	DAP1436	<i>Portieria hornemannii</i>	White Beach, Mahatao, Batanes, Philippines		x	x	x		
B5	DAP1438	<i>Portieria hornemannii</i>	White Beach, Mahatao, Batanes, Philippines		x				
B5	DAP1440	<i>Portieria hornemannii</i>	White Beach, Mahatao, Batanes, Philippines		x		x		
B5	DAP1441	<i>Portieria hornemannii</i>	White Beach, Mahatao, Batanes, Philippines		x		x		
B5	DAP1445	<i>Portieria hornemannii</i>	White Beach, Mahatao, Batanes, Philippines		x		x		
B5	DAP1446	<i>Portieria hornemannii</i>	White Beach, Mahatao, Batanes, Philippines		x		x		
B5	DAP318	<i>Portieria hornemannii</i>	White Beach, Mahatao, Batanes, Philippines		x				
B5	DAP321	<i>Portieria hornemannii</i>	White Beach, Mahatao, Batanes, Philippines		x				
B5	DAP333	<i>Portieria hornemannii</i>	White Beach, Mahatao, Batanes, Philippines	x	x	x	x	x	x
B5	DAP334	<i>Portieria hornemannii</i>	White Beach, Mahatao, Batanes, Philippines	x	x		x	x	x
B5	DAP343	<i>Portieria hornemannii</i>	White Beach, Mahatao, Batanes, Philippines		x				x
B5	DAP344	<i>Portieria hornemannii</i>	White Beach, Mahatao, Batanes, Philippines		x		x		x
B5	DAP346	<i>Portieria hornemannii</i>	White Beach, Mahatao, Batanes, Philippines		x	x	x	x	x
B8	DAP1439	<i>Portieria hornemannii</i>	White Beach, Mahatao, Batanes, Philippines		x	x	x	x	x
B8	DAP1444	<i>Portieria hornemannii</i>	White Beach, Mahatao, Batanes, Philippines	x	x		x	x	x
B8	DAP1461	<i>Portieria hornemannii</i>	Chavayan, Sabtang, Batanes, Philippines	x	x	x	x	x	x
B8	DAP1468	<i>Portieria hornemannii</i>	Chavayan, Sabtang, Batanes, Philippines		x				
B8	DAP1396	<i>Portieria hornemannii</i>	Pier Basco, Batanes, Philippines	x	x		x	x	x
B8	DAP1397	<i>Portieria hornemannii</i>	Pier Basco, Batanes, Philippines		x	x	x	x	x
B8	DAP1401	<i>Portieria hornemannii</i>	Pier Basco, Batanes, Philippines		x				
B8	DAP1402	<i>Portieria hornemannii</i>	Pier Basco, Batanes, Philippines		x				
B8	DAP1406	<i>Portieria hornemannii</i>	Pier Basco, Batanes, Philippines		x				
B8	DAP1407	<i>Portieria hornemannii</i>	Pier Basco, Batanes, Philippines		x				
B8	DAP1408	<i>Portieria hornemannii</i>	Pier Basco, Batanes, Philippines		x				
B8	DAP1416	<i>Portieria hornemannii</i>	Pier Basco, Batanes, Philippines		x				
B8	DAP1418	<i>Portieria hornemannii</i>	Pier Basco, Batanes, Philippines		x	x	x		
B8	DAP1448	<i>Portieria hornemannii</i>	Pier Mahatao, Batanes, Philippines		x	x		x	x
B8	DAP336	<i>Portieria hornemannii</i>	White Beach, Mahatao, Batanes, Philippines	x	x		x	x	x
B8	DAP345	<i>Portieria hornemannii</i>	White Beach, Mahatao, Batanes, Philippines	x	x		x	x	x
S2	DAP1501	<i>Portieria hornemannii</i>	Dapdap, Bulusan, Sorsogon, Philippines		x				
S36	DAP1482	<i>Portieria hornemannii</i>	Dancalan, Bulusan, Sorsogon, Philippines	x	x	x	x	x	x
S36	DAP1487	<i>Portieria hornemannii</i>	Dancalan, Bulusan, Sorsogon, Philippines	x	x	x	x	x	x
S36	DAP1490	<i>Portieria hornemannii</i>	Dancalan, Bulusan, Sorsogon, Philippines	x	x	x	x	x	x
S39	GUI004	<i>Portieria hornemannii</i>	Binuthan, Guiuan, Eastern Samar, Philippines		x				
S39	GUI010	<i>Portieria hornemannii</i>	Binuthan, Guiuan, Eastern Samar, Philippines		x				
S39	GUI013	<i>Portieria hornemannii</i>	Binuthan, Guiuan, Eastern Samar, Philippines		x				
S39	GUI016	<i>Portieria hornemannii</i>	Binuthan, Guiuan, Eastern Samar, Philippines		x				
S39	GUI017	<i>Portieria hornemannii</i>	Binuthan, Guiuan, Eastern Samar, Philippines		x				
S39	GUI019	<i>Portieria hornemannii</i>	Binuthan, Guiuan, Eastern Samar, Philippines		x				
S39	DAP1476	<i>Portieria hornemannii</i>	Dancalan, Bulusan, Sorsogon, Philippines	x	x		x		x
S39	DAP1480	<i>Portieria hornemannii</i>	Dancalan, Bulusan, Sorsogon, Philippines	x	x		x		x
S39	DAP1483	<i>Portieria hornemannii</i>	Dancalan, Bulusan, Sorsogon, Philippines		x				
S39	DAP1491	<i>Portieria hornemannii</i>	Dancalan, Bulusan, Sorsogon, Philippines	x	x				
S39	DAP1492	<i>Portieria hornemannii</i>	Dancalan, Bulusan, Sorsogon, Philippines		x				
S39	DAP290	<i>Portieria hornemannii</i>	Pasig reef, Maydolong, Eastern Samar, Philippines	x	x	x			x
S39	DAP297	<i>Portieria hornemannii</i>	Pasig reef, Maydolong, Eastern Samar, Philippines		x				



Table S4.1. Continued.

Species	Voucher	Field ID	Location	cox 1	cox 23	EF2_1	EF2_3	rbc L	rbc L-sp
S40	DAP1473	<i>Portieria hornemannii</i>	Dancalan, Bulusan, Sorsogon, Philippines	x	x	x	x	x	x
S40	DAP1493	<i>Portieria hornemannii</i>	Dapdap, Bulusan, Sorsogon, Philippines		x	x	x		x
S6	DAP1474	<i>Portieria hornemannii</i>	Dancalan, Bulusan, Sorsogon, Philippines		x		x		
S6	DAP1475	<i>Portieria hornemannii</i>	Dancalan, Bulusan, Sorsogon, Philippines		x		x		
S6	DAP1484	<i>Portieria hornemannii</i>	Dancalan, Bulusan, Sorsogon, Philippines	x	x	x	x	x	x
S6	DAP1502	<i>Portieria hornemannii</i>	Dancalan, Bulusan, Sorsogon, Philippines		x				
S6	DAP1503	<i>Portieria hornemannii</i>	Dapdap, Bulusan, Sorsogon, Philippines	x	x	x	x	x	x
S6	DAP1504	<i>Portieria hornemannii</i>	Dapdap, Bulusan, Sorsogon, Philippines		x				
S6	DAP1505	<i>Portieria hornemannii</i>	Dapdap, Bulusan, Sorsogon, Philippines		x		x		
S6	DAP1506	<i>Portieria hornemannii</i>	Dapdap, Bulusan, Sorsogon, Philippines		x		x		
S6	DAP1507	<i>Portieria hornemannii</i>	Dapdap, Bulusan, Sorsogon, Philippines		x				
S6	DAP1508	<i>Portieria hornemannii</i>	Dapdap, Bulusan, Sorsogon, Philippines		x				
S6	DAP1509	<i>Portieria hornemannii</i>	Dapdap, Bulusan, Sorsogon, Philippines		x		x		
S6	DAP1510	<i>Portieria hornemannii</i>	Dapdap, Bulusan, Sorsogon, Philippines		x				
S6	DAP1511	<i>Portieria hornemannii</i>	Dapdap, Bulusan, Sorsogon, Philippines	x	x		x	x	x
S6	DAP1512	<i>Portieria hornemannii</i>	Dapdap, Bulusan, Sorsogon, Philippines		x				
S6	POR003	<i>Portieria hornemannii</i>	Dapdap, Bulusan, Sorsogon, Philippines	x	x			x	x
S6	MAY002	<i>Portieria hornemannii</i>	Pasig reef, Maydolong, Eastern Samar, Philippines		x				
S7	DAP1477	<i>Portieria hornemannii</i>	Dancalan, Bulusan, Sorsogon, Philippines	x	x	x	x	x	x
S7	DAP1478	<i>Portieria hornemannii</i>	Dancalan, Bulusan, Sorsogon, Philippines		x		x		
S7	DAP1481	<i>Portieria hornemannii</i>	Dancalan, Bulusan, Sorsogon, Philippines	x	x	x	x	x	x
S7	DAP1485	<i>Portieria hornemannii</i>	Dancalan, Bulusan, Sorsogon, Philippines	x	x	x	x	x	x
S7	DAP1488	<i>Portieria hornemannii</i>	Dancalan, Bulusan, Sorsogon, Philippines		x				
S7	DAP1489	<i>Portieria hornemannii</i>	Dancalan, Bulusan, Sorsogon, Philippines		x				
S7	POR002	<i>Portieria hornemannii</i>	Dancalan, Bulusan, Sorsogon, Philippines	x	x			x	x
SP3	SCS105	<i>Portieria hornemannii</i>	Spratley Islands	x	x		x	x	x
SP3	SCS109	<i>Portieria hornemannii</i>	Spratley Islands	x	x			x	x
V1A	DAP108	<i>Portieria hornemannii</i>	Bukabok, Tambisan, San Juan, Siquijor, Philippines		x		x		x
V1A	DAP102	<i>Portieria hornemannii</i>	Dapdap, Siquijor, Siquijor, Philippines		x				x
V1A	DAP103	<i>Portieria hornemannii</i>	Dapdap, Siquijor, Siquijor, Philippines		x		x		x
V1A	DAP104	<i>Portieria hornemannii</i>	Dapdap, Siquijor, Siquijor, Philippines		x				x
V1A	DAP210	<i>Portieria hornemannii</i>	Dapdap, Siquijor, Siquijor, Philippines		x		x		x
V1A	DAP213	<i>Portieria hornemannii</i>	Dapdap, Siquijor, Siquijor, Philippines		x	x	x	x	x
V1A	DAP214	<i>Portieria hornemannii</i>	Dapdap, Siquijor, Siquijor, Philippines		x		x		x
V1A	DAP439	<i>Portieria hornemannii</i>	Dapdap, Siquijor, Siquijor, Philippines		x		x		x
V1A	DAP442	<i>Portieria hornemannii</i>	Dapdap, Siquijor, Siquijor, Philippines		x				x
V1A	DAP445	<i>Portieria hornemannii</i>	Dapdap, Siquijor, Siquijor, Philippines		x		x		x
V1A	DAP450	<i>Portieria hornemannii</i>	Dapdap, Siquijor, Siquijor, Philippines		x				x
V1A	DAP058	<i>Portieria hornemannii</i>	Malo, Siaton, Philippines		x	x	x	x	x
V1A	DAP070	<i>Portieria hornemannii</i>	Malo, Siaton, Philippines		x		x		x
V1A	DAPSTN1	<i>Portieria hornemannii</i>	Malo, Siaton, Philippines		x				
V1B	DAP247	<i>Portieria hornemannii</i>	Bantayan, Dumaguete, Philippines		x		x		x
V1B	DAP248	<i>Portieria hornemannii</i>	Bantayan, Dumaguete, Philippines		x		x		x
V1B	DAP249	<i>Portieria hornemannii</i>	Bantayan, Dumaguete, Philippines		x		x		x
V1B	DAP250	<i>Portieria hornemannii</i>	Bantayan, Dumaguete, Philippines		x	x	x	x	x
V1B	DAP251	<i>Portieria hornemannii</i>	Bantayan, Dumaguete, Philippines		x		x		x
V1B	DAP087	<i>Portieria hornemannii</i>	Silliman Beach, Bantayan, Dumaguete City, Philippines		x				x
V1B	DAP088	<i>Portieria hornemannii</i>	Silliman Beach, Bantayan, Dumaguete City, Philippines		x				x
V1C	DAP167	<i>Portieria hornemannii</i>	Daang Lungsod, Alcoy, Cebu, Philippines		x	x	x		x
V1C	DAP168	<i>Portieria hornemannii</i>	Daang Lungsod, Alcoy, Cebu, Philippines		x	x	x	x	x
V1C	DAP170	<i>Portieria hornemannii</i>	Daang Lungsod, Alcoy, Cebu, Philippines		x		x		x

Table S4.1. Continued.

Species	Voucher	Field ID	Location	cox1	cox23	EF2_1	EF2_3	rbc L	rbc L-sp
V1C	DAP171	<i>Portieria hornemannii</i>	Daang Lungsod, Alcoy, Cebu, Philippines		x		x		x
V1C	DAP185	<i>Portieria hornemannii</i>	Daang Lungsod, Alcoy, Cebu, Philippines		x		x		x
V1C	DAP186	<i>Portieria hornemannii</i>	Daang Lungsod, Alcoy, Cebu, Philippines		x		x		x
V1C	DAP211	<i>Portieria hornemannii</i>	Dapdap, Siquijor, Siquijor, Philippines		x				x
V1E	PAL001	<i>Portieria hornemannii</i>	Palompon, Leyte, Philippines		x				
V1E	PAL002	<i>Portieria hornemannii</i>	Palompon, Leyte, Philippines		x				
V1E	DAP144	<i>Portieria hornemannii</i>	Tolingon, Isabel, Leyte, Philippines		x				
V1E	DAP145	<i>Portieria hornemannii</i>	Tolingon, Isabel, Leyte, Philippines		x				x
V1E	DAP146	<i>Portieria hornemannii</i>	Tolingon, Isabel, Leyte, Philippines		x				
V1E	DAP148	<i>Portieria hornemannii</i>	Tolingon, Isabel, Leyte, Philippines		x				x
V1E	DAP151	<i>Portieria hornemannii</i>	Tolingon, Isabel, Leyte, Philippines		x		x		x
V1E	DAP152	<i>Portieria hornemannii</i>	Tolingon, Isabel, Leyte, Philippines		x		x		x
V1E	DAP153	<i>Portieria hornemannii</i>	Tolingon, Isabel, Leyte, Philippines		x		x		x
V1E	DAP154	<i>Portieria hornemannii</i>	Tolingon, Isabel, Leyte, Philippines		x	x	x	x	x
V1E	DAP155	<i>Portieria hornemannii</i>	Tolingon, Isabel, Leyte, Philippines		x				x
V1E	DAP156	<i>Portieria hornemannii</i>	Tolingon, Isabel, Leyte, Philippines		x	x	x	x	x
V26	DAP184	<i>Portieria hornemannii</i>	Daang Lungsod, Alcoy, Cebu, Philippines		x			x	
V26	DAP052	<i>Portieria hornemannii</i>	Malo,Siaton, Philippines		x	x	x	x	x
V26	DAP054	<i>Portieria hornemannii</i>	Malo,Siaton, Philippines		x	x	x	x	x
V26	DAP055	<i>Portieria hornemannii</i>	Malo,Siaton, Philippines		x	x	x		x
V26	DAPSTN2	<i>Portieria hornemannii</i>	Malo,Siaton, Philippines		x				
V27	DAP187	<i>Portieria hornemannii</i>	Apo, Dauin, Negros Oriental, Philippines		x			x	
V27	DAP188	<i>Portieria hornemannii</i>	Apo, Dauin, Negros Oriental, Philippines		x	x	x	x	
V27	DAP189	<i>Portieria hornemannii</i>	Apo, Dauin, Negros Oriental, Philippines		x				x
V27	DAP190	<i>Portieria hornemannii</i>	Apo, Dauin, Negros Oriental, Philippines		x	x	x	x	x
V27	DAP191	<i>Portieria hornemannii</i>	Apo, Dauin, Negros Oriental, Philippines		x	x	x	x	x
V27	DAP468	<i>Portieria hornemannii</i>	Paliton, Siquijor, Philippines		x				x
V31	DAP286	<i>Portieria hornemannii</i>	Pasig reef, Maydolong, Eastern Samar, Philippines		x	x	x	x	x
V31	DAP288	<i>Portieria hornemannii</i>	Pasig reef, Maydolong, Eastern Samar, Philippines		x	x	x	x	x
V31	DAP291	<i>Portieria hornemannii</i>	Pasig reef, Maydolong, Eastern Samar, Philippines		x				
V31	DAP293	<i>Portieria hornemannii</i>	Pasig reef, Maydolong, Eastern Samar, Philippines		x				x
V31	DAP294	<i>Portieria hornemannii</i>	Pasig reef, Maydolong, Eastern Samar, Philippines		x				x
V31	DAP295	<i>Portieria hornemannii</i>	Pasig reef, Maydolong, Eastern Samar, Philippines		x				
V31	DAP296	<i>Portieria hornemannii</i>	Pasig reef, Maydolong, Eastern Samar, Philippines		x				
V31	MAY001	<i>Portieria hornemannii</i>	Pasig reef, Maydolong, Eastern Samar, Philippines		x				
V31	MAY003	<i>Portieria hornemannii</i>	Pasig reef, Maydolong, Eastern Samar, Philippines		x				
V31	MAY004	<i>Portieria hornemannii</i>	Pasig reef, Maydolong, Eastern Samar, Philippines		x				
V31	MAY006	<i>Portieria hornemannii</i>	Pasig reef, Maydolong, Eastern Samar, Philippines		x				
V31	MAY007	<i>Portieria hornemannii</i>	Pasig reef, Maydolong, Eastern Samar, Philippines		x				
V31	MAY008	<i>Portieria hornemannii</i>	Pasig reef, Maydolong, Eastern Samar, Philippines		x				
V31	MAY009	<i>Portieria hornemannii</i>	Pasig reef, Maydolong, Eastern Samar, Philippines		x				
V31	MAY010	<i>Portieria hornemannii</i>	Pasig reef, Maydolong, Eastern Samar, Philippines		x				
V31	MAY013	<i>Portieria hornemannii</i>	Pasig reef, Maydolong, Eastern Samar, Philippines		x				
V31	MAY014	<i>Portieria hornemannii</i>	Pasig reef, Maydolong, Eastern Samar, Philippines		x				
V31	MAY015	<i>Portieria hornemannii</i>	Pasig reef, Maydolong, Eastern Samar, Philippines		x				
V31	MAY016	<i>Portieria hornemannii</i>	Pasig reef, Maydolong, Eastern Samar, Philippines		x				
V31	MAY017	<i>Portieria hornemannii</i>	Pasig reef, Maydolong, Eastern Samar, Philippines		x				
V31	MAY018	<i>Portieria hornemannii</i>	Pasig reef, Maydolong, Eastern Samar, Philippines		x				
V31	MAY019	<i>Portieria hornemannii</i>	Pasig reef, Maydolong, Eastern Samar, Philippines		x				
V32	GUI001	<i>Portieria hornemannii</i>	Binuthan, Guiuan, Eastern Samar, Philippines		x				

Table S4.1. Continued.

Species	Voucher	Field ID	Location	cox 1	cox 23	EF2_1	EF2_3	rbc L	rbc L-sp
V32	GUI002	<i>Portieria hornemannii</i>	Binuthan, Guiuan, Eastern Samar, Philippines		x				
V32	GUI003	<i>Portieria hornemannii</i>	Binuthan, Guiuan, Eastern Samar, Philippines		x				
V32	GUI005	<i>Portieria hornemannii</i>	Binuthan, Guiuan, Eastern Samar, Philippines		x				
V32	GUI006	<i>Portieria hornemannii</i>	Binuthan, Guiuan, Eastern Samar, Philippines		x				
V32	GUI007	<i>Portieria hornemannii</i>	Binuthan, Guiuan, Eastern Samar, Philippines		x				
V32	GUI008	<i>Portieria hornemannii</i>	Binuthan, Guiuan, Eastern Samar, Philippines		x				
V32	GUI009	<i>Portieria hornemannii</i>	Binuthan, Guiuan, Eastern Samar, Philippines		x				
V32	GUI011	<i>Portieria hornemannii</i>	Binuthan, Guiuan, Eastern Samar, Philippines		x				
V32	GUI014	<i>Portieria hornemannii</i>	Binuthan, Guiuan, Eastern Samar, Philippines		x				
V32	GUI018	<i>Portieria hornemannii</i>	Binuthan, Guiuan, Eastern Samar, Philippines		x				
V32	CAM001	<i>Portieria hornemannii</i>	Camiguin Island, Philippines		x				
V32	DAP1388	<i>Portieria hornemannii</i>	Liloan, Santander, Cebu, Philippines		x				
V32	DAP1389	<i>Portieria hornemannii</i>	Liloan, Santander, Cebu, Philippines		x				
V32	DAP1390	<i>Portieria hornemannii</i>	Liloan, Santander, Cebu, Philippines		x				
V32	DAP1391	<i>Portieria hornemannii</i>	Liloan, Santander, Cebu, Philippines		x				
V32	DAP1392	<i>Portieria hornemannii</i>	Liloan, Santander, Cebu, Philippines		x				
V32	DAP1393a	<i>Portieria hornemannii</i>	Liloan, Santander, Cebu, Philippines		x				
V32	DAP1394a	<i>Portieria hornemannii</i>	Liloan, Santander, Cebu, Philippines		x				
V32	DAP1338	<i>Portieria hornemannii</i>	Pagubagubaaan Reef, San Juan, Siquijor, Philippines		x				x
V32	DAP1342	<i>Portieria hornemannii</i>	Pagubagubaaan Reef, San Juan, Siquijor, Philippines	x	x	x	x		x
V32	DAP1346	<i>Portieria hornemannii</i>	Pagubagubaaan Reef, San Juan, Siquijor, Philippines		x				x
V32	DAP1351	<i>Portieria hornemannii</i>	Pagubagubaaan Reef, San Juan, Siquijor, Philippines		x	x	x		
V32	DAP1352	<i>Portieria hornemannii</i>	Pagubagubaaan Reef, San Juan, Siquijor, Philippines		x				x
V32	DAP455	<i>Portieria hornemannii</i>	Paliton, Siquijor, Philippines		x				
V32	DAP202	<i>Portieria hornemannii</i>	Saw ang Reef, San Juan, Siquijor, Philippines	x	x	x	x	x	x
V32	DAP204	<i>Portieria hornemannii</i>	Saw ang Reef, San Juan, Siquijor, Philippines	x	x	x	x	x	x
V32	DAP480	<i>Portieria hornemannii</i>	Saw ang Reef, San Juan, Siquijor, Philippines		x				x
V32	DAP482	<i>Portieria hornemannii</i>	Saw ang Reef, San Juan, Siquijor, Philippines		x				x
V32	DAP533	<i>Portieria hornemannii</i>	Saw ang Reef, San Juan, Siquijor, Philippines		x				x
V32	DAP544	<i>Portieria hornemannii</i>	Saw ang Reef, San Juan, Siquijor, Philippines		x				
og	DML30919	<i>Ochtodes secundiramea</i>	Rocher du Diamant, Martinique	x	x	x	x		x

Table S4.2. Amplified genes, primer sequences and pcr conditions used.

Genomic compartment	Target	Primer name	Primer sequence (5'–3')	Reference	PCR program	
Mitochondria	cox 2-3 spacer	cox2F	GTACCWCTCTTDRGRRKDAATGTGATGC	Zuccarello 1999	one cycle of 4 min at 94 °C; five cycles of 1 min at 93 °C, 1 min at 45 °C and 1 min at 72 °C, 30 cycles of 30s at 93 °C, 30s at 50 °C and 30s at 72 °C and a final cycle of 5 min at 72 °C	
		cox3R	GGATCTACWAGATGRAAWGGATGTC	Zuccarello 1999		
	cox 1	GazF1	TCAACAAATCATAAGATATTGG	Saunders 2005		
		GazR1	ACTTCTGGATGTCCAAAAAYCA	Saunders 2005		
Chloroplast	rbc L+spacer	F993F	GGTACTGTTGTAGTAAATTAGAAGG	Freshwater and Rueness 1994	one cycle of 3 min at 94 °C, 35 cycles of 1 min at 94 °C, 1 min at 46 °C and 1.5 min at 72 °C and a final cycle of 10 min at 72 °C	
		F993nF	TTCCGTCGTTATTGTAAATGG	This study		
		rbc3R	TGTGTTGCGGCCCTTGTTAGTCTCA	Freshwater and Rueness 1994		
	rbc L	F8	GGTGAATCCATACGCTA AAATG	Wang et al., 2000; Wilkes et al., 2005		one cycle of 3 min at 94 °C; 35 cycles of 1 min at 94 °C, 1 min at 46 °C and 1.5 min at 72 °C and a final cycle of 10 min at 72 °C
		F481	GTAGAACGTGAGCGTATGGA			
		F765	TGAAAGAGCTGAATTYGCTAA			
		R1381	ATCTTCCATAAATCTAAAGC			
		F481n	GTAGAACGTGAGCGIATGGA			
Nucleus	EF2	L3L12F	CGY ACN CTB CTB ATG ATG GG	Le Gall 2007	one cycle of 4 min at 94 °C, 38 cycles at 94 °C for 4 min, 38 cycles of 1 min at 94 °C, 1 min at 50 °C, 2 min at 72 °C, and a final cycle of 7 min at 72 °C. PCR success improved at an annealing of 55 °C	
		R2R	GGR CCR AAR CAC CAG ATC TT	Le Gall 2007		
		518F	CGC ACC CTT CTC ATG ATG GG	This study		
		722R	GGTCACTGGGGTTCCTCGGGTTC	This study		
		1046R	ATCACGAGGAGTGACCTTGC	This study		

Table S4.3. Graphical representation of the concatenated alignment, showing the availability of sequence data for the 51 *Portieria* species and outgroup. The colours of column and row headers indicate the amount of data available for that column or row. Green indicates high data availability, red indicates low data availability and yellow/orange represents intermediate data availability.

	EF1st.fas	EF3rd.fas	cox1.fas	cox23.fas	rbcL.fas	rbcLsp.fas
<i>Ochtodes</i> sp. (outgroup)	RDDMTQ strain: DML30919 length: 459 nt	RDDMTQ strain: DML30919 length: 528 nt	RDDMTQ strain: DML30919 length: 626 nt	RDDMTQ strain: DML30919 length: 310 nt		RDDMTQ strain: DML30919 length: 527 nt
<i>Portieria</i> sp. 02				DAPBUL strain: DAP1501 length: 281 nt		
<i>Portieria</i> sp. 04			BERSRI strain: HEC11802 length: 584 nt	BERSRI strain: HEC11802 length: 307 nt	BERSRI strain: HEC11802 length: 1029 nt	BERSRI strain: HEC11802 length: 524 nt
<i>Portieria</i> sp. 09			BERIND strain: BER16 length: 628 nt	BERIND strain: BER17 length: 309 nt	BERIND strain: BER17 length: 1029 nt	BERIND strain: BER17 length: 538 nt
<i>Portieria</i> sp. 10				MADPNG strain: HEC6584 length: 309 nt		MADPNG strain: HEC6584 length: 503 nt
<i>Portieria</i> sp. 11			ZANTAN strain: HEC12085 length: 627 nt	ZANTAN strain: HEC12085 length: 311 nt	ZANTAN strain: HEC12085 length: 1029 nt	ZANTAN strain: HEC12085 length: 538 nt
<i>Portieria</i> sp. 12				BORTAN strain: HEC12155 length: 300 nt	BORTAN strain: HEC12155 length: 1029 nt	BORTAN strain: HEC12115 length: 501 nt
<i>Portieria</i> sp. 13				LAIPNG strain: HEC4280 length: 307 nt	LAIPNG strain: HEC4280 length: 994 nt	PIGPNG strain: HEC13421B length: 515 nt
<i>Portieria</i> sp. 14			ARRAUS strain: HEC12499 length: 628 nt	ARRAUS strain: HEC12499 length: 305 nt	ARRAUS strain: HEC12499 length: 1029 nt	ARRAUS strain: HEC12499 length: 522 nt
<i>Portieria</i> sp. 15			KEPAUS strain: POR004 length: 628 nt	KEPAUS strain: POR004 length: 304 nt		KEPAUS strain: POR004 length: 538 nt
<i>Portieria</i> sp. 16		KZNSAF strain: ODC1160 length: 486 nt	KZNSAF strain: ODC1160 length: 628 nt	KZNSAF strain: ODC1160 length: 307 nt	KZNSAF strain: ODC1160 length: 1029 nt	KZNSAF strain: ODC1160 length: 529 nt
<i>Portieria</i> sp. 17		ISPSAF strain: KZN2310 length: 495 nt	ISPSAF strain: KZN2310 length: 628 nt	ISPSAF strain: KZN2310 length: 308 nt	ISPSAF strain: KZN2310 length: 1029 nt	PLMSAF strain: KZN852 length: 537 nt
<i>Portieria</i> sp. 18			KENYA strain: ODC1609 length: 628 nt	DIAKEN strain: HEC8490 length: 310 nt	SOCYEM strain: SOC154 length: 1029 nt	MASOMN strain: MAS5050 length: 538 nt
<i>Portieria</i> sp. 19			KZNSAF strain: KZN24 length: 628 nt	KZNSAF strain: KZN24 length: 307 nt	KZNSAF strain: KZNBPhor length: 1029 nt	KZNSAF strain: KZN24 length: 519 nt
<i>Portieria</i> sp. 20		KENYA strain: ODC1592 length: 486 nt	KENYA strain: ODC1589 length: 628 nt	KENYA strain: ODC1589 length: 306 nt	KENYA strain: ODC1596 length: 1027 nt	KENYA strain: ODC1596 length: 538 nt
<i>Portieria</i> sp. 22		KENYA strain: ODC1590 length: 490 nt	KENYA strain: ODC1591 length: 626 nt	ZANTAN strain: HEC12055 length: 307 nt	KENYA strain: ODC1590 length: 1026 nt	KENYA strain: ODC1590 length: 538 nt
<i>Portieria</i> sp. 23				KENYA strain: ODC1665 length: 307 nt		KENYA strain: ODC1665 length: 538 nt
<i>Portieria</i> sp. 24				BERSRI strain: HEC16081 length: 308 nt	BERSRI strain: HEC16081 length: 1026 nt	BERSRI strain: HEC16081 length: 532 nt
<i>Portieria</i> sp. 25			MOTPNG strain: HEC10175 length: 626 nt	MOTPNG strain: HEC10175 length: 306 nt		MOTPNG strain: HEC10175 length: 533 nt
<i>Portieria</i> sp. 28			MALDVS strain: HEC12561 length: 628 nt	MALDVS strain: HEC12561 length: 307 nt	MALDVS strain: HEC12561 length: 1029 nt	MALDVS strain: HV1829 length: 542 nt

Table S4.3. Continued.

<i>Partiera</i> sp. 29		WAIHAW strain: HAW001 length: 481 nt	OAHHAW strain: ODC906 length: 628 nt	OAHHAW strain: ODC906 length: 308 nt	OAHHAW strain: ODC906 length: 1029 nt	WAIHAW strain: HAW001 length: 538 nt
<i>Partiera</i> sp. 30			TKWJPN strain: POR001 length: 523 nt	TKWJPN strain: POR001 length: 307 nt	TKWJPN strain: POR001 length: 952 nt	TKWJPN strain: POR001 length: 533 nt
<i>Partiera</i> sp. 37	PSGMAY strain: DAP290 length: 479 nt		PSGMAY strain: DAP290 length: 624 nt	PSGMAY strain: DAP297 length: 306 nt		PSGMAY strain: DAP290 length: 540 nt
<i>Partiera</i> sp. 38	CORBAS strain: DAP1427 length: 316 nt		CORBAS strain: DAP1427 length: 633 nt	CORBAS strain: DAP1427 length: 256 nt	CORBAS strain: DAP1427 length: 797 nt	CORBAS strain: DAP1427 length: 533 nt
<i>Partiera</i> sp. 42		SOUTAI strain: TAI04B length: 480 nt		SOUTAI strain: TAI04B length: 296 nt		
<i>Partiera</i> sp. 43			BINGUI strain: G013 length: 639 nt	BINGUI strain: GUI019 length: 317 nt		
<i>Partiera</i> sp. 44	NORTAI strain: TAI01A length: 532 nt	NORTAI strain: TAI01A length: 588 nt	NORTAI strain: TAI02A length: 620 nt	NORTAI strain: TAI04A length: 293 nt	NORTAI strain: TAI01A length: 1039 nt	NORTAI strain: TAI02A length: 545 nt
<i>Partiera</i> sp. 45				MANIND strain: BUN003 length: 307 nt		
<i>Partiera</i> sp. 46	SOUTAI strain: TAI02B length: 521 nt	SOUTAI strain: TAI03B length: 608 nt	SOUTAI strain: TAI03B length: 633 nt	SOUTAI strain: TAI01B length: 293 nt		SOUTAI strain: TAI03B length: 541 nt
<i>Partiera</i> sp. 47					NCBI strain: U04215 length: 1020 nt	
<i>Partiera</i> sp. 48					NCBI strain: AF212185 length: 1029 nt	
<i>Partiera</i> sp. B21	PIEMHT strain: DAP1449 length: 485 nt	CHABAS strain: DAP369 length: 549 nt	CHABAS strain: DAP369 length: 628 nt	CHABAS strain: DAP364 length: 307 nt	CHABAS strain: DAP369 length: 1029 nt	CHABAS strain: DAP374 length: 538 nt
<i>Partiera</i> sp. B33	CHABAS strain: DAP366 length: 485 nt	CORBAS strain: DAP1430 length: 535 nt	CHABAS strain: DAP366 length: 626 nt	CHABAS strain: DAP366 length: 309 nt	CHABAS strain: DAP366 length: 1029 nt	CHABAS strain: DAP366 length: 539 nt
<i>Partiera</i> sp. B34	WBCMHT strain: DAP337 length: 482 nt	WBCMHT strain: DAP337 length: 533 nt	WBCMHT strain: DAP337 length: 628 nt	WBCMHT strain: DAP337 length: 306 nt	WBCMHT strain: DAP338 length: 1029 nt	WBCMHT strain: DAP337 length: 538 nt
<i>Partiera</i> sp. B35	CORBAS strain: DAP1421 length: 288 nt	PIEBAS strain: DAP1400 length: 559 nt	CHABAS strain: DAP371 length: 628 nt	CHABAS strain: DAP372 length: 307 nt	WBCMHT strain: DAP340 length: 1029 nt	WBCMHT strain: DAP341 length: 538 nt
<i>Partiera</i> sp. B5	WBCMHT strain: DAP333 length: 482 nt	WBCMHT strain: DAP1436 length: 550 nt	WBCMHT strain: DAP333 length: 628 nt	CHABAS strain: DAP373 length: 308 nt	WBCMHT strain: DAP334 length: 1029 nt	WBCMHT strain: DAP334 length: 538 nt
<i>Partiera</i> sp. B8	PIEBAS strain: DAP1418 length: 234 nt	WBCMHT strain: DAP345 length: 553 nt	WBCMHT strain: DAP336 length: 618 nt	WBCMHT strain: DAP336 length: 317 nt	WBCMHT strain: DAP336 length: 1029 nt	CHASAB strain: DAP1461 length: 539 nt
<i>Partiera</i> sp. S36	DANBUL strain: DAP1490 length: 479 nt	DANBUL strain: DAP1482 length: 554 nt	DANBUL strain: DAP1490 length: 628 nt	DANBUL strain: DAP1487 length: 269 nt	DANBUL strain: DAP1490 length: 858 nt	DANBUL strain: DAP1487 length: 531 nt
<i>Partiera</i> sp. S39		DANBUL strain: DAP1480 length: 548 nt	DANBUL strain: DAP1480 length: 624 nt	DANBUL strain: DAP1492 length: 292 nt		DANBUL strain: DAP1480 length: 541 nt
<i>Partiera</i> sp. S40	DANBUL strain: DAP1473 length: 263 nt	DAPBUL strain: DAP1493 length: 553 nt	DANBUL strain: DAP1473 length: 624 nt	DAPBUL strain: DAP1493 length: 289 nt	DANBUL strain: DAP1473 length: 746 nt	DANBUL strain: DAP1473 length: 540 nt
<i>Partiera</i> sp. S6	DANBUL strain: DAP1484 length: 444 nt	DANBUL strain: DAP1484 length: 553 nt	DAPSOR strain: POR003 length: 628 nt	PSGMAY strain: MAY002 length: 324 nt	DAPSOR strain: POR003 length: 1029 nt	DAPBUL strain: DAP1511 length: 539 nt
<i>Partiera</i> sp. S7	DANBUL strain: DAP1477 length: 294 nt	DANBUL strain: DAP1485 length: 526 nt	DANBUL strain: DAP1481 length: 629 nt	BULSOR strain: POR002 length: 316 nt	BULSOR strain: POR002 length: 1029 nt	DANBUL strain: DAP1485 length: 539 nt
<i>Partiera</i> sp. SP3		SPRSCS strain: SCS105 length: 569 nt	SPRSCS strain: SCS105 length: 614 nt	SPRSCS strain: SCS105 length: 307 nt	SPRSCS strain: SCS105 length: 1029 nt	SPRSCS strain: SCS105 length: 538 nt

Table S4.3. Continued.

<i>Portieria</i> sp. V1A	MALSTN strain: DAP058 length: 479 nt	DAPSIQ strain: DAP213 length: 543 nt		DAPSIQ strain: DAP103 length: 304 nt	DAPSIQ strain: DAP213 length: 1029 nt	DAPSIQ strain: DAP103 length: 537 nt
<i>Portieria</i> sp. V1B	AIRDGT strain: DAP250 length: 471 nt	AIRDGT strain: DAP250 length: 532 nt		BANDGT strain: DAP087 length: 304 nt	AIRDGT strain: DAP250 length: 1029 nt	BANDGT strain: DAP087 length: 537 nt
<i>Portieria</i> sp. V1C	DAAALC strain: DAP168 length: 467 nt	DAAALC strain: DAP168 length: 536 nt		DAAALC strain: DAP185 length: 304 nt	DAAALC strain: DAP168 length: 1029 nt	DAAALC strain: DAP185 length: 537 nt
<i>Portieria</i> sp. V1D		MALPHI strain: HV584 length: 480 nt		MALPHI strain: HV584 length: 304 nt	MALPHI strain: HV584 length: 1029 nt	MALPHI strain: HV584 length: 537 nt
<i>Portieria</i> sp. V1E	TOLISB strain: DAP156 length: 528 nt	TOLISB strain: DAP156 length: 527 nt		PALLEY strain: PAL001 length: 311 nt	TOLISB strain: DAP156 length: 1029 nt	TOLISB strain: DAP154 length: 537 nt
<i>Portieria</i> sp. V26	MALSTN strain: DAP054 length: 482 nt	MALSTN strain: DAP052 length: 530 nt	MALSTN strain: DAP054 length: 627 nt	MALSTN strain: DAP054 length: 307 nt	DAAALC strain: DAP184 length: 1029 nt	MALSTN strain: DAP052 length: 537 nt
<i>Portieria</i> sp. V27	APODAU strain: DAP188 length: 481 nt	APODAU strain: DAP188 length: 527 nt	APODAU strain: DAP191 length: 616 nt	APODAU strain: DAP191 length: 306 nt	APODAU strain: DAP191 length: 1029 nt	PALSIN strain: DAP468 length: 537 nt
<i>Portieria</i> sp. V31	PSGMAY strain: DAP283 length: 496 nt	PSGMAY strain: DAP288 length: 531 nt	PSGMAY strain: DAP283 length: 628 nt	PSGMAY strain: MAV008 length: 325 nt	PSGMAY strain: DAP288 length: 1029 nt	PSGMAY strain: DAP286 length: 521 nt
<i>Portieria</i> sp. V32	SAWSJN strain: DAP204 length: 447 nt	SAWSJN strain: DAP204 length: 523 nt	SAWSJN strain: DAP204 length: 628 nt	BINGUI strain: GUI018 length: 320 nt	SAWSJN strain: DAP202 length: 1029 nt	SAWSJN strain: DAP480 length: 540 nt

Table S4.4. List of calibration points used to date the red algal phylogenetic tree. The nodes to which the age constraints are applied (first column) are indicated on the tree in Fig. S2.

Node Name	Fossil	Period	Age (Ma)	References
<b>a</b>	Rhodophyta crown	interpretation of early eukaryotic diversification	max 1400	(Porter, 2004, Knoll <i>et al.</i> , 2006)
<b>b</b>	Bangiophyceae s.l. crown	<i>Bangiomorpha pubescens</i>	Mesoproterozoic	min 1174 (Butterfield, 2000)
<b>c</b>	Bangiales stem	<i>Palaeoconchocelis starmachii</i>	Upper Silurian	min 419 (Campbell, 1980)
<b>d</b>	Nemaliales stem	<i>Gymnocodium</i>	Asselian	min 294.6 (Mamet & Zhu, 2005)
<b>e</b>	Corallinophycidae stem	<i>Arenigiphylum</i> & <i>Halysis</i>	Arenig	min 471.8 (Riding <i>et al.</i> , 1998, Riding & Braga, 2005)
<b>f</b>	Sporolithaceae stem	<i>Archaeolithothamnion rude</i>	Hauterivian	min 130 (Arias <i>et al.</i> , 1995)
<b>g</b>	Corallinaceae stem	various taxa	Upper Jurassic	min 145.5 (Aguirre <i>et al.</i> , 2000)
<b>h</b>	Peyssonneliaceae stem	no name given	Hauterivian	min 130 (Aguirre <i>et al.</i> , 2000)





## 4.9 References

- Aguirre, J., Riding, R. & Braga, J. C. 2000. Diversity of coralline red algae: origination and extinction patterns from the Early Cretaceous to the Pleistocene. *Paleobiology* **26**:651-67.
- Alfaro, M. E., Santini, F. & Brock, C. D. 2007. Do reefs drive diversification in marine teleosts? Evidence from the pufferfish and their allies (order Tetraodontiformes). *Evolution* **61**:2104-26.
- Arias, C., Masse, J. P. & Vilas, L. 1995. Hauterivian shallow marine calcareous biogenic mounds: SE Spain. *Palaeogeogr. Palaeoclimatol. Palaeoecol.* **119**:3-17.
- Barber, P. H. 2009. The challenge of understanding the Coral Triangle biodiversity hotspot. *J. Biogeogr.* **36**:1845-46.
- Barber, P. H. & Bellwood, D. R. 2005. Biodiversity hotspots: evolutionary origins of biodiversity in wrasses (*Halichoeres*: Labridae) in the Indo-Pacific and new world tropics. *Mol. Phylogenet. Evol.* **35**:235-53.
- Barber, P. H., Erdmann, M. V. & Palumbi, S. R. 2006. Comparative phylogeography of three codistributed stomatopods: Origins and timing of regional lineage diversification in the coral triangle. *Evolution* **60**:1825-39.
- Bellwood, D. R., Herwerden, L. v. & Konow, N. 2004. Evolution and biogeography of marine angelfishes (Pisces: Pomacanthidae). *Mol. Phylogenet. Evol.* **33**:140-55.
- Bellwood, D. R. & Hughes, T. P. 2001. Regional-scale assembly rules and biodiversity of coral reefs. *Science* **292**:1532-35.
- Bellwood, D. R. & Meyer, C. P. 2009a. Endemism and evolution in the Coral Triangle: a call for clarity. *J. Biogeogr.* **36**:2011-12.
- Bellwood, D. R. & Meyer, C. P. 2009b. Searching for heat in a marine biodiversity hotspot. *J. Biogeogr.* **36**:569-76.
- Bickford, D., Lohman, D. J., Sodhi, N. S., Ng, P. K. L., Meier, R., Winker, K., Ingram, K. K. & Das, I. 2007. Cryptic species as a window on diversity and conservation. *Trends Ecol. Evol.* **22**:148-55.
- Briggs, J. C. 1999. Coincident biogeographic patterns: Indo-West Pacific Ocean. *Evolution* **53**:326-35.
- Briggs, J. C. 2000. Centrifugal speciation and centers of origin. *J. Biogeogr.* **27**:1183-88.
- Briggs, J. C. 2009. Diversity, endemism and evolution in the Coral Triangle. *J. Biogeogr.* **36**:2009-10.
- Butterfield, N. J. 2000. *Bangiomorpha pubescens* n. gen., n. sp.: Implications for the evolution of sex, multicellularity, and the Mesoproterozoic/Neoproterozoic radiation of eukaryotes. *Paleobiology* **26**:386-404.
- Campbell, S. E. 1980. *Palaeoconchocelis starmachii*, a carbonate boring microfossil from the Upper Silurian of Poland (425 million years old): implications for the evolution of the Bangiaceae (Rhodophyta). *Phycologia* **19**:25-36.
- Carpenter, K. E., Abrar, M., Aeby, G., Aronson, R. B., Banks, S., Bruckner, A., Chiriboga, A., Cortes, J., Delbeck, J. C., DeVantier, L., Edgar, G. J., Edwards, A. J., Fenner, D., Guzman, H. M., Hoeksema, B. W., Hodgson, G., Johan, O., Licuanan, W. Y., Livingstone, S. R., Lovell, E. R., Moore, J. A., Obura, D. O., Ochavillo, D., Polidoro, B. A., Precht, W. F., Quibilan, M. C., Reboton, C., Richards, Z. T., Rogers, A. D., Sanciangco, J., Sheppard, A., Sheppard, C., Smith, J., Stuart, S., Turak, E., Veron, J. E. N., Wallace, C., Weil, E. & Wood, E. 2008. One-third of reef-building corals face elevated extinction risk from climate change and local impacts. *Science* **321**:560-63.
- Carpenter, K. E. & Springer, V. G. 2005. The center of the center of marine shore fish biodiversity: the Philippine Islands. *Environ. Biol. Fishes* **72**:467-80.
- Connolly, S. R., Bellwood, D. R. & Hughes, T. P. 2003. Indo-Pacific biodiversity of coral reefs: Deviations from a mid-domain model. *Ecology* **84**:2178-90.
- Cowie, R. H. & Holland, B. S. 2008. Molecular biogeography and diversification of the endemic terrestrial fauna of the Hawaiian Islands. *Philos. Trans. R. Soc. Lond. B Biol. Sci.* **363**:3363-76.

- Dawson, M. N. & Hamner, W. M. 2005. Rapid evolutionary radiation of marine zooplankton in peripheral environments. *Proc. Natl. Acad. Sci. U.S.A.* **102**:9235-40.
- Destombe, C., Godin, J., Lefebvre, C., Dehorter, O. & Vernet, P. 1992. Differences in dispersal abilities of haploid and diploid spores of *Gracilaria verrucosa* (Gracilariales, Rhodophyta). *Bot. Mar.* **35**:93-98.
- Drew, J., Allen, G. R., Kaufman, L. & Barber, P. H. 2008. Endemism and regional color and genetic differences in five putatively cosmopolitan reef fishes. *Conserv. Biol.* **22**:965-75.
- Drummond, A. J. & Rambaut, A. 2007. BEAST: Bayesian evolutionary analysis by sampling trees. *BMC Evol. Biol.* **7**:214.
- Eble, J. A., Toonen, R. J. & Bowen, B. W. 2009. Endemism and dispersal: comparative phylogeography of three surgeonfishes across the Hawaiian Archipelago. *Mar. Biol.* **156**:689-98.
- Ekman, S. 1953. Zoogeography of the sea. Sidgwick and Jackson, London. XIV, 417 pp.
- Gaston, K. J. 2000. Global patterns in biodiversity. *Nature* **405**:220-27.
- Guindon, S. & Gascuel, O. 2003. A simple, fast, and accurate algorithm to estimate large phylogenies by maximum likelihood. *Syst. Biol.* **52**:696-704.
- Guiry, M. D. & Guiry, G. M. 2010. AlgaeBase. World-wide electronic publication, National University of Ireland, Galway. <http://www.algaebase.org>; searched on 10 December 2010.
- Halas, D. & Winterbottom, R. 2009. A phylogenetic test of multiple proposals for the origins of the East Indies coral reef biota. *J. Biogeogr.* **36**:1847-60.
- Hall, R. 1998. The plate tectonics of Cenozoic SE Asia and the distribution of land and sea. *In*: Hall, R. & Holloway, J. D. [Eds.] Biogeography and geological evolution of SE Asia. Backhuys Publishers, Leiden, pp. 99-131.
- Hall, R. 2002. Cenozoic geological and plate tectonic evolution of SE Asia and the SW Pacific: computer-based reconstructions, model and animations. *J. Asian Earth Sci.* **20**:353-431.
- Harmon, L. J., Weir, J. T., Brock, C. D., Glor, R. E. & Challenger, W. 2008. GEIGER: investigating evolutionary radiations. *Bioinformatics* **24**:129-31.
- Hoeksema, B. 2007. Delineation of the Indo-Malayan center of maximum marine biodiversity: The Coral Triangle. *In*: Renema, W. [Ed.] Biogeography, Time, and Place: Distributions, Barriers, and Islands. Springer Netherlands, pp. 117-78.
- Jokiel, P. & Martinelli, F. J. 1992. The vortex model of coral reef biogeography. *J. Biogeogr.* **19**:449-58.
- Kerswell, A. P. 2006. Global biodiversity patterns of benthic marine algae. *Ecology* **87**:2479-88.
- Kinlan, B. P. & Gaines, S. D. 2003. Propagule dispersal in marine and terrestrial environments: A community perspective. *Ecology* **84**:2007-20.
- Kirkendale, L. A. & Meyer, C. P. 2004. Phylogeography of the *Patelloida profunda* group (Gastropoda: Lottidae): diversification in a dispersal-driven marine system. *Mol. Ecol.* **13**:2749-62.
- Knoll, A. H., Javaux, E. J., Hewitt, D. & Cohen, P. 2006. Eukaryotic organisms in Proterozoic oceans. *Philos. Trans. R. Soc. Lond. B Biol. Sci.* **361**:1023-38.
- Knowlton, N. 1993. Sibling species in the sea. *Annu. Rev. Ecol. Syst.* **24**:189-216.
- Kooistra, W., Sarno, D., Balzano, S., Gu, H. F., Andersen, R. A. & Zingonea, A. 2008. Global diversity and biogeography of *Skeletonema* species (Bacillariophyta). *Protist* **159**:177-93.
- Ladd, H. S. 1960. Origin of the Pacific Island molluscan fauna. *Am. J. Sci.* **258A**:137-50.
- Le Gall, L. & Saunders, G. W. 2010. DNA barcoding is a powerful tool to uncover algal diversity: a case study of the Phyllophoraceae (Gigartinales, Rhodophyta) in the Canadian flora. *J. Phycol.* **46**:374-89.
- Leliaert, F., Verbruggen, H., Wylor, B. & De Clerck, O. 2009. DNA taxonomy in morphologically plastic taxa: Algorithmic species delimitation in the *Boodlea* complex (Chlorophyta: Cladophorales). *Mol. Phylogenet. Evol.* **53**:122-33.
- Lüning, K. 1990. *Seaweeds: their environment, biogeography and ecophysiology*. Wiley-Interscience, New York.
- Mamet, B. & Zhu, Z. 2005. Carboniferous and Permian algal microflora, Tarim Basin (China). *Geol. Belg.* **8**:3-13.

- Malay, M. C. D. & Paulay, G. 2009. Peripatric speciation drives diversification and distributional pattern of reef Hermit Crabs (Decapoda: Diogenidae: *Calcinus*). *Evolution* **64**:634-62.
- Meyer, C. P., Geller, J. B. & Paulay, G. 2005. Fine scale endemism on coral reefs: Archipelagic differentiation in turbinid gastropods. *Evolution* **59**:113-25.
- Monaghan, M. T., Wild, R., Elliot, M., Fujisawa, T., Balke, M., Inward, D. J., Lees, D. C., Ranaivosolo, R., Eggleton, P., Barraclough, T. G. & Vogler, A. P. 2009. Accelerated Species Inventory on Madagascar Using Coalescent-Based Models of Species Delineation. *Syst. Biol.* **58**:298-311.
- Mora, C., Chittaro, P. M., Sale, P. F., Kritzer, J. P. & Ludsins, S. A. 2003. Patterns and processes in reef fish diversity. *Nature* **421**:933-36.
- Palumbi, S. R. 1994. Genetic divergence, reproductive isolation and marine speciation. *Annu. Rev. Ecol. Syst.* **25**:547-72.
- Paradis, E., Claude, J. & Strimmer, K. 2004. APE: analyses of phylogenetics and evolution in R language. *Bioinformatics* **20**:289-90.
- Paulay, G. & Meyer, C. 2002. Diversification in the tropical Pacific: Comparisons between marine and terrestrial systems and the importance of founder speciation. *Integr. Comp. Biol.* **42**:922-34.
- Pons, J., Barraclough, T. G., Gomez-Zurita, J., Cardoso, A., Duran, D. P., Hazell, S., Kamoun, S., Sumlin, W. D. & Vogler, A. P. 2006. Sequence-based species delimitation for the DNA taxonomy of undescribed insects. *Syst. Biol.* **55**:595-609.
- Porter, S. M. 2004. The fossil record of early eukaryotic diversification. *In: Lipps, J. H. & Waggoner, B. [Eds.] The Paleontological Society Papers 10: Neoproterozoic-Cambrian Biological Revolutions.* Paleontological Society, New Haven, pp. 35-50.
- R\_Development\_Core\_Team 2009. R: A Language and Environment for Statistical Computing
- Rambaut, A. & Drummond, A. 2007a. Tracer v1.4. Available from <http://beast.bio.ed.ac.uk/Tracer> 1.4 ed.
- Rambaut, A. & Drummond, A. J. 2007b. Tracer. 1.4 ed.
- Renema, W., Bellwood, D. R., Braga, J. C., Bromfield, K., Hall, R., Johnson, K. G., Lunt, P., Meyer, C. P., McMonagle, L. B., Morley, R. J., O'Dea, A., Todd, J. A., Wesselingh, F. P., Wilson, M. E. J. & Pandolfi, J. M. 2008. Hopping hotspots: Global shifts in marine Biodiversity. *Science* **321**:654-57.
- Riding, R. & Braga, J. C. 2005. *Halysia* Hoeg, 1932 - An Ordovician coralline red alga? *J. Paleontol.* **79**:835-41.
- Riding, R., Cope, J. C. W. & Taylor, P. D. 1998. A coralline-like red alga from the lower Ordovician of Wales. *Paleontology* **41**:1069-76.
- Ronquist, F. & Huelsenbeck, J. P. 2003. MrBayes 3: Bayesian phylogenetic inference under mixed models. *Bioinformatics* **19**:1572-74.
- Rosen, B. R. & Smith, A. B. 1988. Tectonics from fossils? Analysis of reef coral and sea urchin distributions from late Cretaceous to Recent, using a new method. *In: Audley-Charles, M. G. & Hallam, A. [Eds.] Gondwana and Tethys.* Oxford University Press, Oxford, pp. 275-306.
- Sanderson, M. J. 2002. Estimating absolute rates of molecular evolution and divergence times: a penalized likelihood approach. *Mol. Biol. Evol.* **19**:101-09.
- Santini, F. & Winterbottom, R. 2002. Historical biogeography of Indo-western Pacific coral reef biota: is the Indonesian region a center of origin? *J. Biogeogr.* **29**:189-205.
- Sarnat, E. M. & Moreau, C. S. 2011. Biogeography and morphological evolution in a Pacific island ant radiation. *Mol. Ecol.* **20**:114-30.
- Saunders, G. W. 2005. Applying DNA barcoding to red macroalgae: a preliminary appraisal holds promise for future applications. *Philos. Trans. R. Soc. Lond. B Biol. Sci.* **360**:1879-88.
- Saunders, G. W. 2008. A DNA barcode examination of the red algal family Dumontiaceae in Canadian waters reveals substantial cryptic species diversity. 1. The foliose *Dilsea-Neodilsea* complex and *Weeksia*. *Botany-Botanique* **86**:773-89.
- Shanks, A. L., Grantham, B. A. & Carr, M. H. 2003. Propagule dispersal distance and the size and spacing of marine reserves. *Ecol. Appl.* **13**:S159-S69.

- Sobel, J. M., Chen, G. F., Watt, L. R. & Schemske, D. W. 2010. The biology of speciation. *Evolution* **64**:295-315.
- Stamatakis, A., Hoover, P. & Rougemont, J. 2008. A rapid bootstrap algorithm for the RAxML web servers. *Syst. Biol.* **57**:758-71.
- Tittensor, D. P., Mora, C., Jetz, W., Lotze, H. K., Ricard, D., Berghe, E. V. & Worm, B. 2010. Global patterns and predictors of marine biodiversity across taxa. *Nature* **466**:1098-101.
- Tronholm, A., Sanson, M., Afonso-Carrillo, J., Verbruggen, H. & de Clerck, O. 2010. Niche partitioning and the coexistence of two cryptic *Dictyota* (Dictyotales, Phaeophyceae) species from the Canary Islands. *J. Phycol.* **46**:1075-87.
- Verbruggen, H., De Clerck, O., Schils, T., Kooistra, W. & Coppejans, E. 2005. Evolution and phylogeography of *Halimeda* section *Halimeda* (Bryopsidales, Chlorophyta). *Mol. Phylogenet. Evol.* **37**:789-803.
- Verbruggen, H., Leliaert, F., Maggs, C. A., Shimada, S., Schils, T., Provan, J., Booth, D., Murphy, S., De Clerck, O., Littler, D. S., Littler, M. M. & Coppejans, E. 2007. Species boundaries and phylogenetic relationships within the green algal genus *Codium* (Bryopsidales) based on plastid DNA sequences. *Mol. Phylogenet. Evol.* **44**:240-54.
- Verbruggen, H., Maggs, C., Saunders, G., Le Gall, L., Yoon, H. & De Clerck, O. 2010. Data mining approach identifies research priorities and data requirements for resolving the red algal tree of life. *BMC Evol. Biol.* **10**:16.
- Verbruggen, H., Vlaeminck, C., Sauvage, T., Sherwood, A. R., Leliaert, F. & De Clerck, O. 2009. Phylogenetic analysis of *Pseudochlorodesmis* strains reveals cryptic diversity above the family level in the siphonous green algae (Bryopsidales, Chlorophyta). *J. Phycol.* **45**:726-31.
- Williams, S. T. 2007. Origins and diversification of Indo-West Pacific marine fauna: evolutionary history and biogeography of turban shells (Gastropoda, Turbinidae). *Biol. J. Linn. Soc.* **92**:573-92.
- Williams, S. T. & Duda, T. F. 2008. Did tectonic activity stimulate Oligo-Miocene speciation in the Indo-West Pacific? *Evolution* **62**:1618-34.
- Williams, S. T. & Reid, D. G. 2004. Speciation and diversity on tropical rocky shores: A global phylogeny of snails of the genus *Echinolittorina*. *Evolution* **58**:2227-51.
- Wilson, M. E. J. & Rosen, B. R. 1998. Implications of paucity of corals in the Paleogene of SE Asia: plate tectonics or center of origin? *In*: Hall, R. & Holloway, J. D. [Eds.] *Biogeography and geological evolution of SE Asia*. Backhuys Publishers, Leiden, pp. 165-95.
- Wiseman, D. R. 1975. On the status of the red algal family, the Rhizophyllidaceae (Gigartinales). *Taxon* **24**:489-90.
- Woodland, D. J. 1983. Zoogeography of the Siganidae (Pisces): An interpretation of distribution and richness patterns. *Bull. Mar. Sci.* **33**:713-17.
- Worheide, G., Epp, L. & Macis, L. 2008. Deep genetic divergences among Indo-Pacific populations of the coral reef sponge *Leucetta chagosensis* (Leucettidae): Founder effects, vicariance, or both? *BMC Evol. Biol.* **8**:24.
- Xavier, J. R., Rachello-Dolmen, P. G., Parra-Velandia, F., Schönberg, C. H. L., Breeuwer, J. A. J. & van Soest, R. W. M. 2010. Molecular evidence of cryptic speciation in the "cosmopolitan" excavating sponge *Cliona celata* (Porifera, Clionidae). *Mol. Phylogenet. Evol.* **56**:13-20.
- Zuccarello, G. C. & West, J. A. 2002. Phylogeography of the *Bostrychia calliptera*-*B. pinnata* complex (Rhodomelaceae, Rhodophyta) and divergence rates based on nuclear, mitochondrial and plastid DNA markers. *Phycologia* **41**:49-60.
- Zuccarello, G. C. & West, J. A. 2003. Multiple cryptic species: Molecular diversity and reproductive isolation in the *Bostrychia radicans*/*B. moritziana* complex (Rhodomelaceae, Rhodophyta) with focus on North American isolates. *J. Phycol.* **39**:948-59.

# 5 MORPHOMETRIC CHARACTERIZATION OF THE *PORTIERIA*-COMPLEX IN THE PHILIPPINES<sup>1</sup>

---

## Abstract

Molecular systematic studies have recently shown that the red alga *Portieria bornemannii* consists of multiple species, which, at first sight, fall within a morphological continuum. These findings raise the question whether the diversification of this species complex coincided with morphological differentiation. We applied different morphometric techniques, including discriminant function analyses of fractal parameters, non-conventional and conventional measurements of branch apices, to detect patterns of morphological differentiation between species. Results show that conventional measurements outperform those of fractal and non-conventional variables in the discrimination of lineages. A combination of these variable types resulted in the best discriminatory power. Fractal analyses resulted in low to moderate classification success (21-71%) of branch apices into the correct lineage grouping. Classification success was higher for conventional measurements (70-100%). When combined, fractal variables and conventional measurements resulted in high to very high classification success (83-100 %). These results indicate that although it may not be possible to assign each individual specimen to the correct lineage, the different lineages are, at least to some degree, morphologically differentiated.

*Keywords:* *Portieria*; Rhizophyllidaceae; Phylogeny; Morphometrics, Fractal dimension, FraCLac, Discriminant Analysis

<sup>1</sup> Unpublished manuscript: Payo D.A., Colo J., Leliaert F., Calumpong H. & De Clerck O. Morphometric characterization of the *Portieria*-complex (Gigartinales: Rhizophyllidaceae) in the Philippines.

## 5.1 Introduction

Traditional descriptions of macroalgal species usually include a characterization of the overall thallus morphology combined with details of anatomical structures and measurements of specific structures. This approach, however, largely fails to detect subtle differences that may exist between species with highly similar morphologies (i.e., cryptic or pseudocryptic species). Morphometric analysis, the mathematical investigation of shape, allows a more detailed and statistically sound evaluation of possible morphological differentiation between (pseudo)cryptic species (Verbruggen et al., 2005a). Conventional morphometric techniques include measurements of morphological and anatomical structures, which can be analyzed using multivariate statistical tools to detect patterns of morphological differentiation between species. Such an approach nowadays relies heavily on molecular data, whereby species are first delineated using gene sequence data and subsequently the morphology is studied in an attempt to discover diagnostic characters. Morphometric techniques are increasingly used in macroalgal studies to test congruence between morphological and phylogenetic species concepts (Sherwood and Sheath, 1999, 2000; Kraan et al., 2001; Hubbard and Garbary, 2002; Sherwood and Sheath, 2003; Yano et al., 2004; Verbruggen et al., 2005b; Yano et al., 2006; Leliaert et al., 2007; Tronholm et al., 2010), to describe seasonal morphological changes (Montañes *et al.*, 2006), and to demonstrate morphological plasticity (Altamirano-Cerecedo and Riosmena-Rodríguez, 2007). In some cases traditional measurements have been complemented by shape and size descriptors such as landmark analysis (Verbruggen *et al.*, 2005a). The latter techniques may provide indications of morphological variation and differentiation that went unnoticed by conventional measurements.

Species boundaries and diversity in the red alga *Portieria* have been difficult to assess based on conventional morphological criteria. Several species have been distinguished, often based on vague and inconsistent morphological bases. A comprehensive study on the morphology and diversity of *Portieria* led Wiseman (1975) to conclude that there was only one, morphologically variable species, *P. hornemannii*. DNA sequence data analysis has recently shown that *P. hornemannii* in fact consists of multiple species that are morphologically highly similar (Chapter 3 and 4). In this study we applied fractal analyses to characterize the morphology of the various species. *Portieria* is a modular organism (i.e. an organism built of repeated units, see Kaandorp and Kübler, 2001), with a complex branching pattern. The thallus consists of a basal holdfast that gives rise to several compressed axes branching alternately up to four to five orders (Fig. 5.1). Fractals refer to self-similar

patterns with non-linear scaling rules (Mandelbrot, 1975; Karperien, 1999-2007). The branching pattern of *Portieria* exhibits a certain degree of self-similarity which lends itself well to being characterized using fractal dimensions (Alados *et al.*, 1999). Fractal dimensions are used to quantify complexity in physical forms or non-physical patterns (temporal or spatial) expressed as a scaling rule based on the number of new self-similar parts produced from the scale applied (Karperien, 1999-2007). Compared to landmark analyses, fractal analyses are less troubled by the requirements of unambiguously defined homologous points. Fractal dimension has been successfully utilized in characterizing biological forms. For example, fractal dimensions have been successfully applied to distinguish coral species (Martin-Garin *et al.*, 2007), to show plasticity of sponges in response to water movement (Abraham, 2001), to demonstrate increasing shape complexity during macroalgal development (Corbit and Garbary, 1995), and to show temperature dependent morphological plasticity in the red seaweed *Chondrus* (Kubler and Dudgeon, 1996). Fractal analyses have also been applied in a variety of other disciplines including medical research (Karperien *et al.*, 2005; Goutzanis *et al.*, 2008). Apart from the macroalgal studies mentioned, the technique has not yet been explored in phycology.

We use both conventional and fractal parameters in an attempt to characterize species within the *Portieria*-complex. Gross morphological observations tend to support the notion of a morphological continuum of forms that are difficult to separate Wiseman (1975). This makes fractal analysis an attractive tool for understanding the patterns of form variation contained within this diversity. We aim to 1.) detect morphological differences between *Portieria* species on the basis of conventional and fractal parameters, and 2) evaluate the taxonomic value of conventional and fractal parameters in detecting and delineating morphotypes that correspond to particular phylogenetic lineages.

## 5.2 Materials and methods

### 5.2.1 Specimen sampling, image preparation and acquisition

*Portieria* samples were collected from intertidal to shallow subtidal sites in the Philippines. The specimens used were collected from five sites (Basco, Chanaryan, Coral, Mahatao, Chavayan) in the northern islands of Batanes and six sites (Dapdap, Siquijor; Sawang, San Juan, Siquijor; Pagubagubaan, San Juan, Siquijor; Malo, Siaton; Bantayan, Dumaguete; Liloan, Santander) in the central

islands of the Visayas, Philippines. See Table 5.1 for a complete listing of the samples.

Table 5.1. List of *Portiera* specimens used in fractal (FA) and conventional morphometric (CM) analyses. DNA sequences of the *cox2-3* gene were also obtained from the samples. The symbol (\*) indicates presence of data or availability of a sequence.

Specimen	Clade	Site	FA	CM	DNA
DAP058	V1	Malo, Siaton, Philippines	*		*
DAP070	V1	Malo, Siaton, Philippines	*		*
DAP103	V1	Dapdap, Siquijor, Siquijor, Philippines	*	*	*
DAP104	V1	Dapdap, Siquijor, Siquijor, Philippines	*	*	*
DAP146	V1	Tolingon, Isabel, Leyte, Philippines		*	
DAP154	V1	Tolingon, Isabel, Leyte, Philippines		*	*
DAP167	V1	Daang Lungsod, Alcoy, Cebu, Philippines	*		*
DAP171	V1	Daang Lungsod, Alcoy, Cebu, Philippines		*	*
DAP202	V32	Sawang, Tambisan, San Juan, Siquijor, Philippines	*	*	*
DAP204	V32	Sawang, Tambisan, San Juan, Siquijor, Philippines	*	*	*
DAP480	V32	Sawang, Tambisan, San Juan, Siquijor, Philippines		*	*
DAP210	V1	Dapdap, Siquijor, Siquijor, Philippines	*	*	*
DAP212	V1	Dapdap, Siquijor, Siquijor, Philippines	*	*	
DAP213	V1	Dapdap, Siquijor, Siquijor, Philippines	*	*	*
DAP214	V1	Dapdap, Siquijor, Siquijor, Philippines	*	*	*
DAP247	V1	Bantayan, Dumaguete, Philippines	*	*	*
DAP248	V1	Bantayan, Dumaguete, Philippines	*	*	*
DAP249	V1	Bantayan, Dumaguete City, Philippines		*	*
DAP250	V1	Bantayan, Dumaguete, Philippines	*	*	*
DAP251	V1	Bantayan, Dumaguete, Philippines	*		*
F001	V1	Bantayan, Dumaguete City, Philippines	*		
F002	V1	Bantayan, Dumaguete City, Philippines	*	*	
F003	V1	Bantayan, Dumaguete City, Philippines	*		
F006	V1	Bantayan, Dumaguete City, Philippines	*	*	



Table 5.1. (Continued.)

Specimen	Clade	Site	FA	CM	DNA
DAP283	V31	Pasig reef, Maydolong, Eastern, Samar, Philippines	*		
DAP286	V31	Pasig reef, Maydolong, Eastern, Samar, Philippines	*	*	
DAP288	V31	Pasig reef, Maydolong, Eastern, Samar, Philippines	*	*	
DAP294	V31	Pasig reef, Maydolong, Eastern, Samar	*	*	
DAP295	V31	Pasig reef, Maydolong, Eastern, Samar	*	*	
DAP296	V31	Pasig reef, Maydolong, Eastern, Samar	*	*	
DAP334	B5	White Beach, Mahatao, Batanes, Philippines	*	*	
DAP339	B21	White Beach, Mahatao, Batanes, Philippines	*	*	*
DAP340	B35	White Beach, Mahatao, Batanes, Philippines	*	*	
DAP344	B5	White Beach, Mahatao, Batanes, Philippines	*	*	*
DAP346	B5	White Beach, Mahatao, Batanes, Philippines	*	*	*
DAP347	B35	White Beach, Mahatao, Batanes, Philippines	*	*	
DAP352	B5	Chanaryan, Basco, Batanes, Philippines	*	*	*
DAP364	21	Chanaryan, Basco, Batanes, Philippines	*	*	*
DAP367	21	Chanaryan, Basco, Batanes, Philippines	*	*	*
DAP369	21	Chanaryan, Basco, Batanes, Philippines	*	*	*
DAP371	B35	Chanaryan, Basco, Batanes, Philippines	*	*	
DAP373	B5	Chanaryan, Basco, Batanes, Philippines	*	*	*
DAP438	V1	Dapdap, Siquijor, Siquijor, Philippines	*	*	
DAP441	V1	Dapdap, Siquijor, Siquijor, Philippines	*	*	
DAP442	V1	Dapdap, Siquijor, Siquijor, Philippines			*
DAP443	V1	Dapdap, Siquijor, Siquijor, Philippines	*		
DAP449	V1	Dapdap, Siquijor, Siquijor, Philippines		*	
DAP450	V1	Dapdap, Siquijor, Siquijor, Philippines	*		*
HV646	V32	SE of Olango Island, Cebu, Philippines	*	*	+

Specimens were preserved in a 5% formalin-seawater solution and thallus clippings were preserved in silica gel for molecular characterization. Undamaged branch tips were carefully selected for image acquisition. Thallus tips (approximately 10 mm) were cut and carefully mounted on a microscope slide such that the inrolled side of the tip touched the cover slip (Fig. 5.1). Three to eight branch tips were used as replicates for every individual sample. The prepared tips were photographed under 8x magnification using Wild stereomicroscope equipped with Olympus DP50 digital camera. To verify the life-history stage, specimens were examined under the microscope for reproductive structures.

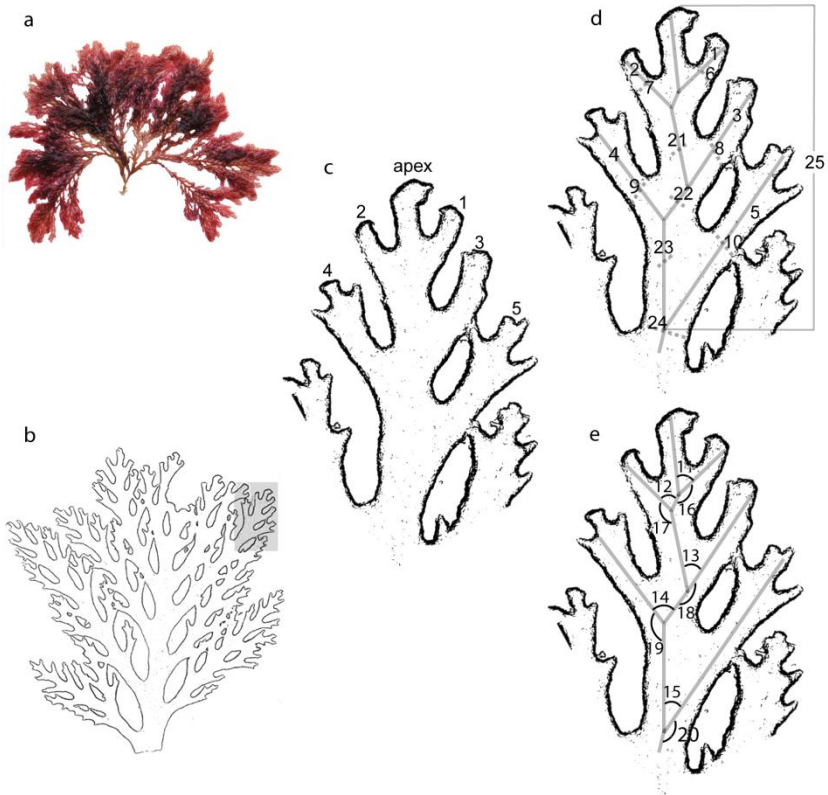

Fig. 5.1. Collection of conventional parameter measurements. (a) General branching pattern of *Portieria*. (b) A 10-mm branch tip with the gray area marking the measurement spot. (c) Numbers assigned to branchlets. (d) Length and width measurements collected. (e) Location of angles measured. Numbers on (d) and (e) are further defined in Table 5.3.

### 5.2.2 DNA-based species assignment

Samples used in the morphometric analyses were assigned to the species defined in Chapter 3 based on analysis of *cox2-3* sequences. DNA extraction, PCR amplification and sequencing were performed as described in Chapter 3. DNA sequences generated were edited using BIOEDIT 7.0.9.0 (Hall, 1999) and were aligned using MAFFT (Multiple Alignment using Fast Fourier Transform) (Katoh et al., 2002). The alignment included 344 bases of 63 *P. bornemannii* and two *Ochtodes secundiramea* sequences. This was submitted to the University of Oslo BIOPORTAL (<http://www.biportal.uio.no/>) for Bayesian phylogenetic tree construction using MrBayes v3.1.2 (Huelsenbeck and Ronquist, 2001). Bayesian analysis was performed using a GTR + I +  $\Gamma$  model. Posterior probabilities were estimated using a Metropolis-coupled Markov chain Monte Carlo approach with sampling according to the Metropolis–Hastings algorithm. The analysis used four chains, one cold and three incrementally heated. Each run consisted of 3000000 generations and was sampled every 1000 generation. Burnin value was determined using TRACER V1.4 (Rambaut and Drummond, 2007) and was set at 750 generations. PhyML (Guindon et al., 2009) was used for Maximum Likelihood analysis (ML). The model of nucleotide substitution used for ML was General Time Reversible (GTR). PhyML was set to estimate the proportion of invariable sites, consider 4 substitution rate categories, estimate the gamma distribution parameter, use BIONJ as an input tree, and to conduct a non-parametric bootstrap analysis of 1000 replicates.

### 5.2.3 Fractal analysis

JPEG images with a resolution of 314 dpi were converted to a binary image and saved in bitmap format using ImageJ 1.42q (Rasband, 1997-2009). Fractal analysis was conducted using the ImageJ plugin FracLac (Karperien, 1999-2007). Two fractal dimensions were measured box-counting dimension ( $D_B$ ) and lacunarity ( $\Lambda$ ). Box counting dimension ( $D_B$ ) is defined as the negative limit of the ratio of the log of the number of boxes at a certain scale over the log of that scale (Karperien, 1999-2007). In a box counting scan complexity is measured by laying several grids of decreasing caliber over an image and counting the number of boxes containing pixels for each grid. In this case, four grids of varying sizes were superimposed on the images. Mean lacunarity ( $\Lambda$ ) is a measure of heterogeneity, ‘gappiness’ or visual texture. It is derived from the variation in pixel density at

different grid calibers, using the coefficient of variation (CV) in pixel distribution. CV is computed from the standard deviation over the mean in pixel density ( $\sigma/\mu$ ). Lacunarity is aimed at supplementing the  $D_B$  as some patterns may have identical  $D_B$ s but a different lacunarity value (Karperien, 1999-2007). Other non-fractal parameters measured using FracLac are the following: foreground pixels, density, span ratio, maximum span, hull area, hull perimeter or convex hull, and circularity. Definition of fractal and non-fractal parameters is as provided in the FracLac documentation and Karperien et al. (2005). For quick reference, definitions of specific parameters used here are provided in Table 5.2.

Table 5.2. Definition of fractal and FracLac-derived (non-conventional) parameters.

Parameter	Definition
Box counting dimension ( $D_B$ )	Measured from ratio of increasing detail (N, number of parts) over increasing scale ( $\epsilon$ ). Several grids of decreasing box size are placed over the image and the numbers of boxes containing pixels are counted for each grid. $D_B = -\lim [\log N\epsilon / \log \epsilon]$ ; = negative limit of the ratio of the log of the number of boxes at a certain scale over the log of that scale.
Lacunarity $\Delta D$	Gappiness or visual texture. Measure of heterogeneity, translational or rotational invariance in an image. Calculated as the variation in pixel density at different box sizes, using the coefficient of variation (CV) for pixel distribution.
Foreground pixels	The number of pixels deemed foreground.
Density	Foreground Pixels/Hull Area; the unit is pixels/pixels <sup>2</sup> or pixels <sup>-1</sup>
Span ratio	The ratio of the major over the minor axes of the convex hull.
Maximum span	The maximum distance in pixels between points across the convex hull.
Hull area	The area, in pixels <sup>2</sup> , of the convex hull.
Hull perimeter or convex hull	A connected series of straight segments convexly enclosing all of the foreground pixels of a binary image.
Circularity	The smallest circle enclosing all of the foreground pixels of a binary image, calculated using the maximum span across or else the three points defining the smallest circle around the convex hull

---

#### 5.2.4 *Conventional morphometric measurements*

For conventional morphometric measurements, we used the same images acquired for fractal analysis. A total of 25 parameters were measured using ImageJ. These parameters are classified as conventional as they are typical linear measurements used in characterizing macroalga and other plants. Table 5.3 provides the definition of the different measurements. For ease, areas of interest were marked and traced with lines to serve as measurement guides (Fig. 5.1a-e). Measurements were based on the first five lateral branchlets beginning from the apex of the branch. The first lateral branchlet appearing at the right of the apical tip was designated as the first order lateral branchlet. The second order lateral branchlet was the second branchlet occurring after and subopposite to the first order branchlet. The succeeding branchlets are ordered in the same manner. However, in some cases when a branchlet is absent in the expected position (for example, 1st branch), the measurement indicated is zero. In instances where overlap among branches is unavoidable and measurement is not possible, no value is indicated. The scale for the measurements were set at 314 distance in pixels; 1 known distance; 1.0 pixel aspect ratio; and unit length in mm.

Table 5.3. Definition of conventional measurements.

<b>Variable</b>	<b>Description</b>
1 L_br_1	Length of the first order lateral branchlet
2 L_br_2	Length of the second order lateral branchlet
3 L_br_3	Length of the third order lateral branchlet
4 L_br_4	Length of the fourth order lateral branchlet
5 L_br_5	Length of the fifth order lateral branchlet
6 W_br_1	Width of the first order lateral branchlet
7 W_br_2	Width of the second order lateral branchlet
8 W_br_3	Width of the third order lateral branchlet
9 W_br_4	Width of the fourth order lateral branchlet
10 W_br_5	Width of the fifth order lateral branchlet
11 A_br_1	Angle of the first order lateral branchlet from the apex
12 A_br_2	Angle between the first and second order lateral branchlet
13 A_br_3	Angle between the second and third order lateral branchlet
14 A_br_4	Angle between the third and fourth order lateral branchlet
15 A_br_5	Angle between the fourth and fifth order lateral branchlet
16 Flx_axs_1	Flex of axis in the first order lateral branchlet
17 Flx_axs_2	Flex of axis in the second order lateral branchlet
18 Flx_axs_3	Flex of axis in the third order lateral branchlet
19 Flx_axs_4	Flex of axis in the fourth order lateral branchlet
20 Flx_axs_5	Flex of axis in the fifth order lateral branchlet
21 L_bet_br3	Length of the main axis between the second branchlet and third order lateral
22 L_bet_br4	Length of the main axis between the third and branchlet fourth order lateral
23 L_bet_br5	Length of the main axis between the fourth and fifth order lateral
24 L_axs_br5	Length of the main axis from the apex to the fifth order branchlet
25 W_axs_br5	Width of the main axis at the fifth order branchlet

### 5.2.5 Statistical analyses

A forward stepwise discriminant function analysis (DA) was performed using STATISTICA 7.0 (StatSoft Inc., Tulsa, OK, USA) to assess the potential of fractal and conventional morphometric variables in discriminating and predicting cluster membership among samples. The method tries to find the best set of predictors that will best differentiate groups in the categorical dependent variable. Variables were entered using the default forward stepwise options in STATISTICA. *A priori* groups were defined according to the clusters found in the *cox2-3* spacer phylogeny and the life stages of *Portieria*. Variables were checked if assumptions set for DA were met. Some variables failed to meet the normality criterion, but since violations of normality are not critical (Tabachnick and Fidell, 2006) as long as non-normality is caused by skewness and not outliers, we used untransformed values. Assumption of homoscedasticity (homogeneity of variances) was tested using Levene's test and Cochran C. This assumption was met except for two variables. But since DA is fairly robust against violation of this assumption (Verbruggen *et al.*, 2005a), this violation was disregarded. An important assumption is correlation between means and variances which can threaten validity of a significance test (StatSoft, 2010). No violation of this assumption was observed. Variables obtained using FracLac and those obtained by traditional morphometric measurements were analyzed separately as well as combined.

## 5.3 Results

### 5.3.1 Phylogenetic Analyses

The *cox2-3* alignment consisted of 63 *Portieria* sequences and *Ochtodes secundiramea* was used as outgroup. Out of the 344 sites, 137 were parsimony informative while 203 sites were non-polymorphic. Fig. 5.2 shows the BI tree indicating very high support in most branches. Specimens from the Visayas belong to at least three clusters (V1, V31, and V32) while those of Batanes belong to at least five lineages (B5, B8, B35, B33, and B21).

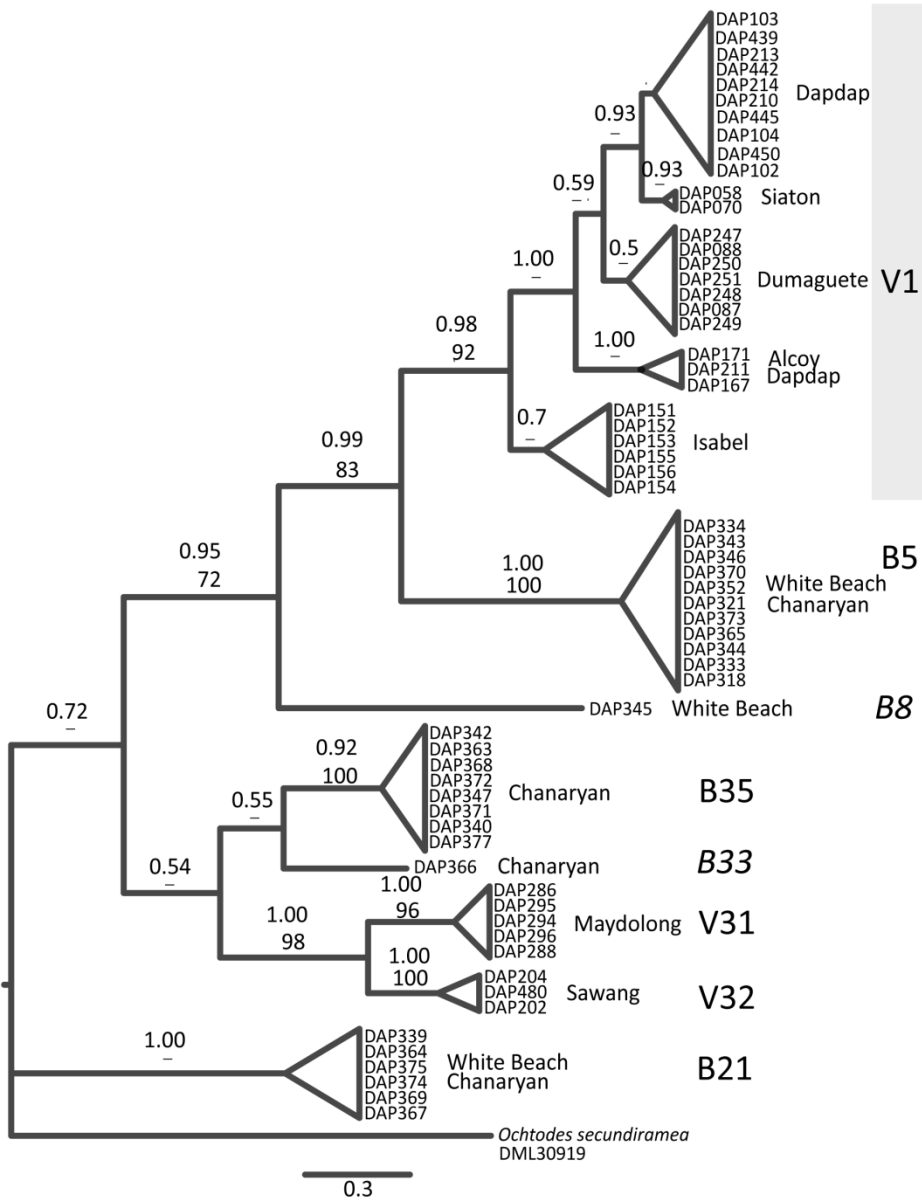

Fig. 5.2. Phylogenetic tree reconstructed using Bayesian inference based on the mitochondrial *cox2-3* spacer of *Portieria* specimens collected from Batanes (B) and Visayas (V) Islands in the Philippines. ML analysis generated identical groupings. Posterior probabilities  $\geq 0.5$  are indicated at the branches.



Specimens belonging to six clades (V1, B5, B35, V31, V32 and B21) were used in the morphometric analysis. Of special interest in this phylogeny are those samples from clade V1. There are five clear subclades belonging to V1. These were recognized as separate species following a general mixed Yule-coalescent (GMYC) model analysis of a *cox2-3* dataset and a multilocus coalescent analysis (see Chapter 3). For the purpose of the morphometric analyses, however, we treat these recently diverged lineages as a single entity. This decision was due to sequencing failure of several specimens used for morphometric measurements. These specimens were mostly from sites where species belonging to clade V1 abounds. These particular specimens could therefore not be unequivocally assigned to these subclades (V1A-E).

### 5.3.2 *Form variation between genetic clusters*

#### **Fractal dimension and non-conventional parameters**

A total of 191 images of *Portieria* apices from 42 individuals belonging to six clades (Fig. 5.2; V1, B5, B35, V31, V32 and B21) were analyzed. Two fractal parameters, box-counting dimension ( $D_B$ ) and lacunarity ( $\Lambda$ ), and eight non-conventional morphometric parameters were scored and analyzed by discriminant analysis. Fig. 5.3a-f shows the mean values for all measured parameters for each clade. The mean  $D_B$  value is  $1.728 \pm 0.003$  while mean lacunarity is  $1.931 \pm 0.005$ . Lacunarity increases with  $D_B$  and a high correlation ( $r=0.91$ ) was observed between these two variables. Nonetheless, none of these two variables were found redundant in the discriminant analysis.

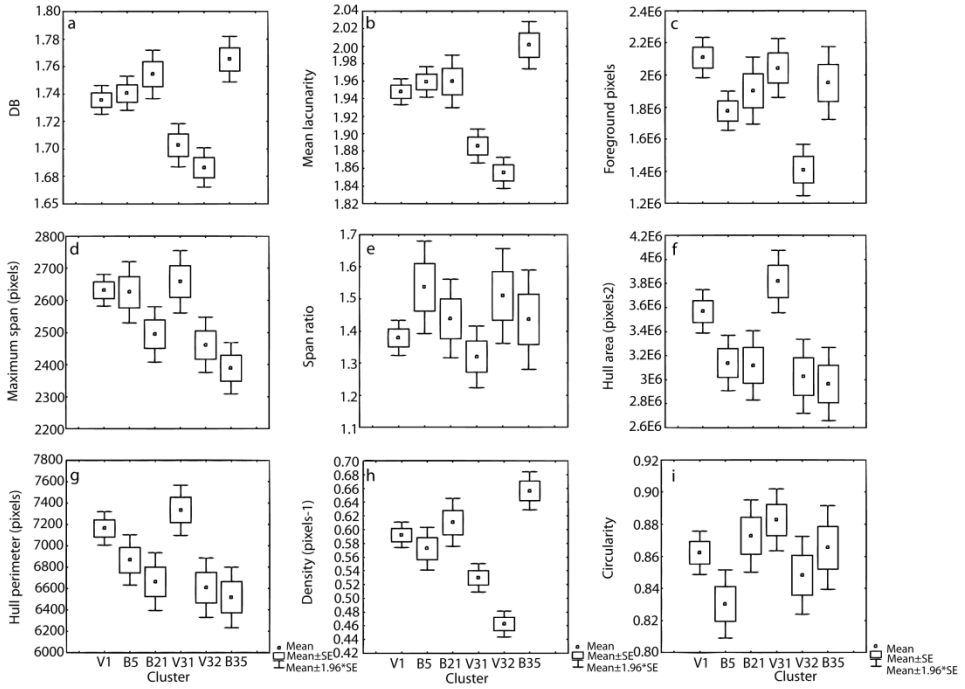

Fig. 5.3. Boxplot of mean values for all measured parameters for each clade and for all the clades.

Fig. 5.4a-i illustrates the relationship of  $D_B$  and  $\Lambda$  and the branching pattern. Higher number of wide branches produces higher fractal dimension ( $D_B$ ) while fewer branching orders and/or thinner branches resulted to a lower  $D_B$ .

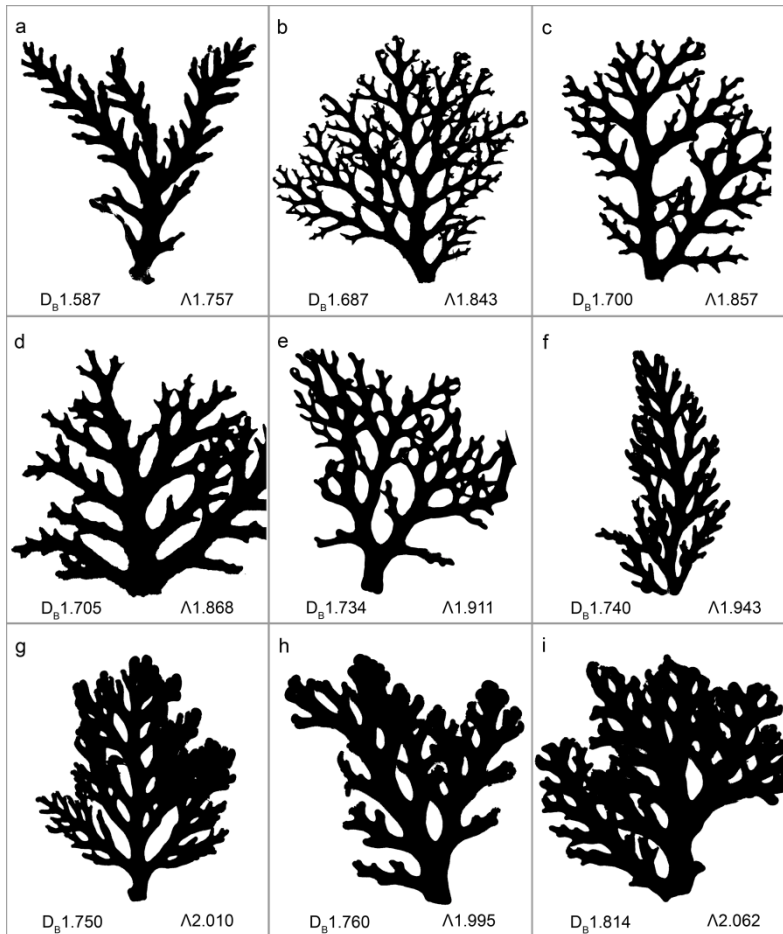

Fig. 5.4. Images of branches demonstrating an increasing box-counting dimension ( $D_B$ ) with lacunarity.

The DA included all but two parameters (span ratio and foreground pixels were excluded) in the model set to predict group membership. Only two variables pixel density and hull perimeter had a significant contribution ( $p < 0.0001$  and  $p = 0.0434$ , respectively) in discriminating the samples of the six clades (Table 5.4). None of the two fractal parameters gave a significant ( $p > 0.05$ ) contribution in

discriminating the samples into groups. Wilks' lambda (1.0 no discriminatory power; 0.0 perfect discriminatory power), indicates that all seven variables showed a relatively even degree of discriminatory power (0.3741-0.4215) (Table 5.4). Circularity and DB have the highest discriminatory power of all the variables analyzed. Pixel density was also found to have the most unique contribution (partial lambda 0.8591) to the discrimination between groups.

Table 5.4. Summary of the Stepwise Discriminant Function Analysis of fractal and non-conventional parameters showing the independent contributions of each variable to the overall discrimination of groups. Wilks lambda values ranges from 0.0 (indicating perfect discriminatory power) to 1.0 (indicating the absence of discriminatory power). Partial Wilks' Lambda indicates for the unique contribution of a variable to group discrimination. The lower the value of Partial Wilks', the greater is the unique discriminatory power of the respective variable.

<b>N = 191</b>	<b>Wilks' Lambda</b>	<b>Partial Lambda</b>	<b>F-remove (5,179)</b>	<b>p-level</b>	<b>Toler.</b>	<b>1-Toler. (R-Sqr.)</b>
Density	0.421486	0.859108	5.871133	0.000048	0.377016	0.622984
Hull Perimeter	0.385786	0.938608	2.341576	0.043403	0.012394	0.987606
Hull Area	0.380772	0.950968	1.845841	0.106149	0.009245	0.990755
Maximum Span	0.383649	0.943837	2.130274	0.063868	0.165300	0.834700
Mean Lacunarity	0.382064	0.947752	1.973594	0.084655	0.156450	0.843550
D <sub>B</sub>	0.374511	0.966868	1.226782	0.298380	0.164119	0.835882
Circularity	0.374069	0.968010	1.183073	0.319256	0.082563	0.917437

Canonical analysis resulted in statistically significant canonical roots or discriminant functions ( $p=0.0000$  and  $p=0.0140$ ). The first root is weighted most heavily by hull perimeter and hull area while the second is weighted more by hull area and D<sub>B</sub> as reflected by the resulting standardized coefficients (Table 5.5). The first and second root accounts for 72% and 15% of the explained variance respectively. The first canonical root discriminates mostly samples belonging to V32 and B35 while the second discriminates samples belonging to B35 and V31 (Table 5.6).

Table 5.5. Standardized b coefficients derived from canonical analysis of fractal and non-conventional variables, showing the optimal combination of variables so that the first function provides the most overall discrimination between groups. The larger the standardized b coefficient, the larger the respective variable's unique contribution to the discrimination specified by the respective discriminant function.

Parameter	Root 1	Root 2
Density	0.82523	-0.123152
Hull Perimeter	2.91160	-0.143495
Hull Area	-2.38983	-0.730742
Maximum Span	-0.47189	-0.194247
Mean Lacunarity	0.60533	-0.105021
D <sub>B</sub>	-0.30592	0.422666
Circularity	0.07332	0.162905
Eigenval	0.93970	0.197757
Cum.Prop	0.72030	0.871883

Table 5.6. Means of canonical variables (from canonical analysis of fractal and non-conventional variables) indicating which groups are best distinguished in each function or root.

Clade	Root 1	Root 2
V1	0.52217	-0.283916
B5	0.45161	0.179798
B21	0.30530	0.549598
V31	-0.68423	-0.648639
V32	-1.87988	0.360831
B35	1.26652	0.763441

However, the plot of canonical scores reveals a very poor discrimination between the six groups (Fig. 5.5a). The poor morphological discrimination of the respective lineages based on fractal analyses is confirmed by the results of the classification analyses. When a priori classification probabilities were the same for all groups, classification results were low to mediocre. In total, less than half of the specimens (42.9%) were correctly classified. Only lineage V32 had a slightly higher percentage (71%) of correctly assigned specimens (Table 5.7).

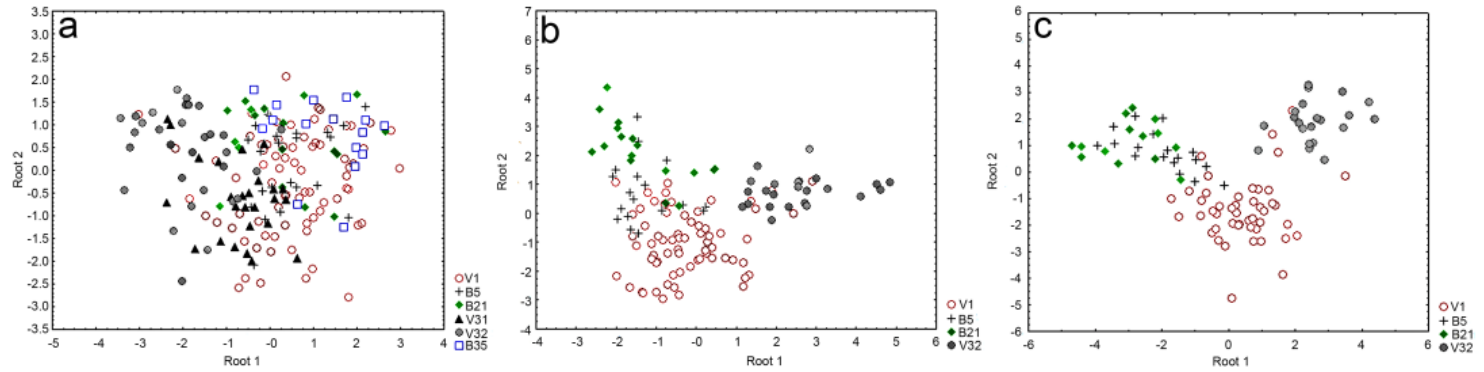

Fig. 5.5. Scatter plots of discriminant scores derived from significant discriminant (canonical) roots. (a) Scatter plot of discriminant scores derived from fractal and non-conventional (FraLac-derived) variables. (b) Scatter plot of discriminant scores derived from conventional variables. (c) Scatter plot of discriminant scores derived from combined FraLac-derived and conventional variables.

Table 5.7. Classification matrix (from DA of fractal and non-conventional variables) indicating the percentage of cases correctly classified for each group when a priori classification probabilities are the same for all groups.

Clade	% Correct	V1 p=.16667	V5 p=.16667	V21 p=.16667	V31 p=.16667	V32 p=.16667	V35 p=.16667	N
V1	21.3	16	16	11	13	3	16	75
B5	33.3	3	8	9	2	0	2	24
V21	52.6	2	2	10	2	0	3	19
V31	65.4	2	2	2	17	3	0	26
V32	71.0	0	1	1	7	22	0	31
V35	56.3	2	1	3	0	1	9	16
Total	42.9	25	30	36	41	29	30	191

### Conventional measurements

A total of 127 images of *Portieria* apices from 30 individuals belonging to four clades (Fig. 5.2) were analyzed. Twenty-five parameters were scored providing information on the length, width, angle and flex of the 5 branchlets situated most closely to the tip of a *Portieria* branch (Fig. 5.1). Mean substitution was used to account for missing data. The mean of the measurements for each clade are listed in Table 5.8. Measurements of the first 5 branchlets for all the four lineages ranged from 0.2805 mm to 0.8783 mm in mean length and 0.0821 to 0.1836 mm in mean width. The angle between successive branches ranged from 29.9<sup>0</sup> to 38.3<sup>0</sup>. Branchlets are flexed from the axis at angles ranging from 88.6<sup>0</sup> to 108.4<sup>0</sup>. Mean length of the axis between successive branchlets 3-5 ranged from 0.3466 to 1.2509 mm. Mean width of the axis of branch 5 was 0.3330 mm.

Table 5.8. Means of the 25 conventional measurements measured. Length and width measurements are in mm.

Clade	L_br_1	L_br_2	L_br_3	L_br_4	L_br_5	W_br_1	W_br_2	W_br_3	W_br_4	W_br_5	A_br_1	A_br_2	A_br_3
V1	0.2939	0.5072	0.7372	0.8219	0.9116	0.0886	0.1363	0.1778	0.1913	0.2059	27.9	33.7	37.1
B5	0.2917	0.5269	0.6780	0.6221	0.7025	0.0756	0.1142	0.1452	0.1569	0.1633	18.0	20.0	20.6
B21	0.2780	0.4373	0.6549	0.7092	0.8752	0.0727	0.0969	0.1203	0.1268	0.1336	22.5	14.4	21.3
V32	0.2356	0.4424	0.6520	0.8004	0.9181	0.0755	0.1144	0.1388	0.1644	0.1713	48.6	61.1	60.7
All Grps	0.2805	0.4884	0.7017	0.7744	0.8783	0.0821	0.1238	0.1581	0.1727	0.1836	29.7	34.4	37.1

Clade	A_br_4	A_br_5	Flx_axs_1	Flx_axs_2	Flx_axs_3	Flx_axs_4	Flx_axs_5	L_bet_br3	L_bet_br4	L_bet_br5	L_axs_br5	W_axs_br5	N
V1	38.7	38.7	96.8	117.1	124.1	123.4	117.9	0.3552	0.2688	0.3676	13.747	0.3818	68
B5	18.7	20.6	63.4	77.6	73.7	73.6	72.0	0.3757	0.2465	0.3925	0.7326	0.2998	18
B21	20.7	21.6	51.1	67.8	66.0	67.8	67.4	0.3314	0.2776	0.2921	0.8320	0.2379	17
V32	62.0	62.3	110.7	136.4	137.7	139.2	137.9	0.3112	0.3387	0.4200	16.248	0.2874	24
All Grps	37.9	38.3	88.6	108.6	111.8	111.9	108.4	0.3466	0.2800	0.3709	12.583	0.3330	127

Of the 25 variables, only 13 were finally included in the DA model (Table 5.9). Variables with the least unique contribution to the discrimination were excluded (partial  $\lambda \geq 0.9790$ ). Six out of 13 variables had significant contribution in discriminating the samples into different groups ( $W\_axs\_br5$ ,  $A\_br2$ ,  $A\_br3$ ,  $L\_bet\_br5$ ,  $A\_br4$ , and  $L\_br5$ ). Of the variables in the model,  $Flx\_axs\_3$  and  $W\_br\_5$  have the highest discriminatory power (0.1397 and 0.1416, respectively).  $A\_br\_4$  had the highest discriminatory power (0.1469) among the significant variables.  $W\_axs\_br5$  had the most unique contribution (0.6776) in the discrimination of cases but with the least discriminatory power.

Two significant discriminant functions (canonical roots,  $p=0.0000$ ) emerge from the canonical analysis. The first and second root account for 55% and 42%, respectively, of the explained variance. Of the 13 variables, the angles,  $A\_br\_3$  and  $A\_br\_4$ , contribute most to the prediction of group membership in root 1 and  $W\_axs\_br5$  and  $A\_br2$  for root 2 (Table 5.10).



Table 5.9. Summary of the Stepwise Discriminant Function Analysis of conventional parameters showing the independent contributions of each variable to the overall discrimination of groups.

Parameter N= 127	Wilks' Lambda	Partial Lambda	F-remove (3,111)	p-level	Toler.	1-Toler. (R- Sqr.)
W_axs_br5	0.201629	0.677596	17.60478	0.000000	0.594671	0.405330
A_br_2	0.156941	0.870538	5.50248	0.001464	0.279724	0.720276
Flx_axs_2	0.144954	0.942526	2.25622	0.085814	0.282692	0.717308
A_br_3	0.151660	0.900850	4.07230	0.008717	0.189101	0.810899
Flx_axs_3	0.139771	0.977477	0.85255	0.468112	0.114396	0.885604
L_bet_br5	0.156701	0.871872	5.43743	0.001587	0.638395	0.361605
L_bet_br4	0.143435	0.952509	1.84478	0.143199	0.691522	0.308478
A_br_4	0.146915	0.929946	2.78726	0.044034	0.151386	0.848614
L_br_1	0.143916	0.949327	1.97498	0.121862	0.835061	0.164939
L_br_5	0.147687	0.925084	2.99637	0.033829	0.540631	0.459370
Flx_axs_4	0.143235	0.953842	1.79050	0.153125	0.093875	0.906125
A_br_5	0.142185	0.960884	1.50622	0.216892	0.204426	0.795574
W_br_5	0.141650	0.964514	1.36128	0.258407	0.476849	0.523151

The first and second roots discriminate mostly samples from V32 and B21 (Table 5.11). Fig. 5b illustrates a large overlap in canonical scores between the four groups, be it that V32 is moderately well discriminated along the first canonical axis. Classification success was moderate to high, ranging from 70.6% (N=17) to 100% (N=24) if *a priori* probabilities were made equal among groups (Table 5.12).

Table 5.10. Standardized  $b$  coefficients derived from canonical analysis of conventional variables, showing the optimal combination of variables so that the first function provides the most overall discrimination between groups. The larger the standardized  $b$  coefficient, the larger is the respective variable's unique contribution to the discrimination specified by the respective discriminant function.

Parameter	Root 1	Root 2
W_axis_br5	0.089935	-0.963490
A_br_2	0.564458	-0.489482
Flx_axis_2	-0.504456	-0.260415
A_br_3	0.846353	0.318045
Flx_axis_3	-0.495866	-0.210390
L_bet_br5	0.338452	0.380495
L_bet_br4	0.170343	0.269753
A_br_4	0.652460	-0.079111
L_br_1	-0.241545	0.200309
L_br_5	0.085602	0.342049
Flx_axis_4	-0.695412	-0.316343
A_br_5	0.312262	0.472667
W_br_5	0.091965	-0.338047
Eigenval	1.799940	1.357267
Cum.Prop	0.551085	0.966638

Table 5.11. Means of canonical variables (conventional) indicating which groups are best distinguished in each function or root composed of conventional variables.

Clade	Root 1	Root 2
<b>V1</b>	-0.24017	-0.992647
<b>B5</b>	-1.26998	0.715447
<b>B21</b>	-1.32417	2.118575
<b>V32</b>	2.57092	0.775256

Table 5.12. Classification matrix (from DA of conventional variables) indicating the percentage of cases correctly classified for each group when a priori classification probabilities are the same for all groups.

Clade	%Correct	V1	B5	B21	V32	N
		p=.25000	p=.25000	p=.25000	p=.25000	
<b>V1</b>	72.1	49	12	2	5	68
<b>B5</b>	72.2	2	13	3	0	18
<b>B21</b>	70.6	2	3	12	0	17
<b>V32</b>	100.0	0	0	0	24	24
Total	77.2	53	28	17	29	127

### Combined parameters

A total of 100 apices of *Portieria* from 23 individuals belonging to four lineages (Fig. 5.2) were analyzed. All non-conventional and conventional parameters except for hull area were used for DA. The tolerance value of the hull area failed to reach the minimum limit (0.01) and was highly correlated with hull perimeter. The DA model contained nineteen variables which included component parameters nearly identical to the two previous analyses. However, foreground pixels was included while  $D_B$  and hull area were excluded in this model. This was not the case in the first DA analysis (under fractal and non-conventional parameters) which recorded  $D_B$  with the second highest discriminatory power (Table 5.4). Eight conventional and one non-conventional variable (circularity) were found to have significant contribution to the discrimination of samples. The 13 variables showed nearly even discriminatory powers (0.0482-0.0589).  $W\_axis\_br5$  had the most unique contribution in the discriminatory power of all 13 variables.

The analysis yielded three discriminant functions (canonical roots), accounting for 58%, 34%, and 8% of the explained variance, respectively. Roots 1, 2 and 3 are weighted most heavily by variables  $A\_br\_4$ , density, maximum span, circularity, hull perimeter and foreground pixels. Based from the means of canonical variables, root 1 discriminates mostly samples from B21 and V32. Root 2 discriminates V32 and V1 while root 3 discriminates B5 and B21 samples. On Fig. 5.5c, samples belonging to V32 are well-separated at the positive side of the scatter plot. The samples from V1 are partially separated but those from B5 and B21 clearly overlap. Successful group classification of cases ranged from 83.3 % (N=18) to 100% (N =21) when a priori probabilities were equal along groups (Table 5.13).

Table 5.13. Classification matrix derived from combined variables indicating the percentage of cases correctly classified for each group when a priori classification probabilities are the same for all groups.

Clade	%Correct	V1	B5	V21	V32	N
		p=.25000	p=.25000	p=.25000	p=.25000	
V1	85.1	40	2	1	4	47
B5	83.3	1	15	2	0	18
V21	92.9	0	1	13	0	14
V32	100.0	0	0	0	21	21
Total	89.0	41	18	16	25	100

## 5.4 Discussion

In this study we aimed to assess whether it is possible to distinguish between *Portieria* species on the basis of morphometric variables. Fractal analyses resulted in low to moderate classification success. The maximum percentage of correctly classified cases was 71% for lineage V32. Classification success was higher for conventional measurements, ranging from 70 to 100%. When combined, fractal variables and conventional measurements resulted in high to very high classification success (83-100 %). These results indicate that although it may not be possible to assign each individual specimen or apex to the correct lineage, some *Portieria* species are morphologically differentiated from one another. Misclassification of individual specimens was highest for B5, B21 and V1, while specimens of V32 appeared to be morphologically more differentiated from the others. Regardless of techniques used (fractal analyses, conventional measurements, or the combined data set) their classification success was markedly higher. The fractal and non-conventional characters that set them apart from the rest were  $D_B$  and circularity while, pixel density provided a unique discriminatory power. The conventional variables, flex of axis in the third order lateral branchlet (Flx\_axis\_3) and width of the fifth order lateral branchlet (W\_br\_5) have the highest discriminatory power. Width of the fifth order lateral branchlet (W\_axis\_br5) had the most unique contribution in the discrimination. Conventional measurements outperform the parameters derived from the fractal analysis. In addition, conventional measurements have the advantage that their interpretation is more straightforward compared to the somewhat abstract parameters resulting from fractal analyses. The combination of both, however, results in the best discriminatory power.

These results show the utility of simple linear and branch angle measurements in capturing differences among macroalgal sister species. This suggests that the method can be carried on to future morphometric investigations in *Portieria* and possibly, similarly branched seaweeds (e.g. *Plocamium*). It should also be noted that more meaningful measurements can be obtained around older branchlets, as suggested by the parameters retained in the DA and those with the highest discriminatory power. Since combined fractal, non-conventional and conventional variables improve discrimination and classification, future morphometric studies, should focus on the 20 variables ( $D_B$ , density, hull perimeter, hull area, maximum span, mean lacunarity, circularity, W\_axis\_br5, A\_br\_2, Flx\_axis\_2, A\_br\_3, Flx\_axis\_3, L\_bet\_br5, L\_bet\_br4, A\_br\_4, L\_br\_1, L\_br\_5, Flx\_axis\_4, A\_br\_5, W\_br\_5) found to contribute in the discrimination between

*Portieria* species. The robustness of these variables may be further tested with the classification of more samples from the lineages in this study. In fractal analysis, to obtain the true value of a fractal dimension care should be taken that noise from dust, particles and epiphytes are removed since these pixels are included in the analysis. In the same way, damaged specimens should also be avoided so as to capture the real shape of a specimen.

Although it is clear that *Portieria* lineages exhibited little morphological change over time, we show that diversification in *Portieria* did coincide with subtle morphological differentiation which is detectable through morphometric analyses. At least the species compared in this study (B5, B21, B31, B35, V1, V32) are not entirely cryptic, because we are able to show morphological differences *post hoc*, that is after species had been delineated based on DNA sequence data. Hence, we would classify them as being pseudocryptic (see Knowlton, 1993; Sáez et al., 2003). The clades selected for the morphometric analyses are however not sister taxa. They are often more closely related to other species occurring within or outside the Philippines (see Chapter 4). The scale and tempo, at which morphological differences become established, however, remain to be determined using fine-scale investigations between closely related lineages. Especially, the V1 clade which we have shown to be composed of at least 5 distinct lineages all present in the Visayas, could present an interesting test case. These subclades, identified as distinct species by various algorithmic species delimitation analyses, diverged at small spatial scales in the Visayas during the last 5 My. In this paper, we united the various subclades, but it would be interesting to investigate if morphological differences exist between these recently diverged species.

## 5.5 Acknowledgements

Funding was provided by the Flemish Interuniversity Council (VLIR) as a PhD grant to DA Payo. Sincere gratitude goes to Abner Bucol, Zacharias Generoso and Jacinta Lucañas of IEMS- Silliman University, Rey Ladiao of Leyte Normal University and Florabel Fumar of the University of the Philippines, William Villaver and Batanes MENRO Francis Domingo for field and dive assistance. We also thank D. and M. Littler for providing *Ochtopodes* samples. We greatly appreciate the assistance of Caroline Vlaeminck and Sofie D'hondt on PCR and sequencing work.



## 5.6 References

- Abraham, E.R., 2001. The fractal branching of an arborescent sponge. *Mar. Biol.* 138, 503-510.
- Alados, C.L., Escos, J., Emlen, J.M., Freeman, D.C., 1999. Characterization of branch complexity by fractal analyses. *Int. J. Plant Sci.* 160, S147-S155.
- Altamirano-Cerecedo, M.C., Riosmena-Rodríguez, R., 2007. Vegetative and reproductive variability of *Dictyota crenulata* (Phaeophyta: Dictyotales) along the Central and Southwestern Gulf of California, México. *Pac. Sci.* 61, 575-586.
- Corbit, J.D., Garbary, D.J., 1995. Fractal dimension as a quantitative measure of complexity in plant development. *P. Roy. B-Biol. Sci.* 262, 1-6.
- Guindon, S., Dufayard, J.F., Hordijk, W., Lefort, V. & Gascuel, O. 2009. Phylml: Fast and accurate phylogeny reconstruction by maximum likelihood. *Infect. Genet. Evol.*, 9, 384-385.
- Goutzanis, L., Papadogeorgakis, N., Pavlopoulos, P.M., Katti, K., Petsinis, V., Plochoras, I., Pantelidaki, C., Kavantzias, N., Patsouris, E., Alexandridis, C., 2008. Nuclear fractal dimension as a prognostic factor in oral squamous cell carcinoma. *Oral Oncol.* 44, 345-353.
- Guiry, M.D., Guiry, G.M., 2011. AlgaeBase. World-wide electronic publication, National University of Ireland, Galway. <http://www.algaebase.org>; searched on 19 June 2011.
- Hall, T.A., 1999. BioEdit: a user-friendly biological sequence alignment editor and analysis program for Windows 95/98/NT. *Nucl. Acids. Symp. Ser.* 41, 95-98.
- Hubbard, C.B., Garbary, D.J., 2002. Morphological Variation of *Codium fragile* (Chlorophyta) in Eastern Canada. *Bot. Mar.* 45, 476-485.
- Huelsenbeck, J.P., Ronquist, F., 2001. MRBAYES: Bayesian inference of phylogenetic trees. *Bioinformatics* 17, 754-755.
- Kaandorp, J.A., Kübler, J.E., 2001. The algorithmic beauty of seaweeds, sponges, and corals. Springer Verlag.
- Karperien, A., 1999-2007. FracLac for ImageJ, version 2.5. <http://rsb.info.nih.gov/ij/plugins/fraclac/FLHelp/Introduction.htm>.
- Karperien, A., Jelinek, H.F., Bossomaier, T., 2005. Fractal analysis quantitates overt and subtle effects of naloxone and lipopolysaccharide on cultured rat microglia. *Complex Int. Monash University Faculty of Information of Technology*, p. msid12.
- Katoh, K., Misawa, K., Kuma, K.-i., Miyata, T., 2002. MAFFT: a novel method for rapid multiple sequence alignment based on fast Fourier transform. *Nucl. Acids Res.* 30, 3059-3066.
- Knowlton, N., 1993. Sibling species in the sea. *Annu. Rev. Ecol. Syst.* 24, 189-216.
- Kraan, S., Rueness, J., Guiry, M., 2001. Are North Atlantic *Alaria esculenta* and *A. grandifolia* (Alariaceae, Phaeophyceae) conspecific? *Eur. J. Phycol.* 36, 35 - 42.
- Kubler, J.E., Dudgeon, S.R., 1996. Temperature dependent change in the complexity of form of *Chondrus crispus* fronds. *J. Exp. Mar. Biol. Ecol.* 207, 15-24.
- Leliaert, F., Millar, A.J.K., Vlaeminck, C., Coppejans, E., 2007. Systematics of the green macroalgal genus *Chamaedoris* Montagne (Siphonocladales), with an emended description of the genus *Struvea* Sonder. *Phycologia* 46.
- Mandelbrot, B.B., 1975. Les objets fractals: forme, hasard et dimension, Flammarion, Paris.
- Martin-Garin, B., Lathuiliere, B., Verrecchia, E.P., Geister, J., 2007. Use of fractal dimensions to quantify coral shape. *Coral Reefs* 26, 541-550.
- Montañes, M.A., Sanson, M., Reyes, J., 2006. Vegetative and reproductive phenology of *Zonaria tournefortii* (Dictyotales, Phaeophyceae) in sublittoral populations off the Canary Islands. *Bot. Mar.* 49, 406-416.
- Rambaut, A., Drummond, A.J., 2007, Tracer v1.4.
- Rasband, W.S., 1997-2009. ImageJ, US National Institutes of Health, Bethesda, Maryland, USA. <http://rsb.info.nih.gov/ij> 20.
- Sáez, A.G., Probert, I., Geisen, M., Quinn, P., Young, J.R., Medlin, L.K., 2003. Pseudo-cryptic speciation in coccolithophores. *Proc. Natl. Acad. Sci. U. S. A.* 100, 7163.

- Sherwood, A.R., Sheath, R.G., 1999. Biogeography and systematics of Hildenbrandia (Rhodophyta, Hildenbrandiales) in North America: inferences from morphometrics and *rbcL* and 18S rRNA gene sequence analyses. *Eur. J. Phycol.* 34, 523-532.
- Sherwood, A.R., Sheath, R.G., 2000. Biogeography and systematics of Hildenbrandia (Rhodophyta, Hildenbrandiales) in Europe: inferences from morphometrics and *rbcL* and 18S rRNA gene sequence analyses. *Eur. J. Phycol.* 35, 143-152.
- Sherwood, A.R., Sheath, R.G., 2003. Systematics of the Hildenbrandiales (Rhodophyta): Gene sequence and morphometric analyses of global collections. *J. Phycol.* 39, 409-422.
- StatSoft, I., 2010, Electronic Statistics Textbook. Tulsa, OK: StatSoft.
- Tabachnick, B.G., Fidell, L.S., 2006. Using Multivariate Statistics (5th Edition). Allyn & Bacon, Inc. , Needham Heights, MA, USA
- Tronholm, A., Sansón, M., Afonso-Carrillo, J., Verbruggen, H., De Clerck, O., 2010. Niche partitioning and the coexistence of two cryptic *Dictyota* (Dictyotales, Phaeophyceae) species from the Canary Islands. *J. Phycol.* 46, 1075-1087.
- Verbruggen, H., De Clerck, O., Cocquyt, E., Kooistra, W., Coppejans, E., 2005a. Morphometric taxonomy of siphonous green algae: A methodological study within the genus *Halimeda* (Bryopsidales). *J. Phycol.* 41, 126-139.
- Verbruggen, H., De Clerck, O., Kooistra, W., Coppejans, E., 2005b. Molecular and morphometric data pinpoint species boundaries in *Halimeda* section *Rhipsalis* (Bryopsidales, Chlorophyta). *J. Phycol.* 41, 606-621.
- Wiseman, D.R., 1975. On the status of the red algal family, the Rhizophyllidaceae (Gigartinales). *Taxon* 24, 489-490.
- Yano, T., Kamiya, M., Arai, S., Kawai, H., 2004. Morphological homoplasy in Japanese *Plocamium* species (Plocamiales, Rhodophyta) inferred from the Rubisco spacer sequence and intracellular acidity. *Phycologia* 43, 383-393.
- Yano, T., Kamiya, M., Murakami, A., Sasaki, H., Kawai, H., 2006. Biochemical phenotypes corresponding to molecular phylogeny of the red algae *Plocamium* (Plocamiales, Rhodophyta): implications of incongruence with the conventional taxonomy. *J. Phycol.* 42,155-169.



## 6 VARIABILITY OF NON-POLAR SECONDARY METABOLITES IN THE RED ALGA *PORTIERIA*<sup>1</sup>

---

### Abstract

About 80 secondary metabolites have been characterized from the marine red macroalga *Portieria hornemannii*. Most of these compounds are halogenated monoterpenes, the signatures of which differ between samples from different geographical origins. Possible sources of variation have rarely been investigated. Using non-polar extraction and metabolite fingerprinting of *P. hornemannii* sampled from two distinct regions in the Philippines (Batanes and Visayas), this study aims to determine if variation is due to the different life-history stages, presence of cryptic species, and/or spatiotemporal factors. A total of 302 compounds were detected. In the Batanes region, DNA sequence data point towards the presence of 5 cryptic species. PCA analyses demonstrate secondary metabolite variation between as well as within these cryptic species. Intraspecific variation was even more pronounced in the Visayas dataset which included samples from 6 sites, belonging to 3 cryptic species. Neither species groupings nor spatial or temporal based patterns were observed in the PCA analysis. However, intraspecific variation in secondary metabolites was detected between life-history stages. Male gametophytes are strongly discriminated from the two other stages, and female gametophyte and tetrasporophyte samples are partially discriminated. Female gametophyte extracts (202) are chemically richer compared to that of the male (102) and tetrasporophyte (106). These results suggest that life-history driven variations and possibly other microscale factors may significantly influence variation within *Portieria* species.

**Keywords:** *Portieria*, secondary metabolite, variation, cryptic species, life-history stages

<sup>1</sup> Unpublished manuscript: Payo D.A., Colo J, Calumpong H. & De Clerck O. Variability of non-polar secondary metabolites in the red alga *Portieria*.

## 6.1 Introduction

Natural products, and in particular secondary metabolites, have been the focus of study in many marine macroalgae. Seaweeds interact with their environment utilizing a rich variety of secondary metabolites (Williams et al., 1989; Hay and Fenical, 1996; Wise, 2003; Bhat et al., 2005). These chemical compounds have no explicit role in the internal metabolism of the organisms (Williams et al., 1989; Bourgaud et al., 2001; Gribble, 2003) but serve as defense mechanisms against grazers, competitors, fouling organisms and pathogens (Dworjanyn et al., 1999; Gunatilaka et al., 1999; Kladi et al., 2004). The compounds are localized in specialized cells, have relatively low molecular weights (<3000 Daltons), are structurally diverse, often halogenated, and exist in low abundance (often <1% of total carbon) (Williams et al., 1989, Fenical, 1975; Hay and Fenical, 1996; Barahona and Rorrer, 2003; Gribble, 2003; Andrianasolo et al., 2006).

Secondary metabolites have drawn wide attention because of their pharmaceutical potentials, chemotaxonomic and ecological importance (Kuniyoshi et al., 2003; Smit, 2004; Kamenarska et al., 2006; Blunt et al., 2007). Macroalgae produce a wide range of compounds such as terpenes, phenols, fatty acids, lipopeptides, amides, alkaloids, terpenoids, lactones, pyrroles and steroids (Bhadury and Wright, 2004; Kladi et al., 2004; Kamenarska et al., 2006). Red seaweeds belonging to the family Rhizophyllidaceae have been found to be especially rich in secondary metabolites, harboring a variety of halogenated monoterpenes. The tropical, Indo-Pacific genus *Portieria* (synonyms *Chondrococcus* and *Desmia*), is a prolific source of these halogenated compounds (Ichikawa et al., 1974; Bureson et al., 1975a; Coll and Wright, 1987; Wright et al., 1991b; Fuller et al., 1992; Fuller et al., 1994; Matlock et al., 1999; Barahona and Rorrer, 2003; Andrianasolo et al., 2006). About 80 monoterpenes have been isolated and characterized from *Portieria hornemannii* (Table S6.1). Among the most interesting of these compounds is halomon, a monoterpene with anti-tumour properties, isolated from samples collected in Batanes, Philippines (Fuller et al., 1992; Fuller et al., 1994). However, the inconsistent availability of this compound from natural populations prevented further drug development.

Previous studies have mainly focused on discovery and pharmaceutical potentials of chemical compounds in *P. hornemannii*. Only a few studies have addressed inter- or intraspecific variation in secondary metabolite composition. Puglisi and Paul (1997) tested the carbon/nutrient hypothesis, which postulates that the secondary metabolites produced by a certain alga are dependent on the nutrient

---

availability. They found that variation in octodene concentrations *P. hornemannii* cannot be attributed to nitrogen and phosphorus availability but suggested that instead light may be an important factor. Matlock et al. (1999) demonstrated strong site-to-site differences, variation within populations, and limited evidence for temporal variation in apakaoctodene levels. Some authors have emphasized the necessity to genotype the organisms in order to better understand the mechanisms that regulate the production of specific natural products (Bourgaud et al., 2001; Miller et al., 2001; Pietra, 2002; McGovern and Hellberg, 2003). However, within *P. hornemannii*, intraspecific genetic variation in relation to secondary metabolites has not been studied.

Recently, we found convincing evidence for a large number of cryptic species within *Portieria*, with at least 21 species occurring in the Philippines (Chapter 3). This study aims to understand how non-polar secondary metabolites of *Portieria* plants vary between cryptic species and among life stage within species. We employed metabolite fingerprinting and multivariate analysis of metabolites detected among samples collected in the Philippines. Because of the large number of detected compounds in the samples, the unavailability of commercial standards of the exotic compounds found in *Portieria* and the scarcity of compound identification resources such as mass spectral databases dedicated to marine secondary metabolites, metabolite fingerprinting was the most feasible analytical method to achieve the objective. In contrast to target analysis, metabolite profiling and metabolomics, metabolite fingerprinting does not separate individual metabolites, but instead compares spectra of whole extracts using multivariate statistics (Fiehn and Kind, 2006). Metabolite fingerprinting is particularly useful for rapid classification of samples (Fiehn, 2002). Our specific aims were to evaluate in *Portieria* spp.: 1) if there is variation of non-polar secondary metabolites between the gametophyte and tetrasporophyte life-history stages 2) if metabolite variation is due to the presence of phylogenetically distinct cryptic species, and 3) if patterns of variation are observed on a geographical and temporal level.

## 6.2 Materials and methods

### 6.2.1 Collection and Storage

Field samplings were performed at different periods in several sites in the Philippines (Fig. 6.1. a-c). Plants were collected by snorkeling and SCUBA diving depths ranging from 1-20 meters. For secondary metabolite characterization of the different life-history stages of *Portieria*, the plants used were collected randomly in Bantayan near Dumaguete (Fig. 6.1. c) in December 29, 2009. To allow both chemical characterization and life-history stage verification under the microscope, plants were blotted dry and stored in silica after collection.

Plants for secondary metabolites analysis between species were collected at 4 sites in Batanes (Basco, White Beach, Coral, and in Chavayan) (Fig. 6.1. a-b) in April 23-26, 2009. Plants were preserved in 95% ethanol in the field and placed at -23 °C afterwards. Sampling for seasonal and spatial comparison of secondary metabolites were conducted in 6 sites in the Central Visayas (Dapdap, Siquijor, Siquijor; Pagubagubaan, San Juan, Siquijor; Sawang, San Juan Siquijor; Bantayan, Dumaguete, Negros Oriental; Siaton, Negros Oriental; Liloan, Santander, Cebu (Fig. 6.1. a and Fig. 6.1. c) from 2007 to 2009. For the first 4 sites, plants were collected on a monthly basis when present and when abundant enough to afford a good amount for extraction. For sites close to the Silliman Marine Laboratory, plants were immediately packed and stored at -23 °C upon arrival. When immediate freezing was not possible, plants were preserved in 95% ethanol in the field and placed at -23 °C afterwards until extraction. Frozen plants were rinsed in freshwater or in ethanol and blotted dry.

As *Portieria* can often not be distinguished morphologically (Chapter 5), species identification was based on DNA sequence data (see below). For DNA characterization, thallus clippings were collected from specimens and stored in silica while in the field.

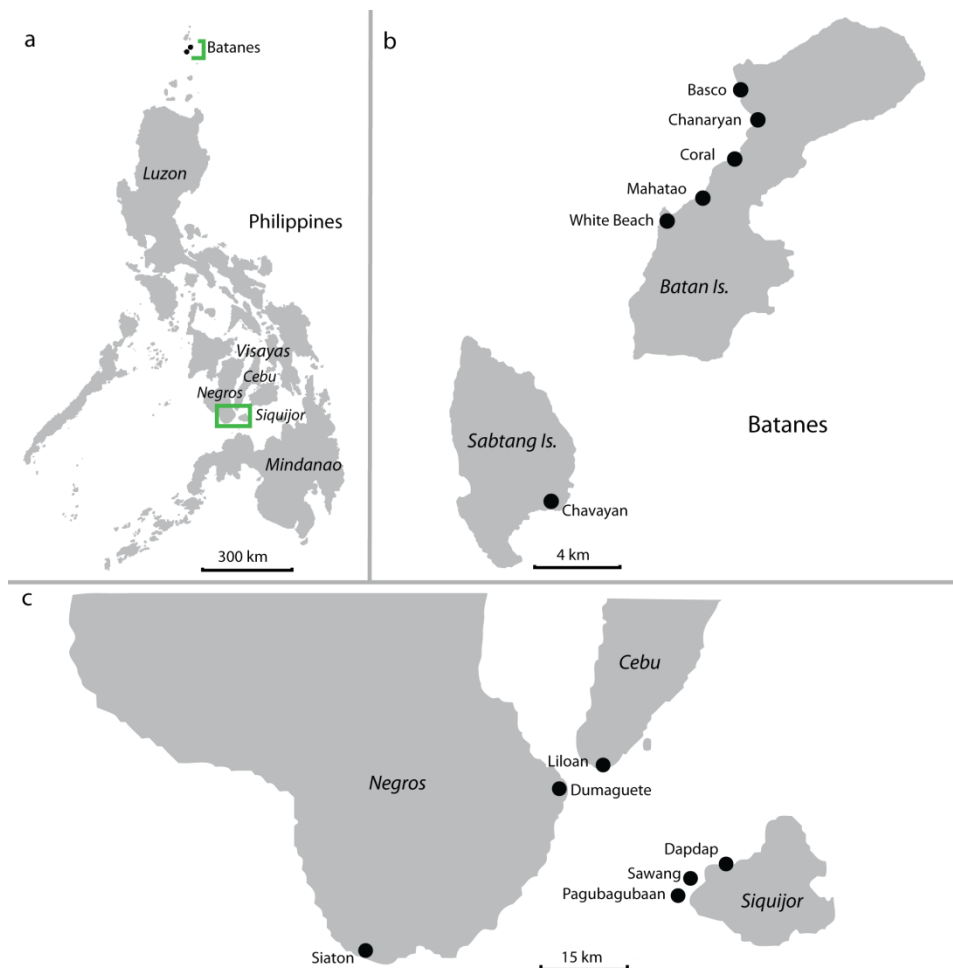

Fig. 6.1. Map of sampling sites. (a) Map of the Philippines indicating location of Batanes and Visayas. (b) Sampling sites in Batan and Sabtang Islands in Batanes. (c) Sampling sites in Siquijor, Negros, and Cebu Islands in the Visayas.

### 6.2.2 Extraction

*Life-history stages comparison.* *Portieria* has a tri-phasic isomorphic life history which includes free-living haploid male and female gametophytes, a diploid carposporophyte attached to the thallus and dependent to the female gametophyte, and a free-living diploid tetrasporophyte. Silica-dried specimens were examined under the microscope and segregated into different life-history stages (male gametophytes, female gametophytes, and tetrasporophytes). Biological replicates

each about 1 gram dry weight were prepared for every life-history stage. Tissues were ground using mortar and pestle, dissolved in 6 mL dichloromethane (DCM) containing 50  $\mu\text{g. mL}^{-1}$  naphthalene, and vortexed for a few seconds. The DCM extracts were allowed to stand at room temperature for 24 hours in screw-cap tubes. The extracts were decanted and transferred to air tight screw-cap tubes and stored at  $-23\text{ }^{\circ}\text{C}$ . The tissues were re-dissolved in DCM for another 24 hours. First and second extracts of a sample were pooled together and filtered using Whatman GF/C. The combined extracts were loaded into pre-conditioned SPE tubes containing 10 g of silica (Silicycle SiliaFlash® G60, 60-200 $\mu\text{m}$ , 60Å). Non-polar compounds were eluted using 12 mL hexane. The eluate was blown down to 0.5 mL to concentrate the sample. Three 100  $\mu\text{L}$  replicates were taken from this stock and used as technical replicates in the GC-MS analysis.

Species Comparison. The samples were extracted individually. Tissue was ground using a mortar and pestle and extracted twice in 6 mL DCM overnight. Extracts were pooled, loaded in 2 g silica and eluted using 6 mL of hexane. Eluates of 8 samples belonging to the same species, approximately weighing 10-26 g, were pooled and evaporated down to 100  $\mu\text{L}$ . To assess consistency in the GC-MS analyses, 3 technical replicates were prepared for each sample. Solvents for extraction and chromatography were HPLC grade (DCM – Mallinckrodt 4879, bp  $40\text{ }^{\circ}\text{C}$ , density 1.3266 g  $\text{cm}^{-3}$  at  $20\text{ }^{\circ}\text{C}$  or HiperSolv Chromanorm; n- Hexane - Mallinckrodt 5167, bp  $69\text{ }^{\circ}\text{C}$  or Hipersolv Chromanorm. Naphthalene Fisher N134, bp  $218\text{ }^{\circ}\text{C}$ ) and  $\beta$ -myrcene (Sigma M0382, 90% purity, bp  $167\text{ }^{\circ}\text{C}$ ) were used as internal and external standards, respectively.

Seasonal and Spatial Comparison. For seasonal analysis, plant material was ground using mortar and pestle. Twenty grams of ground material was extracted in 20 mL dichloromethane for 24 hrs at room temperature. The material was extracted a second time in 20 mL dichloromethane and the extracts were pooled. To measure the amount of green oil that is generated, one of the two pooled extracts is evaporated to dryness using nitrogen until thick green oil is visible. The oil is weighed and redissolved in 20 mL dichloromethane. The other extract is evaporated down to 20 mL. Both extracts were loaded in SPE columns containing 10 g of silica (Silicycle SiliaFlash® G60, 60-200 $\mu\text{m}$ , 60Å). Non-polar compounds were eluted from the column with 20 mL hexane and again blown down to 100  $\mu\text{L}$  to concentrate the sample. A separate aliquot of ground plant tissue was used to determine dry mass.

### 6.2.3 *Phylogenetic Analysis*

Assignment of the sampled specimens to cryptic species was based on phylogenetic analysis of the mitochondrial *cox2-3* spacer region. The phylogeny includes specimens collected from 5 sites (Basco, Chanaryan, Coral, Mahatao, Chavayan) in Batanes and 6 sites (Dapdap, Siquijor; Sawang, San Juan, Siquijor; Pagubagubaan, San Juan, Siquijor; Malo, Siaton; Bantayan, Dumaguete; Liloan, Santander) in the Visayas, Philippines. Species delineation follows the rationale outlined in Chapter 3. DNA extraction, PCR amplification, sequencing and sequence alignment were performed as described in Chapter 3. The alignment of 152 *Portieria* sequences was 345 bp long. Bayesian inference (BI) of phylogeny was performed using MrBayes v3.1.2 (Huelsenbeck and Ronquist, 2001) under a GTR + I +  $\Gamma$  model as determined by jModelTest (Posada, 2008). BI analyses consisted of two parallel runs of three incrementally heated chains and one cold chain each, and 3 million generations with sampling every 1000 generations. A burnin value of 750 was determined using TRACER V1.4 (Rambaut and Drummond, 2007).

### 6.2.4 *Metabolite analysis, data processing and multivariate analysis*

GC-MS Analysis. GC-MS analyses of the non-polar eluates were performed using Agilent 6890 gas chromatograph and Agilent 6973 mass selective detector. Sample injection volume was 1  $\mu$ L. Split injection with a split ratio of 20:1 was used. The carrier gas was helium with a total flow rate of 72.7 mL min<sup>-1</sup> and 26.20 psi column head pressure. Compounds were separated using a 30m x 0.25mm HP-5 MS non-polar capillary column (Hewlett-Packard, 5% phenyl methyl siloxane, 0.25  $\mu$ m thickness) for a run time of 67 min. under the following oven temperature program: 50 °C initial held for 2 min, then increased at a rate of 5 °C min<sup>-1</sup> to 300 °C, held for 15 min. The spectrometers were run in electron-impact mode with ionization energy of 70 eV and an ion source temperature ranging from 230-250 °C. The scan range was set to detect masses from 50-500 amu.

GC-MS Data Processing. The software AMDIS (<http://www.amdis.net>) (Meyer, 2010) was used for peak identification and deconvolution of the chromatogram. This method calculates and retrieves pure (background-free) mass spectra from raw GC-MS data files based from the parameters indicated by the user. The following parameters were used for all of the analyses: medium shape requirement, medium sensitivity, and medium resolution. The ELU files generated from AMDIS were submitted for analysis using Spectconnect (<http://spectconnect.mit.edu/>) (Styczynski et al., 2007) to generate matrices of

component peaks (relative abundance, retention time, integrated signal and base peak).

*Compound identification.* In the absence of pure standards of compounds previously isolated from *Portieria* (except for  $\beta$ -myrcene), we used Kovats indices, freely available mass spectral databases to determine identity of component peaks, and literature. We computed the Kovats or retention index of each peak using the retention times of alkane standards from C8-C20 and the Retention Index Calculator (Lucero et al., 2009). The retention index is derived from the interpolation (usually logarithmic), relating the adjusted retention volume (time) of the sample component to the adjusted retention volumes (times) of two standards eluted before and after the peak of a sample component (IUPAC definition). The calculated KI was automatically compared to the KI's of compounds stored in the built-in library of the calculator.

Mass spectra of component peaks were compared to compounds retrieved from MassBank (<http://www.massbank.jp/index.html?lang=en>), Pherobase (<http://www.pherobase.com/>), and the limited version of the NIST library in the MS Search Program and AMDIS. Mass spectra of components were inspected for similarity with those of the characteristic mass signals of components published in Andrianasolo et al., 2006, Egorin et al., 1997, and Barahona and Rorrer, 2003.

*Data standardization, metabolite fingerprinting and multivariate analyses.* Relative abundance matrices generated from the Spectconnect analyses were used for statistical analyses. A matrix contains relative abundance values of all detected components across all samples included in the analysis. The data were standardized by obtaining a ratio between the relative abundance of a component per replicate (or sample) and the total of all components per replicate (or sample). The ratios obtained among the technical replicates were subsequently averaged. Principal component analysis was performed using Statistica 7.0 (StatSoft Inc., Tulsa, OK, USA) on each dataset to detect any pattern or groupings based from the variables which are the component compounds.



---

## 6.3 Results

### 6.3.1 *Delimitation of species*

Phylogenetic analyses of 152 *cox2-3* sequences revealed 12 clades of closely related sequences, preceded by long well supported branches. Seven lineages include specimens from Batanes and 5 clades are restricted to the Visayas (Fig. 6.2). These clades will further be regarded as species (see Chapter 3 for details on species delimitation).

### 6.3.2 *Identification of compounds in non-polar extracts*

Owing to the unavailability of standard compounds and public repositories of mass spectral data specific to marine metabolites, the identity of the compounds was investigated only by comparing the mass spectra and the Kovats retention indices to those deposited in publicly available databases (MassBase, Pherobase, Lucero Library and the free limited NIST database in the MS Search Program and AMDIS). Identifications were based on a minimum of 80% similarity of mass fragments. Using the Retention Index Calculator (Lucero et al., 2009), plant volatiles with the nearest Kovats Index (KI) to that of the compounds in the samples were retrieved. The Kovats index used in the RI Calculator is based on a DB5 column similar to HP-5MS used in this study. The Lucero KI based identification was verified with the mass spectra and KIs listed in Pherobase. Comparison with mass spectra of compounds found in *Portieria* in the literature (Egorin et al., 1997; Barahona and Rorrer, 2003; Andrianasolo et al., 2006) did not reveal any positive identification. Examination of mass fragments did not show any similarity of components with that of halomon's mass spectral fragments as reported by Egorin et al. (1997).

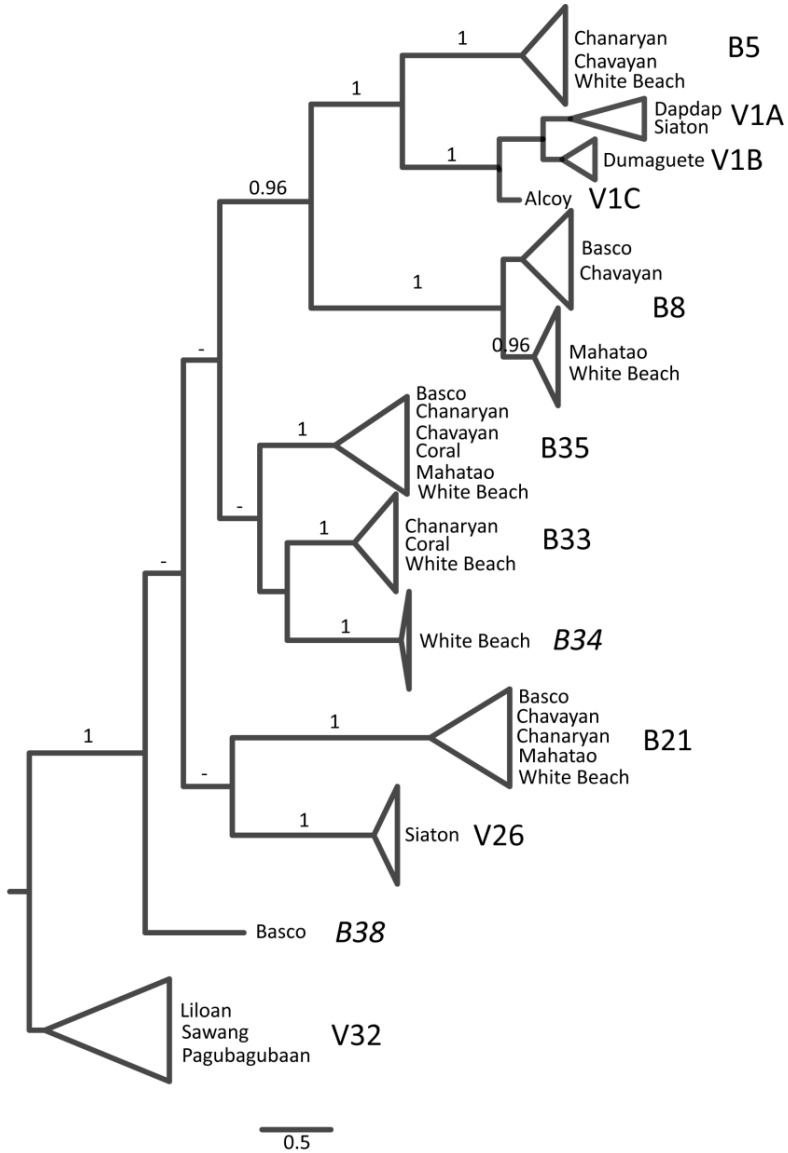

Fig. 6.2. Phylogenetic tree reconstructed using Bayesian inference based on the *cox2-3* gene of *Portieria* specimens collected from Batanes (B) and Visayas (V) Islands in the Philippines. Branch support (posterior probabilities)  $\geq 0.5$  are indicated at the branches. The eleven clades represent cryptic species. Species B34 and B38 were not included in the chemical analysis.

### 6.3.3 Metabolite Fingerprinting

#### Variation between life stages

Plants used for this study belonged to a single species V1B (Fig. 6.2.) and were collected on the same day from a single site in Bantayan, Dumaguete. A total of 202 non-polar compounds were detected from a 67 min GC-MS running time of gametophytes and tetrasporophyte samples (Fig. S6.2). Using an external standard and the databases, we confirm the presence of  $\beta$ -myrcene in the samples. This monoterpene occurs first at 6.1863 min (Fig. 6.3. a). The last peak appeared at 38.661 min. Only 11% (22) of the compounds were identified using NIST and MassBase. Based on the NIST and MassBase identifications, 5 compounds were monoterpenes. Examination of the patterns of parent ions showed 10 halogenated compounds containing 1 Cl, 1 Br or 1Cl and 1 Br. Two hundred compounds had Kovats Index ranging from 993-1969. Some peaks with succeeding retention times shared the same KI but had a different mass spectra composition. NIST and MassBase did not share the same identification of peaks except for  $\beta$ -myrcene. KI for the last two peaks were not computed since it occurred later than the last alkane standard (C20 at 31.226 min) that was used for KI calculation. We also explored the potential of the Lucero library and Pherobase to identify compounds that *Portieria* might have in common with land plants.

The Lucero library in the RI Calculator retrieved the nearest KIs of plant volatiles. Some of these identifications were verified at Pherobase, but mass spectra composition of the unidentified peaks was not similar to the spectra of the compound name retrieved from the database. Furthermore, we also tried to retrieve compounds with a certain KI and examined the corresponding spectra.  $\beta$ -myrcene has a KI of 993.543 in this study. Pherobase listed 991 and 994 as KIs for  $\beta$ -myrcene in a DB5 column. Nine compounds listed in the database have a KI of 993.

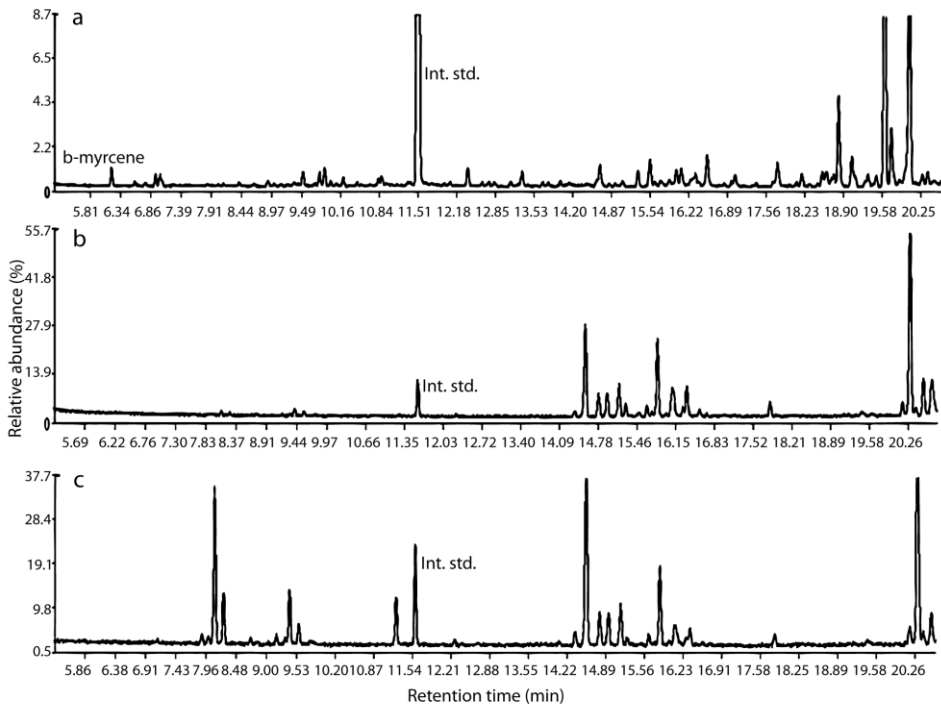

Fig. 6.3. Portion of GC-MS total ion chromatograms of non-polar extracts of *Portieria* samples (a) male gametophyte from Bantayan (Dumaguete), V1 (b) White Beach, Batanes, B21 (c) Liloan, V32.  $\beta$ -myrcene, a precursor of many halogenated monoterpenes, was detected only in the Bantayan specimens. Naphthalene is used as an internal standard.

The Lucero library lists KI 993 for  $\beta$ -myrcene. With the large number of metabolites retrieved, this method of verification proved cumbersome especially since Pherobase currently does not allow automated mass spectral and Kovat indices comparison. Of the 202 compounds detected, 155 compounds were present in the female samples, 102 in male plants and 106 in tetrasporophytes (Fig. 6.4a). There were 55 compounds that were shared by all life stages. Sixty-three compounds were found exclusively in female gametophyte extracts, 15 in male gametophyte extracts, and 18 in tetrasporophyte extracts. There were 14 compounds common to male and tetrasporophyte extracts. The male and female gametophyte shared 18 compounds while female and tetrasporophyte shared 19 compounds. A precursor compound of the monoterpenes, myrcene, was detected in all of the life stages but not in all replicates.

We applied a principal component analysis (PCA) on the standardized relative abundances to determine if metabolites differ among life stages (Fig. 6.5a).

The matrix contained 202 compounds (active variables) and 10 samples (active cases: six female gametophytes, 2 male gametophytes, and 2 tetrasporophytes). Fig. 6.5a shows the projection of the cases on the factor plane. Factor 1 and factor 2 accounts for 20.42% and 14.37% of the variation, respectively. Factor 1 clearly discriminates the male gametophyte samples. The gametophyte and tetrasporophyte samples are partially separated. Factor 2 does not discriminate between life stages but points towards additional variation within life stages.

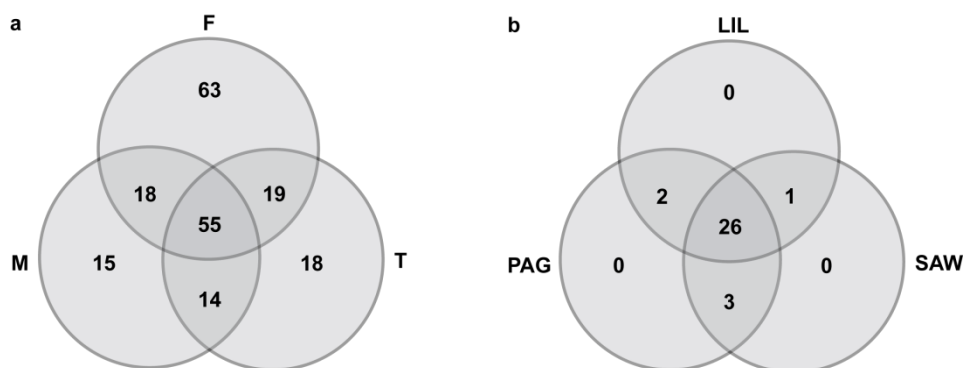

Fig. 6.4. Frequency distribution indicating number of shared and unique non-polar secondary metabolites. (a) within life-history stages of Bantayan specimens (b) species V32 of the Visayas specimens.

### Variation between cryptic species

A total of 67 compounds were detected from 9 samples (3 technical replicates) in a 67 minute GC-MS running time (Table S6.3).

These samples belonged to 5 species, as determined by DNA sequence analysis. A sample consists of pooled extract of 8 individuals belonging to one species as verified by DNA analysis.  $\beta$ -myrcene was not detected in the samples (Fig. 6.3. b). The first compound appeared later at 8.112 min, and the last peak appeared at 50.7731 min. The three databases used (NIST, MassBase, Lucero library) did not give identical identifications of compounds. NIST identified 4 compounds appearing at different times as 3-Hexanone, 2, 2-dimethyl. Comparison of mass spectra with MassBase resulted in the retrieval of straight and branched alkanes and alkenes. Compounds with retention times from 8.1122 to 30.6929 min had retention indices from 1065 to 1965. No KIs were computed for the rest of the compounds. Comparison of computed retention indices with those in Lucero library, component compounds from this batch of samples contained

monoterpenes, sesquiterpenes, esters, fatty acids and alcohols. NIST, MassBase and the Lucero databases did not share the same identification of compounds. Visual examination of parent ions showed only 2 compounds to be halogenated containing either 1 Cl or 1 Br.

The number of compounds detected varied between the 5 species (Table 6.1) and among biological replicates. Species B35 had the highest number of compounds, 60 out of the total 67 detected. Species 21 had the least number of compounds (49). Species B33 had 51 compounds detected in its samples. Species B8 and B5 both had 57 compounds detected. There were 21 compounds that were detected in all of the 9 samples while 33 compounds were present in all 5 species. Unique compounds were only found in species B33 (peak at 43.7727min and base peak 85mz) and B8 (peak at 44.3901min and base peak 85mz) (Table 6.1).

To detect distinct groupings, we conducted a principal component analysis using the standardized relative abundances of the 9 samples using the 67 compounds as variables (Fig. 6.5b). The first principal axis accounted for 27.4% of the variance while the second 16.0%. Plotted scores from PCA did not show distinct interspecific clusters. The largest variation was displayed by specimens belonging to species 5.

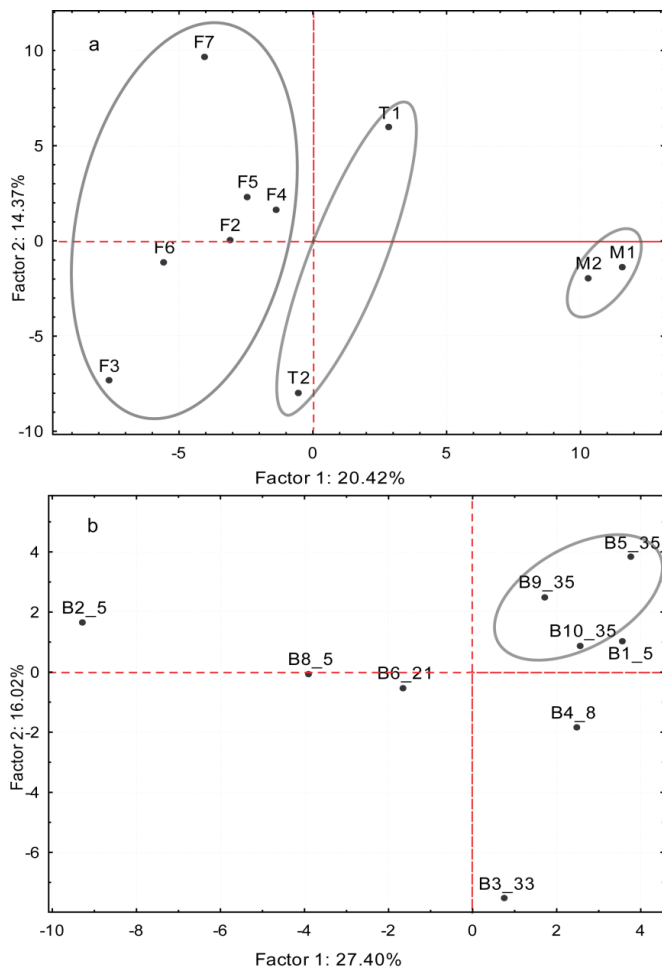

Fig. 6.5. Principal component analysis of GC-MS standardized relative abundance datasets which includes the compounds detected in a 67-minute run of *Portieria* extracts. (a) Male gametophyte (M1-2) samples are clearly discriminated occurring at the positive end of the plane while female gametophyte (F2-7) and tetrasporophyte samples (T1-2) are only partially discriminated by Factor 1. (b) Batanes dataset includes 5 cryptic species. The clustering of B35 replicates and the scattered pattern of B5 suggest variation in component compounds exists between species but at the same time suggested that variation within species can occur.

Table 6.1. Frequency of compounds that are unique to or common to several species of *Portieria* found in Batanes. Values in parenthesis indicate total number of compounds found in a species, while 1 indicates presence and 0 absence of a compound.

B21 (49)	B33 (51)	B35 (60)	B8 (57)	B5 (57)	Frequency (67)
0	0	0	1	0	1
0	0	1	1	0	3
0	0	1	1	1	3
0	1	0	0	0	1
0	1	0	1	0	2
0	1	1	1	0	1
0	1	1	1	1	7
1	0	1	0	1	3
1	0	1	1	0	2
1	0	1	1	1	4
1	1	0	0	1	2
1	1	0	1	1	1
1	1	1	0	1	4
1	1	1	1	1	33

### Spatial and Temporal Variation

Six sites in the Visayas were sampled from 2007 to 2009: Sawang, Pagubagubaaan, Dapdap, Siaton, Liloan and Bantayan (Dumaguete). The two latter sites were sampled only once and twice, respectively. The objective was to determine if seasonality or geography explained the variation in secondary metabolites. Our DNA analyses showed that the *Portieria* specimens from these sites belong to 4 cryptic species (V1A, V1B, V26, and V32) (Fig. 6.2. ). Samples from Sawang, Pagubagubaaan, and Liloan can be classified as one species (V32). Dapdap and Dumaguete specimens belong to species V1A and V1B, respectively. Two species (V1A & V26) were found in Siaton, but for this experiment, it was not possible to distinguish the samples into species. Our geographical and seasonal analyses on the datasets took the DNA results in consideration. Spectconnect analysis included GC-MS profile of 44 *Portieria* extracts from 6 sites. A total of 33 compounds were detected from these samples (Table 6.2).  $\beta$ -myrcene was also not detected (Fig. 6.3. c). The first peak appeared later at 8.1118 min while the last peak appeared at 47.6237 min. As in previous datasets, the three databases (NIST, MassBase, Lucero library) used did not result in identical identifications of



---

compounds. Comparison of mass spectra with MassBase resulted in the retrieval of straight and branched alkanes and alkenes. Eleven compounds with retention times 8.1118 to 30.4069 min had Kovats indices from 1065 to 1950. The rest of the compounds had longer retention times than the last alkane (icosane, C<sub>20</sub>) in the standard at 31.4226 min. Hence no KIs were computed. The comparison of computed retention indices with those in Lucero library retrieved compounds which are monoterpenes, sesquiterpenes, esters and fatty acids. NIST library identified 2 compounds appearing at different times as 3-hexanone, 2, 2-dimethyl and one as disilane. Visual examination of parent ions showed no hints of halogenated compounds. To detect distinct groupings, we conducted principal components analysis using the standardized relative abundance file from Spectconnect of all the 44 samples using the 33 compounds as variables (Fig. 6.6a).

Table 6.2. Compound peaks detected from GC-MS analysis of samples used for evaluation of temporal and spatial patterns of non-polar metabolites of 3 cryptic species of *P. bornemannii* found in the Visayas. Identifications based on comparison of either Kovats Indices (KI) of compounds retrieved from the Retention Index Calculator (Lucero et al. 2009) or mass spectral comparison of compounds retrieved from NIST or MassBase. Asterisk (\*) indicates compounds with parent ions showing halogenated mass spectral patterns.

#	Sample	Base Peak	RT	KI	Nearest KI	KI based ID	Mass spectra based ID
						Lucero et al. 2008	Massbase
1	3A	57	8.1118	1065	1062	y-terpinene	undecane
2	15A	57	14.556	1285	1286	borneol acetate	1-nonene
3	9A	57	14.556	1285	1286	borneol acetate	pentacosane
4	29A	57	20.3128	1500	1499	a-murolene	tricosane
5	15B	71	20.5458	1510	1509	$\beta$ -bisabolene	3-ethylpentane
6	15A	57	25.186	1705	1686	8-cedren-13-ol	-
7	34A	57	25.4206	1716	1735	oplopanone	-
8	15B	71	26.6674	1772	1761	benzyl-benzoate	2-methylbutane
9	15A	57	27.8534	1827	1827	isopropyl tetradecanoate	
10	44BB	71	30.0015	1930	1927	methyl hexadecanoate	docosane
11	8B	57	30.4069	1950	1927	methyl hexadecanoate	
12	15B	71	31.6111	-	-	-	-
13	15A	57	31.8326	-	-	-	-
14	15B	57	31.8342	-	-	-	1,4-dimethylhexane
15	44BA	71	34.1535	-	-	-	docosane
16	15B	71	34.2967	-	-	-	3-ethylpentane
17	15A	57	34.76	-	-	-	1-octene
18	15A	71	35.4496	-	-	-	2-methylbutane
19	15B	57	35.5757	-	-	-	-
20	15B	57	35.5757	-	-	-	2,2-dimethylbutane
21	44BA	71	37.9407	-	-	-	docosane
22	15B	410	38.2743	-	-	-	-
23	15A	71	39.3484	-	-	-	3-ethylhexane
24	15A	71	40.0877	-	-	-	2,2-dimethylbutane
25	15A	71	40.0981	-	-	-	beta-Aminopropionitrile
26	15B	71	42.5358	-	-	-	2-methylbutane
27	15B	57	43.9626	-	-	-	4-methyloctane
28	44C	71	44.6454	-	-	-	-
29	15A	57	45.2255	-	-	-	2,2-dimethylbutane

Table 6.2. Continued.

30	15A	71	47.3529	-	-	-	-
31	15B	57	47.3534	-	-	-	-
32	15B	57	47.3581	-	-	-	2,4-dimethylpentane
33	15A	71	47.6237	-	-	-	2,4-dimethylhexane

The first and second principal component accounted for 17.87% and 17.78% of the variance, respectively. No clear groupings could be deduced based on species, sampling period, or sampling site. Most of the samples clumped except for 2 Bantayan and 1 Siaton samples which were clearly separated from the rest. A PCA excluding the 3 samples slightly spread the rest of the samples but likewise did not show any recognizable clusters (a). This time, the first and second principal component accounted for 19.15% and 13.98% of the variance, respectively. The analysis showed that same species samples occur widespread on the axes and did not show any pattern based on site or period of collection. A separate PCA analysis was conducted on samples belonging to the same species, i.e. species V32 from Sawang, Pagubagubaan, and Liloan (Fig. 6.6b). The first and second principal components accounted 21.36% and 14.96% of the variance, respectively. No clusters based on site or period of collection were detected from this analysis.

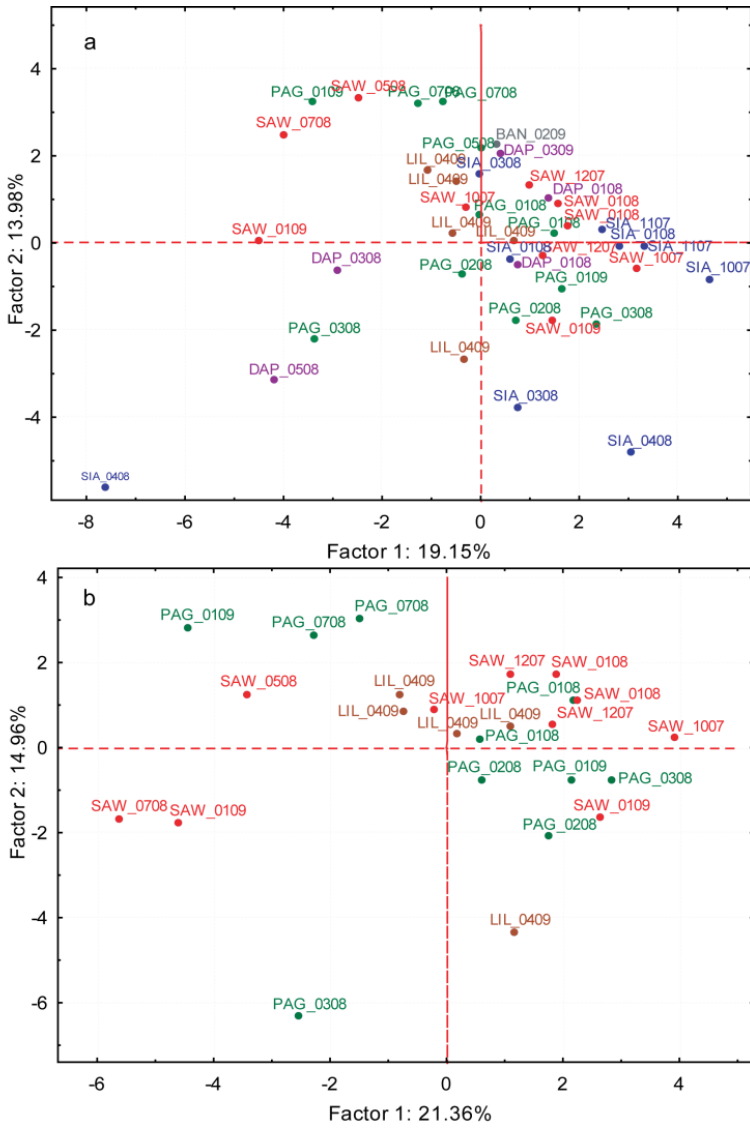

Fig. 6.6. Principal component analysis of GC-MS standardized relative abundance datasets for detecting possible spatial and temporal patterns in (a) the Visayas species (b) the Visayas samples belonging to species V32. Letters indicate sampling site (DAP: Dapdap; PAG: Pagubagubaan; SAW: Sawang; SIA: Siaton) and numbers indicate month and year of sampling.

## 6.4 Discussion

Distribution of secondary metabolites in marine macroalgae exhibit macroscale and microscale patterns (Pelletreau and Targett 2008). Macroscale patterns include global patterns within or across algal taxa, patterns within a specific habitat, and patterns correlated with biotic and abiotic factors. Microscale patterns are related to molecular and biochemical processes within an algal thallus, the spatial distribution of compounds within an algal thallus and temporal responses (short- and long-term responses). In *Portieria* macro- or microscale patterns of secondary metabolite variation has not been fully explored. Three decades of studies have been dedicated to the isolation of new compounds. Only two studies have attempted to understand variation of these compounds, mainly focusing on target monoterpenes (ochtodene; Apakaochtodene A and B) (Puglisi and Paul, 1997; Matlock et al., 1999). The present study aimed to understand the variation on a macroscale level. It is now clear that *P. hornemannii* is not a single species but harbors genetically distinct entities that can be classified as cryptic species.

While most studies focusing on marine secondary metabolites attempt to address variation of a single compound, this study has focused on the non-polar secondary metabolites of *Portieria* as a whole. However, a possible drawback related to the preceding method is the fact that the compounds are not mutually independent but their relative presences are linked by biological pathways. For example, the presence of myrcene, which is the likely precursor of many monoterpenes (Wise et al., 2002), influences the presence or absence of other halogenated monoterpene components. Hence to understand general or specific metabolite patterns might also require knowledge of the presence and absence of progenitor component compounds. For the purposes of this study, the use of entire spectra using metabolite fingerprinting has proven to be a pragmatic method for gaining a broader view of secondary metabolite patterns in this alga.

Reports on intraspecific variation of secondary metabolites in macroalgae have been based on variations within individuals, between individuals of a population and among geographically isolated populations (Thornber et al., 2006; Verges et al., 2008). Our results suggest substantial intraspecific variation among the life-history stages of *Portieria*. Male gametophytes form a clearly distinct group, while a partial discrimination was detected between female gametophytes and tetrasporophytes. Furthermore, our results show that female gametophytes are chemically richer in terms of the number of secondary metabolites. It is possible that such higher number of metabolites is due to the combined deterrent effects of

such compounds on grazers as part of the maternal protection it provides to the carposporophyte. Many of the compounds detected appear to occur exclusively to a certain life-history stage while a relatively small group of compounds is shared among life-history stages. Evidence of secondary metabolite variation within life-history stages has also been observed in another red alga (*Asparagopsis armata*) and more recently in a brown alga (*Dictyota menstrualis*) (Verges et al., 2008; Cavalcanti et al., 2010). Similar to our study, male gametophytes of *A. armata* were found to have lower concentration of the secondary metabolite (bromoform) compared to the female gametophyte. It has also been observed that the carposporophyte phase *A. armata* was the least consumed life-history phase by the seahare, *Aplysia parvula* (Verges et al., 2008). Likewise, in the brown alga *Dictyota menstrualis*, female gametophytes were found to produce more diterpenes compared of the other stages.

Comparative analyses of the 5 cryptic species from Batanes (B5, B21, B33, B35, and B8) showed variation between, as well as within species. Intraspecific variation is even more pronounced in the Visayas dataset. Neither species specific nor spatio-temporal patterns were evident. In addition, a separate PCA including only specimens of species V32 (Fig. 6.4b) did not elucidate patterns based on collection site or period. The results suggest that life-history caused variations combined with microscale factors have a large influence on the variation within *Portieria* species. Pelletreau and Targett (2008) pointed out that the existence of inducible and activated defenses complicates the search for universal patterns of secondary metabolites and continues to highlight the importance of localized phenomena.

Finally, there was difficulty in achieving unequivocal identification of compounds in this study unveiling the need for mass spectral and KI databases dedicated solely to marine secondary metabolites. Such repositories will assist in the identification of previously reported compounds for investigations mainly focused on rapid detection and understanding of chemical patterns in marine organisms. In doing so, future studies will not just be focused in isolating and naming novel compounds as had been the trend in *Portieria* but will also seek to answer questions that are of biological or ecological in nature. Furthermore, the presence of cryptic species in *P. hornemannii* highlights the need to genotype organisms. In this way, the correct species that produced a chemical of interest can be tracked down in succeeding studies.

## 6.5 Acknowledgements

The authors are grateful to Abner Bucol, Zacharias Generoso and Jacinta Lucañas of IEMS- Silliman University for field assistance, Batanes MENRO Francis Domingo for field and dive assistance, Renaat Dasseville for the valuable technical assistance on GC-MS, Frederik Lynen and his lab for the helpful suggestions and access to GC-MS and HPLC machines during the exploratory period of the chemical analysis. Funding for this research was provided by the Flemish Interuniversity Council (VLIR) as part of the PhD Grant to D.A. Payo.





## 6.6 References

- Andrianasolo, E.H., France, D., Cornell-Kennon, S., Gerwick, W.H., 2006. DNA methyl transferase inhibiting halogenated monoterpenes from the Madagascar red marine alga *Portieria bornemannii*. *J. Nat. Prod.* 69, 576-579.
- Barahona, L.F., Rorrer, G.L., 2003. Isolation of halogenated monoterpenes from bioreactor-cultured microplantlets of the macrophytic red algae *Ochtodes secundiramea* and *Portieria bornemannii*. *J. Nat. Prod.* 66, 743.
- Bhadury, P., Wright, P.C., 2004. Exploitation of marine algae: biogenic compounds for potential antifouling applications. *Planta* 219, 561-578.
- Bhat, S.V., Nagasampagi, B.A., Sivakumar, M., 2005. Chemistry of natural products. Narosa Pub House.
- Blunt, J.W., Copp, B.R., Hu, W.P., Munro, M.H.G., Northcote, P.T., Prinsep, M.R., 2007. Marine natural products. *Nat. Prod. Rep.* 24, 31-86.
- Bourgaud, F., Gravot, A., Milesi, S., Gontier, E., 2001. Production of plant secondary metabolites: a historical perspective. *Plant Sci.* 161, 839-851.
- Burreson, B.J., Woolard, F.X., Moore, R.E., 1975a. Chondrocole A and B, two halogenated dimethylhexahydrobenzofurans from the red alga (mertens) schmitz. *Tetrahedron Lett.* 16, 2155-2158.
- Burreson, B.J., Woolard, F.X., Moore, R.E., 1975b. Evidence for the biogenesis of halogenated myrcenes from the red alga *Chondrococcus bornemannii*. *Chem. Lett.* 4, 1111-1114.
- Cavalcanti, D.N., de Oliveira, M.A.R., De-Paula, J.C., Barbosa, L.S., Fogel, T., Pinto, M.A., de Palmer Paixão, I.C.N., Teixeira, V.L., 2010. Variability of a diterpene with potential anti-HIV activity isolated from the Brazilian brown alga *Dictyota menstrualis*. *J. Appl. Phycol.*, 1-4.
- Coll, J.C., Wright, A.D., 1987. Tropical marine algae. 1. New halogenated monoterpenes from *Chondrococcus bornemannii* (Rhodophyta, Gigartinales, Rhizophyllidaceae). *Aust. J. Chem.* 40, 1893-1900.
- Coll, J.C., Wright, A.D., 1989. Tropical marine algae. 6. New monoterpenes from several collections of *Chondrococcus bornemannii* (Rhodophyta, Gigartinales, Rhizophyllidaceae). *Aust. J. Chem.* 42, 1983-1993.
- De Clerck, O., Gavio, B., Fredericq, S., Cocquyt, E., Coppejans, E., 2005. Systematic reassessment of the red algal genus *Phyllymenia* (Halymeniaceae, Rhodophyta). *Eur. J. Phycol.* 40, 169-178.
- Dworjanyn, S.A., De Nys, R., Steinberg, P.D., 1999. Localisation and surface quantification of secondary metabolites in the red alga *Delisea pulchra*. *Mar. Biol.* 133, 727-736.
- Egorin, M.J., Rosen, D.M., Benjamin, S.E., Callery, P.S., Sentz, D.L., Eiseman, J.L., 1997. In vitro metabolism by mouse and human liver preparations of halomon, an antitumor halogenated monoterpene. *Cancer Chemother. Pharmacol.* 41, 9-14.
- Fenical, W., 1975. Halogenation in the Rhodophyta: a review. *J. Phycol.* 11, 245-259.
- Fiehn, O., 2002. Metabolomics - the link between genotypes and phenotypes. *Plant Mol. Biol.* 48, 155-171.
- Fiehn, O., Kind, T., 2006. Metabolite profiling in blood plasma. In: Weckwerth, W. (Ed.), *Methods in Molecular Biology, Metabolomics: Methods and Protocols*. Humana Press, Totowa, NJ, pp. 3-17.
- Fuller, R.W., Cardellina, J.H., Jurek, J., Scheuer, P.J., Alvaradolindner, B., McGuire, M., Gray, G.N., Steiner, J.R., Clardy, J., Menez, E., Shoemaker, R.H., Newman, D.J., Snader, K.M., Boyd, M.R., 1994. Isolation and structure activity features of halomon-related antitumor monoterpenes from the red alga *Portieria bornemannii*. *J. Med. Chem.* 37, 4407-4411.
- Fuller, R.W., Cardellina, J.H., Kato, Y., Brinen, L.S., Clardy, J., Snader, K.M., Boyd, M.R., 1992. A pentahalogenated monoterpene from the red alga *Portieria bornemannii* produces a novel cytotoxicity profile against a diverse panel of human tumor cell lines. *J. Med. Chem.* 35, 3007-3011.

- Gribble, G.W., 2003. The diversity of naturally produced organohalogens. *Chemosphere* 52, 289-297.
- Guindon, S., Dufayard, J.F., Hordijk, W., Lefort, V., Gascuel, O., 2009. PhyML: fast and accurate phylogeny reconstruction by maximum likelihood. *Infect Genet Evol* 9, 384-385.
- Gunatilaka, A.A.L., Paul, V.J., Park, P.U., Puglisi, M.P., Gitler, A.D., Eggleston, D.S., Haltiwanger, R.C., Kingston, D.G.L., 1999. Apakaoctodenes A and B: two tetrahalogenated monoterpenes from the red marine alga *Portieria bornemannii*. *J. Nat. Prod* 62, 1376-1378.
- Hall, T.A., 1999. BioEdit: a user-friendly biological sequence alignment editor and analysis program for Windows 95/98/NT. *Nucl. Acids. Symp. Ser* 41, 95-98.
- Hay, M.E., Fenical, W., 1996. Chemical ecology and marine biodiversity: insights and products from the sea. *Oceanography* 9.
- Higa, T., 1985. 2-(1-chloro-2-hydroxyethyl)-4, 4-dimethylcyclohexa-2, 5-dienone: a precursor of 4, 5-dimethylbenzo [b] furan from the red alga *Desmia bornemannii*. *Tetrahedron Lett.* 26, 2335-2336.
- Huelsenbeck, J.P., Ronquist, F., 2001. MRBAYES: Bayesian inference of phylogenetic trees. *Bioinformatics* 17, 754-755.
- Ichikawa, N., Naya, Y., Enomoto, S., 1974. New halogenated monoterpenes from *Desmia (Chondrococcus) bornemannii*. *Chem. Lett.* 3, 1333-1336.
- Ichikawa, N., Naya, Y., Enomoto, S., 1975. Halogenated monoterpene derivatives from *Desmia (Chondrococcus) japonicus*. *Proceedings of the Japan Academy* 51, 562-565.
- Kamenarska, Z., Ivanova, A., Stancheva, R., Stoyneva, M., Stefanov, K., Dimitrova-Konaklieva, S., Popov, S., 2006. Volatile compounds from some Black Sea red algae and their chemotaxonomic application. *Bot. Mar.* 49, 47-56.
- Katoh, K., Misawa, K., Kuma, K.-i., Miyata, T., 2002. MAFFT: a novel method for rapid multiple sequence alignment based on fast Fourier transform. *Nucl. Acids Res.* 30, 3059-3066.
- Kladi, M., Vagias, C., Roussis, V., 2004. Volatile halogenated metabolites from marine red algae. *Phytochem. Rev.* 3, 337-366.
- Kuniyoshi, M., Oshiro, N., Miono, T., Higa, T., 2003. Halogenated monoterpenes having a cyclohexadienone from the red alga *Portieria bornemannii*. *J. Chin. Chem. Soc.* 50, 167-170.
- Lucero, M., Estell, R., Tellez, M., Frederickson, E., 2009. A retention index calculator simplifies identification of plant volatile organic compounds. *Phytochem. Anal.* 20, 378.
- Matlock, D.B., Ginsburg, D.W., Paul, V.J., 1999. Spatial variability in secondary metabolite production by the tropical red alga *Portieria bornemannii*. *Hydrobiologia* 399, 267-273.
- McGovern, T.M., Hellberg, M.E., 2003. Cryptic species, cryptic endosymbionts, and geographical variation in chemical defences in the bryozoan *Bugula neritina*. *Mol. Ecol.* 12, 1207-1215.
- Meyer, M.R., 2010. Automated mass spectral deconvolution and identification system for GC-MS screening for drugs, poisons, and metabolites in urine. *Clin. Chem.* 56, 1-10.
- Miller, K., Alvarez, B., Battershill, C., Northcote, P., Parthasarathy, H., 2001. Genetic, morphological, and chemical divergence in the sponge genus *Latrunculia* (Porifera: Demospongiae) from New Zealand. *Mar. Biol.* 139, 235-250.
- Pelletreau, K.N., Targett, N.M., 2008. New perspectives for addressing patterns of secondary metabolites in marine macroalgae. *Algal Chemical Ecology*, 121-146.
- Pietra, F., 2002. Biodiversity and Natural Product Diversity. Pergamon, Trento.
- Posada, D. 2008. jModelTest: Phylogenetic Model Averaging. *Mol. Biol. Evol.* 25:1253-1256.
- Puglisi, M.P., Paul, V.J., 1997. Intraspecific variation in the red alga *Portieria bornemannii*: monoterpene concentrations are not influenced by nitrogen or phosphorus enrichment. *Mar. Biol.* 128, 161-170.
- Rambaut, A., Drummond, A.J., 2007. Tracer v1.4.  
Available free from <http://beast.bio.ed.ac.uk/Tracer>.
- Smit, A.J., 2004. Medicinal and pharmaceutical uses of seaweed natural products: a review. *J. Appl. Phycol.* 16, 245-262.
- Styczynski, M.P., Moxley, J.F., Tong, L.V., Walther, J.L., Jensen, K.L., Stephanopoulos, G.N., 2007. Systematic identification of conserved metabolites in GC/MS data for metabolomics and biomarker discovery. *Anal. Chem.* 79, 966-973.

- 
- Thornber, C., Stachowicz, J.J., Gaines, S., 2006. Tissue type matters: selective herbivory on different life history stages of an isomorphic alga. *Ecology* 87, 2255-2263.
- Verges, A., Paul, N.A., Steinberg, P.D., 2008. Sex and life-history stage alter herbivore responses to a chemically defended red alga. *Ecology* 89, 1334-1343.
- Williams, D.H., Stone, M.J., Hauck, P.R., Rahman, S.K., 1989. Why are secondary metabolites (natural products) biosynthesized? *J. Nat. Prod.* 52, 1189-1208.
- Wise, M.L., 2003. Monoterpene biosynthesis in marine algae. *Phycologia* 42, 370-377.
- Wise, M.L., Rorrer, G.L., Polzin, J.J., Croteau, R., 2002. Biosynthesis of marine natural products: isolation and characterization of a myrcene synthase from cultured tissues of the marine red alga *Ochtodes secundiramea*. *Arch. Biochem. Biophys.* 400, 125-132.
- Woolard, F.X., Moore, R.E., Mahendran, M., Sivapalan, A., 1976. (-)-3-Bromomethyl-3-chloro-7-methyl-1, 6-octadiene from Sri Lankan *Chondrococcus bornemanni*. *Phytochemistry* 15, 1069-1070.
- Wright, A.D., König, G.M., Sticher, O., De Nys, R., 1991a. Five new monoterpenes from the marine red alga *Portieria bornemannii*. *Tetrahedron* 47, 5717-5724.
- Wright, A.D., König, G.M., Sticher, O., 1991b. Five new monoterpenes from the marine red alga *Portieria bornemannii*. *Tetrahedron* 47, 5717-5724.
- Zuccarello, G.C., Burger, G., West, J.A., King, R.J., 1999. A mitochondrial marker for red algal intraspecific relationships. *Mol. Ecol.* 8, 1443-1447.

## 6.7 Supplementary tables

Table S6.1. List of compounds isolated from *Portieria* (syn. *Desmia* and *Chondrococcus*) *bornemannii*, based on previous studies.

Reference	Cpd #	Name	mol. formula	Description	Specimen source
(Ichikawa et al., 1974)	1	myrcene	C <sub>10</sub> H <sub>16</sub>	acyclic halogenated monoterpene	Amami Is., Japan
	2	7-chloro-myrcene	C <sub>10</sub> H <sub>15</sub> Cl	"	"
	3	7-bromo-myrcene	C <sub>10</sub> H <sub>15</sub> Br	"	"
	4	( <i>Z</i> )-10-bromo-myrcene	C <sub>10</sub> H <sub>15</sub> Br	"	"
	5	( <i>E</i> )-10-bromo-myrcene	C <sub>10</sub> H <sub>15</sub> Br	"	"
	6	( <i>Z</i> )-10-bromo-7-chloro-myrcene	C <sub>10</sub> H <sub>14</sub> BrCl	"	"
	7	( <i>E</i> )-10-bromo-7-chloro-myrcene	C <sub>10</sub> H <sub>14</sub> BrCl	"	"
	8	3-chloro-7, ( <i>Z</i> )-10-dibromo-myrcene	C <sub>10</sub> H <sub>13</sub> Br <sub>2</sub> Cl	"	"
	9	( <i>Z</i> )-10-chloro-3,7-dibromo-myrcene	C <sub>10</sub> H <sub>13</sub> Br <sub>2</sub> Cl	"	"
	10	3-bromo-7-chloro-myrcene	C <sub>10</sub> H <sub>14</sub> BrCl	"	"
	11	7-bromo-10-chloro-myrcene	C <sub>10</sub> H <sub>14</sub> BrCl	"	"
	12	-	C <sub>10</sub> H <sub>15</sub> Br	cyclic halogenated monoterpene	"
(Burreson et al., 1975a)	1	chondrocole A	C <sub>10</sub> H <sub>14</sub> BrClO	"	Hawaii
	2	chondrocole B	C <sub>10</sub> H <sub>14</sub> BrClO	"	Hawaii
(Burreson et al., 1975b)	3	-	C <sub>10</sub> H <sub>15</sub> Cl <sub>3</sub> Br <sub>2</sub>	acyclic halogenated monoterpene	Black Point, Oahu, Hawaii
	4	-	C <sub>10</sub> H <sub>16</sub> Cl <sub>3</sub> Br	"	"
	5	-	C <sub>10</sub> H <sub>15</sub> Cl <sub>2</sub> Br	"	"
	6	-	C <sub>10</sub> H <sub>16</sub> Cl <sub>2</sub> Br <sub>2</sub>	"	Halona Blowhole Is, Oahu, Hawaii
	10	-	C <sub>10</sub> H <sub>16</sub> Cl <sub>2</sub> Br <sub>2</sub>	acyclic halogenated monoterpene	"
	11	6-bromo-2-chloromyrcene	C <sub>10</sub> H <sub>15</sub> ClBr	"	Black Point, Oahu, Hawaii
	12	chondrocole c	C <sub>10</sub> H <sub>14</sub> Br <sub>2</sub> O	cyclic halogenated monoterpene	"
	13	-	C <sub>10</sub> H <sub>15</sub> Cl <sub>3</sub> Br <sub>2</sub>	acyclic halogenated monoterpene	Hawaii
	14	<i>Z</i> -3-bromomethylene-7-methyl-1,6-octadiene	C <sub>10</sub> H <sub>16</sub> ClBr <sub>2</sub>	"	Halona Blowhole Is, Oahu, Hawaii

Table S6.1. Continued

	15	-	C <sub>10</sub> H <sub>14</sub> Br <sub>2</sub> Cl <sub>2</sub>	cyclic halogenated monoterpene	"
(Ichikawa et al., 1975)	1	myrcene	C <sub>10</sub> H <sub>16</sub>	acyclic halogenated monoterpene	Kada Coast, Wakayama Pref., Japan
	2	7-chloro-myrcene	C <sub>10</sub> H <sub>15</sub> Cl	"	"
	3	7-bromo-myrcene	C <sub>10</sub> H <sub>15</sub> Br	"	"
	4	3,7-dichloro-myrcene	C <sub>10</sub> H <sub>14</sub> Cl <sub>2</sub>	"	"
	5	( <i>Z</i> )-10-bromo-3-methoxy- $\alpha$ -myrcene	C <sub>11</sub> H <sub>17</sub> OBr	"	"
	6	( <i>E</i> )-10-bromo-3-methoxy- $\alpha$ -myrcene	C <sub>11</sub> H <sub>17</sub> OBr	"	"
	7	3-bromo-7-chloro-myrcene	C <sub>10</sub> H <sub>14</sub> BrCl	"	"
	8	( <i>Z</i> )-10-bromo-1-methoxy-myrcene	C <sub>11</sub> H <sub>17</sub> OBr	"	"
	9	( <i>E</i> )-10-bromo-1-methoxy-myrcene	C <sub>11</sub> H <sub>17</sub> OBr	"	"
(Woolard et al., 1976)		(-)-3-bromomethyl-3-chloro-7-methyl-1, 6-octadiene	C <sub>10</sub> H <sub>16</sub> BrCl	"	Trincomalee (Foul Point) Sri Lanka
(Higa, 1985)		2-(1-chloro-2-hydroxyethyl)-4, 4-dimethylcyclohexa-2, 5-dienone: a precursor of 4, 5-dimethylbenzo [b] furan	-	-	-
(Coll and Wright, 1987)	1	( <i>2Z</i> , <i>6E</i> )- 1, 8- dichloro-3-chloromethyl-7-methylocta-2,6-diene	C <sub>10</sub> H <sub>15</sub> Cl <sub>3</sub>	acyclic halogenated monoterpene	Rib Reef, Great Barrier Reef, Australia
	2	( <i>E</i> )-1,2-dibromo-3-chloromethylene-7-methyloct-6-ene	C <sub>10</sub> H <sub>15</sub> Br <sub>2</sub> Cl	"	"
	3	( <i>Z</i> )-1-chloro-3-chloromethyl-7-methylocta-2,6-diene	C <sub>10</sub> H <sub>16</sub> Cl <sub>2</sub>	"	"
	4	( <i>Z</i> )-1,6-dichloro-3-chloromethyl-7-methylocta-2,7-diene	C <sub>10</sub> H <sub>15</sub> Cl <sub>3</sub>	"	"
	5	( <i>2R</i> *, 3(8) <i>E</i> , 4 <i>S</i> *, 6 <i>R</i> *)-6-bromo-2-chloro-1,4-oxido-3,(8)-octodene	C <sub>10</sub> H <sub>14</sub> BrClO	epimeric bicyclic monoterpene	"
	6	( <i>2S</i> *, 3(8) <i>E</i> , 4 <i>S</i> *, 6 <i>R</i> *)-6-bromo-2-chloro-1,4-oxido-3,(8)-octodene	C <sub>10</sub> H <sub>14</sub> BrClO	"	"
(Coll and Wright, 1989)		( <i>Z</i> )-3-bromo-8-chloro-6-chloromethyl-2-methylocta-1,6-diene (9,6-hydroxymethyl-2-methylocta-2,8-dien-6-ol	-	-	-
(Wright et al., 1991a)	1	( <i>2Z</i> )-6-bromo-3-chloromethyl-1, 7-dichloro-7-methylocta-2-ene	C <sub>10</sub> H <sub>16</sub> Cl <sub>3</sub> Br	acyclic halogenated monoterpene	Nelly Bay, Magnetic Island, Queensland, Australia

Table S6.1. Continued

	2	(2Z, 6E)-3-chloromethyl-1-chloroocta-2,6-dien-8-al	C <sub>10</sub> H <sub>14</sub> OCl <sub>2</sub>	"	"
	3	3-methoxymethyl-6-methoxy-7-methylocta-1,7(10)-dien-3-ol	C <sub>12</sub> H <sub>22</sub> O <sub>3</sub>	"	"
	4	(2Z,6S)-3-chloromethyl-1-methylocta-2,7(10)-dien-6-ol	C <sub>11</sub> H <sub>19</sub> O <sub>2</sub> Cl	"	"
	5	(2Z,6S)-3-chloromethyl-6-methylocta-2,7(10)-dien-1-ol	C <sub>11</sub> H <sub>19</sub> O <sub>2</sub> Cl	"	"
(Fuller et al., 1992)	1	<b>halomon</b> / 6(R)-bromo-3(S)-(bromomethyl)-7-methyl-2,3,7-trichloro-1-octene	C <sub>10</sub> H <sub>15</sub> Br <sub>2</sub> Cl <sub>3</sub>	acyclic halogenated monoterpene	Chanaryan, Batan Is., Batanes, Philippines
	2	-	C <sub>10</sub> H <sub>13</sub> Cl	cyclic halogenated monoterpene	Banilad, Bacong, Negros Oriental, Philippines
(Fuller et al., 1994)	2	isohalomon	C <sub>10</sub> H <sub>15</sub> Br <sub>2</sub> Cl <sub>3</sub>	acyclic halogenated monoterpene; isomeric with halomon	Chanaryan, Batan Is., Batanes, Philippines
	3	-	C <sub>10</sub> H <sub>14</sub> BrCl <sub>3</sub>	acyclic halogenated monoterpene	"
	4	-	C <sub>10</sub> H <sub>14</sub> Br <sub>2</sub> Cl <sub>2</sub>	"	"
	5	-	C <sub>10</sub> H <sub>14</sub> Br <sub>3</sub> Cl	cyclic halogenated monoterpene	"
	6	-	C <sub>10</sub> H <sub>14</sub> BrCl <sub>3</sub>	"	"
	7	-	C <sub>10</sub> H <sub>13</sub> Cl <sub>3</sub>	"	"
	8	-	C <sub>10</sub> H <sub>15</sub> BrCl <sub>2</sub>	acyclic halogenated monoterpene	"
	9	-	C <sub>10</sub> H <sub>16</sub> Br <sub>2</sub> Cl <sub>2</sub>	"	"
	10	-	C <sub>10</sub> H <sub>16</sub> BrCl	"	Halona Blowhole Is, Oahu, Hawaii
	11	-	C <sub>10</sub> H <sub>15</sub> BrCl	"	"
	12	-	C <sub>10</sub> H <sub>14</sub> BrCl	cyclic halogenated monoterpene	"
(Gunatilaka et al., 1999)	1	<b>apakaochtodene A</b> / 6(S*)-bromo-1,4(S*),8(R*)-trichloro-2(Z)-ochtodene	C <sub>10</sub> H <sub>14</sub> Cl <sub>3</sub> Br	cyclic halogenated monoterpene	Apaka Point Beach, Guam
	2	<b>apakaochtodene B</b> / 6(S)-bromo-1,4(S), 8(R*)-trichloro-2(E)-ochtodene	C <sub>10</sub> H <sub>14</sub> Cl <sub>3</sub> Br	cyclic halogenated monoterpene	Gun Beach; Double Reef; Pago Bay; Guam
(Barahona and Rorrer, 2003)	1	<b>myrcene</b> / 7-methyl-3-methylene-1,6-octadiene	C <sub>10</sub> H <sub>16</sub> O	acyclic non-halogenated monoterpene	microplantlet culture, Double Reef NW Guam
	2	<b>10E-bromomyrcene</b> / E-3-bromomethylene-7-methyl-1,6-octadiene	C <sub>10</sub> H <sub>15</sub> Br	"	"

Table S6.1. Continued

	3	<b>10Z-bromomyrcene</b> / Z-3-bromomethylene-7-methyl-1,6-octadiene	C <sub>10</sub> H <sub>15</sub> Br	"	"
	4	<b>10E-bromo-3-chloro-<math>\alpha</math>-myrcene</b> / E-3-bromomethylene-6-chloro-1,7-octadiene	C <sub>10</sub> H <sub>14</sub> BrCl	"	"
	5	-	C <sub>10</sub> H <sub>14</sub> Br <sub>2</sub>	"	"
	6	<b>apakaochtodene B</b> / 6(S)-bromo-1,4(S), 8(R*)-trichloro-2(E)-ochtodene	C <sub>10</sub> H <sub>14</sub> BrCl <sub>3</sub>	cyclic halogenated monoterpene	"
	7	-	C <sub>10</sub> H <sub>16</sub> O	non-halogenated monoterpene	"
	8	bromomyrcene isomer	C <sub>10</sub> H <sub>15</sub> Br	halogenated monoterpene	"
	9	<b>7-chloromyrcene</b> / 2-chloro-3-methylene-7-methyl-1,6-octadiene	C <sub>10</sub> H <sub>15</sub> Cl	"	"
	10		C <sub>10</sub> H <sub>14</sub> Cl	"	"
	11	chloromyrcene derivative	C <sub>10</sub> H <sub>16</sub> Cl	"	"
	12	bromomyrcene isomer	C <sub>10</sub> H <sub>15</sub> Br	"	"
	13	chloromyrcene derivative	C <sub>10</sub> H <sub>14</sub> Cl	"	"
	14	-	C <sub>10</sub> H <sub>18</sub> Cl <sub>2</sub>	"	"
	15	-	C <sub>15</sub> H <sub>18</sub> O <sub>4</sub>	sesquiterpene	"
(Kuniyoshi et al., 2003)	5	1,2-dibromoochtoda-3(8),5-dien-4-one	C <sub>22</sub> H <sub>12</sub> Br <sub>2</sub> O	cyclic halogenated monoterpene	Cape Zampa, Okinawa, Japan
	6	1-bromo-2-chloroochtoda-3(8),5-dien-4-one	C <sub>10</sub> H <sub>12</sub> BrClO	"	"
	7	1,2-dichloroochtoda-3(8),5-dien-4-one	C <sub>10</sub> H <sub>12</sub> Cl <sub>2</sub> O	"	Gushichan coast, Okinawa, Japan
	8	(1Z)-1-bromoochtoda-1,3(8),5-trien-4-one	C <sub>10</sub> H <sub>11</sub> BrO	"	Cape Zampa, Okinawa, Japan
	9	(1Z)-1-chloroochtoda-1,3(8),5-trien-4-one	C <sub>10</sub> H <sub>11</sub> ClO	"	"
Andrianasolo et al. 2006	1	<b>halomon</b> / 6(R)-bromo-3(S)-(bromomethyl)-7-methyl-2,3,7-trichloro-1-octene	C <sub>10</sub> H <sub>15</sub> Br <sub>2</sub> Cl <sub>3</sub>	acyclic halogenated monoterpene	Tolagniaro, Fort Dauphin, Madagascar
	2	-	C <sub>10</sub> H <sub>13</sub> ClBr	"	"
	3	-	C <sub>10</sub> H <sub>14</sub> Cl <sub>2</sub> Br	"	"
	4		C <sub>10</sub> H <sub>15</sub> Br <sub>2</sub> Cl <sub>3</sub>	"	"

Table S6.2. Compound peaks detected from GC-MS analysis of samples used for characterization of the life history stages of *P. bornemannii*. Identifications based on comparison of either Kovats Indices (KI) of compounds retrieved from the Retention Index Calculator (Lucero et al. 2009) or mass spectral comparison of compounds retrieved from NIST or MassBase. Asterisk (\*) indicates compounds with parent ions showing halogenated mass spectral patterns.

#	Sample	Base Peak	RT (min)	KI	KI based ID		Mass spectra based ID		
					Nearest KI	Lucero et al. 2009	NIST	MassBase	
1	F6_2	93	6.1863	994	993/994	$\beta$ -myrcene/ 6-methyl-5-hepten-2-ol	b-myrcene	b-myrcene	
2	T1_1	104	6.5874	1008	1007	$\alpha$ -phellandrene	-	-	
3	T1_2	104	6.5909	1008	1007	$\alpha$ -phellandrene	-	-	
4	M1_1	91	6.7685	1016	1017	$\alpha$ -terpinene	Benzene, tert-butyl-	4-methylacetophenone	
5	F3_3	79	6.9501	1023	1024	r-cymene	-	-	
6	M1_2	79	6.9532	1023	1024	r-cymene	-	-	
7	M1_3	91	7.017	1026	1025	p-cymene	carbonic acid	1-phenylpropan-2-one	
8	M2_2	91	7.021	1026	1025	p-cymene	-	protopine	
9	F3_2	91	7.0387	1027	1025	p-cymene	-	N-Methyl-N-propargylbenzylamine	
10	T2_1	57	8.0381	1063	1062	$\gamma$ -terpinene	-	-	
11	M2_2	132	8.8894	1089	1089	p-mentha-2,4(8)diene	-	-	
12	T2_1	117	9.5127	1110	1099	linalool	-	-	
13	F4_3	117	9.8874	1124	1123	chrysanthenone	-	-	
14	M1_3	117	9.9855	1128	1127	$\alpha$ -campholenal	-	-	
15	M2_2	91	10.2042	1136	1127	$\alpha$ -campholenal	-	-	
16	F2_2	91	10.2132	1136	1127	$\alpha$ -campholenal	-	Dimethirimol	
17	T2_1	119	10.4565	1145	1145	camphor	-	Benzimidazole	
18	M1_1	68	10.8826	1160	1158	isobomeol	-	-	
19	F7_3	68	10.8845	1160	1158	isobomeol	-	-	
20	T2_1	68	10.8866	1160	1158	isobomeol	-	-	
21	F3_3	68	10.8873	1160	1158	isobomeol	-	-	
22	F4_1	117	11.3242	1174	1171	ethyl-benzoate	-	-	
23	F4_1	50	11.5177	1180	1180	m-cymen-8-ol	-	-	
24	T2_2	127	11.5317	1180	1180	m-cymen-8-ol	-	-	



Table S6.2. Continued.

25	T2_3	134	11.7619	1188	1187	p-cymen-8-ol	-	-
26	M2_2	105	12.0654	1197	1196	methylchavicol	-	3-cyanopyridine
27	F3_2	57	12.1827	1200	1203.748	n-decanal	3-Hexanone	-
28	F7_3	113	12.3674	1207	1207	verbenone	-	-
29	M1_2	113	12.3831	1208	1207	verbenone	-	-
30	T1_3	91	12.3874	1208	1207	verbenone	-	-
31	M2_2	93	12.6294	1217	1217	trans-carveol	-	-
32	M1_2	69	12.7588	1222	1219	trans-carveol	-	-
33	M1_1	55	12.8397	1225	1229	nerol	-	-
34	F7_3	67	13.1203	1236	1236	thymol methyl ether	-	-
35	M1_1	79	13.1266	1236	1236	thymol methyl ether	-	-
36	F5_2	93	13.127	1236	1236	thymol methyl ether	-	Beta-pinene; y-cudesmol
37	M2_2	93	13.32	1243	1243	carvone	-	-
38	T1_1	93	13.327	1243	1243	carvone	2-chloropropionyl chloride	-
39	T2_1	93	13.3305	1243	1243	carvone	-	-
40	F6_2	69	13.6916	1256	1256	geraniol	-	-
41	M1_1	91	13.6953	1256	1256	geraniol	-	-
42	F2_1	69	13.6967	1256	1256	geraniol	-	-
43	F5_1	69	13.6975	1256	1256	geraniol	-	-
44	M2_1	91	13.9837	1266	1263	(E)-2-decenal	-	N-Methyl-N-propargylbenzylamine
45	F7_3	119	14.131	1271	1271	geranial	-	-
46	F2_3	119	14.1354	1271	1271	geranial	-	-
47	F3_2	69	14.4252	1281	1282	$\alpha$ -terpinen-7-al	-	-
48	M2_3	69	14.4368	1281	1282	$\alpha$ -terpinen-7-al	-	-
49	F5_1	91	14.6745	1289	1289	p-cymen-7-ol	-	-
50	T2_1	91	14.68	1289	1289	p-cymen-7-ol	-	-
51	F6_3	149	14.9157	1297	1297	perilla alcohol	-	Benzoylcholine
52* (Cl)	F6_3	131	15.0641	1302	1302	trans-ascaridole	-	2-chloro-1-phenyl-2-butene

Table S6.2. Continued

53	F6_1	166	15.3344	1313	1313	2 <i>E</i> ,4 <i>E</i> -decadienal	-	2-chloro-1-phenyl-2-butene
54	F6_3	81	15.5368	1320	1313	2 <i>E</i> ,4 <i>E</i> -decadienal	-	-
55	M2_2	81	15.5381	1321	1313	2 <i>E</i> ,4 <i>E</i> -decadienal	-	-
56	T1_2	81	15.5481	1321	1313	2 <i>E</i> ,4 <i>E</i> -decadienal	-	-
57	M2_2	67	15.6269	1324	1313	2 <i>E</i> ,4 <i>E</i> -decadienal	-	1-Adamantanamine
58	M1_2	67	15.6354	1324	1313	2 <i>E</i> ,4 <i>E</i> -decadienal	-	-
59	F3_1	57	15.7447	1329	1339	d-clemene	-	-
60	F2_1	57	15.7649	1329	1339	d-clemene	-	-
61	M2_2	91	15.8827	1334	1339	d-clemene	-	-
62	M1_2	91	15.8885	1334	1339	d-clemene	-	-
63	M2_2	139	16.5157	1357	1357	eugenol	-	-
64	F6_1	115	16.5278	1358	1357	eugenol	-	-
65	M2_3	166	16.5392	1358	1357	eugenol	-	-
66	M2_2	91	17.02	1375	1373	a-ylangene	-	-
67	M2_3	91	17.0254	1376	1373	a-ylangene	-	-
68	M1_2	91	17.0311	1376	1373	a-ylangene	-	-
69	T2_1	127	17.403	1389	1389	isolongifolene	-	Imidazole-4-acetate
70	T2_1	57	17.7476	1400	1399	1,7-di-epi-a-cedrene	-	-
71	M2_2	79	17.7625	1401	1402	methyleugenol	-	-
72	M2_3	127	17.7782	1402	1402	methyleugenol	-	-
73	T2_2	67	18.1041	1415	1415	<i>cis</i> -a-bergarnotene	-	-
74	T1_3	79	18.18	1418	1419	$\beta$ -caryophyllene	-	-
75	F6_1	79	18.1866	1419	1419	$\beta$ -caryophyllene	-	-
76	T1_1	79	18.1928	1419	1419	$\beta$ -caryophyllene	Pyridine	-
77	F5_1	79	18.1934	1419	1419	$\beta$ -caryophyllene	-	camphene
78	M1_2	79	18.1939	1419	1419	$\beta$ -caryophyllene	-	-
79	F7_2	212	18.3193	1424	1420	$\beta$ -caroyophyllene	-	-
80	F6_2	210	18.4564	1429	1420	$\beta$ -caroyophyllene	-	-
81	M2_3	131	18.4673	1430	1420	$\beta$ -caroyophyllene	-	-
82	M1_1	67	18.5462	1433	1435	trans-a-bergamotene	-	-
83	M1_2	67	18.5503	1433	1435	trans-a-bergamotene	-	-
84	F2_2	133	18.6084	1435	1435	trans-a-bergamotene	-	-

Table S6.2. Continued

85	T2_2	69	18.6925	1439	1438	trans-a-bergamotene	-	-
86	F3_3	69	18.6982	1439	1440	a-guaiene	-	-
87	M2_3	69	18.7018	1439	1440	a-guaiene	-	-
88	M1_1	91	18.7475	1441	1440	a-guaiene	-	-
89	F4_2	69	18.8243	1444	1440	a-guaiene	-	-
90	F7_2	69	18.8273	1444	1440	a-guaiene	-	-
91	T1_3	69	18.8306	1444	1440	a-guaiene	-	-
92	F2_2	210	19.1226	1456	1455	a-humulene	-	-
93	F3_3	133	19.3339	1464	1464	a-acoradiene	-	-
94	T2_2	105	19.4843	1469	1469	drima-7,9(11)-diene	-	-
95	T2_1	105	19.4852	1469	1469	drima-7,9(11)-diene	-	-
96	F7_2	131	19.4915	1470	1469	drima-7,9(11)-diene	-	-
97	F5_1	91	19.6255	1475	1474	b-cadinene	-	-
98	F6_3	91	19.7468	1479	1479	$\gamma$ -curcurnene	-	-
99	F2_1	91	19.7581	1480	1480	germacrene D	-	-
100	F4_1	153	20.0567	1491	1491	<i>cis</i> - $\beta$ -guaiene	-	-
101	F4_1	153	20.0567	1491	1491	<i>cis</i> - $\beta$ -guaiene	-	-
102	F3_2	71	20.2111	1496	1495	a-zingiberene	-	-
103	F7_2	135	20.3621	1502	1499	a-murolene	-	-
104	F5_1	91	20.3727	1503	1506	d-selinene	-	-
105	T2_1	91	20.3766	1503	1506	d-selinene	-	-
106	F2_2	91	20.3829	1503	1506	d-selinene	--	-
107	F6_1	205	20.6221	1513	1513	g-cadinene	-	-
108	F4_3	205	20.6237	1513	1513	g-cadinene	-	-
109	F7_2	205	20.6252	1513	1513	g-cadinene	-	5-bromo-4-methoxyoct-1-ene
110	T2_1	205	20.6278	1513	1513	g-cadinene	p-Benzoquinone	-
111	F3_2	133	20.6781	1516	1514	sesquicineole	-	-
112	F3_3	133	20.6803	1516	1514	sesquicineole	-	-
113	F6_3	133	20.685	1516	1514	sesquicineole	-	-
114	F5_1	69	20.8293	1522	1523	d-cadinene	-	--
115	F5_1	69	20.9154	1526	1525	eugenyl acetate	-	-
116	F6_3	69	20.9158	1526	1525	eugenyl acetate	-	-
117	F7_2	121	20.9204	1526	1525	eugenyl acetate	-	-

Table S6.2. Continued

118	T1_3	69	20.9227	1526	1525	eugenyl acetate	-	-
119	F7_2	167	21.1103	1534	1533	cadina-1,4-diene1	-	-
120	T2_2	91	21.1498	1536	1538	a-cadinene	-	-
121	F6_1	167	21.43	1547	1548	elemol	-	-
122	F7_2	167	21.4346	1547	1548	elemol	-	-
123	T1_3	69	21.467	1549	1549	elemol	-	--
124	F3_2	69	21.4709	1549	1549	elemol	-	-
125	F7_2	91	21.598	1554	1552	elemicin	-	-
126	F6_2	91	21.6852	1557	1557	germacrene B	-	-
127	F5_1	91	21.6859	1558	1557	germacrene B	-	-
128	F6_3	91	21.6869	1558	1557	germacrene B	-	-
129	M1_1	91	21.6895	1558	1557	germacrene B	-	-
130	F6_3	67	21.7268	1559	1557	germacrene B	-	-
131	F7_2	133	21.8253	1563	1564	$\beta$ -calacorene	-	L-Asparagine
132	T1_1	91	21.8405	1564	1564	$\beta$ -calacorene	-	-
133	F7_2	167	22.0012	1570	1574	prenopsan-8-ol	-	-
134	T1_3	213	22.018	1571	1574	prenopsan-8-ol	-	-
135	F6_3	132	22.0226	1571	1574	prenopsan-8-ol	-	-
136	F6_3	153	22.0226	1571	1574	prenopsan-8-ol	-	-
137	M1_1	91	22.3956	1586	1585	gleenol	-	-
138	F2_2	133	22.5362	1591	1590	viridflorol	-	-
139	F6_3	71	22.7179	1598	1590	viridflorol	-	-
140	F3_2	71	22.7193	1598	1590	viridflorol	-	-
141	F2_3	135	22.722	1598	1590	viridflorol	-	-
142	F3_3	57	22.7547	1600	1607	b-oploponone	-	-
143	F3_2	57	22.7603	1600	1607	b-oploponone	-	-
144	F3_3	57	22.761	1600	1607	b-oploponone	-	-
145	F6_3	67	22.8782	1605	1607	b-oploponone	-	-
146	T2_2	68	23.0541	1613	1612	tetradecanal	-	-
147	F4_3	148	23.2435	1622	1623	silphiperfol-6-en-5-one	-	-
148	F3_1	135	23.2485	1622	1623	silphiperfol-6-en-5-one	-	-
149	F5_3	91	23.52	1634	1633	y-eudesmol	-	-
150	F4_3	91	23.5226	1634	1633	y-eudesmol	-	-
151	F7_2	68	23.5261	1634	1633	y-eudesmol	-	-
152	F7_2	68	23.5261	1634	1633	y-eudesmol	-	--

Table S6.2. Continued

153	T2_2	68	23.5278	1634	1633	y-eudesmol	-	-
154	F6_1	167	23.5309	1634	1633	y-eudesmol	-	-
155	F6_2	67	23.7239	1643	1642	cubenol	-	allyl cy-anide
156	T1_3	91	23.8325	1647	1646	a-muurolol	-	-
157	F7_2	132	23.8759	1649	1646	a-muurolol	-	-
158	F7_2	132	23.9988	1654	1653	a-cadinol	-	-
159	F6_2	149	24.3377	1669	1668	bulnesol	-	-
160	F7_2	149	24.3428	1669	1668	bulnesol	-	-
161	F6_3	167	24.6091	1680	1682	a-bisabolol	-	-
162	F6_1	57	24.6252	1681	1682	a-bisabolol	-	-
163	F7_2	69	24.8113	1689	1686	8-cedren-13-ol	-	-
164	F7_2	69	24.8207	1689	1686	8-cedren-13-ol	-	-
165	F2_3	67	24.9282	1693	1686	8-cedren-13-ol	-	-
166	F6_1	57	25.0854	1700	1686	8-cedren-13-ol	-	Heptadecane
167	F7_2	91	25.3006	1710	1686	8-cedren-13-ol	-	-
168	F3_2	71	25.3224	1711	1735	oplopanone	-	-
169	F3_3	68	25.4814	1718	1735	oplopanone	-	-
170	F6_3	67	25.7278	1730	1735	oplopanone	-	-
171	F7_2	103	25.7292	1730	1735	oplopanone	-	-
172	F2_1	67	25.7318	1730	1735	oplopanone	-	-
173	F2_3	133	25.8305	1735	1735	oplopanone	-	-
174	F3_1	117	25.8366	1735	1735	oplopanone	-	-
175	F7_2	167	26.3223	1757	1761	benzyl-benzoate	-	-
176	T2_1	167	26.5838	1769	1761	benzyl-benzoate	-	6--Methylmercaptapurine
177	F6_2	117	26.7333	1775	1789	8-a-acetoxyelemol	-	-
178	T2_2	103	26.8111	1779	1789	8-a-acetoxyelemol	-	-
179	F3_1	67	26.8577	1781	1789	8-a-acetoxyelemol	-	-
180	F6_1	67	26.8599	1781	1789	8-a-acetoxyelemol	-	-
181	F3_2	67	26.8671	1781	1789	8-a-acetoxyelemol	-	-
182	T2_1	67	26.8697	1781	1789	8-a-acetoxyelemol	-	-
183	F6_1	103	26.8838	1782	1789	8-a-acetoxyelemol	-	-
184	* <sub>(Cl<sub>2</sub>)</sub> F3_1	103	26.8852	1782	1789	8-a-acetoxyelemol	-	-
185	* <sub>(Br)</sub> F6_1	67	27.4286	1806	1798	nootkatone	-	-

Table S6.2 Continued

186	F7_2	67	27.4342	1806	1798	nootkatone	-	-
*(Br)								
187	F2_1	67	27.4383	1807	1798	nootkatone	-	-
188	F6_3	103	27.4961	1810	1798	nootkatone	-	-
189	F6_1	67	27.5012	1810	1798	nootkatone	-	-
190	F6_2	67	27.5676	1813	1827	isopropyl tetradecanoate	-	-
191	F6_2	69	28.0351	1836	1827	isopropyl tetradecanoate	-	-
192	F3_2	69	28.0387	1836	1827	isopropyl tetradecanoate	-	-
193	F6_1	91	28.3153	1849	1867	flourensiadiol	-	-
194	F3_2	149	28.735	1869	1867	flourensiadiol	-	-
195	F6_2	69	29.2918	1895	1878	hexadecanol	-	-
*(ClB								
r)								
196	F5_3	67	29.4766	1903	1927	methyl hexadecanoate	-	-
197	T2_1	67	29.4889	1904	1927	methyl hexadecanoate	-	-
198	F7_2	91	30.7705	1968	1999	eicosane	-	-
199	T2_2	91	30.7753	1969	1999	eicosane	-	-
200	F3_2	91	30.7855	1969	1999	eicosane	-	-
201	T2_2	64	31.6475	-	-	-	-	-
202	T2_2	129	38.661	-	-	-	-	-

Table S6.3. Compound peaks detected from GC-MS analysis of samples for evaluation of non-polar secondary metabolite patterns of 5 cryptic species of *P. bornemannii* found in Batanes, Philippines. Identifications based on comparison of either Kovats Indices (KI) of compounds retrieved from the Retention Index Calculator (Lucero et al. 2009) or mass spectral comparison of compounds retrieved from NIST or MassBase. Asterisk (\*) indicates compounds with parent ions showing halogenated mass spectral patterns.

#	Sam ple	Base Peak	RT (min)	KI based ID			Mass spectra based ID	
				KI	Near est KI	Lucero et al. 2009	NIST	Massbase
1	B4B	57	8.1122	1065	1062	$\gamma$ -terpinene	-	-
2	B4C	69	8.7386	1085	1085	artemisia-alcohol	-	-
3	B4C	57	9.1807	1098	1097	linalool	-	-
4	B4B	71	9.1841	1098	1097	linalool	-	-
5	B6C	57	9.4047	1106	1099	linalool	3- hexanone,- 2,2- dimethyl	2-methylbutane
6	B4C	69	11.2515	1172	1171	ethyl-benzoate	-	-
7-	B3A	69	11.2560	1172	1171	ethyl-benzoate	-	-
8	B4A	57	14.3547	1279	1277	trans-carvone- oxide	-	2,2-dimethylbutane
9	B4B	57	14.3593	1279	1277	trans-carvone- oxide	-	3-ethylhexane
10	B3B	57	14.5560	1285	1286	borneol-acetate	-	-
11	B3A	69	15.2678	1310	1306	undecanal	-	trans-4-octene
12	B3A	57	15.6497	1325	1314	2 <i>E</i> ,4 <i>E</i> -decadienal	-	-
13	B6B	57	15.6518	1325	1314	2 <i>E</i> ,4 <i>E</i> -decadienal	-	-
14	B4A	71	16.5884	1360	1357	eugenol	-	2-methylpentane
15	B6C	57	17.8154	1403	1403	italicene	-	2,2-dimethylbutane
16	B3A	57	17.8289	1404	1403	italicene	-	-
17	B10	71	20.306	1500	1499	a-muurolene	-	Pentacosane
18	B3A	57	20.4025	1504	1506	d-selinene	-	tripropylamine
19	B4A	191	20.715	1517	1514	sesquicineole	-	-
20	B6C	57	21.0008	1529	1532	cadina-1,4-diene	-	-
21-	B3B	57	21.0024	1529	1532	cadina-1,4-diene	-	1-octene
22	B4A	69	21.5566	1552	1552	elemicin	-	-
23	B4A	57	25.1819	1704	1686	8-cedren-13-ol	-	-
24	B4B	71	25.4142	1715	1735	oplopanone	-	Hexacosane
25	B4B	69	26.0498	1745	1747	6 <i>S</i> -7 <i>R</i> -bisabolone	-	10-methyl-1- dodecanol

Table S6.3. Continued.

26	B4A	57	27.4031	1805	1798	nootkatone	-	4-methyl-1-pentene
27	B3B	57	27.9515	1832	1827	isopropyl-tetradecanoate	-	2,4-dimethylpentane
28	B3B	71	29.9932	1930	1927	methyl-hexadecanoate	-	docosane
29	B6B	57	30.4182	1951	1927	methyl-hexadecanoate	-	-
30	B10	69	30.5987	1960	1927	methyl-hexadecanoate	-	-
31	B4C	73	30.6949	1965	1999	eicosane	-	-
32	B6B	71	32.0267		-		3-hexanone,- 2,2-dimethyl	2,2-dimethylbutane
33	B3B	71	32.0458		-		-	2,2-dimethylbutane
34	B6B	69	34.1452		-		-	docosane
35	B3B	69	34.7128		-		-	-
36	B4C	69	34.7233		-		-	-
37	B6C	71	35.0713		-		-	-
38	B3C	71	36.7162		-		-	3-ethylpentane
39	B9B	395	38.2697		-		-	-
40	B6C	71	38.8875		-		-	3-ethylhexane
41	B6B	71	39.0147		-		-	-
42	B4C	57	39.4792		-		-	3-ethylhexane
43	B6B	57	39.4822		-		-	3,3-dimethyl-1-butene
44	B4C	71	39.6266		-		-	3-ethylpentane
45	B3C	71	39.7884		-		-	-
46	B6B	57	40.4997		-		3-hexanone,- 2,2-dimethyl	2-methylbutane
47	B6C	57	40.7684		-		-	3-ethylpentane
48	B3C	71	40.7722		-		-	-
49	B4C	57	43.09		-		-	3-ethylpentane
50	B6B	57	43.0982		-		-	2,2,4,6,6-pentamethylheptane
51	B6C	85	43.2865		-		-	2-methylnonane
52	B6B	71	43.3628		-		-	3-ethylpentane
53	B3C	71	43.3691		-		-	-



Table S6.3. Continued.

54	B3B	85	43.7727	-	-	-	3,3-dimethyl-1-butene
55	B4B	85	44.3901	-	-	-	amitrole
56	B6B	71	44.3953	-	-	-	3-aminopropionitrile
57	B4A	71	46.2638	-	-	-	-
58	B3C	71	46.8143	-	-	-	2,3-dimethylbutane
59	B6B	71	46.822	-	-	3-hexanone,- 2,2-dimethyl	-
60	B6C	71	47.3544	-	-	-	-
61	B4A	71	47.7467	-	-	-	3-ethylpentane
62	B3A	57	47.7529	-	-	-	3,3-dimethyl-1-butene
63	B4A	71	48.0072	-	-	-	-
64	B6B	71	48.0159	-	-	-	-
65	B6C	71	48.0169	-	-	-	-
66	B4A	71	48.0321	-	-	-	-
67	B4B	71	50.7731	-	-	-	-



## 7 SEASONAL DYNAMICS OF *PORTIERIA* POPULATIONS IN THE PHILIPPINES<sup>1</sup>

---

### Abstract

The seasonal dynamics of the red alga, *Portieria*, were studied by looking at three parameters: density, percent cover and biomass in four sites located at Negros and Siquijor Islands, Philippines from Jan 2007 to Mar 2009. Sites are affected by strong waves during the southwest (June-Sept) and northeast (Nov-Feb) monsoon periods. Significant fluctuations in all three parameters were detected mainly in two sites affected either by the NE and SW monsoon waves. Results and field observations suggest that *Portieria* has a site-specific seasonality that is influenced by strong wave actions brought by the monsoonal winds. *Portieria* in Siaton, Negros, a site exposed to the SW monsoon waves, begins its growth closely before or during the SW monsoon season and disappears at the end of the NE monsoon. In Dapdap, Siquijor, a site exposed only to the NE monsoon waves, plants begin growing just before or during the NE monsoon, and decline towards the SW monsoon. Sawang and Pagubagubaan in Siquijor are two sites exposed to waves of the NE and SE monsoon. Here, no significant fluctuations of the measured parameters were detected indicating a lack of marked seasonality. However, field observations of the presence of young and senescent individuals suggest two growth cycles in Sawang: one that appears during the SW monsoon and a new batch appearing during the NE monsoon. A generation of plants in Siaton and Dapdap is estimated to grow and live for a maximum of 9-10 months while those in Sawang and Pagubagubaan live for about 5 months.

Keywords: *Portieria*; seasonal dynamics; monsoon; Philippines

<sup>1</sup> Unpublished manuscript: Payo D.A., A. Bucol, Leliaert F., H.P. Calumpong, and O. De Clerck. Seasonal dynamics of *Portieria* populations in the Philippines.

## 7.1 Introduction

*Portieria bornemannii* is a common red alga in the Philippines (Silva et al., 1987; Meñez et al., 1996). The species grows in the infralittoral fringe where it can obtain considerable biomass and further extends in lower abundance down to 20 meters. The species has drawn the attention of many phycologists by the discovery of secondary metabolites particularly halogenated monoterpenes with anti-tumor properties (Fuller et al., 1992; Fuller et al., 1994). However, the lack of a constant supply from natural populations hampered further drug development procedures. Recent studies applying molecular identification techniques (Chapter 3) revealed that *P. bornemannii* is in fact a complex of several cryptic species and that this cryptic diversity may at least partly contribute to the variation in the signature of secondary metabolites observed in different samples (Payo et al., in preparation or Chapter 6). We observed an unexpected diversity of *Portieria* in the Philippines, including at least 21 species. These species exhibit a well structured and fine-scale geographical pattern with most species occurring in only one or few islands. Populations found in the different islands of Central and Eastern Visayas are generally composed of a single (or sometimes two) species only.

Given the local structure of the diversity of *Portieria*-complex, it is of interest to investigate how this diversity is maintained and which factors contribute towards continuous isolation of neighbouring populations. Amongst other factors, differences in phenology among different cryptic species may reinforce isolation. Little is known however about changes in biomass, growth and reproduction in *Portieria*. Meñez *et al.* (1996) provided the first knowledge on the ecology of *Portieria* populations in the Philippines based on a one-time assessment of field biomass in some sites, and growth rates measured *in situ*. Macroalgal community studies provide some indication of seasonality and occurrence of *Portieria* but its temporal abundance has never been specifically followed. Along the southern coast of Yemen, Ormond and Banaimoon (1994) reported its presence in January, February, August, September, and October from January 1988 to February 1990. In Orchard Island, Taiwan, thalli were observed in April, August and September 2001; February, May, October 2002; July and September 2003; January 2004, i.e. 75% of the total survey visits from 2001 to 2004 (Su et al., 2009). Chung et al. (2007) reported only two occurrences of *Portieria* (July and October 2001) in a study from April 2001 to September 2003 in Dulang Bay, Southern Taiwan. These studies suggest that the seasonality of *Portieria* varies on a large spatial scale. Up to which extent the phenology of various cryptic species differs at a local scale remains

unknown at present. Thereto we studied the population dynamics of three cryptic species at four sites located in Negros and Siquijor islands in the Philippines.

## 7.2 Materials and methods

### 7.2.1 Study sites

Four sites located in Negros and Siquijor islands in the Philippines were sampled: Malo, Siaton, Negros Oriental (N 9.046722, E 122.9922); Dapdap, Siquijor, Siquijor (N 9.224033, E 123.5163); Sawang, San Juan, Siquijor (N 9.196861, E 123.4473) and Pagubagubaan, San Juan, Siquijor (N 9.191875, E 123.4476) (Fig. 7.1a and b).

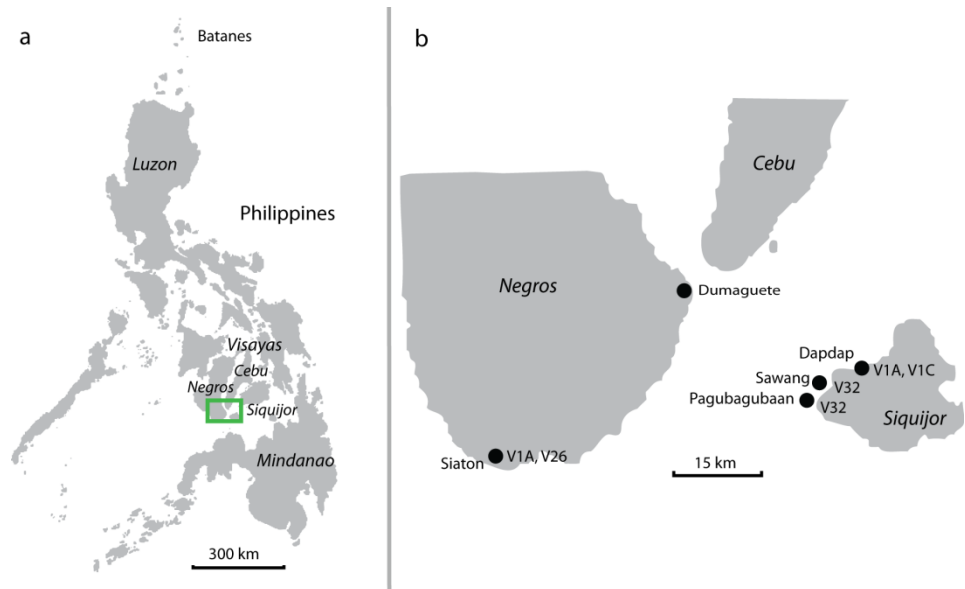

Fig. 7.1a-b. Maps showing the location of the four survey sites (Siaton, Dapdap, Pagubagubaan and Sawang) of *Portieria*, the species found and the location of the PAGASA Station (Dumaguete) where rainfall data was obtained.

The site in Siaton is a rocky intertidal zone noticeably covered by several species of *Sargassum*. *Portieria hornemannii* occur in the shallows, often attached to dead corals. This site is affected by strong waves brought by the SW monsoon (June-September). In Dapdap, the plants were observed growing on dead coral mounds as well as on rocks making up the structure of an unused pier. This site is exposed to the waves brought by the NE monsoon (November-February). Sawang and Pagubagubaan are offshore reefs, separated by deeper water for a distance of

500 m, from which many species of algae abound. These two sites are both affected by the NE and SW monsoons. Plants often are loosely attached to coral rubbles or epiphytic to other seaweeds. *P. bornemannii* were all found in the shallow water in all the four sites, reaching to a maximum depth of two meters.

Our molecular work (utilizing nuclear, mitochondrial and plastid genes) which will be treated in detail separately, suggests that there are four cryptic species (indicated as V1A, V1C, V26 and V32) found in these sites. These four entities are reflected as clade V1A, V1C, V26 and V32 on a mitochondrial *cox2-3* spacer derived phylogeny of *Portieria bornemannii* specimens from the Philippines (Chapter 3). Two coexisting *Portieria* cryptic species occur in Malo, Siaton (V1A and V26). In Dapdap, two species belonging to clade V1A and V1C are found. Sawang and Pagubagubaaan, which are closely adjacent sites, have also one species belonging to clade V32.

### 7.2.2 *Sampling.*

Sampling was conducted on a monthly basis (weather permitting) for 3 consecutive years: January 2007 to January 2009, in Siaton, Negros Oriental; February 2007 to March 2009 in Dapdap, Siquijor; March 2007 to February 2009 in Sawang, San Juan, Siquijor and from February 2008 to February 2009 in Pagubagubaaan, San Juan, Siquijor. Abundance was measured using the quadrat method. The quadrat used measures 0.25 m<sup>2</sup> subdivided into twenty-five .01 m<sup>2</sup> subquadrats. Ten quadrats were randomly thrown on the algal beds and the number of *Portieria* individuals within the quadrat was counted. Percentage cover estimates were taken by counting the number of quadrat squares covered by the plants. For the purpose of this study, an **individual** refers to a distinct clump or tuft, physically separated from conspecifics. For biomass assessment, *Portieria* within the quadrats were collected, and subsequently oven dried at 60°C until dry weights were constant. Biomass is expressed in dry weight. All data were converted and expressed on a per m<sup>2</sup> basis. Average thallus height was measured and cystocarpic plants were recorded. On the spot water parameters measured was surface water temperature using a standard laboratory thermometer and salinity using an YSI model 30 conductivity instrument. Daily rainfall data from January 2007 to March 2009 was measured and obtained from Dumaguete station of the Philippine Atmospheric Geophysical and Atmospheric Services Administration (PAGASA) in Dumaguete City, Philippines. With the proximity of the station to the sites (Fig. 7.1), it is assumed that the observed precipitation pattern is representative for the study area.

### 7.2.3 Statistical analyses

To determine significant differences in monthly quadrat data, we performed nonparametric Kruskal-Wallis ANOVA using Statistica 7.0 (StatSoft Inc., Tulsa, OK, USA). A post hoc test was applied to determine the months which caused the significant difference. Data on plant height successfully normalized using  $\log_{10}(x+1)$  were analyzed using ANOVA. Unequal N HSD (Honest Significant Difference) was used as a post hoc test. Average abundance, percent cover and biomass were compared between sites. Product-moment correlations were used to detect possible relationships between biological (number of individuals per  $m^2$ , percent cover and biomass) and environmental (surface temperature, salinity, rainfall) variables.

## 7.3 Results

### 7.3.1 Biophysical parameters

The Philippines is mainly affected by the NE monsoon around November to February and by SW monsoon from June to September, which brings increased precipitation as well as rough seas. Depending on the location, a coast can experience strong waves brought about by winds of the NE (in the Philippines referred to as *Amihan*) or SW monsoon (*Habagat*).

During the survey period, mean seawater surface temperature in the four sites ranged from 27.0-32.9 °C (Fig. 7.2.a-d). Temperature fluctuated within this range with lower mean temperatures (27.0-28.8 °C) generally observed in the colder NE monsoon months (around November to February). Dapdap in 2007 was an exception with the minimum temperature recorded during the SW monsoon months of August (28.7 °C) and September (28.8 °C).

Maximum temperatures (31.0- 32.9 °C) were not consistently observed during the same month among the four sites but were generally observed around the SW monsoon months (June to September). Dapdap in 2007 presented an exception with the highest temperature observed in October and November (32.0 °C).

Salinity in the four sites ranged from 28.7 to 35.0 ppt (Fig. 7.2a-d). Minimum salinity (28.4-31.5 ppt) was generally observed during the NE monsoon months while maximum salinity (35 ppt) was observed in the hot interim period of April and May, SW monsoon months, until the beginning of the NE monsoon in

November. In Dapdap, lower salinity levels (28.4-31.5 ppt) were also observed in August 2007 (31.1 ppt).

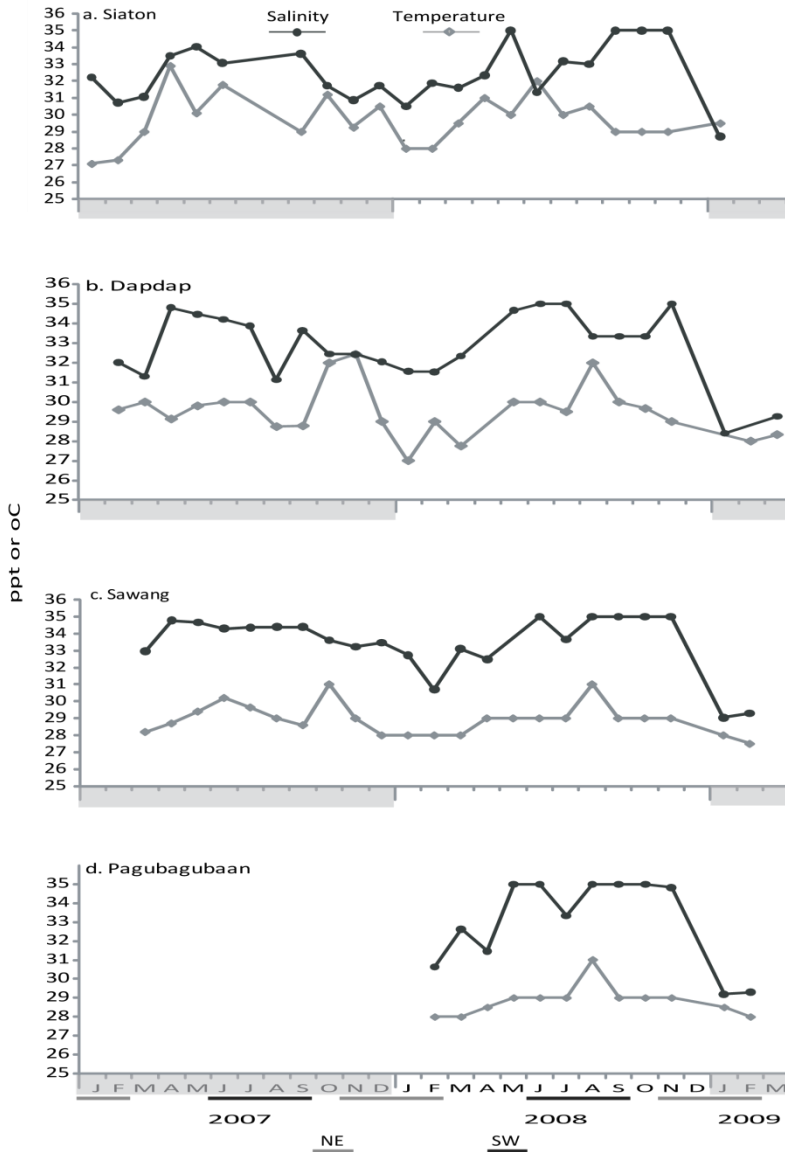

Fig. 7.2. Temporal variation in environmental parameters. Temperature and salinity measurements during the surveys in (a) Siaton (b) Dapdap (c) Sawang (d) Pagubagubaan.



Mean monthly rainfall ranged from 7.94 to 348.34 mm within the study period (Fig. 7.3). In 2007 and 2008, maximum mean rainfall was experienced at the onset of the monsoon seasons in June (252.12 mm and 224.54 mm, respectively) and November (276.10 mm and 211.58 mm, respectively). Minimum mean rainfall in 2007 was experienced in the hot months of March (7.94 mm) and April (19.98 mm). Minimum rainfall in 2008 was experienced in July (29.09 mm). Tropical storms and typhoons (particularly Ambo and Frank) contributed to high rainfall in April and June in the area.

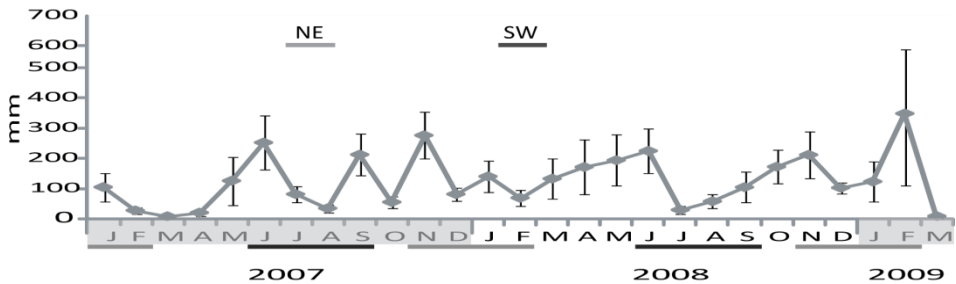

Fig. 7.3. Mean monthly rainfall ( $\pm$  SE) measured at the PAGASA station closest to the sampling sites. NE and SW monsoon months are indicated by light and dark gray bars, respectively.

### 7.3.2 Density, cover and biomass

*Portieria* exhibits seasonal patterns but the period of high abundance (Fig. 7.4a-d) and biomass (Fig. 7.5a-d) differs between sites.

In **Siaton** (Fig. 7.1), the general pattern suggests a growth of young individuals during the southwest monsoon between June to July, peaking in October, and declining between March to June.

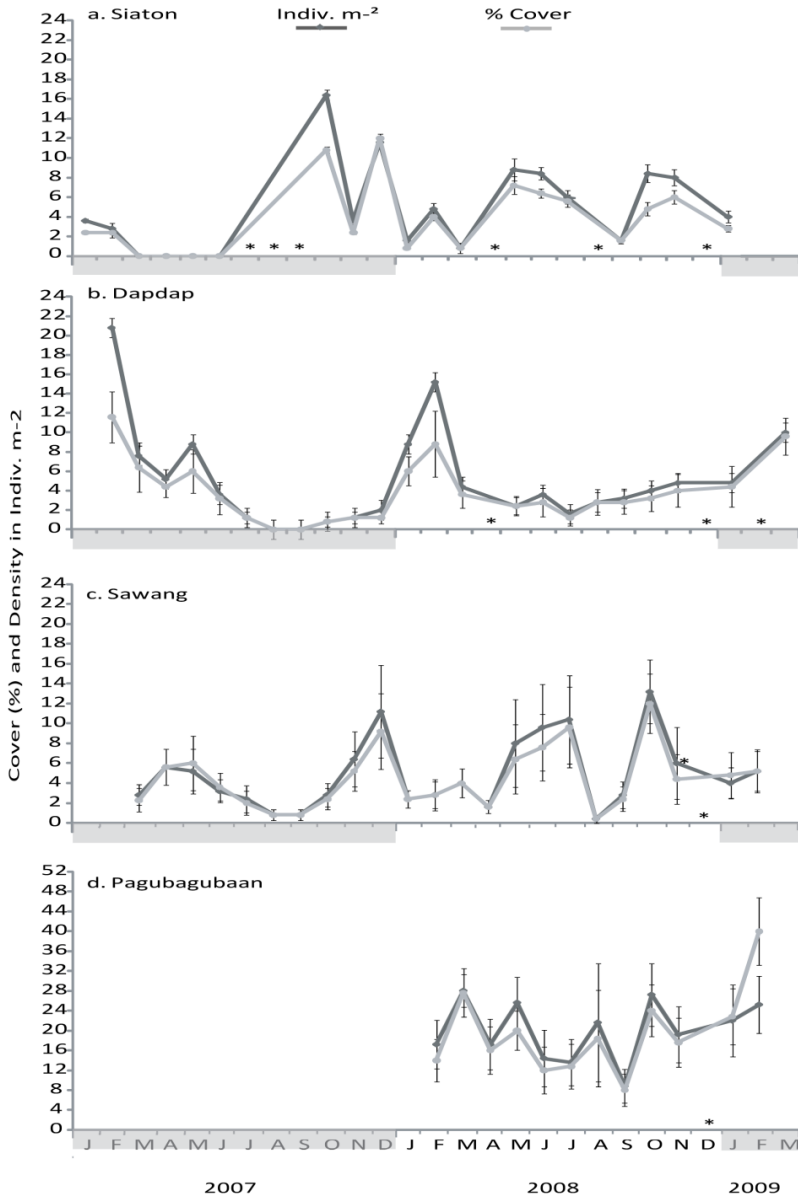

Fig. 7.4. Temporal variation in monthly mean abundance (individuals.m<sup>-2</sup>) ( $\pm$  SE) and percent cover ( $\pm$  SE) from 2007-2009 in 4 surveyed sites (a) Siaton (b) Dapdap (c) Sawang (d) Pagubagubaan. The symbol \* indicates absence of sampling data due to site inaccessibility during extreme wave actions and bad weather. Pagubagubaan has only been surveyed for 1 year as this site was a later discovery.

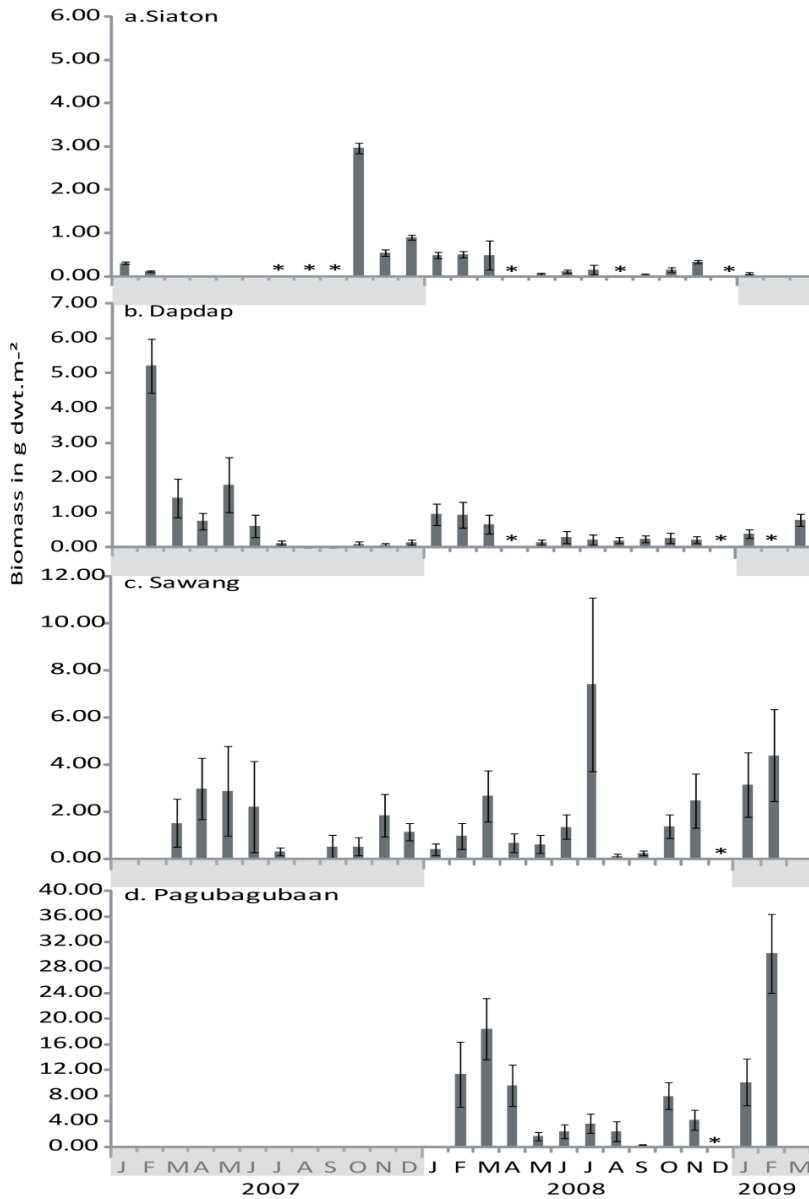

Fig. 7.5. Temporal variation in monthly mean biomass ( $\pm$  SE) of *Portieria* from 2007-2009 in 4 surveyed sites (a) Siaton (b) Dapdap (c) Sawang (d) Pagubagubaan. The symbol \* indicates absence of sampling data due to site inaccessibility during extreme wave actions and bad weather. Pagubagubaan has only been surveyed for 1 year as this site was a later discovery.

This was evident by its absence from March to June 2007 and its significant increase ( $p=0.0321$ ) of the number of individuals ( $16.40 \pm 0.51$  indiv.m<sup>-2</sup>), percent cover ( $10.80 \pm 0.30\%$ ), and biomass ( $2.96 \pm 0.12$  g m<sup>-2</sup>) in October 2007. The noticeable presence of these plants remains until February to March, which is the end of the northeast monsoon. The abundance and biomass fluctuates within the period, which could be due to continuous settling of recruits, successful growth and death of plants. The population declines almost entirely around March or April, coinciding with the proliferative growth of several *Sargassum* species reaching the shallow surface waters. *Portieria* specimens observed around this time, exhibit an orangy color and rubbery texture as opposed to the red and softer texture of younger plants in October. Its observable disappearance occurs before the SW monsoon months commencing around June. No statistically significant differences in these parameters were detected between 2008 and 2007. However, there was a certain disparity in the patterns observed between the period March to June 2007 and for the same period in 2008. Plants were absent in this period in 2007 while an increase of individuals per m<sup>2</sup> ( $0.80 \pm 0.53 - 8.40 \pm 0.63$  indiv.m<sup>-2</sup>) and percent cover ( $0.80 \pm 0.53 - 6.40 \pm 0.45\%$ ) occurred in the same period in 2008. *Portieria* was also observed in April 2008, but no quadrat survey was conducted in this period. In April, some of the rocks were already devoid of *Sargassum*. This early decline and disappearance of *Sargassum* beds were aggravated by the storms and typhoons that occurred before the surveys in April to June 2008. The disappearance of *Sargassum* beds paved the way for growth of young *Portieria* germinates, which were observed in June. Biomass remained consistently low until September 2008. Quadrat measurements were not possible from July to September 2007 due to the strong waves of the SW monsoon. But in October of both years, a sudden increase of abundance was observed. No significant difference in dry weight, individuals per m<sup>2</sup>, and percent cover were observed for this month in both years.

In **Dapdap**, plants were observed throughout the year. *Portieria* in this area is most abundant during the wavy northeast monsoon months (December-February). Towards the southwest monsoon season (June-August), the coast is calm and the plants become less abundant. Increase in abundance resumes around September until its peak around February. The highest abundance ( $20.80 \pm 5.16$  indiv.m<sup>-2</sup> and  $15.20 \pm 6.61$  indiv.m<sup>-2</sup>, respectively) and percent cover ( $11.60 \pm 2.63\%$  and  $8.80 \pm 3.41\%$ , respectively) were recorded in February 2007 and 2008. The number of individuals per m<sup>2</sup> and percent cover in February 2007 were significantly higher than in the months of August ( $p=0.034568$  and  $p=0.012713$ , respectively), September ( $p=0.002883$  and  $p=0.012713$ , respectively) and October

( $p=0.00288$ ) of 2007 when nearly no plants were observed. No significant difference in percent cover was observed between February and October 2007. Peaks in plant biomass were recorded in February 2007 at  $5.21\text{g} \pm 0.78\text{ g.m}^{-2}$  and at lower values in January ( $0.95 \pm 0.30\text{ g.m}^{-2}$ ) and February 2008 ( $0.93 \pm 0.37\text{ g.m}^{-2}$ ). Biomass in February 2007 was significantly higher ( $p=0.018312-0.000286$ ) than in July to December 2007 ( $0-0.95 \pm 0.30\text{ g.m}^{-2}$ ). The lowest recorded biomass was  $0.07 \pm 0.06\text{ g.m}^{-2}$  in November 2007 and  $0.20 \pm 0.09\text{ g.m}^{-2}$  in August 2008. A possible massive spore release occurs somewhere in December and January, explaining the sudden increase in the number of individuals and percent cover that peaks in February. This is supported by a conspicuous growth of young plants observed in the field in December 2007. However, as early as September 2007, a few young individuals that fell outside of the quadrats were already observed. By April 2007 and May 2008, the plants appeared old and became yellowish brown in color. Percent cover and individual count ( $1.20 \pm 0.61\%$  and  $1.60 \pm 1.22\text{ indiv.m}^{-2}$ , respectively) were at its minimum in July 2007 and 2008. No significant differences in number of individuals, percent cover and biomass could be detected among the months in 2008. However, a similar pattern in 2007 was observed.

In **Sawang**, *Portieria* is present all throughout the year. No significant differences in abundance, percent cover and biomass were detected from March 2007 to February 2009. The maximum number of individuals per  $\text{m}^2$  was recorded during the NE monsoon, in December 2007 ( $11.20 \pm 4.65\text{ indiv.m}^{-2}$ ) and in the interim month of October 2008 ( $13.20 \pm 3.21\text{ indiv.m}^{-2}$ ). The percent cover was also at maximum at these months ( $9.20 \pm 3.82\%$  and  $13.20 \pm 3.21\%$ , respectively). However, biomass was highest in April 2007 ( $2.98 \pm 1.31\text{ g.m}^{-2}$ ) and July 2008 ( $7.40 \pm 3.68\text{ g.m}^{-2}$ ). Minimum abundance ( $0.40-0.80\text{ indiv.m}^{-2}$ ), percent cover ( $0.40-0.80\%$ ), and biomass ( $0.01-0.50\text{ g.m}^{-2}$ ) were recorded during the southwest monsoon (August and September 2007, and in August 2008). There were no significant variations detected in abundance, percent cover and biomass through time but field observations suggest two growth cycles. An early growth occurs somewhere at the end of the SW monsoon or in October and peaks in NE monsoon months of November to December and begins to decline in January. A second growth is initiated in the interim period of April and May, which peaks during the SW monsoon months of June and July, and finally declines in August.

In **Pagubagubaan**, *Portieria* is also observed year-round. No significant differences were detected in the number of individuals per  $\text{m}^2$  throughout the survey period but a peak in biomass occurred in the latter period of the NE monsoon and a decrease in the SW monsoon. Biomass significantly increased ( $p=$

0.037391-0.00079) in February 2009 ( $30.23 \pm 6.14 \text{ g.m}^{-2}$ ) compared to the low biomasses in June ( $2.47 \pm 1.08$ ), July ( $3.62 \pm 1.50 \text{ g.m}^{-2}$ ), August ( $2.42 \pm 1.55 \text{ g.m}^{-2}$ ) and September 2008 ( $0.29 \pm 0.08 \text{ g.m}^{-2}$ ). A significant decrease in biomass was also detected from  $40.10 \pm 1.96 \text{ g.m}^{-2}$  in March to  $32.05 \pm 1.8 \text{ g.m}^{-2}$  in September 2008. Percent cover was significantly higher ( $p=0.0318$ ) in February 2009 ( $14.00 \pm 4.27\%$ ) than in September 2008 ( $8.00 \pm 3.27\%$ ). The trend in Pagubagubaa suggests growth of new seedlings around the interim period of October and the beginning of the NW monsoon period in November.

Pagubagubaa had a significantly higher ( $p=0.000$ ) abundance, percent cover and biomass compared to the other sites. No significant differences were detected between the sites, Siaton, Dapdap and Sawang in terms of abundance, percent cover, and biomass. Despite removal of possible outliers, there was low to non-significant correlation observed between the biological and environmental parameters measured.

### 7.3.3 *Thallus height*

Thallus height (Fig. 7.6a-d) in the 4 sites also suggested a seasonality pattern. *Portieria* plants in Siaton were tallest ( $42.53 \pm 0.84 \text{ mm}$ ) in October 2007 and shortest ( $29.00 \pm 2.40 \text{ mm}$ ) in February 2007. A significant decrease ( $p = 0.000214$ ) in the average height of plants was detected between January ( $41.20 \pm 0.85 \text{ mm}$ ) and February 2007. By October 2007, the new generation of plants was already at maximum height and was significantly higher ( $p = 0.000070$ ) than the last ones observed in February 2007. These observations also suggest early growth around the SW monsoon months and its peak around the interim period of October. As the NW monsoon season ends, the tall branches probably defragment leaving shorter branches attached to the holdfast. However, in 2008 no significant differences in height were detected in the first few months. But plants from February to May 2008 ( $36.00 \pm 0.75 \text{ mm}$ –  $42.30 \pm 3.90 \text{ mm}$ ) were significantly taller ( $p = 0.031877$ - $0.000156$ ) than those found in September 2008 ( $22.00 \pm 0.37 \text{ mm}$ ).

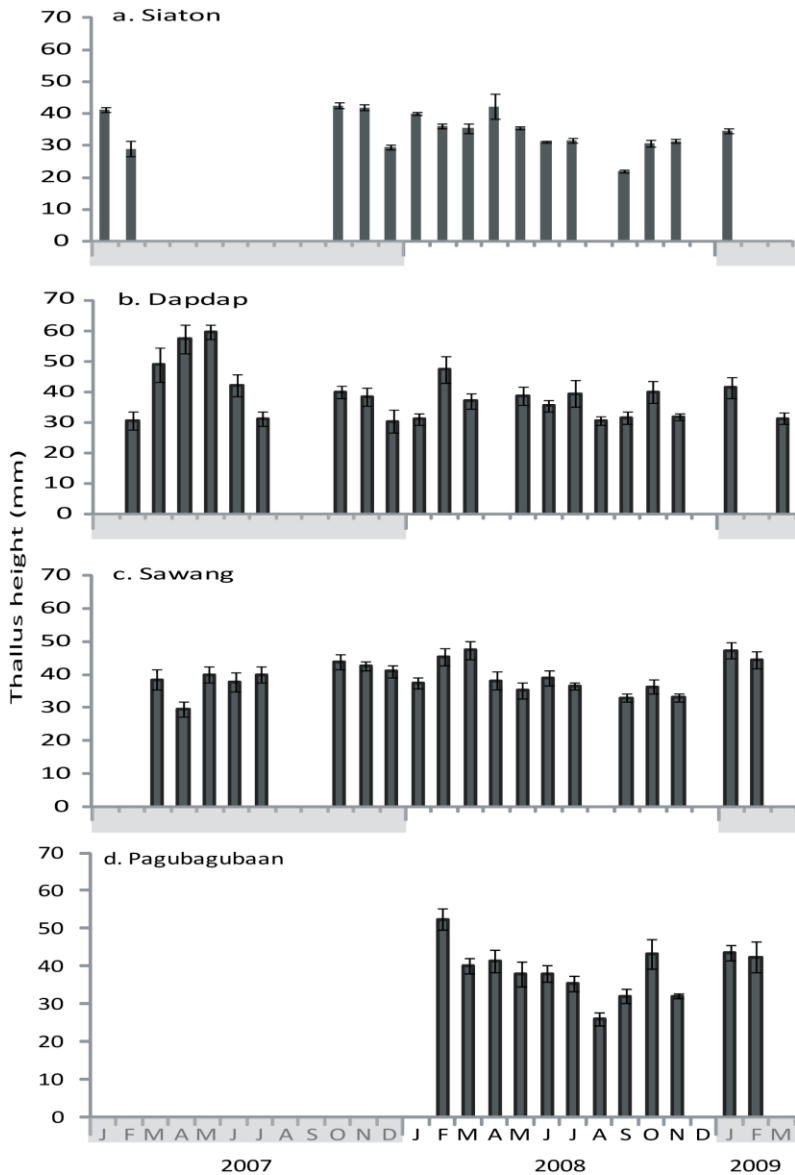

Fig. 7.6. Monthly mean thallus height ( $\pm$  SE) of *Portieria* from 2007-2009 in 4 surveyed sites (a) Siaton (b) Dapdap (c) Sawang (d) Pagubagubaa.

In Dapdap, the maximum average height ( $59.80 \pm 2.34$  mm) and the minimum height ( $30.40 \pm 3.78$  mm) were recorded in May 2007 and December 2007, respectively. Plants grew significantly ( $p=0.022755-0.000244$ ) from February (49.00  $\pm$  5.63 mm) to May 2007. But between April ( $57.5 \pm 4.78$  mm) and July 2007

( $31.22 \pm 2.43$  mm), a significant decrease ( $p=0.024311$ ) in plant height was observed until August when no plants were observed anymore. Young plants observed in December 2007 ( $30.40 \pm 3.78$  mm) were significantly smaller to plants found in April ( $p=0.008903$ ) and May 2007 ( $p=0.000069$ ). No significant height differences have been detected among plants in 2008 until March 2009. However, the maximum average height ( $47.50 \pm 4.47$  mm) and the minimum average height ( $30.64 \pm 1.33$  mm) were observed in February and August 2008, respectively.

The maximum average height of plants in Sawang were recorded in October 2007 ( $43.80$  mm  $\pm$  2.31), March 2008 ( $47.40 \pm 2.69$  mm), and January 2009 ( $47.30 \pm 2.53$  mm). The minimum average height was observed in April 2007 ( $29.60 \pm 2.27$  mm) and September 2008 ( $33.00 \pm 1.18$  mm). Significant differences in plant height were not detected in 2007. However, plants significantly decreased ( $p=0.032366$ - $0.004203$ ) in height beginning February ( $45.40 \pm 2.66$  mm) until November 2008 ( $33.10 \pm 1.20$  mm). While a significant increase ( $p=0.004517$ ) in height occurred between November 2008 and January 2009 ( $47.30 \pm 2.53$  mm).

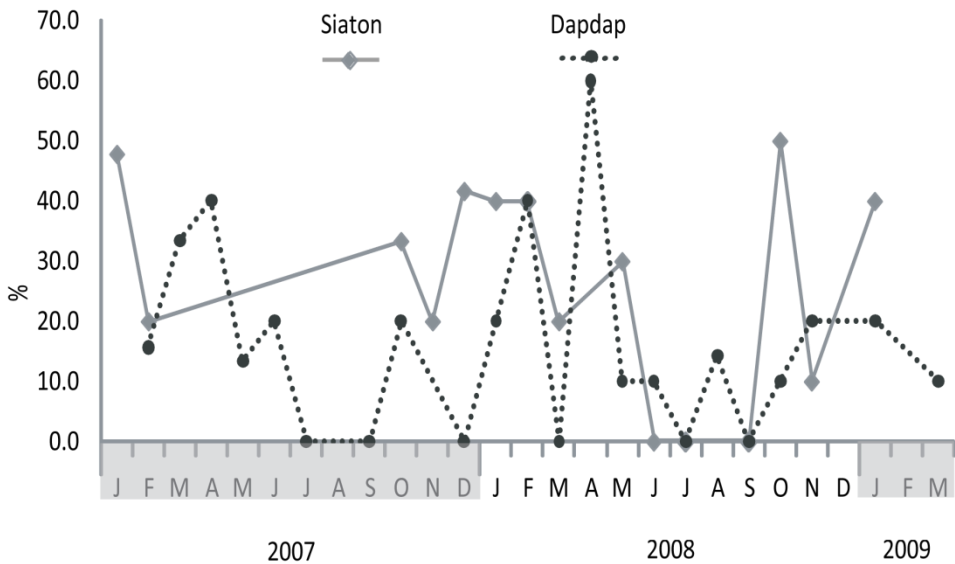

Fig. 7.7. Percentage of cystocarpic plants in Siaton ( $n=10-23$ ) and Dapdap ( $n=5-51$ ) from 2007 to 2009.

This signifies that the batch of plants that grew around April which matured during the SW monsoon season were relatively shorter than those that grew around October and which matured during the NE monsoon. In Pagubagubaaan, a similar pattern was observed. The plants in February 2008 ( $52.40 \pm 2.79$  mm) were significantly taller ( $p=0.025571$ - $0.000234$ ) than the plants in May



( $37.80 \pm 3.31$  mm), June ( $35.47 \pm 2.02$  mm), July ( $35.47 \pm 2.02$  mm), October ( $43.30 \pm 3.96$  mm) and November 2008 ( $32.00 \pm 0.63$  mm).

#### 7.3.4 *Reproductive thalli*

On months when plants were present in Siaton, 10-50% ( $n=10-23$ ) of those randomly examined was cystocarpic (Fig. 7.7). The highest number of cystocarpic plants was observed in the months of January (47.8%) and October (33.3 %) in 2007 and in January (40%), February (40%), and October (50%) in 2008. However, for the months June, July and September 2008, none were cystocarpic for every 10 plants examined. Cystocarpic plants in Dapdap were generally found throughout the year (Fig. 7.6). It composed 10-60 percent of the total number of plants ( $n=5-51$ ) randomly examined for the presence of cystocarps. There was no significant difference in the number of cystocarpic plants found each month. No cystocarpic plants were observed during the surveys in Sawang and Pagubagubaaan. In these localities, only sterile and tetrasporic plants were observed in some of the samples that were verified under the microscope.

### 7.4 Discussion

There are several indications suggesting that *Portieria* favors growth in periods of strong wave actions. In Siaton, when the coast is exposed to waves during the SW monsoon, *Portieria* starts to grow between June to July when large *Sargassum* species have defragmented. Young bright-red plants are very conspicuous in October and remain present until March when they disappear. This disappearance occurs simultaneously with the increase in thallus height and density of several *Sargassum* species. In contrast to Siaton, the Dapdap site is exposed to strong waves during the NE monsoon. Here, majority of the new generation of plants begin growing around October, peaks in the NE monsoon season months of January and February, and declines beginning March, and remains until the end of the SW monsoon. From these observations, it is estimated that a generation of plants in Siaton and Dapdap live for a maximum of 9-10 months. Sawang and Pagubagubaaan are two sites exposed to the waves of the NE and SE monsoon. Two growth cycles were observed in Sawang both during the NE and SE monsoons. It is estimated that a generation of plants in Sawang (and probably, Pagubagubaaan) last for about 5 months. This shorter life span may have to do with the lack of sexual reproduction based on the fact that no cystocarpic plants were observed in the entire study period.

*Portieria*'s seasonal patterns *can* be altered especially by strong disturbances caused by storms and typhoons. It appears that *Portieria* will take any opportunity to grow when surfaces become free from the taller seaweeds. In 2008, a tropical storm (Ambo/Neoguri; April 13-15 2008) and later, a typhoon (Frank/Fengshen; June 18-23, 2008) passed the region clearing up the dense *Sargassum* beds earlier than the period of defragmentation. This allowed appearance of *Portieria* in Siaton as early as May in 2008. In contrast, *Portieria* remained absent for 4 months (March-June) in the previous year when no strong typhoon had occurred.

We suspect that the increased wave motion during the monsoon seasons provides opportunities for *Portieria* populations in two ways: habitat availability and the increased availability of resources for its physiological needs. Waves facilitate the defragmentation of dense canopies of seaweeds, like *Sargassum*, allowing for smaller species such as *Portieria* to grow and have sufficient light for photosynthesis. Several studies have acknowledged the role of water motion in increasing the availability of carbon dioxide and nutrients, in increasing the rate of photosynthesis through the removal of photosynthetic inhibitors like OH<sup>-</sup> ions from the surfaces of the thallus, and in increased light availability (Lüning et al., 1990; Gonen et al., 1995; Hurd, 2000; Ryder et al., 2004; Barr et al., 2008). Increased water motion reduces the diffusion boundary layer (layer of water that builds up next to the organism) surrounding a macroalga through which nutrients and carbon dioxide must pass to reach the plant from the water column (Koehl, 1984; Lüning et al., 1990). Furthermore, increased water motion causes substantial effect on both thallus growth rate and spore development by increased availability of carbon dioxide as has been shown for *Gracilaria parvispora* (Ryder et al., 2004). Ryder *et al.* (2004) also suggested that increased water motion increases survival of newly germinated spores through increased availability of the nutrients.

Several phenological studies of macroalgae in monsoon affected areas have attributed seasonal growth patterns to fluctuation in irradiance, nutrients, seawater temperature, salinity and precipitation (Kong and Ang, 2004; Mayakun and Prathep, 2005; Chung et al., 2007). Our current observations suggest that wave actions during monsoon seasons may have an important role on the seasonal growth of some algae. Future seasonality studies should include quantification of bottom flow patterns and turbulence using clod cards (Ryder et al., 2004) or dynamometers (Palumbi, 1984). Furthermore, future culture attempts of *Portieria* (for example for pharmaceutical purposes) whether in aquaria or in the field should consider sufficient water motion.

## 7.5 Acknowledgements

We are grateful to Jacinta Lucañas and several fishers from Siquijor for field assistance and to the Philippine Atmospheric Geophysical and Atmospheric Services Administration (PAGASA) in Dumaguete City, Philippines for the rainfall data. This research is funded by the Flemish Interuniversity Council (VLIR) as part of the PhD grant to D.A. Payo.



## 7.6 References

- Barr, N.G., Kloeppel, A., Rees, T.A.V., Scherer, C., Taylor, R.B., Wenzel, A., 2008. Wave surge increases rates of growth and nutrient uptake in the green seaweed *Ulva pertusa* maintained at low bulk flow velocities. *Aquatic Biology* 3, 179-186.
- Chung, I.C., Hwang, R.L., Lin, S.H., Wu, T.M., Wu, J.Y., Su, S.W., Chen, C.S., Lee, T.M., 2007. Nutrients, temperature, and salinity as primary factors influencing the temporal dynamics of macroalgal abundance and assemblage structure on a reef of Du-Lang Bay in Taitung in southeastern Taiwan. *Botanical Studies* 48, 419-433.
- Fuller, R.W., Cardellina, J.H., Jurek, J., Scheuer, P.J., Alvaradolindner, B., McGuire, M., Gray, G.N., Steiner, J.R., Clardy, J., Menez, E., Shoemaker, R.H., Newman, D.J., Snader, K.M., Boyd, M.R., 1994. Isolation and structure-activity features of halomon-related antitumor monoterpenes from the red alga *Portieria bornemannii*. *J. Med. Chem.* 37, 4407-4411.
- Fuller, R.W., Cardellina, J.H., Kato, Y., Brinen, L.S., Clardy, J., Snader, K.M., Boyd, M.R., 1992. A pentahalogenated monoterpene from the red alga *Portieria bornemannii* produces a novel cytotoxicity profile against a diverse panel of human tumor-cell lines. *J. Med. Chem.* 35, 3007-3011.
- Gonen, Y., Kimmel, E., Friedlander, M., 1995. Diffusion boundary layer transport in *Gracilaria conferta* (Rhodophyta). *J. Phycol.* 31, 768-773.
- Hurd, C.L., 2000. Water motion, marine macroalgal physiology, and production. *J. Phycol.* 36, 453-472.
- Koehl, M.A.R., 1984. How do benthic organisms withstand moving water? *Integr. Comp. Biol.* 24, 57.
- Kong, C.S.L., Ang, P.O., 2004. Seasonal occurrence and reproduction of *Hypnea charoides* (Rhodophyta) in Tung Ping Chau, NT, Hong Kong SAR, China. *Hydrobiologia* 512, 63-78.
- Lüning, K., Yarish, C., Kirkman, H., 1990. Seaweeds: their environment, biogeography, and ecophysiology. John Wiley & Sons, Inc., New York, p. 527.
- Mayakun, J., Prathep, A., 2005. Seasonal variations in diversity and abundance of macroalgae at Samui Island, Surat Thani Province, Thailand. *Songklanakarin J. Sci. Technol.* 27, 653-663.
- Meñez, E.G., Calumpong, H.P., Newman, D.J., West, J.A., 1996. An account of the red alga *Portieria bornemannii* (Gigartinales, Rhodophyllidaceae) from the Philippines. *Nova Hedvigia* 112, 161-170.
- Ormond, R.F.G., Banaimoon, S.A., 1994. Ecology of intertidal macroalgal assemblages on the Hadramout Coast of Southern Yemen, an area of seasonal upwelling. *Marine Ecology-Progress Series* 105, 105-120.
- Palumbi, S.R., 1984. Measuring intertidal wave forces. *J. Exp. Mar. Biol. Ecol.* 81, 171-179.
- Ryder, E., Nelson, S.G., McKeon, C., Glenn, E.P., Fitzsimmons, K., Napoleon, S., 2004. Effect of water motion on the cultivation of the economic seaweed *Gracilaria parvispora* (Rhodophyta) on Molokai, Hawaii. *Aquaculture* 238, 207-219.
- Silva, P.C., Meñez, E.G., Moe, R.L., 1987. Catalog of the Benthic Marine Algae of the Philippines. Smithsonian Institution Press, Washington, D.C.
- Su, S.W., Chung, I.C., Lee, T.M., 2009. Temporal dynamics of rocky-shore macroalgal assemblage structures in relation to coastal construction threats in Orchard Island (Taiwan): Impacts of turbidity and nutrients on the blooms of *Galaxaura oblongata* and a red alga-sponge symbiose *Ceratodictyon/Haliclona*. *Kurushio Science* 3, 63-80.



## 8 GENERAL DISCUSSION

---

### 8.1 Seaweed species diversity: the red alga *Portieria* as a case study

#### 8.1.1 *Importance of correctly delimiting species*

Accurate delineation of species is crucial. Being widely accepted as a fundamental unit of biological diversity, delineation of species may have implications in ecological and biodiversity studies, conservation efforts and planning, development of evolutionary and biogeographic theories (Bickford et al., 2007; Trontelj and Fišer, 2009; Yang and Rannala, 2010). Incorrect species delimitation may have an important impact on the size of species ranges, formal threat classifications, and the decision over critical areas of biodiversity (Agapow et al., 2004). From an economic and social point of view, correct assessment of biodiversity is important for allocation of conservation funds and resources and conservation schemes (Agapow et al., 2004). Apart from biodiversity studies, fields such as pharmacognosy and natural product studies may benefit from correct species delineation (Pietra, 2002). In chapters 3 and 4, we demonstrated large cryptic diversity in *Portieria bornemannii* in the Indo-Pacific and in the Philippines in particular. As a consequence of the lack of a priori knowledge on this, chemical studies conducted on *Portieria bornemannii* as early as 1974 may actually be referring to different entities or species.

#### 8.1.2 *Species concepts and species delimitation*

Despite the general consensus that species are fundamental units of biological organization, there is long-standing disagreement among biologists about how to divide biodiversity into species (Claridge et al., 1997; Agapow et al., 2004; Richards, 2010). Over twenty different species concepts have been proposed, according to criteria ranging from morphological or molecular similarity to sexual compatibility (Hey, 2006). Three species concepts have been generally applied in algal studies, including the morphological, biological and phylogenetic species concept. The morphological species concept uses discontinuities in the pattern of morphological variation as a criterion for distinguishing species. However, the criterion of morphological similarity is problematic in many algal groups that are morphologically depauperate or exhibit phenotypic plasticity. Despite these known

drawbacks, the morphological species concept is still widely applied in algal systematics. The biological species concept defines a species as members of populations that actually or potentially interbreed in nature. The application of the biological species concept has been applied in several algal groups, including red algae, green algae and diatoms (Hörnig and Schnetter, 1988; Zuccarello and West, 2003; Casteleyn et al., 2008). However, the investigation of sexual compatibility has often been hampered due to difficulties in initiating sexual reproduction in culture conditions, or because several algae are only known to reproduce asexually (reviewed in John and Maggs 1997). The phylogenetic species concept defines species as the smallest diagnosable monophyletic group, and has gained popularity over the years (discussed below). An important problem arising from these species concepts was that different criteria were often in conflict, resulting in ambiguously defined species.

More recently, important conceptual progress has been made in thinking about species by recognizing that the competing species concepts have an underlying commonality to them. In this unifying species concept (termed General Lineage Concept) a species is regarded as a group of individuals that is structured as a metapopulation, which evolves separately from other metapopulations (de Queiroz, 2007). As has been argued by de Queiroz (2005, 2007), “alternative species concepts agree in treating existence as a separately evolving metapopulation lineage as the primary defining property of the species category, but they disagree in adopting different properties acquired by lineages during the course of divergence (e.g., reproductive isolation, morphological diagnosability and monophyly) as secondary defining properties (secondary species criteria).” In other words, under this unified species concept, the “old species concepts” (more appropriately called species properties), are viewed as different lines of evidence (operational criteria) relevant to assessing species boundaries.

### 8.1.3 *DNA-based species delimitation*

Morphological stasis, morphological simplicity and plasticity as exhibited in marine macroalga can make species determination challenging, thus making DNA-based approaches more valuable in species detection. DNA-based taxonomy has been shown to provide a convenient and reliable tool for species delimitation in several organismal groups, including algae (Wiens, 2007; Wiens et al., 2008). The widespread accumulation of genetic data at the interface between populations and species has led to the development of several methods for sequence-based species



---

delimitation, enabling formal analyses of species boundaries (Templeton, 2001; Sites and Marshall, 2003).

Several methods for detecting species limits from DNA sequence data are based on diagnostic character variation, and aggregate a priori populations that lack discrete differences into a single species, which are distinguished from other species by unique nucleotide differences (Cracraft, 1983; Davis and Nixon, 1992; Wiens and Penkrot, 2002). These methods are problematic for many algal groups because a priori information on populations (e.g., morphological or geographical data) is often lacking (Leliaert et al., 2009).

Recently, a number of methods have been developed that incorporate coalescent models within a phylogenetic framework (Pons et al., 2006; Knowles and Carstens, 2007; O'Meara, 2010; Yang and Rannala, 2010). These methods can be broadly separated into two groups: single and multilocus methods. Single-locus methods aim to infer species boundaries from sequence data by analyzing the dynamics of lineage branching in a gene tree, trying to determine the point of transition from species-level (speciation/extinction) to population-level (coalescent) evolutionary processes (Pons et al., 2006; Fontaneto et al., 2007). An important assumption made in these single-locus methods is that gene trees are fully sorted within species. This assumption may be violated through several processes, including incomplete lineage sorting and hybridization. Multilocus methods for species delimitation have been developed that combine species phylogenies and gene genealogies via ancestral coalescent processes (Knowles and Carstens, 2007; Carstens and Dewey, 2010; Yang and Rannala, 2010). These multilocus methods are based on a population genetics perspective that includes prior information about population size and divergence times, two important parameters for making inferences about population history (Rannala and Yang, 2003). Some authors have emphasized the importance of using multilocus over single locus in resolving relationships among closely related species (Dettman et al., 2003; Chase et al., 2005; Destombe et al., 2010). This approach allows the detection of consistent groupings among the several loci used and the examination of possible occurrence of hybridization and incomplete lineage sorting (Destombe et al., 2010). Furthermore, it is also argued that a gene tree does not necessarily reflect the same topology as a species tree (Sites and Marshall, 2004; Galtier and Daubin, 2008; Degnan and Rosenberg, 2009; Meng and Kubatko, 2009; O'Meara, 2010; Yu et al., 2011). Thus, a tree derived from a single gene may not necessarily recover the true species groupings.

Sequenced-based species delimitation is particularly valuable in organisms in which morphological discrimination is difficult or impossible, such as in many algal groups (Saunders, 2005; Verbruggen et al., 2005; Harvey and Goff, 2006; Verbruggen et al., 2007). Although, multilocus approaches have been used in several red algal studies (Maggs et al., 2007), our study on *Portieria* (Chapters 3 and 4) is the first to employ multilocus coalescence based approaches for species delimitation in algae. Our main results are discussed below.

#### 8.1.4 *Cryptic diversity*

The presence of a large number of cryptic species (i.e. morphologically indistinguishable species), especially in the marine environment is continuously being revealed by DNA based studies. Cryptic species are predicted to be more common among marine taxa because these organisms rely heavily on non-visual and chemical mating signals. It is also possible that these organisms are experiencing selection on behavioral or physiological characters promoting morphological stasis (Knowlton, 1993; Knowlton, 2000).

Most studies on marine cryptic species are from temperate regions, and it can be expected that an enormous cryptic diversity is yet to be discovered among tropical species (Bickford et al., 2007). Cryptic and pseudo-cryptic species, i.e. species that can be distinguished once the diagnosable character has been found (Knowlton, 1993; Bickford et al., 2007), have been documented in several algal groups, including the red macroalgae in *Polysiphonia* (McIvor et al., 2001), *Bostrychia* (Zuccarello and West, 2003), *Plocamium* (Saunders and Lehmkuhl, 2005), *Asparagopsis* (Andreakis et al., 2007), *Mastocarpus* (Lindstrom, 2008) and the *Dilsea-Neodilsea* complex (Saunders, 2008), the brown macroalga in *Dictyota* (Tronholm et al., 2010b), and the green algal *Boodlea* complex (Leliaert et al., 2009). Most of these studies dealt with taxa or specimens from temperate regions. Thus, our recent investigations on the cryptic diversity of the red alga *Portieria bornemannii* in the Philippines and the Indo-Pacific (Chapters 3 and 4) are important contributions to a depauperate list of tropical macroalgal cryptic diversity studies.

#### 8.1.5 *Unveiling cryptic diversity in Portieria bornemannii*

The red macroalga *Portieria bornemannii* has been reported from the entire Indo-Pacific. Its supposedly wide distribution included the coasts of East Africa going eastward to the Pacific Islands, and from Japan down to Australia and New Zealand (Guiry and Guiry, 2011). Because of the lack of diagnostic morphological

---

and anatomical structures and a seemingly continuum of forms, some authors have recognized a single species, *Portieria hornemannii*, including *P. harveyi*, *P. japonica*, *P. spinulosa* and *P. tripinnata* as synonyms (Wiseman, 1973; Millar and Van Reine, 2005). Chapters 3 and 4 demonstrate that the recognition of a single species or the separation into the traditional species is both untenable. Instead we show multiple cryptic species within *Portieria*. Chapter 5 has demonstrated that some of these lineages may qualify as pseudocryptic species based on morphometric techniques.

While no quantitative structural and anatomical comparisons have been made among different *Portieria* samples in Chapter 2, the detailed microscopic examination of the different samples from the Indo-Pacific revealed the absence of conspicuous characters useful for species discrimination. Furthermore, anatomical characteristics appeared very similar among specimens such that the continuum of forms observed among *Portieria* specimens warranted a more detailed examination for detectable morphometric boundaries. Chapter 5 has demonstrated the utility of conventional measurements and fractal parameters in unveiling subtle morphological differences between the different *Portieria* species. These morphometric procedures revealed not only the presence of pseudo-cryptic species in the *Portieria* complex but more significantly, the occurrence of morphological differentiation along with lineage diversification. These subtle variations, however, have been detected between distantly related *Portieria* species under study. It might be worthwhile to investigate the scale and tempo at which morphological differences are manifested and established using closely related or recently diverged lineages. Although fine-scale conventional measurements and fractal parameters proved useful in showing morphological differences among lineages, these characters may not prove very useful as practical hints that can guide fast species discrimination, for example, in the field.

In chapters 3 and 4, a combination of DNA-based species delineation approaches were employed to capture species groupings among *Portieria* samples from the Philippines and the rest of the Indo-Pacific. One of the approaches, patterned after the phylogenetic species recognition approach by (Dettman et al., 2003), was to examine gene trees derived from 3 loci (*cox2-3* spacer, EF2, and *rbcL* spacer) for congruence (Chapter 3, Fig. 3). Any incongruence among the gene trees can be used as clues for potential hybrids and/or the presence of incomplete lineage sorting (ILS). Several monophyletic groups were concordantly supported by the three loci, except for some differences within the V1 clade. Single- and multilocus coalescent-based approaches identified additional species within clade V1, indicating that the criteria of reciprocal monophyly and/or genealogical

concordance of independent loci (e.g., Dettman et al. 2003) are too conservative to identify recently diverged species. Further testing using special models and algorithmic approaches might be worthwhile to detect hybridization and ILS in *Portieria* (Maddison and Knowles, 2006; Mossel and Roch, 2008; Joly et al., 2009; Kubatko, 2009; Meng and Kubatko, 2009). Although, *Portieria* can be difficult to culture, breeding studies especially on the recently diverged V1 species can also be explored.

The single-locus general mixed Yule-coalescent (GMYC) model analysis aims to recognize species boundaries from DNA sequences by identifying the shift in the rate of lineage branching which corresponds to the transition from coalescent to speciation branching patterns on a phylogenetic tree (Pons et al., 2006; Leliaert et al., 2009; Monaghan et al., 2009). This model also determines the point of highest likelihood of the transition (Pons et al., 2006; Monaghan et al., 2009). Species delimitation using this method revealed approximately 21 *Portieria* species from the Philippines and 49 species from the entire Indo-Pacific. This model appears to provide a very good approximation of *Portieria* species diversity as corroborated by the strong support for speciation events on tree branches obtained from the multilocus Bayesian species delimitation analysis. The GMYC model is an approach that is appropriate for rapid and large-scale detection of species (Pons et al., 2006), and can be useful for rapid approximation of (cryptic) diversity a certain taxon in a specific area or large geographical region. Species delimitation using the GMYC method has been utilized in green algae (*Boodlea* complex) (Leliaert et al., 2009) and brown algae (*Dictyota*) (Tronholm et al., 2010a, submitted manuscript). The method is first used on red algae in this thesis. Unlike the two previous studies, which utilized nuclear or plastid genes, we used the mitochondrial *cox2-3* spacer for the GMYC species delimitation. The use of a mitochondrial *cox2-3* spacer is an appropriate choice for this method because it provides a high level of sequence variation and exhibits fast coalescence, which makes lineage divergence among cryptic species detectable (Gabrielsen et al., 2002; Provan et al., 2004). Moreover, we showed high congruence with other gene trees (plastid and nuclear). Other studies on red algae have also demonstrated the congruence of the *cox2-3* derived gene tree with other gene trees such as in *Spyridia* (Zuccarello et al., 2002), *Bostrychia* (Zuccarello and West, 2002, 2003) and in *Gracilaria* (Destombe et al., 2010). The proponents of the GMYC method require tests of congruence with additional genetic loci (Monaghan et al., 2009).

We reinforced our single-locus GMYC analysis with multilocus Bayesian species delimitation. Result for the Bayesian species delimitation was in accord with that of

---

the single-locus GMYC. The strength of the former method is the employment of a multilocus, multi-species coalescent framework while addressing gene tree uncertainties such as introgression and incomplete lineage sorting (ILS), which arise often in more recently diverged lineages (Leaché and Fujita, 2010). It takes into account branch lengths on gene trees to distinguish between ancestral lineage sorting and hybridization that form potential species (Yang and Rannala, 2010). It solves these issues by integrating gene tree uncertainties in a Bayesian framework and incorporating a model of ILS via the coalescent process model (Yang and Rannala, 2010). Apart from incorporating two important population genetics parameters, i.e., population size and divergence times), this method requires a guide species tree which specifies relationships among species in the analysis. The species tree was generated using \*BEAST which estimates directly from the sequence data and incorporates the uncertainty associated with gene trees, nucleotide substitution model parameters and the coalescent process (Heled and Drummond, 2008; Leaché and Fujita, 2010). Our Philippine dataset in Chapter 3 displayed partial incongruence in the three loci specifically among the recently diverged V1 species. However, these groups are completely resolved as separate species in this method.

## **8.2 Diversity and evolution of marine Indo-Pacific species**

### *8.2.1 Macroalgal diversity in the Philippines*

It is estimated that there are about 6500 to 7000 species of macroalgae (Lüning et al., 1990; Silva, 1992). While several studies of marine shallow water organisms have shown that the central Indo-West Pacific region known as the Coral Triangle is a center of biodiversity, this is not always the case for macroalgal diversity. Biodiversity studies based on macroalgal distribution datasets show that the most diverse seaweed floras occur in subtropical areas such as Southern Australia, Japan, Mediterranean Sea and Western Europe while species poor areas are in the polar oceans, West Africa and southeast Pacific (Silva, 1992; Bolton, 1994; Phillips, 2001; Kerswell, 2006; Hoeksema, 2007). These findings have been corroborated by the recent report from the Census of Marine Life that some seaweeds peak in diversity and biomass in higher latitudes (Ausubel et al., 2010). While the Coral Triangle does not pass as the center of macroalgal biodiversity, its species richness is still recognized (Silva, 1992; Bolton, 1994; Kerswell, 2006). There are about 900 species reported for the Philippines alone (Bolton, 1994). Silva (1992) acknowledged that the Malay Peninsula extending to the Philippines is poorly known phycologically and that diversity is probably much higher. Diversity

estimates have been mainly based on checklists of species occurrences identified morphologically (Liao and Sotto, 1980; Cordero, 1981; Silva et al., 1987; Trono, 1997; Kraft et al., 1999; Tito et al., 2007). Only a few studies have investigated species diversity within a genus, for example *Caulerpa* (Meñez and Calumpang, 1982; de Senerpont Domis et al., 2003). Apart from these studies, there are no studies addressing possible cryptic species diversity within the Philippines. Thus, it can be expected that seaweed diversity is way far underestimated. Our report on the enormous cryptic diversity found in *Portieria* from the Philippines is very significant as it highlights the potential diversity that remains unexplored in other seaweeds and other marine organisms. This high diversity of *Portieria* in the Philippines as compared to other Indo-Pacific sites may partially be attributed to sampling bias. However, such pattern observed in the Philippines is consistent with observations made in other seaweeds such as *Caulerpa* (Prud'Homme Van Reine et al., 1996) and other marine organisms, for example marine shore fishes (Carpenter and Springer, 2005), cowries (Cypraeidae) (Paulay and Meyer, 2006) and other mollusks (Hoeksema, 2007). On the other hand, it cannot be ignored that if more sites are visited, a potential for a higher diversity than currently reported can be present in non-Philippine sites. Most of these countries (Australia, Indonesia, Kenya, Taiwan, Tanzania, and Oman) revealed one species per collection site (see Table S4.1). Although, the scale of endemism and sympatric diversity remains to be determined with more specimens from closely-distanced sites comparable to the Batanes sites (Philippines). The same can be said to confirm the higher *Portieria* diversity in the Philippines.

### 8.2.2 *Speciation within the Philippines*

Contrary to the previous claims of several authors regarding speciation patterns in the Indo-west Pacific (Santini and Winterbottom, 2002), the pattern of diversity exhibited by *Portieria* in the Philippines and within the Indo-Pacific does not support a single predominant mechanism of speciation. The diversity in *Portieria* (and probably among similar marine organisms) is a product of both speciation within the Philippines and accumulation of species from peripheral areas. The presence of several species of *Portieria* within the Philippines reinforces the claim that seaweeds are overall poor dispersers (Kinlan and Gaines, 2003; Shanks et al., 2003). The young sister lineages (V1A-E, Chapter 4 and 5) best demonstrates the occurrence of speciation in the Philippines. Further clues of speciation in the Philippines can be inferred from a clade showing closer relationship of Philippine lineages with species from the opposite sides of the Indo-Pacific (Maldives and

Hawaii). Although, *Portieria* can be expected to be a poor disperser as demonstrated by studies involving other seaweeds (Kinlan and Gaines, 2003; Shanks et al., 2003), it is possible that over long time scales a population expands and contracts leaving remnants from the periphery to speciate (Briggs, 1999, 2000). Despite its poor dispersal capability, *Portieria* propagules can survive very well the moment it manages to enter a vector for dispersal (such as the current). Paulay and Meyer (2002) argued that endemism through founder speciation is most likely to occur among organisms that rarely enter the transport medium but survive well in it.

Furthermore, the sea-level fluctuations during the Pleistocene caused the making and breaking of land barriers which may have repeatedly separated populations, creating a setting for allopatric speciation (Briggs, 1999). Tectonic events in the Oligo-Miocene epoch caused significant geological changes that created discontinuous land connections and geographical complexity. This prompted opportunities for speciation (McManus, 1985; Williams and Duda Jr, 2008). One of the most important tectonic events in the IWP during the Oligo-Miocene was the collision of the Australia and New Guinea plate with the southeast extremity of the Eurasian plate and the Philippines-Halmahera-New Guinea arc system approximately 25 Ma (Hall, 1998). This was followed soon afterwards by a collision between the Ontong Java plateau and the Melanesian arc. These two events caused significant geological changes in the central IWP that created a discontinuous land connection via the island arcs of Halmahera and the Philippines into Sulawesi, and also changed ocean currents (Hall, 1998). A broad zone of shallow water occurred between Australia and Sulawesi, probably with numerous islands (Hall, 1998). Long, discontinuous island arcs also linked Asia and Melanesia (Hall, 1998). These tectonic events decreased the isolation of the central IWP from more peripheral regions and increased both the amount of shallow-water area and the length of coastline. (Wilson and Rosen, 1998) argue that the geographical complexity of the region provided opportunities for the isolation and origination of new species. An increase in reef-building corals in the central IWP contributed to the radiation of reef-associated organisms such as mollusks and fish (Alfaro et al., 2007; Williams and Duda Jr, 2008).

A possible reinforcing factor of speciation especially those of recent lineages (V1A-E) are the site-specific seasonal patterns of *Portieria* which coincide with monsoonal patterns affecting the areas (Chapter 7). In Chapter 7, it is demonstrated that *Portieria* proliferates during the period of strong wave actions which varies depending on the monsoonal wind affecting a site. Variation in period of proliferation suggests asynchrony in spawning period among the different

populations. This limits gene flow even in closely-distanced sites. Spawning asynchrony presents an opportunity for diversification in marine species (Palumbi, 1994) and this phenomenon has been observed in many sibling/cryptic species (Knowlton, 1993; Palumbi, 1994).

Although speciation may be occurring within the IMA or more precisely, in the Philippines, high diversity in *Portieria* may be due in part from the accumulation of species in this region. Species aggregation may have resulted from complex tectonic reorganizations during the Cenozoic particularly in the last 45, 25 and 5 Ma involving the SE Asian region (Hall, 2002).

### 8.2.3 *Natural product variability in macroalgae*

Reports on marine natural products indicate a wide range of secondary metabolites from marine macroalgae. These compounds vary from halogenated indoles, terpenes, acetogenins, and phenols to halogenated hydrocarbons produced on a large scale (Hay and Fenical, 1996; Moore, 1999; Blunt et al., 2004; Butler and Carter-Franklin, 2004; Cardozo et al., 2007). They are known to vary in their bioactivity properties (e.g. antiviral, antibacterial, and cytotoxic properties) and can have various biomedical and pharmacological uses (Smit, 2004). On an ecological perspective, it has been demonstrated that these compounds are used as chemical cues and can have indirect effects on behavior of organisms (Hay, 2009). Thus, they can strongly influence population and community organization, affect resource allocation, influence competition and mediate species distributions, and select for traits leading to potential diversification of species (Pelletreau and Targett, 2008; Hay, 2009). Despite of its importance, there is an unbalanced research effort between prospecting for potentially useful compounds and understanding the mechanisms behind the production and diversity of these compounds in seaweeds. In the case of *Portieria*, research has focused on the isolation of halogenated compounds from 1974 onwards (Table 1, Chapter 6). Until now, only two studies have employed a biological perspective designed to understand the production of these compounds (Puglisi and Paul, 1997; Matlock et al., 1999). The case of *Portieria* has demonstrated that a lack of biological knowledge can prevent the tapping of potentially useful compounds (such as halomon). Scientists working on the development of halomon into anti-cancer drug were beset with the unstable supply of halomon-containing *Portieria* extracts from natural samples (Fuller et al., 1992; Fuller et al., 1994). Our data has shown that *Portieria* includes numerous cryptic or pseudo-cryptic species (Chapters 3 and 4) and that intraspecific variability of secondary metabolites is also present among the different life stages (Chapter 6).



---

The absence of such biological information has prevented drug and biomedical scientists from undertaking research decisions that would have allowed further drug development of halomon. Although it is known that secondary metabolites are derived from a combination of phylogenetic and ecological factors (Pelletreau and Targett, 2008), the relationship between cryptic species and secondary metabolite patterns in marine macroalgae has rarely been investigated. In contrast, studies on chemical diversity in other marine organisms, for example, among bryozoans, marine actinomycetes and cyanobacteria, are being conducted in tandem with phylogenetic diversity investigations (McGovern and Hellberg, 2003; Jensen et al., 2005; Jensen et al., 2007). These studies showed a degree of species specificity on the production of secondary metabolites. On the other hand, a few studies concerned with the distribution of secondary metabolites demonstrated within thallus variation, for example, in *Dictyota* (Cronin and Hay, 1996; Dworjanyn et al., 1999), *Delisea* (Dworjanyn et al., 1999), and *Caulerpa* (Meyer and Paul, 1992). The result on the chemical variation among life-history stages in *Portieria* is corroborated by studies conducted in *Asparagopsis* (Verges et al., 2008) and *Dictyota* (Cavalcanti et al., 2010). However, some of these investigations were conducted in context with the palatability of these different stages among grazers. The relationship between grazing pressure and secondary metabolite variation in *Portieria* remains to be pursued.

### 8.3 Future prospects

*Portieria* is one of the severely understudied taxa among marine macroalgae. This thesis has greatly improved our understanding of diversity, distributions, evolution, ecology and chemical composition of *Portieria*; however, many questions remain. With the knowledge of the enormous cryptic and pseudocryptic diversity in *Portieria*, additional data probably will be needed to understand the link between these different lineages and the production of metabolites. Chapter 6 has only examined secondary metabolite variation between Batanes lineages. Therefore, the extent of this variation can be determined through closely and distantly-related lineages. GC-MS spectra from different lineages can be used to assess chemosystematic potentials of some compounds. Chapter 6 (Table 1) shows that some compounds can be exclusive to a species. Furthermore, this study has provided strong indications that specific compounds can potentially be exclusive to certain life stages and/or *Portieria* species. These new insights may guide future bioprospecting efforts.

The determination of the influence of grazers on the secondary metabolite production has not been successfully carried out during the course of this study. Early attempts to grow field-collected *Portieria* in aquaria were beset by death due to high temperature in the aquaria environment. Results on the seasonality chapter (Chapter 7) suggest the need of such plants for strong wave actions. Thus, any future attempt to grow these plants in the aquaria will have to consider options to mimic this environmental requirement. Another obstacle for this experiment was the continuous larval development of the seahare *Aplysia* on the thallus of the alga. While adults and eggs were easy to remove from the thallus, this microscopic stage of the natural *Portieria* herbivore was difficult to get rid. Future grazing studies will need to find ways to disinfect the plants from *Aplysia* larvae or to assess the utility of the UV light for such purpose.

The seasonality pattern observed in *Portieria* has not been reported in any other seaweed taxa or in other marine organisms. Ecological studies on other organisms can also be conducted in this light to confirm the extent of the influence of monsoons on benthic organisms. Our seasonality study on *Portieria* suggests the importance of water motion or wave action on monsoon seasons on the seasonal growth of some algae. Bottom flow patterns and turbulence can be quantified using clod cards (Ryder et al., 2004) or dynamometers (Palumbi, 1984) during the period of seasonality study.

Future efforts can also be directed to determining the presence of associated microbes influencing variation of the production of metabolites. It is obvious that *Portieria* produces metabolites as shown by the intraspecies variation among life-history stages. However, the lack of geographical or temporal pattern may not only be influenced by life-history stage variation but also by different associated microbes that produce their own compounds. Bacteria associated with sponges have been found responsible in the production of compounds (Moore, 2006; Thomas et al., 2010). Geographic variation among secondary metabolites can be due to difference in associated bacteria.

In the Philippines, genetic connectivity of coral reefs has been used to justify the establishment of marine protected areas that are of close proximity (Palumbi, 2001, 2003). The design of marine reserves requires understanding of larval transport in and out of reserves (Palumbi, 2003). While *Portieria* generally appears to be lowly dispersed, lineage V32 in the Visayas has been successfully distributed in several islands. Local current patterns as well the extent of the distribution of lineage V32 may be used to understand local dispersal patterns and connectivity in the Visayas. *Portieria* has no current economic value which makes it

---

an uncultivated species. Therefore, its distribution may not be significantly influenced by humans as in other cultivated species. This makes it an ideal species for population genetic connectivity studies.

#### 8.4 Taxonomic implications

Our analyses have shown considerable conflict between morphological and DNA-based species definitions, resulting in incongruence between DNA-based species diversity and traditional taxonomy. About 12 *Portieria* species have been described based on morphological criteria (Wiseman, 1973), of which about seven are currently recognized (Guiry and Guiry 2011, Silva et al. 1987). Our studies unveil a much higher diversity of at least 51 species in the Indo-Pacific. These results have an immediate impact on the common habit of taxonomists to describe newly discovered species formally using a system that builds on the practices initiated more than 250 years ago by Linnaeus. The introduction of DNA to identify and genotype species, made phycologists realise from an early stage onwards that there is no one-to-one relationship between morphology and species diversity as reflected in the genotype. Nearly every group of algae that was scrutinized revealed non-neglectable levels of cryptic diversity. As long the slope of the morphology/genotypic diversity slope was not too steep, however, taxonomists felt comfortable describing the odd (pseudo-)cryptic species. Our data, however, demonstrate that a single algal morphospecies may contain as many as 51 phylogenetic species, and there is no reason to believe that increased taxon sampling will not turn out another 50 or even more species. From the perspective of a practical taxonomist this makes one feel really uncomfortable, because at the very heart of descriptive taxonomy lies utilitarian perspective. The extreme levels of cryptic diversity as observed in *Portieria* are clearly at odds with this utilitarian perspective, for one is never going to recognize or identify the individual species. We could give them numbers or letters, similar to strains of *Symbiodinium* living as zooxanthellia in coral polyps (Coffroth and Santos, 2005) or species of the green algal *Boodlea*-complex (Leliaert et al., 2009), respectively.

A major source of uncertainty, however, is formed by linking the literature names to the extant diversity. Following the Linnean classification system, the identity of the type specimen will determine which names should be applied to which clades. If the morphology or geographic origin of the type specimens is inconclusive, one could potentially attempt to sequence type specimens, but it should be realized that is a costly and time-consuming exercise. Furthermore, the degree to which cryptic diversity is unveiled in this study makes it a daunting task.

Therefore, it might be necessary to discontinue the use of these names if it is not absolute if a specimen is genetically identical to the type material. In addition, the diversity revealed in our study is much higher than the number of currently described *Portieria* species, which imply that a large part of the diversity would have to be formally described according to the rules of botanical nomenclature (ICBN 2011).

Formal taxonomic nomenclature (traditional taxonomy) is important in developing awareness of visually (or may involve other senses) perceptible differences between distantly related species. For a practical example, it is necessary to know the basic morphological characters of *Portieria* to be able to distinguish it in the field against a similarly branching alga like *Plocamium* (Family Plocamiaceae). Earlier descriptions on *Portieria* have proved sufficient in distinguishing this plant against similarly looking non-sibling species. Since *Portieria* has limited morphological divergence and distinguishing characters that can be easily defined by human eye, it might no longer be necessary to describe each species in the traditional manner. The emergence of 51 *Portieria* sibling species needs to be handled with pragmatism. Whether all these new species have to be described in the traditional manner, the answer should be in consideration of the costs and benefits of describing each species. Describing new species in the traditional manner requires searching and describing the gap in the morphological continuum which might be difficult or not at all present in many *Portieria* species. It has been estimated that an average taxonomist describes an average 24.8 new species in an entire career and about US\$48, 500 per species (Mora et al., 2011). These estimates might not completely apply to *Portieria* but the cost and the time devoted will most likely outweigh the benefits, if there are any. In a period of rapid biodiversity decline, priorities may have to be given to cost efficient procedures.

In cases where research objectives require that sibling species be distinguished, such as in pharmacognosy, then these entities can be efficiently identified with molecular characters. These 51 sibling species can be assigned with permanent codes that correspond to their DNA characters which can serve as standards for future references. The use of morphometric techniques in *Portieria* managed to “decrypt” some of its member species. The parameters used demonstrated the distinctive morphology of some lineages, most particularly V32. These morphometric dimensions may be fed into artificial neural network systems that can automate recognition and classification of plants (Pandolfi 2006). Although, the method appears useful, DNA analysis is a more efficient species identification or classification tool compared to the entire process of image and

---

statistical analyses. DNA presents a stable and accurate information on the identity of a species while morphometric values can present a high degree of variance which can be due to for example, measurement lapses. Plants afflicted with diseases may also exhibit a different form than usual. The essence of morphometric application on *Portieria* in this study was its utility in demonstrating the occurrence of morphological divergence along with genetic differentiation.

### 8.5 Significance of the study in the Philippine setting

The need to study the genetic biodiversity of the Philippine flora and fauna is slowly being recognized with the recent efforts by Filipino geneticists and the Department of Science and Technology to establish the University of the Philippines- Philippine Genome Center. This study therefore serves as a timely contribution to the knowledge of the scale of macroalgal diversity that needs to be expected, studied, and allocated with research funds.

### 8.6 Conclusions

The genus *Portieria* shares a similar basic structure with other members of the Rhizophyllidaceae such as a pseudoparenchymatous thallus with inner cells differentiated into cellular medulla and peripheral cells into a cortical layer, thin rhizoidal filaments, large gland cells, and most likely, the absence of secondary pit connections. Non-procarpic reproduction and the presence of nemathecium in all life-history stages are also consistent with the rest of the members of the Rhizophyllidaceae. Molecular sequence analysis confirms close phylogenetic relationships among genera of the Rhizophyllidaceae. *Contarinia* is resolved as a sister taxon of a clade uniting *Nesophila*, *Ochtodes* and *Portieria*.

The genus *Portieria* has at least 21 species in the Philippines based on coalescent based single locus (General Mixed Yule Coalescent Model) and multilocus (Bayesian species delimitation) species delimitation approaches. These gene sequence analyses demonstrate that previous morphology-based species circumscriptions underestimate *Portieria* diversity in the respective region. The congruence observed between the single-locus and multilocus species delimitation analyses is an important finding as it supports the utility of single but fast coalescing loci for species delimitation. The diversity pattern of *Portieria* in the Philippines demonstrates that species level diversity may be structured at a much smaller scale (<100 km). This finding may have an important implication for the establishment and management of marine conservation areas.

Although several tropical groups exhibit highly congruent patterns of biodiversity, with a prominent hotspot in the Indo-Malayan Archipelago (IMA), there may be no single explanation for this pattern. Given the age and complex geological history, along with the vast biological diversity of (IMA), it is likely that multiple processes have probably been at work over long temporal scales (Barber, 2009, Halas & Winterbottom, 2009). Our phylogenetic analysis of *Portieria* in the Indo-Pacific reflect the long and complex evolutionary history of this seaweed and suggests that the observed biogeographical patterns are a combination of long-term persistence of ancient lineages within confined geographical regions, including the IMA, along with more recent speciation events, possibly related to the climatic changes in the Pleistocene. The IMA biodiversity hotspot has provided a focus for numerous evolutionary and ecological studies, which have in their turn supported strategies for conservation efforts (Carpenter *et al.*, 2008). Our study adds to the growing body of evidence that the present-day species richness within the IMA hotspot results from long and intricate evolutionary trajectories. For many organismal groups, the IMA likely serves as both a species pump and a “museum” of biodiversity, harboring ancient lineages that were formed prior to the geological formation of the coral triangle. Ecological and conservation related research also depends on a clear understanding of species boundaries, which is often problematic due to the prevalence of cryptic species in marine environments (Bickford *et al.*, 2007). This study shows clearly that misconceptions about species boundaries may impact on our understanding of distributions and diversification of tropical seaweeds.

Diversification in some *Portieria* species did coincide with subtle morphological differentiations which are detectable through morphometric analyses (fractal, non-conventional, and conventional variables). At least some species can therefore be classified as pseudocryptic.

*Portieria* species in the Philippines are a rich source of secondary metabolites. This diversity in secondary metabolites amounts to at least 302 various compounds. The majority of which are exotic, remain undescribed and therefore are not available in natural product databases. Intraspecific variation in secondary metabolites occurs between life-history stages. Female gametophytes (202 compounds) are chemically richer compared to that of the males (102) and tetrasporophytes (106). Variation in secondary metabolites also occurs between as well as within these species. These results suggest that life-history driven variations and possibly other microscale factors may have an important influence on the variation within *Portieria* species.

---

*Portieria* species in the Philippines have a site-specific seasonality that is influenced by strong wave actions influenced by monsoonal winds. The increased wave motion during the monsoon seasons provides opportunities for *Portieria* populations in two ways: habitat availability and the increased availability of resources for its physiological needs.





## 8.7 References

- Agapow, P.M., Bininda-Emonds, O.R.P., Crandall, K.A., Gittleman, J.L., Mace, G.M., Marshall, J.C., Purvis, A., 2004. The impact of species concept on biodiversity studies. *Q. Rev. Biol.*, 161-179.
- Alfaro, M.E., Santini, F., Brock, C.D., Schwenk, K., 2007. Do reefs drive diversification in marine teleosts? Evidence from the pufferfish and their allies (Order Tetraodontiformes). *Evolution* 61, 2104-2126.
- Andreakis, N., Procaccini, G., Maggs, C., Kooistra, W.H.C.F., 2007. Phylogeography of the invasive seaweed *Asparagopsis* (Bonnemaisoniales, Rhodophyta) reveals cryptic diversity. *Mol. Ecol.* 16, 2285-2299.
- Ausubel, J.H., Crist, D.T., Waggoner, P.E. (Eds.), 2010. First census of marine life 2010: Highlights of a decade of discovery. Census of Marine Life, Washington D.C.
- Barber, P.H., 2009. The challenge of understanding the Coral Triangle biodiversity hotspot. *Journal of Biogeography* 36, 1845-1846.
- Bickford, D., Lohman, D.J., Sodhi, N.S., Ng, P.K.L., Meier, R., Winker, K., Ingram, K.K., Das, I., 2007. Cryptic species as a window on diversity and conservation. *Trends Ecol. Evol.* 22, 148-155.
- Blunt, J.W., Copp, B.R., Munro, M.H.G., Northcote, P.T., Prinsep, M.R., 2004. Marine natural products. *Nat. Prod. Rep.* 21, 1-49.
- Bolton, J.J., 1994. Global seaweed diversity: patterns and anomalies. *Bot. Mar.* 37, 241-246.
- Briggs, J.C., 1999. Modes of speciation: marine Indo-West Pacific. *Bull. Mar. Sci.* 65, 645-656.
- Briggs, J.C., 2000. Centrifugal speciation and centres of origin. *J. Biogeogr.* 27, 1183-1188.
- Butler, A., Carter-Franklin, J.N., 2004. The role of vanadium bromoperoxidase in the biosynthesis of halogenated marine natural products. *Nat. Prod. Rep.* 21, 180-188.
- Cardozo, K.H.M., Guaratini, T., Barros, M.P., Falcão, V.R., Tonon, A.P., Lopes, N.P., Campos, S., Torres, M.A., Souza, A.O., Colepicolo, P., 2007. Metabolites from algae with economical impact. *Comp. Biochem. Phys. C*: 146, 60-78.
- Carpenter, K.E., Springer, V.G., 2005. The center of the center of marine shore fish biodiversity: the Philippine Islands. *Environ. Biol. Fishes* 72, 467-480.
- Carpenter, K.E., Abrar, M., Aeby, G., Aronson, R.B., Banks, S., Bruckner, A., Chiriboga, A., Cortes, J., Delbeek, J.C., DeVantier, L., Edgar, G.J., Edwards, A.J., Fenner, D., Guzman, H.M., Hoeksema, B.W., Hodgson, G., Johan, O., Licuanan, W.Y., Livingstone, S.R., Lovell, E.R., Moore, J.A., Obura, D.O., Ochavillo, D., Polidoro, B.A., Precht, W.F., Quibilan, M.C., Reboton, C., Richards, Z.T., Rogers, A.D., Sanciangco, J., Sheppard, A., Sheppard, C., Smith, J., Stuart, S., Turak, E., Veron, J.E.N., Wallace, C., Weil, E., Wood, E., 2008. One-third of reef-building corals face elevated extinction risk from climate change and local impacts. *Science* 321, 560-563.
- Carstens, B.C., Dewey, T.A., 2010. Species delimitation using a combined coalescent and information-theoretic approach: an example from North American *Myotis* bats. *Syst. Biol.* 59, 400.
- Casteleyn, G., Chepurinov, V.A., Leliaert, F., Mann, D.G., Bates, S.S., Lundholm, N., Rhodes, L., Sabbe, K., Vyverman, W., 2008. *Pseudo-nitzschia pungens* (Bacillariophyceae): a cosmopolitan diatom species? *Harmful Algae* 7, 241-257.
- Cavalcanti, D.N., de Oliveira, M.A.R., De-Paula, J.C., Barbosa, L.S., Fogel, T., Pinto, M.A., de Palmer Paixão, I.C.N., Teixeira, V.L., 2010. Variability of a diterpene with potential anti-HIV activity isolated from the Brazilian brown alga *Dicyota menstrualis*. *J. Appl. Phycol.*, 1-4.
- Chase, M.W., Salamin, N., Wilkinson, M., Dunwell, J.M., Kesanakurthi, R.P., Haidar, N., Savolainen, V., 2005. Land plants and DNA barcodes: short-term and long-term goals. *Philos. T. Roy. Soc. B*: 360, 1889.
- Claridge, M.A., Dawah, H.A., Wilson, M.R., 1997. Species: the units of diversity. Chapman and Hall, London.

- Cordero, P.A., 1981. Studies on Philippine marine red algae. National Museum of the Philippines, Manila.
- Coffroth, M.A., Santos, S.R., 2005. Genetic diversity of symbiotic dinoflagellates in the genus *Symbiodinium*. *Protist* 156, 19-34.
- Cracraft, J., 1983. Species concepts and speciation analysis. *Curr Ornithol* 1, 159-187.
- Cronin, G., Hay, M.E., 1996. Within plant variation in seaweed palatability and chemical defenses: Optimal defense theory versus the growth differentiation balance hypothesis. *Oecologia* 105, 361-368.
- Davis, J.I., Nixon, K.C., 1992. Populations, genetic variation, and the delimitation of phylogenetic species. *Syst. Biol.* 41, 421.
- de Queiroz, K., 2005. Different species problems and their resolution. *Bioessays* 27, 1263-1269.
- de Queiroz, K., 2007. Species concepts and species delimitation. *Syst. Biol.* 56, 879.
- de Senerpont Domis, L.N., Fama, P., Bartlett, A.J., Prud'homme van reine, W.F., Espinosa, C.A., Trono, G.C., 2003. Defining taxon boundaries in members of the morphologically and genetically plastic genus *Caulerpa* (Caulerpaceae, Chlorophyta). *J. Phycol.* 39, 1019-1037.
- Degnan, J.H., Rosenberg, N.A., 2009. Gene tree discordance, phylogenetic inference and the multispecies coalescent. *Trends Ecol. Evol.* 24, 332-340.
- Destombe, C., Valero, M., Guillemain, M.L., 2010. Delineation of two sibling red algal species, *Gracilaria gracilis* and *Gracilaria dura* (Gracilariales, Rhodophyta), using multiple DNA markers: resurrection of the species *G. dura* previously described in the Northern Atlantic 200 years ago. *J. Phycol.* 46, 720-727.
- Dettman, J.R., Jacobson, D.J., Taylor, J.W., 2003. A multilocus genealogical approach to phylogenetic species recognition in the model eukaryote *Neurospora*. *Evolution* 57, 2703-2720.
- Dworjanyan, S.A., De Nys, R., Steinberg, P.D., 1999. Localisation and surface quantification of secondary metabolites in the red alga *Delisea pulchra*. *Mar. Biol.* 133, 727-736.
- Fontaneto, D., Herniou, E.A., Boschetti, C., Caprioli, M., Melone, G., Ricci, C., Barraclough, T.G., 2007. Independently evolving species in asexual bdelloid rotifers. *PLoS Biol.* 5, 914-921.
- Fuller, R.W., Cardellina, J.H., Jurek, J., Scheuer, P.J., Alvaradolindner, B., McGuire, M., Gray, G.N., Steiner, J.R., Clardy, J., Menez, E., Shoemaker, R.H., Newman, D.J., Snader, K.M., Boyd, M.R., 1994. Isolation and structure activity features of halomon-related antitumor monoterpenes from the red alga *Portieria hornemannii* J. *Med. Chem.* 37, 4407-4411.
- Fuller, R.W., Cardellina, J.H., Kato, Y., Brinen, L.S., Clardy, J., Snader, K.M., Boyd, M.R., 1992. A pentahalogenated monoterpene from the red alga *Portieria hornemannii* produces a novel cytotoxicity profile against a diverse panel of human tumor cell lines J. *Med. Chem.* 35, 3007-3011.
- Gabrielsen, T.M., Brochmann, C., Rueness, J., 2002. The Baltic Sea as a model system for studying postglacial colonization and ecological differentiation, exemplified by the red alga *Ceramium tenuicorne*. *Mol. Ecol.* 11, 2083-2095.
- Galtier, N., Daubin, V., 2008. Dealing with incongruence in phylogenomic analyses. *Philos. T. Roy. Soc. B*: 363, 4023-4029.
- Guiry, M.D., Guiry, G.M., 2011. AlgaeBase. World-wide electronic publication, National University of Ireland, Galway. <http://www.algaebase.org>; searched on 19 June 2011.
- Halas, D., Winterbottom, R., 2009. A phylogenetic test of multiple proposals for the origins of the East Indies coral reef biota. *J. Biogr.* 36, 1847-1860.
- Hall, R., 1998. The plate tectonics of Cenozoic SE Asia and the distribution of land and sea. In: Hall, R., Holloway, J.D. (Eds.), *Biogeography and geological evolution of SE Asia*. Backhuys Publishers, Leiden, pp. 99-131.
- Hall, R., 2002. Cenozoic geological and plate tectonic evolution of SE Asia and the SW Pacific: computer-based reconstructions, model and animations. *J. Asian Earth Sci* 20, 353-431.
- Harvey, J.B.J., Goff, L.J., 2006. A reassessment of species boundaries in *Cystoseira* and *Halidrys* (Phaeophyceae, Fucales) along the North American west coast. *J. Phycol.* 42, 707-720.

- Hay, M.E., 2009. Marine chemical ecology: Chemical signals and cues structure marine populations, communities, and ecosystems. *Ann. Rev. Mar. Sci.* 1, 193-212.
- Hay, M.E., Fenical, W., 1996. Chemical ecology and marine biodiversity: insights and products from the sea. *Oceanography* 9.
- Heled, J., Drummond, A., 2008. Bayesian inference of population size history from multiple loci. *BMC Evol. Biol.* 8, 289.
- Hey, J., 2006. On the failure of modern species concepts. *Trends Ecol. Evol.* 21, 447-450.
- Hocksema, B., 2007. Delineation of the Indo-Malayan centre of maximum marine biodiversity: the coral triangle. In: Renema, W. (Ed.), *Biogeography, Time and Place: Distributions, Barriers and Islands: Topics in Geobiology*. Springer, Dordrecht, pp. 117-178.
- Hörnig, I., Schnetter, R., 1988. Notes on *Dictyota dichotoma*, *D. menstrualis*, *D. indica* and *D. pulchella* spec. nova (Phaeophyta). *Phyton (Austria)* 28, 277-291.
- Jensen, P.R., Mincer, T.J., Williams, P.G., Fenical, W., 2005. Marine actinomycete diversity and natural product discovery. *Antonie Van Leeuwenboek* 87, 43-48.
- Jensen, P.R., Williams, P.G., Oh, D.C., Zeigler, L., Fenical, W., 2007. Species-specific secondary metabolite production in marine actinomycetes of the genus *Salinispora*. *Appl. Environ. Microbiol.* 73, 1146.
- John, D.M., Maggs, C.A., 1997. Species problems in eukaryotic algae: a modern perspective. In: Claridge, M.F., Dawah, H.A., Wilson, M.R. (Eds.), *Systematics Association Special Volume*, pp. 83-107.
- Joly, S., McLenachan, P.A., Lockhart, P.J., 2009. A statistical approach for distinguishing hybridization and incomplete lineage sorting. *Am. Nat.* 174, E54-70.
- Kerswell, A.P., 2006. Global biodiversity patterns of benthic marine algae. *Ecology* 87, 2479-2488.
- Kinlan, B.P., Gaines, S.D., 2003. Propagule dispersal in marine and terrestrial environments: a community perspective. *Ecology* 84, 2007-2020.
- Knowles, L.L., Carstens, B.C., 2007. Delimiting species without monophyletic gene trees. *Syst. Biol.* 56, 887.
- Knowlton, N., 1993. Sibling species in the sea. *Annu. Rev. Ecol. Syst.* 24, 189-216.
- Knowlton, N., 2000. Molecular genetic analyses of species boundaries in the sea. *Hydrobiologia* 420, 73-90.
- Kraft, G.T., Liao, L.M., Millar, A.J.K., Coppejans, E.G.G., Hommersand, M.H., Freshwater, D.W., 1999. Marine benthic red algae (Rhodophyta) from Bulusan, Sorsogon Province, Southern Luzon (Philippines). *Philippine Scientist (Philippines)*.
- Kubatko, L.S., 2009. Identifying hybridization events in the presence of coalescence via model selection. *Syst. Biol.* 58, 478-488.
- Leaché, A.D., Fujita, M.K., 2010. Bayesian species delimitation in West African forest geckos (*Hemidactylus fasciatus*). *P. Roy. Soc. B: Bio.* 277, 3071.
- Leliaert, F., Verbruggen, H., Wysor, B., De Clerck, O., 2009. DNA taxonomy in morphologically plastic taxa: Algorithmic species delimitation in the *Boodlea* complex (Chlorophyta: Cladophorales). *Mol. Phylogen. Evol.* 53, 122-133.
- Liao, L., Sotto, F.B., 1980. A preliminary list of marine algae of Mactan Island and the neighboring islands (Cebu, Philippines). *The Philipp. Sci* 17, 94-100.
- Lindstrom, S.C., 2008. Cryptic diversity and phylogenetic relationship and phylogenetic relationships within the *Mastocarpus papillatus* species complex (Rhodophyta, Phylloporaceae). *J. Phycol.* 44, 1300-1308.
- Lüning, K., Yarish, C., Kirkman, H., 1990. *Seaweeds: their environment, biogeography, and ecophysiology*. Wiley-Interscience.
- Maddison, W.P., Knowles, L.L., 2006. Inferring phylogeny despite incomplete lineage sorting. *Syst. Biol.* 55, 21.
- Maggs, C.A., Verbruggen, H., De Clerck, O. (Eds.), 2007. 6 Molecular systematics of red algae: building future structures on firm foundations. In *Unravelling the Algae: the Past, Present,*

- and Future of Algal Systematics (Brodie J. and Lewis J. editors), 103-121, CRC Press, Boca Raton, USA.
- Matlock, D.B., Ginsburg, D.W., Paul, V.J., 1999. Spatial variability in secondary metabolite production by the tropical red alga *Portieria hornemannii*. *Hydrobiologia* 399, 267-273.
- McGovern, T.M., Hellberg, M.E., 2003. Cryptic species, cryptic endosymbionts, and geographical variation in chemical defences in the bryozoan *Bugula neritina*. *Mol. Ecol.* 12, 1207-1215.
- McIvor, L., Maggs, C.A., Provan, J., Stanhope, M.J., 2001. *rbtL* sequences reveal multiple cryptic introductions of the Japanese red alga *Polysiphonia harveyi*. *Mol. Ecol.* 10, 911-919.
- McManus, J.W., 1985, Marine speciation, tectonics and sea-level changes in Southeast Asia. pp. 133-138.
- Meñez, E.G., Calumpong, H.P., 1982. The genus *Caulerpa* from Central Visayas, Philippines. *Smithson. Contrib. Mar. Sci.*
- Meng, C., Kubatko, L.S., 2009. Detecting hybrid speciation in the presence of incomplete lineage sorting using gene tree incongruence: A model. *Theor. Popul. Biol.* 75, 35-45.
- Meyer, K.D., Paul, V.J., 1992. Intraplant variation in secondary metabolite concentration in 3 species of *Caulerpa* (Chlorophyta, Caulerpales) and its effects on herbivorous fishes. *Mar. Ecol.-Prog. Ser.* 82, 249-257.
- Millar, A.J.K., Van Reine, W.F.P., 2005. Marine benthic macroalgae collected by Vieillard from New Caledonia and described as new species by Kützinger. *Phycologia* 44, 536-549.
- Monaghan, M.T., Wild, R., Elliot, M., Fujisawa, T., Balke, M., Inward, D.J.G., Lees, D.C., Ranaivosolo, R., Eggleton, P., Barraclough, T.G., Vogler, A.P., 2009. Accelerated species inventory on Madagascar using coalescent-based models of species delineation. *Syst Biol* 58, 298-311.
- Moore, B.S., 1999. Biosynthesis of marine natural products: microorganisms and macroalgae. *Nat. Prod. Rep.* 16, 653-674.
- Moore, B.S., 2006. Biosynthesis of marine natural products: macroorganisms (Part B). *Nat. Prod. Rep.* 23, 615-629.
- Mora, C., Tittensor, D.P., Adl, S., Simpson, A.G.B., Worm, B., 2011. How many species are there on Earth and in the ocean? *PLoS Biol.* 9, e1001127.
- Mossel, E., Roch, S., 2008. Incomplete lineage sorting: consistent phylogeny estimation from multiple loci. *IEEE IEEE/ACM Trans. Comput. Biol. Bioinf.*, 166-171.
- O'Meara, B.C., 2010. New heuristic methods for joint species delimitation and species tree inference. *Syst. Biol.* 59, 59.
- Palumbi, S.R., 1984. Measuring intertidal wave forces. *J. Exp. Mar. Biol. Ecol.* 81, 171-179.
- Palumbi, S.R., 1994. Genetic-divergence, reproductive isolation and marine speciation *Annu. Rev. Ecol. Syst.* 25, 547-572.
- Palumbi, S.R., 2001. The ecology of marine protected areas. *Marine community ecology* 9, 509-530.
- Palumbi, S.R., 2003. Population genetics, demographic connectivity, and the design of marine reserves. *Ecol. Appl.* 13, 146-158.
- Pandolfi, C., Mugnai, S., Azzarello, E., Masi, E., Mancuso, S., 2006. Fractal geometry and neural networks for the identification and characterization of ornamental plants. In: Teixeira da Silva, J. (Ed.), Floriculture, ornamental and plant biotechnology: advances and topical issues. Global Science Books, Kyoto, pp. 213-225.
- Paulay, G., Meyer, C., 2002. Diversification in the tropical Pacific: comparisons between marine and terrestrial systems and the importance of founder speciation. *Integr. Comp. Biol.* 42, 922.
- Paulay, G., Meyer, C., 2006. Dispersal and divergence across the greatest ocean region: Do larvae matter? *Integr. Comp. Biol.* 46, 269-281.
- Pelletreau, K.N., Targett, N.M., 2008. New perspectives for addressing patterns of secondary metabolites in marine macroalgae. *Algal Chemical Ecology*, 121-146.
- Phillips, J.A., 2001. Marine macroalgal biodiversity hotspots: why is there high species richness and endemism in southern Australian marine benthic flora? *Biodivers. Conserv.* 10, 1555-1577.
- Pietra, F., 2002. Biodiversity and natural product diversity. Pergamon, Trento.

- Pons, J., Barraclough, T.G., Gomez-Zurita, J., Cardoso, A., Duran, D.P., Hazell, S., Kamoun, S., Sumlin, W.D., Vogler, A.P., 2006. Sequence-based species delimitation for the DNA taxonomy of undescribed insects. *Syst. Biol.* 55, 595-609.
- Provan, J., Murphy, S., Maggs, C.A., 2004. Universal plastid primers for Chlorophyta and Rhodophyta. *Eur. J. Phycol.* 39, 43-50.
- Prud'Homme Van Reine, W.F., Verheij, E., Coppejans, E., 1996. Species and ecads of *Caulerpa* (Ulvoephyceae, Chlorophyta) in Malesia (South-East Asia): taxonomy, biogeography and biodiversity. *Aquat. Ecol.* 30, 83-98.
- Puglisi, M.P., Paul, V.J., 1997. Intraspecific variation in the red alga *Portiera hornemannii*: Monoterpene concentrations are not influenced by nitrogen or phosphorus enrichment. *Mar. Biol.* 128, 161-170.
- Rannala, B., Yang, Z.H., 2003. Bayes estimation of species divergence times and ancestral population sizes using DNA sequences from multiple loci. *Genetics* 164, 1645-1656.
- Richards, R.A., 2010. The species problem: a philosophical analysis. Cambridge University Press, New York.
- Ryder, E., Nelson, S.G., McKeon, C., Glenn, E.P., Fitzsimmons, K., Napoleon, S., 2004. Effect of water motion on the cultivation of the economic seaweed *Gracilaria parvispora* (Rhodophyta) on Molokai, Hawaii. *Aquaculture* 238, 207-219.
- Santini, F., Winterbottom, R., 2002. Historical biogeography of Indo-western Pacific coral reef biota: is the Indonesian region a centre of origin? *J. Biogeogr.* 29, 189-205.
- Saunders, G.W., 2005. Applying DNA barcoding to red macroalgae: a preliminary appraisal holds promise for future applications. *Philos. T. Roy. Soc. B.* 360, 1879-1888.
- Saunders, G.W., 2008. A DNA barcode examination of the red algal family Dumontiaceae in Canadian waters reveals substantial cryptic species diversity. 1. The foliose *Dilsea-Neodilsea* complex and *Weeksia*. *Botany* 86, 773-789.
- Saunders, G.W., Lehmkuhl, K.V., 2005. Molecular divergence and morphological diversity among four cryptic species of *Plocamium* (Plocamiales, Florideophyceae) in northern Europe. *Eur. J. Phycol.* 40, 293-312.
- Shanks, A.L., Grantham, B.A., Carr, M.H., 2003. Propagule dispersal distance and the size and spacing of marine reserves. *Ecol. Appl.* 13, 159-169.
- Silva, P.C., 1992. Geographic patterns of diversity in benthic marine algae. *Pac. Sci.* 46, 429-437.
- Silva, P.C., Meñez, E.G., Moe, R.L., 1987. Catalog of the benthic marine algae of the Philippines. Smithsonian Institution Press, Washington, D.C.
- Sites, J.W., Marshall, J.C., 2003. Delimiting species: a Renaissance issue in systematic biology. *Trends Ecol. Evol.* 18, 462-470.
- Sites, J.W., Marshall, J.C., 2004. Operational criteria for delimiting species. *Annu Rev Ecol Evol Syst* 35, 199-227.
- Smit, A.J., 2004. Medicinal and pharmaceutical uses of seaweed natural products: a review. *J. Appl. Phycol.* 16, 245-262.
- Templeton, A.R., 2001. Using phylogeographic analyses of gene trees to test species status and processes. *Mol. Ecol.* 10, 779-791.
- Thomas, T.R.A., Kavlekar, D.P., LokaBharathi, P.A., 2010. Marine drugs from sponge-microbe association—a review. *Mar. Drugs* 8, 1417-1468.
- Tito, O., Sescon, C., Adalla, C., Asdani, J., Basilio, E.M., Climaco, A., Dagalea, A., Luna, M., Uddin, Y., Vega, R.A., 2007. An annotated checklist of macrobenthic algae of the western coast of Zamboanga City (Mindanao, Philippines). *Science Diliman* 21.
- Tronholm, A., Leliaert, F., Sansón, M., Afonso-Carrillo, J., Tyberghein, L., Verbruggen, H., De Clerck, O., 2010a. Biogeographical asymmetry as a result of thermal tolerance and long-distance dispersal in two allegedly widespread tropical brown algae. *J. Biogeogr.*
- Tronholm, A., Sansón, M., Afonso-Carrillo, J., Verbruggen, H., De Clerck, O., 2010b. Niche partitioning and the coexistence of two cryptic *Dictyota* (Dictyotales, Phaeophyceae) species from the Canary Islands. *J. Phycol.* 46, 1075-1087.

- Trono, G.C., 1997. Field guide and atlas of the seaweed resources of the Philippines. Bookmark. Inc., Makati.
- Trontelj, P., Fišer, C., 2009. Cryptic species diversity should not be trivialised. *Syst. Biodivers.* 7, 1-3.
- Verbruggen, H., De Clerck, O., Kooistra, W., Coppejans, E., 2005. Molecular and morphometric data pinpoint species boundaries in *Halimeda* section *Rhipsalis* (Bryopsidales, Chlorophyta). *J. Phycol.* 41, 606-621.
- Verbruggen, H., Leliaert, F., Maggs, C.A., Shimada, S., Schils, T., Provan, J., Booth, D., Murphy, S., De Clerck, O., Littler, D.S., Littler, M.M., Coppejans, E., 2007. Species boundaries and phylogenetic relationships within the green algal genus *Codium* (Bryopsidales) based on plastid DNA sequences. *Mol. Phylog. Evol.* 44, 240-254.
- Verges, A., Paul, N.A., Steinberg, P.D., 2008. Sex and life-history stage alter herbivore responses to a chemically defended red alga. *Ecology* 89, 1334-1343.
- Wiens, J.J., 2007. Species delimitation: new approaches for discovering diversity. *Syst. Biol.* 56, 875.
- Wiens, J.J., Kuczynski, C.A., Smith, S.A., Mulcahy, D.G., Sites, J.W., Townsend, T.M., Reeder, T.W., 2008. Branch lengths, support, and congruence: testing the phylogenomic approach with 20 nuclear loci in snakes. *Syst. Biol.* 57, 420.
- Wiens, J.J., Penkrot, T.A., 2002. Delimiting species using DNA and morphological variation and discordant species limits in spiny lizards (*Sceloporus*). *Syst. Biol.* 51, 69.
- Williams, S.T., Duda Jr, T.F., 2008. Did tectonic activity stimulate Oligo-Miocene speciation in the Indo-West Pacific? *Evolution* 62, 1618-1634.
- Wilson, M.E.J., Rosen, B.R., 1998. Implications of paucity of corals in the Paleogene of SE Asia: plate tectonics or centre of origin. *Biogeography and geological evolution of SE Asia*, 165-195.
- Wiseman, D.R., 1973. Morphological and taxonomic studies of the red algal genera *Ochtodes* and *Chondrococcus*. Department of Botany. Duke University, p. 234.
- Yang, Z., Rannala, B., 2010. Bayesian species delimitation using multilocus sequence data. *Proceedings of the National Academy of Sciences* 107, 9264.
- Yu, Y., Than, C., Degnan, J.H., Nakhleh, L., 2011. Coalescent histories on phylogenetic networks and detection of hybridization despite incomplete lineage sorting. *Syst. Biol.* 60, 138.
- Zuccarello, G.C., Sandercock, B., West, J.A., 2002. Diversity within red algal species: variation in world-wide samples of *Spyridia filamentosa* (Ceramiaceae) and *Murrayella pericladus* (Rhodomelaceae) using DNA markers and breeding studies. *Eur. J. Phycol.* 37, 403-417.
- Zuccarello, G.C., West, J.A., 2002. Phylogeography of the *Bostrychia calliptera*-*B. pinnata* complex (Rhodomelaceae, Rhodophyta) and divergence rates based on nuclear, mitochondrial and plastid DNA markers. *Phycologia* 41, 49-60.
- Zuccarello, G.C., West, J.A., 2003. Multiple cryptic species: molecular diversity and reproductive isolation in the *Bostrychia radicans*/*B. moritziana* complex (Rhodomelaceae, Rhodophyta) with focus on North American isolates. *J. Phycol.* 40, 226-226.

## SUMMARY

---

Marine macroalgae are a prolific source of pharmacologically important secondary metabolites. However, many species used in pharmacognosy and in biomedical experiments are severely understudied biologically. *Portieria*, an Indo-Pacific red seaweed, is one of those understudied species found to harbor an abundance of halogenated monoterpenes. **Halomon**, a halogenated monoterpene with anti-tumor properties has been isolated in a *Portieria* population in Batanes, Philippines. Unfortunately, the absence of sufficient biological knowledge about *Portieria* has placed halomon in a drug development bottleneck. The motivations for this thesis are to test the hypotheses that the variation in halomon content among *Portieria* populations could be due to cryptic diversity, seasonality or geographical variation on the secondary metabolite production. Given these three conditions: differential production of pharmacologically important monoterpenes, lack of biological knowledge on *Portieria*, and the possibility of the presence of cryptic species, this thesis specifically aimed to examine cryptic diversity in *Portieria*; determine how this genetic diversity is expressed on the phenotypic level (morphology and chemistry) and in doing so determine the role of cryptic diversity, life-history stages, seasonality and geographical location on the differential production of secondary metabolites. To achieve these goals, we conducted the following investigations and report the results on six research chapters:

In **Chapter 2**, an in-depth treatment is presented on the vegetative and reproductive development of the algae, which includes a study on the ontogeny of male, female and tetrasporangial nemathecia. Post fertilization events and carposporophyte development is described in detail for the first time. Phylogenetic analysis using chloroplast encoded *rbcL* and nuclear encoded ribosomal LSU gene sequences, including members of Rhizophyllidaceae and their close relatives suggest a monophyletic family.

In **Chapter 3**, a description of the pattern of the unprecedented cryptic species diversity in the *P. bornemannii* complex in the Philippines is provided. Cryptic species are delineated using the General Mixed-Yule Coalescent Model Approach and Bayesian species delimitation. Based on these approaches, we revealed the presence of at least 21 *Portieria* species in the Philippines.

In **Chapter 4**, we examined species diversity, distributions and phylogenetic relationships within the red alga *Portieria* to determine how historical processes have contributed to present-day biodiversity patterns across the marine

tropical Indo-Pacific. DNA-based species delimitation analysis revealed rampant cryptic diversity. Forty-nine *Portieria* species were delineated, which were all restricted to a single Ocean basin. Within the Philippines, several species display fine scale archipelagic and intra-archipelagic endemism, suggesting low dispersal capacity. The highest diversity was recovered in the Indo-Malay Archipelago (IMA), with declining species numbers moving away, both longitudinally and latitudinally, from the centre. A species phylogeny suggests a long term persistence of ancient lineages within confined regions of the Indo-Pacific, including the IMA. These results indicate that the long and complex geological history of the IMA played an important role in shaping the diversity of *Portieria* in the IMA. The taxonomic richness in the IMA may have resulted from a combination of species accumulation via island integration through tectonic movement, in combination with diversification at small spatial scales within the IMA as a result of increased geographical complexity of the region during the Oligo-Miocene and Pleistocene periods of glacially lowered sea level. This study thus supports both the centre of origin and centre of accumulation hypothesis, and highlights that there may be not one unifying model to explain the biological diversity within the IMA.

**In Chapter 5**, we applied different morphometric techniques, including discriminant function analyses of fractal parameters, and non-conventional and conventional measurements of branch apices, to detect patterns of morphological differentiation between *Portieria* species. Results show that conventional measurements outperform those of fractal and non-conventional variables in the discrimination of lineages. A combination of such characters resulted in the best discriminatory power. Fractal analyses resulted in low to moderate classification success (21-71%) of branch apices. Classification success was higher for conventional measurements (70-100%). When combined, fractal variables and conventional measurements resulted in high to very high classification success (83-100%). These results indicate that although it may not be possible to assign each individual specimen to the correct lineage, the different lineages are, at least to some degree, morphologically differentiated.

**In Chapter 6**, using non-polar extraction and metabolite fingerprinting of *P. bornemannii* sampled from two distinct regions in the Philippines (Batanes and Visayas), we determined if variation in secondary metabolites is due to the different life-history stages, presence of cryptic species, and/or spatiotemporal factors. A total of 302 compounds were detected. PCA analyses show intraspecific variation in secondary metabolites between life-history stages. Male gametophytes are strongly discriminated from the two other stages, and female gametophyte and



---

tetrasporophyte samples are partially discriminated. Female gametophyte extracts (202) are chemically richer compared to that of the male (102) and tetrasporophyte (106). In the Batanes region, DNA sequence data point towards the presence of 5 cryptic species. Variation in secondary metabolites was shown between as well as within these species. Intraspecific variation was even more pronounced in the Visayas dataset which included samples from 6 sites, belonging to 3 cryptic species. Neither species groupings nor spatial or temporal based patterns were observed in the PCA analysis. These results suggest that life-history driven variations and possibly other microscale factors may have more influence on the variation within *Portieria* species.

In **Chapter 7** we studied the seasonal dynamics of *Portieria* by looking at three parameters: density, percent cover and biomass in four sites located at Negros and Siquijor Islands, Philippines from Jan 2007 to Mar 2009. Sites are affected by strong waves during the southwest (June-Sept) and northeast (Nov -Feb) monsoon periods. Significant fluctuations in all three parameters were detected mainly in two sites affected either by the NE and SW monsoon waves. Results and field observations suggest that *Portieria* has a site-specific seasonality that is influenced by strong wave actions brought by the monsoonal winds. *Portieria* in Siaton, Negros, a site exposed to the SW monsoon waves, begins its growth closely before or during the SW monsoon season and disappears at the end of the NE monsoon. In Dapdap, Siquijor, a site exposed only to the NE monsoon waves, plants begin growing just before or during the NE monsoon, and decline towards the SW monsoon. Sawang and Pagubagubaaan in Siquijor are two sites exposed to waves of the NE and SE monsoon. Here, no significant fluctuations of the measured parameters were detected indicating a lack of marked seasonality. However, field observations of the presence of young and senescent individuals suggest two growth cycles in Sawang: one that appears during the SW monsoon and a new batch appearing during the NE monsoon. A generation of plants in Siaton and Dapdap is estimated to grow and live for a maximum of 9-10 months while those in Sawang and Pagubagubaaan live for about 5 months.



## SAMENVATTING

---

Mariene macroalgen vormen een rijke bron van secundaire metabolieten die potentieel belangrijk zijn voor farmacologisch onderzoek. Toch is de biologie van heel wat farmacologisch potentieel interessante zeewiersoorten slecht gekend. Eén van deze algen is *Portieria*, een algemeen tropisch roodwiergenus uit de Indische en Stille Oceaan dat een diversiteit aan gehalogeneerde monoterpenen (halogenated monoterpenes) bevat. Halomon, een gehalogeneerd monoterpeen met anti-tumoreigenschappen werd geïsoleerd uit een *Portieria* populatie van Batanes (Filippijnen). Een gebrek aan gedetailleerde kennis van de biologie van *Portieria* bemoeilijkt echter sterk het onderzoek naar halomon-gebaseerde geneesmiddelen. Een van de doelstellingen van dit proefschrift was om na te gaan of variatie in halomon en andere secundaire metabolieten mogelijk gekoppeld is aan cryptische diversiteit, seizoensaliteit of geografische verspreiding van *Portieria*. De specifieke doelstellingen van dit proefschrift waren: 1) soortsdiversiteit en evolutionaire patronen onderzoeken aan de hand van genetische variatie (DNA sequentiegegevens), 2) nagaan hoe deze genetische diversiteit zich fenotypisch vertaalt (morfologisch en chemisch), en 3) de invloed bepalen van cryptische diversiteit, levenscyclus, seizoensaliteit en geografische verspreiding op de differentiële productie van secundaire metabolieten. De resultaten worden uiteengezet in 6 hoofdstukken.

Hoofdstuk 2 omvat een studie van de vegetatieve en reproductieve kenmerken van *Portieria*. Hierin worden de ontwikkeling van mannelijke, vrouwelijke en tetrasporangiale voortplantingsstructuren beschreven. Post-fertilisatie ontwikkelingsstadia en carposporofyt-ontwikkeling worden voor het eerst in detail beschreven. Een fylogenetische analyse op basis van het chloroplast-geëncodeerde *rbcL* gen en het nucleair ribosomaal LSU gen tonen aan dat de familie Rhizophyllidaceae, waartoe *Portieria* behoort, monofyletisch is.

In Hoofdstuk 3 wordt de soortsdiversiteit binnen *Portieria* bestudeerd aan de hand van DNA sequenties. Een vijftal soorten werden traditioneel beschreven aan de hand van morfologische kenmerken, maar veelal wordt één enkele, morfologisch variabele en wijdverspreide soort erkend (*P. hornemannii*). Twee technieken werden toegepast om soorten af te bakenen op basis van DNA-sequenties: een “General Mixed-Yule Coalescent Model” techniek en multi-locus Bayesiaanse methode. Deze analyses tonen aan dat de Filippijnen ten minste 21

*Portieria* soorten herbergt. Deze soorten blijken morfologisch moeilijk te onderscheiden en kunnen beschouwd worden als cryptische of pseudocryptische soorten.

In hoofdstuk 4 wordt de geografische schaal uitgebreid tot het volledige verspreidingsgebied van *Portieria*: de Indische en Stille Oceaan. Soortdiversiteit, geografische distributie en fylogenetische verwantschappen werden onderzocht met als doel een beter inzicht te verwerven in de historische processen die geleid hebben tot de huidige diversiteitspatronen. DNA sequentie-analyse resulteerde in de afbakening van niet minder dan 49 *Portieria* soorten, met een beperkte geografische verspreiding. Binnen de Filippijnen vertonen enkele soorten fjnschalige distributiepatronen wat wijst op een lage dispersiecapaciteit. Deze beperkte dispersie vertaalt zich ook in de fylogenetische resultaten waar oude evolutielijnen beperkte geografische verspreidingen vertonen. De hoge waargenomen diversiteit in de Indo-Maleisische Archipel (IMA) is mogelijk een gevolg van een accumulatie van soorten door een complexe geologische geschiedenis van de IMA in het Oligo-Mioceen en meer recente speciatie binnen de regio tijdens het klimatologisch dynamische Pleistoceen.

In hoofdstuk 5 worden patronen van morfologische differentiatie onderzocht aan de hand van verschillende morfometrische technieken, waaronder discriminant functie analyse van fractaalparameters en metingen van vegetatieve morfologische kenmerken. Deze analyses tonen aan dat ondanks de schijnbaar morfologische homogeniteit binnen het genus, er wel degelijk morfologische differentiatie is opgetreden tussen de respectievelijke *Portieria*-soorten. Toch blijken deze morfologische kenmerken slechts beperkt bruikbaar om soorten correct te identificeren. Het opstellen van diagnoses voor alle soorten integraal gebaseerd op morfologische kenmerken lijkt dan ook bijzonder weinig haalbaar.

In hoofdstuk 6 wordt gebruik gemaakt van non-polaire extracten en metabolische fingerprinting om na te gaan of variatie in secundaire metabolieten mogelijk gekoppeld is aan verschillende levenscyclus-stadia, cryptische diversiteit en/of spatio-temporele factoren. In totaal werden 302 metabolieten gedetecteerd. PCA analyses tonen aan dat de variatie in secundaire metabolieten voor een grotendeels gekoppeld is aan verschillende levensstadia. Zo bevatten vrouwelijke gametofyten aanzienlijk meer metabolieten dan mannelijke gametofyten of tetrasporofyten. Variatie gekoppeld aan cryptische diversiteit, geografische distributie of seizoenaliteit was minder eenduidig.

Hoofdstuk 7 onderzoekt seizoenale patronen van *Portieria* in de Filippijnen. Densiteit en biomassa werden opgevolgd in vier locaties van Negros en Siquijor

---

tussen 2007 en 2009. Resultaten tonen aan dat de seizoenspatronen sterk locatiespecifiek zijn en dat groeicycli sterk afhankelijk zijn van brandingsterkte tijdens de Zuid-West (juni-september) en Noord-Oost moesson periodes.



## CURRICULUM VITAE

---

**Dioli Ann Payo** finished her bachelor's degree in Biology at the University of the Philippines in the Visayas Tacloban College in 1999. Her first job was as a research assistant for Project Seahorse in Bohol, Philippines. The thirst for adventure and research was fed with night dives, studying the movement of seahorses and living with a fishing community in a small island in Cataban, Bohol. Studying seahorse biology came with exposure to fishers' exclusive knowledge and at the same time to the perils of destructive fishing. Soon after, she received an opportunity to study for a master's degree in Ecological Marine Management at the Vrije Universiteit Brussel (VUB), Belgium, which she completed in 2004 with distinction. She worked on the molecular systematics of the brown macroalga *Dictyota* from the Philippines under Dr. O. De Clerck. This thesis had been granted the VLIZ Best Thesis prize in 2005. In 2004, she returned to the Philippines. There she worked as a team leader of the MPA research and monitoring team of the Coastal Conservation and Education Foundation (CCEF) in Cebu, Philippines. Her research at CCEF exposed her even more to the beauty of coral reef diversity and marine protected areas in the Central Visayas. In 2006, she received a grant from the Flemish Interuniversity Council (VLIR) for a PhD project on the marine macroalga *Portieria* at Ghent University with Prof. O. De Clerck. This thesis is the culmination of this research endeavor which lasted for 5 years.