

ALTERNATIVE LINE DELIVERY STRATEGIES SUPPORT A FORKLIFT FREE TRANSITION IN A HIGH PRODUCT VARIETY ENVIRONMENT

Cottyn Johannes^(a), Govaert Tim^(b), Van Landeghem Hendrik^(c)

^(a)Department PIH, University College of West-Flanders, Graaf Karel de Goedelaan 5, Kortrijk B-8500, Belgium

^(b)Department of Industrial Management, Ghent University, Technologiepark 903, Zwijnaarde B-9052, Belgium

^(c)Department of Industrial Management, Ghent University, Technologiepark 903, Zwijnaarde B-9052, Belgium

^(a)johannes.cottyn@howest.be, ^(b)tim.govaert@ugent.be, ^(c)hendrik.vanlandeghem@ugent.be

ABSTRACT

Forklift transport fails when it comes to efficiency. As a result, more and more attention is going to alternative transport systems that automate or further structure the material flow; such as line deliveries by train and conveyor technology. Only substituting the transport system itself is not cost-effective. The resulting improvements are rather low compared to the high investment cost. Therefore, in this paper alternative material flow and line delivery strategies are taken into consideration. Within a high product variety environment a combination of materials kitting and line stocking is proposed. This approach has some important benefits on top of the pure forklift free transition. A basic model is constructed to calculate the kitting area and transport system requirements. A truck assembly company is used as case study. A feasibility study is carried out, to give a rough indication of the cost-effectiveness of the model.

Keywords: Materials kitting, line assembly, forklift free

1. INTRODUCTION

What drives the research on and implementation of forklift free (also referred to as 'fork-free') factories? Forklifts have long been the undisputed standard for material handling within the factory walls. The main reason is undoubtedly their enormous flexibility. Forklifts can perform the complete internal logistic flow as long as two important conditions are satisfied: Appropriate forklift construction and sufficient transport and handling space. Mostly the number of forklifts is overdimensioned in order to cope with fluctuations of the material flow. That - in combination with the human factor - makes the internal transport system flexible because the transport duties can easily be adapted to a changing material flow or factory layout.

Nowadays, flexibility remains an important issue but with the emergence of lean concepts it can not longer be at the cost of the efficiency of the transport system. Considering the different forms of waste stated below, it is obvious that forklifts fail when it comes to efficiency.

1. **Overdimensioning:** From own experience we noted that the uncertainty about the cycle time for transport tasks is certainly an important factor that contributes to an excessive number of forklifts. Since roaming vehicles are difficult to monitor visually, idle time remains easily hidden. The flexibility of the forklift transport is exactly the result of an over dimensioned transport system.
2. **Waiting:** Another aspect is the manual character of the forklift. The human factor makes the transport system vulnerable to social disruptions.
3. **Defects:** Finally, there's also the safety issue. Forklifts are a constant threat to personnel and can cause serious material and infrastructure damage. Neumann et al. (2007) and Gecker (2004) even state the human loss and liability cost relative to forklift injuries as the number one driver for forklift free plant floors.

As a result, more and more attention is going to alternative transport systems that automate or further structure the material flow. That explains the growing research on and implementation of line deliveries by train (Manual and automatic) and conveyor technology (Electrified Monorail System, Chain conveyor, Power&Free). The design of a material handling system is commonly subdivided in two highly interrelated sub-problems: design of the material flow network that provides the resource inter-connections; and sizing of the transporters fleet and allocation of the intergroup moves to these transporters (Montoya-Torres (2006); Sly (2006)). Both topics are well documented in literature. Forklift transport is typically a one on one delivery of pallets of parts (BULK) between origin and destination points. Alternative transport systems benefit from modified delivery approaches. It is obvious that trains must deviate from the one on one transport to for example a milkrun system to be effective. Automated transport systems - such as Automated Guided Vehicles (AGV) and Electrified Monorail Systems (EMS) - require special pickup and dropoff stations.

Only substituting the transport system itself is not cost effective. The resulting improvements are rather low compared to the high investment cost. In addition, safety issues - such as forklift injuries - are difficult to quantify and therefore far from trivial to incorporate in an investment analysis. Therefore, in this paper alternative material flow and line delivery strategies are taken into consideration on top of the forklift free transition. Bozer and McGinnis (1992) compared the use of materials kitting for a Just In Time (JIT) delivery of parts for assembly to the line stocking approach of the bulk delivery. It is important to determine the contents of each kit. This assembly line feeding problem is discussed by De Souza et al. (2008). In addition, the use of the kits at the line can reduce the walking distance of the line operator. Within a high product variety environment a combination of both approaches is proposed: line stocking for common and materials kitting for variant parts. This approach has some important benefits on top of the pure forklift free transition: (1) reduction of the transport system requirements by restricting necessary dropoff stations; (2) reduction of walking distances for the line operator by presenting kits; (3) reduction of line stock by JIT delivery of parts; (4) centralizing the parts handling at the kitting area.

Section 2 presents a basic flow model to calculate the kitting area and transport system requirements. Different model configurations/strategies are made possible by a set of parameters. In Section 3 a truck assembly company is presented as case study. The feasibility study gives a rough indication of the cost-effectiveness of the extended forklift free transition. A Dupont model is constructed that uses the flow model output to obtain a first impression of the financial potential of this endeavour. Section 4 concludes and states further research possibilities.

2. FLOW MODEL

In order to make accurate model calculations regarding the different internal logistic flows, it is necessary to build a database based on the current situation ('AS IS'). The constantly changing layout and material flow of a real factory is too complex for the feasibility study. Therefore the current situation is frozen and a snapshot of the factory layout and material flow will be used. The feasibility at that specific time will then be determined. The following sections highlight the three important aspects in the model: (1) material flow; (2) transport system and (3) line delivery strategy.

There is no optimization integrated in the presented model. The transport system network, vehicle routing, kit composition, etc. are all based on average values of a small production period. The proposed logic should be sufficient however to determine the feasibility by roughly estimating the required investments and featured improvements.

2.1. Material flow

The current material flow is assumed to be in bulk. A

container (pallet, rack, box, ...) containing a certain number of the same parts is transported to the line and placed as stock. The line operator empties the batch and orders a new one timely. This method is called line stocking. Each combination (Part, Origin Point, Destination Point) is identified by a specific transport frequency N and an amount A . This means that N times per shift, a package of average A parts is transported. In addition the use frequency f of a part at the use point is calculated by (1) with $Nb_{assembly}$ the number of products that are assembled during one shift on that use point.

$$f = \frac{N \cdot A}{Nb_{assembly}} \quad (1)$$

This value tells in how many final products the part is used. A value of 0.2 means that the part is used in 2 out of 10 products. The latter parameter is a significant one: it can fluctuate widely from $f \geq 1$ (common part) to $f \leq 0.001$ (an exotic option part) and it differentiates industries: the frequency range in automotive is less than in truck assembly, while the latter is smaller than in harvester equipment assembly. Within a high product variety environment line stocking results in an excessive inventory at the line (Fisher and Ittner 1999). Parts that are assembled in almost any product, are referred to as common parts. Variant parts reflect the various options that can be installed on a product at the same workstation. Materials kitting is the practice of putting together a kit of parts and/or subassemblies before delivery to the assembly line (Bozer and McGinnis 1992). A kit can combine materials for one final product at different use points (travelling kit) or materials for different final products at the same use point (stationary kit). Within the proposed model a mixture of line stocking and (travelling) materials kitting is integrated. The model parameter **Frequency Boundary** f_b makes the divide between both groups of parts. Parts with a higher (or equal) use frequency than f_b are brought in bulk. Parts with a use frequency less than f_b are collected in kits. For example, when f_b is 0.5 then all parts that are assembled in half or more final products are kept as inventory at the assembly line. The other parts are seen as variant parts and will be brought JIT in kits.

The flowchart in Figure 1 describes the composition strategy of the kits based on the average use frequency f of each part at each line station. The first step is filtering the parts list based on their use frequency. Those with $f \geq f_b$ are left out. The remaining parts are grouped in kits considering the line direction and some restriction parameters:

$$(p_{kit} + p_{PN}) < p_{max} \quad (2)$$

$$(w_{kit} + w_{PN}) < \frac{w_{max}}{\delta_w} \quad (3)$$

$$(p_{kit} + p_{PN}) < \delta_p \cdot p_{max} \quad (4)$$

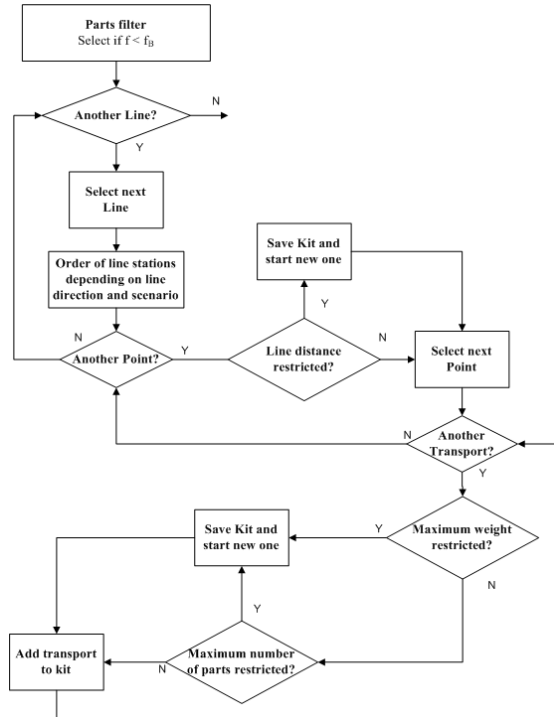

Figure 1: Flowchart of the Kit Composition Strategy in the Model

- **Maximum line distance Δ_l** (line stations): The maximum line distance the kit can travel. This value is expressed in the number of line stations the kit passes through. This parameter is introduced to restrict the walking distances of the line operator emptying the kit. A value of $\Delta_l = 3$ means that each kit can contain parts for one product assembly at no more than three different line stations.
- **Maximum weight w_{max}** (kg/kit): The carriers of each transport system have a maximum weight limit that can be transported. This parameter makes sure that this limit is not exceeded.
- **Maximum number of parts p_{max}** (parts/kit): This is a restriction on the number of parts that are put into the same kit. Restricting this amount, should ease the handling of the kit by the line operator. This restriction however is not binding, because otherwise the result would have kits that contain a large number of small parts. Therefore this restriction is coupled to a certain percentage of w_{max} . So, considering the parts restriction, part number PN can be added to the kit when (2) OR ((3) AND (4)) is satisfied. Expression (2) is the normal parts restriction. Expression ((3) AND (4)) eliminates kits with many small parts by making sure that the total weight is minimum the weight restriction divided by δ_w . A value $\delta_w = 5$ means that the kits must weigh at least 20% of w_{max} . Additionally there is an extra expression that restricts the number of parts again to maximum δ_p times the normal parts

maximum. So, when all parts are small (low weight) than the used parts restriction can be $\delta_p \times p_{max}$. When $\delta_p = 3$ then kits can contain three times more small parts.

The composition of the kits requires extra handling. Therefore a kitting area is introduced where all necessary kits are composed. Within the proposed model two extra parameters concerning the kitting process are introduced: **Overall Picking Productivity PP** and **Batch Size BS**. In order to calculate the amount of pickers required, a productivity has to be assigned, ex. 175 line picks per picker per hour. If the use frequency of a part is larger than 1, only 1 pick is counted to pick all the pieces. In real-life picking situations, often batch picking is used. This means that several kits are picked at the same time. BS = 4 means four kits will be picked at the same time. If a part is picked that occurs in 2 of the 4 kits, only 1 pick is counted because the picker can take the 2 pieces and drop them in the 2 different kits. He only has to walk once. In addition to the picking workforce a sufficient infrastructure is needed to support the kitting processes. If current warehouses don't satisfy the needs, new infrastructure or different methods must be introduced.

Optimal values should be obtained for the different model parameters. For example, an increasing value for the frequency boundary parameter f_b results in more kitting and more transport efforts. But more travelling kits at the line, decreases the handling efforts of the line operator. However, before this exercise can be made, the benefits of materials kitting at the production line must be quantified more precisely.

2.2. Transport System

Based on the selected alternative for the forklifts, the transport system requirements are calculated within the proposed model. Each transport technology has specific characteristics for the (1) **transport network** and (2) **carrier**. In current literature much research can be found on optimal solutions for network design (Wan (2006); Montoya-Torres (2006)) and vehicle routing (Le-Anh and Koster (2006); Chuah and Yingling (2005)). However, in this paper there is no need for an optimal solution. A simple calculation will do for the feasibility study of the complex material flow. Based on the total list of bulk and kit transports (see 2.1 *Material Flow*) a static simulation is performed. To reduce the complexity of the problem, the model doesn't incorporate the dynamic behaviour of the transport system. The possible transport systems are: (a) **Manual train** (Forklift-like pulling unit), (b) **Automatic train** (Automated Guided Vehicle) and (c) **Electrified Monorail System**. As an example the working method is illustrated for the EMS.

(c1) *EMS transport network* - At each use point (for bulk and kits) on the factory floor a dropoff point is drawn. An unidirectional network of tracks is constructed to interconnect all points. Everything is

done manually, so an optimal network is not the aim. The purpose is - based on an CAD drawing of the factory floor - to determine the distance between each two points in the network. The output is a number of dropoff stations, an amount of track in meters and some shifting tracks.

(c2) *EMS carrier* - Each carrier is independently driven and can transport a certain maximum volume V_{cmax} (m^3) and maximum weight w_{cmax} (kg) over the transport network at an average speed of v_{cavg} (ms). Equation (5) summons all required carrier time (seconds) to route the material flow through the transport network. There are n transport combinations (part, origin, destination). d_i is the shortest path distance of transport i (meter) to go from origin to destination and complete the loop back to the origin in the EMS transport network. Based on the number of work hours during one shift t_{shift} the number of carriers can be calculated (6).

$$T_c = \sum_{i=1}^n \frac{d_i}{v_{cavg}} \quad (5)$$

$$n_c = \frac{T_c}{60.60.t_{shift}} \quad (6)$$

2.3. Line Delivery Strategy

The line delivery strategy determines what happens with the travelling kits when they are dropped off at the assembly line. Four different approaches are proposed:

1. **Further handling at the line** - The kit is simply placed at the dropoff point by the transport system. Further handling has to be done by the line operators. When the kit stays at a fixed position, it results in larger walking distances to fetch the parts. When the travelling kit is collected in some sort of cart, then the line operator has to take it with him during assembly causing him to do extra handling.
2. **Couple cart to the line** - The part numbers for both sides of the assembly line are combined in kits and placed on carts. When dropped off, the carts are coupled to the driving mechanism of the line. They run along with the product at line speed, resulting in smaller walking distances.
3. **Conveyor at both sides of the line** - Each side of the line has its track and dropoff stations. When dropped off, the kits are placed on (or coupled to) the (chain) conveyor. They run along with the product (at both sides) at line speed, resulting in smaller walking distances.
4. **Carrier runs along with the line** - This option is the most advanced one. Each side of the line has its track and dropoff stations. Here the kits are not really dropped off. The carrier leaves the main track and runs along the line

on a secondary track at line speed presenting the parts to the line operator, resulting in smaller walking distances. Figure 2 illustrates strategy (4) in the case of a truck assembly company.

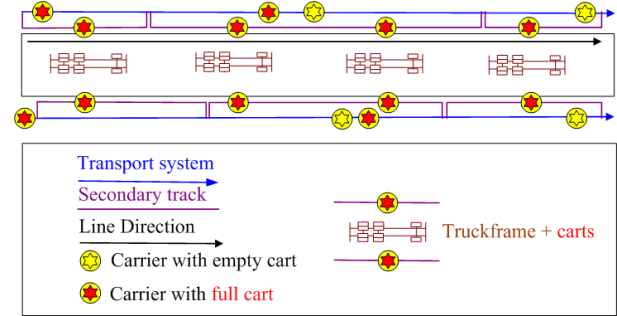

Figure 2: Dropoff Strategy 'Carrier Runs Along with the Line'

3. CASE STUDY – A TRUCK ASSEMBLY COMPANY

3.1. High Product Variety

The database contains the internal logistic flow from 33 days during the months April and May of the reference year. There are two main lines: one produces 72 trucks per shift in a two shift operation, the other produces 36 trucks in one shift. The average number of transports and the average transport amount of the parts from warehouses to lines and pre-assembly are calculated over 33 days. The origins of the material flow are a High Bay Automatic Warehouse, Small Box Warehouse, some conventional stores and 40 pre-assembly stations. The destination points are 149 line stations and 137 pre-assembly stations. The logistic points are drawn on top of an AutoCad file of the factory layout. The possible routings are added by connecting the logistic points through lines and network points (numbered points) to a complete logistic network. Figure 3 gives an excerpt of the current situation. There is a total of 4320 transport combinations (part, origin, destination). There are more different part numbers than there are packages transported during one shift (3317 against 2215). This reveals the complexity of this material flow. There are many parts that are only used in few trucks, referred to as variant parts. The use frequency of a part number at a specific line station gives an idea of the percentage of trucks the part is assembled into. A frequency of 0.2 means that the part is used in 2 out of 10 truck assemblies at that line station. Table 1 lists a few examples.

Table 1: A Delivery Overview of Some <Part Number, Line Station> Combinations

Part Number	Line Station	Weight (kg/part)	Frequency (parts/truck)
03176675	EL09	0,169	0,133
20478323	ER06	0,25	0,933
980464	CL10	0,006	9,073
208911	CR06	0,24	0,075
955399	AR03	0,41	3,779

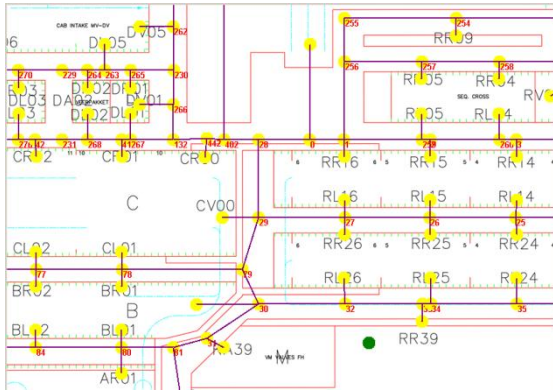

Figure 3: A Part of the Factory Layout of the Current Situation

Figure 4 gives a histogram of the frequencies of all the possible <part number, line station> combinations. There are 31 use frequencies smaller than 0.001 and 1729 use frequencies between 0.001 and 0.1 . The cumulative line in Figure 4 gives a clear view of the large number of variant parts. Somewhat 70% of the use frequencies are less than 0.5. This means that 70% of all combinations are only used in 50% or less of the truck assemblies. Half of the combinations have a frequency less than 0.2.

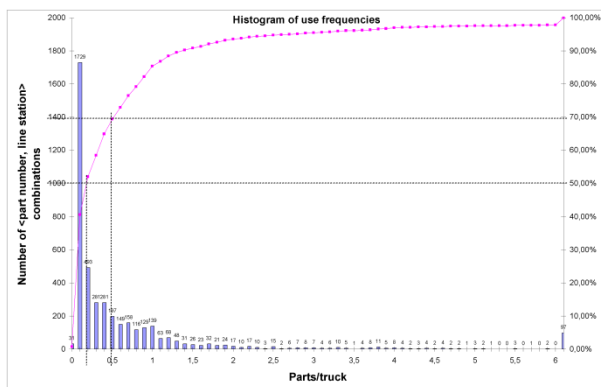

Figure 4: A Histogram of the Use Frequencies of All Possible <Part Number, Line Station> Combinations

3.2. Model Output

The model can be used to calculate some basic scenario's. Within the figures the names below will be mentioned:

- **Sc1611a&b:** (a) Manual or (b) automatic train, kits are coupled to the truck frame.
- **Sc1612a&b:** (a) Manual or (b) automatic train, kits are put on conveyors at both sides of the line.
- **Sc1311:** EMS, kits are coupled to the truck frame.
- **Sc1312:** EMS, kits are put on conveyors at both sides of the line.
- **Sc1313:** EMS, carriers run along with the line.

Extracted transport system requirements from the flow model like carriers, train carts, bulk and kit dropoff points, kit carts, conveyor length and overhead track length are forwarded to the financial calculations. Figure 5 gives an overview of the needed EMS carriers. The influence of the frequency boundary parameter f_B is illustrated: 1000 (=complete kitting), 0.9 and 0.7. The lower f_B gets, the more the transport shifts to bulk instead of kits. The composition of the kits is restricted and consequently is more carrier consuming. So the shift to more bulk transports results in lower overall carrier requirements. Figure 6 shows the number of kits that have to be composed per shift.

Figure 7 gives a summary of the picker results. The number of pickers in the figure have to be cumulated. As an example, for the left graph in figure 7, 19 pickers are needed in case of kits only and batch size 8. If one considers batch size 4, 13 more pickers are needed and thus 32 pickers are needed in total for kits only and batch size 4.

3.3. Financial Model

In order to obtain a first impression of the financial potential of this endeavour, a Dupont model was constructed, that calculates ROI and ROA based on the expected cash flows of the different scenarios. From the preliminary results, which cannot be reported due to confidentiality reasons, we found that the financial viability of the project was mainly determined by the waste reduction at the assembly line (less handling, less walking). As soon as 5% of the waste is reduced, most of the scenarios become viable.

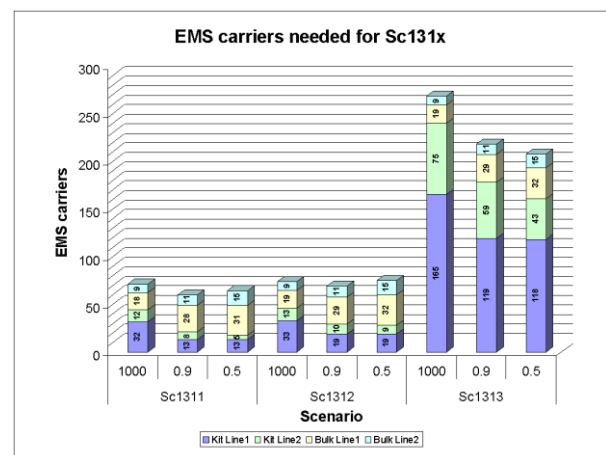

Figure 5: The Needed EMS Carriers for Scenarios Sc131x.

4. CONCLUSION AND FURTHER RESEARCH

This preliminary research has pointed out that alternative line delivery strategies can support the forklift free transition in a high product variety environment to make the project viable. Crucial is the reduction of direct time at the assembly line for the line operator. As soon as 5% of the waste was reduced, the financial model showed decent results. Further research should be done in quantifying the exact benefits of the

materials kitting and the presentation of kits to the line operator. By using JIT supply, space utilization at the line is reduced. This also has a unquantified positive impact on production.

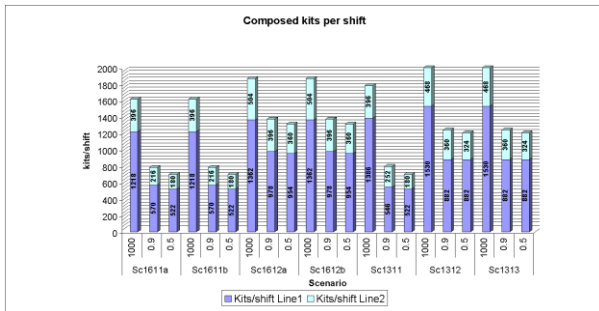

Figure 6: The Number of Kits Composed per Shift.

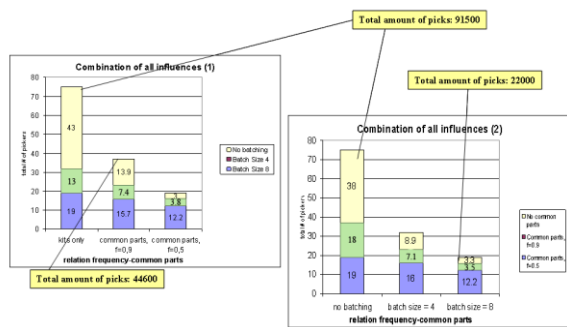

Figure 7: General Overview of the Number of Picking Operators Needed

This feasibility study is only a rough indication. The output is an early impression of featured challenges and expected costs and improvements. It points out which scenarios are open for further research. Based on detailed simulation and practical studies a more founded decision is possible. The detailed simulation will have to determine the number of carriers that will have to be added due to variability and failures, as well as indicate how big and where buffers are to be included in the transportation system. The technical issues regarding delivery to the hands of the operator by an automatic handling system will have to be studied by experimental setups.

ACKNOWLEDGMENTS

The study was supported in part by the Institute for the Advancement of Science and Technology (IWT) of the Flemish Government.

REFERENCES

Bozer, Y. A., and L. F. McGinnis. 1992. Kitting versus line stocking: A conceptual framework and a descriptive model. *International Journal of Production Economics* 28 (1). P.1-19.

Chuah, K. H., and J. C. Yingling. 2005. Routing for a just-in-time supply pickup and delivery system. *Transportation Science* 39 (3): 328–339.

De Souza, M. C., C. R. V. de Carvalho, and W. B. Brizon. 2008. Packing items to feed assembly

lines. *European Journal of Operational Research* 184. P.480-489.

Fisher, M. L., and C. D. Ittner. 1999, June. The impact of product variety on automobile assembly operations: Empirical evidence and simulation analysis. *Management Science* 45 (6). P.771-786.

Gecker, R. 2004, December. Materials handling strategies: A fork-free future. *Inbound Logistics* 24 (12). P.52-56.

Le-Anh, T., and M. D. Koster. 2006. A review of design and control of automated guided vehicle systems. *European Journal of Operational Research* 171:1–23.

Montoya-Torres, J. 2006, October. A literature survey on the design approaches and operational issues of automated wafer-transport systems for wafer fabs. *Production Planning & Control - The Management of Operations* 17 (7): 648–663.

Neumann, J., L. Tyler, and M. Urban. 2007, May. *Forklift free plants...considerations for success*. White paper, Kinetic Technologies inc. Available online (7 pages).

Sly, D. 2006, April. *Techniques for the evaluation, reduction and elimination of excess material flow within industrial facilities*. White paper, Proplanner. Available online (22 pages).

Wan, Y.-T. 2006, May. *Material transport system design in manufacturing*. Ph.D. dissertation, Industrial and Systems Engineering, Georgia Institute of Technology.

AUTHORS BIOGRAPHY

JOHANNES COTTYN is academic assistant at the University College of West-Flanders, PIH. He is currently working on his PhD in Industrial Management at Ghent University. His research interests lie in material handling, production automation, lean manufacturing and management software. He is a member of the Instrumentation, Systems and Automation (ISA) Society.

TIM GOVAERT is PhD student in Industrial Management at Ghent University.

HENDRIK VAN LANDEGHEM is full professor in Industrial Management at Ghent University. He is an expert in the area of logistics and their application in business processes. He advises companies in their choice and implementation of their logistic organisation and production control systems. He is fellow of the European Academy of Industrial Management (AIM) and senior member of the Institute of Industrial Engineering (IIE). He is since 2007 Fellow of the World Confederation of Productivity Science.