



UvA-DARE (Digital Academic Repository)

Questions in context

van Gessel, T.

Publication date

2020

Document Version

Final published version

License

Other

[Link to publication](#)

Citation for published version (APA):

van Gessel, T. (2020). *Questions in context*. [Thesis, fully internal, Universiteit van Amsterdam]. Institute for Logic, Language and Computation.

General rights

It is not permitted to download or to forward/distribute the text or part of it without the consent of the author(s) and/or copyright holder(s), other than for strictly personal, individual use, unless the work is under an open content license (like Creative Commons).

Disclaimer/Complaints regulations

If you believe that digital publication of certain material infringes any of your rights or (privacy) interests, please let the Library know, stating your reasons. In case of a legitimate complaint, the Library will make the material inaccessible and/or remove it from the website. Please Ask the Library: <https://uba.uva.nl/en/contact>, or a letter to: Library of the University of Amsterdam, Secretariat, Singel 425, 1012 WP Amsterdam, The Netherlands. You will be contacted as soon as possible.



Questions in Context

Thom van Gessel

Questions in Context

Thom van Gessel

Questions in Context

ILLC Dissertation Series DS-2020-13



INSTITUTE FOR LOGIC, LANGUAGE AND COMPUTATION

For further information about ILLC-publications, please contact

Institute for Logic, Language and Computation
Universiteit van Amsterdam
Science Park 107
1098 XG Amsterdam
phone: +31-20-525 6051
e-mail: illc@uva.nl
homepage: <http://www.illc.uva.nl/>

Copyright © 2020 by Thom van Gessel

Cover design and layout by Jeanne Bataille.

Printed and bound by Ipskamp Printing.

ISBN: 978-94-6421-086-6

Questions in Context

ACADEMISCH PROEFSCHRIFT

ter verkrijging van de graad van doctor
aan de Universiteit van Amsterdam
op gezag van de Rector Magnificus
prof. dr. ir. K.I.J. Maex
ten overstaan van een door het College voor Promoties ingestelde
commissie, in het openbaar te verdedigen in de Agnietenkapel
op woensdag 25 november 2020, te 10.00 uur

door

Thom van Gessel

geboren te Apeldoorn

Promotiecommissie

Promotor:	Dr. F. Roelofsen	Universiteit van Amsterdam
Copromotor:	Dr. M.D. Aloni	Universiteit van Amsterdam
Overige leden:	Prof. dr. J.F.A.K. van Benthem	Universiteit van Amsterdam
	Prof. dr. A. Betti	Universiteit van Amsterdam
	Dr. P.J.E. Dekker	Universiteit van Amsterdam
	Dr. P.A. Fritz	Australian Catholic University
	Dr. W.H. Holliday	University of California, Berkeley
	Prof. dr. ing. R.A.M. van Rooij	Universiteit van Amsterdam
	Dr. I. Stojanovic	Institut Jean Nicod

Faculteit der Natuurwetenschappen, Wiskunde en Informatica

This project has received funding from the European Research Council (ERC) under the European Union's Horizon 2020 research and innovation programme (grant agreement number 680220).



Voor opa

Contents

Acknowledgments	xi
Introduction	1
1 Two-dimensional semantics for declarative sentences	7
1.1 Motivation	8
1.1.1 Indexicals	9
1.1.2 Actuality	9
1.1.3 A priori and necessary truths	10
1.2 Two-dimensional semantics	11
1.2.1 Context and index	12
1.2.2 Content and character	13
1.2.3 Language and semantics	13
1.3 Identity and proper names	15
1.3.1 Necessity of identity and rigidity of names	15
1.3.2 Absolute or indexical names	16
1.4 Applications	17
2 Semantics of questions and indexical expressions	21
2.1 Motivation	22
2.1.1 Questions	22
2.1.2 Indexicals in questions	23
2.1.3 Apriority and necessity	24
2.1.4 Actuality	25
2.2 Reductive analysis of apriority	25
2.3 Questions as sets of propositions	28
2.3.1 Inquisitive semantics	28
2.3.2 Level of support conditions	31
2.3.3 Information states	33
2.3.4 Semantics	34
2.3.5 Character, content and context-sensitivity	36
2.3.6 Consequence and equivalence	38

2.3.7	Statements	40
2.3.8	Indexical-free sentences	40
2.3.9	Apriority and necessity of questions	40
2.3.10	Applications	41
2.4	Questions as relations over worlds	44
2.4.1	Question operator in two-dimensional semantics	44
2.4.2	Three-dimensional semantics	45
2.4.3	Layered two-dimensional semantics	46
2.4.4	Comparison with two-dimensional inquisitive semantics	47
2.5	Actuality in questions	48
2.6	Conclusion	51
3	Questions with indexical resolution conditions	53
3.1	Motivation	54
3.1.1	Example 1: exchanging cards	54
3.1.2	Example 2: the lost guide	55
3.1.3	Example 3: time to leave	55
3.1.4	Indexical resolutions and essential indexicality	56
3.2	Integrating conceptual covers	57
3.2.1	Level of perspective and context	59
3.2.2	First proposal	61
3.2.3	Applications	62
3.3	Refinement: indexical conceptual covers	64
3.3.1	Example 1: exchanging cards	64
3.3.2	Example 2: the lost guide	66
3.3.3	Other applications	67
3.4	Conclusion	68
4	Question-directed attitudes, indexicality and <i>de se</i>	71
4.1	Motivation	72
4.2	Question-directed attitudes	73
4.2.1	Traditional treatment of propositional attitudes	73
4.2.2	Analyses of question-directed attitudes	74
4.2.3	Treatment in inquisitive semantics	75
4.3	Two-dimensional analyses of attitude predicates	77
4.3.1	Propositions	78
4.3.2	Characters	79
4.3.3	Properties	80
4.4	Embedding properties	81
4.4.1	Inquisitive properties	82
4.4.2	Sets of properties	83
4.4.3	Other shortcomings	85
4.5	Embedding propositions or characters	86

4.5.1	Partial diagonalization	86
4.5.2	Enriched indices	87
4.6	Bicontextual approach	88
4.6.1	Inquisitive version	90
4.6.2	Applications	92
4.6.3	Dynamic extension: multiple contexts	95
4.7	Conclusion	98
5	Two-dimensional logic of questions	99
5.1	Two-dimensional inquisitive logic	100
5.1.1	Language	101
5.1.2	Semantics	101
5.1.3	State-based actuality	104
5.1.4	Consequence relations	105
5.1.5	Questions and apriority	106
5.2	Completeness proof for the classical fragment	107
5.2.1	Proof system	108
5.2.2	Sliced matrix model	108
5.2.3	Canonical model	111
5.2.4	Completeness	113
5.2.5	Logic of diagonal consequence	115
5.3	Extending completeness to the full language	116
5.3.1	Proof system	116
5.3.2	Resolutions	116
5.3.3	Regular matrix frames	118
5.3.4	Logic of diagonal consequence	120
5.4	Conclusion	120
	Bibliography	123
	Samenvatting	131
	Summary	133

Acknowledgments

I would like to thank my supervisors Floris Roelofsen and Maria Aloni for their indispensable advice, encouragement and critical comments. I am deeply indebted to Floris for the trust he placed in me, in particular at two key moments: at the start of the project and halfway through, when I decided to change the topic of my thesis. I want to thank Maria for her great enthusiasm for the project – our meetings always made me feel optimistic and energized. Thanks also to Ivano Ciardelli, who acted as a supervisor during my first year and commented on parts of this thesis at an early stage.

I am grateful to Johan van Benthem, Arianna Betti, Paul Dekker, Peter Fritz, Wesley Holliday, Robert van Rooij and Isidora Stojanovic for agreeing to be on my doctorate committee and for taking the time to read this thesis.

Over the past four years it has been inspiring to work within the inquisitive semantics research group. I want to thank its former members Alexandre Cremers, Jakub Dotlačil and Nadine Theiler for the many interactions and collaborations. I also want to thank Lucas Champollion and the NYU Linguistics Department for hosting me for a visit in the spring of 2018. Thanks in particular to office mates Yining Nie and Hagen Blix for making me feel at home in New York.

Some parts of this thesis have been presented at workshops and conferences: I thank the audiences at *InqBnB3*, *OZSW 2019* and *Semantics and Philosophy in Europe 11* for their helpful questions and comments. Thanks to Peter Fritz for our discussions during my visit in Oslo, which sparked many new ideas.

Working at the ILLC was enjoyable mainly because of the company of my (former) office mates. Thanks to all of them for the time we spent both in and outside of the office, especially to Ilaria Canavotto, Aybüke Özgün and Anthi Solaki. A special thanks to Gianluca Grilletti, who became a friend at first sight, and whose comments and suggestions on parts of this thesis were extremely helpful.

I owe a special word of thanks to Tom Schoonen, not just for proofreading this thesis and providing lots of feedback, but also for facing the challenge of getting a PhD together. I cannot imagine a better colleague or friend.

Finally and most importantly, I could not have written this thesis without the love and support of Maaike.

Introduction

According to the traditional picture in semantics, the meaning of a sentence is given by its truth conditions (Frege, 1879; Wittgenstein, 1922; Davidson, 1967). Formally, a sentence expresses a proposition – the set of possible worlds in which that sentence is true. In turn, the meaning of subsentential expressions is understood in terms of their contribution to the truth conditions of the sentences they appear in.

This picture has been very influential in both linguistics and logic. For instance, it can explain how an utterance of a sentence conveys information, by restricting which worlds are possible candidates for the actual one. It also offers a characterization of entailment: one sentence entails another if the latter is true in all the worlds in which the former is.

However, there are several phenomena that require us to refine this picture. This thesis is about two of these phenomena: indexicality and questions. What indexical expressions like ‘I’, ‘you’, ‘here’ or ‘now’ refer to depends on the context in which they are used (who the speaker and addressee are, and where and when the utterance takes place). As a consequence, the truth conditions of sentences in which indexical expressions appear may vary between contexts of use. The other phenomenon poses a different challenge: questions cannot be true or false. Therefore, their meaning cannot be given in terms of truth conditions.

The observation that these phenomena cannot be captured by the traditional picture is far from new – in fact, much has already been written about both.¹ But so far, indexicality and questions have only been studied in isolation.

Aims and scope of the thesis

The purpose of this thesis is threefold. The first goal is to show that there are interesting interactions between indexicality and questions. I will briefly highlight these below. The second goal is to provide a semantic framework that can account for these observations. Third and finally, this thesis studies the logical properties of this framework.

¹For recent overviews, see Schlenker (2018) on indexicality and Roelofsen (2019) on questions.

Questions and context-sensitivity

Of course, indexical expressions also occur in questions, as the following examples show.

- (1) a. Are you in Amsterdam?
b. Who is here?

These questions are context-sensitive. For instance, in a context where Jerry is the addressee of (1a), the speaker asks whether Jerry is in Amsterdam. Similarly, if (1b) is asked in Bob's office, then the speaker asks who is in Bob's office. The same kind of context-sensitivity can be found in statements. But questions can also be context-sensitive in a different way, one that does not occur with statements. Consider (2).

- (2) a. Where am I?
b. Who am I?
c. What time is it right now?

These questions are not context-sensitive in the standard sense. That is, we do not require information about the context to determine what is asked. Rather, it is the speaker who asks for information about the context: she wants to know the position of her utterance, the speaker of her utterance, or the time of her utterance, respectively. The fact that questions can be context-sensitive in this way is a new observation that poses a puzzle for the semantics of context-sensitivity.

Apriority and necessity of questions

Philosophers distinguish *a priori* truths and *necessary* truths (Kripke, 1980). A statement is *a priori* true if its truth can be established without information about what the world is like, while a statement is *necessarily* true if it could not have been false. Classical examples are (3) and (4), respectively:

- (3) I am here now.
(4) Hesperus is Phosphorus.

We know immediately whenever someone utters (3) that it must be true. However, it cannot be necessarily true, because the speaker could also have been somewhere else. By contrast, (4) is a true identity statement (both names refer to Venus), which has been argued to be necessarily true. But for a long time it was not known that Hesperus is Phosphorus, so it cannot be *a priori*.

This thesis argues that these notions should be generalized in such a way that they apply to questions and statements uniformly. Such a generalization could account for the contrast between (5a) and (5b), as well as the contrast between (6a) and (6b).

- (5) a. It is a priori whether I am here now.
- b. It is a posteriori whether I am in Amsterdam now.
- (6) a. It is contingent where I am.
- b. It is not contingent who I am.

The challenge is that the classical notions of apriority and necessity are connected to the truth values of expressions, while questions do not have truth values.

Questions with indexical resolution conditions

There is another way in which questions and indexicality interact. A question can require information that is essentially indexical, without the question itself necessarily containing any indexical expressions.

Notice that speakers are often very ignorant about the context in which they ask a question: they might not know what their current position is, or what the current time is. But even then, they can still ask about relative positions or times:

- (7) Where is the guide?
- ≈ Is the guide in front of us or behind us?

If the speaker is unaware of her own position, then information about the absolute position of the guide is not helpful in response to (7). Instead, information about the position of the guide relative to the position of the utterance is required. A different example of the same phenomenon is (8):

- (8) When do we need to leave?
- ≈ Do we need to leave five minutes from now or an hour from now?

If the speaker does not know the current time, then information about the exact time to leave is not helpful to her. The information about when to leave needs to be given relative to the time of the utterance.

We can also imagine speakers who are so ignorant of the context that they do not even know who they are. Consider the following example in which two amnesiacs, Rudolph Lingens and Adolf Dingens, try to find out who they are:

- (9) Who is who?
- ≈ Am I Lingens and are you Dingens, or are you Lingens and am I Dingens?

These examples have two things in common. First, the questions do not quantify directly over the domain (of positions, times and individuals, respectively), but rather over a particular way in which this domain is conceptualized. Second, the speaker has a conceptualization of the domain in mind that is essentially indexical. As a result, the question requires its answers to be essentially indexical too.

Question-directed attitude ascriptions

Indexical expressions also occur in questions when they are embedded under attitude predicates, as in the following examples:

- (10) My wife doesn't know where I am.
 (11) Who wonders whether I am in Amsterdam?

A semantics of questions and indexicality needs to account for the behavior of indexicals when they occur in these environments.

A well-known challenge for propositional attitudes is that attitudes about oneself can be *de se* as well as *de re* (Perry, 1979; Lewis, 1979). Consider the following example:

- (12) Lingens believes that he is in the Stanford library.

It has been argued that (12) has a reading that can be false even if Lingens knows that the sentence 'Lingens is in the Stanford library' is true, because he fails to realize that he himself is Lingens. Sentences with embedded questions, like (13a), can have such a *de se* reading too:

- (13) a. Lingens wonders where he is.
 b. Lingens wonders where Lingens is.

While (13a) has a *de se* reading that can be paraphrased as (14), (13b) lacks such a reading and can only be understood *de re*.

- (14) Lingens wonders 'where am I?'

This shows that there is a relation between indexical questions and *de se* readings that our semantics should account for.

Delimitation

Let me also mention some related topics that will not be covered in this thesis.

Questions and context-sensitivity can play a role in explaining the pragmatic effects of utterances. Some authors explain certain pragmatic inferences by keeping track of the conversational history, in particular the *question under discussion* (e.g. Roberts, 1996). The term 'context' is sometimes used to refer to this conversational history. This notion is distinct from the contexts that play a role in this thesis, which are descriptions of situational aspects (like time, place and speaker) in which an utterance takes place. Furthermore, this thesis is about how contexts affect the literal meaning of sentences, not on how they affect pragmatic inferences.

Second, questions can be context-sensitive because the information they require depends on the speaker's *goals*. For instance, (15) can in some cases be

answered by (16a), but in other cases this answer may not be specific enough, and an answer like (16b) is required instead.

- (15) Where is Joshua?
 (16) a. Joshua is in Poland.
 b. Joshua is in Krakow.

In a similar way, the information required by (17) can depend on the speaker's goals.

- (17) Who has been to Lombardy?

In a scientific investigation, (17) may be asked to get a complete list of people who went to Lombardy. But it can also be asked by someone who wants ideas for places to visit, and whose goal is just to find one person who went to Lombardy. The kind of context-sensitivity that relates to conversational goals will not be covered in this thesis. Instead, I will make two simplifying assumptions: first, I will think of places as coordinates on a map, and assume everyone is at exactly one place (but see Ginzburg, 1995). Second, although our semantics will be able to distinguish a *mention-all* and *mention-some* reading of questions like (17), I will not go into the relation between these readings and conversational goals (but see Van Rooij, 2003).

Another topic that I will not discuss is the distinction between the information that a sentence conveys and its presuppositions (Strawson, 1950). For instance, (18) (interpreted as an alternative question) presupposes that *Flamboyant* is a song by either Pet Shop Boys or The Human League, while (19) presupposes that David Bowie has exactly one song about space travel.

- (18) Is *Flamboyant* a song by Pet Shop Boys or The Human League?
 (19) Which song by David Bowie is about space travel?

The basic theories of question semantics that I discuss in this thesis either do not capture these kinds of presuppositions or simply treat them as informative content. However, these theories can be extended to capture presuppositions correctly (see e.g. Rullmann & Beck, 1998; AnderBois, 2012; Ciardelli et al., 2012).

Fourth and finally, like most other work on two-dimensional semantics, this thesis analyzes natural language expressions by translating them into expressions of a logical language. In doing so, it does not provide an exact theory that explains how these translations are obtained compositionally. However, the material presented in this thesis is compatible with existing compositional versions of inquisitive semantics (see Theiler, 2014; Champollion et al., 2015; Ciardelli et al., 2017).

Structure of the thesis

The account of indexicality that this thesis develops relies heavily on existing literature on two-dimensional semantics (primarily Kaplan, 1989). This branch of semantics is traditionally only concerned with declarative sentences. Chapter 1 provides an introduction to this tradition. It presents the ingredients that will be used in later parts of the thesis, by giving a detailed description of two-dimensional semantics for declaratives and explaining the subtleties of its different interpretations.

In Chapter 2, this two-dimensional approach is combined with two types of frameworks of question semantics: one in which questions are construed as sets of propositions (inquisitive semantics, Ciardelli et al., 2019), and one in which they are construed as relations over worlds (as in Lewis, 1982; Groenendijk & Stokhof, 1984). This results in semantic theories that can account for context-sensitivity in questions, and generalizations of the notions of apriority and necessity.

The next two chapters develop extensions of the proposition-set account. Questions with indexical resolution conditions are dealt with in Chapter 3. They require a refinement of the way quantification works. Chapter 4 develops a further extension by providing an account of question-directed attitude ascriptions, and *de se* attitudes in particular.

The final chapter investigates the logic of the basic framework of two-dimensional inquisitive semantics. It provides a sound and complete proof system for this logic.

All the material in this thesis is single-authored work that, at the time of writing, has not been published anywhere else.

1.

**Two-dimensional
semantics
for declarative
sentences**

In this chapter I will introduce the standard treatment of indexicality, apriority and necessity, which the rest of this thesis will build on. Since we follow existing literature on two-dimensional semantics, the scope of this treatment is limited to declarative sentences.

1.1 Motivation

A semantic theory aims to explain how the meaning of a sentence depends on the meaning of its parts and the way they are combined. In the most basic semantic framework, these meanings are *extensions*. An extension of an expression is that to which it applies in reality. For instance, the extension of a proper name like ‘Michael Crichton’ is the person Michael Crichton, while the extension of ‘dinosaurs’ is the set of all dinosaurs. The extension of a sentence is a truth value (true or false), and it can be determined based on the expressions the sentence consists of. For instance, (1) is true if the individual Roberta is a member of the set of dinosaurs, and false otherwise.

- (1) Roberta is a dinosaur.

A limitation of this extensional framework is that it assigns the same meaning to co-referring expressions. For instance, ‘Robert Zemeckis’ and ‘the director of *Back to the Future*’ have the same extension, namely Robert Zemeckis. But intuitively, these expressions do not have the same meaning. This becomes apparent when we imagine that Steven Spielberg had directed the film instead, in which case (2) would have been false:

- (2) Robert Zemeckis is the director of *Back to the Future*.

However, (3) would still have been true in that scenario:

- (3) Robert Zemeckis is Robert Zemeckis.

It follows from these observations that (4) is false, while (5) is true.

- (4) Necessarily, Robert Zemeckis is the director of *Back to the Future*.
 (5) Necessarily, Robert Zemeckis is Robert Zemeckis.

An extensional semantics cannot account for sentences in which counterfactual possibilities are considered, because the semantic value of an expression is tied to the actual world. We need a semantics that assigns an *intension* to expressions: a function that takes a possible world and returns the expression’s extension in that world (Carnap, 1956).

The intensions of proper names and definite descriptions have been argued to differ in a crucial way. While the extension of a definite description like ‘the

director of *Back to the Future* can differ from world to world, the extension of a proper name remains fixed across worlds: they are rigid designators (Kripke, 1980). This is why, intuitively, the director of *Back to the Future* could be someone else in a counterfactual situation, but Robert Zemeckis would still be Robert Zemeckis.

In this framework, the semantic value of a sentence is no longer a truth value, but rather a function from possible worlds to truth values, or equivalently, a set of possible worlds, namely those in which the sentence is true. This is the basic idea behind truth-conditional semantics.

There are several reasons for moving from this truth-conditional (or one-dimensional) semantics to a two-dimensional semantics in which sentences are evaluated relative to two points rather than one. I will discuss those reasons that are central to this thesis in turn.

1.1.1 Indexicals

Indexical expressions like ‘I’, ‘you’, ‘here’ or ‘now’ pose a challenge to truth-conditional semantics. The reason for this is that the truth conditions of sentences that contain indexicals cannot be given directly. Consider the following sentence:

(6) I am the king of Belgium.

We cannot say in which possible worlds (6) is true, because that depends on who the speaker is. It is true in the actual world if it is said by king Philippe, but it is false in the actual world if I say it. So in general, evaluation relative to a world does not yield a definite truth value. We also need to know what the circumstances are in which the sentence is uttered.

In the two-dimensional semantics of Kaplan (1979, 1989) this idea is made explicit in a formal way: sentences have a truth value relative to two points rather than one. The first point (the context of utterance) provides the referents for indexical expressions in the sentence, and the second point (the world of evaluation) provides the state of affairs against which the sentence is evaluated.

1.1.2 Actuality

Another argument for two-dimensional semantics is that it can account for the meaning of sentences like (7):

(7) The students in class could have all joined the protest march.

This sentence indicates that there exists a possible world in which all the students who are in class in the actual world have joined the protest march, and are therefore not present in class in that world. This reading cannot be obtained by letting ‘the students in class’ take scope over the possibility modal:

$$(8) \quad \forall x(Cx \rightarrow \Diamond Px)$$

What (8) indicates is that each individual student in class today could have been at the protest march. But this is much weaker than saying that there is a possibility in which they are *all* there. For sentences like (7), a correct analysis in terms of scope does not exist.¹ The problem is that the possibility modal should have wide scope relative to the quantifier, while the expression Cx is to be evaluated in the actual world rather than a counterfactual possible world.

What we need is an actuality operator A that shifts the evaluation of an expression from the current world of evaluation back to the actual world (Crossley & Humberstone, 1977):

$$(7') \quad \Diamond \forall x(ACx \rightarrow Px)$$

In this way, Cx in (7') is interpreted in the actual world rather than in the modal context introduced by \Diamond .

1.1.3 A priori and necessary truths

Philosophers distinguish two kinds of truths: a priori and necessary ones (Kripke, 1980). Providing a formal account of this distinction is another motivation for two-dimensional semantics (Stalnaker, 1978; Jackson, 1998; Chalmers, 2002, 2004). A statement like (9) is a priori true, because its truth can be established without information about what the world is like.

(9) I am here now.

(10) You are Omar.

A statement like (10) (addressed to Omar) is necessarily true, because it could not have been false according to metaphysical or logical laws – in this case the necessity of identity.²

Crucially, two-dimensional semantics shows that a priori statements do not have to be necessary and vice versa. For instance, (9), although a priori, is not necessary, because I could have been somewhere else right now. Conversely, (10), although necessary, is not a priori, because someone could fail to know it.

Some authors (e.g. Jackson, 1998; Chalmers, 2002, 2004) use two-dimensional semantics for more ambitious goals, and have argued that it can be used to distinguish a priori from necessary truths beyond indexicals. On the view of Chalmers

¹At least, not in a first-order modal language.

²The necessity of identity and the rigidity of proper names are not crucial assumptions of two-dimensional semantics, but they do raise a puzzle that two-dimensionality can be a solution to. The point of two-dimensional semantics is not to show exactly what is a priori and what is necessary, but to give an account of how the two can be distinct. I will go into the assumptions of this thesis with respect to identity and proper names in Section 1.3.

(2004), the first point of two-dimensional semantics should not be viewed as a context of utterance per se, but more generally as an epistemic scenario: some way the actual world might be according to our knowledge of it.

In this way, two-dimensional semantics can be used to show why other necessarily true statements, like identity statements between co-referring names, can still have non-trivial cognitive significance, a problem known as Frege's puzzle (Frege, 1892). This applies for instance to the two familiar examples in (11) and (12), which were once scientific discoveries, but are nevertheless argued to be necessarily true:

(11) Hesperus is Phosphorus.

(12) Water is H₂O.

On its epistemic interpretation, two-dimensional semantics can be used to distinguish two kinds of intensions of expressions. The primary intension has an epistemic nature: it considers possibilities that might be the case. The secondary intension keeps the actual world fixed, and considers possibilities as ways the world could have been but is not. Following Haas-Spohn (1995), I will refer to these intensions as *subjective* and *objective* intension respectively.

The aposteriority of (11) can be explained by two-dimensional semantics because it is not true in every epistemic possibility – this is because it may not be known to what object the names Hesperus and Phosphorus exactly refer. In other words, the subjective meaning of (11) ('whatever Hesperus refers to is whatever Phosphorus refers to') is not trivially true. On the other hand, its necessity can be explained by the fact that, given an actual world that fixes these referents (both Hesperus and Phosphorus refer to Venus in the actual world), the objective meaning (the proposition that Venus is Venus) is true in all counterfactual possibilities.

In the rest of this thesis, I will stay agnostic about the exact interpretation of two-dimensional semantics, as for a large part this does not bear on the semantic analysis of questions.³ The theory developed in this thesis will be compatible with different interpretations of two-dimensional semantics.

1.2 Two-dimensional semantics

In this section I will describe a first-order two-dimensional semantics for declarative sentences that will be used as the basis for the rest of this thesis. It is based primarily on Kaplan (1989), and I will mostly use terminology that originates there.

³An exception is Chapter 4, in which I develop an account of question-directed attitudes. Here we will see that it does matter how we interpret two-dimensional semantics.

1.2.1 Context and index

Sentences will be evaluated relative to two points: a *context* and an *index*. The context can be thought of as the situation in which the utterance is made, while the index represents the circumstance of evaluation.

Contexts can be either primitive objects or lists of parameters. If they are lists of parameters, they should at least contain a speaker, addressee, time, position and world. However, it is difficult to make this list exhaustive – for a treatment of demonstratives, we also need access to generally salient objects, pointing gestures, and perhaps even to the intentions of the speaker (Lewis, 1970, 1980). I will remain agnostic about the exact parameters that a context consists of:⁴

DEFINITION 1.2.1. Context

A context c is a list of parameters, containing at least a_c, b_c, p_c, w_c (speaker, addressee, position, world) such that in world w_c , speaker a_c is at position p_c .

To simplify presentation throughout the thesis, I will not assume that there is a time parameter, and I will not give a treatment of any examples that crucially rely on time. But it is straightforward to extend the system with a time element as well. For instance, the behavior of ‘now’ with respect to time is the same as the behavior of ‘actually’ with respect to worlds (see Kamp, 1971).

The requirement for contexts c that the speaker at a_c is at position p_c in world w_c means that, in the terminology of Kaplan, we only allow *proper* contexts. As we will see, it is this requirement that makes statements like (9) special.

This brings us to the second evaluation point, the index. In Kaplan’s work, this index consists of two parameters, a world and a time. I will remain agnostic about the exact anatomy of indices too, with two exceptions: first, I assume that they determine at least a world, and second, I assume that they have no parameters that contexts do not have.

DEFINITION 1.2.2. Index

An index i is a list of parameters, containing at least a world w_i . The parameters of indices are a subset of the parameters of contexts.

Given these assumptions, for every context c there exists an index i_c that has the same parameters as c , except that it does not have those parameters that contexts have and indices do not.

⁴The ‘speaker’ of a context is not always literally a speaker, but should be considered the producer of the utterance regardless of whether it is written, spoken, or just thought. Kaplan (1989) refers to this as the ‘agent’ of the context.

DEFINITION 1.2.3. Index corresponding to context

If c is a context, then i_c is that index such that for all index-parameters

x : $x_{i_c} = x_c$.

1.2.2 Content and character

In two-dimensional semantics, statements do not directly express propositions. In fact, Kaplan (1989) distinguishes two levels of meaning for any type of expression, namely *content* and *character*. The content of an expression is its intension, and its character reflects how this content changes between contexts.

For instance, the content of ‘the person left of me’, as uttered by Bob, is the individual concept ‘the person left of Bob’: a function that maps every index to the person to the left of Bob at that index. But the content of ‘the person left of me’ as uttered by John is a completely different individual concept. The character of this expression is a function from contexts to these different contents. It provides a more general layer of meaning that is independent of the speaker of the sentence.

The content of a sentence can be thought of as its truth conditions. Formally, the content of a sentence is a proposition (a set of indices), and its character is a function from contexts to contents. Equivalently, characters of sentences can also be viewed as sets of context-index pairs, namely those pairs $\langle c, i \rangle$ such that the content expressed in context c is true at index i . In this thesis, both of these interpretations of characters will be used interchangeably.

1.2.3 Language and semantics

Here and elsewhere in the thesis, the non-logical symbols of the language are n -ary relation symbols and variables. A term t is either a relation symbol of arity 0 (an individual constant) or a variable. In this chapter, the language is defined as follows, where R is an n -ary relation symbol, t_1, \dots, t_n are terms and x is a variable:

$$\varphi ::= R(t_1, \dots, t_n) \mid (t = t') \mid \perp \mid \varphi \wedge \varphi \mid \varphi \rightarrow \varphi \mid \forall x \varphi \mid \Box \varphi \mid A\varphi$$

The intended reading of the modal operators is as follows: $\Box \varphi$ can be read as ‘necessarily φ ’ and $A\varphi$ as ‘actually φ ’.⁵ Sentences are evaluated in a model, which is defined as follows:⁶

⁵We will use the actuality operator as a device that (in the scope of a necessity operator) shifts evaluation back to the actual world, as defined in Crossley & Humberstone (1977); Kaplan (1989). This is not the same as what ‘actually’ means in natural language, see Yalcin (2015).

⁶Unlike in Kaplan (1989), the model has a constant domain and there is no existence predicate, which means that the individuals (and positions) that exist do so in all worlds (and therefore necessarily, contrary to intuitions). This is just a simplification that we can make because we will not treat any examples that rely on existence.

DEFINITION 1.2.4. Model

A model M is a structure $M = \langle C, J, W, D, P, I \rangle$ such that

- C is a non-empty set of contexts
- J is a non-empty set of indices
- W is a non-empty set of worlds
- D is a non-empty set of individuals
- P is a non-empty set of positions
- I is an interpretation function (assigns an intension to all relation symbols)

We write $[\alpha]_{cig}^M$ for the denotation of expression α with respect to model M , context c , index i and assignment function g . We omit M whenever possible. The denotation of terms is defined as follows:

- $[I]_{cig} = a_c$
- $[you]_{cig} = b_c$
- $[here]_{cig} = p_c$
- If b is any other constant, $[b]_{cig} = I(b)(i)$
- If x is a variable, $[x]_{cig} = g(x)$ ⁷

We also define some special predicates:

- $[Pos]_{cig} = P$ (a predicate that applies to all and only the positions)
- $[Ind]_{cig} = D$ (a predicate that applies to all and only the individuals)
- $[Located]_{cig} = \{ \langle d, p \rangle \mid d \in D, p \in P \text{ and } d \text{ is at } p \text{ in } i \}$
- If Q is any other predicate, $[Q]_{cig} = I(Q)(i)$

This means we have three indexical terms, ‘I’, ‘you’ and ‘here’, which get their referent from the context, and three special predicates *Pos*, *Ind* and *Located*. Other terms and predicates get their referent in the same way as in classical first-order models. We define assignment function g_d^x as the assignment function that is exactly like g , except that it maps x to d . The semantic clauses for the connectives are given below.⁸

⁷Note that variables range over two domains: that of individuals and that of positions.

⁸Note that \forall quantifies over both the domain of individuals and the domain of positions. The predicates *Ind* and *Pos* can be used as restrictors.

- $c, i \models_g Qt_1 \dots t_n \iff \langle [t_1]_{cig}, \dots, [t_n]_{cig} \rangle \in [Q]_{cig}$
- $c, i \models_g t = t' \iff [t]_{cig} = [t']_{cig}$
- $c, i \not\models_g \perp$
- $c, i \models_g \varphi \wedge \psi \iff c, i \models_g \varphi \text{ and } c, i \models_g \psi$
- $c, i \models_g \varphi \rightarrow \psi \iff c, i \models_g \varphi \text{ implies } c, i \models_g \psi$
- $c, i \models_g \forall x \varphi \iff \text{for all } d \in D \cup P : c, i \models_{g_d^x} \varphi$
- $c, i \models_g \Box \varphi \iff \text{for all } j \in J : c, j \models_g \varphi$
- $c, i \models_g A\varphi \iff c, i_c \models_g \varphi$

We define the following abbreviations:

$$\neg\varphi := \varphi \rightarrow \perp \quad \varphi \vee \psi := \neg(\neg\varphi \wedge \neg\psi) \quad \exists x\varphi := \neg\forall x\neg\varphi \quad \Diamond\varphi := \neg\Box\neg\varphi$$

Three things are worth noting. First, sentences are evaluated with respect to a context and an index: thus, $c, i \models_g \varphi$ means that the proposition that φ expresses in c is true in i .⁹ Second, the necessity operator \Box shifts evaluation to different indices, but keeps the context (and thus the content of the sentence) fixed. Third, the actuality operator A shifts evaluation back to the actual world, by taking the index that belongs to the context of utterance as the index of evaluation.

1.3 Identity and proper names

Before we look at some examples of analyses of sentences in two-dimensional semantics, let me mention a few assumptions that this thesis will make with respect to identity and proper names.

1.3.1 Necessity of identity and rigidity of names

As mentioned, two-dimensional semantics can explain how it is possible that a necessarily true sentence like (10), repeated below, can still provide new information (it is a posteriori).

(10) You are Omar.

⁹Technically there are three parameters, but the assignment function g is vacuous if there are no free variables.

The diagnosis of (10) as a necessarily true sentence is based on three assumptions. First, that indexicals like ‘you’ are rigid designators – that is, although their referent varies per context, it does not vary per index. This is also what I will assume.¹⁰ Second, that proper names are rigid designators. So ‘Omar’ also picks out the same referent in every index. And third, the necessity of identity: if two objects are identical in the actual world, they are identical in all worlds in which they exist (Kripke, 1971, 1980).

Not everyone accepts that identity is necessary (e.g. Gibbard, 1975; Kocurek, 2018; see Schwarz, 2013 for a discussion), but this does not have to stand in the way of accepting two-dimensional semantics. In our models, the necessity of identity follows from the fact that the identity symbol is used to express real identity of objects in the domain, rather than an explicitly defined relation in the model that may hold between two elements in some but not all worlds. This is not a crucial ingredient to the mechanism of two-dimensionality. The same can be said about the rigidity of proper names.

Our assumptions about identity and names also affect the analysis of questions. If we assume necessity of identity and rigidity of names, then it is not immediately clear why questions about identity are not trivial:

(13) Is Batman Bruce Wayne?

(14) Who is Beyonce?

One could see this as a reason to reject these assumptions.¹¹ However, in this thesis I assume necessity of identity and rigidity of proper names, to show that we need not give them up. Instead, we can use ideas from two-dimensional semantics to account for a posteriori identity questions in a way that is compatible with Kripke’s ideas. In doing so, I develop an account that captures linguistic intuitions about the truth and falsity of necessity and contingency claims. I do not intend to make strong metaphysical claims about necessity (see e.g. Fine, 2002; Nolan, 2011; Williamson, 2016).

1.3.2 Absolute or indexical names

According to Kaplan, proper names are not only rigid designators, but also *absolute*: that is, their referent is not only fixed across indices, but also fixed across contexts. Under this analysis, it is difficult to explain why sentences like (11), repeated below, are a posteriori, in contrast to Chalmers (2004).

(11) Hesperus is Phosphorus.

¹⁰There might be exceptions: in Chapter 3 we will see an example of a descriptive use of indexicals.

¹¹For instance, the analysis of identity questions in Ciardelli (2016, Chapter 4) relies on contingent identity.

Another strategy to account for this data, which differs from Chalmers' idea, is to posit that proper names (and natural kind terms) are 'hidden indexicals' (Haas-Spohn, 1995): just like proper indexicals like 'I', their referent is determined by the context of the utterance, and remains fixed if we consider other worlds of evaluation. The difference lies in the way their referent is determined: the character of 'I' is only a linguistic convention, while the character of 'Hesperus' is a different kind of convention (it is a function from worlds to whatever the astronomical object is that we observe in the evening in that world). The perspective of Haas-Spohn (1995) requires a more liberal interpretation of what contexts are than what Kaplan had in mind – instead of just formal descriptions of the circumstances in which an utterance is made, they should also fix the origin of the usage of proper names. However, this view of contexts is conceptually much more similar to Kaplan's contexts than Chalmer's epistemic scenarios.

As I mentioned in Section 1.1.3, I want the theory in this thesis to be compatible with different interpretations of two-dimensional semantics. As for proper names, I will assume, contra Kaplan, that their referent can vary per context. Thus, we assume that proper names are a special subset of constants, which are interpreted as follows:

$$\text{If } b \text{ is a proper name, } [b]_{cig} = I(b)(i_c)$$

This means that we either need to assume that contexts are not just contexts of utterance but epistemic scenarios, or more conservatively, that proper names are in some way indexical. I leave it to the reader to make this decision.

1.4 Applications

We are now ready to illustrate the workings of two-dimensional semantics with some applications. First, consider (15):

- (15) John is here.
Located(John, here)

Suppose p_c is Paris and p_e is Kiev, and John is in Paris at i and in Kiev at j . Then in c , (15) expresses a proposition that is true in i and false in j . But in e , it expresses a proposition that is false in i and true in j . Following the convention introduced in Stalnaker (1978), we can represent the character of (15) in a matrix, which is shown in Figure 1.1.

Using the notion of character, we can capture in a formal way what it means for an expression to be context-sensitive. A sentence like (15) is context-sensitive, because its content (the proposition that is expressed) varies between contexts of utterance. In general, the following fact applies:

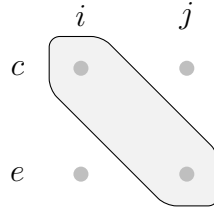

Figure 1.1: The character of (15) in a matrix. Dots represent context-index pairs. The pairs in which the sentence is true are the ones contained in the gray area.

FACT 1.4.1. Context-sensitivity

An expression α is context-sensitive just in case the character of α , viewed as a function from contexts to contents, is not a constant function.

The standard definitions of what it means for a sentence to be necessarily or a priori true (following Chalmers, 2004; Fritz, 2013) are given below.

DEFINITION 1.4.1. Necessity and apriority

φ is *necessarily true* in c iff for all indices $i : c, i \models \varphi$
 φ is *a priori true* iff for all contexts $c : c, i_c \models \varphi$

In words, what it means for a sentence to be a priori true is that whatever it expresses in a context c is true according to the state of affairs in that context itself. This means that while necessity is a property that the *content* of a sentence in a particular context may have, apriority is a property that may apply to the *character* of a sentence.

The reason that (9), repeated below without the time indication in (16), is a priori is that whatever context c we pick, the proposition it expresses there will be true in c itself. This is not the case for (17): we can find a context c such that in i_c , a_c is not in London.

(16) I am here.
Located(I, here)

(17) I am in London.
Located(I, London)

Sentence (18) is necessarily true in a context c where a_c is John, because it expresses the proposition that John is identical to himself, which, given our as-

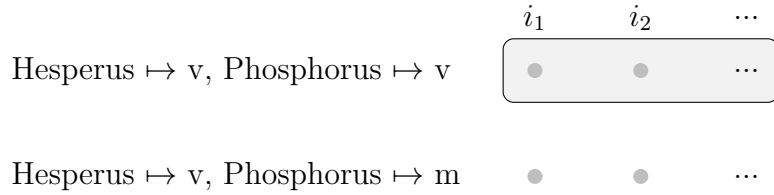

Figure 1.2: The character of (11) in a matrix. The context on top is the actual one, where both Hesperus and Phosphorus refer to Venus. The proposition expressed here is necessary. In the bottom context, Phosphorus refers to Mars. The sentence fails to be true in all diagonal points, showing that it is a posteriori.

sumptions, is a necessary truth.

- (18) I am John.
 $I = \text{John}$

Based on these definitions of necessity and apriority, the following definitions of contingency and aposteriority can be given:

DEFINITION 1.4.2. Contingency and aposteriority
 φ is *contingent* in c iff neither φ nor $\neg\varphi$ is necessarily true in c .
 φ is a *posteriori* iff neither φ nor $\neg\varphi$ is a priori true.

The idea that there is a subjective intension and an objective intension to expressions can now be made more precise as well. While the subjective intension is the diagonal of the matrix (the set of contexts c such that $\langle c, i_c \rangle$ makes the sentence true), the objective intension in a particular context c is a row of the matrix (the set of indices i such that $\langle c, i \rangle$ makes a sentence true).

To illustrate, consider again (11), repeated below, and its matrix, displayed in Figure 1.2.

- (11) Hesperus is Phosphorus.

The fact that the subjective intension of (11) is false in some contexts, while the objective intension in the actual context is always true, shows how (11) can be a posteriori as well as necessary.

Finally, let us examine the workings of the actuality operator A to see how it solves the problem of (7), repeated below:

- (7) The students in class could have all joined the protest march.
 (7') $\Diamond\forall x(ACx \rightarrow Px)$

As discussed in Section 1.1.2, we need the actuality operator A to evaluate Cx in

the actual world rather than in the modal context introduced by \diamond . Unpacking the clauses for \square and A , we can see that this is exactly what the actuality operator does: (7') is true in a pair $\langle c, i_c \rangle$ just in case there is an index j where all individuals are at the protest march if they are in class at i_c .

This concludes the exposition of the ingredients of two-dimensional semantics that we will need in what follows. The next chapter will examine how the formal notions introduced in the present chapter have to be adapted in order to apply to questions. For instance, we have seen that the content of a statement is a proposition, and its character is a function from context to contents. How do we define the content and character of questions? And what does it mean for a question to be context-sensitive, a priori or necessary? Given that all these notions are traditionally tightly connected to truth, it is not immediately clear what the correct generalizations would be.

2.

Semantics of
questions
and indexical
expressions

In Chapter 1 we examined how two-dimensional semantics can provide an account of certain observations with respect to indexicality and modality. A fundamental aspect of this account is that it is based on the idea that a sentence has a truth value relative to a context of utterance and an index of evaluation. Although this idea is powerful, it also marks the limits of two-dimensional semantics. There is a type of sentence that cannot in general be characterized in this way, namely questions.

2.1 Motivation

2.1.1 Questions

Unlike statements, questions are not true or false relative to a particular circumstance. Compare (1a) and (1b):

- (1) a. Luka's birthday is the 7th of July.
 b. What is Luka's birthday?

It is easy to say what a circumstance has to be like for (1a) to be true: there has to be a person named Luka who was born on the 7th of July. But we cannot come up with circumstances in which (1b) is true. Because questions have no truth value, their meaning – just like the meaning of sentences with indexicals – cannot be captured directly in terms of truth conditions. Thus, questions call for a refinement of truth-conditional semantics.

Several different strategies have been proposed to deal with questions. In this chapter I will distinguish two general approaches: one that analyzes questions as relations over possible worlds, and one that analyzes questions as sets of propositions.

In a relational semantics, questions are viewed as context-sensitive entities (Groenendijk & Stokhof, 1984; Lewis, 1982; Groenendijk, 2009; Mascarenhas, 2009; Aloni et al., 2013). Given an actual world, a question expresses the proposition that represents the true answer in that world. Or equivalently: questions have a truth value relative to a pair of worlds rather than a single world. The first world determines the true answer to the question, and the second world provides the state of affairs against which this answer is evaluated. As an example, the question in (2) is true relative to two worlds either if John is in Amsterdam in both, or if John is somewhere else in both.

- (2) Is John in Amsterdam?

In other words, a question can be viewed as a relation that holds between two worlds if they agree on how the question should be resolved.

The second group of approaches analyzes questions not as context-sensitive

entities, but as sets of propositions (Hamblin, 1973; Ciardelli et al., 2019). Depending on the framework, these propositions can be viewed as possible answers, possible continuations of the discourse, or states of information in which the question is resolved. In such frameworks, (2) expresses a set that contains the propositions ‘that John is in Amsterdam’ and ‘that John is not in Amsterdam’.¹

What the accounts of question semantics that I consider here agree on, is that the semantic value of a sentence in general is an expression of a different type than the traditional set of worlds, namely either a set of pairs of worlds or a set of sets of worlds.²

2.1.2 Indexicals in questions

Assuming that we adopt a two-dimensional semantics to account for indexicals, and one of the frameworks mentioned above to account for questions, it seems we should consider a combination of the two, if we want to account for questions in which indexicals occur:

- (3) a. Are you in Amsterdam?
b. Who is here?

It is obvious that these questions, just like questions without indexicals, should express (depending on the framework of choice) either a set of world-pairs or a set of propositions. The fact that we also need a dimension for indexicals becomes apparent when we consider questions that are embedded by an attitude predicate, or that contain an attitude predicate themselves:

- (4) a. John doesn’t know where I am.
b. Who believes that I am in Amsterdam?

Suppose we use our favorite question semantics, without implementing any two-dimensionality to account for indexicals. Assume also that the referent of ‘I’ varies per index. Then (4a) would be true in a situation where John knows where everyone is located, but doesn’t know to whom ‘I’ refers. But this is not a possible reading of (4a) – our semantics should predict that it is true in case John doesn’t know where the actual speaker of the sentence is.

Similarly, in a one-dimensional semantics, (4b) asks to specify the individuals who believe that whoever the speaker is, is in Amsterdam. But in fact it asks to specify the individuals who believe of the actual speaker that she is in Amsterdam.

¹In the case of inquisitive semantics (Ciardelli et al., 2019), this set also contains all propositions that are strictly stronger than these two.

² Another framework for the semantic analysis of questions is the functional or categorial approach (Hausser & Zaefferer, 1978), in which questions are analyzed as functions from individuals to propositions. I will not discuss this approach, because it is not suitable for a non-reductive analysis of the apriority of questions. I will argue against reductive approaches in Section 2.2.

In both examples, the referent of ‘I’ should be independent of the modal context introduced by the embedding verb. We could simply postulate that indexicals like ‘I’ always take scope over embedding operators. However, as we have seen in Chapter 1 with declarative sentences, we need to do more if we also want to account for the distinction between apriority and necessity of sentences with indexicals.

2.1.3 Apriority and necessity

A second piece of motivation for a combination of two-dimensionality and question semantics is that there is a natural way in which the notion of apriority can be extended to questions. In the same way that statements can be a priori true, questions can be a priori *resolved*: for instance, we know that (5a) can only be answered positively, even if we don’t know what the world is like, or what the referents of ‘I’, ‘here’ and ‘now’ are. This is not the case for (5b): to resolve this question, we need to know to whom ‘I’ refers and where this person is.

- (5) a. Am I here now?
b. Am I in Amsterdam now?

A priori linguistic expressions can be viewed as defective ones: statements are generally uttered in order to convey information, so an a priori statement like (6) is defective, because it fails to convey any real information.

- (6) I am here now.

Similarly, questions are generally uttered in order to *request* information, and an a priori question like (5a) fails to request any real information. Another common way to understand apriority is as ‘a priori knowability’. Questions can be a priori in this sense as well: just as it is a priori knowable *that* I am here now, it is a priori knowable *whether* I am here now.

Thirdly, questions can be about necessary or contingent facts, like the embedded questions in (7a-b).

- (7) a. It is contingent where I am.
b. It is contingent who I am.

While (7a) is true, (7b) is false (that is, if we follow Kripke (1980) and accept that identity is necessary). This means that there is a difference between the embedded questions ‘where am I?’ and ‘who am I?’ that a semantics of questions should capture.

2.1.4 Actuality

Finally, the actuality operator, which is used in two-dimensional semantics to switch evaluation from the modal context back to the actual world, is also required for an adequate analysis of some questions, like the embedded question in (8):

(8) John doesn't know which students are students.

There is a non-contradictory reading of (8), which is true if there is at least one actual student, of which John is unaware that she's a student. This means that the first occurrence of 'students' should be interpreted outside of the scope of John's knowledge, since it refers to the students in the actual world. As we will see later, this can be achieved with an actuality operator, given the right semantics.

These observations show that the semantics of questions and indexicals interact in interesting ways. However, the frameworks that have been proposed to account for questions need refinements in order to capture these facts. The purpose of this chapter is to develop these refinements.

First, in Section 2.2, I will argue against the suggestion that the apriority of questions reduces to the apriority of their answers. I will then work out an account of indexicals in questions for the two types of frameworks of question semantics mentioned before: first, a proposition-set account in Section 2.3 and then a relational account in Section 2.4. In Section 2.5, I return to the use of an actuality operator in questions, and I conclude in Section 2.6.

2.2 Reductive analysis of apriority

I view the observation that some questions are a priori as a data point that a semantics for questions with indexicals should account for. Empirical support for this position comes from the fact that sentences like (9) can be uttered and judged to be true or false.

(9) It is (not) a priori whether I am here now.

There is a prominent tradition in semantics in which questions that occur in an embedded environment are analyzed reductively (Karttunen, 1977; see also Heim, 1994; Dayal, 1996; Spector & Egré, 2015 for variants). To illustrate, consider (10).

(10) Inge knows who came to the wedding.

It is assumed by these theories that the type of object that *know* embeds is a proposition. In the case of an embedded question, this proposition is (depending on the theory) either one of its true answers or the conjunction of its true answers.

On this analysis, (10) means either that Inge knows a proposition 'that x

came to the wedding' for some individual x that in fact came to the wedding, or the proposition 'that G came to the wedding' for the set G of people that in fact came to the wedding. What makes this strategy reductive is that knowledge of a question is analyzed in terms of knowledge of a proposition, the semantic value of a statement.

Following this line of thought, it is natural to ask whether we can give a reductive account of sentences like (9) as well. For instance, could we say that a question is a priori just in case it has a true answer that is a priori?³ On such a reductive definition of apriority, (11) would be a priori because its true answer is a priori.

- (11) Am I here now?
True answer: I am here now.⁴

However, there are some problems for this analysis. Answers are normally not construed as specific sentences, but as propositions. The reason for this is that whether something counts as an answer to a question is viewed as depending only on the content of the expression, not on the way it is expressed.

As we have already seen in Chapter 1, propositions are not the kinds of objects that can be a priori. There is nothing special about the proposition that 'I am here now' expresses in a particular context, it is its character that is a priori. For a reductive account to go through, we have to be able to detect whether an answer is a priori, so answers would have to be construed as characters rather than propositions. No matter what particular analysis of questions we choose, this means it needs to be revised in a non-trivial way.

Firstly, it is not so clear that question-answer relations always obtain at the level of characters. Consider the following example.

- (12) a. John: Who of the girls wants to go to the beach?
b. Mary: I want to go to the beach!
c. Bob: I want to go to the beach!

Intuitively, we would count Mary's statement in (12b) as an answer to John's question in (12a). But if this is so, then it must be because the *proposition* it expresses counts as an answer. If the statement would count as an answer based on its *character*, then Bob's statement in (12c) (which has the same character) would also count, which is intuitively not the case. So it seems to be more natural to determine at the propositional level whether something is an answer

³Note that in a two-dimensional framework, this has to be made more precise. If answers are characters, then an answer to a question is true relative to a context-index pair, and there are context-index pairs in which the true answer to 'Are we here now?' is 'We are not here now'. This means we should also restrict the context-index pairs in which we look for true answers.

⁴I abstract away from the pragmatic fact that the person who answers a question is normally not the one who asked it.

to a question.

Secondly, if answers are characters, then what prevents us from answering (13b) in the same way we would answer (13a)? We would say that (13a) is a priori because of the apriority of its true answer, but intuitively (13b) is not a priori, even though it has a true answer that is exactly the same.

- (13) a. Are we here?
 True answer: We are here.
 b. Where are we?
 True answer: We are here.

A reductive approach needs to supply a theory of answerhood that explains why ‘We are here’ is an answer to ‘Are we here?’, but not to ‘Where are we?’. Another possible response would be to say that a question is a priori just in case the *conjunction* of its true answers is. In that case, since (13b) also has a true answer that is not indexical (for instance, ‘We are in London’), the conjunction of its true answers is not a priori, and the problem would not arise in this particular case.

A third problem is that there might be a priori questions for which their true answer (or the conjunction of their true answers) is not a priori. For example, (14) seems to be an a priori question:

- (14) Which first year students are students?

According to theories that analyze questions as sets of answers, answers to this question are about individuals, so answers would be ‘John is a student’, ‘Mary is a student’, etc. These are not a priori, and neither is the conjunction of all these answers. It has been proposed by Rothschild (2013) to also add statements like (15) to the answer set of which-questions:

- (15) All first year students are students.

This statement is indeed a priori, but it would not help, since the conjunction of all true answers would still not be a priori. It does not sound reasonable to say that (15) is the *only* true answer to (14). To compare, even if (16) is asked in a context in which all students happen to be first year students, then it should still be possible to answer by naming them all individually.

- (16) Which students are first year students?

To sum up, there are two main reasons not to pursue a reductive strategy: first, a reductive theory would only work if we change the way we normally think about questions and answers. Second, it is committed to a direct link between the apriority of a question and the apriority of its answers. It can therefore never predict that an a priori question can have only a posteriori answers, or that an a

posteriori question can have a priori answers.

2.3 Questions as sets of propositions

In this section we will explore how to integrate two-dimensional semantics into a framework that analyzes questions as sets of propositions. Our language and semantics of choice will be a first-order inquisitive semantics (Ciardelli et al., 2019) rather than a Hamblin-style alternative semantics (Hamblin, 1973; Karttunen, 1977). There are two differences between these systems that are relevant to us here.

The first difference is a conceptual one: in a Hamblin-style semantics, questions are sets of propositions that represent answers. In inquisitive semantics, the propositions represent states of information in which the question is resolved. Given the discussion in Section 2.2, the latter is more natural for our purposes: if we define questions in terms of the information that is required to resolve them, we can remain neutral about what it means for an expression to count as an answer to a question, and on what level (character or content) this relation should be defined.

The second difference is technical, but follows from the first: because the propositions in inquisitive semantics are viewed as information states in which the question is resolved, questions are *downward closed*: if a question is resolved in some particular information state, it is also resolved in a more informative information state. This means that questions, viewed as proposition sets, always contain all subsets of the propositions they contain. The conception of questions in inquisitive semantics allows for a natural notion of entailment: because of downward closure, entailment can be defined simply as set inclusion (see Roelofsen, 2013; Ciardelli et al., 2017; Ciardelli & Roelofsen, 2017).

Although these differences motivate our choice, they are not crucial to what follows – the way we incorporate two-dimensional semantics into inquisitive semantics could in principle be applied to other proposition-set semantics as well.

2.3.1 Inquisitive semantics

The motivation behind inquisitive semantics is the fact that sentences in general do not only provide information, but also raise issues. This is captured in a uniform way: statements and questions are analyzed as objects of the same semantic type. Both are evaluated relative to information states, which are modeled as sets of indices. A sentence is supported by an information state just in case the information expressed by the sentence is already present in the information state, and on top of that, the issue expressed by the sentence is resolved in the information state.

The language is a usual first-order one, extended with symbols for inquisitive

disjunction and inquisitive existential quantification:

$$\varphi ::= R(t_1, \dots, t_n) \mid (t = t') \mid \perp \mid \varphi \wedge \varphi \mid \varphi \vee \varphi \mid \varphi \rightarrow \varphi \mid \exists x\varphi \mid \forall x\varphi$$

Sentences are evaluated in standard first-order models with a constant domain. Normally, we do not distinguish contexts from indices (or indices from worlds) and we do not distinguish separate domains for individuals and positions.

DEFINITION 2.3.1. Model

A model M is a structure $M = \langle W, D, I \rangle$ such that

- W is a non-empty set of indices/worlds
- D is a non-empty set of individuals
- I is an interpretation function (assigns an intension to all relation symbols)

The semantics is defined as follows. Terms are interpreted in the standard way, and we write $[\alpha]_{ig}$ for the denotation of expression α with respect to index i and assignment function g . We write $s \models_g \varphi$ to indicate that information state s supports φ under assignment function g .

- $s \models_g Qt_1\dots t_n \iff$ for all $i \in s : \langle [t_1]_{ig}, \dots, [t_n]_{ig} \rangle \in [Q]_{ig}$
- $s \models_g t = t' \iff$ for all $i \in s : [t]_{ig} = [t']_{ig}$
- $s \models_g \perp \iff s = \emptyset$
- $s \models_g \varphi \wedge \psi \iff s \models_g \varphi$ and $s \models_g \psi$
- $s \models_g \varphi \vee \psi \iff s \models_g \varphi$ or $s \models_g \psi$
- $s \models_g \varphi \rightarrow \psi \iff$ for all $t \subseteq s : t \models_g \varphi$ implies $t \models_g \psi$
- $s \models_g \exists x\varphi \iff$ there is some $d \in D$ such that $s \models_{g_d^x} \varphi$
- $s \models_g \forall x\varphi \iff$ for all $d \in D : s \models_{g_d^x} \varphi$

Negation, classical disjunction and classical existential quantification are defined as before:

$$\neg\varphi := \varphi \rightarrow \perp \qquad \varphi \vee \psi := \neg(\neg\varphi \wedge \neg\psi) \qquad \exists x\varphi := \neg\forall x\neg\varphi$$

Two connectives are special: inquisitive disjunction \vee and the inquisitive existential quantifier \exists . Both have a support clause that looks standard, but states are sets and these clauses require them to be homogeneous: for a state to

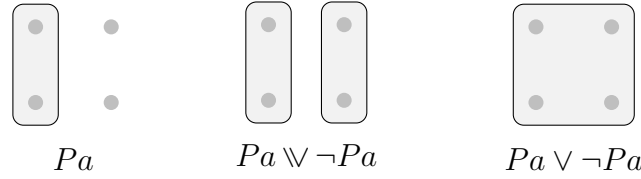

Figure 2.1: Alternatives in inquisitive semantics. Dots represent indices, rectangles represent information states containing those indices. Pa is true in the two indices on the left and false in the indices on the right. The states that support the formula are the ones drawn here and all their subsets.

support $Pa \vee Qa$, it is enough to provide the information that at least one of Pa or Qa is the case. To support $Pa \vee\vee Qa$, the state also has to specify which of the two is the case. Similarly, a state supports $\exists xPx$ if it provides the information that some x has property P , but to support $\exists xPx$, it also has to specify which element that is.

The set of states that support a formula is called an *inquisitive proposition*, and it always has the property of being non-empty (any formula is supported by the empty, inconsistent state) and of being downward closed: if an information state s supports φ , then any state that is at least as informative $t \subseteq s$ will also support φ .

Of special interest are the least informative states that support a formula, which are called *alternatives*.⁵ Classical formulas typically have exactly one alternative, while formulas that contain $\vee\vee$ or \exists can have more. The notions ‘questions’ and ‘statement’ can be defined in many ways, either semantically, syntactically or pragmatically. Throughout this thesis I will call a sentence a statement if it has exactly one alternative, and a question otherwise.⁶ For an illustration, see Figure 2.1, in which the alternatives of three formulas are displayed.

As mentioned before, an important advantage of the uniform treatment of statements and questions that inquisitive semantics proposes, is that it gives rise to a natural notion of entailment, as preservation of support.⁷

I will use $?x\varphi$ as shorthand for $\forall x(\varphi \vee\vee \neg\varphi)$, where \bar{x} is any finite sequence of variables. If this sequence contains one variable, the operator is used to ask for the extension of a property: $?xPx$ is short for $\forall x(Px \vee\vee \neg Px)$, which is supported by those information states that determine the extension of P . With the empty

⁵Formally, $\text{alt}(\varphi) = \{s \mid s \models \varphi \text{ and there is no } t \supset s \text{ such that } t \models \varphi\}$

⁶Note that this is a simplification. With infinite domains, it is possible to construct sentences that have no alternatives at all, as is shown in Ciardelli (2010). Any information state that supports such a sentence is contained in an infinitely growing chain of superstates. The existence of such sentences does not affect the issues discussed in this thesis, as we will not encounter them here.

⁷See Ciardelli et al. (2019) for a comparison with other frameworks for question semantics.

sequence of variables, the operator can be used to form polar questions: $?Pa$ is short for $Pa \vee \neg Pa$, which is the question whether Pa is the case.

This first-order variant of inquisitive semantics can represent a broad range of questions. Polar questions, which ask whether some fact is the case, can be formed using $?$ as in (17a). Alternative questions, which ask to choose between two or more alternatives, can be formed using \vee as in (17b). For *wh*-questions, like ‘Who has property P ?’, we can distinguish two kinds of readings: a mention-some reading (17c), which is resolved by identifying at least one individual with property P , and a more demanding mention-all reading (17d), which requires full information about the extension of property P . Finally, all these questions can be presented in a conditional form as well. For instance, questions of the form ‘If a has property P , does b do too?’ can be represented as in (17e).

- | | | |
|------|-------------------------|--------------|
| (17) | a. $?Pa$ | polar |
| | b. $Pa \vee Qa$ | alternative |
| | c. $\exists xPx$ | mention-some |
| | d. $?xPx$ | mention-all |
| | e. $Pa \rightarrow ?Pb$ | conditional |

However, this first-order variant is not committed to a particular translation from natural language questions to formulas of the language. It is outside the scope of this thesis to give a fully compositional account of questions, but for compositional variants of inquisitive semantics see Theiler (2014); Champollion et al. (2015); Ciardelli et al. (2017).

Let me end this exposition of inquisitive semantics with a note on *wh*-questions. The mention-some and mention-all readings of ‘Who has property P ?’ coincide if it is presupposed that exactly one individual has property P . This will turn out to be the case for most of the examples in this thesis. For instance, the mention-some reading of ‘Who am I?’, on the assumption that I am a single person, is no different from its mention-all reading. For this reason, the operator \exists will not be crucial to any of the examples we discuss in this thesis. But notice that this is something of a coincidence: there are several questions for which a mention-some reading is the most natural one, like (18):

- (18) Who has an iPhone charger I can borrow?

I will therefore keep the operator \exists around, but I will not use it as the primary ingredient of translations of *wh*-questions.

2.3.2 Level of support conditions

We are now ready to integrate the two-dimensional semantics from Chapter 1 into inquisitive semantics. Recall that, like inquisitive semantics, two-dimensional semantics also revises the classical approach of having sentences directly ex-

press truth conditions. While inquisitive semantics replaces truth conditions with support conditions, two-dimensional semantics makes truth conditions context-sensitive.

The first thing we have to decide is how to combine these two revisions. There are at least two ways in which this can be done. A first option is to simply make support conditions context-sensitive, by taking two-dimensional semantics and replacing truth conditions with support conditions. We would maintain the view that expressions can be captured by their character, as functions from contexts to contents. The contents of sentences would be encoded as inquisitive propositions rather than classical propositions. In other words, we evaluate our sentences relative to a context and an information state.

A second option would be to have sentences express support conditions directly, and introduce context-sensitivity at the level of information states. Sentences would be evaluated relative to information states only, and information states would not only represent information about the index, but also about the context.

Since the first option intuitively makes sense, let's look at it in a bit more detail, to see why ultimately we have to dismiss it.

Functions from contexts to support conditions

If contents express support conditions rather than truth conditions, the content of (19) would be an inquisitive proposition.

(19) Am I in Amsterdam?

This inquisitive proposition would vary per context. Contexts are the same as in Chapter 1: lists of parameters including a speaker, addressee, position and world. If the speaker of the context is John, the content of the question would be that of 'Is John in Amsterdam?', but if the speaker is Mary, the content would be that of 'Is Mary in Amsterdam?'. The character of this question would be a function that takes a context c and returns the set of information states that specify either that a_c is in Amsterdam or that a_c is not in Amsterdam. Thus, sentences would be evaluated relative to pairs $\langle c, s \rangle$ consisting of a context and an information state.

So far, things are as they should be. However, questions like (20) would be problematic for such a set-up.

(20) Where am I?

The problem arises when we want to check whether this question is a priori. In standard two-dimensional semantics, we check for every context c whether c considered as index makes the content expressed in c true. This definition needs to be generalized in terms of support: we need to check whether the content in c

is supported by some information state s_c . Which one? A minimal requirement would be that in all indices in this information state, a_c is at p_c – otherwise the Kaplanian a priori truths would no longer come out as a priori on our account. But then (20) comes out as a priori supported, because whatever context c we pick, we will thereby fix one position p_c such that in all worlds in s_c , a_c will be located at p_c . This prediction is wrong: (20) cannot be resolved without experience, we need to know who the speaker is and where she is. The same argument can be made with the following questions:

(21) What time is it right now?

(22) Who am I?

Both (21) and (22) are trivial given a context and an information state that matches this context in terms of time, position and speaker. But they should not be classified as a priori questions, because intuitively we need information to resolve them.

The problem here is that the support conditions of such questions cannot be obtained by fixing a context, because the question raises an issue about *what the context is like*. Thus, the context itself becomes an object of inquiry. This is the reason why the second option we considered above is the correct one. In this second approach, support conditions are introduced at the level of characters. In other words, the shift from evaluating relative to single entities to sets of them (information states) does not happen at the level of content but at the level of character: rather than evaluating a sentence relative to a single context-index pair, we evaluate it relative to sets of such pairs. Such sets represent information both about the context and about the index. This means that we need to rethink the notion of information states.

2.3.3 Information states

In standard inquisitive semantics, information states are sets of indices or worlds. In our revised definition, information states are sets of context-index pairs:

DEFINITION 2.3.2. Information state

An information state is a set of pairs $\langle c, i \rangle$, where c is a context and i an index.

An information state encodes information about what the context might be, and what the index might be. For instance, the information state $\{\langle c, i \rangle, \langle e, j \rangle\}$ encodes the information that the context might be c or e and that the index might be i or j . On top of this, it encodes dependencies between these two types of information: in this case the information that c is the context if and only if i is the index.

We need this third type of information, because whether a sentence is supported depends partly on it. For instance, whether the sentence ‘I am in Paris’ is supported by information about the context and information about the index depends on how these types of information relate: it is supported if the referent of ‘I’ in the context is in Paris in the index. This kind of dependency can only be captured by sets of pairs, not by two independent sets of contexts and indices, respectively.

In a sense, information about the context normally implies some information about the index: namely, we know that if the actual context is c , then the actual index must be i_c (that index such that all parameters of the index are the same as in c). If an information state reflects this dependency, we call it a *diagonal* information state.

DEFINITION 2.3.3. Diagonal information state

A diagonal information state is any information state s such that for each $\langle c, i \rangle \in s$, $i = i_c$.

The need for information states that are not diagonal may seem counterintuitive, but notice that standard two-dimensional semantics also evaluates sentences relative to pairs $\langle c, i \rangle$ where c and i do not belong together. This is required to evaluate modal claims: for instance, to confirm that it would have been possible for me to be somewhere else than where I am now, we need the existence of a pair $\langle c, i \rangle$ where w_c is the actual world and w_i a world where I am in a different place.

2.3.4 Semantics

Now that we refined the notion of information states, it is straightforward to give the support clauses for sentences in two-dimensional inquisitive semantics. Our language now combines all the symbols we have seen so far:

$$\varphi ::= R(t_1, \dots, t_n) \mid (t = t') \mid \perp \mid \varphi \wedge \varphi \mid \varphi \vee \varphi \mid \varphi \rightarrow \varphi \mid \exists x\varphi \mid \forall x\varphi \mid \Box\varphi \mid A\varphi$$

For the remainder of the thesis, we will be evaluating sentences in the models from Chapter 1. The definition is repeated here:

DEFINITION 2.3.4. Model

A model M is a structure $M = \langle C, J, W, D, P, I \rangle$ such that

- C is a non-empty set of contexts
- J is a non-empty set of indices
- W is a non-empty set of worlds

- D is a non-empty set of individuals
- P is a non-empty set of positions
- I is an interpretation function (assigns an intension to all relation symbols)

Sentences are evaluated relative to information states in these models: they are supported by those states that contain the information that the sentence conveys, and resolve the issue raised by the sentence. Terms are evaluated as in Section 1.2 and as before we write $[\alpha]_{cig}$ for the denotation of expression α with respect to context c , index i and assignment function g . We write $s \models_g \varphi$ to indicate that information state s supports φ under assignment function g .

- $s \models_g Qt_1 \dots t_n \iff$ for all $\langle c, i \rangle \in s : \langle [t_1]_{cig}, \dots, [t_n]_{cig} \rangle \in [Q]_{cig}$
- $s \models_g t = t' \iff$ for all $\langle c, i \rangle \in s : [t]_{cig} = [t']_{cig}$
- $s \models_g \perp \iff s = \emptyset$
- $s \models_g \varphi \wedge \psi \iff s \models_g \varphi$ and $s \models_g \psi$
- $s \models_g \varphi \vee \psi \iff s \models_g \varphi$ or $s \models_g \psi$
- $s \models_g \varphi \rightarrow \psi \iff$ for all $t \subseteq s : t \models_g \varphi$ implies $t \models_g \psi$
- $s \models_g \exists x \varphi \iff$ there is some $d \in D \cup P$ such that $s \models_{g_d^x} \varphi$
- $s \models_g \forall x \varphi \iff$ for all $d \in D \cup P : s \models_{g_d^x} \varphi$
- $s \models_g \square \varphi \iff$ for all $\langle c, i \rangle \in s : \{c\} \times J \models_g \varphi$
- $s \models_g A\varphi \iff \{\langle c, i_c \rangle \mid \langle c, i \rangle \in s\} \models_g \varphi$

We define negation, disjunction, existential quantification and the question mark operator as before:

$$\neg \varphi := \varphi \rightarrow \perp \quad \varphi \vee \psi := \neg(\neg \varphi \wedge \neg \psi) \quad \exists x \varphi := \neg \forall x \neg \varphi \quad ?\bar{x}\varphi := \forall \bar{x}(\varphi \vee \neg \varphi)$$

The clauses are the standard clauses for first-order inquisitive semantics, with two additions. First, the necessity operator \square checks for each context c compatible with s whether φ is supported by a state which specifies that the context is c , but that does not specify what the index of evaluation is. Note that this is equivalent to the requirement that for every set of indices K , the information state $\{c\} \times K$ supports the sentence. Second, the actuality operator from two-dimensional semantics is added, which now shifts evaluation to the index belonging to the context in each pair in s separately.

As an example, consider the question in (23).

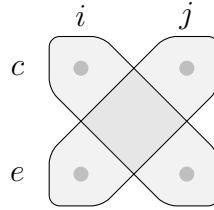

Figure 2.2: Alternatives of (23). Here, dots represent context-index pairs.

- (23) Is John here?
?Located(John, here)

Let p_c be Paris and p_e be Kiev, and let John be in Paris at i and in Kiev at j . Then (23) is supported by the states $\{\langle c, i \rangle, \langle e, j \rangle\}$ (where John is here), $\{\langle e, i \rangle, \langle c, j \rangle\}$ (where John is not here), and their subsets. See Figure 2.2 for a graphical representation.

Before we move on, let me introduce an extra notation convention that will make the presentation of examples easier. From now on, whenever I use variables in examples, I will use the variables x and y for individuals and the variable z for positions. This means that, if v is a generic variable, $\forall z\varphi(z)$ can be read as shorthand for $\forall v(Pos(v) \rightarrow \varphi(v))$ and $\exists x\varphi(x)$ as shorthand for $\exists v(Ind(v) \wedge \varphi(v))$.⁸

2.3.5 Character, content and context-sensitivity

In Kaplan's terminology, the character of an expression captures how its content varies between contexts. However, our analysis of questions requires that we encode sentences not as sets of context-index pairs (functions from contexts to contents), but as sets of sets of context-index pairs, which cannot be understood as functions. This raises the issue what the content and character of questions are.

I will distinguish two kinds of characters: *functional* and *inquisitive*. The former is the character of a sentence in the Kaplanian sense: a function from contexts to inquisitive propositions. The latter is the set of information states that support a sentence:

DEFINITION 2.3.5. Inquisitive character of a sentence

If φ is a sentence, its inquisitive character $[\varphi]$ is defined as follows:

$$[\varphi] = \{s \mid s \models \varphi\}$$

⁸See p. 14 for the definitions of *Pos* and *Ind*.

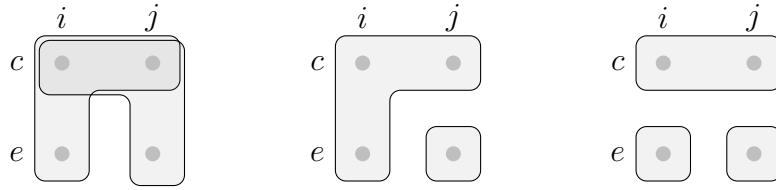

Figure 2.3: Three questions with different inquisitive characters, but the same functional character: given a context (row), they each express the same inquisitive proposition.

Although $[\varphi]$ is the most general meaning component of φ , it cannot be viewed as its character in Kaplan's terms, since it is not a function. However, it does determine a functional character. If we restrict an inquisitive character to a single context, we obtain a standard inquisitive proposition (a set of sets of indices). So we can define functional character as follows:⁹

DEFINITION 2.3.6. Functional character of a sentence

The functional character of φ is a function from contexts to inquisitive propositions, defined as follows:

$$\text{character}(\varphi)(c) = \{\text{indices}(s) \mid s \in [\varphi] \text{ and } \text{contexts}(s) = \{c\}\}$$

Functional characters do encode how the support conditions of a sentence vary per context, but fail to encode what information about the context is required to resolve a question. This shows that the meaning of a question can be richer than its functional character. For an illustration, see Figure 2.3.

When we consider only statements, inquisitive characters are not richer than functional characters. That is, given the functional character of a statement, we can determine its inquisitive character.

FACT 2.3.1. Statements determined by functional character

If φ is a statement, then $[\varphi] = \wp(\{\langle c, i \rangle \mid \{i\} \in \text{character}(\varphi)(c)\})$.

As an example of a question meaning that cannot be captured by its functional character alone, consider (24):

- (24) Who am I?
 $?x(x = I)$

The functional character of (24) is a function that, given a context c , which provides a referent for 'I', returns the trivial inquisitive proposition (the powerset

⁹Where $\text{indices}(s) = \{i \mid \langle c, i \rangle \in s\}$, similar for contexts.

of the set of all indices). But the question itself is not trivial.

Based on the distinction between inquisitive character and functional character, we can now distinguish two kinds of context-sensitivity. A sentence is strongly context-sensitive if the inquisitive proposition it expresses varies per context:

DEFINITION 2.3.7. Strong context-sensitivity

A sentence φ is strongly context-sensitive just in case $\text{character}(\varphi)$, viewed as a function from contexts to sets of sets of indices, is not a constant function.

The notion of strong context-sensitivity corresponds to the standard notion of context-sensitivity of expressions (see Fact 1.4.1). However, a sentence can also be context-sensitive in a weak sense, namely if information about the context may be required to determine how it is resolved. This is the case if at least one of its alternatives is itself context-sensitive in the standard sense. The following definition relies on the fact that an information state s (a set of context-index pairs) can also be viewed as a function from contexts to sets of indices, namely that function f such that $f(c) = \{i \mid \langle c, i \rangle \in s\}$.

DEFINITION 2.3.8. Weak context-sensitivity

A sentence φ is weakly context-sensitive just in case $\text{alt}(\varphi)$, viewed as a set of functions from contexts to sets of indices, contains a non-constant function.¹⁰

An example of a weakly context-sensitive question is again (24): the inquisitive proposition it expresses is the same in all contexts, but information about the context is required to resolve it.

The distinction between strong and weak context-sensitivity is unique to questions. By contrast, a statement is weakly context-sensitive just in case it is strongly context-sensitive.

2.3.6 Consequence and equivalence

So far we have talked about information states as objects that sentences are evaluated against. But we can also think of individuals (or groups of individuals) as possessing certain information about the context and/or index. If we do so, we should conclude that the information state of an individual is always a diagonal one, since it can be known a priori that the actual index is the index that corre-

¹⁰As noted in footnote 6 on p. 30, strictly speaking there exist sentences that have no alternatives. The definition can be made more general as follows: a sentence φ is weakly context-sensitive just in case there is some $s \in [\varphi]$ that, viewed as a function from contexts to sets of indices, is non-constant, and there is no constant $t \in [\varphi]$ such that $t \supset s$.

sponds to the context. Therefore we can assume that the effect of an utterance of a sentence, in terms of an update of beliefs or a conversational common ground as in Stalnaker (1978), is completely determined by the diagonal information states that support the sentence. The other information states that support the sentence only come into play whenever a sentence is embedded under a modal operator.

In this light, it makes sense to distinguish two consequence relations: a *general* consequence relation, which is based on preservation of support in all information states of the model, and a *diagonal* consequence relation, which only looks at diagonal information states.¹¹

DEFINITION 2.3.9. General consequence
 $\varphi \models_{\mathbf{g}} \psi$ iff for all models M and information states s :
 if $M, s \models \varphi$ then $M, s \models \psi$.

The general consequence relation does not satisfy $A\varphi \models \varphi$, because there are information states that support $A\varphi$ but not φ . However, we can normally infer φ from $A\varphi$ because these non-diagonal information states can already be excluded. For this reason, diagonal consequence is a more natural consequence relation:

DEFINITION 2.3.10. Diagonal consequence
 $\varphi \models_{\mathbf{d}} \psi$ iff for all models M and diagonal information states s :
 if $M, s \models \varphi$ then $M, s \models \psi$.

In the diagonal consequence relation, the actuality operator only plays a role when it occurs in the scope of a necessity operator, because this operator is the only one that involves checking in non-diagonal information states.

These two notions of consequence come with their corresponding notions of equivalence. The latter is more restricted than the former: two sentences are generally equivalent if they are supported by the same information states, and diagonally equivalent if they are supported by the same diagonal information states. For example, $A\varphi$ is not generally equivalent to φ , but they are diagonally equivalent. This means that the difference in semantic value only becomes apparent when they appear in a modal context. We can think of diagonally equivalent sentences as having the same update conditions but possibly different modal properties. For instance, $p \rightarrow p$ and $Ap \rightarrow p$ both have trivial update conditions, but the former is necessary, while the latter is not.

¹¹Crossley & Humberstone (1977) distinguish these consequence relations on the level of context-index pairs. Here, their definitions are generalized to sets of such pairs. The diagonal consequence relation is referred to as *real-world consequence* on the level of pairs.

2.3.7 Statements

The treatment of statements in two-dimensional inquisitive semantics is completely classical. This means that the set of information states that support a statement is completely determined by the set of context-index pairs that make it true in classical two-dimensional semantics. We have the following fact:

FACT 2.3.2. Declaratives are truth-conditional
 For all \forall - and \exists -free formulas φ :

$$s \models_g \varphi \iff \text{for all } \langle c, i \rangle \in s : \langle c, i \rangle \models_g \varphi$$

The relation on the right is the classical satisfaction relation in terms of truth. It follows from this result that entailment between statements (whether general or diagonal), is also conservative with respect to classical two-dimensional semantics.

2.3.8 Indexical-free sentences

The treatment of indexical-free sentences corresponds to their treatment in standard inquisitive semantics. That is, we could formulate their semantics without reference to the context element of information states. The following fact can be shown by a straightforward induction on indexical-free formulas:

FACT 2.3.3. Indexical-free formulas are context-insensitive
 For all formulas φ :

If φ is *A*-, *I*-, *you*- and *here*-free, then φ is context-insensitive.

Note that the other direction of the implication does not hold because of sentences like '*I* = *I*', in which indexicals are only used redundantly. It follows from Fact 2.3.3 that entailment between indexical-free sentences corresponds to standard entailment in inquisitive semantics.

2.3.9 Apriority and necessity of questions

We can now generalize the original definitions of necessity and apriority, which were given in terms of truth, to ones given in terms of support:

DEFINITION 2.3.11. Necessity and apriority
 φ is *necessarily supported* in c iff for all sets of indices K , $\{c\} \times K \models \varphi$
 φ is *a priori supported* iff for all diagonal information states s , $s \models \varphi$

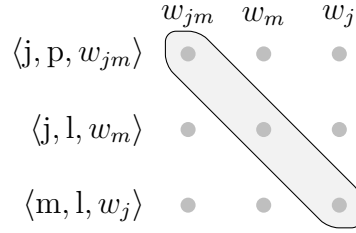

Figure 2.4: Minimally informative diagonal information state of M . To maintain readability, only three contexts and three indices are shown here. Dots represent context-index pairs consisting of the context on the left and the index above.

A sentence is necessarily supported in a context c if whatever it expresses is already supported by any information state in which this context is fixed. A sentence is a priori supported if any diagonal information state supports it – even the one that only encodes that the index of evaluation is the index determined by the context. Note that the sentences in this definition can be questions as well as statements. An intuitive understanding of the generalized notion of apriority as used in this thesis is the following: we call a sentence a priori if it neither *provides* nor *requests* any information about what the world is like.

Based on the generalized notions of necessity and apriority above, we can also formulate uniform definitions of contingency and aposteriority:

DEFINITION 2.3.12. Contingency and aposteriority
 φ is *contingent* in c iff $?\varphi$ is not necessary in c .
 φ is *a posteriori* iff $?\varphi$ is not a priori.

2.3.10 Applications

Let us now return to the example questions from the Section 2.1, to see how they are treated formally. To keep things simple, we evaluate them in a model M with only two individuals, John and Mary, and two positions, Paris and London. We assume for now that indices are just worlds. Let w_{jm} be the world in which both John and Mary are in Paris, w_m the world in which Mary is in Paris and John is in London, etc. The minimally informative diagonal information state (the information state consisting of all context-index pairs $\langle c, i \rangle$ such that $i = w_c$) is depicted in Figure 2.4.

The reason that (25) (depicted in Figure 2.5(a)) comes out as a priori on this account is that any diagonal information state supports it: the information that the index of evaluation is whatever the world in the context is, is already enough to settle this question positively. This can be seen by the fact that the area marked in Figure 2.4 is contained in one of the marked areas in Figure 2.5(a).

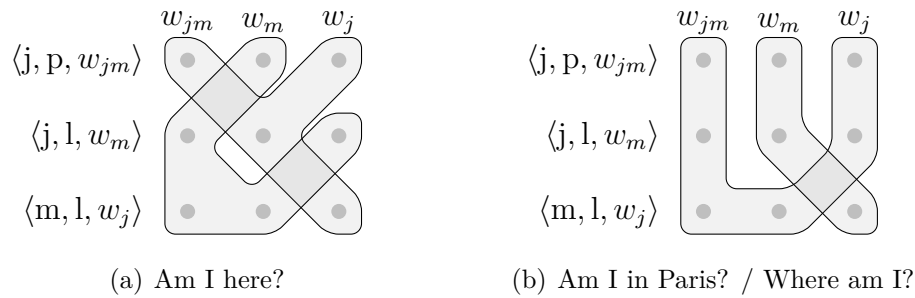

Figure 2.5

- (25) Am I here?
?Located(I, here)

The non-diagonal information states that support (25) become relevant when this question is embedded. For instance, the fact that the rows are split up into parts encodes that the question is contingent in all contexts.

Compare this to (26) (depicted in Figure 2.5(b)), which is a posteriori:

- (26) Am I in Paris?
?Located(I, Paris)

There are pairs $\langle c, w_c \rangle$ such that at w_c , a_c is in Paris, but also pairs in which the speaker is somewhere else.

Let us now look at (27), which is a necessarily supported question.

- (27) Who am I?
?x(x = I)

This is the case in any context c , because whoever the speaker a_c is, he or she will be self-identical in all indices. To resolve the question, only information about the context is needed, which can be seen in Figure 2.6(a): the question splits the matrix horizontally. This makes the question weakly context-sensitive.

By contrast, (28) is contingent in any context c , because the state $\{c\} \times J$ is compatible with more than one position for a_c . In Figure 2.5(b) it can be seen that the question splits each individual row into two areas.¹²

- (28) Where am I?
?zLocated(I, z)

Let us also look at an example of a question that does not contain indexicals, namely (29).

¹²‘Am I in Paris?’ and ‘Where am I?’ come out as equivalent here, but this is just because there are only two possible positions in this model.

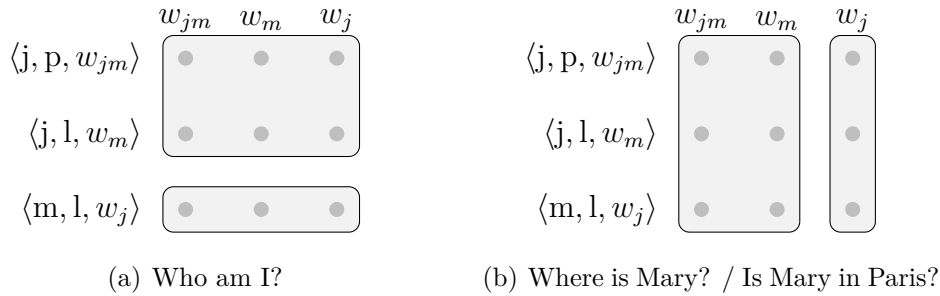

Figure 2.6

- (29) Where is Mary?
 $?z \text{Located}(\text{Mary}, z)$

It can be seen in Figure 2.6(b) that such a question splits the matrix vertically, showing that it is neither strongly nor weakly context-sensitive. This is, however, on the assumption that the referent of ‘Mary’ is known to everyone, which means no contexts are considered in which this name refers to other individuals than Mary. Following Haas-Spohn (1995), we can capture situations in which this is not the case by letting the referent of ‘Mary’ vary per context, thereby giving an analysis of (30) that is not trivial, but splits the matrix into rows in the same way (27) does.

- (30) Who is Mary?
 $?x(x = \text{Mary})$

Before we continue, let me briefly summarize the achievements of this section. We have given a semantics that is both inquisitive and two-dimensional, in which information states encode information about the context and the index. We have seen that sentences express inquisitive characters which, in the case of questions, are objects that are richer than just functional characters. Inquisitive characters are sets of information states, which encode support conditions. In this way, questions can be about what the index is like, but also about what the context is like. We formulated uniform definitions of necessity and apriority, in terms of support rather than truth, that apply to both questions and statements. The actuality operator provides a mechanism to shift the evaluation of an expression to the actual world – I will say more about applications of this operator in questions in Section 2.5.

Let us now move on to the second group of frameworks for question semantics, which analyzes questions as relations.

2.4 Questions as relations over worlds

The second group of approaches to question semantics can be described as having a two-dimensional nature, in the sense that double indexing is used to define question meanings. Such an account is proposed by Groenendijk & Stokhof (1984); Lewis (1982); Groenendijk (2009); Mascarenhas (2009); Aloni et al. (2013) and others. Just like in the semantics we looked at in Section 1.2, sentences are evaluated relative to two points: here, an actual world and a world of evaluation. While the truth value of a statement depends only on the world of evaluation, the truth value of a question also depends on its answer in the actual world. In general, a question is evaluated as true relative to two worlds if the worlds agree on its answer. Or, in other words: the content of a question is its true answer in the actual world. In the spirit of this tradition, we could extend the semantics in Section 1.2 with the following clause for polar questions:¹³

$$c, i \models ?\varphi \iff c, i \models \varphi \text{ if and only if } c, i_c \models \varphi$$

This means that $?\varphi$ is already definable in two-dimensional semantics as presented in Section 1.2, namely as $\varphi \leftrightarrow A\varphi$.

The set of pairs relative to which the question is true can be viewed as a relation between worlds that holds whenever they agree on its answer. This relation is often called the intension of the question. In the theory of Groenendijk & Stokhof (1984), this relation is an equivalence relation, which induces a partition on the logical space. However, this is only the case if questions have exactly one true answer in a world, which not all authors assume. The relation can be viewed as a relation of indifference: if a question, expressed as a relation, connects two worlds, then the difference between those two worlds is inessential to resolve the question (Groenendijk, 2009; Mascarenhas, 2009). To keep the discussion general, I will not assume any constraints on the relation here. This means that whatever is said in this section applies not only to the partition theory of questions, but to all relational accounts.

2.4.1 Question operator in two-dimensional semantics

In the literature on relational question semantics, several different notations for questions are considered. To ease comparison with the semantics in Section 2.3, let us extend the language of two-dimensional semantics from Chapter 1 with the following question mark operator:

$$c, i \models_g ?\bar{x}\varphi \iff \text{for all } \bar{d} \in D \cup P : c, i \models_{g\bar{d}} \varphi \text{ if and only if } c, i_c \models_{g\bar{d}} \varphi$$

¹³I present this clause in terms of a context and index purely for uniformity of presentation. Usually, this clause is presented in terms of worlds.

This operator is all we need to analyze the questions from the examples in the previous section. However, we find that this operator is also already definable, namely as follows: $?x\varphi := \forall \bar{x}(\varphi \leftrightarrow A\varphi)$.¹⁴ So it seems that questions can already be represented in the two-dimensional semantics we encountered in Chapter 1.

However, adopting such a representation of questions causes two problems. Firstly, it is not compatible with how apriority is normally defined (Definition 1.4.1). Consider a question φ that has a true answer in every world. Then for any context c , the true answer to φ in w_c must be true in w_c itself, so we obtain $c, i_c \models \varphi$. This means that φ is a priori. But all polar questions and non-presuppositional readings of *wh*-questions have a true answer in every world. So all of these questions would be predicted to be a priori, even a question like ‘is it raining?’, contrary to intuitions. The problem is that the content of a question φ in a context c is not the question φ itself, but the true answer to φ in c . So we are really checking whether ‘the true answer to φ is true’ is a priori, and this obviously is the case.

The second problem is that the context c now plays a double role: it determines the referents of indexical expressions, and it determines the world against which we evaluate questions. This is problematic in the case of questions embedded under intensional predicates like *wonder*: such predicates are not sensitive to the true answers to a question, so they embed a question intension rather than its extension, as in (31):

(31) John wonders whether I am hungry.

Here, *wonder* must embed the question intension of ‘whether I am hungry’, which is a set of context-index pairs, but it needs a single context to fix the referent of ‘I’. This second problem shows that contexts cannot play this double role.

2.4.2 Three-dimensional semantics

The problem with contexts playing a double role (being the source for true answers as well as referents for indexicals) can be solved by adding a separate index for the evaluation of questions on top of the context and index of evaluation we already had, thereby making the semantics three-dimensional. We adapt our semantic clauses in such a way that we evaluate sentences relative to three elements: as before we have a context c and an evaluation index i , but we introduce a third parameter j , which is the index that determines the true answer to questions.

¹⁴In fact, inquisitive disjunction and inquisitive existential quantification are also definable, namely as:

- $\varphi \vee \psi := (\varphi \wedge A\varphi) \vee (\psi \wedge A\psi)$
- $\exists x\varphi := \exists x(\varphi \wedge A\varphi)$

We let all clauses be insensitive to the third parameter j , except the following:

$$c, i, j \models_g ?\bar{x}\varphi \iff \text{for all } \bar{d} \in D \cup P : c, i, j \models_{g\bar{d}} \varphi \text{ if and only if } c, j, j \models_{g\bar{d}} \varphi$$

We can then view sentence meanings as functions from an actual world j to a character (a set of context-index pairs). Statements are constant functions, while questions are not.

This solves the second problem, but not the first: we cannot say that a priori sentences are the ones that are true relative to c, i_c, j_c for any context c , because this is still the case for *all* questions that have a true answer in every world. So just like standard two-dimensional semantics, three-dimensional semantics does not make it possible to define a notion of apriority that applies to questions.

2.4.3 Layered two-dimensional semantics

A possible solution is to separate the two kinds of two-dimensionalism into layers. That is, question meanings should not be relations between indices, but between context-index pairs. As we have seen in Section 2.3, questions can be about what the context and/or index is like. This means we should encode to what extent a question requests information about both the context and the index.

Sentences should be evaluated relative to two parameters, which are both a context-index pair. We have a context c and an index i , and we introduce a context-index pair parameter $\langle e, j \rangle$, which determines the true answer to questions. Again we let all clauses be insensitive to this extra parameter, except the following:

$$\langle c, i \rangle, \langle e, j \rangle \models_g ?\bar{x}\varphi \iff \text{for all } \bar{d} \in D \cup P : \\ \langle c, i \rangle, \langle e, j \rangle \models_{g\bar{d}} \varphi \text{ if and only if } \langle e, j \rangle, \langle e, j \rangle \models_{g\bar{d}} \varphi$$

Consider again examples (25) and (26), repeated here.

(25) Am I here?
?Located(I, here)

(26) Am I in Paris?
?Located(I, Paris)

The question in (26) is a relation that holds between two context-index pairs just in case they agree on whether the referent of ‘I’ in the context is in Paris in the index.

To check whether a sentence is a priori, we can again look at pairs $\langle c, i \rangle$ such that $i = i_c$. The question in (25) will connect any two such pairs, since in any $\langle c, i_c \rangle$, the referent of ‘I’ will be at the referent of ‘here’, so any such pair agrees with any other such pair. We can thus give the following uniform definition of apriority:

DEFINITION 2.4.1. Apriority
 φ is a priori iff for every two contexts c, e : $\langle c, i_c \rangle, \langle e, i_e \rangle \models \varphi$

This definition checks whether φ already follows from simply establishing that the index corresponds to the context. Similarly, the definition of necessity checks whether φ can be established without knowing what the index is, while keeping the context fixed.

DEFINITION 2.4.2. Necessity
 φ is necessary in c iff for every two indices i, j : $\langle c, i \rangle, \langle c, j \rangle \models \varphi$

We have thus obtained a semantics that is two-dimensional in two ways: sentences are evaluated with respect to a pair of context-index pairs. The top layer of two-dimensionality is required for the meaning of questions, while the bottom layer is required for the meaning of indexicals. The meaning of a sentence is encoded as a set of pairs of context-index pairs. Such a set can also be viewed as a function that takes a context-index pair and returns a set of context-index pairs. This function is constant in the case of statements, and variable in the case of questions.

The definitions of character, content and (weak and strong) context-sensitivity can be given in a way analogous to the inquisitive variant in Section 2.3.5. It is easy to show that, when we limit ourselves to the questions in the examples in Section 2.3.9, this semantics gives the same results (we can interpret the figures with the convention that areas in the diagram group together those pairs that are related to each other by the indifference relation). I will not go over this in detail, but instead move on to compare the two approaches.

2.4.4 Comparison with two-dimensional inquisitive semantics

Although both approaches seem to be adequate implementations of two-dimensionality in their respective frameworks for question semantics, it is useful to point out that there is an essential difference between the two.

First, note that there is no conceptual difference between the respective definitions of apriority and necessity: in general, a sentence is a priori if support is already guaranteed by the information that the world of evaluation is the world from the context, and it is necessary in a context c if support is already guaranteed by the information that the context is c . The only difference is the way this evaluation takes place. This is because the two systems inherit an important difference between their one-dimensional base systems, namely their conception of issues.

In inquisitive semantics, an issue is encoded as a set of states (which in turn are sets of indices), namely those states in which the issue is resolved. In a relational semantics, an issue is a relation between indices that encodes indifference. In the

latter approach, an issue is resolved in any state that only contains indices such that any two of them are related to each other by this indifference relation.

As is shown in Ciardelli & Roelofsen (2011), the latter approach suffers from an important limitation: it cannot deal with certain mention-some questions and disjunctive questions with three or more disjuncts. Consider the following example, taken from Ciardelli et al. (2019, p. 181):

(32) Where can one buy an Italian newspaper?

And suppose the possible indices are the following:

- i_1 : Italian newspapers are only sold at the Central Station and the zoo.
- i_2 : Italian newspapers are only sold at the airport and the zoo.
- i_3 : Italian newspapers are only sold at the Central Station and the airport.

In this example, (32) can be resolved in three minimally informative ways: by finding out that Italian newspapers are sold at Central Station (the actual index is i_1 or i_3), at the zoo (i_1 or i_2) or at the airport (i_2 or i_3). In a relational semantics, every index would be related to every index, so the question would be trivial (see Figure 2.7 for a graphical representation).

Since this difference is already present at the one-dimensional level, the issue is orthogonal to the topic of this thesis, especially since we will not encounter any examples that crucially involve mention-some questions or alternative questions.¹⁵

We can conclude that, regardless of what our favorite method for capturing the meaning of questions is, we have to add a two-dimensional layer if we want to also capture indexicality and apriority – it is by no means the case that we are immediately done when we choose a relational semantics for questions. Since the implementation of two-dimensionality in inquisitive semantics presented in Section 2.3 is strictly more general than layered two-dimensional semantics, I will work with this framework for the remainder of this thesis, but it is easy to see how the results generalize to relational semantics.

2.5 Actuality in questions

Now that we have the formal framework in place, we can have another look at the actuality operator. As shown in Chapter 1, the actuality operator in two-dimensional semantics can be used to shift the evaluation of an expression from the world of evaluation to the actual world. In a two-dimensional question semantics, such an operator can be used in questions as well. This section explores some

¹⁵But, as mentioned in Section 2.3.1, this is only because the examples we are after in this thesis are of a specific nature.

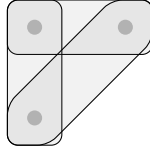

Figure 2.7: Example of an issue that can be captured by inquisitive semantics, but not by a relational question semantics. In this issue, every index is related to every index, so according to a relational question semantics, the issue would be trivial.

applications of this operator. Although what is said here carries over to layered two-dimensional semantics, I will assume we are working with two-dimensional inquisitive semantics here.

First, observe that (33) has a reading that is not contradictory:

(33) John doesn't know which students are students.

The non-contradictory reading of (33) is true if there is some student x such that John does not know that x is a student. If we assume that no movement takes place, this means that the seemingly trivial question in (34) cannot be completely trivial.

(34) Which students are students?

Standard inquisitive semantics is compatible with several analyses of questions of the form of (35). Two options are (36a) and (36b).

(35) Which P are Q ?

- (36) a. $\forall x?(Px \wedge Qx)$
 b. $\forall x(Px \rightarrow ?Qx)$

Reading (36a) corresponds to the *de dicto* reading proposed by Groenendijk & Stokhof (1984), and is supported by states that specify for each individual whether she has both properties P and Q or not. Reading (36b), proposed by Velissarotou (2000), is less demanding: it is supported by a state if it specifies for each individual whether she has property Q on the assumption that she has property P . However, both of these analyses are distinct from the most salient reading of the embedded question in (33). The analysis in (36a) makes it equivalent to 'who are the students?', while (36b) renders the question trivial, and thereby makes (33) a contradiction.

In a two-dimensional question semantics, it becomes possible to refine these readings by applying the actuality operator. This operator can be used in either of the readings to evaluate the first property in the actual world:

(37) a. $\forall x?(APx \wedge Qx)$

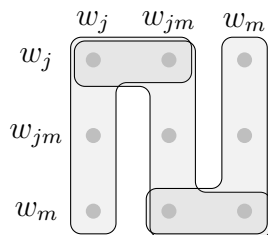

Figure 2.8: Analysis of ‘which students are students?’, formalized as in (37b). Subscripts of worlds indicate the students in that world.

$$\text{b. } \forall x(APx \rightarrow ?Qx)$$

The readings (37a) and (37b) are diagonally equivalent to (36a) and (36b) respectively, which corresponds to the observation that an ambiguity only comes about under the scope of a modal operator as in (33). These questions are supported by information states that specify which of the individuals who are students in the actual world are students. This is something that John can fail to know, in which case (33) is true. See Figure 2.8 for a graphical representation of (37b).¹⁶

I do not intend to settle the debate about how to analyze *wh*-questions here, but it seems that the most natural reading of *wh*-questions is one where the restrictor is interpreted relative to the actual world (following Karttunen, 1977), which can be achieved using the actuality operator. Consider the following two claims:

- (38) a. It is necessary which students are students.
 b. It is a priori which students are students.

Intuitively, (38a) is false (some students could not have been students), while (38b) is true. This is predicted only by (37b): under (36a) and (37a), both claims are false while under reading (36b) both are true.¹⁷

The combination of two-dimensional semantics and inquisitive semantics can capture such observations. However, a full analysis of *wh*-questions also takes into account presuppositions (see e.g. Rullmann & Beck, 1998) and is outside the scope of this thesis. There is more to say about questions embedded under attitude verbs in relation to indexicality. I will return to this topic in Chapter 4.

¹⁶Note that $\neg K\forall x(ASx \rightarrow ?Sx)$ can be translated without the actuality operator as $\neg\forall x(Sx \rightarrow K?Sx)$, which is equivalent (according to the analysis of *know* that will be developed in Chapter 4). It is not so clear how the latter translation would be derived compositionally, especially since it requires movement outside of a question. However, in general, what can be done using an actuality operator can also be done using movement (see Von Stechow & Heim, 2011, Chapter 8). Which method is syntactically more plausible is an open question.

¹⁷The claim that (33) and (38b) can both be true may seem odd, because one would expect all a priori questions to be known. However, on the present interpretation of apriority, things are more subtle. I will discuss the relation between apriority and knowledge in Chapter 4, and return to these specific examples in Section 4.6.3.

2.6 Conclusion

We have enhanced a proposition-set framework for questions with two-dimensionality, which we need for an adequate treatment of indexicals in questions, resulting in two-dimensional inquisitive semantics. We have done this in such a way that it can capture the apriority and necessity of questions. We have seen that relational accounts of questions can also be extended to capture indexicals, and that we need a layered two-dimensional semantics to do so. This semantics is much like two-dimensional inquisitive semantics, but is built on a notion of issues that has certain limitations. We have also discussed some linguistic applications for the actuality operator in questions.

The predictions this system makes about the apriority of questions are adequate for the examples discussed in this chapter, but this does not extend to all questions. One example is the following:

(39) Who is who?

Questions like (39) are predicted to be a priori, because of the fact that no real information is needed to know that John is John, Mary is Mary, and so on. What makes this question non-trivial in reality is that we might be in a situation where this does not count as knowing who is who: for instance, we need to know whether John is the person on the left and Mary is the person on the right, or vice versa. Such cases can be accounted for by letting one of the instances of ‘who’ quantify not over the domain of individuals itself, but over a particular conceptualization of this domain. This requires a refinement of quantification that I will suggest in Chapter 3. This conceptualization of the domain can itself be indexical, which is a way in which questions and indexicality interact that the present chapter did not cover.

Another extension of two-dimensional inquisitive semantics is required to give an account of questions embedded under attitude predicates. This will be the focus of Chapter 4.

Finally, while in the present system, claims about necessity can be expressed in the object language using the \Box operator, no such operator has been added for apriority here. However, if we are interested in studying the logic of necessity, apriority and actuality, we can add such an operator to the language, as Fritz (2014) does for non-inquisitive two-dimensional semantics. This task is taken up in Chapter 5.

3.

Questions
with indexical
resolution
conditions

Chapter 2 introduced a combination of inquisitive semantics and two-dimensional semantics that can capture indexicality, actuality, apriority and necessity of questions. In the present chapter I will develop a refinement for this system, which is primarily motivated by questions that have indexical resolutions.

In the system as defined in the previous chapter, all quantification is relative to the domain of individuals and positions. As a result, *wh*-questions are always about individuals (or positions), and are resolved by the information that says which individual (or position) has a certain property.

However, this wrongly presupposes that resolution conditions never depend on how the domain of individuals is conceptualized. For instance, we might identify individuals by their position in the room, by their role in the team or by their social security number. There are good reasons to suppose that *wh*-questions quantify over these conceptualizations rather than over the individuals directly.

As we will see in this chapter, there are cases in which resolution conditions of questions are indexical, and this can be traced back to the indexicality of the conceptualization of the domain of individuals.

3.1 Motivation

In Section 2.3, questions are analyzed as requests for information. Information can be about the context, the index, or about the relation between context and index. We have seen that there exist weakly context-sensitive questions, which require information about the context to be resolved, like (1).

- (1) Who am I?

I will argue that there are also questions (not necessarily containing indexicals) that require a different kind of indexical information. Three examples will be discussed in the following subsections.

3.1.1 Example 1: exchanging cards

Hearts is a card game played with four players. After the cards are dealt, there is an exchanging round. Each player chooses three cards (typically bad ones), and passes them to one of the other players. Passing is rotated through four deals: on the first deal, players pass to the left, on the second deal to the right, on the third diagonally across the table. On the fourth deal no cards are passed, and this cycle is then repeated.

Suppose that at the beginning of a deal, one of the players, Amelia, has forgotten in what stage of the cycle the players are at that moment. She holds up three of her cards and asks:

- (2) To whom do I pass these cards?

Amelia wants to know whether to pass the cards to ‘the person left from her’, ‘the person right from her’, or ‘the person across from her’ (if we ignore the presupposition of the question, keeping them is also one of the possibilities).

Amelia does not know who the other players are. This means that specifying to which *individual* the cards should be passed, for instance by giving a name, does not resolve the question. In that case, Amelia would first need to know where this person is sitting. So the person has to be identified by their position relative to Amelia.

Suppose further that Amelia is an amnesiac who has somehow forgotten who she is. In this case, the individual to whom she passes her cards can not be identified by their position relative to Amelia – because Amelia does not know that she is Amelia. Instead, any information that resolves the question has to be of an indexical nature: Amelia needs to know where the individual is sitting relative to *herself*, the speaker in the present context, whoever that may be.

3.1.2 Example 2: the lost guide

Alex and Jim are hiking in a foreign country, and they hired a guide to show them the way. At some point during their hike, the two friends realize that they haven’t seen the guide in a while. Alex asks Jim:

(3) Where is the guide?

Alex asks this question, because he wants to know the position of the guide relative to their current position. For instance, if the guide went ahead of them, they have to walk faster in order to keep up with him, but if he is behind them, they can wait for him or walk back. Information about the absolute position of the guide (for instance his GPS coordinates) is not useful to Alex, since he does not know what his own position is in this absolute way.

Now suppose that Alex is also an amnesiac – he has forgotten who he is and who Jim is, and for all he knows, they might be two different individuals. In that case, the position of the guide relative to the position of Alex and Jim does not resolve his question. Instead, the position has to be given relative to *there*, the position in which the utterance of the question has taken place.

3.1.3 Example 3: time to leave

A third example, which I want to mention only briefly but is perhaps even more natural, involves time. Elaine and George are chatting and drinking in a bar, and they have dinner plans with friends later. George has just finished his drink, and is wondering whether there is enough time to order another one before they need to leave. He asks Elaine:

(4) When do we need to leave?

The question in (4) can be answered by giving an absolute time, like six o'clock. But George does not know the current time, so what he really needs is a relative answer like 'in ten minutes (from now)', which is indexical.¹

3.1.4 Indexical resolutions and essential indexicality

All three examples rely on there being two ways to identify individuals, positions and times: an absolute and a relative way. The resolution conditions of the question therefore depend on the way the domain is conceptualized. Furthermore, it seems that the information required to resolve the questions is indexical in an essential way: resolutions are required to contain a reference to the *actual* speaker, position or time.

In a way, these observations are similar to the observation of Perry (1979) that the cognitive significance of some beliefs cannot be analyzed without indexicals. In Perry's example, the protagonist comes to realize he is accidentally making a mess in the supermarket because there is a torn sack of sugar in his shopping cart. At some point he comes to believe that 'I am making a mess', which explains his behavior of rearranging the groceries in his cart, while 'the shopper with the torn sack is making a mess' or even 'Perry is making a mess' cannot explain this behavior.

However, there are also differences between Perry's *essential indexical* and our examples here. Perry's example was used as a motivation for accounts of so-called *de se* belief reports (e.g. Lewis, 1979), which are sentences in which statements like 'I am making a mess' occur embedded. The examples in the present chapter are puzzles for the analysis of *unembedded* sentences.² Moreover, whereas Perry's example contains an indexical expression that cannot be paraphrased away, our examples concern questions which do not have to contain indexical expressions at all, as (3) from example 2 shows.³ This raises the question where this indexicality comes from.

Intuitively, it is the conceptualization of the domain of individuals that has this indexical nature. The idea that whenever we use a quantifier, we do not have a fixed domain of individuals in mind but some conceptualization of that domain, has already been proposed by Aloni (2001). According to Aloni, there is a contextually salient domain of individual concepts that together form a *conceptual cover* of the domain of individuals, and each quantifier can range over a different conceptual cover.

This refinement of quantification can be applied to two-dimensional inquisitive

¹Since we decided in Chapter 1 to set aside everything that involves time, I will not work out this example in detail and only mention it as a motivation. Note that it is logically the same as the other ones.

²An account of *de se* attitudes towards questions will be given in Chapter 4.

³Furthermore, the indexicals in (2) and (4) *can* be paraphrased away without changing the indexical resolution conditions of the question.

semantics, which is what we will develop in Section 3.2. However, we will see that the problem of questions with indexical resolutions cannot be dealt with by a combination of question semantics and conceptual covers as normally conceived. We will need another refinement, which will be formulated in Section 3.3.

3.2 Integrating conceptual covers

I will build on the combination of two-dimensional semantics and conceptual covers developed in Aloni (2016). Let me first indicate how this system differs from the two-dimensional semantics in Chapter 1, setting questions aside for a bit.

The crucial ingredient of this approach is the definition of conceptual covers. Conceptual covers are sets of individual concepts that cover the domain of individuals in a specific way: for every index and every individual, they contain one unique individual concept.

DEFINITION 3.2.1. Conceptual cover

Given a set of indices J and a domain E , a conceptual cover CC is a set of functions $J \rightarrow E$ such that:⁴

$$\forall i \in J : \forall d \in E : \exists! h \in CC : h(i) = d$$

As an example, let our domain consist of two individuals, John and Paul. One of them is a singer and the other plays guitar. One of them is standing on the left, the other on the right. Conceptual covers could then be:

- {left, right}
- {singer, guitarist}
- {John, Paul}

The set {left, singer} is not a conceptual cover, because there is an index in which the person on the left is the singer. Both concepts select the same individual in that index, and therefore do not form a cover. Note that there is always exactly one conceptual cover consisting only of rigid designators, one for each individual in the domain. I will refer to this as the *rigid cover*.

Quantifiers do not quantify over individuals in the domain directly, but rather over concepts in a conceptual cover. In this way, knowing who John is can mean

⁴Note that our domain $E = D \cup P$ where D is the domain of individuals and P the domain of positions. I assume that each concept in a conceptual cover maps indices either exclusively to individuals or exclusively to positions. In this way, we can think of a conceptual cover CC as consisting of two parts, one for the individuals and one for the positions.

knowing whether it is the man on the left or on the right, or knowing whether it is the singer or the guitarist.

We introduce a third evaluation point, distinct from the context and index, that determines which variable ranges over which conceptual cover. This is a function from CC -indices to conceptual covers called the *perspective*:

DEFINITION 3.2.2. Perspective

Given a set of conceptual covers \mathcal{C} and a set of CC -indices N , a perspective π is a function such that $\forall n \in N : \pi(n) \in \mathcal{C}$.

Variables are indexed to indicate which conceptual cover they use relative to the perspective. The assignment function g no longer maps variables directly to members of the domain. It is now a function that takes a perspective π and returns a function (notation g_π) that maps each variable x_n to an individual concept in the conceptual cover π_n . The assignment function $g[\pi, x_n/d]$ is just like g , except that g_π now maps x_n to d (where d is a concept in π_n).

We adapt the interpretation of variables, now subscripted to indicate which conceptual cover they range over:⁵

$$[x_n]_{\pi c i g} = g_\pi(x_n)(i)$$

Note that $[x_n]_{\pi c i g}$ is not an individual concept, but still an individual. However, its value is now assigned in a different way: first, π determines the conceptual cover π_n that x_n ranges over, and then g_π maps x_n to an individual concept in π_n . Finally, the index serves as an input to this individual concept and we obtain an individual.

We adapt the clause for universal quantification in the following way, making explicit how quantification is relative to the conceptual cover π_n :

$$\pi, c, i \models_g \forall x_n \varphi \iff \text{for all } d \in \pi_n : \pi, c, i \models_{g[\pi, x_n/d]} \varphi$$

The other clauses on p. 14 remain insensitive to the perspective.

Aloni (2016) not only interprets variables relative to the perspective, but also indexicals like ‘I’ and ‘you’. The effect of this is that although ‘I’ still refers to the speaker of the context, it does not do so *rigidly*. This is motivated by descriptive uses of indexicals, as in the following example:⁶

- (5) Why did you open the door without checking? You should be more careful!
I could have been a burglar.

In the indices under consideration here, ‘I’ does not refer to the speaker of (5) but instead to the person at the door in that index.

⁵The subscripts c and i still refer to the context and index, respectively. See p. 14.

⁶This kind of use of indexicals was first mentioned in Nunberg (1993). The example is from Hans Kamp, reported in Maier (2009).

One effect of the non-rigidity of indexicals is that it blocks the inference from ‘I am John’ to ‘necessarily I am John’ – although this inference still holds under any perspective in which ‘I’ is interpreted rigidly. For the purposes of this chapter, we do not need indexicals to be non-rigid, therefore I will leave them unindexed and assume that they behave rigidly. However, our system is compatible with this account of descriptive uses of indexicals.

3.2.1 Level of perspective and context

The next step is to integrate quantification under conceptual covers into the two-dimensional inquisitive semantics from Section 2.3. As before, we need to lift the semantics from evaluation relative to single instances of parameters to sets of them.

In Section 2.3.2, we observed that there are two ways to add a context parameter to inquisitive semantics: evaluate sentences relative to pairs $\langle c, s \rangle$ where s is a set of indices, or relative to sets of context-index pairs $\langle c, i \rangle$. In the present case, there are again two possible generalizations, so a similar question arises: do we evaluate relative to a pair $\langle \pi, s \rangle$ where s is a set of context-index pairs, or relative to an information state which is a set of triples $\langle \pi, c, i \rangle$? Before answering this new question, let us take a step back and reconsider our answer to the first question.

Context and set of indices vs. set of context-index pairs

In the previous chapter, we dismissed the option of evaluating sentences relative to a context and a set of indices. One of the arguments against that approach was that the following sentences are not a priori, but would be predicted to be a priori on such an account:

- (6) a. Where am I?
b. Who am I?

To be a priori, a sentence has to be supported given any context c and a state s_c that is ‘consistent enough’ with c . That means at least that in all indices in s_c , the speaker of c is at the position of c .

It follows that the indices in s_c cannot vary in terms of the position and speaker. As a consequence, the questions in (6) are trivial with respect to that information state. Therefore we dismissed this approach, and chose the more general option to evaluate relative to information states which are sets of context-index pairs.

However, this original problem disappears when *wh*-questions quantify over conceptual covers rather than the domain of individuals. The reason for this is that even though the position and speaker are fixed in s_c , it is not guaranteed that we have a conceptual cover that has a constant function from all indices in

s_c to this position or individual as its member.

Take (6a) as an example. Take any context c that fixes the speaker and position. Then take any s_c in which, at least, the speaker of c is at the position of c . That means that s_c fixes a particular position, for instance a particular latitude and longitude. If quantifiers would quantify over positions directly, then we would have to conclude that (6a) is a priori. However, now we can simply take a perspective π with only a single conceptual cover, which contains only non-rigid concepts. For instance, the concept ‘Paris’, which can be at different coordinates in different indices. Then there will be no concept that points all indices in s_c to the same coordinates. So our information state s_c is not informative enough to support the question. This is not because the information does not fix a position, but because there may be no concept available to capture this position in that information state.

So the questions in (6) are all non-trivial, even if a context (and thus a position and speaker) is already fixed. In that case, the questions are not after a position or individual, but after suitable concepts to identify them. Since our original argument for the more general set-up relied on these examples, the question arises whether we still need information states as context-index pairs in a set-up with conceptual covers.

However, there are still good reasons to continue working with the more general set-up. Firstly, it is not clear that questions like (6) are really a posteriori because we might lack suitable concepts to identify individuals and positions. This is most clear with individuals, as we can see from the following example.

- (7) a. Who am I?
b. I am John.

Intuitively, the information in (7b) should count as resolving the question in (7a) in a non-trivial way. However, if sentences are evaluated relative to a single context and a set of indices (and indexicals and proper names are rigid) then this is not possible. Given a context c , the individual to whom ‘I’ refers is given (it is a_c). So (7a) can only be non-trivial when interpreted under a conceptual cover that is about a certain property of individuals (e.g. being on the left or right). If ‘John’ is rigid, then (7b) expresses the trivial proposition. So that doesn’t provide any information that can count as resolving the question. In the more general set-up, the question ‘who am I?’ can also be non-trivial if it is really a question about the context (‘who is asking himself this question?’). Then ‘I am John’ can be informative, because it excludes the contexts in which the speaker is not John.

A second motivation for keeping the more general set-up can be found in sentences with an actuality operator. To check whether a sentence is a priori, we look in any context c and a corresponding state s_c . If s_c is defined based on just the speaker and position of c , then the facts of the world in c don’t matter, and there is no relation between the world of utterance and the world of evaluation. In

that case, questions like ‘Which actual students are students?’ are not predicted to be a priori. On the other hand, if we do take into account the world, then s_c is always the singleton set $\{i_c\}$, and all questions are predicted to be a priori. Neither of the two options are satisfactory.

Perspective and set of pairs vs. set of perspective-context-index triples

Having established that we still need to evaluate sentences relative to information states that consist of context-index pairs, we can continue with the second question: is the perspective one of the parameters against which we evaluate sentences, just like information states, or should information states be sets of triples of the form $\langle \pi, c, i \rangle$?

Here too, the second option is strictly more general than the first. It allows for cases where the question is really *about the perspective*, rather than just determined by it. However, as far as I am aware there are no questions that put the conceptual cover itself at issue. This contrasts with contexts, about which we can ask questions: for instance, I can wonder who I am, where I am or what time it is. This means I will assume that the first option will be general enough.

3.2.2 First proposal

We are now ready to develop a first proposal: a straightforward combination of two-dimensional inquisitive semantics and conceptual covers. We will evaluate sentences relative to an information state (set of context-index pairs) and a single perspective. This perspective only has an effect on the clauses for existential and universal quantification:

- $\pi, s \models_g \exists x_n \varphi \iff$ there is some $d \in \pi_n$ such that $\pi, s \models_{g[\pi, x_n/d]} \varphi$
- $\pi, s \models_g \forall x_n \varphi \iff$ for all $d \in \pi_n$: $\pi, s \models_{g[\pi, x_n/d]} \varphi$

As before, classical existential quantification (\exists) is defined in terms of universal quantification and negation.

The definitions of necessity and apriority now need to be relativized to the perspective:

DEFINITION 3.2.3. Necessity and apriority
 φ is *necessarily supported* under perspective π in context c iff for all sets of indices K : $\pi, \{c\} \times K \models \varphi$
 φ is *a priori supported* under perspective π iff for all diagonal information states s : $\pi, s \models \varphi$

That is, whether a sentence is a priori now depends on the perspective chosen, and whether a sentence is necessary depends both on the perspective and the

context. For instance, (8) is a posteriori under the rigid cover:

(8) Who is the man on the left?

However, under the cover $\{\text{left, right}\}$, this question is a priori.

3.2.3 Applications

Let us look at some applications to see what the introduction of conceptual covers means for the apriority and necessity of sentences, and what the limits of the present system are. The refinement does not affect examples without quantification like ‘I am here now’, so we only need to consider *wh*-questions.⁷

The main effect is that identity questions are no longer always necessary. An example of this is (9):

(9) Who am I?
 $?x_n(x_n = I)$

Under the rigid cover, (9) is analyzed as ‘which individual am I?’, which mimics our original analysis in Chapter 2. But it can also mean ‘am I on the left or on the right?’ under a suitable perspective. Under this perspective the question is contingent, unlike in the original analysis. It remains a posteriori even under a rigid cover, since we might not know who is speaking.

The same thing happens to (10).

(10) Who is John?
 $?x_n(x_n = \text{John})$

As we have seen in the previous chapter, (10) can be a posteriori if the referent of ‘John’ varies between contexts, reflecting that language users might not have full knowledge of the referent of a proper name, even though the name refers rigidly in counterfactual situations. But if we assume that language users are fully aware of the referent of ‘John’, and thus that its referent is fixed across the model, then (10) would come out as a priori.

This is no longer the case in the refined system. Even if ‘John’ refers to the same individual in all contexts, (10) can still be a posteriori. Of course, there still exists a perspective π that makes π_n a cover consisting of only rigid designators. But there are also perspectives in which this is not the case. For instance, we could ask (10) in a room full of masked people. It is then neither necessary nor a priori which of the masks John hides behind.

⁷The examples in this chapter follow the notation conventions from Chapter 2: x and y are used as variables for individuals, z as a variable for positions. See p. 36.

Who is who?

More interesting cases are questions in which more than one instance of quantification occurs, like (11).

- (11) Who is who?
 $?x_n, y_m(x_n = y_m)$

In a system without conceptual covers, (11) would come out as necessary a priori. It is resolved by pieces of information that indicate which individuals are identical to which. Since any individual is identical to herself, any information state resolves the question. However, the most salient reading is not trivial.

In the system with covers, (11) comes out as a posteriori under perspectives that let both variables range over different conceptual covers. For instance, {singer, guitarist} and {John, Paul}, respectively. In that case, the question is resolved by establishing who of John and Paul is the guitarist, and who is the singer, which is not something that can be settled a priori.

When we ask under what perspectives (11) is necessary, we run into a limitation of the present system. Namely, it can only be necessary if each instance of quantification ranges over a different conceptual cover, which means that one of them has to be non-rigid. So it turns out that (11) is necessary *just in case* it is a priori.

However, there is also a necessary a posteriori interpretation of (11). Consider a scenario in which two amnesiacs, Rudolph Lingens and Adolf Dingens, try to find out who they are.⁸ In this scenario, Lingens might ask Dingens ‘Who is who?’, thereby intending to ask something like ‘Am I Lingens and are you Dingens, or are you Lingens and am I Dingens?’. This necessary a posteriori reading is impossible to get in the present system, since it requires the two rigid covers {I, you} and {Lingens, Dingens}, and, as we have seen, it follows from the definition of conceptual covers that there is exactly one rigid cover.

What this shows is that, although we obtained some desirable results with the present combination of two-dimensional inquisitive semantics and conceptual covers, we need another refinement. In the next section I will propose such a refinement, and show that we can use it not only for necessary a posteriori interpretations of identity questions, but also for the questions with indexical resolutions we saw in Section 3.1.

⁸Rudolph Lingens and Adolf Dingens are two amnesiacs lost in a library in an example scenario from Lewis (1979), who adapted the example from Perry (1977). We will meet Lingens again in Chapter 4.

3.3 Refinement: indexical conceptual covers

The refinement of conceptual covers I propose to account for questions with indexical resolutions, as well as necessary a posteriori interpretations of identity questions, is the following revision of Definition 3.2.1:

DEFINITION 3.3.1. Conceptual cover (revised)

Given a set of contexts C , a set of indices J and a domain E , a conceptual cover CC is a set of functions $(C \times J) \rightarrow D$ such that:

$$\forall \langle c, i \rangle \in C \times J : \forall d \in E : \exists! h \in CC : h(c, i) = d$$

Instead of a function from indices to individuals, each concept in a conceptual cover will be a function from context-index pairs to individuals. In this way, we can allow a broader range of concepts. These can be purely indexical concepts that map context-index pairs directly to a parameter of the context, like ‘I’ and ‘you’, but also concepts that depend on both the context and the index, like ‘the person to the left of me’. The referent of variables x_n will be determined in the following way:

$$[x_n]_{\pi cig} = g_{\pi}(x_n)(c, i)$$

I will illustrate the workings of this new notion of conceptual cover using the examples of questions with indexical resolutions.

3.3.1 Example 1: exchanging cards

To simplify presentation, I modify the card game example a bit: instead of four players, let there be only three players a , b and c , which have to pass their cards to the left (l), to the right (r), or keep them (k). Since there are only three individuals, there are only two distinct ways in which they can sit at the table, (clockwise) a - b - c and a - c - b . This means we can distinguish six indices. Let us first consider a non-indexical variant of the question:

- (12) To whom does a pass their cards?
 $?x_n Pass(a, x_n)$

We can now distinguish an absolute and a relative reading for this question. Under a cover with rigid designators, (12) has alternatives that correspond to the three individuals a , b and c . This is the absolute reading of the question, shown in Figure 3.1(a), which is resolved by the information to which *individual* a should pass her cards. The relative reading we are after can be obtained under the cover {left of a , right of a , keep (a)}. The result is shown in Figure 3.1(b).

These results can equally well be obtained with both the old version of conceptual covers and the new one. But now, let us move on to the indexical example.

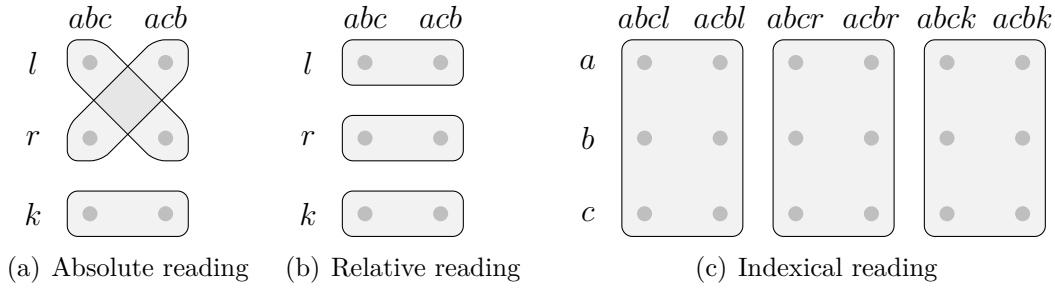

Figure 3.1: Absolute, relative and indexical readings of (13). In (a) and (b), points represent indices and contexts are suppressed. In (c), points represent context-index pairs.

(13) To whom do I pass my cards?
 $?x_n Pass(I, x_n)$

This example shows that the original notion of conceptual covers is too limited. In the previous example, we relied on a cover relative to a : the concept ‘left’ maps each index to the person sitting left of a in that index, similar for ‘right’, and the ‘self’ concept maps each index to a . Of course, these conceptual covers exist also for b and c – these would be similar but slightly different. But none of these conceptual covers is general enough to get the right results for the indexical example. What we need is a concept ‘left’ which is the person left of *the speaker*, similar for ‘right’, and the concept ‘self’ which is always the speaker.

With the revised definition of conceptual covers, we can define the cover we want (I replace the name of the context by the speaker in that context. i_{abcl} is the index where the order is a - b - c and they pass to the left. i_{abc*} can refer to i_{abcl} , i_{abcr} or i_{abck}):

$$\text{left} = \left\{ \begin{array}{l} a, i_{abc*} \mapsto b \\ a, i_{acb*} \mapsto c \\ b, i_{abc*} \mapsto c \\ b, i_{acb*} \mapsto a \\ c, i_{abc*} \mapsto a \\ c, i_{acb*} \mapsto b \end{array} \right\}, \text{right} = \left\{ \begin{array}{l} a, i_{abc*} \mapsto c \\ a, i_{acb*} \mapsto b \\ b, i_{abc*} \mapsto a \\ b, i_{acb*} \mapsto c \\ c, i_{abc*} \mapsto b \\ c, i_{acb*} \mapsto a \end{array} \right\}, \text{self} = \left\{ \begin{array}{l} a, i_{abc*} \mapsto a \\ a, i_{acb*} \mapsto a \\ b, i_{abc*} \mapsto b \\ b, i_{acb*} \mapsto b \\ c, i_{abc*} \mapsto c \\ c, i_{acb*} \mapsto c \end{array} \right\}$$

Under this conceptual cover, the resolution conditions of the question are as displayed in Figure 3.1(c). The three alternatives correspond to ‘pass to the person on my left’, ‘pass to the person on my right’, and ‘keep the cards’, as we wanted.

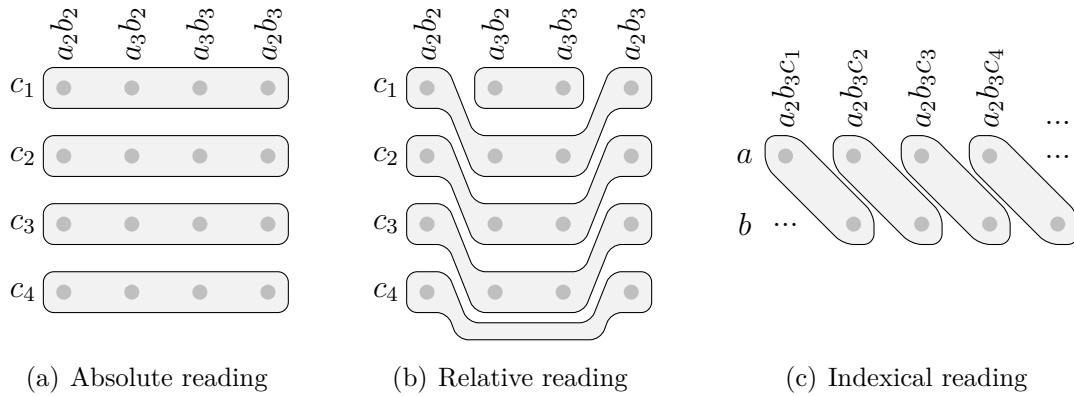

Figure 3.2: Absolute, relative and indexical readings of (14). In (a) and (b), points represent indices and contexts are suppressed. In (c), points represent context-index pairs.

3.3.2 Example 2: the lost guide

The second example can be captured in a similar way, by making the conceptual cover depend on the actual position in the context.

Let there be three individuals, a , b and c , the latter being the guide. Let their possible positions be numbers on a path (1 to 4). We assume that a and b are either at position 2 or 3, but make no such assumption about c . We distinguish 16 indices corresponding to the combinations of positions and name them accordingly, e.g. index $a_2b_3c_1$ is the index in which a is at position 2, b at 3 and c at 1. The question that we want to capture is the following:

- (14) Where is the guide?
 $?z_n \text{Located}(c, z_n)$

The absolute reading, based on rigid covers, is displayed in Figure 3.2(a). This question is resolved by information about the exact position of c . For the relative reading, the challenge is to come up with a suitable conceptual cover. Let us first give the cover for the reading relative to a . We define the conceptual cover $\{\dots, -1, 0, +1, \dots\}$, where each number represents a function that is an operation on the position of a in the input index. For instance, the function -1 would, given an index in which a 's position is 2, return position 1. This gives us the reading relative to a , displayed in Figure 3.2(b).

For the indexical variant we need to rely again on the fact that conceptual covers can be sensitive to the context. We let $\{\dots, -1, 0, +1, \dots\}$ consist of functions that operate on the position of the context. The alternatives of the question then become $\{2 \text{ behind us}, 1 \text{ behind us}, \text{here}, 1 \text{ in front of us}, 2 \text{ in front of us}\}$, as can be seen in Figure 3.2(c).

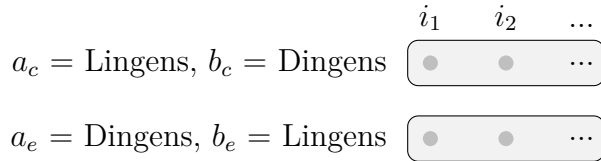

Figure 3.3: Necessary a posteriori reading of (11).

3.3.3 Other applications

In the refined system, the examples discussed before obtain new readings. Since conceptual covers now depend on the context, elements provided by the context such as the speaker and the addressee become concepts that can be quantified over. For instance, the concept ‘the speaker’ is the constant function that, given a context-index pair, returns the speaker of that context. This means that there is a reading in which (10) quantifies over individuals made available by the context (the speaker, the addressee, and perhaps others).

- (10) Who is John?
 $?x_n(x_n = \text{John})$

Answers like ‘I am John’ are thereby accounted for, if the perspective allows it. Of course, contexts should provide not only a speaker and an addressee but more concepts, in case the domain of individuals is larger, otherwise we do not have a full cover of the domain.

Finally, the refined system also makes available a necessary a posteriori reading of (11), in which one of the *wh*-words quantifies over indexicals and the other over names.

- (11) Who is who?
 $?x_n, y_m(x_n = y_m)$

An answer to such a question could be ‘I am Lingens and you are Dingens’. The resolution conditions of this question depend completely on the context, it does not require any information about the index (see Figure 3.3). The crucial part of the solution is that there is no longer a single rigid cover: the covers {I, you} and {Lingens, Dingens} are both rigid, but distinct.⁹

This means that we can give a meaningful analysis of this reading of (11) without giving up the rigidity of indexicals, the rigidity of names or necessity of identity.

⁹With the revised definition, there is one unique *absolute* cover: the set of constant functions from context-index pairs to individuals.

3.4 Conclusion

We have seen that conceptual covers can be indexical in nature, which makes the resolution conditions of questions indexical without the question itself necessarily containing any indexical expressions. To capture this, we need the concepts of our conceptual covers to be sensitive not only to the index, but also to the context.

The question how contexts and perspectives conceptually relate to each other is one of the questions left open in Aloni (2016). I cannot completely resolve this here, but our examples involving questions have at least shown the following: the perspective is not a parameter of the context, since the context can vary per resolving state, while the perspective remains fixed. Moreover, the fact that concepts have to be sensitive also to the context shows that the perspective precedes the context: to fully grasp a question, we don't need to know what the context is like, but we do need to know the perspective.

There remain some open problems, which raise the question whether the generalization we made here is general enough. Firstly, questions with indexical resolutions also occur in attitude ascriptions.

(15) Amelia wonders to whom she should pass the cards (relative to herself).

In a relative reading, the conceptual cover that the question quantifies over is one that is not relative to the speaker, but to the attitude holder – in this case, Amelia. However, presumably the attitude verb does not shift the context, since a 'relative to the speaker' reading is also still available. Perhaps this means that concepts in a conceptual cover need an extra parameter for the 'center' of the attitude.

A second problem arises when the question occurs under quantification. Suppose that there is a version of the game in which not all players pass the cards in the same direction. We could then ask the following question.

(16) To whom does everyone pass the cards?
 $?x_n, y_m Pass(x_n, y_m)$

The formal translation of (16) given here is a pair-list reading of the question, which can be answered by a list of pairs such as 'Jake to himself', 'Henry to his left', 'Amelia to her right'. These concepts are not anchored to an attitude holder or the context, but depend on the referent of x_n . So it seems that we need an even further generalization to capture this kind of examples. Perhaps this calls for a system in which conceptual covers can depend on a 'perspectival center' which is optionally influenced by attitude verbs or quantification.

Another open problem concerns the basic assumptions of conceptual covers: by definition, each cover consists of the same amount of concepts as there are individuals in the domain. This means that the model already assumes that everyone is aware of how many individuals there are. This may be problematic

for ‘how many’-questions and cases of double vision: for instance, if I am unaware that Hesperus and Phosphorus are the same heavenly body, then I must also be unaware of how many heavenly bodies there are (see also Quine, 1956).

I consider these last two issues (conceptual covers relative to quantifiers and questions about cardinality) to be outside the scope of this thesis and leave them as open questions. The first issue (conceptual covers relative to attitude holders) will be addressed in Chapter 4.

4.

Question-
directed attitudes,
indexicality
and *de se*

The previous chapters have developed a semantic framework that can account for questions and indexicality. So far, its scope has been restricted to unembedded sentences and sentences embedded under necessity modals. In this chapter I will extend the semantics from the previous chapters to account for sentences that contain attitude ascriptions.

4.1 Motivation

There are several good reasons to investigate attitude ascriptions in relation to questions and indexicality.

Firstly, while existing literature on two-dimensional semantics focuses on attitude predicates that embed declarative complements, there are several attitude predicates that embed interrogative complements too. Examples are *know*, *remember*, *forget* and *agree (about)*. These predicates are called *responsive* (Lahiri, 2002). There is also a class of *rogative* predicates that exclusively embed interrogative complements, such as *wonder*, *ask* and *inquire*. Of course, indexicals and proper names can also occur in questions when they are embedded under these responsive and rogative predicates, as the following examples illustrate.

- (1) a. John knows where I am.
b. John wonders whether Hesperus is Phosphorus.

Having developed a semantics that can account for these questions in the previous chapters, these examples raise the question whether this can be extended to embedded environments.

A second reason to look at attitude ascriptions can be found in so-called *de se* attitude ascriptions. In a classic example due to Perry (1977), Rudolph Lingens is an amnesiac lost in the Stanford library, who reads a complete biography about Rudolph Lingens and thereby learns all there is to know about him (including the fact that he is lost in the Stanford library), but does not realize that the book he is reading is about himself. Now consider the following two sentences.

- (2) a. Lingens believes that he is in the Stanford library.
b. Lingens believes that Lingens is in the Stanford library.

According to Perry, (2a) has a reading that is false in this situation, and only becomes true once Lingens realizes that the book he was reading was about himself. By contrast, (2b) does not have such a reading – it is true immediately after reading the book. What makes *de se* attitudes such as the one in (2a) special is that we can only describe it by reference to this ‘self’, which can be viewed as an indexical: Lingens must realize ‘*I* am in the Stanford library’, before (2a) can be true.

A similar observation can be made with question-directed attitudes. It is easy

to imagine that in Perry's story, Lingens would like to know what his position is. Given this assumption, there is a contrast between (3a) and (3b).

- (3) a. Lingens wonders where he is.
 b. Lingens wonders where Lingens is.

The difference is that (3a) has a reading that can be described as Lingens wondering 'where am I?'. Under this *de se* reading, (3a) is true. By contrast, (3b) does not have such a reading, which makes it false relative to this story – Lingens knows where Lingens is because he read the book. Although several accounts of *de se* attitudes exist (see e.g. Lewis, 1979; Perry, 1979; Stalnaker, 1981; Chierchia, 1989), they only account for attitudes towards declarative complements, not interrogatives.

A third reason for discussing attitude ascriptions was given in Chapter 3. As we have seen, there can be interactions between conceptual covers and contexts under attitude ascriptions:

- (4) Lingens wonders to whom he should pass the cards.

In (4), Lingens may wonder to whom he should pass the cards relative to the speaker of the utterance context, but under a more plausible reading he wonders to whom he should pass the cards relative to *himself*. In that case, the conceptual cover that is active is not relative to the context of utterance of the matrix sentence, but rather to Lingens' attitude. This means that attitude ascriptions require another revision of the notion of conceptual cover developed in the previous chapter.

This chapter is set up as follows. I will first describe how the traditional treatment of propositional attitudes can be generalized to questions. In Sections 4.3 to 4.5, I will examine different accounts of attitude ascriptions in two-dimensional semantics. I will then develop a new proposal in Section 4.6.

4.2 Question-directed attitudes

Before we get into indexicals, let us first look at how question-directed attitudes in general should be analyzed.

4.2.1 Traditional treatment of propositional attitudes

Traditionally, attitude ascriptions are analyzed as relations between an individual and some set of indices (Hintikka, 1969). For every attitude predicate and individual, the model includes a function that maps each index to a set of indices, those that are compatible with the individual's attitude at this particular index. For predicates like *know* and *believe*, this function maps each index to that set of

indices that represents the information state of the individual at that index.¹

DEFINITION 4.2.1. Information state of individual

The information state of individual a at index i (notation $\sigma_a(i)$) is a set of indices.

The clauses that attitude predicates embed are analyzed as propositions:

- (5) John knows that it is raining.

According to this analysis, (5) is true in i just in case the set of indices that represent John's information state in i consists only of indices in which the proposition expressed by 'it is raining' is true. Thus, in the traditional view, the semantic value of embedded clauses and the objects that attitudes are about are both propositions.

4.2.2 Analyses of question-directed attitudes

When it comes to responsive predicates, some authors maintain the view that attitude verbs express relations between individuals and propositions (Karttunen, 1977; Groenendijk & Stokhof, 1984; Spector & Egré, 2015, see Uegaki, 2019 for an overview). Consider the following example.

- (6) John knows whether it is raining.

Although it is not a statement but a question that is embedded in (6), the propositional view can be maintained by arguing that *know* in (6) represents a relation between John's information state and the proposition expressed by an answer to the question 'is it raining?'. In Groenendijk & Stokhof (1984) and Karttunen (1977), it is the complete true answer to the embedded question, while according to Spector & Egré (2015), the sentence is already true if John's information confirms *some* complete answer.

The literature on inquisitive semantics argues that this propositional view should be abandoned in favor of an analysis in which proposition sets (more specifically, inquisitive propositions) are central. I will follow this view, and summarize the arguments given in Ciardelli & Roelofsen (2018); Theiler et al. (2018); Ciardelli et al. (2019).

Firstly, the propositional view is challenged by mention-some questions:

- (7) John knows where to buy an Italian newspaper.

¹A difference between *know* and *believe* is that the former presupposes that any statement it embeds is true, which can be captured by demanding any i to be a member of $\sigma_a(i)$. I will bypass the differences between *know* and *believe* in this chapter.

Intuitively, (7) is true if John knows at least one place that sells Italian newspapers. The problem for the propositional view is that there is no *single* proposition that John needs to know for the whole sentence to be true: instead, there are several propositions, corresponding to different newspaper sellers, that each suffice. The theory of Spector & Egré (2015) is compatible with questions like these, but those of Karttunen (1977) and Groenendijk & Stokhof (1984) are not.

A second argument in favor of a proposition-set account is the fact that the truth of (7) depends not only on John knowing a true answer to the embedded question, but also on John not believing any false answers to it (George, 2011). To make the semantics of *know* sensitive to false answers to embedded questions, the question as a whole should be considered, not just its true answers. Since this issue is orthogonal to context-sensitivity I will not pursue such an account here, but see Theiler et al. (2018).

Third and finally, there are also verbs like the rogative *wonder*, which are not only about the information that the subject has:

(8) John wonders whether it is raining.

The problem for all propositional accounts is that (8) cannot be understood as expressing a relation between John's information state and an (inquisitive) proposition. Instead, we need to consider not just the information that John has, but also the issues that he has.²

4.2.3 Treatment in inquisitive semantics

I will follow Ciardelli & Roelofsen (2018); Theiler et al. (2018); Ciardelli et al. (2019); Theiler et al. (2019) in modeling all attitude predicates as embedding inquisitive propositions. This strategy provides us with a uniform account of responsive predicates like *know* since, as we have already seen, inquisitive propositions are suitable semantic values for declarative sentences as well.³

Our model will equip individuals not just with an information state in each index, but also with an inquisitive state: a downward closed set of information states in which all of their issues are resolved.

²Other examples of predicates that describe a relation between an individual and an issue are so-called predicates of relevance like *care*, *matter* and *be relevant*. I will not discuss these here, but see Elliott et al. (2017).

³The view that all attitude predicates embed inquisitive propositions is seemingly at odds with the observation that not all attitude predicates embed both declarative and interrogative complements. However, semantic explanations for the selectional restrictions of some attitude predicates have been proposed. See e.g. Ciardelli & Roelofsen (2015); Uegaki (2015) on why *wonder* embeds only interrogative complements, Theiler et al. (2019); Mayr (2019) on why *believe* embeds only declaratives and Uegaki & Sudo (2019) on why this is also the case for preferential predicates like *hope* and *want*.

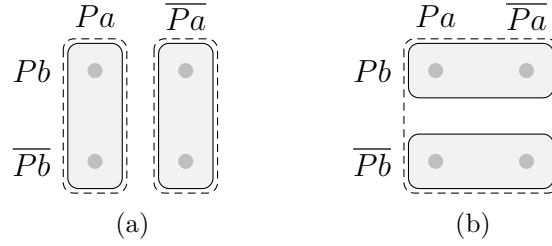

Figure 4.1: Example of inquisitive states and information states of individuals. Dotted lines show the information state in the indices within them, gray areas indicate the elements of the inquisitive state in those indices (only the maximal states are displayed). In (a), the individual knows whether Pa is true, and has no further non-trivial issues. In (b), the individual has no information as to whether Pa or Pb are true, and her issues are only resolved by finding out whether Pb is true.

DEFINITION 4.2.2. Inquisitive state of individual

The inquisitive state of individual a at index i (notation $\Sigma_a(i)$) is a non-empty, downward closed set of sets of indices.

The information state of an individual is related to her inquisitive state in a systematic way. On the one hand, it is assumed that all elements in her inquisitive state are at least as informative as her current information state. On the other hand, it must be possible to resolve the issues of an individual truthfully, so her information state should not contain indices that are not a member of some state in her inquisitive state. Thus, we arrive at the following definition of the information state of an individual:

DEFINITION 4.2.3. Information state of individual

The information state of individual a at index i (notation $\sigma_a(i)$) is a set of indices, defined as follows:

$$\sigma_a(i) = \bigcup \Sigma_a(i)$$

See Figure 4.1 for an illustration of inquisitive states and information states.

Ciardelli et al. (2019) define the following two clauses for *know* and *entertain*, respectively:

$$\begin{aligned} s \models K_a \varphi &\iff \text{for all } i \in s : \sigma_a(i) \models \varphi \\ s \models E_a \varphi &\iff \text{for all } i \in s, \text{ for all } t \in \Sigma_a(i) : t \models \varphi \end{aligned}$$

In words, ‘John knows φ ’ is true in an index, if John’s information state in that index supports φ . φ is entertained by John in an index if all information states in his inquisitive state in that index support φ . The semantics for *wonder* can then be given as a combination of not knowing and entertaining:

$$W_a\varphi := \neg K_a\varphi \wedge E_a\varphi$$

According to this analysis, (8) is true at an index i just in case John’s information state in i is not informative enough to resolve the question ‘is it raining?’, but all states that resolve John’s issues in i are.

Summing up, accounting for question-directed attitudes requires us to make two revisions to the traditional account of propositional attitudes. First, attitude predicates have to embed inquisitive propositions rather than classical propositions. Second, each individual should be equipped not just with an information state, but also with an inquisitive state, which indicates when her issues are resolved. The semantics of attitude predicates can then be given in terms of the relation between the inquisitive state of the individual and the inquisitive proposition that is expressed by the embedded clause.

In what follows we will see that, even when we set aside question-directed attitudes, the objects of attitudes already have to be richer than propositions to account for indexicality and *de se* reports. For now it suffices to see that whatever type of objects of attitudes we require for declarative attitudes, this type has to be lifted to sets of these objects in order to account for questions. In the next section, we will investigate what these objects of declarative attitudes could be.

4.3 Two-dimensional analyses of attitude predicates

We have seen that the traditional account of attitude ascriptions can be generalized to question-directed attitudes by letting the objects of attitudes be sets of propositions rather than single propositions. However, what are the objects of attitudes in two-dimensional semantics? And what do the information states of individuals encode?

Based on Chapter 2, we can distinguish two layers of meaning: inquisitive character and inquisitive proposition. These are generalizations of the classical character and proposition. So the question is, if we restrict ourselves to declarative sentences for now, do attitude predicates embed characters, propositions or something else? In fact, we can distinguish the following three options:

1. Attitude predicates embed propositions (or *objective* intensions). An embedded sentence is evaluated relative to a shifted index, but the context of utterance is never shifted (Kaplan, 1989).

2. Attitude predicates embed characters (or *subjective* intensions). An embedded sentence is evaluated relative to a shifted context, which has the role of both context and index. (Haas-Spohn, 1995; Jackson, 1998; Chalmers, 2002, 2004; Schlenker, 2011).
3. Attitude predicates embed properties (Lewis, 1979). To account for *de se* attitudes, we have to say that believing something amounts to the self-ascription of a property.

Let us discuss these three proposals in more detail.

4.3.1 Propositions

The goal of the first strategy is primarily to account for the behavior of indexical expressions. The referents of these expressions are given by the context of utterance. This does not change when they occur in an embedded environment, which means that the original context must still be available to supply these referents. Consider the example in (9).

(9) John knows that I am here now.

In (9), the indexical expressions ‘I’, ‘here’ and ‘now’ are still interpreted relative to the context of utterance. This suggests that attitude verbs just shift the index of evaluation, and leave the context alone. We arrive at the following entry for *know*:

$$c, i \models K_a^1 \varphi \iff \text{for all } i' \text{ in } a\text{'s information state in } i: c, i' \models \varphi$$

Although this account is a natural approach to indexicality, it has some disappointing consequences. First, given our assumptions in Chapter 1, it follows from this analysis that everything that is necessary is always known by every individual. For instance, it is necessary that Hesperus is Phosphorus because there are no indices in which Venus is not identical to itself. But then it follows from this fact alone that (10) is true:

(10) John knows that Hesperus is Phosphorus.

One of the important points of the two-dimensional analysis of unembedded sentences was to show that necessities can still be a posteriori.⁴

Second, under this analysis, (10) expresses a relation between John and a proposition. This means that the object of John’s attitude is an objective intension, while intuitively it should be a subjective intension, which is epistemic:

⁴The inference from $\Box\varphi$ to $K\varphi$ can be blocked using a non-global semantics of \Box with an accessibility relation, which effectively makes more things necessary. But that does not solve this particular problem.

it is the intension that encodes what the actual world might be like, not what counterfactual alternatives to the actual world are.

However, Kaplan claimed that nothing could shift the context of utterance, and called operators that would do so ‘monsters’. Later it was argued that there are monsters, in particular in relation to attitude ascriptions (Israel & Perry, 1996; Schlenker, 2003; Santorio, 2012; Rabern, 2013).

4.3.2 Characters

Compared to the first strategy, the second strategy has exactly the opposite advantages and disadvantages. The idea behind this approach is that the two-dimensional machinery we have put in place to distinguish apriority and necessity should also be used for attitudes. For instance, we have concluded that ‘I am here’ is a priori, thus in principle always known, while ‘Hesperus is Phosphorus’ is necessary, but we can be ignorant about it if we don’t know exactly what these names refer to in the context of utterance. To account for this, the objects of attitudes should not be construed as propositions, but as characters (Haas-Spohn, 1995; Jackson, 1998; Chalmers, 2002, 2004).

The information of an individual includes everything that is a priori, and should therefore be formalized as a diagonal information state. Necessary truths are not always known, so attitude predicates do not just shift the index, but also the context. The following analysis of *know* would then be natural:

$$c, i \models K_a^2 \varphi \iff \text{for all } \langle c', i' \rangle \text{ in } a\text{'s information state in } i: c', i' \models \varphi$$

Note that this analysis is not in the spirit of Kaplan, since it is a monster, but it is natural in an epistemic interpretation of two-dimensional semantics. With it, we can explain why (10), repeated here, is not trivially true.

(10) John knows that Hesperus is Phosphorus.

Since ‘Hesperus is Phosphorus’ is a posteriori, John’s information state may include context-index pairs in which Hesperus and Phosphorus refer to different things.

As expected, we lose the correct analysis of indexicals in embedded sentences that K^1 offered. This happens because the objects of belief are now subjective things, in which the agent of the context is always the attitude holder herself. Consider the sentence in (11a). How should this be formalized when embedded sentences are characters?

- (11) a. John knows that I am here now
 b. $K_j^2(\textit{Located}(I, \textit{here}))$
 c. John knows ‘I am here now’ (John knows that he is where he is)

It turns out that we cannot formalize (11a) as (11b), since this is now only a

correct formalization of (11c), which expresses something different and is trivially true.

4.3.3 Properties

The third analysis is developed without having indexicals in mind, and its single goal is to account for *de se* attitudes. The idea in Lewis (1979); Chierchia (1989) is that objects of belief in general must be properties, not propositions.

Indeed, if Lingens believes that Lingens is in the Stanford library, but also lacks the belief that he himself is in the Stanford library, then this shows that belief cannot be adequately captured by a relation between Lingens and a proposition.⁵ According to Lewis, the latter belief is not just a belief about what the world is like, but also about where to locate oneself.

What it really means for Lingens to believe that he himself is in the Stanford library is for him to *self-ascribe the property* of being in the Stanford library. If the objects of attitudes in general are properties rather than propositions, then an individual's information state is not a set of worlds, but rather a set of centered worlds (individual-world pairs).

Lewis (1979) does not consider utterance contexts, but the following version of *know* mimics his analysis in a two-dimensional setting.⁶ Let ρ be any expression that represents a property.

$$c, i \models K_a^3 \rho \iff \text{for all } \langle d, i' \rangle \text{ in } a\text{'s information state in } i: c, i' \models \rho(d)$$

For this analysis we have to assume that properties like 'being in the Stanford library' can be obtained using lambda-abstraction over a formula with a free variable, as in (12).⁷

$$(12) \quad \lambda x \text{Located}(x, \text{Stanford library})$$

In this way, the approach can also account for simple propositional attitudes: in these cases, we abstract over formulas without any free variables, as in (13).

$$(13) \quad \lambda x \text{Located}(\text{Lingens}, \text{Stanford library})$$

This means that K^3 is essentially an extension of K^1 . So although Lewis' approach does not mention indexicals, his analysis can in principle be extended to account for them.

⁵At least, not if we construe propositions as sets of possible worlds or indices, as I do in this thesis.

⁶Lewis also assumes that any individual inhabits only one possible world and that counterparts stand in for her at other worlds. I don't assume this here.

⁷An expression of the form $\lambda x \varphi(x)$ denotes a function that, given input x , returns the result of applying φ to x .

For now, what we can conclude from this brief look at the three different approaches of embedding declaratives is that each of the three obtains some desirable results: K^1 captures the behavior of indexicals, K^2 distinguishes apriority from necessity, and K^3 captures *de se* attitudes.

As for K^1 and K^2 , it is easy to imagine how they can be generalized to questions. We already encountered the ingredients for this generalization in Chapter 2, namely, the notions of inquisitive proposition and inquisitive character, which could replace propositions and characters, respectively, as the objects of attitude predicates.

As for K^3 , things are different: it is not immediately clear what a property-embedding account has to say about questions. Before we come back to inquisitive propositions and characters, let us first examine what a generalization of Lewis' account would be like, and what the limitations of such a generalization are.

4.4 Embedding properties

To account for *de se* attitudes, Lewis (1979) construes attitude verbs as relations between individuals and properties that hold whenever the individual self-ascribes the property. With declaratives, two different kinds of *de se* sentences can be distinguished:

- (14) Lingens believes he is in the Stanford library.
- (15) John decides to call back Bob.

Although a *de se* reading in sentences with an anaphor like (14) is only optional, it is generally assumed that for sentences like (15) only a *de se* reading is available. Such sentences contain a covert pronoun called *subject control PRO* which is obligatorily interpreted as the center of the attitude (Morgan, 1970; Chierchia, 1989). These sentences can be understood as Lingens self-ascribing the property of 'being in the Stanford library', and John deciding to have the property of 'going to call back Bob', respectively.

For both types of *de se* sentences, it is easy to construe examples where the embedded clause is not a statement but a question:

- (16) Lingens wonders where he is.
- (17) John decides who to call back.

These sentences have similar readings as their variants with declaratives: while (16) has both a *de re* and a *de se* reading, (17) can only be read *de se*. The *de se* reading of (16) is compatible with Lingens already knowing where *Lingens* is – his issue will only be resolved by finding out where he *himself* is. Similarly, (17) is compatible with John *not* deciding who *John* will call back – it is only false if he does not decide who he *himself* will call back.

Although these observations are similar to those Lewis made about declaratives, these cases cannot be captured in his semantics, because wondering where you are cannot be viewed as self-ascribing a property in the traditional sense. Things are similar for (17): there is no single property that John decides he has.

4.4.1 Inquisitive properties

A generalization of the notion of property can provide a solution that stays true to Lewis' idea. In the same way we call a function from individuals to propositions a classical property, we can call a function from individuals to *inquisitive* propositions an *inquisitive* property. This notion of property is used in compositional implementations of inquisitive semantics (Theiler, 2014; Ciardelli et al., 2017). Their motivation for the use of inquisitive properties is the behavior of quantifiers in questions.

DEFINITION 4.4.1. Inquisitive property
 An inquisitive property is a function from individuals to downward closed sets of sets of indices.

This leads to formalizations along the following lines, where we use lambda-abstraction over inquisitive propositions to form inquisitive properties:

(16') Lingens wonders $\lambda x?z Located(x, z)$

(17') John decides $\lambda x?y C(x, y)$

To see how an account based on inquisitive properties works, we also need to redefine inquisitive states – they need more structure to be able to encode attitudes about the self. Lewis construes the information state of an individual as a set of individual-world pairs, which is equivalent to a classical property (a function from individuals to sets of worlds). Analogously, we need to construe the inquisitive state of an individual as an inquisitive property too.

As an example, let us construe an inquisitive state for Lingens that would make (16) true. This is a function that, given any individual Lingens might be according to his information state, returns a set of information states that specify where this individual is. This inquisitive state is depicted in Figure 4.2. To provide a formal analysis of *wonder* in (16'), we also need to modify the definition of E from Section 4.2. Let ρ be any expression corresponding to an inquisitive property.

$$c, i \models E_a^3 \rho \iff \text{for all } d \in D, \text{ for all } t \in \Sigma_a(i)(d) : \{c\} \times t \models \rho(d)$$

In words: an individual a entertains the inquisitive property ρ if for all individuals d , on the assumption that she is d , the information states that resolve her issue



Figure 4.2: An example of an inquisitive state (as a function from individuals to inquisitive propositions) for Lingens that makes (16) true. That he wonders where he is means that if he is Lingens, he wonders where Lingens is and if he is Dingens, he wonders where Dingens is. The function returns the inconsistent inquisitive proposition on any individual Lingens thinks he isn't.

support $\rho(d)$.

As we have seen, *de re* beliefs can be captured as self-ascription of a property too, by abstracting over a formula without free variables. The same applies to question-directed *de re* attitudes:

- (18) Lingens wonders where Lingens is.
 $W_j \lambda x ?z \text{Located}(\text{Lingens}, z)$

An example of an inquisitive state that makes (18) true would be a constant function that takes any individual and returns only information states that specify where Lingens is. Note that the *de se* and *de re* readings of (16) and (18) are really distinct, and independent – neither of them entails the other.

4.4.2 Sets of properties

The analysis in terms of inquisitive properties is completely in the spirit of Lewis, and provides a simple solution to the problem of question-directed *de se* attitudes. However, this solution has an important shortcoming, which is very similar to an issue discussed already in Chapter 2. Consider the following example sentence, which we could imagine to be true in Lingens' situation:

- (19) Lingens wonders who he is.
 Lingens wonders $\lambda x ?y (y = x)$

As it turns out, the inquisitive property analysis predicts this sentence to be contradictory. This happens because the inquisitive property that Lingens self-ascribes here is a trivial one: it is a function from x to the question 'who x is', which is trivial because whatever the value of x is, she will be identical to herself.⁸

⁸As in Chapter 3, conceptual covers may be used to arrive at a non-trivial reading of this sentence. In such a case, the question 'who is x ?' would quantify not over the domain of individuals directly, but rather over a certain conceptualization of this domain. However, I

This means it is impossible to come up with an inquisitive state (as a function from individuals to inquisitive propositions) for Lingens that would make (19) true.

In Section 2.3.2, we encountered the same problem with the apriority of unembedded questions. When we briefly considered construing characters as functions from contexts to inquisitive propositions, this led to the triviality of questions such as ‘who am I?’. Given a single context, and thus a single referent for ‘I’, the inquisitive proposition cannot be non-trivial. There we concluded that, since questions can ask for information about the context, sentence meanings in general cannot be functions from contexts to inquisitive propositions. Instead, they must be sets of sets of context-index pairs. An analogous solution is required in the case of property-embedding. We would have to say that embedded clauses are not functions from individuals to inquisitive propositions, but downward closed sets of sets of individual-index pairs instead. In this way, the individual does not just serve as input, but can be an object of inquiry too. A set of sets of individual-index pairs is equivalent to a set of properties. So it looks like the correct generalization of Lewis’ idea is to embed sets of properties rather than single inquisitive properties.⁹

However, this theory faces a compositionality problem. While inquisitive propositions can be abstracted to inquisitive properties by means of lambda-abstraction, inquisitive propositions cannot be abstracted to sets of properties. As an example, consider the inquisitive proposition denoted by $?y(y = x)$, which is our translation of the question ‘who is x ?’. An inquisitive property can be obtained by simply abstracting over x , which results in $\lambda x ?y(y = x)$. But when we want embedded questions to denote sets of properties, we have to obtain the following set of sets of individual-index pairs: $\{\{\langle x, i \rangle \mid i \models x = d\} \mid d \in D\}$. This cannot be done by abstracting over the question as a whole, but only by abstracting over its resolutions individually: we would need a syntactic operation to retrieve formulas that represent the resolutions of the question, and abstract over these. This, in turn, means that the semantic value of (19) would not be built up out of the semantic values of its parts.

This compositionality problem can be solved by making unembedded questions denote sets of sets of individual-index pairs too, so that no abstraction is required when embedding them. In fact, we can just rely on the structure of inquisitive characters as defined in Chapter 2, as sets of sets of context-index pairs, which is strictly richer than sets of sets of individual-index pairs. However, this would be a character-embedding rather than a property-embedding strategy.

would argue that in Lingens’ situation, the sentence should also be true if we have a rigid cover in mind.

⁹Note that while sets of sets of individual-index pairs (or as Lewis would say, sets of sets of centered worlds) can be viewed as sets of properties, not all sets of properties are equivalent to a *downward closed* set of sets of individual-index pairs.

4.4.3 Other shortcomings

Let us briefly look at some other shortcomings of the property-embedding approach that also point towards embedding inquisitive characters rather than inquisitive properties or sets of properties.

First, the property-embedding approach does not account for the relations between *de se* attitudes and indexicality:

- (20) John wonders whether his pants are on fire. \approx John wonders ‘are my pants on fire?’.
- (21) Ringo knows that he is Ringo. \approx Ringo knows ‘I am Ringo’.
 \Rightarrow Ringo knows something that is necessary but a posteriori.

This relation can only be captured by somehow relating the ‘self’ variable to the context. But Lewis does not consider indexicals, and therefore never mentions the context.

Second, properties may ultimately not be general enough anyway. Besides attitudes relative to the attitude holder, there are also attitudes relative to an addressee (*de te*) and to the present moment (*de nunc*) (Von Stechow, 1982; Schlenker, 1999). An example of a *de te* attitude is the following:

- (22) John told Mary to leave.

Third, it has been argued (e.g. in Magidor, 2015) that *de se* puzzles are just special cases of Frege’s puzzle, and therefore one single solution should be sought for both *de se* attitudes and other cases of Frege’s puzzle.¹⁰ Magidor offers two directions for options: either using a more fine-grained notion of propositions, or a more fine-grained notion of belief states in terms of a combination of propositions and modes of presentation. Since in this thesis we use two-dimensional machinery to account for puzzles about identity, it is natural to use this machinery also for *de se* attitudes – although this strategy does not make propositions more fine-grained, it does offer a more fine-grained notion of semantic value in terms of characters.

A fourth and final problem has to do specifically with questions under conceptual covers: the ‘self’ of the *de se* attitude has to be available as input for functions in conceptual covers (just like the speaker of a context, as we have seen in the previous chapter). This is required to account for questions like the following:

- (23) Lingens wonders to whom he should pass the cards (relative to himself).

If this ‘self’ element exists only as a free variable of the (inquisitive) property that

¹⁰For another prominent refutation of the importance of *de se*, see Cappelen & Dever (2013). Since their view differs radically from most of the work discussed in this thesis, I will not engage with it here.

is being self-ascribed, then it is not clear how it can serve as input for concepts.

These arguments together suggest that the (inquisitive) character-embedding approach discussed in the previous section is an improvement over (inquisitive) property-embedding. In this strategy, the role of the ‘self’ in Lewis’ account is essentially replaced by the more general context, which contains not only a speaker/subject, but also an addressee, time, place, etc. Furthermore, attitudes can make these things objects of inquiry, instead of just taking them as input.

However, we are still left with the problem that the character-embedding approach does not capture the behavior of indexicals. We therefore need to somehow combine the proposition-embedding and character-embedding approaches.

4.5 Embedding propositions or characters

In this section I will suggest and dismiss two combinations of the proposition-embedding and character-embedding approaches.¹¹

4.5.1 Partial diagonalization

First, note that K^2 is definable in terms of K^1 and a diagonal operator \dagger (Davies & Humberstone, 1980; Stalnaker, 1978):

$$c, i \models \dagger\varphi \iff i, i \models \varphi$$

$$K^2\varphi := K^1 \dagger\varphi$$

This illustrates the difference between the two notions of knowing: failing to know that Hesperus is Phosphorus in the K^2 -sense means failing to know that ‘whatever Hesperus refers to is whatever Phosphorus refers to’, the subjective intension, in the K^1 -sense.

A way to save the treatment of indexicals that K^1 offers, which seems worth a try, is using a ‘partial diagonalizer’ \dagger' which only partially modifies the context of utterance, as follows:

$$c, i \models \dagger'\varphi \iff c(w_i), i \models \varphi$$

Where $c(w_i)$ is like context c , but with world w_i instead of w_c . In this way, both intuitions about attitude verbs are reflected: they embed characters, but the referents of indexicals remain fixed since the speaker, addressee and position of $c(w_i)$ are the same as those of c .

However, this option will not work. Since the speaker of c may not be at the position of c in w_i , in many cases $c(w_i)$ will be an improper context and thus

¹¹Chalmers (2011) develops a combination of these approaches that relies on structured intensions. Since we do not have an inquisitive generalization of this machinery at hand, I leave a comparison with this proposal for further work.

undefined. This is especially problematic in cases where the attitude holder has a false belief about the position of the speaker: in that case, all contexts $c(w_i)$ will be undefined, and this will trivialize all belief ascriptions. Since the ban on improper contexts is crucial to distinguish a priori from a posteriori sentences, the idea of partial diagonalization should be abandoned.

4.5.2 Enriched indices

A more fruitful strategy to combine K^1 and K^2 , proposed by (Stephenson, 2002; Anand & Nevins, 2004; Ninan, 2010), is to give indices the same structure as contexts. This means that, like contexts, indices have a speaker, addressee, position, and whatever other parameters are required in contexts. These parameters of the index serve as referents for *de se*, *de te* and *de nunc* attitudes, while the parameters of the context remain available as referents for indexicals.

Attitude predicates shift the index, not the context, and the information state of an individual is a set of enriched indices (which is the same as a set of contexts). This approach has the same entry for *know* as K^1 , repeated here:

$$c, i \models K_a^1 \varphi \iff \text{for all } i' \text{ in } a\text{'s information state in } i: c, i' \models \varphi$$

However, here i' is a context-like object. If we want, we can assume that i' really stands for a point $\langle i', i' \rangle$ and that an individual's information state is a subset of the diagonal.

As an example, the *de se* reading of 'Kirk believes that he is a hero' is true in context c and index i iff for all Kirk's belief-indices i' in i , $a_{i'}$ is a hero in $w_{i'}$.

This approach is quite elegant, and what I will develop in the next section will be very much in the same spirit. However, there are arguments to do things slightly differently.

First, one of the main ideas behind the distinction between contexts and indices is that the indices contain the parameters that can be shifted by operators in natural language, while the contexts contain the unshiftable ones (see e.g. Lewis, 1980; Haas-Spohn, 1995). The speaker is usually considered to not be shiftable, and should therefore belong to a context. Admittedly, this distinction blurs a bit since the attitude holder is not really the same as a speaker.

Second, a big advantage of two-dimensionality is that it encodes a distinction between subjective intension (as the diagonal) and objective intension (as the proposition expressed). The enriched indices approach is correct in that it lets attitude predicates embed subjective intensions. But it does so by making propositions subjective. For instance, the proposition expressed by $P(\textit{self})$ means something else for you than for me (for me it means that I have property P , for you it means that you have property P). The result of making propositions subjective is that there is no objective meaning layer left.

A concrete example in which this matters is in strict readings of elliptical sentences such as (24):

(24) John forgot to call Mary and Bob forgot too.

In the sloppy reading of the sentence, Bob also forgot to call Mary, so Bob forgot the same subjective thing as John. But in the strict reading, Bob also forgot that John had to call Mary, the same objective thing as John. To predict this ambiguity, the subjective and objective meanings of the embedded clause have to be distinguished.

Finally, a related problem is the necessity or contingency of embedded clauses. Consider the following sentence.

(25) Lingens knows that it is not contingent who he is.

For this sentence to be true, the expression ‘who he is’ (read *de se*) should not be contingent. But in the enriched indices approach it would be contingent, since the referent of ‘he’ (the speaker parameter of the index) may vary per index.

These points are not devastating arguments against the enriched indices approach. One could still defend it by saying that some operators, such as metaphysical modalities, only shift the world parameter of the index, not the index itself. And one could also say that the objective meaning of a proposition is represented by the set of worlds w_i such that i is a member of the proposition. However, I think it is more transparent to keep these things separate from the start. In the next section I will therefore propose an account that is technically similar to the enriched indices approach, but conceptually different.

4.6 Bicontextual approach

In this section I propose a new way of combining the proposals discussed so far. The idea is as follows: on the one hand, the character-embedding approach shows that to account for attitudes about the context such as *de se* attitudes, we need to be able to shift the context. At the same time, the proposition-embedding approach shows that we need to keep the original utterance context around, so that indexicals can refer to that context. My proposal is therefore to evaluate sentences relative to an index and two different contexts: the utterance context cu and the attitude context ca .

We will assume that the information that any individual has can be encoded as information with respect to a context and index. Following the enriched indices approach, we will assume that we only need to consider diagonal points. The clause for *know* will then be the following:

$$cu, ca, i \models K_a \varphi \iff \text{for all } \langle c', i' \rangle \text{ in } a\text{'s information state in } i: cu, c', i' \models \varphi$$

We obtain a similar result as in partial diagonalization and the enriched indices

approach: since indexicals get their referent from cu , the embedding verb does not affect them, but we still assess φ by taking its diagonal (in a way, since there is now more than one way to diagonalize. Here we diagonalize with respect to the attitude context only). We can assume that for unembedded sentences $cu = ca$, because there can be no discrepancy between the context of utterance and the attitude context in that case.

An important difference compared to the enriched indices approach is that the index can still be shifted independently of the attitude context. This is something we need for attitude ascriptions about counterfactual situations, like the following:

- (26) Heimson believes he could have been Hume.
 (27) John knows that the students in class could have all joined the protest march.

The point is that the possibility claims within Heimson's and John's attitudes should still be evaluated relative to *two* independent points: for Heimson, we need a context c that provides the epistemically possible 'self', and a counterfactual alternative possibility i , in which we evaluate the claim that this person is Hume. For John, we need an epistemic alternative c that provides the set of students in class according to John's knowledge, and a counterfactual alternative i in which we check that these students are at the protest march.¹²

As for the interpretation of indexicals, nothing changes. They still get their referent from the utterance context cu :

- $[I]_{cu,ca,i,g} = a_{cu}$
- $[you]_{cu,ca,i,g} = b_{cu}$
- $[here]_{cu,ca,i,g} = p_{cu}$

However, we also introduce special constants that can be used in attitudes *de se* and *de te*:

- $[subject]_{cu,ca,i,g} = a_{ca}$
- $[object]_{cu,ca,i,g} = b_{ca}$

The analysis of proper names changes. They now get their interpretation from the attitude context instead of the utterance context.¹³

- If b is a proper name, $[b]_{cu,ca,i,g} = I(b)(i_{ca})$

¹²A proper analysis of these sentences requires a non-global semantics for necessity and possibility, which makes use of an accessibility relation.

¹³This makes our analysis of proper names similar to that in Cumming (2008), where proper names get their referent from the assignment function. There, attitude predicates shift both the assignment function and the world, while metaphysical modals shift only the world.

Note that the behavior of indexicals we encode here is not universal. In English, indexicals always get their referent from the context of utterance rather than the context of attitude, but there are languages in which ‘I’ in indirect discourse can refer to the attitude holder instead. It is a matter of debate whether indexicals always shift together or can shift individually in some languages (see Anand & Nevins, 2004; Anand, 2006; Deal, 2017; Schlenker, 2011). I will not consider any non-English examples here, but the system can easily be extended to account for these cross-linguistic differences, either by an operator that shifts the context or by different entries for indexicals.¹⁴

4.6.1 Inquisitive version

Having established a non-inquisitive account of attitude ascriptions, we are now ready to formulate an inquisitive version that can capture question-directed attitudes. We start by revising some of the definitions from Chapter 2 and Section 4.2.3.

First, the information states that sentences are evaluated against are now sets of triples:

DEFINITION 4.6.1. Information state

An information state is a set of triples $\langle cu, ca, i \rangle$, where cu is an utterance context, ca an attitude context and i an index.

We also redefine the notion of diagonal information state:

DEFINITION 4.6.2. Diagonal information state

A diagonal information state is any information state s such that for each $\langle cu, ca, i \rangle \in s$, $i = i_{ca}$ and $ca = cu$.

We can then define the inquisitive state and information state that individuals are equipped with in our models.

DEFINITION 4.6.3. Inquisitive state of individual

The inquisitive state of individual a at index i (notation $\Sigma_a(i)$) is non-empty, a downward closed set of sets of pairs $\langle c, j \rangle$ where c is a context and j an index.

The information state is defined in terms of the inquisitive state as before, but is now a set of context-index pairs rather than a set of indices:

¹⁴An interesting empirical issue is how indexical shift interacts with question embedding. See Anvari (2019, Section 5.5) for data on Farsi.

DEFINITION 4.6.4. Information state of individual

The information state of individual a at index i (notation $\sigma_a(i)$) is a set of pairs $\langle c, j \rangle$ where c is a context and j an index, defined as follows:

$$\sigma_a(i) = \bigcup \Sigma_a(i)$$

If $\langle c, i \rangle$ is a member of the information state, this means that c is a candidate for the actual context, while i is a possible index. We will only consider pairs $\langle c, i \rangle$ where $i = i_c$. Elements of an individual's inquisitive state are those subsets of their information state in which her issues are resolved.

The generalized clause for *know* will be the following:

$$\pi, s \models_g K_a \varphi \iff \text{for all } \langle cu, ca, i \rangle \in s : \pi, \{cu\} \times \sigma_a(i) \models_g \varphi$$

In words, ‘John knows φ ’ is true in a triple, if the information state that determines the original utterance context, combined with the information state of John at the original index, supports φ . As before, it is supported by an information state if it is true in all members of it.

Like in standard inquisitive semantics, we will arrive at a semantics for *wonder* by first adding an *entertain* operator:

$$\pi, s \models_g E_a \varphi \iff \text{for all } \langle cu, ca, i \rangle \in s, \text{ for all } t \in \Sigma_a(i) : \pi, \{cu\} \times t \models_g \varphi$$

In words, φ is entertained by John in a triple if all information states in his inquisitive state in that index, together with the original context of utterance, support φ . We then define *wonder* in the standard way, as a combination of not knowing and entertaining:

$$W_a \varphi := \neg K_a \varphi \wedge E_a \varphi$$

As in Chapter 2, the notion of consequence and equivalence that apply to unembedded sentences are based on diagonal information states. By Definition 4.6.2, these are information states in which $cu = ca$. Therefore, in unembedded sentences, *I* and *you* are (diagonally) equivalent to *subject* and *object*, respectively.

Finally, we change the definitions of necessity and apriority:

DEFINITION 4.6.5. Necessity and apriority

φ is *necessarily supported* under perspective π in contexts cu, ca iff for all sets of indices K : $\pi, \{cu\} \times \{ca\} \times K \models \varphi$

φ is *a priori supported* under perspective π iff for all diagonal information states s : $\pi, s \models \varphi$

4.6.2 Applications

Let us go through some applications of the bicontextual system to show how our semantics captures question-directed attitudes with indexicals. First, consider the following example in which an indexical question is embedded.¹⁵

- (28) Lingens wonders where I am.
 $W_l?z\text{Located}(I, z)$

This sentence is true in a triple $\langle cu, ca, i \rangle$ if Lingens' information state in i is not informative enough to determine the position of the speaker of cu , but all of the information states in his inquisitive state in i are.

We can capture *de se* readings with the *subject* constant, which always refers to the attitude holder:

- (29) Lingens wonders where he is.
 $W_l?z\text{Located}(\text{subject}, z)$

This sentence is true in a triple $\langle cu, ca, i \rangle$ if Lingens' information state in i does not determine the position of the subject of the attitude, but all of the information states in his inquisitive state in i do.

Unlike the inquisitive property strategy in Section 4.4.1, the present account is general enough to also capture *de se* questions about self-identification:

- (30) Lingens knows who he is.
 $K_l?x(x = \text{subject})$

This sentence is true in a triple $\langle cu, ca, i \rangle$ if in all pairs $\langle c, i \rangle$ in Lingens' information state, the subject of c is the same person, indicating that there is only one person Lingens might be according to his information. Note that this does not come out as trivially true: Lingens' information state may contain pairs $\langle c, i \rangle$ such that a_c is a different individual. Note that, given the right perspective and indexing of x , there is also a descriptive reading of (30), which indicates that Lingens can identify himself in some conceptual cover (for instance, the person on the left or the person on the right).

The distinction between utterance context and attitude context makes sure that we have no problem accounting for mixed cases, which are *de se* as well as indexical:

- (31) Lingens wonders whether he is taller than I am.
 $W_l?T(\text{subject}, I)$

This sentence is true in a triple $\langle cu, ca, i \rangle$ if each information state in Lingens'

¹⁵Whenever variables appear unindexed, I am assuming we interpreted them under the absolute cover.

inquisitive state in i contains either only pairs $\langle c', i' \rangle$ where $a_{c'}$ is taller than a_{cu} , or only pairs $\langle c', i' \rangle$ where a_{cu} is taller than $a_{c'}$, and Lingens' information state in i contains both kinds of pairs.

De se and indexicality

We have seen examples of question-directed attitudes with indexicals, attitudes *de se* and mixed examples. To account also for the relation between indexicality and *de se* attitudes, we can define the following quotation operator ‘.’:

$$\pi, s \models_g \text{'}\varphi\text{' } \iff \pi, \{\langle ca, ca, i \rangle \mid \langle cu, ca, i \rangle \in s\} \models_g \varphi$$

This operator switches evaluation from an information state s to one which is like s , except that in each triple, the utterance context is replaced by the attitude context. This affects the interpretation of indexicals: they now get their referent from the attitude context rather than the utterance context, so that ‘I’ refers to the attitude holder.

As an example, compare the following two sentences:

(32) Lingens wonders ‘who am I?’

$$W_l \text{'}\varphi(x = I)\text{'}$$

(33) Lingens wonders who he is.

$$W_l \varphi(x = \textit{subject})$$

It is easy to show that (32) and (33) are diagonally equivalent. However, they are distinct from (34):

(34) Lingens wonders who I am.

$$W_l \varphi(x = I)$$

Conceptual covers and attitudes

Finally, we can apply the bicontextual refinement also to the definition of conceptual covers. By doing so, we allow for concepts that are not just sensitive to the utterance context, but also to the attitude context.

DEFINITION 4.6.6. Conceptual cover

Let T be a set of triples $\langle cu, ca, i \rangle$. Given T and a domain D , a conceptual cover CC is a set of functions $T \rightarrow D$ such that:

$$\forall t \in T : \forall d \in D : \exists! h \in CC : h(t) = d$$

We can use concepts that rely on the input of attitude contexts to give an account of questions like (35):

- (35) Lingens wonders to whom he should pass the cards.
 $W_l?x_n Pass(subject, x_n)$

The reading we are after is the ‘relative to himself’ reading. Let π_n be a conceptual cover consisting of the functions f_{self} , f_{left} and f_{right} . The first maps every triple $\langle cu, ca, i \rangle$ to the subject in ca , the second to the person who at index i is on the left of the subject in context ca , et cetera. Under this cover, the sentence is true in indices in which Lingens wonders whether he should pass the cards to the left, right or not at all.

Limitations

The inquisitive bicontextual approach can capture *de se* attitudes towards questions and their relation to indexicals. Note that it does not suffer from the limitation of the inquisitive property account, because the attitude context (and, thereby, the self) can be made an object of inquiry. Therefore, questions like (32) do not come out as trivially false on this account. At the same time, indexicals retain their scopeless behavior, because utterance contexts always remain accessible in embedded sentences.

However, the bicontextual approach has an important limitation, which is illustrated by its failure to account for a *de se* reading of (36). Suppose Lingens, still lost in the library and unaware of who he is, encounters a librarian who introduces herself as Miss Mingens. She happens to mention that she knows that a person named Lingens is in the Stanford library.

- (36) Lingens wonders whether Mingens knows where he is.

In this scenario, the *de se* reading of (36) is true, even though Lingens knows (and therefore does not wonder) whether Mingens knows where *Lingens* is.¹⁶

The bicontextual approach cannot account for this. The problem is that ‘he’ should refer to the subject of Lingens’ attitude, but since it occurs in the environment of Mingens’ attitude, the only contexts that are available are the utterance context and Mingens’ attitude context. This limitation is not unique to questions – it also applies to declarative embedded clauses, as (37) shows:

- (37) Lingens believes that Mingens knows that he is in the Stanford library.

The problem can be solved using a dynamic implementation of the idea of the bicontextual approach, which makes more contexts available with each attitude predicate.

¹⁶I assume that ‘where’ quantifies over absolute positions here, not relative ones. Lingens does know that Mingens knows that he is in front of her, but he does not know what Mingens knows about their absolute position (that they’re in the Stanford library).

4.6.3 Dynamic extension: multiple contexts

In this section I will sketch how the bicontextual approach can be implemented dynamically, allowing for reference to elements from contexts that are not the current attitude context, but were introduced earlier.¹⁷ To keep things simple, I do not give a treatment of anaphoric expressions. This dynamic implementation also differs from other dynamic accounts of indexicals in that it does not assume that indexicals are presuppositional (like e.g. Hunter & Asher, 2005). Instead, it stays close to Kaplan’s two-dimensional approach.

The key idea is that we use not only contexts, but also *context maps*:

DEFINITION 4.6.7. Context map

A context map \bar{c} is a partial function from natural numbers to contexts such that $\bar{c}(0)$ is defined.

By convention, a context c and its corresponding context map $\{0 \mapsto c\}$ can be used interchangeably.

The most basic context map is just an utterance context, but the idea is that context maps keep track of attitude contexts as a sentence unfolds. In the definition of information states, we can do away with the distinction between utterance contexts and attitude contexts, and replace them with the more general notion of context maps.

DEFINITION 4.6.8. Information state

An information state is a set of pairs $\langle \bar{c}, i \rangle$, where \bar{c} is a context map and i an index.

We will keep the original structure for inquisitive states and information states of individuals: a set of sets of context-index pairs and a set of context-index pairs, respectively.¹⁸

All attitude operators will be indexed with a number $n > 0$ (e.g. K_a^1). The elements of the attitude context that belongs to a particular attitude will remain available with the usual constants, which are also indexed (e.g. *subject*₁, *object*₂).

Updating an information state s with $K_a^n \varphi$ happens in two steps, which are performed independently for every pair $\langle \bar{c}, i \rangle$ in s . First, we update the information state of a in i . Second, we evaluate φ against this updated information state. The update of the information state of a amounts to making the contexts from s available to this information state. Let us first define the update of an

¹⁷Similar results can be obtained by adding variables for contexts to the object language. See Schlenker (2003) for such an approach to declarative sentences.

¹⁸However, by Definition 4.6.7, this means that we can also view the information state of an individual as a set of pairs $\langle \bar{c}, i \rangle$ with only $\bar{c}(0)$ defined.

information state s with a number n and a context map \bar{c} .

DEFINITION 4.6.9. Information state update

The update of information state s with number $n > 0$ and context map \bar{c} is defined as follows:

$$s[n, \bar{c}] = \{ \langle \bar{c}[n \mapsto \bar{e}(0)], i \rangle \mid \langle \bar{e}, i \rangle \in s \}$$

In words, the update of s with n, \bar{c} results in a new information state t which is like s , except that in all pairs $\langle \bar{e}, i \rangle$, the context map \bar{e} is replaced by \bar{c} , with n mapping to the context that 0 mapped to in \bar{e} .

Since an update with $K_a^n \varphi$ does not introduce new contexts outside of its scope (it is externally static), we can give its semantics in terms of the familiar support conditions rather than update conditions:¹⁹

$$s \models_g K_a^n \varphi \iff \text{for all } \langle \bar{c}, i \rangle \in s : \sigma_a(i)[n, \bar{c}] \models_g \varphi$$

Applications

To illustrate how things work, let us look at a few examples. As can be seen in Definition 4.6.9, an update to an information state s can never change the value of $\bar{c}(0)$ in any pair $\langle \bar{c}, i \rangle \in s$. As a consequence, the utterance context always stays available using subscript 0, no matter how deep an indexical expression occurs in nested attitudes.

- (38) John believes₁ that I am taller than he₁ is.
 $B_j^1 T(\text{subject}_0, \text{subject}_1)$

In a similar way, attitude contexts remain available using the subscript that corresponds to the number of the attitude verb (as long as two attitude verbs are not indexed with the same number). Because of this mechanism, ‘he₁’ in (39) can refer to the attitude context of John.

- (39) John believes₁ that Mary knows₂ that she₂ is taller than he₁ is.
 $B_j^1 K_m^2 T(\text{subject}_2, \text{subject}_1)$

For examples with *wonder*, we need to add the E modality in a way analogous to K . In this case, we have to make the context maps in s available to each of the individual information states in the inquisitive state:

$$s \models_g E_a^n \varphi \iff \text{for all } \langle \bar{c}, i \rangle \in s : \text{for all } t \in \Sigma_a(i) : t[n, \bar{c}] \models_g \varphi$$

With this machinery in place, it is straightforward to account for the *de se* reading of (36), namely as follows:

¹⁹To maintain readability, the perspective π is suppressed here.

- (36') Lings wonders whether Mings knows where he is.
 $W_l^1 ? K_m^2 ? z \text{Located}(\text{subject}_1, z)$

Flexible actuality

Let me end this sketch with a final suggestion: apart from indexing *subject* and *object* constants, we can also consider indexing the actuality operator A , as is done in Cresswell (1990). In this way, we obtain a more flexible actuality operator that can not just be used to shift evaluation to the index corresponding to the utterance context, but also to the index corresponding to one of the attitude contexts. I suggest the following semantics:

$$s \models_g A_n \varphi \iff \{ \langle \bar{c}, i_{\bar{c}(n)} \rangle \mid \langle \bar{c}, i \rangle \in s \} \models_g \varphi$$

We recover our original actuality operator from Chapter 2 as A_0 . This more flexible actuality operator can be motivated by sentences like the following:

- (40) John wonders whether the students in class could have all joined the protest march.

In (40), the actuality operator we use to check whether a student is in class should not shift evaluation to the context of utterance, but to John's attitude context.

With the flexible actuality operator, we can give a more precise account of the following puzzling data in Section 2.5. Compare the following two sentences:

- (41) John doesn't know which students are students.
 (42) It is a priori which students are students.

As noted in footnote 17 on p. 50, it seems odd that these two sentences can both be true. With (43) as the formal translation of the embedded question, it follows that (42) is indeed true.

- (43) $\forall x (A_0 Sx \rightarrow ?Sx)$

Moreover, under the analysis in (41'), (41) is indeed satisfiable.

- (41') $\neg K_j^1 \forall x (A_0 Sx \rightarrow ?Sx)$

One can rightly ask what it means for a question to be a priori if someone can fail to know it. But we can now show that this just means that the following analysis of (41) is contradictory:

- (41'') $\neg K_j^1 \forall x (A_1 Sx \rightarrow ?Sx)$

Of course, the sketch of the dynamic version given here is very limited: for instance, it cannot capture the *de re* reading of (36) where 'he' is just anaphoric

to Lingens. However, a properly dynamic extension could do so by incorporating ideas from Kamp (1981); Heim (1982); Groenendijk & Stokhof (1991). For a dynamic version of inquisitive semantics that does just that, but without indexicality and *de se*, see Dotlačil & Roelofsen (2019). Note also that, in the full picture, conceptual covers should be reimplemented, by defining them as sets of functions from context-map-index pairs to individuals.

4.7 Conclusion

In this chapter we examined several analyses of attitude ascriptions and the feasibility of generalizing them to question-directed attitudes. We have seen that an inquisitive generalization of the property-embedding approach of Lewis (1979), in terms of inquisitive properties, cannot account for *de se* questions about the identity of the attitude holder.

We have developed an inquisitive generalization of the character-embedding approach, which keeps track of previous contexts. This generalization can account for question-directed attitudes *de se*, and at the same time preserves the original account of indexicals from Chapter 2. It also shows in a precise way how a priori questions are known, and how non-contingent questions can still be wondered about.

In the final part of this chapter, I have given a sketch of a dynamic implementation of the presented ideas. The next step in the development of this framework is to fully develop the dynamic variant, which I leave for another occasion.

5.

Two-dimensional
logic of questions

Chapter 2 developed a combination of two-dimensional semantics and inquisitive semantics, in which questions are analyzed directly in terms of resolution conditions: the meaning of a question is equated with the set of information states in which it is resolved. In inquisitive semantics, it is natural to generalize the notions of apriority and necessity that already exist in the literature in such a way that they can apply to questions and statements uniformly. While necessary truth and a priori truth are formalized as truth relative to some particular pairs, in two-dimensional inquisitive semantics sentences can be *necessarily resolved* or *a priori resolved*, which means being resolved relative to some particular information states.

The present chapter is concerned with the logic that this combination of two-dimensional semantics and inquisitive semantics gives rise to, which we will call *two-dimensional inquisitive logic* (Inq2D).

5.1 Two-dimensional inquisitive logic

For simplicity, we will work with the propositional variant of Inq2D, and we will not incorporate attitude ascriptions or conceptual covers. The main ingredients of this system are an operator with which questions can be formed, as well as three modal operators: apart from apriority and necessity, it has a modal operator for *actuality*, which plays the role of an indexical.¹

The ‘classical’ (that is, non-inquisitive) variant of this logic is the one described in Fritz (2013, 2014). I will generalize this system to the inquisitive setting in order to be able to express statements about the apriority (and necessity) of questions, as in the schema in (1), as well as questions about the apriority (and necessity) of statements and questions, as in (2).

- (1) It is a priori whether φ .
- (2)
 - a. Is it a priori that φ ?
 - b. Is it a priori whether φ ?

The rest of this chapter is set up as follows. I will first introduce the semantics of Inq2D. Then, in Section 5.2, I will give an alternative completeness proof for the classical fragment of Inq2D, one that is based on a canonical model so that it can be easily extended to our full language. The details of the completeness proof for the full language will be given in Section 5.3.

¹In a first-order setting, other indexicals like ‘I’ and ‘here’ can be considered, but these are not available in a propositional language.

5.1.1 Language

The language of Inq2D is defined by the following grammar:

$$\varphi ::= p \mid \perp \mid \varphi \wedge \varphi \mid \varphi \vee \varphi \mid \varphi \rightarrow \varphi \mid \Box\varphi \mid A\varphi \mid \blacksquare\varphi$$

We define the usual abbreviations:

$$\neg\varphi := \varphi \rightarrow \perp \qquad \varphi \vee \psi := \neg(\neg\varphi \wedge \neg\psi) \qquad ?\varphi := \varphi \vee \neg\varphi$$

In short, we extend the basic inquisitive logic InqB (following the notation conventions of Ciardelli, 2016) with operators to express necessity (\Box), actuality (A) and apriority (\blacksquare).

Necessity and apriority operate on different levels: the former is a property of propositions, while the latter is a property of propositional concepts (or, in Kaplanian terms, of *content* and of *character*, respectively). However, there are several reasons for considering apriority as part of the logical language rather than as a meta-logical notion, and therefore operating on the same level in the formalization as necessity. First, sentences can be a priori in some models and not in others, which means apriority does not operate on the same level as logical validity. Second, it is interesting to study the interactions between apriority and necessity (see, for instance, the analysis of the nesting problem in Fritz, 2013). Thirdly, it makes sense to embed claims about apriority of sentences under logical operators, like negation and question-forming operators.

5.1.2 Semantics

Our semantics will operate on the same models as the ones used in Fritz (2013, 2014).²

DEFINITION 5.1.1. Matrix frame

A matrix frame is a structure $\langle W, R_\Box, R_A, R_\blacksquare \rangle$, where:

- $W = W' \times W'$ for some set of worlds W'
- $\langle w, v \rangle R_\Box \langle w', v' \rangle \iff w = w'$
- $\langle w, v \rangle R_A \langle w', v' \rangle \iff w = w' = v'$
- $\langle w, v \rangle R_\blacksquare \langle w', v' \rangle \iff w' = v'$

²To maintain consistency with the notation in the rest of this thesis, there are some differences between Fritz' papers and the present chapter: Fritz uses A for apriority and $@$ for actuality. I use \blacksquare for apriority and A for actuality. Also, I order the pairs as in the previous chapters: in the pair $\langle w, v \rangle$ the context world is w and the index world is v . However, I will speak of worlds rather than of contexts or indices, since these elements need no further structure in a propositional setting.

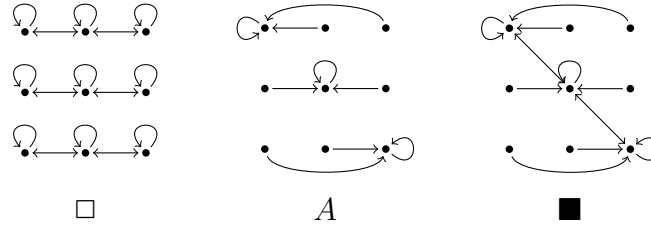

Figure 5.1: Relations in matrix frames (transitive arrows omitted)

□ We define: $D = \{\langle w, v \rangle \in W \mid w = v\}$

We can think of matrix frames as diagrams in which the elements of W' are both on the vertical and the horizontal axis, and the pairs in W are coordinates. A pair $\langle w, v \rangle$ is an evaluation point that takes w to be the world considered as actual and v to be the world of evaluation.

The relation R_{\square} connects a pair to all the pairs on the same row. This means that it considers other worlds of evaluation, while keeping the actual world constant. The relation R_A looks at the unique ‘actual pair’ within the row. That is, it connects any $\langle w, v \rangle$ to $\langle w, w \rangle$.

D is the set of all these ‘actual pairs’: pairs in which the same world is contained twice. It is also called the *diagonal* because of the position these pairs are in when we draw a matrix. D will be the set of distinguished elements on which consequence and validity will be defined. R_{\blacksquare} connects each pair simply to all pairs on the diagonal. See Figure 5.1 for an illustration of the relations in a matrix frame.

As usual in inquisitive semantics, we will evaluate sentences not relative to single points in the model but relative to sets of them – in this case, not sets of worlds but sets of pairs of worlds. We will call any subset of W an *information state* and use the term *diagonal information state* for subsets of D .

We can think of an information state s as something that gives us incomplete information about what the actual world is (namely, it is one of the worlds w such that $\langle w, v \rangle \in s$ for some v). In a similar way, it gives us information about what the world of evaluation is (namely, one of the worlds v such that $\langle w, v \rangle \in s$ for some w). On top of this, it also gives us information about how the two relate: for instance, the information state $\{\langle w, w \rangle, \langle v, v \rangle\}$ also tells us that the actual world and the evaluation world are the same.

A matrix model is any matrix frame extended with a valuation function V , which will be defined as follows: instead of assigning a set of worlds to each propositional atom, it assigns a set of pairs of worlds, so a set of elements of W .

Whenever p represents a sentence with an indexical, like ‘I am hungry’, its truth will depend not only on the world of evaluation (which determines whether

the person denoted by ‘I’ is indeed hungry), but also on what the actual world is (which determines how the indexical is resolved). Therefore, the valuation may make it true in $\langle w, v \rangle$ but false in $\langle w', v \rangle$. Atoms whose truth does not at all depend on the left element of pairs can be considered to represent sentences without indexicals or proper names.

We are now ready to give the semantics for **Inq2D**, which is a special case of inquisitive Kripke modal logic (**InqBK**) as presented in Ciardelli (2016).

DEFINITION 5.1.2. Support conditions

For $\boxtimes \in \{\square, A, \blacksquare\}$: let $\sigma_{\boxtimes}(x) = \{y \mid xR_{\boxtimes}y\}$.

- $s \models p \iff s \subseteq V(p)$
- $s \models \perp \iff s = \emptyset$
- $s \models \varphi \wedge \psi \iff s \models \varphi \text{ and } s \models \psi$
- $s \models \varphi \vee \psi \iff s \models \varphi \text{ or } s \models \psi$
- $s \models \varphi \rightarrow \psi \iff \text{for all } t \subseteq s : t \models \varphi \text{ implies } t \models \psi$
- $s \models \square\varphi \iff \text{for all } \langle w, v \rangle \in s : \sigma_{\square}(\langle w, v \rangle) \models \varphi$
- $s \models A\varphi \iff \text{for all } \langle w, v \rangle \in s : \sigma_A(\langle w, v \rangle) \models \varphi$
- $s \models \blacksquare\varphi \iff \text{for all } \langle w, v \rangle \in s : \sigma_{\blacksquare}(\langle w, v \rangle) \models \varphi$

We write $s \models \varphi$ for ‘ s supports φ ’, which means that the information in s already contains the information conveyed by φ and settles the issue raised by φ . The issue that a formula raises is trivial if there is only one maximal supporting state, while the information a formula conveys is trivial if the supporting states together cover the entire logical space.

We can define the notion of truth with respect to an evaluation pair as support in the corresponding singleton state:

DEFINITION 5.1.3. Truth

$$\langle w, v \rangle \models \varphi \iff \{\langle w, v \rangle\} \models \varphi$$

For some formulas, being supported in s simply amounts to being true relative to all pairs in s . These formulas are called *truth-conditional*.

DEFINITION 5.1.4. Truth-conditionality

A formula φ is truth-conditional iff

$$s \models \varphi \iff \text{for all } \langle w, v \rangle \in s : \langle w, v \rangle \models \varphi$$

The operator \vee (inquisitive disjunction) can be used to construct formulas that are not truth-conditional, such as $p \vee q$. For this formula to be supported in s , it is not enough if all pairs in s make it true – it is required that they either all make p true or all make q true. Formulas that are not truth-conditional will be called *questions*.

5.1.3 State-based actuality

Two facts about the modalities should be highlighted. First, any formula of the form $\Box\varphi$, $\blacksquare\varphi$ or $A\varphi$ is by definition a truth-conditional formula (this can be seen from the support conditions, which operate on individual pairs). For necessity and apriority this is as it should be, since ‘it is necessary whether φ ’ and ‘it is a priori whether φ ’ are indeed statements, not questions. Second, since R_A connects every pair only to one single pair, the truth conditions of $A\varphi$ are not sensitive to the issue raised by φ .³ Thus, what $A\varphi$ expresses can be phrased as ‘in the actual world, the information conveyed by φ is true’.

In Chapter 2 we defined a different actuality operator, namely the following one, which is sensitive to issues:

$$s \models \mathcal{A}\varphi \iff \{\langle w, w \rangle \mid \langle w, v \rangle \in s\} \models \varphi$$

A formula $\mathcal{A}\varphi$ is supported by an information state s just in case the information in s about what the actual world is settles the issue expressed by φ . Unlike $A\varphi$, $\mathcal{A}\varphi$ is sensitive to the inquisitive content of φ and can be a question itself.

However, adding \mathcal{A} does not make the language more expressive, and since it will be easier for us to work with A in our completeness proof, we will consider A as primitive and define \mathcal{A} by the following recursive definition:⁴

- $\mathcal{A}\varphi := A\varphi$ whenever φ is atomic or of the form $\Box\psi$, $A\psi$ or $\blacksquare\psi$
- $\mathcal{A}(\varphi \wedge \psi) := \mathcal{A}\varphi \wedge \mathcal{A}\psi$
- $\mathcal{A}(\varphi \vee \psi) := \mathcal{A}\varphi \vee \mathcal{A}\psi$
- $\mathcal{A}(\varphi \rightarrow \psi) := \mathcal{A}\varphi \rightarrow \mathcal{A}\psi$

³This means, for instance, that $A(p \vee q)$ expresses the same as $A(p \vee q)$, even though $p \vee q$ raises the issue whether p or q holds and $p \vee q$ does not.

⁴ \mathcal{A} is not uniformly definable in terms of the other connectives.

With this recursive definition, the support conditions for \mathcal{A} given above follow as a fact. Whenever φ is truth-conditional, $A\varphi$ and $\mathcal{A}\varphi$ are equivalent. For questions ψ , $\mathcal{A}\psi$ is always equivalent to some formula without \mathcal{A} 's.

5.1.4 Consequence relations

Following Crossley & Humberstone (1977), we can distinguish two relations of consequence in two-dimensional logic: the *general* consequence relation looks at all evaluation pairs of the model, while the *diagonal* consequence relation only looks at diagonal pairs (elements of D).⁵ Both of these notions can be generalized to information states.

DEFINITION 5.1.5. General consequence
 $\Phi \models_{\mathbf{g}} \psi$ iff for all models M and information states s :
 if $M, s \models \varphi$ for all $\varphi \in \Phi$ then $M, s \models \psi$.

Intuitively, we want our consequence relation to be such that $\mathcal{A}\varphi \models \varphi$ and $\blacksquare\varphi \models \varphi$. This is not satisfied in the general consequence relation, because it considers all information states. There are information states that support $\mathcal{A}\varphi$ or $\blacksquare\varphi$ but not φ , namely ones that contain non-diagonal pairs. Therefore it makes more sense to restrict the consequence relation to diagonal information states (subsets of D):

DEFINITION 5.1.6. Diagonal consequence
 $\Phi \models_{\mathbf{d}} \psi$ iff for all models M and diagonal information states s :
 if $M, s \models \varphi$ for all $\varphi \in \Phi$ then $M, s \models \psi$.

This restriction can be motivated by viewing diagonal consequence as a specific case of *contextual entailment* (Ciardelli, 2016): we are interested in entailment in a specific context, namely the state in which everything which is a priori is supported, and this state is exactly the diagonal D in our models.

Notice that this does not mean that information states that are not diagonal should be disregarded altogether, as they still come into play whenever a \square -operator is used. They are essential to capture the distinction between necessity and apriority.

For each information state s there is a diagonal information state s' consisting of all the $\langle w, w \rangle$ such that $\langle w, v \rangle \in s$. As we have seen, \mathcal{A} is defined in such a way that we have $s \models_{\mathbf{g}} \mathcal{A}\varphi \iff s' \models_{\mathbf{g}} \varphi$. This can be used to connect the notions of general and diagonal consequence by the following fact:

⁵Crossley & Humberstone (1977) refer to the diagonal consequence relation as *real-world* consequence.

FACT 5.1.1. $\varphi \models_d \psi \iff \mathcal{A}\varphi \models_g \mathcal{A}\psi$

As we will see later, this connection will be exploited by our inference relation.

The notions of general consequence and diagonal consequence come with their corresponding notions of validity. The latter is more restricted than the former: the diagonal validities include sentences which are valid by virtue of their indexicals, such as ‘Am I here now?’ or $?(Ap \rightarrow p)$, while the general validities are only those sentences that are purely logically resolved (such as $?(p \rightarrow p)$).

Notice that apriority is not the same as diagonal validity: although all diagonal validities are a priori, the converse is not the case. For instance, p can be a priori in some model, but it is not valid.

5.1.5 Questions and apriority

Classically, what it means for a formula to be valid is that it is true in any possible world in any model. In inquisitive logics, a formula is valid if it is supported in any state in any model.

Normally, this definition makes sure that inquisitive disjunction does not introduce any new validities to the logic. That is, inquisitive logics usually satisfy the *disjunction property*, which says that the validity of an inquisitive disjunction can be traced back to the validity of one of the disjuncts:

$$\models \varphi \vee \psi \iff \models \varphi \text{ or } \models \psi$$

The intuitive idea behind this property is as follows. An inquisitive disjunction puts forward a request to choose between two alternatives. If this disjunction is valid – which means that this choice can be made purely by logic – then one of the suggested alternatives should be valid (Grilletti, 2019).

An interesting observation we can make here is that this property does not hold for Inq2D .⁶ A counterexample is the following:

$$\models \blacksquare p \vee \neg \blacksquare p, \text{ but } \not\models \blacksquare p \text{ and } \not\models \neg \blacksquare p$$

It is easy to see why this disjunction is valid: it is supported if either p is true in all pairs on the diagonal or p is false in at least one pair on the diagonal. Clearly, in all models one of the two must be the case.⁷

Intuitively, this result seems to be correct: the only situation in which we can be uncertain as to whether some statement p is a priori is if we do not really grasp

⁶It does not matter which consequence relation we consider here, both \models_d and \models_g lack this property.

⁷This phenomenon is similar to what occurs in first-order inquisitive logic (InqBQ) if identity is rigid: in that case $?(a = b)$ becomes a validity. However, in InqBQ , identity is an equivalence relation that may vary across worlds. See Ciardelli (2016, p. 142).

what it means – but this is like not knowing in which model we are. Given some model that defines what sentences mean (by means of its valuation function), the question $?■p$ should always be resolved.⁸

Note that while $?■p$ is valid, the same does not hold for $■?p$, which expresses something else. The former expresses the question ‘whether it is a priori that p ’ while the latter expresses the statement ‘it is a priori whether p ’, which is false if the pairs on the diagonal do not agree on the truth value of p .

5.2 Completeness proof for the classical fragment

We start by giving a completeness proof for the non-inquisitive fragment of the language. This fragment is identical to the one introduced in Fritz (2014). However, we will give a different completeness proof than the one given there, one that can more easily be adapted to the inquisitive setting because it relies on a canonical model.

Our language \mathcal{L}_1 will be the \forall -free fragment, generated by the following grammar:⁹

DEFINITION 5.2.1. Classical fragment

$$\alpha ::= p \mid \perp \mid \alpha \wedge \alpha \mid \alpha \rightarrow \alpha \mid \Box\alpha \mid A\alpha \mid \blacksquare\alpha$$

The classical fragment of the system consists only of truth-conditional formulas. That is, the support relation between states and formulas can be reduced to the relation of truth between worlds and formulas.

FACT 5.2.1. Truth conditions of classical fragment

- $\langle w, v \rangle \models p \iff \langle w, v \rangle \in V(p)$
- $\langle w, v \rangle \not\models \perp$
- $\langle w, v \rangle \models \alpha \wedge \beta \iff \langle w, v \rangle \models \alpha \text{ and } \langle w, v \rangle \models \beta$
- $\langle w, v \rangle \models \alpha \rightarrow \beta \iff \langle w, v \rangle \not\models \alpha \text{ or } \langle w, v \rangle \models \beta$
- $\langle w, v \rangle \models \Box\alpha \iff \langle w, v \rangle R_{\Box} \langle w', v' \rangle \text{ implies } \langle w', v' \rangle \models \alpha$
- $\langle w, v \rangle \models A\alpha \iff \langle w, v \rangle R_A \langle w', v' \rangle \text{ implies } \langle w', v' \rangle \models \alpha$
- $\langle w, v \rangle \models \blacksquare\alpha \iff \langle w, v \rangle R_{\blacksquare} \langle w', v' \rangle \text{ implies } \langle w', v' \rangle \models \alpha$

⁸Note that, strictly speaking, $?■p$ is not a question, since it is truth-conditional.

⁹In what follows we will use α, β, γ for classical formulas and φ, ψ for arbitrary formulas.

These truth conditions are indeed the same as the ones given in Fritz (2014).¹⁰

The completeness proof will proceed in the following steps.

Although we are ultimately interested in the logic of diagonal consequence, we start by proving completeness for the logic of general consequence. We will do this by constructing a canonical model for two-dimensional logic. However, this canonical model is itself not a matrix model. We will therefore first introduce a more general class of models, which we will call *sliced matrix models*.

We will then show that the canonical model of two-dimensional logic is a sliced matrix model, and use this canonical model to prove completeness with respect to sliced matrix frames.

Completeness with respect to regular matrix frames then follows from the fact that sliced matrix models and regular matrix models share the same general consequence relation.

We then have a complete proof system for the general consequence relation, but not yet for the diagonal consequence relation. We define the latter in terms of the former and prove completeness.

5.2.1 Proof system

The proof system for general consequence is displayed in Table 5.1 on p. 109. It is a Hilbert-style proof system that consists of the standard axioms (A1-A10) and rules (R1-R3) for inquisitive modal logic, extended with the axioms of two-dimensional modal logic (A11-A19, Fritz 2014). The axioms for inquisitive disjunction are not relevant for the classical fragment, but we will need them when we consider the full language in Section 5.3. We will denote the proof system of general consequence by \vdash_g .

The soundness of this proof system can be shown by checking that all individual rules and axioms are sound. For (A1-A10, R1-R3), proofs can be found in Ciardelli (2016).¹¹ As for (A11-A19), it is easy to see how the properties of the respective relations in the model make them valid (e.g. $\Box\alpha \rightarrow \alpha$ and $\Diamond\alpha \rightarrow \Box\Diamond\alpha$ are valid because R_\Box is an equivalence relation).

5.2.2 Sliced matrix model

In a regular matrix model, the relation R_\blacksquare connects every pair in the domain with every pair on the diagonal D . In contrast, in a sliced matrix model, R_\blacksquare

¹⁰Note that $\blacksquare\alpha$ is equivalent to $FA\alpha$ in Davies & Humberstone (1980): in their semantics, the F (fixedly) operator quantifies over other worlds as the actual world (it is, in a sense, the vertical variant of \Box) and the A operator then considers this world as evaluation world too.

¹¹The proof system for inquisitive modal logic is presented as a natural deduction system in Ciardelli (2016), but it can be shown that the differences are immaterial. A Hilbert-style proof system for InqB is introduced in Ciardelli (2018).

Axioms	Rules
A1 $\varphi \rightarrow (\psi \rightarrow \varphi)$	R1 $\varphi, \varphi \rightarrow \psi / \psi$
A2 $(\varphi \rightarrow (\psi \rightarrow \chi)) \rightarrow ((\varphi \rightarrow \psi) \rightarrow (\varphi \rightarrow \chi))$	R2 $\varphi / \boxtimes \varphi$
A3 $\varphi \rightarrow (\psi \rightarrow (\varphi \wedge \psi))$	R3 $\boxtimes(\varphi \rightarrow \psi) / \boxtimes \varphi \rightarrow \boxtimes \psi$
A4 $(\varphi \wedge \psi) \rightarrow \varphi, (\varphi \wedge \psi) \rightarrow \psi$	
A5 $\perp \rightarrow \varphi$	
A6 $\neg\neg\alpha \rightarrow \alpha$	
A7 $\varphi \rightarrow (\varphi \vee \psi), \psi \rightarrow (\varphi \vee \psi)$	
A8 $(\varphi \rightarrow \chi) \rightarrow ((\psi \rightarrow \chi) \rightarrow ((\varphi \vee \psi) \rightarrow \chi))$	
A9 $(\alpha \rightarrow (\varphi \vee \psi)) \rightarrow ((\alpha \rightarrow \varphi) \vee (\alpha \rightarrow \psi))$	
A10 $\boxtimes(\varphi \vee \psi) \rightarrow (\boxtimes \varphi \vee \boxtimes \psi)$	
A11 $\Box\alpha \rightarrow \alpha$	$(R_{\Box}$ is reflexive)
A12 $\Diamond\alpha \rightarrow \Box\Diamond\alpha$	$(R_{\Box}$ is euclidean)
A13 $A\alpha \leftrightarrow \neg A\neg\alpha$	$(R_A$ is serial and functional)
A14 $\Box\alpha \rightarrow A\alpha$	$(R_A \subseteq R_{\Box})$
A15 $A\alpha \rightarrow \Box A\alpha$	$(R_A \circ R_{\Box} \subseteq R_A)$
A16 $\blacksquare\alpha \rightarrow \blacksquare\blacksquare\alpha$	$(R_{\blacksquare}$ is transitive)
A17 $\blacklozenge\alpha \rightarrow \blacksquare\blacklozenge\alpha$	$(R_{\blacksquare}$ is euclidean)
A18 $\blacksquare\alpha \rightarrow A\alpha$	$(R_A \subseteq R_{\blacksquare})$
A19 $\blacksquare(A\alpha \rightarrow \alpha)$	$(R_A$ is reflexive on the image of R_{\blacksquare})

Table 5.1: Proof system $\vdash_{\mathbf{g}}$ of general consequence, where α ranges only over classical formulas. Some modal rules and axioms apply to $\boxtimes \in \{\Box, A, \blacksquare\}$.

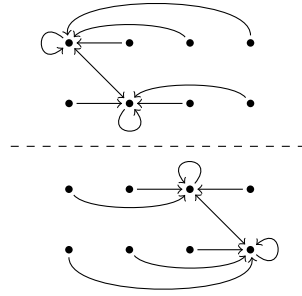

Figure 5.2: Example of a sliced matrix model. The arrows represent R_{\blacksquare} (transitive arrows omitted).

relates all pairs to *some* (not necessarily all) pairs on the diagonal.

DEFINITION 5.2.2. Sliced matrix model

A sliced matrix model M is a structure $\langle W, R_{\square}, R_A, R_{\blacksquare}, V \rangle$ where:

- R_{\blacksquare} connects pairs to some subset of D rather than to all of D :

$$\langle w, v \rangle R_{\blacksquare} \langle w', v' \rangle \Rightarrow \langle w', v' \rangle \in D$$

- Pairs are at least related to the actual pair on their own row:

$$\text{For any } w, v: \langle w, v \rangle R_{\blacksquare} \langle w, w \rangle$$

- R_{\blacksquare} is transitive and euclidean (positive and negative introspection)¹²
- All other elements of the structure are defined as in regular matrix models.

We can think of such a model as a matrix model which is divided into slices: within a slice, R_{\blacksquare} can reach all pairs on the diagonal, but it cannot reach any pair outside of the slice. Since \blacksquare is the only modality that can be used to express what is true on other rows, this means that what is true in pairs in one slice is completely independent of what is true in other slices. See Figure 5.2 for a graphical representation of a sliced matrix model.

We already introduced two consequence relations before, namely general consequence (\models_g) and diagonal consequence (\models_d). We will now introduce a third notion of consequence, namely the one defined using sliced matrix models.

¹²These constraints on the relation correspond to the idea that it is a priori whether something is a priori.

DEFINITION 5.2.3. **Sliced consequence**
 $\Phi \models_s \psi$ iff for all sliced models M and states s :
 if $M, s \models \varphi$ for all $\varphi \in \Phi$, then $M, s \models \psi$.

Note that a regular matrix model is by definition also a sliced matrix model, namely one with exactly one slice.

5.2.3 Canonical model

We will now construct a canonical model for \vdash_g . To make sure that this model has the shape of a matrix, the domain of this model will not be the set of maximally consistent sets of formulas, but the set of all pairs of these. This guarantees that there are just as many rows as there are columns, and that each row has the same amount of elements.

Let us first go through some preliminary definitions. Let T^c be the set of maximally \vdash_g -consistent sets of formulas of \mathcal{L}_1 . Then we define $W^c = T^c \times T^c$. For every set of formulas Γ , let $\Gamma_A = \{\alpha \mid A\alpha \in \Gamma\}$. It is important to note that if Γ is maximally consistent, then so is Γ_A . This is because by maximal consistency, Γ contains either $A\alpha$ or $\neg A\alpha$. In the latter case, it must also contain $A\neg\alpha$. So Γ_A contains exactly one of α and $\neg\alpha$.

As the points in the canonical model will not themselves be theories but pairs of theories, we need to say which formulas are true at each point. Thus, we need to assign a theory to each pair of theories $\langle \Gamma, \Delta \rangle$. Clearly it cannot be Γ , for then all pairs on a row would make the same formulas true. It can also not be Δ : in that case, the theory of $\langle \Gamma, \Gamma \rangle$ would be Γ . Since $\langle \Gamma, \Gamma \rangle$ is on the diagonal, we want the theory of $\langle \Gamma, \Gamma \rangle$ to be the set of formulas α such that $A\alpha$ is in the theory of $\langle \Gamma, \Delta \rangle$. But this is only the case if $\Gamma = \Delta_A$, so it will not work for arbitrary Γ and Δ . Therefore, the theory of a pair $\langle \Gamma, \Delta \rangle$ must be a possibly distinct theory, determined by Γ and Δ . We will use the following definition:

DEFINITION 5.2.4. For each $\langle \Gamma, \Delta \rangle \in W^c$, we define:

$$t(\Gamma, \Delta) = \begin{cases} \Delta & \text{if } \Gamma_A = \Delta_A \text{ and } \Gamma \neq \Delta \\ \Gamma_A & \text{otherwise} \end{cases}$$

The idea behind this definition is as follows. Any pair $\langle \Gamma, \Gamma \rangle$ must be the ‘actual pair’ in its row, but it is not guaranteed that Γ is a suitable theory for this: it may be the case that $A\alpha \leftrightarrow \alpha \notin \Gamma$. Therefore, Γ_A will be the true theory assigned to this pair. Any other element $\langle \Gamma, \Delta \rangle$ on this row can have Δ as its true theory, but only if Δ contains exactly the formulas $A\alpha$ such that α is true in the actual pair. If this is not the case, we reuse Γ_A , which makes this element a dummy

copy of the actual pair.

In this way, each pair in W^c is associated with a maximally consistent set, and conversely each maximally consistent set Γ is associated with at least one pair in the canonical model, namely $\langle \Gamma_A, \Gamma \rangle$.

We can now give the definition of the canonical model itself.

DEFINITION 5.2.5. Canonical sliced matrix model

Let $M^c = \langle W^c, R_{\square}^c, R_A^c, R_{\blacksquare}^c, V^c \rangle$, where:

- $W^c = T^c \times T^c$
- R_{\square}^c and R_A^c are defined as in any sliced matrix model
- $\langle \Gamma, \Delta \rangle R_{\blacksquare}^c \langle \Gamma', \Delta' \rangle \iff \Gamma' = \Delta' \text{ and } \{\alpha \mid \blacksquare\alpha \in \mathfrak{t}(\Gamma, \Delta)\} \subseteq \mathfrak{t}(\Gamma', \Delta')$
- $\langle \Gamma, \Delta \rangle \in V(p) \iff p \in \mathfrak{t}(\Gamma, \Delta)$

To show that the canonical model is indeed a sliced matrix model, we need to show that R_{\blacksquare}^c relates every pair to the actual pair of its row, and that it is transitive and euclidean. A simple proof using the appropriate axioms suffices to show this.

The completeness proof continues as usual, by establishing a relation between truth at a point in the canonical model and membership of that point, which in this case is mediated by \mathfrak{t} .

LEMMA 5.2.1. Truth lemma

$$M^c, \langle \Gamma, \Delta \rangle \models \alpha \iff \alpha \in \mathfrak{t}(\Gamma, \Delta)$$

Proof. By induction on the complexity of α . I give only the case for $\boxtimes\alpha$ (for $\boxtimes \in \{\square, A, \blacksquare\}$).

(\Leftarrow) Assume $\boxtimes\alpha \in \mathfrak{t}(\Gamma, \Delta)$. Then take an arbitrary pair $\langle \Gamma', \Delta' \rangle$ such that $\langle \Gamma, \Delta \rangle R_{\boxtimes}^c \langle \Gamma', \Delta' \rangle$. We need to show that $M^c, \langle \Gamma', \Delta' \rangle \models \alpha$.

- (\square) If $\square\alpha \in \mathfrak{t}(\Gamma, \Delta)$, then since $\square\alpha \rightarrow \square\square\alpha$ is derivable from (A11) and (A12), $\square\square\alpha \in \mathfrak{t}(\Gamma, \Delta)$. By axiom (A14), we have that $A\square\alpha \in \mathfrak{t}(\Gamma, \Delta)$. Then by definition of \mathfrak{t} , $\square\alpha \in \Gamma_A$. So since $\Gamma' = \Gamma$, $A\square\alpha \in \mathfrak{t}(\Gamma', \Delta')$. It follows from the axioms that $\alpha \in \mathfrak{t}(\Gamma', \Delta')$.
- (A) In this case, $\Gamma' = \Delta' = \Gamma$. If $A\alpha \in \mathfrak{t}(\Gamma, \Delta)$, then $\alpha \in \Gamma_A$. By definition of \mathfrak{t} , $\alpha \in \mathfrak{t}(\Gamma', \Delta')$.
- (\blacksquare) It follows from the definition of R_{\blacksquare}^c that $\alpha \in \mathfrak{t}(\Gamma', \Delta')$.

By the induction hypothesis, $M^c, \langle \Gamma', \Delta' \rangle \models \alpha$.

(\Rightarrow) For the left to right case, assume $\boxtimes\alpha \notin \mathfrak{t}(\Gamma, \Delta)$. Then $\neg\boxtimes\alpha \in \mathfrak{t}(\Gamma, \Delta)$. Thus we need to find some $\langle \Gamma', \Delta' \rangle$ such that $\langle \Gamma, \Delta \rangle R_{\boxtimes}^c \langle \Gamma', \Delta' \rangle$ and $M^c, \langle \Gamma', \Delta' \rangle \not\models \alpha$.

Let $\Delta^- = \{\neg\alpha\} \cup \{\beta \mid \boxtimes\beta \in \mathfrak{t}(\Gamma, \Delta)\}$. Then Δ^- is consistent. If not, then $\{\beta \mid \boxtimes\beta \in \mathfrak{t}(\Gamma, \Delta)\} \vdash_{\mathfrak{g}} \alpha$. But then $\{\boxtimes\beta \mid \boxtimes\beta \in \mathfrak{t}(\Gamma, \Delta)\} \vdash_{\mathfrak{g}} \boxtimes\alpha$, and this contradicts the assumption that $\neg\boxtimes\alpha \in \mathfrak{t}(\Gamma, \Delta)$. Let Δ' be any maximally consistent set extending Δ^- .

The next step is to show that there exists a pair $\langle \Gamma', \Delta' \rangle$ such that $\Delta' = \mathfrak{t}(\Gamma', \Delta')$ and $\langle \Gamma, \Delta \rangle R_{\boxtimes}^c \langle \Gamma', \Delta' \rangle$.

(\square) We show that $\Delta' = \mathfrak{t}(\Gamma, \Delta')$. This follows from the definition of \mathfrak{t} and the fact that $\Gamma_A = \Delta'_A$: if $\alpha \in \Gamma_A$, then $A\alpha \in \mathfrak{t}(\Gamma, \Delta)$. By maximal consistency of $\mathfrak{t}(\Gamma, \Delta)$, it follows that $\Box A\alpha \in \mathfrak{t}(\Gamma, \Delta)$. Then by construction of Δ' , $\Box A\alpha \in \Delta'$. It follows that $A\alpha \in \Delta'$ and thus $\alpha \in \Delta'_A$. Conversely, if $\alpha \notin \Gamma_A$, then $\neg\alpha \in \Gamma_A$, and from the previous part of the proof it follows that $\neg\alpha \in \Delta'_A$, so $\alpha \notin \Delta'_A$.

(A) In this case, Δ^- is already a maximally consistent set by definition. Furthermore, it is defined in such a way that $\Delta^- = \Gamma_A$. Thus $\Delta' = \Gamma_A = \mathfrak{t}(\Gamma, \Gamma)$.

(\blacksquare) By construction, Δ' contains $A\alpha \rightarrow \alpha$, thus it is easy to show that $\Delta' = \Delta'_A$. This means that $\Delta' = \mathfrak{t}(\Delta', \Delta')$, and since $\{\alpha \mid \blacksquare\alpha \in \mathfrak{t}(\Gamma, \Delta)\} \subseteq \mathfrak{t}(\Delta', \Delta')$, we have by definition of R_{\blacksquare}^c that $\langle \Gamma, \Delta \rangle R_{\blacksquare}^c \langle \Delta', \Delta' \rangle$.

Thus we have found a $\langle \Gamma', \Delta' \rangle$ such that $\langle \Gamma, \Delta \rangle R_{\boxtimes}^c \langle \Gamma', \Delta' \rangle$ and $\alpha \notin \mathfrak{t}(\Gamma', \Delta')$. By induction hypothesis it follows that $M^c, \langle \Gamma', \Delta' \rangle \not\models \alpha$. Thus $M^c, \langle \Gamma, \Delta \rangle \not\models \boxtimes\alpha$.

□

5.2.4 Completeness

Having established the truth lemma, we can prove completeness in the standard way.

THEOREM 5.2.1. Completeness wrt sliced matrix frames

$$\Gamma \models_s \alpha \Rightarrow \Gamma \vdash_{\mathfrak{g}} \alpha$$

Proof. Suppose $\Gamma \not\vdash_{\mathfrak{g}} \alpha$, then $\Gamma \cup \{\neg\alpha\}$ is consistent. So there exists a maximally consistent set Δ such that $\Gamma \subseteq \Delta$ but $\alpha \notin \Delta$. This set is equal to $\mathfrak{t}(\Delta_A, \Delta)$, thus we have a pair in the canonical model such that, by the truth lemma, $M^c, \langle \Delta_A, \Delta \rangle \models \Gamma$ but $M^c, \langle \Delta_A, \Delta \rangle \not\models \alpha$.

By finding a pair which makes Γ true and α false we also found an information state that supports Γ but not α , namely the singleton state consisting only of that pair. Therefore, $\Gamma \not\models_s \alpha$. \square

We have thereby shown that the proof system \vdash_g is complete with respect to sliced matrix models. Now we want to show that it is also complete with respect to regular matrix models. This is the case because for every pointed sliced matrix model we can find a pointed regular matrix model that satisfies exactly the same formulas.

THEOREM 5.2.2. Completeness wrt regular matrix frames

$$\Gamma \models_g \alpha \Rightarrow \Gamma \vdash_g \alpha$$

Proof. For this we only need to show that $\Gamma \models_g \alpha \Rightarrow \Gamma \models_s \alpha$. Suppose there is a sliced matrix model M and pair $\langle w_0, v_0 \rangle$ such that $M, \langle w_0, v_0 \rangle \models \gamma$ for all $\gamma \in \Gamma$ but $M, \langle w_0, v_0 \rangle \not\models \alpha$. We define the following regular matrix model M' :

- $W' = W$, $R'_\square = R_\square$, $R'_A = R_A$
- Define R'_\blacksquare as in a regular matrix model:
 $\langle w, v \rangle R'_\blacksquare \langle w', v' \rangle \iff w' = v'$
- Let $X = \{w \mid \langle w_0, v_0 \rangle R_\blacksquare \langle w, v \rangle \text{ for some } v\}$ (X is the set of worlds whose row is accessible by R_\blacksquare)

$$\bullet V'(p)(\langle w, v \rangle) = \begin{cases} V(p)(\langle w, v \rangle) & \text{if } w \in X \\ V(p)(\langle w_0, w_0 \rangle) & \text{if } w \notin X \text{ and } w = v \\ V(p)(\langle w_0, w \rangle) & \text{if } w \notin X \text{ and } v = w_0 \\ V(p)(\langle w_0, v \rangle) & \text{otherwise} \end{cases}$$

In words, if in M a row was accessible by R_\blacksquare from $\langle w_0, v_0 \rangle$, then the valuation of this row in M' is the same. If not, then the valuation of the row is copied from that of the row of $\langle w_0, v_0 \rangle$, but with two pairs swapped: the pair $\langle w, w \rangle$ is valuated like $\langle w_0, w_0 \rangle$, and the pair $\langle w, w_0 \rangle$ is valuated like $\langle w_0, w \rangle$. This ensures that the valuation of the actual pair on the new row is the same as the valuation of the actual pair on the original row. See Figure 5.3 for a graphical representation of this construction.

We can then show that $M, \langle w_0, v_0 \rangle \models \beta \iff M', \langle w_0, v_0 \rangle \models \beta$. I give a sketch of the proof, which goes by induction on the structure of formulas, the crucial case being $\blacksquare\beta$. If $M, \langle w_0, v_0 \rangle \models \blacksquare\beta$ then in all pairs $\langle w, w \rangle$ accessible by R_\blacksquare , β is true. But then β is true in all diagonal pairs in M' , since each of these is one of those pairs mentioned before or a copy of one. So $M', \langle w_0, v_0 \rangle \models \blacksquare\beta$.

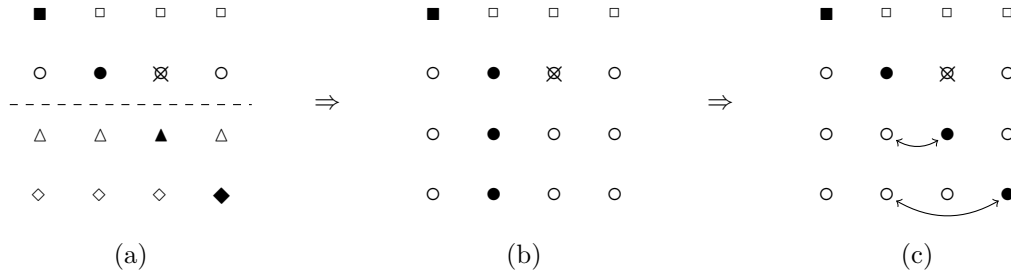

Figure 5.3: A pointed sliced matrix model (a), and a pointed matrix model (c) that satisfies the same formulas. The \times marks the pair on which the model is based. Its slice is copied entirely, rows from other slices are replaced by its own row, as shown in (b). On these copied rows, the actual pair has to switch positions so it ends up on the diagonal, as is shown in (c).

Conversely, if $M, \langle w_0, v_0 \rangle \not\models \blacksquare\beta$ then there is some accessible diagonal pair where β is false. This pair is unchanged in M' .

We have thus constructed a regular matrix model M' and pair $\langle w_0, v_0 \rangle$ that makes all of Γ true but not α . \square

5.2.5 Logic of diagonal consequence

So far we have shown that $\Gamma \models_{\mathbf{g}} \alpha \iff \Gamma \vdash_{\mathbf{g}} \alpha$, but recall that what we were after was an inference relation for diagonal consequence. We can define this as follows:

DEFINITION 5.2.6. Diagonal inference relation
 The inference relation $\vdash_{\mathbf{d}}$ for the diagonal consequence relation is defined by:

$$\Gamma \vdash_{\mathbf{d}} \alpha \iff \{A\gamma \mid \gamma \in \Gamma\} \vdash_{\mathbf{g}} A\alpha$$

By the above definition, any proof in the system $\vdash_{\mathbf{g}}$, with $A\gamma$ for all $\gamma \in \Gamma$ as premises and $A\alpha$ as conclusion, counts as a proof of α from Γ in $\vdash_{\mathbf{d}}$.

Recall that this mimics exactly the semantic relation between general consequence and diagonal consequence. Therefore, it automatically follows that this inference relation is sound and complete:

THEOREM 5.2.3. Diagonal soundness and completeness

$$\Gamma \vdash_{\mathbf{d}} \alpha \iff \Gamma \models_{\mathbf{d}} \alpha$$

Proof. Immediate by Definition 5.2.6, Fact 5.1.1 and the fact that $\mathcal{A}\alpha$ and $A\alpha$ are equivalent for classical formulas α . \square

5.3 Extending completeness to the full language

Having obtained a completeness proof for the classical fragment of Inq2D , it remains to be shown that this result can be extended to the inquisitive setting.

It is shown in Ciardelli (2016) how this can be done for any normal modal logic. Although the logic of diagonal consequence is not a normal modal logic (there are validities φ for which $\Box\varphi$ is not valid), the logic of general consequence is, which means we should again take the logic of general consequence as a starting point.

5.3.1 Proof system

The proof system $\vdash_{\mathbf{g}}$, which we introduced in Section 5.2.1, remains unchanged for now, but unlike before we will also use the axioms for inquisitive disjunction (A7-A10). We will see in Section 5.3.3 that we need one extra axiom to make the step from sliced matrix models to regular matrix models, but for the moment we will go back to working with sliced matrix models.

5.3.2 Resolutions

For the completeness proof we make use of the tight relation between inquisitive logic and classical logic, which can be sketched as follows: every formula in Inq2D can be characterized by a set of classical formulas, which are called its *resolutions*, in such a way that an information state s supports φ just in case it supports at least one of its resolutions α .

Extending the definition in Ciardelli (2016), we can define resolutions for the whole language of Inq2D as follows:

DEFINITION 5.3.1. Resolutions

- $\mathcal{R}(\alpha) = \{\alpha\}$ if α is \forall -free
- $\mathcal{R}(\varphi \wedge \psi) = \{\alpha \wedge \beta \mid \alpha \in \mathcal{R}(\varphi) \text{ and } \beta \in \mathcal{R}(\psi)\}$
- $\mathcal{R}(\varphi \rightarrow \psi) = \{\bigwedge_{\alpha \in \mathcal{R}(\varphi)} (\alpha \rightarrow f(\alpha)) \mid f \text{ is a function from } \mathcal{R}(\varphi) \text{ to } \mathcal{R}(\psi)\}$
- $\mathcal{R}(\varphi \vee \psi) = \mathcal{R}(\varphi) \cup \mathcal{R}(\psi)$
- $\mathcal{R}(\Box\varphi) = \{\bigvee_{\alpha \in \mathcal{R}(\varphi)} \Box\alpha\}$

$$\left| \begin{array}{l} \bullet \mathcal{R}(A\varphi) = \{\bigvee_{\alpha \in \mathcal{R}(\varphi)} A\alpha\} \\ \bullet \mathcal{R}(\blacksquare\varphi) = \{\bigvee_{\alpha \in \mathcal{R}(\varphi)} \blacksquare\alpha\} \end{array} \right.$$

Because φ is supported just in case one of its resolutions is, we can also say that φ is supported just in case the inquisitive disjunction of its resolutions is. This shows that any formula can be rewritten as an inquisitive disjunction of classical formulas, which we call its *normal form*:¹³

$$\left| \begin{array}{l} \text{FACT 5.3.1. Normal form} \\ \\ \varphi \equiv \bigvee \mathcal{R}(\varphi) \end{array} \right.$$

The notion of resolution can be generalized to sets of formulas Φ in the following way: we call a function $f : \Phi \rightarrow \mathcal{L}_!$ a *resolution function* of Φ if for all $\varphi \in \Phi$, $f(\varphi) \in \mathcal{R}(\varphi)$. We can then say that $\mathcal{R}(\Phi)$ is the set of sets of formulas Γ such that $\Gamma = \{f(\varphi) \mid \varphi \in \Phi\}$ for some resolution function f of Φ . Simply put, a resolution of Φ is a set of classical formulas that contains a resolution for each $\varphi \in \Phi$.

With this generalized notion of resolutions, we can obtain the following lemma:

$$\left| \begin{array}{l} \text{LEMMA 5.3.1. Semantic resolution lemma} \\ \\ \Phi \models_s \psi \iff \text{for all } \Gamma \in \mathcal{R}(\Phi) \text{ there is } \alpha \in \mathcal{R}(\psi) \text{ such that } \Gamma \models_s \alpha \end{array} \right.$$

Proof sketch. The crucial direction is from left to right. Suppose $\Phi \models_s \psi$ and take any $\Gamma \in \mathcal{R}(\Phi)$. Then Γ entails any formula in Φ , so $\Gamma \models_s \psi$. This means that $\Gamma \models_s \bigvee \mathcal{R}(\psi)$.

Now suppose towards a contradiction that there is no $\alpha \in \mathcal{R}(\psi)$ such that $\Gamma \models_s \alpha$. Then for each $\alpha \in \mathcal{R}(\psi)$ there exists a sliced model M_α and state s_α such that $M_\alpha, s_\alpha \models \gamma$ for all $\gamma \in \Gamma$ but $M_\alpha, s_\alpha \not\models \alpha$.

Then from these sliced models we can construct a new sliced model M , the domain of which is $W' \times W'$, where W' is the disjoint union of the worlds of all original models M_α for $\alpha \in \mathcal{R}(\psi)$. We define $V(\langle w, v \rangle)$ as $V_\alpha(\langle w, v \rangle)$ if $\langle w, v \rangle$ is a pair in M_α , and as $V_\alpha(\langle w, w \rangle)$ otherwise. As R_\blacksquare we take the union of all R_\blacksquare^α , and the other relations are defined as normal. Let s be the union of the states s^α .

Then a simple proof by induction on the structure of formulas shows that the formulas which s of M supports are the formulas that all individual states s_α out of which it was built support. Thus we have $M, s \models \gamma$ for all $\gamma \in \Gamma$ and $M, s \not\models \alpha$ for all $\alpha \in \mathcal{R}(\psi)$. So $M, s \not\models \psi$. As this contradicts the assumption that $\Gamma \models_s \psi$, we are done. \square

¹³See Proposition 6.3.13 in Ciardelli (2016).

In the proof above, the step in which we construct a new model out of several models, while maintaining the same supported formulas, is not available in regular matrix models. In these models, the truth value of $\blacksquare\alpha$ may change as the model gets bigger, because diagonal pairs become accessible that previously weren't. Thus, the semantic resolution lemma does not hold for the general consequence relation $\models_{\mathbf{g}}$.¹⁴ This is why we again need to make a detour through sliced matrix models.

The resolution lemma holds on the syntactic side as well:

LEMMA 5.3.2. Syntactic resolution lemma

$$\Phi \vdash_{\mathbf{g}} \psi \iff \text{for all } \Gamma \in \mathcal{R}(\Phi) \text{ there is } \alpha \in \mathcal{R}(\psi) \text{ such that } \Gamma \vdash_{\mathbf{g}} \alpha$$

Proof. The left to right direction is Lemma 6.4.12 of Ciardelli (2016). The other direction follows immediately from his Lemma 6.4.14 and 6.4.19. \square

These two lemmas can be connected by the fact that $\vdash_{\mathbf{g}}$ is sound and complete for the classical fragment, which we have already shown. Thus we obtain:

THEOREM 5.3.1. Soundness and completeness wrt sliced frames

$$\Phi \models_s \psi \iff \Phi \vdash_{\mathbf{g}} \psi$$

5.3.3 Regular matrix frames

The next step is to obtain a proof system that is complete with respect to regular matrix frames. Recall that when we proved completeness for the classical fragment, we could use the fact that sliced matrix models and regular matrix models share the same consequence relation. However, this is no longer the case when we consider the full language.

A counterexample is $? \blacksquare p$. A state s can fail to support this formula in a sliced matrix model: if s contains worlds from more than one slice, p may be a priori in some worlds, but not in others. This is not possible in a regular matrix model, as we have already seen in Section 5.1.5. There, whether something is a priori cannot differ from world to world: if something is a priori, it is a priori everywhere. Thus, $? \blacksquare p$ is a validity in these models.

In fact, the class of regular matrix frames is exactly the class of sliced frames on which $? \blacksquare p$ is valid. We only need to add the axiom schema $? \blacksquare \alpha$ to obtain completeness with respect to regular matrix frames.

Define $\vdash_{\mathbf{g}'}$ as the proof system consisting of the axioms and rules in (A1-A19,

¹⁴Note that this follows from the fact that the disjunction property fails, see Section 5.1.5.

R1-R3) and (A20):¹⁵

A20 ? \blacksquare α

Recall that $\models_{\mathbf{g}}$ is the consequence relation in which we consider only models in which R_{\blacksquare} makes the whole diagonal accessible, while $\models_{\mathbf{s}}$ is the consequence relation based on sliced matrix models. To prove completeness, we need to show the following lemma.

LEMMA 5.3.3. Let $\Delta_{A20} = \{?\blacksquare\alpha \mid \alpha \in \mathcal{L}\}$.

$$\Phi \models_{\mathbf{g}} \psi \Rightarrow \Phi, \Delta_{A20} \models_{\mathbf{s}} \psi$$

Proof. Suppose we have a sliced model and a state M, s such that $M, s \models \Phi$, $M, s \models \Delta_{A20}$ and $M, s \not\models \psi$. Now let M' be the same model as M but with R_{\blacksquare} defined as in a regular matrix model. It can be shown by induction that every state in M' supports exactly the same formulas as the same state in M .

We can show this by induction on the normal form of formula's, and we show the inductive step for \blacksquare as the others are trivial. So we need to show that $M, s \models \blacksquare\alpha \iff M', s \models \blacksquare\alpha$. The right to left direction is trivial, so assume $M', s \not\models \blacksquare\alpha$. Then there is some $\langle w, w \rangle \in D$ such that $M', \langle w, w \rangle \not\models \alpha$. By induction hypothesis, $M, \langle w, w \rangle \not\models \alpha$. But then $M, \langle w, w \rangle \not\models \blacksquare\alpha$ and since $M \models \Delta_{A20}$, we have $M \models \blacksquare\alpha \vee \neg\blacksquare\alpha$. So we must have that all information states in M support $\neg\blacksquare\alpha$ and therefore $M, s \not\models \blacksquare\alpha$.

So we found a regular matrix model M', s that satisfies Φ but not ψ . \square

We then have a complete proof system $\vdash_{\mathbf{g}'}$ for the general consequence relation of the class of regular matrix frames:

COROLLARY 5.3.1. **Completeness wrt regular matrix frames**

$$\Phi \models_{\mathbf{g}} \psi \Rightarrow \Phi \vdash_{\mathbf{g}'} \psi$$

Proof. Suppose $\Phi \models_{\mathbf{g}} \psi$. By Lemma 5.3.3, we obtain $\Phi, \Delta_{A20} \models_{\mathbf{s}} \psi$. By Theorem 5.3.1 we have that $\Phi, \Delta_{A20} \vdash_{\mathbf{g}} \psi$. Since all formulas in Δ_{A20} are axioms in $\vdash_{\mathbf{g}'}$, it follows that $\Phi \vdash_{\mathbf{g}'} \psi$. \square

¹⁵Because $?\blacksquare\varphi$ is valid also for non-classical φ , we could make the axiom schema more general. However, this is not required for completeness.

5.3.4 Logic of diagonal consequence

We have shown that $\Phi \models_{\mathbf{g}} \psi \iff \Phi \vdash_{\mathbf{g}'} \psi$, but we still need an inference relation for diagonal consequence. The definition we gave for the classical fragment only needs a minor revision:

DEFINITION 5.3.2. Diagonal inference relation

The inference relation $\vdash_{\mathbf{d}}$ for the diagonal consequence relation is defined by:

$$\Phi \vdash_{\mathbf{d}} \psi \iff \{\mathcal{A}\varphi \mid \varphi \in \Phi\} \vdash_{\mathbf{g}'} \mathcal{A}\psi$$

This generalizes the previous definition to the full inquisitive language: now, any proof in the system $\vdash_{\mathbf{g}'}$, with $\mathcal{A}\varphi$ for all $\varphi \in \Phi$ as premises and $\mathcal{A}\psi$ as conclusion, counts as a proof of ψ from Φ in $\vdash_{\mathbf{d}}$.

Then we can show that the logic of diagonal consequence is sound and complete.

THEOREM 5.3.2. Diagonal soundness and completeness

$$\Phi \vdash_{\mathbf{d}} \psi \iff \Phi \models_{\mathbf{d}} \psi$$

Proof. Immediate by Fact 5.1.1 □

5.4 Conclusion

Apart from giving an alternative completeness proof for the classical two-dimensional logic in Fritz (2014), we have shown that the logic can be extended in a natural way to a setting in which questions play a role: this allows us to express questions and statements about the apriority, necessity and actuality of questions as well as statements. We have observed that **Inq2D** does not have the disjunction property. This is caused by the fact that the question whether a formula is a priori is valid on any model, even though models can differ in whether they make this formula a priori or not. We have given a sound and complete proof system for **Inq2D**.

Some extensions of this system are already suggested in the other chapters of this thesis. An extension in the spirit of Chapter 4 would be to add a knowledge operator K and investigate the interaction between apriority, necessity and knowledge. Furthermore, we could add its inquisitive counterpart, the ‘entertain’ operator E , which is sensitive to issues. These additions are no obstacle for completeness, since the completeness proof of inquisitive epistemic logic in Ciardelli (2016, Chapter 7) includes this operator as well.

A more difficult challenge would be to extend the system to the first-order

setting: as of yet, it is unknown whether it is possible to give a sound and complete proof system for basic first-order inquisitive logic, although there are completeness proofs for interesting fragments (see Ciardelli, 2016, Chapter 4 and Grilletti, 2020) that could be extended to the two-dimensional setting.

Bibliography

- Aloni, M. (2001). *Quantification under conceptual covers*. Ph.D. thesis, University of Amsterdam.
- (2016). 'You' and 'I' in modal logic. *Grazer Philosophische Studien*, 93(1989), 1–26.
- Aloni, M. , Egré, P. , & Jäger, T. de (2013). Knowing whether A or B. *Synthese*, 190(14), 2595–2621.
- Anand, P. (2006). *De De Se*. Ph.D. thesis, MIT.
- Anand, P. , & Nevins, A. (2004). Shifty Operators in Changing Contexts. In R. Young (Ed.) *Proceedings of Semantics and Linguistic Theory 14*, (pp. 20–37). Cornell University: CLC Publications.
- AnderBois, S. (2012). Focus and un informativity in Yukatek Maya questions. *Natural Language Semantics*, 20, 349–390.
- Anvari, A. (2019). *Meaning in Context*. Ph.D. thesis, Ecole Normale Supérieure, Paris.
- Cappelen, H. , & Dever, J. (2013). *The Inessential Indexical: On the Philosophical Insignificance of Perspective and the First Person*. Oxford University Press.
- Carnap, R. (1956). *Meaning and Necessity: a Study in Semantic and Modal Logic*. University of Chicago Press.
- Chalmers, D. J. (2002). On sense and intension. *Philosophical Perspectives*, 16, *Language and Mind*, 135–182.
- (2004). Epistemic two-dimensional semantics. *Philosophical Studies*, 118, 153–226.
- (2011). Propositions and attitude ascriptions: A Fregean account. *Noûs*, 45(4), 595–639.

- Champollion, L. , Ciardelli, I. , & Roelofsen, F. (2015). Some questions in typed inquisitive semantics. Talk at workshop on Questions in Logic and Semantics, Amsterdam.
- Chierchia, G. (1989). Anaphora and attitudes *de se*. In R. Bartsch, J. van Benthem, & P. van Emde Boas (Eds.) *Semantics and Contextual Expressions*. Dordrecht: Foris.
- Ciardelli, I. (2010). A first-order inquisitive semantics. In M. Aloni, H. Bastiaanse, T. de Jager, & K. Schulz (Eds.) *Logic, Language, and Meaning: Selected Papers from the Seventeenth Amsterdam Colloquium*, (pp. 234–243). Springer.
- (2016). *Questions in Logic*. Ph.D. thesis, University of Amsterdam.
- (2018). Dependence statements are strict conditionals. In G. Bezhanishvili, G. D’Agostino, G. Metcalfe, & T. Studer (Eds.) *Advances in Modal Logic (AIML)*, (pp. 123–142). London: College Publications.
- Ciardelli, I. , Groenendijk, J. , & Roelofsen, F. (2012). Inquisitive semantics. NASSLLI lecture notes, available via projects.illc.uva.nl/inquisitivesemantics.
- (2019). *Inquisitive Semantics*. Oxford University Press.
- Ciardelli, I. , & Roelofsen, F. (2011). Inquisitive Logic. *Journal of Philosophical Logic*, 40(1), 55–94.
- (2015). Inquisitive dynamic epistemic logic. *Synthese*, 192(6), 1643–1687.
- (2017). Hurford’s constraint, the semantics of disjunctions, and the nature of alternatives. *Natural Language Semantics*, 25(3), 199–222.
- (2018). An inquisitive perspective on modals and quantifiers. *Annual Review of Linguistics*, 4, 129–149.
- Ciardelli, I. , Roelofsen, F. , & Theiler, N. (2017). Composing alternatives. *Linguistics and Philosophy*, 40(1), 1–36.
- Cresswell, M. (1990). *Entities and Indices*. Dordrecht: Kluwer Academic Publishers.
- Crossley, J. N. , & Humberstone, L. (1977). The logic of “actually”. *Reports on Mathematical Logic*.
- Cumming, S. (2008). Variabilism. *Philosophical Review*, 117(4), 525–554.
- Davidson, D. (1967). Truth and meaning. *Synthese*, 17(3), 304–323.

- Davies, M. , & Humberstone, L. (1980). Two notions of necessity. *Philosophical Studies*, 38(1), 1–30.
- Dayal, V. (1996). *Locality in Wh-quantification: Questions and Relative Clauses in Hindi*. Dordrecht: Kluwer Academic Publishers.
- Deal, A. R. (2017). Shifty asymmetries: Universals and variation in shifty indexicality. Manuscript. Berkeley: University of California.
- Dotlačil, J. , & Roelofsen, F. (2019). Dynamic inquisitive semantics: Anaphora and questions. In M. Espinal, E. Castroviejo, M. Leonetti, L. McNally, & C. Real-Puigdollers (Eds.) *Proceedings of Sinn und Bedeutung 23*, (pp. 365–382).
- Elliott, P. D. , Klinedinst, N. , Sudo, Y. , & Uegaki, W. (2017). Predicates of relevance and theories of question embedding. *Journal of Semantics*, 34(3), 547–554.
- Fine, K. (2002). The varieties of necessity. In T. S. Gendler, & J. Hawthorne (Eds.) *Conceivability and Possibility*, (pp. 253–281). Oxford: Oxford University Press.
- Fintel, K. von , & Heim, I. (2011). Intensional semantics. Lecture notes, MIT.
- Frege, G. (1879). *Begriffsschrift, eine der arithmetischen nachgebildete Formelsprache des reinen Denkens*. Halle: Verlag von Louis Nebert. Republished and translated in *Conceptual Notation and Related Articles*, edited by Terrell Ward Bynum. Oxford: Clarendon Press.
- (1892). Über Sinn und Bedeutung. *Zeitschrift für Philosophie und philosophische Kritik*, 100, 25–50. Translated as *On Sense and Reference* by M. Black in *Translations from the Philosophical Writings of Gottlob Frege*, P. Geach and M. Black (eds. and trans.), Oxford: Blackwell, third edition, 1980.
- Fritz, P. (2013). A logic for epistemic two-dimensional semantics. *Synthese*, 190(10), 1753–1770.
- (2014). What is the correct logic of necessity, actuality and apriority? *Review of Symbolic Logic*, 7(3), 385–414.
- George, B. (2011). *Question embedding and the semantics of answers*. Ph.D. thesis, University of California, Los Angeles.
- Gibbard, A. (1975). Contingent identity. *Journal of Philosophical Logic*, 4(2), 187–221.

- Ginzburg, J. (1995). Resolving questions, I. *Linguistics and Philosophy*, 18(5), 459–527.
- Grilletti, G. (2019). Disjunction and Existence Properties in Inquisitive First-Order Logic. *Studia Logica*, 107, 1199–1234.
- (2020). Completeness for the classical antecedent fragment of inquisitive first-order logic. Manuscript, University of Amsterdam. http://ggrilletti.scienceontheweb.net/wp-content/uploads/2019/06/clant_v6.pdf
- Groenendijk, J. (2009). Inquisitive semantics: Two Possibilities for Disjunction. In P. Bosch, D. Gabelaia, & J. Lang (Eds.) *Seventh International Tbilisi Symposium on Language, Logic, and Computation*. Springer-Verlag.
- Groenendijk, J. , & Stokhof, M. (1984). *Studies on the Semantics of Questions and the Pragmatics of Answers*. Ph.D. thesis, University of Amsterdam.
- (1991). Dynamic predicate logic. *Linguistics and Philosophy*, 14, 39–100.
- Haas-Spohn, U. (1995). *Versteckte Indexikalität und subjektive Bedeutung*. Ph.D. thesis, Universität Tübingen.
- Hamblin, C. L. (1973). Questions in Montague English. *Foundations of Language*, 10(1), 41–53.
- Hausser, R. , & Zaefferer, D. (1978). Questions and answers in a context-dependent Montague grammar. In F. Guenther, & S. J. Schmidt (Eds.) *Formal Semantics and Pragmatics for Natural Languages*, (pp. 339–358). Dordrecht: Reidel.
- Heim, I. (1982). *The Semantics of Definite and Indefinite Noun Phrases*. Ph.D. thesis, University of Massachusetts, Amherst.
- (1994). Interrogative semantics and Karttunen’s semantics for *know*. In R. Buchalla, & A. Mittwoch (Eds.) *The Proceedings of the Ninth Annual Conference and the Workshop on Discourse of the Israel Association for Theoretical Linguistics*. Jerusalem: Academon.
- Hintikka, J. (1969). Semantics for propositional attitudes. In *Models for Modalities: Selected Essays*, (pp. 87–111). Dordrecht: Springer.
- Hunter, J. , & Asher, N. (2005). A presuppositional account of indexicals. In P. Dekker, & M. Franke (Eds.) *Proceedings of the Fifteenth Amsterdam Colloquium*, (pp. 119–124).
- Israel, D. , & Perry, J. (1996). Where Monsters Dwell. In J. Seligman, & D. Westerstahl (Eds.) *Logic, Language and Computation*, vol. 1, (pp. 303–316). Stanford, CA.: CSLI Publications.

- Jackson, F. (1998). *From Metaphysics to Ethics: a Defence of Conceptual Analysis*. Oxford: Clarendon Press.
- Kamp, H. (1971). Formal Properties of 'Now'. *Theoria*, 13, 227–273.
- (1981). A theory of truth and semantic representation. In J. Groenendijk, T. Janssen, & M. Stokhof (Eds.) *Formal Methods in the Study of Language*, (pp. 277–322). Amsterdam: Mathematical Centre.
- Kaplan, D. (1979). On the Logic of Demonstratives. *Journal of Philosophical Logic*, 8(1), 81–98.
- (1989). Demonstratives. In J. Almog, J. Perry, & H. Wettstein (Eds.) *Themes from Kaplan*, (pp. 481–563). Oxford University Press.
- Karttunen, L. (1977). Syntax and Semantics of Questions. *Linguistics and philosophy*, 1(1), 3–44.
- Kocurek, A. (2018). Counteridenticals. *Philosophical Review*, 127(3), 1–38.
- Kripke, S. (1971). Identity and Necessity. In M. K. Munitz (Ed.) *Identity and Individuation*, (pp. 135–164). New York University Press.
- (1980). *Naming and necessity*. Harvard University Press.
- Lahiri, U. (2002). *Questions and Answers in Embedded Contexts*. Oxford University Press.
- Lewis, D. K. (1980). Index, context, and content. In S. Kanger, & S. Öhman (Eds.) *Philosophy and Grammar*, (pp. 79–100). Dordrecht: D. Reidel Publishing Company.
- Lewis, D. (1970). General semantics. *Synthese*, 22, 18–67.
- (1979). Attitudes De Dicto and De Se. *Source: The Philosophical Review*, 88(4), 513–543.
- (1982). 'whether' report. In T. Pauli (Ed.) *Philosophical Essays Dedicated to Lennart Åqvist on his Fiftieth Birthday*, (pp. 194–206). University of Uppsala Press.
- Magidor, O. (2015). The myth of the de se. *Philosophical Perspectives*, 29, 249–283.
- Maier, E. (2009). Proper names and indexicals trigger rigid presuppositions. *Journal of Semantics*, 26(3), 253–315.

- Mascarenhas, S. (2009). Inquisitive semantics and logic. MSc thesis, University of Amsterdam.
- Mayr, C. (2019). Triviality and interrogative embedding: context sensitivity, factivity, and neg-raising. *Natural Language Semantics*, 27(3), 227–278.
- Morgan, J. (1970). On the criterion of identity for noun phrase deletion. In *Papers from the Sixth Regional Meeting, Chicago Linguistic Society*, (pp. 380–389). Chicago Linguistic Society.
- Ninan, D. (2010). De Se Attitudes : Ascription and Communication. *Philosophy Compass*, 5(7), 551–567.
- Nolan, D. (2011). The Extent of Metaphysical Necessity. *Philosophical Perspectives*, 25, 311–339.
- Nunberg, G. (1993). Indexicality and Deixis. *Linguistics and Philosophy*, 16, 1–43.
- Perry, J. (1977). Frege on Demonstratives. *The Philosophical Review*, 86(4), 474–497.
- (1979). The Problem of the Essential Indexical. *Noûs*, 13, 3–21.
- Quine, W. V. O. (1956). Quantifiers and propositional attitudes. *Journal of Philosophy*, 53(5), 177–187.
- Rabern, B. (2013). Monsters in Kaplan’s logic of demonstratives. *Philosophical Studies*, 164, 393–404.
- Roberts, C. (1996). Information structure in discourse. In J. Yoon, & A. Kathol (Eds.) *OSU Working Papers in Linguistics*, vol. 49, (pp. 91–136). Ohio State University.
- Roelofsen, F. (2013). Algebraic foundations for the semantic treatment of inquisitive content. *Synthese*, 190(1), 79–102.
- (2019). Semantic theories of questions. Oxford Research Encyclopedia of Linguistics.
- Rooij, R. van (2003). Questioning to resolve decision problems. *Linguistics and Philosophy*, 26(6), 727–763.
- Rothschild, D. (2013). Worrying about Trivial Questions. *University College London Working Papers in Linguistics*, 24, 94–108.

- Rullmann, H. , & Beck, S. (1998). Presupposition projection and the interpretation of which questions. In D. Strolovitch, & A. Lawson (Eds.) *Semantics and Linguistic Theory (SALT 8)*, (pp. 215–232).
- Santorio, P. (2012). Reference and Monstrosity. *Philosophical Review*, 121(3), 359–406.
- Schlenker, P. (1999). *Propositional Attitudes and Indexicality: A Cross-Categorical Approach*. Ph.D. thesis, MIT.
- (2003). A plea for monsters. *Linguistics and Philosophy*, 26(1), 29–120.
- (2011). Indexicality and De Se Reports. In K. von Stechow, P. Portner, & C. Maienborn (Eds.) *Semantics: An international handbook of natural language meaning 2*. De Gruyter Mouton.
- (2018). Indexicals. In S. Hansson, & V. Hendricks (Eds.) *Introduction to Formal Philosophy*, (pp. 297–321). Cham: Springer.
- Schwarz, W. (2013). Contingent Identity. *Philosophy Compass*, 8(5), 486–495.
- Spector, B. , & Egré, P. (2015). A uniform semantics for embedded interrogatives: An answer, not necessarily the answer. *Synthese*, 192(6), 1729–1784.
- Stalnaker, R. (1978). Assertion. In P. Cole (Ed.) *Syntax and Semantics, vol. 9: Pragmatics*, (pp. 315–332). New York: Academic Press.
- (1981). Indexical belief. *Synthese*, 49, 129–151.
- Stechow, A. von (1982). Structured propositions. Technical Report 59, Sonderforschungsbereich 99, Universität Konstanz.
- Stephenson, T. (2002). *Towards a Theory of Subjective Meaning*. Ph.D. thesis, MIT.
- Strawson, P. F. (1950). On referring. *Mind*, 59, 320–44.
- Theiler, N. (2014). A multitude of answers: Embedded questions in typed inquisitive semantics. MSc thesis, University of Amsterdam.
- Theiler, N. , Roelofsen, F. , & Aloni, M. (2018). A uniform semantics for declarative and interrogative complements. *Journal of Semantics*, 35(3), 409–466.
- (2019). Picky predicates: Why *believe* doesn't like interrogative complements, and other puzzles. *Natural Language Semantics*, 27(2), 95–134.
- Uegaki, W. (2015). *Interpreting Questions under Attitudes*. Ph.D. thesis, Massachusetts Institute of Technology.

- (2019). The semantics of question-embedding predicates. *Language and Linguistics Compass*, 13(1), 1–17.
- Uegaki, W. , & Sudo, Y. (2019). The **hope-wh* puzzle. *Natural Language Semantics*, 27(4), 323–356.
- Velissaratou, S. (2000). Conditional questions and which-interrogatives. MSc Thesis, University of Amsterdam.
- Williamson, T. (2016). Modal science. *Canadian Journal of Philosophy*, 46(4-5), 453–492.
- Wittgenstein, L. (1922). *Tractatus Logico-Philosophicus*. London: Routledge & Kegan Paul. Translation by C.K. Ogden. Reprinted by Dover Publications, 1999.
- Yalcin, S. (2015). Actually, actually. *Analysis*, 75(2), 185–191.

Samenvatting

Vragen in Context

Volgens het traditionele beeld in de semantiek is de betekenis van een zin gegeven door zijn waarheidscondities: die geven aan hoe de wereld eruit moet zien als de zin waar is. Deze dissertatie gaat over twee fenomenen die beide een verfijning van dit beeld vereisen: indexicaliteit en vragen.

Waar indexicale expressies zoals ‘ik’, ‘jij’, ‘hier’ en ‘nu’ naar refereren hangt af van de context waarin ze worden gebruikt. Hierdoor kunnen de waarheidscondities van zinnen waarin indexicale expressies voorkomen verschillen per context. Vragen vormen een andere uitdaging: omdat die niet waar of onwaar zijn, kan hun betekenis niet gegeven worden in termen van waarheidscondities.

Wat deze dissertatie laat zien is dat indexicaliteit en vragen, die tot nu toe alleen afzonderlijk van elkaar zijn bestudeerd, interessante wisselwerkingen met elkaar hebben. Een expressie is normaal gesproken contextafhankelijk als wat ermee gezegd wordt verschilt per context. Vragen kunnen echter ook op een andere manier contextafhankelijk zijn. Bijvoorbeeld, wat gevraagd wordt met ‘Wie ben ik?’ verschilt niet per context, maar bevraagt juist de context. Een ander fenomeen waarin vragen uniek zijn is dat ze indexicale antwoorden kunnen vereisen, terwijl ze zelf niet indexicaal zijn: in sommige omstandigheden moet de vraag ‘Waar is de gids?’ geïnterpreteerd worden als ‘Is de gids voor of achter ons?’ in plaats van ‘Wat is de absolute positie van de gids?’.

Deze dissertatie ontwikkelt een semantisch raamwerk dat deze observaties kan verklaren. Dit wordt gedaan door inzichten van twee tradities in de semantiek-literatuur te combineren: aan de ene kant, twee-dimensionale semantiek, waarin contextafhankelijkheid wordt behandeld, en aan de andere kant inquisitieve semantiek, een theorie die is ontworpen om op een uniforme manier met vragende en declaratieve zinnen om te gaan. Het resulterende raamwerk kan gebruikt worden om te laten zien hoe vragen over zaken als identiteit, die geacht worden noodzakelijk te zijn, toch cognitief significant kunnen zijn, en hoe vragen die *a priori* beantwoord kunnen worden over contingente feiten kunnen gaan. De logische eigenschappen van de basisversie van dit raamwerk worden onderzocht, en een correcte en volledige axiomatisering van de logica wordt gegeven.

Summary

Questions in Context

According to the traditional picture in semantics, the meaning of a sentence is given by its truth conditions: they state what the world has to be like for the sentence to be true. This dissertation is about two phenomena that both require a refinement of this picture: indexicality and questions.

What indexical expressions like ‘I’, ‘you’, ‘here’ or ‘now’ refer to depends on the context in which they are used. As a consequence, the truth conditions of sentences in which indexical expressions appear may vary between contexts of use. Questions pose a different challenge: because they are not true or false, their meaning cannot be given in terms of truth conditions.

What is shown in this dissertation is that indexicality and questions, which so far have only been studied in isolation, interact in interesting ways. According to the standard analysis, an expression is context-sensitive if what is said by it depends on the context. Questions can be context-sensitive in a different way too. For instance, what is asked by ‘Who am I?’ does not vary between contexts, but rather makes the context an object of inquiry. Another phenomenon unique to questions is that they can require indexical answers, while being non-indexical themselves: in some circumstances, the question ‘Where is the guide?’ should be interpreted as ‘Is the guide in front of us or behind us?’ rather than ‘What is the absolute position of the guide?’.

This dissertation develops a semantic framework that can account for these observations. It does so by combining insights from two traditions in the semantic literature: on the one hand, two-dimensional semantics, which provides an account of context-sensitivity, and on the other hand inquisitive semantics, which is designed to deal with questions and statements in a uniform way. The resulting framework can be used to show how questions about facts like identity, which have been argued to be necessary, can be cognitively significant, and how questions that can be answered *a priori* can be about contingent facts. The logical properties of the basic version of this framework are investigated, and a sound and complete axiomatization for the logic is given.

Titles in the ILLC Dissertation Series:

- ILLC DS-2009-01: **Jakub Szymanik**
Quantifiers in TIME and SPACE. Computational Complexity of Generalized Quantifiers in Natural Language
- ILLC DS-2009-02: **Hartmut Fitz**
Neural Syntax
- ILLC DS-2009-03: **Brian Thomas Semmes**
A Game for the Borel Functions
- ILLC DS-2009-04: **Sara L. Uckelman**
Modalities in Medieval Logic
- ILLC DS-2009-05: **Andreas Witzel**
Knowledge and Games: Theory and Implementation
- ILLC DS-2009-06: **Chantal Bax**
Subjectivity after Wittgenstein. Wittgenstein's embodied and embedded subject and the debate about the death of man.
- ILLC DS-2009-07: **Kata Balogh**
Theme with Variations. A Context-based Analysis of Focus
- ILLC DS-2009-08: **Tomohiro Hoshi**
Epistemic Dynamics and Protocol Information
- ILLC DS-2009-09: **Olivia Ladinig**
Temporal expectations and their violations
- ILLC DS-2009-10: **Tikitu de Jager**
"Now that you mention it, I wonder...": Awareness, Attention, Assumption
- ILLC DS-2009-11: **Michael Franke**
Signal to Act: Game Theory in Pragmatics
- ILLC DS-2009-12: **Joel Uckelman**
More Than the Sum of Its Parts: Compact Preference Representation Over Combinatorial Domains
- ILLC DS-2009-13: **Stefan Bold**
Cardinals as Ultrapowers. A Canonical Measure Analysis under the Axiom of Determinacy.
- ILLC DS-2010-01: **Reut Tsarfaty**
Relational-Realizational Parsing

- ILLC DS-2010-02: **Jonathan Zvesper**
Playing with Information
- ILLC DS-2010-03: **Cédric Dégrement**
The Temporal Mind. Observations on the logic of belief change in interactive systems
- ILLC DS-2010-04: **Daisuke Ikegami**
Games in Set Theory and Logic
- ILLC DS-2010-05: **Jarmo Kontinen**
Coherence and Complexity in Fragments of Dependence Logic
- ILLC DS-2010-06: **Yanjing Wang**
Epistemic Modelling and Protocol Dynamics
- ILLC DS-2010-07: **Marc Staudacher**
Use theories of meaning between conventions and social norms
- ILLC DS-2010-08: **Amélie Gheerbrant**
Fixed-Point Logics on Trees
- ILLC DS-2010-09: **Gaëlle Fontaine**
Modal Fixpoint Logic: Some Model Theoretic Questions
- ILLC DS-2010-10: **Jacob Vosmaer**
Logic, Algebra and Topology. Investigations into canonical extensions, duality theory and point-free topology.
- ILLC DS-2010-11: **Nina Gierasimczuk**
Knowing One's Limits. Logical Analysis of Inductive Inference
- ILLC DS-2010-12: **Martin Mose Bentzen**
Stit, It, and Deontic Logic for Action Types
- ILLC DS-2011-01: **Wouter M. Koolen**
Combining Strategies Efficiently: High-Quality Decisions from Conflicting Advice
- ILLC DS-2011-02: **Fernando Raymundo Velazquez-Quesada**
Small steps in dynamics of information
- ILLC DS-2011-03: **Marijn Koolen**
The Meaning of Structure: the Value of Link Evidence for Information Retrieval
- ILLC DS-2011-04: **Junte Zhang**
System Evaluation of Archival Description and Access

- ILLC DS-2011-05: **Lauri Keskinen**
Characterizing All Models in Infinite Cardinalities
- ILLC DS-2011-06: **Rianne Kaptein**
Effective Focused Retrieval by Exploiting Query Context and Document Structure
- ILLC DS-2011-07: **Jop Briët**
Grothendieck Inequalities, Nonlocal Games and Optimization
- ILLC DS-2011-08: **Stefan Minica**
Dynamic Logic of Questions
- ILLC DS-2011-09: **Raul Andres Leal**
Modalities Through the Looking Glass: A study on coalgebraic modal logic and their applications
- ILLC DS-2011-10: **Lena Kurzen**
Complexity in Interaction
- ILLC DS-2011-11: **Gideon Borensztajn**
The neural basis of structure in language
- ILLC DS-2012-01: **Federico Sangati**
Decomposing and Regenerating Syntactic Trees
- ILLC DS-2012-02: **Markos Mylonakis**
Learning the Latent Structure of Translation
- ILLC DS-2012-03: **Edgar José Andrade Lotero**
Models of Language: Towards a practice-based account of information in natural language
- ILLC DS-2012-04: **Yurii Khomskii**
Regularity Properties and Definability in the Real Number Continuum: idealized forcing, polarized partitions, Hausdorff gaps and mad families in the projective hierarchy.
- ILLC DS-2012-05: **David García Soriano**
Query-Efficient Computation in Property Testing and Learning Theory
- ILLC DS-2012-06: **Dimitris Gakis**
Contextual Metaphilosophy - The Case of Wittgenstein
- ILLC DS-2012-07: **Pietro Galliani**
The Dynamics of Imperfect Information

- ILLC DS-2012-08: **Umberto Grandi**
Binary Aggregation with Integrity Constraints
- ILLC DS-2012-09: **Wesley Halcrow Holliday**
Knowing What Follows: Epistemic Closure and Epistemic Logic
- ILLC DS-2012-10: **Jeremy Meyers**
Locations, Bodies, and Sets: A model theoretic investigation into nominalistic mereologies
- ILLC DS-2012-11: **Floor Sietsma**
Logics of Communication and Knowledge
- ILLC DS-2012-12: **Joris Dormans**
Engineering emergence: applied theory for game design
- ILLC DS-2013-01: **Simon Pauw**
Size Matters: Grounding Quantifiers in Spatial Perception
- ILLC DS-2013-02: **Virginie Fiutek**
Playing with Knowledge and Belief
- ILLC DS-2013-03: **Giannicola Scarpa**
Quantum entanglement in non-local games, graph parameters and zero-error information theory
- ILLC DS-2014-01: **Machiel Keestra**
Sculpting the Space of Actions. Explaining Human Action by Integrating Intentions and Mechanisms
- ILLC DS-2014-02: **Thomas Icard**
The Algorithmic Mind: A Study of Inference in Action
- ILLC DS-2014-03: **Harald A. Bastiaanse**
Very, Many, Small, Penguins
- ILLC DS-2014-04: **Ben Rodenhäuser**
A Matter of Trust: Dynamic Attitudes in Epistemic Logic
- ILLC DS-2015-01: **María Inés Crespo**
Affecting Meaning. Subjectivity and evaluativity in gradable adjectives.
- ILLC DS-2015-02: **Mathias Winther Madsen**
The Kid, the Clerk, and the Gambler - Critical Studies in Statistics and Cognitive Science

- ILLC DS-2015-03: **Shengyang Zhong**
Orthogonality and Quantum Geometry: Towards a Relational Reconstruction of Quantum Theory
- ILLC DS-2015-04: **Sumit Sourabh**
Correspondence and Canonicity in Non-Classical Logic
- ILLC DS-2015-05: **Facundo Carreiro**
Fragments of Fixpoint Logics: Automata and Expressiveness
- ILLC DS-2016-01: **Ivano A. Ciardelli**
Questions in Logic
- ILLC DS-2016-02: **Zoé Christoff**
Dynamic Logics of Networks: Information Flow and the Spread of Opinion
- ILLC DS-2016-03: **Fleur Leonie Bouwer**
What do we need to hear a beat? The influence of attention, musical abilities, and accents on the perception of metrical rhythm
- ILLC DS-2016-04: **Johannes Marti**
Interpreting Linguistic Behavior with Possible World Models
- ILLC DS-2016-05: **Phong Lê**
Learning Vector Representations for Sentences - The Recursive Deep Learning Approach
- ILLC DS-2016-06: **Gideon Maillette de Buy Wenniger**
Aligning the Foundations of Hierarchical Statistical Machine Translation
- ILLC DS-2016-07: **Andreas van Cranenburgh**
Rich Statistical Parsing and Literary Language
- ILLC DS-2016-08: **Florian Speelman**
Position-based Quantum Cryptography and Catalytic Computation
- ILLC DS-2016-09: **Teresa Piovesan**
Quantum entanglement: insights via graph parameters and conic optimization
- ILLC DS-2016-10: **Paula Henk**
Nonstandard Provability for Peano Arithmetic. A Modal Perspective
- ILLC DS-2017-01: **Paolo Galeazzi**
Play Without Regret
- ILLC DS-2017-02: **Riccardo Pinosio**
The Logic of Kant's Temporal Continuum

- ILLC DS-2017-03: **Matthijs Westera**
Exhaustivity and intonation: a unified theory
- ILLC DS-2017-04: **Giovanni Cinà**
Categories for the working modal logician
- ILLC DS-2017-05: **Shane Noah Steinert-Threlkeld**
Communication and Computation: New Questions About Compositionality
- ILLC DS-2017-06: **Peter Hawke**
The Problem of Epistemic Relevance
- ILLC DS-2017-07: **Aybüke Özgün**
Evidence in Epistemic Logic: A Topological Perspective
- ILLC DS-2017-08: **Raquel Garrido Alhama**
Computational Modelling of Artificial Language Learning: Retention, Recognition & Recurrence
- ILLC DS-2017-09: **Miloš Stanojević**
Permutation Forests for Modeling Word Order in Machine Translation
- ILLC DS-2018-01: **Berit Janssen**
Retained or Lost in Transmission? Analyzing and Predicting Stability in Dutch Folk Songs
- ILLC DS-2018-02: **Hugo Huurdeman**
Supporting the Complex Dynamics of the Information Seeking Process
- ILLC DS-2018-03: **Corina Koolen**
Reading beyond the female: The relationship between perception of author gender and literary quality
- ILLC DS-2018-04: **Jelle Bruineberg**
Anticipating Affordances: Intentionality in self-organizing brain-body-environment systems
- ILLC DS-2018-05: **Joachim Daiber**
Typologically Robust Statistical Machine Translation: Understanding and Exploiting Differences and Similarities Between Languages in Machine Translation
- ILLC DS-2018-06: **Thomas Brochhagen**
Signaling under Uncertainty
- ILLC DS-2018-07: **Julian Schlöder**
Assertion and Rejection

- ILLC DS-2018-08: **Srinivasan Arunachalam**
Quantum Algorithms and Learning Theory
- ILLC DS-2018-09: **Hugo de Holanda Cunha Nobrega**
Games for functions: Baire classes, Weihrauch degrees, transfinite computations, and ranks
- ILLC DS-2018-10: **Chenwei Shi**
Reason to Believe
- ILLC DS-2018-11: **Malvin Gattinger**
New Directions in Model Checking Dynamic Epistemic Logic
- ILLC DS-2018-12: **Julia Ilin**
Filtration Revisited: Lattices of Stable Non-Classical Logics
- ILLC DS-2018-13: **Jeroen Zuiddam**
Algebraic complexity, asymptotic spectra and entanglement polytopes
- ILLC DS-2019-01: **Carlos Vaquero**
What Makes A Performer Unique? Idiosyncrasies and commonalities in expressive music performance
- ILLC DS-2019-02: **Jort Bergfeld**
Quantum logics for expressing and proving the correctness of quantum programs
- ILLC DS-2019-03: **Andras Gilyen**
Quantum Singular Value Transformation & Its Algorithmic Applications
- ILLC DS-2019-04: **Lorenzo Galeotti**
The theory of the generalised real numbers and other topics in logic
- ILLC DS-2019-05: **Nadine Theiler**
Taking a unified perspective: Resolutions and highlighting in the semantics of attitudes and particles
- ILLC DS-2019-06: **Peter T.S. van der Gulik**
Considerations in Evolutionary Biochemistry
- ILLC DS-2019-07: **Frederik Mollerstrom Lauridsen**
Cuts and Completions: Algebraic aspects of structural proof theory
- ILLC DS-2020-01: **Mostafa Dehghani**
Learning with Imperfect Supervision for Language Understanding
- ILLC DS-2020-02: **Koen Groenland**
Quantum protocols for few-qubit devices

- ILLC DS-2020-03: **Jouke Witteveen**
Parameterized Analysis of Complexity
- ILLC DS-2020-04: **Joran van Apeldoorn**
A Quantum View on Convex Optimization
- ILLC DS-2020-05: **Tom Bannink**
Quantum and stochastic processes
- ILLC DS-2020-06: **Dieuwke Hupkes**
Hierarchy and interpretability in neural models of language processing
- ILLC DS-2020-07: **Ana Lucia Vargas Sandoval**
On the Path to the Truth: Logical & Computational Aspects of Learning
- ILLC DS-2020-08: **Philip Schulz**
Latent Variable Models for Machine Translation and How to Learn Them
- ILLC DS-2020-09: **Jasmijn Bastings**
A Tale of Two Sequences: Interpretable and Linguistically-Informed Deep Learning for Natural Language Processing
- ILLC DS-2020-10: **Arnold Kochari**
Perceiving and communicating magnitudes: Behavioral and electrophysiological studies
- ILLC DS-2020-11: **Marco Del Tredici**
Linguistic Variation in Online Communities: A Computational Perspective
- ILLC DS-2020-12: **Bastiaan van der Weij**
Experienced listeners: Modeling the influence of long-term musical exposure on rhythm perception