

Optical sensing in urban areas by deployed telecommunication fiber networks

Original

Optical sensing in urban areas by deployed telecommunication fiber networks / Boffi, Pierpaolo; Ferrario, Maddalena; Luch, Ilaria Di; Rizzelli, Giuseppe; Gaudino, Roberto. - ELETTRONICO. - (2022), pp. 1-5. (Intervento presentato al convegno 2022 International Conference on Optical Network Design and Modeling (ONDM) tenutosi a Warsaw, Poland nel 16-19 May 2022) [10.23919/ONDM54585.2022.9782848].

Availability:

This version is available at: 11583/2975400 since: 2023-01-31T08:46:12Z

Publisher:

IEEE

Published

DOI:10.23919/ONDM54585.2022.9782848

Terms of use:

openAccess

This article is made available under terms and conditions as specified in the corresponding bibliographic description in the repository

Publisher copyright

IEEE postprint/Author's Accepted Manuscript

©2022 IEEE. Personal use of this material is permitted. Permission from IEEE must be obtained for all other uses, in any current or future media, including reprinting/republishing this material for advertising or promotional purposes, creating new collecting works, for resale or lists, or reuse of any copyrighted component of this work in other works.

(Article begins on next page)

Optical sensing in urban areas by deployed telecommunication fiber networks

Pierpaolo Boffi
*Dept. Electronics, Information and
Bioengineering*
POLITECNICO di MILANO
Milan, Italy
pierpaolo.boffi@polimi.it

Maddalena Ferrario
*Dept. Electronics, Information and
Bioengineering*
POLITECNICO di MILANO
Milan, Italy
maddalena.ferrario@polimi.it

Ilaria Di Luch
*Dept. Electronics, Information and
Bioengineering*
POLITECNICO di MILANO
Milan, Italy
ilaria.diluch@polimi.it

Giuseppe Rizzelli
*Dept. Electronics and
Telecommunications*
POLITECNICO di TORINO
Turin, Italy
giuseppe.rizzelli@polito.it

Roberto Gaudino
*Dept. Electronics and
Telecommunications*
POLITECNICO di TORINO
Turin, Italy
roberto.gaudino@polito.it

Abstract—The telecommunication fiber network already deployed in urban areas provides an added value to the optical asset itself, allowing a smart monitoring of our cities in a large scale. It is possible to use deployed PON infrastructures for structural vibration and local seismologic perturbations monitoring. On the other hand, surveillance of the embedded network and real-time safety diagnostic is also possible. The invited talk will present different experimental demonstrations to show the sensing performance by exploiting deployed fiber links, assessing the compatibility with the optical data telecom traffic at very high rate.

Keywords— *Metro networks, fiber sensors, interferometric sensors, smart city.*

I. INTRODUCTION

According to the EU H2020 Digital Agenda [1], a huge amount of optical fiber has been deployed in our cities for high traffic metropolitan and access networks. A continuous reinforcement in the urban fiber infrastructure is estimated to support 5G development, requiring the connection of a large quantity of small cells and hotspots in order to transport the mobile data traffic in the next years. Telecom operators, communications service providers and public-private partnerships are investing in the urban area and also many municipalities own their optical network, supporting communications at their disposal. This fiber mesh penetrating in all the apartment thanks to the fiber-to-the-home (FTTH) connection is mandatory to overcome the present “digital divide”. It can represent a precious asset for a pervasive and smart monitoring as well, allowing not only the transmission of the telecom data, but also constituting the sensitive medium able to offer surveillance and real-time safety diagnostic of civil buildings, structures and of the embedded network itself. The urban fiber network can be utilized to generate, convey and transport a variety of useful information coming from critical

locations, making the city “smart” and providing even public security in a proactive way.

The monitoring of civil infrastructures demands a periodical check of the structures and the usual methods (for example based on the use of mechanical extensometers) are often complex and expensive. The guaranteed spatial resolution is low and the request of the the intervention of specialized operators limits the frequency of this kind of measurements. In this sense, the fiber optical sensors [2] assure an automatic and real-time monitoring embedded the structure itself, with high precision and good spatial resolution. Fiber sensors present important advantages compared to more traditional sensing approaches, such as their low cost, compact size, the ability to measure different parameters (vibrations, strain, pressure, temperature, etc.), insensitivity to electromagnetic fields (in presence of power lines, trains, and thunderstorms) and to corrosion.

Optical fiber sensors have already been employed for years to supervise gas&oil [3] and hydraulic pipelines [4], and also for manufacturing machine diagnostic [5,6]. Ocean-bottom fiber links of the submarine long-haul networks are used to provide seismographic and oceanographic data [7,8]. Recently, some examples of applications of fiber sensors in the urban area exploiting the already deployed communications network carrying simultaneously high-speed traffic [9,10,11], have been presented, for example to monitor vehicle speed and car density in a road [2]. In these applications, the employed fiber cable is enclosed in standard conduits, demonstrating low detection sensitivity, thus requiring complex and expensive sensing techniques such as based on distributed acoustic sensors (DASs), generally not compatible with the telecommunication data transport.

In this paper we show sensing solutions exploiting the installed urban fiber infrastructure, that can turn into simple and reliable embedded systems for optical surveillance, preventing dangerous damages to both civil buildings and the optical network cable itself, providing a fruitful synergy between

telecommunications and sensing applications. In our proposal, not special optical components are necessary as sensing elements, but we exploit directly the already installed access and metro network, providing fiber connection to each residential apartment in a pervasive way. The adoption of an interferometric approach allows to develop simple sensing solutions, assuring good resolution and accuracy without requiring complex digital signal processing and expensive devices.

In particular, we demonstrate the monitoring of vibration and deformation of urban buildings, using the access network organized as a passive optical network (PON) supporting NG-PON2 (TWDM-PON) standard, working up to 10 Gb/s per wavelength [13]. The buildings, FTTH-connected to the PON, can operate in this way as “optical antennas” able to give distributed information also about seismologic perturbations in the urban area. The monitoring of structural health of the road, of the surrounding environment, and of the telecom cable itself is also presented by using as sensing element the typical metropolitan area network (MAN) fiber organized in a ring topology, dedicating a proper wavelength to sensing applications in parallel with the dense division multiplexing (WDM) telecom traffic grid. The proposed diagnostic solution, embedded in the MAN, can identify in advance potentially dangerous situations affecting the integrity of the optical metro link. In both the proposed sensing systems, we adopt a coherent approach based on interferometric schemes, in order to achieve reliable embedded solutions with simple implementation supported by off-the-shelf low-cost instrumentations.

Preliminary assessments of the proposed sensing solutions have been experimented in the urban fiber infrastructure deployed in the city of Turin, Italy, by one of the Italian FTTH operators for telecom applications (Fig. 1). The fiber layout, comprising of spans of standard single-mode fiber (SSMF) of different lengths in normal conduits, can be organized in several topologies, according to the interconnections among the network sections and applications.



Fig. 1. Turin deployed urban fiber infrastructure exploited for the experimental assessment of the proposed sensing solutions.

II. FTTH PON EXPLOITATION FOR CIVIL BUILDINGS AND INFRASTRUCTURES MONITORING

The health conditions of buildings, such as skyscrapers, and in general of civil structures, such as bridges and tunnels, require a continuous real-time monitoring of the environmental

conditions (in case of critical events such as earthquakes and landslides) as well as the modal responses of the structure, in order to identify damages and to predict structural performance. Optical fiber sensors have been served as an effective tool for the monitoring of each phase of the civil structure life-cycle, with different types of measures (strains, vibrations, cracks, deflections/displacements). There have been a lot of solutions based on optical sensors for health condition assessment based on fiber Bragg gratings (FBGs) [14,15], extrinsic Fabry-Perot interferometers [16,17], and optical time-domain reflectometry (OTDR) [18,19].

In our proposal, not special optical components, such as FBGs are employed, but we exploit directly the FTTH network, providing fiber connection to each residential apartment in a pervasive way. The PON already installed in our cities can not only carry the telecom data to and from the final users, but also the measured physical parameters. The C band is used for the sensing signals, while the downstream telecom signal remains in the O band, according to the PON standard.

As shown in Fig. 2, an interferometric approach, based on a Michelson scheme, is adopted [20], devoting two optical ports of the last PON splitter not for network units (ONUs), but for monitoring the structural integrity of urban building. In fact, the fibers connected to these two outputs and terminated with Faraday rotator mirrors (FRM) to back-reflect the C-band radiation, constitute the sensing and reference arms of the Michelson interferometer. The sensing fiber can be laid on the structure to be monitored. FRMs assure the retracing of signal polarizations to avoid fading impairments [21]. Thanks to the adopted Michelson scheme, the feeder fiber connecting the central office to the splitter is common to the sensing and reference arms and hence does not introduce any phase noise contribution as the phase shift induced by the mechanical stresses or vibration in the sensing arm is immediately converted into amplitude after the splitter.

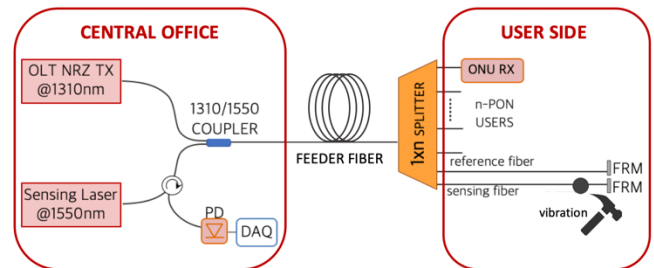

Fig. 2. PON architecture used as a Michelson interferometer, with 2 optical ports of the last PON splitter reserved for building structural monitoring.

The experimental assessment of the proposed PON-based sensing solution has been performed using an SSMF link in the deployed Turin fiber infrastructure, described before. At the central office a CW radiation at 1550 nm is added to the downstream 10-Gb/s NRZ signal at 1310 nm. At the user side the sensing fiber is stressed by a vibration achieved by means of a piezoelectric transducer (PZT), inducing dynamic strain variations in the range of few Hz, and causing a phase shift between the two arms of the Michelson interferometer. After the demodulation occurred inside the splitter in a similar way to what happens in a 1x2 coupler, the interferometric signal back-

propagates in the PON link together with the data traffic and is detected. Hence, the differential phase induced by the vibration is recovered thanks to the digital phase-generated carrier (PGC) homodyne technique [22]. We experimented different feeder fiber length and splitting ratios for the 1xN splitter (1x4, 1x8, and 1x16) [23], in order to assess the PON impact on the accuracy in the vibration monitoring.

In Fig. 3 the measured SNR as a function of the input sensing power for different splitting ratios is shown in case of 11-km PON length with 10-dB roundtrip loss. The measured SNR remains almost constant for the input sensing power owing to the Rayleigh backscattering contributions induced along the link, increasing linearly with the input power. Main penalties are due to splitter losses (6-dB signal drop each time the number of the splitter ports doubles). In case of 26-dB SNR (achieved with the 1x4 splitter) about $\pm 5\%$ of strain accuracy in vibration detection is obtained, while the presence of 1x16 splitter decreases the SNR, but assuring an acceptable $\pm 17\%$ accuracy.

Fig. 4 presents the BER for the downstream NRZ 10-Gb/s signals measured for different levels of sensing signal power (in case of 1x8 splitter): no significant detrimental in the measured is visible, demonstrating negligible impact of the C-band sensing signals copropagating in the PON with the downstream O-band data traffic.

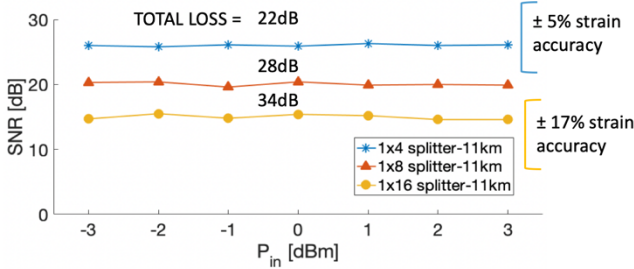

Fig. 3. Measured SNR vs input sensing power experimented in the deployed 11-km PON link.

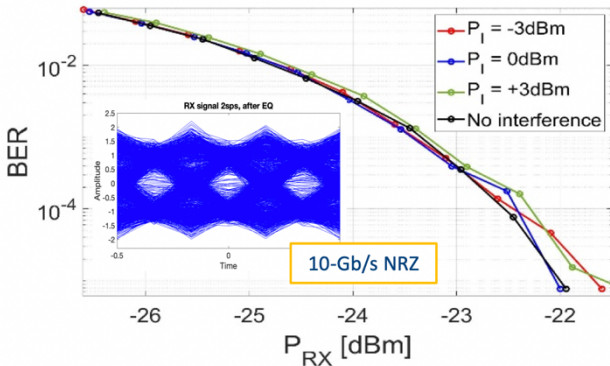

Fig. 4. BER of the downstream NRZ 10-Gb/s signal in O-band vs. received downstream signal power P_{RX} , measured for different levels of the C-band sensing signal P_i .

III. MAN RING EXPLOITATION FOR REAL-TIME DIAGNOSTIC OF EMBEDDED CABLES

Damages or breakages of telecommunication fiber infrastructures, due to strong mechanical stresses, due to sudden

landslides or road works close to the deployed cable, is a dangerous issue, causing prolonged out of service, and requiring time-consuming and high-cost repairs. We propose a diagnostic solution exploiting the MAN organized in a ring topology, to provide real-time monitoring of the structural health of the optical cable itself and also of the surrounding environment. The used scheme of the sensing system is shown in Fig. 5, based on a coherent approach [24] combined to a Mach-Zehnder interferometer (MZI) arranged in a loop configuration. To localize the onset of vibrations or dynamic stress applied to the fiber link, we employ a dual MZI layout. We consider not only the clockwise (CW) waves travelling in the two arms of the interferometer, but also the counter-clockwise (CCW) waves counterpropagating in the interferometer. The vibration localization is achieved by evaluating the time delay between the two counterpropagating phase modulations at the receivers.

As reference arm in the employed implementation, we use a different fiber inside the same deployed cable. The phase noise accumulated by the sensing arm deployed in the fiber infrastructure is very strong, owing to the city environment. By exploiting the proposed scheme, the reference and the sensing arms accumulate the same common mode noise, that can be cancelled by a balance detection. The reference arm also is affected by the vibration. But a slight difference in the geometrical arrangement of the fibers in the cable allows to reveal the vibration.

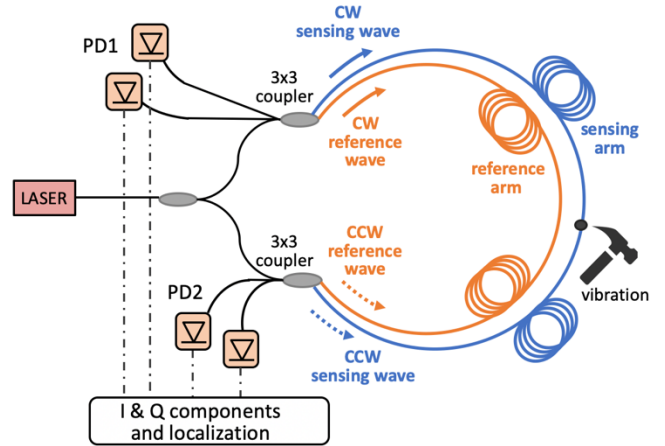

Fig. 5. Dual MZI arranged in the MAN fiber ring: in orange the reference arm; in blue the sensing arm. PD: photodetector.

For the experimental assessment, we used a 32-km SSMF ring in the Turin deployed network. To emulate a realistic stress event, we generated vibrations by means of a PZT applied to the cable or perturbations by manually hitting the floor under which the optical cable passed [25]. An example of the phase modulation recovered by the CW and CCW interferometer is shown in Fig.6, showing an impulsive wavefront caused by the pressure waves impacting on the fibers inside the deployed cable. The time delay between the two wavefronts of the CW and CCW waves, estimated in this example in $158.2 \mu s$ (Fig. 7) allows to localize the event, in agreement in this case with $\Delta L = 32 km$, having hit the cable at the end of the MAN ring. The sensing system employs off-the shelf components, such as programmable 20-Msample/s sampling boards, assuring spatial

accuracy of $\pm 15\text{m}$ in the impulsive event localization along real MAN, without complex and expensive solutions. The guaranteed accuracy is a good trade-off between a reduced DSP complexity and spatial resolution in fault localization.

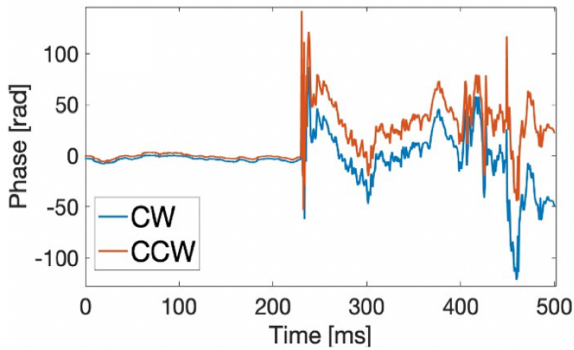

Fig. 6. Recovered phase modulation by the CW (in blue) and CCW interferometer (in orange).

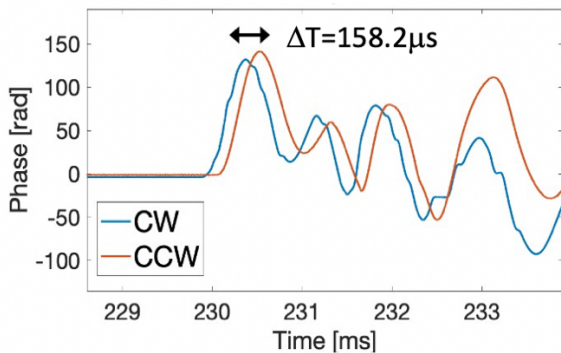

Fig. 7. Detail of the onset of the detected impulsive event, allowing to measure the time delay.

The sensing system has been proved in presence of WDM telecom data signals at 10 Gb/s. Two adjacent WDM radiations with a 50-GHz spacing are used for the sensing signal and the modulated telecom data. The overall link losses are up to 22dB, while the sensing signal is always kept below +5dBm in order not to induce non-linear effects. Fig. 8 shows the BER of the 10-Gb/s signal measured for different powers of the copropagating sensing signal. No significant detrimental effect of the sensing system is observed on the performance. The sensitivity curves overlap almost perfectly, with small discrepancies only for BER values close to the error free limit.

The interferometric scheme exploiting the MAN is based on two fiber rings operating in a bi-directional way, but it can be also adopted when in the metro network reconfigurable optical add-drop multiplexers (ROADMs) are present. Owing to the presence of isolators in the ROADM optical amplifiers, each fiber is strictly mono-directional. This means that four monodirectional fiber paths are required, as shown in Fig. 9, exploiting two pairs of sensing and reference fibers (one pair for the CW and one pair for the CCW propagation). In this way, the same interferometric scheme can be exploited also in case of ROADMs in the ring network.

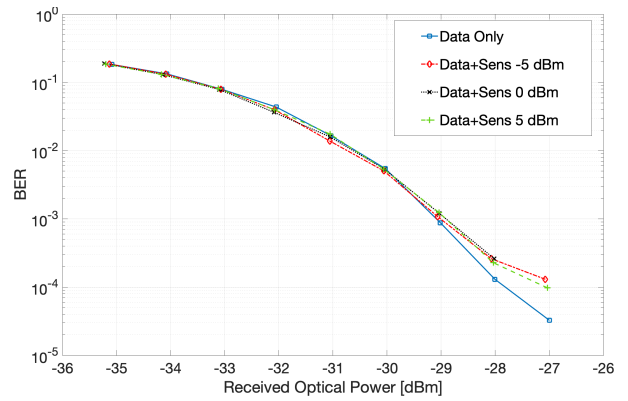

Fig. 8. BER of 10-Gb/s WDM telecom signal vs. received signal power, measured for different levels of power of the coexistent sensing signal.

CONCLUSIONS

We proposed sensing architectures exploiting the telecommunication fiber networks already deployed in urban area to enable a smart and pervasive monitoring of our cities in a large scale. All the sensing monitoring is achieved preserving the coexistence with the high-speed telecom data traffic transmission. Preliminary assessment of the proposed sensing solutions has been experimented by exploiting the urban fiber link deployed in the city of Turin. Reliable embedded sensing systems have been experimentally demonstrated with simple implementation supported by off-the-shelf low-cost instrumentations, assuring good performance in terms of resolution and accuracy and providing a fruitful synergy between telecommunications and sensing.

The exploitation for sensing applications of the installed network, in future even constituted by special fibers, such as multi-core and few-mode fibers, provides an added value to the optical telecom asset, that can turn into reliable embedded system for optical surveillance not only of the civil buildings and infrastructures, but also of the telecom cable itself and of other deployed pipes and cables.

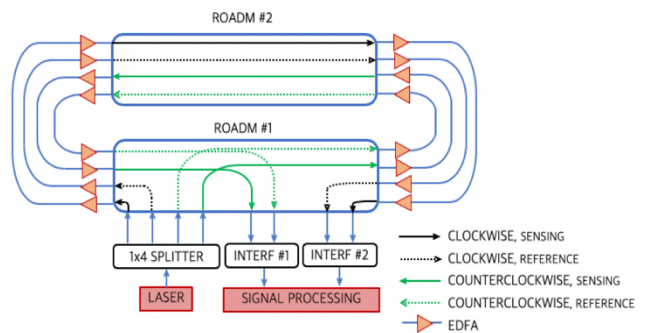

Fig. 9. Application of the proposed sensing architecture in a ring network in presence of ROADMs.

REFERENCES

- [1] <https://ec.europa.eu/digital-single-market/>
- [2] M. Bourmpos, A. Argyris, D. "Smart Smart City Surveillance Through Low-Cost Fiber Sensors in Metropolitan Optical Networks," *Fiber and Integrated Optics*, vol. 33, no. 3, pp. 205-223. 2004.

- [3] A. Kersey, "Optical fiber sensors for permanent downwell monitoring applications in the oil and gas industry," *IEICE Trans. Electron.*, E83-C, 3, 2000.
- [4] P. Boffi, et al., "Coherent optical fiber interferometric sensor for incipient cavitation index detection", *Flow Measurement and Instrumentation*, vol. 66, pp. 37-43, 2019.
- [5] M. Ferrario, et al., "A software-defined coherent fiber optic sensor for manufacturing machine diagnostic", in *Proc. SAS 2016 – 11th IEEE Sensors Applications Symposium*, Article 7479852, 242-246, 2016.
- [6] J. Morosi, et al., "Phase-coded Brillouin optical correlation domain analysis for extreme temperature sensing", in *Proc. CLEO Europe 2019, European Conference on Lasers and Electro-Optics*, Article number 2019-ch_13_5, 2019.
- [7] E. Williams, M.R. Fernández-Ruiz, R. Magalhaes, R. Vanthillo, Z. Zhan, M. Gonzalez-Herraez, and H. Martins, "Distributed sensing of microseisms and teleseisms with submarine dark fibers," *Nature Communications*, vol. 10, p. 5778, 2019.
- [8] M. Cantono, J.C. Castellanos, V. Kamalov, A. Mecozzi, R. Muller, S. Yin, Z. Zhan "Seismic sensing in submarine fiber cables," in *Proc. ECOC 2021 – 2021 European Conference on Optical Communication*, pp- 1-3, 2021.
- [9] M. Huang "First field trial of distributed fiber optical sensing and high-speed communication over an operational telecom network," *J. Lighwave Technol.*, vol. 38, p. 75, 2020.
- [10] N.J. Lindsey et al., "City scale dark fiber DAS measurements of infrastructure use during the COVID19 Pandemic," *Geophysical Research Lett.*, e2020GL089931, 2020.
- [11] Y. Aono, et al., "More than communications: environment monitoring using existing optical fiber network infrastructure," *Proc. OFC 2020, 2020 Optical Fiber Communications Conference*, San Diego, CA, 2020.
- [12] A. Glenn, et al., "First field trial of sensing vehicle speed, density and road conditions by using fiber carrying high speed data," in *Proc. OFC 2019, 2019 Optical Fiber Communications Conference*, San Diego, CA, paper Th4C.7, 2019.
- [13] <https://www.itu.int>
- [14] P. Capoluongo, C. Ambrosino, S. Campopiano et al., "Modal analysis and damage detection by Fiber Bragg grating sensors," *Sensors and Actuators A: Physical*, vol. 133, no. 2, pp. 415–424, 2007.
- [15] P. Moyo, J. M. W. Brownjohn, R. Suresh, and S. C. Tjin, "Development of fiber Bragg grating sensors for monitoring civil infrastructure," *Engineering Structures*, vol. 27, no. 12, pp. 1828–1834, 2005.
- [16] K. Kesavan, K. Ravisankar, S. Parivallal, and P. Sreeshylam, "Applications of fiber optic sensors for structural health monitoring," *Smart Structures and Systems*, vol. 1, no. 4, pp. 355–368, 2005.
- [17] I. B. Kwon, M. Y. Choi, and H. Moon, "Strain measurement using fiber optic total reflected extrinsic Fabry-Perot interferometric sensor with a digital signal processing algorithm," *Sensors and Actuators A: Physical*, vol. 112, no. 1, pp. 10–17, 2004.
- [18] A. Güemes, A. Fernández-López, and B. Soller, "Optical fiber distributed sensing-physical principles and applications," *Structural Health Monitoring*, vol. 9, no. 3, pp. 233–245, 2010.
- [19] Z. Zhu, D. Liu, Q. Yuan, B. Liu, and J. Liu, "A novel distributed optic fiber transducer for landslides monitoring," *Optics and Lasers in Engineering*, vol. 49, no. 7, pp. 1019–1024, 2011.
- [20] P. Boffi, I. Di Luch, M. Ferrario, G. Rizzelli, R. Gaudino, "Exploitation of deployed telecommunication fiber infrastructures for sensing applications," in *Proc. ICTON 2020 – 2020 22nd International Conference on Transparent Optical Networks*, 2020.
- [21] M. Martinelli, "A universal compensator for polarization change induced by birefringence on a retracing beam," *Opt. Comm.*, 72, pp. 341(1989).
- [22] A. Dandridge, et al., "Homodyne demodulation scheme for fiber optic sensors using phase generated carrier," *J. of Quantum Elect.*, QE-18, pp. 1647-1653, 1982.
- [23] I. Di Luch, et al., "Demonstration of structural vibration sensing in a deployed PON infrastructure", in *Proc. ECOC 2019, 45th European Conference on Optical Communication*, Dublin, 2019.
- [24] I. Di Luch, et al., "Vibration sensing for deployed metropolitan fiber infrastructures," in *Proc. OFC 2020, 2020 Optical Fiber Communications Conference*, San Diego, CA, paper 15966, 2020.
- [25] I. Di Luch, et.al., "Vibration sensing for deployed metropolitan fiber infrastructure," *J. Lighwave Technol.*, vol. 39, no. 4, pp. 1204-1211, 2021.