

## Characterization and analysis of N<sub>2</sub> plasma DC glow discharge at different voltage

Suzan M. Haji

Department of physics, Faculty of Science, University of Zakho, Kurdistan, Iraq

### ABSTRACT

In this work, the plasma glow discharge characteristics of nitrogen gas will be studied and analyzed at different pressures, and we will study the effect of these pressures on the I-V curve, the Panchen curve, the I-P curve, the current-voltage curve, and their effect on the electrical conductivity of the generated plasma. The distance between the glow electrodes was (15.5) cm. The pressures that were used in this work were (0.025, 0.05, 1.5, 5) T. The results indicated that the discharge was operating in the atypical glow region. On the other hand, the discharge current decreased as the gas pressure increased. On the other hand. Also, the conductivity decreased in its values with the increase in applied pressure as well as the voltage of the plasma focus.

**Keywords:** DC glow discharge; Panchen's law; I-V curve; I-P curve; discharge current.

### *Corresponding Author:*

Suzan M. Haji

Dept. of Physics, Faculty of Science/ University of Zakho

Kurdistan/ Iraq

E-mail: Suzan.haji@Uoz.edu.krd

### 1. Introduction

Plasma is a luminous material, and this is what is expressed by the glowing discharge. This illumination or luminosity was a result of the electron generated by the plasma, which has sufficient strength and density to generate visible light as a result of recombination by excited collisions [1]. This incandescent discharge has many varied applications. For example, photogeneration applications (fluorescent and neon discharge tubes for advertising, etc.), gas laser manufacturing, and large-area flat-panel plasma screens. Besides, there are other essential applications in microelectronics industries [2]. Other important applications are the surface treatments of materials, which include surface etching for the manufacture of integrated circuits, plasma polymerization, polymer curing, and coating deposition [3]. There are other very important types in the energy field such as beam glow discharge such as DC parallel plate plasma reactors, electron bombardment plasma, etc. [4]. In the simplest case, a glow discharge can be obtained by applying a potential difference of the order of a few 100 volts to a few kilovolts) between two electrodes in a chamber containing an inert gas at pressures ranging from a few mTorr to atmospheric pressure [5]. As a result of this voltage difference, the electrons are accelerated away from the cathode, which increases the secondary collisions between the electrons and the positive ions of the plasma material, which results in excitation, ionization, dissociation, etc., which creates an excited and electrically unneutral substance, which can decompose into levels Emitting less energy difference in the form of light, this is responsible for the distinctive name of the "glow" discharge. As the ions accelerate toward the negative electrode, the secondary ions release electrons that bombard the surface of the cathode [6]. The secondary electrons are accelerated away from the cathode and can lead to further ionization because of the collisions caused by these electrons. As a result, these collisions create ion-electron pairs, and this ion-electron multiplication in the presence of sufficient excitation potential makes the glow discharge process a self-sustaining plasma [7]. The research aims to study the properties of DC glow discharge plasma for gas of different pressures, where the effect of gas pressure on plasma parameters, such as voltage in the focus of the plasma, properties, and electrical conductivity of glow discharge as well as light emission from the discharge at the applied voltage and different pressures has been studied.

## 2. Method

Figure 1 shows the DC glow discharge plasma system used in this work.

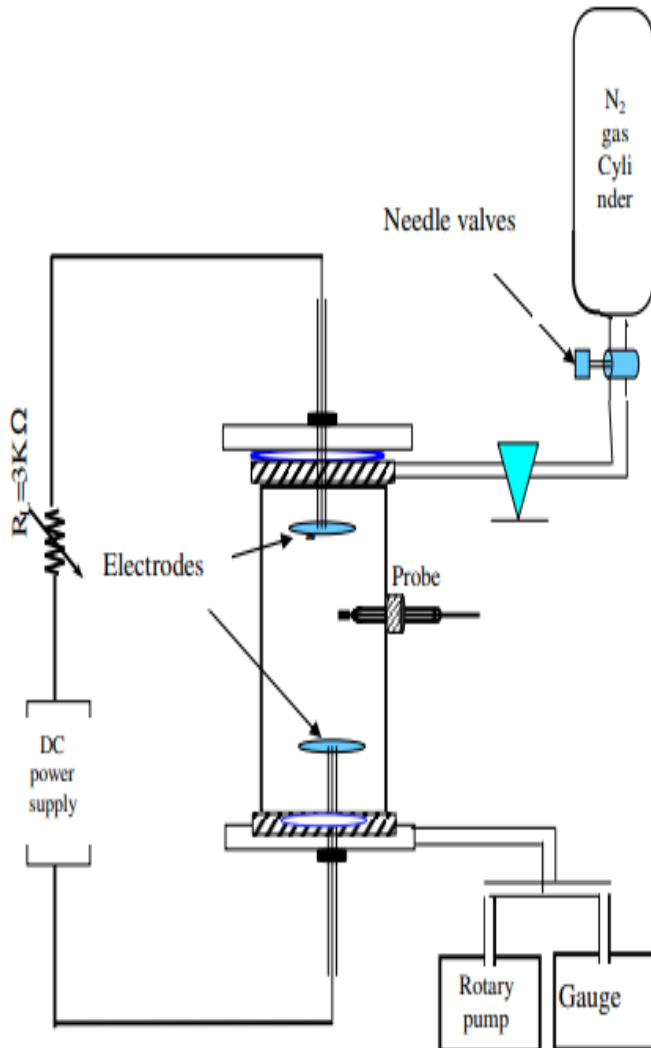

Figure 1. A schematic of system DC glow discharge plasma circuit

The electrodes (cathode and anode) are placed inside the chamber, while the pressure inside the chamber is controlled by a special instrument (needle valve). An appropriate voltage was then applied between the anode and the cathode while maintaining an anode ground connection. By changing the pressure value, the breakdown voltage ( $V_{br}$ ) occurs at different discharge values. When nitrogen gas is used,  $V_{br}$  decreases with increasing BD, while it increases with increasing pd. When a breakdown occurs, plasma forms between the electrodes, and current begins to flow through the system rapidly. Whereas the voltage drops across the panels quickly once a breakdown occurs. To obtain the electrical characterizations, the DC was passed between the electrodes first by providing sufficient breakdown voltage from the DC source. The basic properties of plasma discharge, such as I-V, I-P, and Paschen's law ( $V_{br}$ -PD) at different pressures of nitrogen gas in the chamber were studied (0.025, 0.05, 1.5, and 5) Torr using a needle valve. The distance between the two electrodes was 15.5 cm.

## 3. Results and discussion

The characteristics of a nitrogen gas plasma DC glow discharge such as breakdown voltage, I-V, and I-P characteristics, and the plume of the plasma depend on the pressure gas and the distance between the electrodes, where the plasma is created. These measurements were made using power DC voltage (0-1100) V.

It is known that the breakdown voltage is related to the distance between the electrodes PD (Paschen law), where  $p$  is the pressure of the gas used and  $d$  is the separation distance between the electrodes. Figure 2 shows the lowest potential for collapse. The breakdown value can be reduced by increasing the distance between the pd

electrodes. For pd values >1.6 cm), the breakdown voltage increases linearly with increasing pd values. For the small quantity pd, its values are determined by Equation 1 and as follows [8]:

$$pd = A - 1 \ln(1 + 1/\text{sec}) \dots\dots(1)$$

where (A) is a constant, and (sec) is the secondary emission coefficient of electrons. Also, the values of V<sub>min</sub> and (pd)<sub>min</sub> play an important role in the more complex problem of the cathode sheath [9].

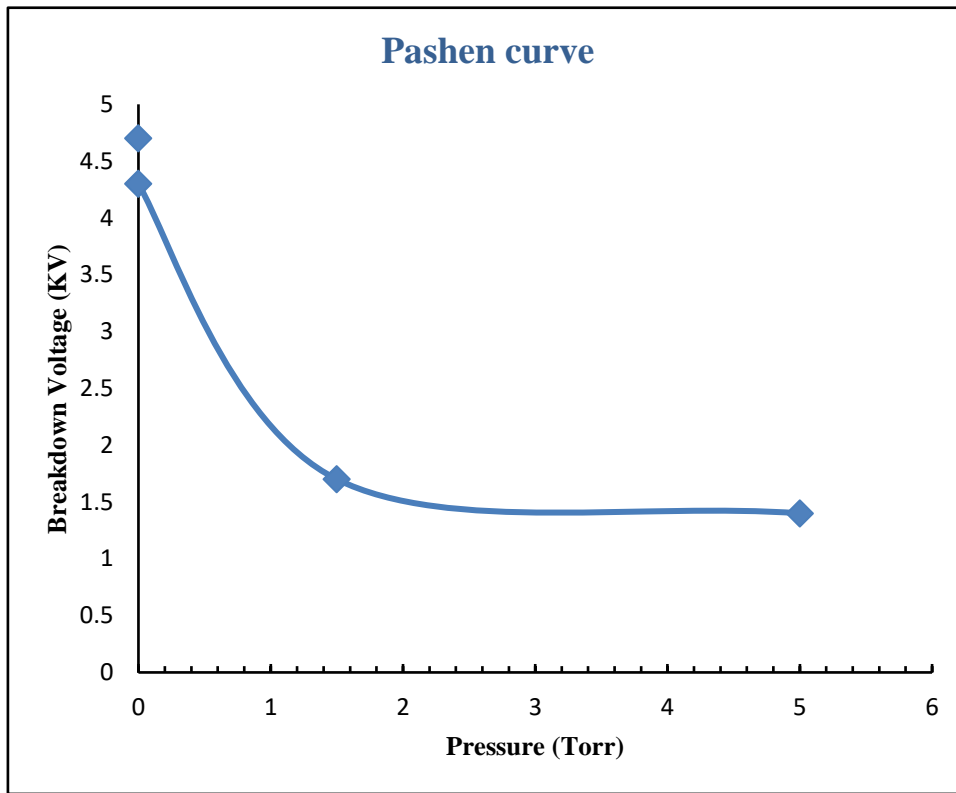

Figure 2. The Breakdown of DC voltage as a function of different N<sub>2</sub> gas pressure

Figure 3 showed that the discharge current increased gradually with increasing the applied voltage obtained at the pressure (0.025, 0.05, 1.5, and 5) Torr and the distance between the electrodes (15.5 cm). We note from Figure 2 that the discharge current increased with an increase in applied voltage but the increase is not linear [10]. We also note that the current density after a short period changes, as well as the thickness of the sheath. The low current density J<sub>c</sub> for the applied voltage V<sub>0</sub> across the shell of thickness S is given by the following relation [11]:

$$J_e = 4/9 E_0 (2e / M)^{1/2} V_0^{3/2} / S^2 \dots\dots\dots(2)$$

Where E<sub>0</sub>: is free space permittivity, e: is the charge, and M: particles mass. The behavior of the current and voltage curves can be attributed to the motion of the plasma particles and this behavior is consistent with the Longmuir equation [12]. Where the results confirm that the ionic currents at different pressures and usually were interpreted in terms of gas pressure, considering the gas density. As the pressure of the gas increases, the current of ions will increase. This means that ionic collisions occur during their path between the two poles, and this process may be accompanied by excitation and ionization because plasma processes occur simultaneously [9]. The current-voltage (I-V) curves can give us valuable information about the glow-discharge properties of DC plasmas. This discharge occurs after the supplied voltage is more than 1 kV. As for the voltage of the power source, it is changed to change the discharge current. Comparing the I-V curve for different pressures applied and glow discharge indicates that there is no Townsend mode, and the starter voltage drops (negative resistance). These regions can be observed in the Torr pressure I-V curve (0.025, 0.05). At higher pressures, breakdown occurs rapidly followed by a transition to a normal glow discharge mode which is relatively constant. When the pressure is increased, the average discharge voltage decreases from about 900 volts at (1.5) torrs to 600 volts at (5) torr. It is clear that as the pressure increases, the discharge becomes more conductive. The relationship is nonlinear but becomes linear at larger gaps. This represents an increase in the anode length in the discharge with the electric field constant.

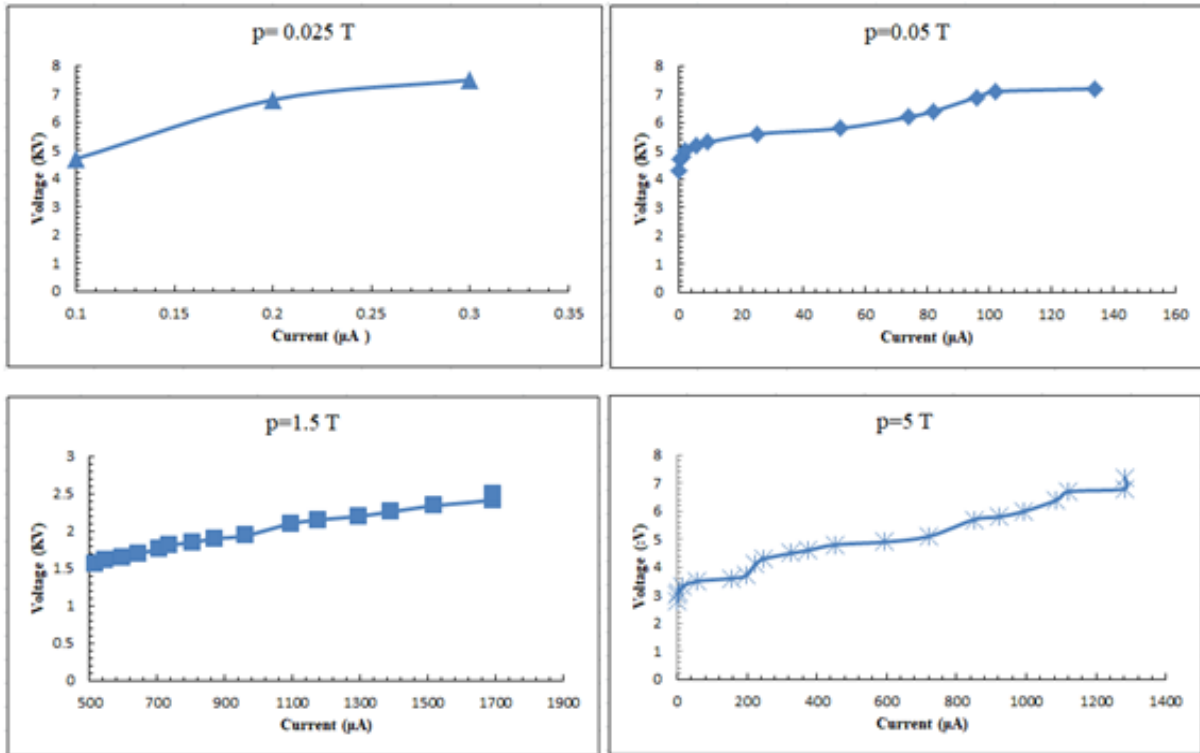

Figure 3. The (I-V) curves of glow discharge plasma using  $N_2$  gas at different pressure

Figure 4 shows the I-P curve characteristics of  $N_2$  gas. The results showed the glow discharge current increased with the increasing pressure generated in the reactor chamber at a constant voltage of about (3 kV). This behavior can be attributed to the increase in the pressure chamber leading to the increasing generation of ions and free electrons in the glowing column, thus increasing the potential for secondary electron emission. So, the measured current represents the sum of the ions and the currents of the electrons emitted [13].

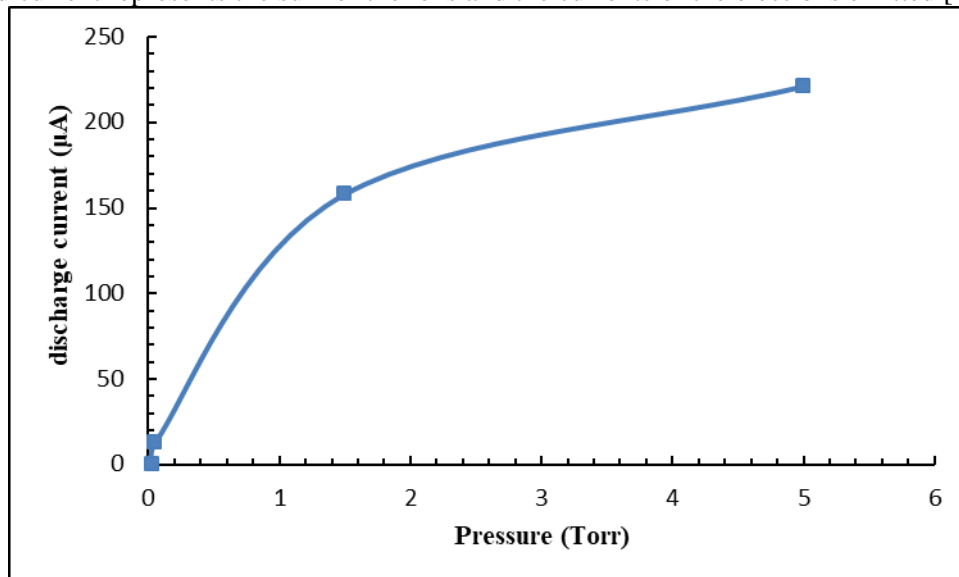

Figure 4. (I-P) curves of glow discharge plasma of  $N_2$  gas

The electrical conductivity ( $\sigma$ ) is measured in a glow discharge column of  $N_2$  gas plasma at different pressures. Figure 5 showed the values of conductivity distribution at different gas pressures. The results showed the conductivity increased with the increase in applied pressure. The reason is that when the pressure increases, the gas concentration increases, and this leads to an increase in the formed ions, which means an increase in the number of electrons, and thus an increase in conductivity, and this is consistent with the arrangement of (Marek et al., 2002) [14] in the same line.

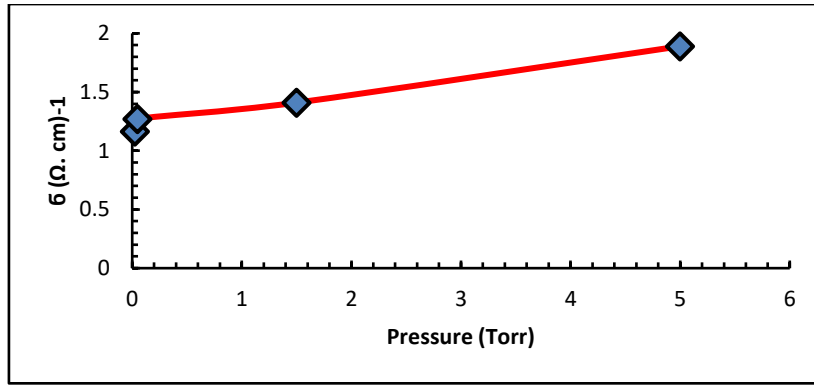

Figure 5. The diagram of conductivity with pressure

Figure 6 showed the relationship between voltage (Vb) and conductivity (σ) at different pressures, the electrical conductivity was calculated at each voltage fitted at the specified pressure. The results showed there is an inverse relationship between the voltage and pressure, where the electrical conductivity decreases with increasing supply voltage (Vb). Knowing that the applied voltages were decreased with increasing pressure, as shown in Figure 7 which explains the relationship between voltage and pressure. This means that electrical conductivity increases the increase in pressure, due to the increase in ionization and excited collisions with the increase in pressure in the plasma chamber. This is consistent with the results of the researcher (Yunus et al. 2021) [15] in the same line.

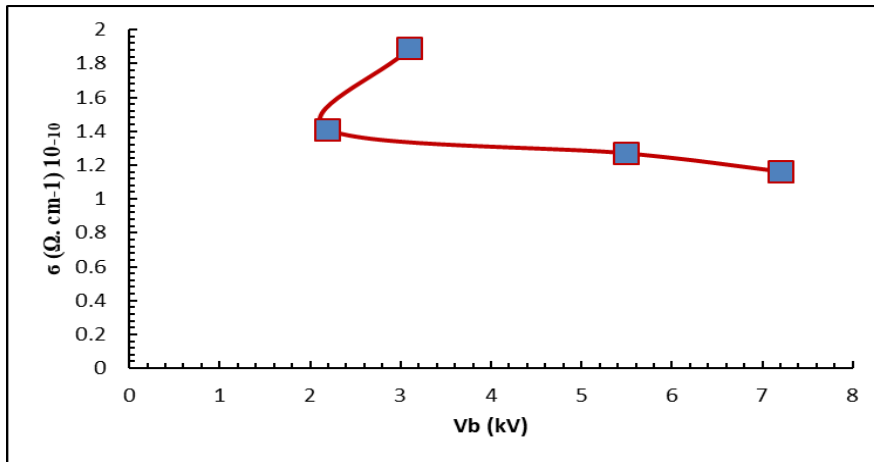

Figure 6. The evolution of conductivity as a function of Vb

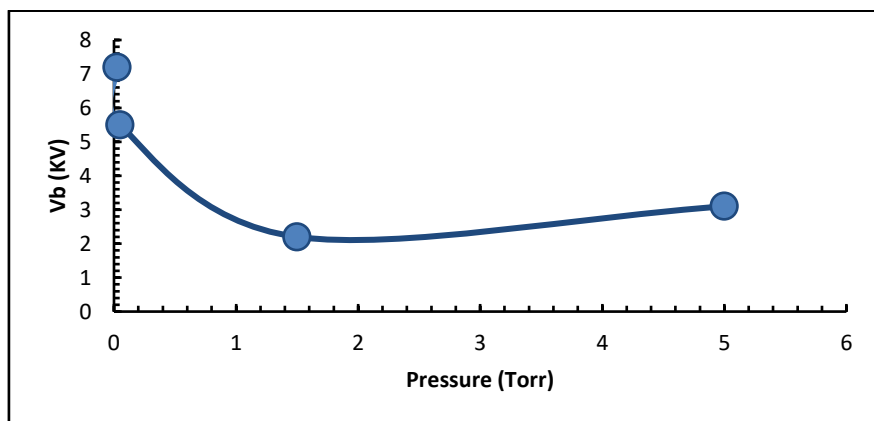

Figure 7. Evolution the pressure as a function of Vb

Figure 8 showed the relationship between the luminous intensity of the plasma and the applied voltage between the electrodes for the pressures chosen in this work. The intensity of the lighting in general increased with the increase in the applied voltage, and this increase varies in intensity according to the applied pressure, as we note that the intensity is high in the pressure of 1.5 Torr. The intensity of the illumination of the plasma is related to the secondary collisions of the emitted electrons, as the violet light of the plasma indicates the emission of

energy when the electrons return to the ground levels after being excited by the secondary collisions. These results coincide with the results of the researcher (Mari, et al. 2002) [16] which are in the same research line.

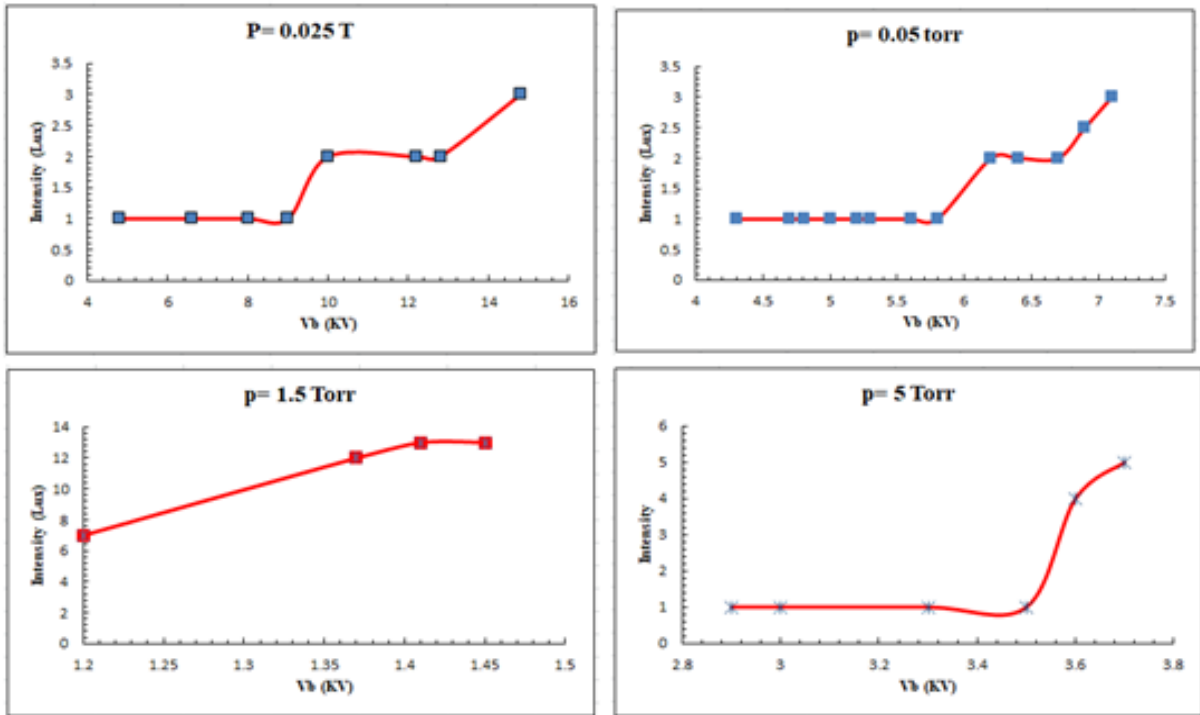

Figure 8. The intensity luminesces with apply voltage

Figure 9 shows the relationship between the electrodes for the pressures chosen in this work. We notice that the intensity of the lighting in general increased with the increase in the current, and this increase varies in intensity according to the applied pressure. From Figure 9, we can see that the intensity is high in the pressure of 1.5 Torr. The intensity of the illumination of the plasma is related to the current of the plasma, this is because the current increased the secondary collisions of the free electrons. These results coincide with the results of the researcher [17-21] which are in the same research line.

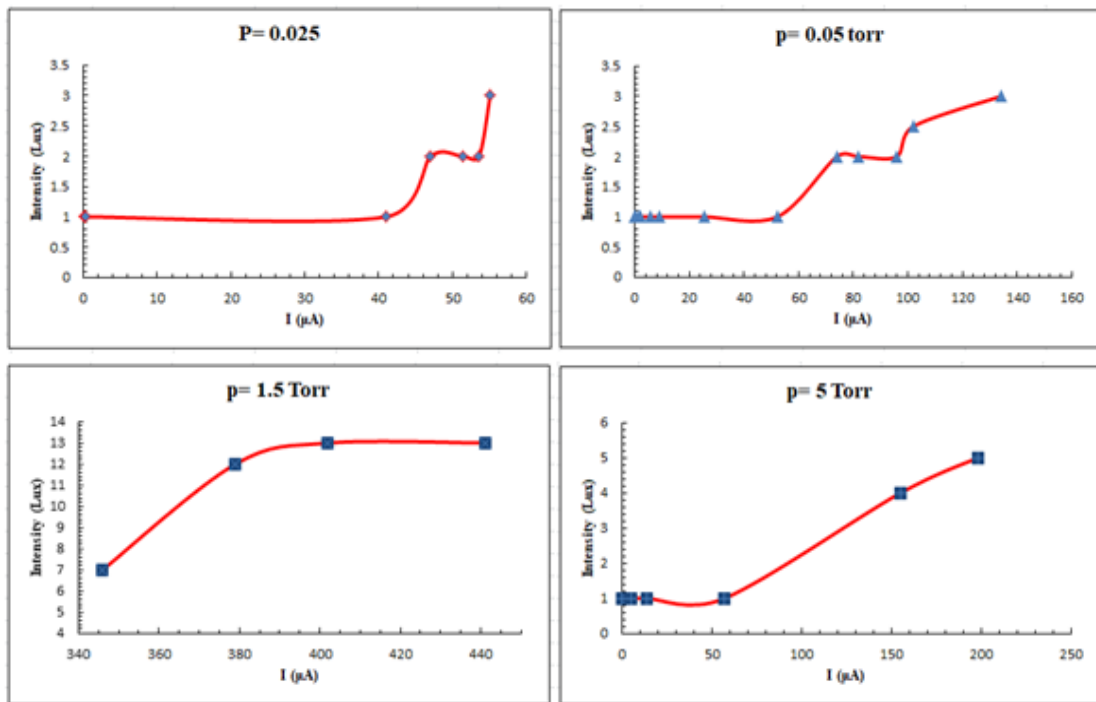

Figure 9. The intensity luminesces with current of plasma

Figure 10 showed the relationship between intensity luminesces and pressure. We can see the high intensity in the pressure (1.5) Torr, this is meaning the high secondary collisions of the free electrons in (1.5) Torr, this is clear in Figures 8 and 9.

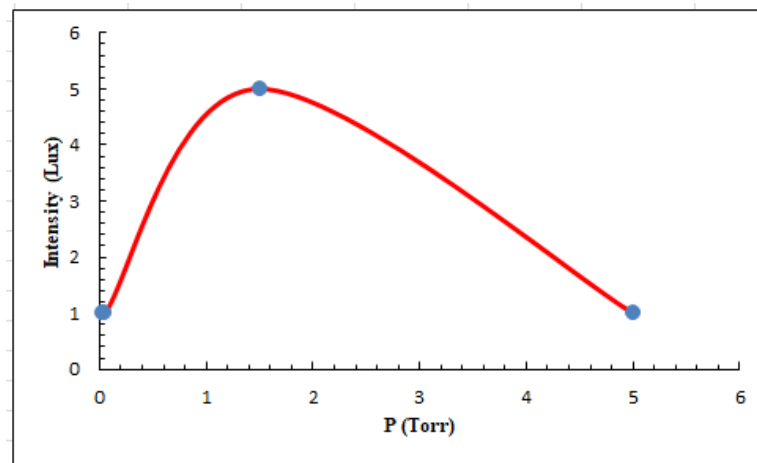

Figure 10. The relationship between intensity luminesces and pressure.

#### 4. Conclusions

different pressures in this work. Firstly, the I-V curve characteristics of the N<sub>2</sub> gas discharge indicated that the plasma obtained under different pressures and voltages operates in an abnormal glow discharge region, which means that this plasma is important for the microelectronics industry. Second, gas pressure had a significant effect on glow discharge current, conductance, and plasma density and this is consistent with the Child–Langmuir equation. The final volume of the plasma and the intensity of the resulting plasma plume (glow) depends on the gas pressure. Also, the high intensity luminesces in the pressure (1.5) Torr.

#### Conflict of interest

The authors declare that they have no conflict of interest, and all the authors agree to publish this paper under academic ethics.

#### Author contributions

All the authors contributed equally to the manuscript.

#### Funding

The work was not supported by any official Institute or company.

#### References

- [1] E. H. S. Nisaan, F. Shakir, "Analysis of Langmuir Probe Characteristics for Measurement of Plasma Parameters in DC Discharge," *Journal of Applied Mathematics and Physics*, vol. 7, pp. 78-95. , 2020.
- [2] N. A. Dyatko, Y. Z. Ionikh, and A. P. Napartovich, "Influence of nitrogen admixture on plasma characteristics in a DC argon glow discharge and in afterglow," *Atoms*, vol. 7, no. 1, p. 13, 2019.
- [3] S. Hübner, E. Carbone, J. M. Palomares, and J. van der Mullen, "Afterglow of argon plasmas with H<sub>2</sub>, O<sub>2</sub>, N<sub>2</sub>, and CO<sub>2</sub> admixtures observed by Thomson scattering," *Plasma Processes and Polymers*, vol. 11, no. 5, pp. 482-488, 2014.
- [4] L. Zigan, "Overview of electric field applications in energy and process engineering," *Energies*, vol. 11, no. 6, p. 1361, 2018.
- [5] A. Barkhordari, A. Ganjovi, I. Mirzaei, A. Falahat, and M. Rostami Ravari, "A pulsed plasma jet with the various Ar/N<sub>2</sub> mixtures," *Journal of Theoretical and Applied Physics*, vol. 11, pp. 301-312, 2017.
- [6] M. Hassouba and E. Menanna, "Electrical characteristics of (N<sub>2</sub>-H<sub>2</sub>) gas mixture DC glow discharge," *International Journal of Physics Sciences*, vol. 4, no. 11, pp. 713-721, 2009.

- 
- [7] M. A. B. Soliman, N. Basal, "Physical Characteristics of the Modified Glow Discharge Ion Source," *Acta Physica Polonica A*, vol. 33, no. 1, pp. 10-14, 2018.
- [8] O. F. M. Farag, "Mixing and cathode material effects on breakdown voltage of DC Ar glow discharge," *Pelagia Research Library*, vol. 8, 2013.
- [9] C. Yuenyao, T. Chittrakarn, Y. Tirawanichakul, and H. Nakajima, "Low pressure DC-plasma system for the modification of polymeric membrane surfaces," *Sains Malaysiana*, vol. 46, no. 5, pp. 783-793, 2017.
- [10] M. Saady, "DC pseudo-glow discharge in nitrogen gas," *Plasma Devices and Operations*, vol. 17, no. 1, pp. 88-96, 2009.
- [11] S. Surzhikov, "Comparative Analysis of the Parameters of the Normal and Abnormal DC Glow Discharges," *Plasma Physics Reports*, vol. 48, no. 11, pp. 1261-1272, 2022.
- [12] M. A. Rahman, F. A. Salam, and B. Soliman, "Improved treatment of home-made glow discharge ion source," in *Journal of Physics: Conference Series*, vol. 2304, no. 1: IOP Publishing, p. 012011, 2022.
- [13] S. Linnik, S. Zenkin, A. Gaydaychuk, and A. Mitulinsky, "High-rate growth of single crystal diamond in AC glow discharge plasma," *Diamond and Related Materials*, vol. 120, p. 108681, 2021.
- [14] D. Marić, K. Kutasi, G. Malović, Z. Donkó, and Z. L. Petrović, "Axial emission profiles and apparent secondary electron yield in abnormal glow discharges in argon," *The European Physical Journal D-Atomic, Molecular, Optical and Plasma Physics*, vol. 21, pp. 73-81, 2002.
- [15] Y. K. Jabur, M. G. Hammed, and M. K. Khalaf, "DC glow discharge plasma characteristics in Ar/O<sub>2</sub> gas mixture," *Iraqi Journal of Science*, pp. 475-482, 2021.
- [16] K. K. D. Mari, G. Malovi, Z. Donk and Z.Lj. Petrovi, "Axial emission profiles and apparent secondary electron yield in abnormal glow discharges in argon," *The European Physical Journal D-Atomic, Molecular, Optical and Plasma Physics*, pp. 73-81, 2002.
- [17] M. S. Farhan, and F. T. Abed, "Impact of substrate temperatures on the properties of V<sub>2</sub>O<sub>5</sub> thin films deposited by pulsed laser deposition," in *Journal of Physics: Conference Series*, 2021, vol. 1973, no. 1: IOP Publishing, p. 012074.
- [18] M. S. Ahmed, and Y. AL-Tulaihi, "Bandwidth Analysis of a p- $\pi$ -n Si Photodetector," *International Journal of Computer Applications*, vol. 975, no. 8887, p. 535, 2016.
- [19] H. F. Khazaal, "A Proposed Model for the Mutual Dependency Between QoE and QoS in Wireless Heterogeneous Networks," *Journal of Al-Qadisiyah for computer science and mathematics*, vol. 9, no. 2, pp. Page 45-55, 2017.
- [20] I. A. Aljazeera, H. Alhasan, and F. N. Al Hachami, "Simulation Study to Calculate the Vibration Energy of Two Molecules of Hydrogen Chloride and Carbon Oxide," *Journal of Green Engineering*, vol. 10, no. 9, pp. 5989-6010, 2020.
- [21] S. Zivanov, J. Zivkovic, I. Stefanovic, S. Vrhovac, and Z. L. Petrovic, "Transition from diffuse to constricted low current discharge in argon," *The European Physical Journal Applied Physics*, vol. 11, no. 1, pp. 59-69, 2000.