

ADA Notice
 For individuals with sensory disabilities, this document is available in alternate formats. For information call (916) 654-6410 or TDD (916) 654-3880 or write Records and Forms Management, 1120 N Street, MS-89, Sacramento, CA 95814.

1. REPORT NUMBER CA19-3213	2. GOVERNMENT ASSOCIATION NUMBER	3. RECIPIENT'S CATALOG NUMBER
4. TITLE AND SUBTITLE Advanced Camera Lowering Device for ITS Maintenance		5. REPORT DATE August 17, 2018
		6. PERFORMING ORGANIZATION CODE AHMCT Research Center, UC Davis
7. AUTHOR Duane Bennett and Ty A. Lasky		8. PERFORMING ORGANIZATION REPORT NO. UCD-ARR-18-08-31-01
		10. WORK UNIT NUMBER
9. PERFORMING ORGANIZATION NAME AND ADDRESS AHMCT Research Center UCD Dept. of Mechanical & Aerospace Engineering Davis, California 95616-5294		11. CONTRACT OR GRANT NUMBER IA 65A0560 Task 3213
		13. TYPE OF REPORT AND PERIOD COVERED Final Report May 2017 – August 2018
		14. SPONSORING AGENCY CODE Caltrans
12. SPONSORING AGENCY AND ADDRESS California Department of Transportation P.O. Box 942873, MS #83 Sacramento, CA 94273-0001		
15. SUPPLEMENTARY NOTES		

16. ABSTRACT

The California Department of Transportation (Caltrans), in an effort to satisfy mandated Intelligent Transportation System (ITS) performance goals and consistency with MAP-21 performance management targets, is deploying an increasing number of Closed-Circuit TV (CCTV) cameras to monitor traffic and conditions on California's roadways. These CCTV cameras are typically mounted along the highway on top of high poles and need to be accessed periodically for service and repair to keep these sophisticated systems functional. Many of these Caltrans camera system sites are difficult to access due to traffic hazards, roadside obstacles, and greater pole heights. Challenging access sites like these require additional time, cost, and exposure to unsafe conditions, which can contribute to delayed or deferred camera maintenance and repairs. Caltrans is expanding their application of pole-mounted Camera Lowering Devices (CLDs) systems in an effort to facilitate access to these problematic camera sites. Caltrans commonly deploys Halo-style CLD products. This research introduces Caltrans to the use of a detachable type of CLD product that offers additional benefits, such as eliminating the potential of binding, reducing communication cabling requirements, allowing the mounting of ancillary items such as antennas and microwave vehicle detection systems (MVDS), and supporting the retrofitting of existing camera poles. This research project supports the deployment and evaluation of both an internal and external MG2 CLD systems on Caltrans highways. This report documents the installation, training, and performance of these research MG2 systems in association with Caltrans District 3 Maintenance and Transportation Management Center (TMC) personnel. These MG2 CLD systems have proven to be easy to use, performed effectively, and provide significant cost and safety benefits to Caltrans maintenance when accessing ITS camera systems on the highway. Based on the successful deployment of these MG2 CLD systems, it is the recommendation of this report that Caltrans consider the qualification and expanded use of the MG2 CLD systems in the future.

17. KEY WORDS Camera Lowering Device, Closed-Circuit TV (CCTV), Intelligent Transportation Systems (ITS)	18. DISTRIBUTION STATEMENT No restrictions. This document is available to the public through the National Technical Information Service, Springfield, Virginia 22161.	
19. SECURITY CLASSIFICATION (of this report) Unclassified	20. NUMBER OF PAGES 154	21. COST OF REPORT CHARGED

DISCLAIMER

The research reported herein was performed by the Advanced Highway Maintenance and Construction Technology (AHMCT) Research Center, within the Department of Mechanical and Aerospace Engineering at the University of California – Davis, for the Division of Research, Innovation and System Information (DRISI) at the California Department of Transportation. AHMCT and DRISI work collaboratively to complete valuable research for the California Department of Transportation.

The contents of this report reflect the views of the author(s) who is (are) responsible for the facts and the accuracy of the data presented herein. The contents do not necessarily reflect the official views or policies of the STATE OF CALIFORNIA or the FEDERAL HIGHWAY ADMINISTRATION. This report does not constitute a standard, specification, or regulation. This report does not constitute an endorsement by the Department of any products or services described herein.

The contents of this report do not necessarily reflect the official views or policies of the University of California. This report does not constitute an endorsement by the University of California of any products or services described herein.

For individuals with sensory disabilities, this document is available in alternate formats. For information, call (916) 654-8899, TTY 711, or write to California Department of Transportation, Division of Research, Innovation and System Information, MS-83, P.O. Box 942873, Sacramento, CA 94273-0001.



Advanced Highway Maintenance and Construction Technology Research Center

Department of Mechanical and Aerospace Engineering
University of California at Davis

Advanced Camera Lowering Device for ITS Maintenance

Duane Bennett &
Dr. Ty A. Lasky: Principal Investigator

Report Number: CA19-3213
AHMCT Research Report: UCD-ARR-18-08-31-01
Final Report of Contract: IA 65A0560 Task 3213

August 17, 2018

California Department of Transportation

Division of Research, Innovation and System Information

ABSTRACT

The California Department of Transportation (Caltrans), in an effort to satisfy mandated Intelligent Transportation System (ITS) performance goals and consistency with MAP-21 performance management targets, is deploying an increasing number of Closed-Circuit TV (CCTV) cameras to monitor traffic and conditions on California's roadways. These CCTV cameras are typically mounted along the highway on top of high poles and need to be accessed periodically for service and repair to keep these sophisticated systems functional. Many of these Caltrans camera system sites are difficult to access due to traffic hazards, roadside obstacles, and greater pole heights. Challenging access sites like these require additional time, cost, and exposure to unsafe conditions, which can contribute to delayed or deferred camera maintenance and repairs. Caltrans is expanding their application of pole-mounted Camera Lowering Devices (CLDs) systems in an effort to facilitate access to these problematic camera sites. Caltrans commonly deploys Halo-style CLD products. This research introduces Caltrans to the use of a detachable type of CLD product that offers additional benefits, such as eliminating the potential of binding, reducing communication cabling requirements, allowing the mounting of ancillary items such as antennas and microwave vehicle detection systems (MVDS), and supporting the retrofitting of existing camera poles. This research project supports the deployment and evaluation of both an internal and external MG² CLD systems on Caltrans highways. This report documents the installation, training, and performance of these research MG² systems in association with Caltrans District 3 Maintenance and Transportation Management Center (TMC) personnel. These MG² CLD systems have proven to be easy to use, performed effectively, and provide significant cost and safety benefits to Caltrans maintenance when accessing ITS camera systems on the highway. Based on the successful deployment of these MG² CLD systems, it is the recommendation of this report that Caltrans consider the qualification and expanded use of the MG² CLD systems in the future.

EXECUTIVE SUMMARY

The California Department of Transportation (Caltrans), in order to satisfy Caltrans' 2020 Intelligent Transportation System (ITS) field equipment performance goals and be consistent with MAP-21 performance management targets, is deploying an increasing number of Closed-Circuit TV (CCTV) cameras to monitor traffic and conditions on California's roadways. These CCTV cameras are typically mounted along the highway on top of high poles which need to be accessed periodically for maintenance to keep these sophisticated systems operational. Many sites where Caltrans operates camera systems are difficult to access due to traffic hazards, roadside obstacles, and pole heights out of the reach of standard Caltrans man-lift trucks. These challenging sites require additional time, cost, and exposure to unsafe conditions, which consequently contributes to delayed or deferred camera maintenance and repairs. In an effort to facilitate access to these problematic camera sites, Caltrans is expanding their application of pole-mounted camera lowering device (CLD) systems.

CLD systems can be incorporated into a new pole installation and, in the case of certain products, can be attached to existing camera poles. The CLD system enables a single maintenance worker to lower the camera package suspended by a steel cable down to the ground for service. Caltrans has primarily relied on one type of CLD product that can only be incorporated into new camera pole installations, but other types of devices and products can be investigated which may provide additional benefits, such as eliminating the possibility of binding, reducing communication cabling requirements, and supporting retrofitting of an existing camera pole. Caltrans needs an evaluation leading towards the qualification of at least one additional, viable commercially available CLD system of a different design for Caltrans' potential purchase and deployment.

This report examines the unique features and operation of the Halo and Detachable types of commercially available CLD products offered by major manufactures. The research methodology of this report includes the procurement and deployment for evaluation and study of a Detachable-type MG² Internal CLD system with an integrated 50-foot steel pole to be mounted on a highway by Caltrans. This research project also supports the installation and operation of an MG² External-type CLD system retrofitted by Caltrans to a legacy highway camera pole. This report documents the installation process for both the Internal and External MG² systems along with their subsequent operation, performance characteristics, and serviceability in association with Caltrans District 3 Maintenance and Transportation Management Center (TMC) personnel. This report also includes the performance and serviceability evaluation of the Caltrans high-mast MG² Internal-type security/traffic Pan-Tilt-Zoom camera system located on the eastern approach to the SF-Oakland Bay Bridge. This system was installed and is maintained by the Caltrans subcontractor Industrial ENET. All of the MG² CLD systems examined in this report have proven to be easy to use, performed effectively, and provide significant cost and safety benefits to Caltrans maintenance when accessing ITS camera systems on the highway. Based on the successful deployment and performance of these MG² CLD systems, it is the recommendation of this report that Caltrans consider expanding their use of MG² CLD products in the future.

TABLE OF CONTENTS

<i>Abstract</i>	<i>ii</i>
<i>Executive Summary</i>	<i>iii</i>
<i>Table of Contents</i>	<i>iv</i>
<i>List of Figures</i>	<i>v</i>
<i>List of Acronyms and Abbreviations</i>	<i>vii</i>
<i>Acknowledgments</i>	<i>viii</i>
<i>Chapter 1: Introduction</i>	<i>1</i>
Problem	1
Objectives	2
Scope	2
Background	3
Research Methodology	8
Overview of Research Results and Benefits	8
<i>Chapter 2: Detachable-Type CLD Design Description</i>	<i>10</i>
Detachable-Type CLD - Common Features	10
Detachable-Type CLD - Suspension Coupling Designs	15
Detachable-Type CLD – Internal Mounting Systems.....	24
Detachable-Type CLD – External Mounting Systems.....	26
<i>Chapter 3: Halo-Style CLD – Design Description</i>	<i>30</i>
Halo-Style CLD - Common Features	30
<i>Chapter 4: Trial MG² CLD Systems Procurement and Installation</i>	<i>36</i>
MG ² Internal-Type System Procurement.....	36
MG ² Internal-Type System Installation.....	38
MG ² External-Type System Procurement	51
MG ² External-Type System Installation	52
<i>Chapter 5: MG² CLD System Performance Evaluation</i>	<i>62</i>
MG ² Internal-Type System Performance	62
MG ² External-Type System Performance	69
SF-Oakland Bay Bridge MG ² Internal-Type System Performance	74
<i>Chapter 6: Conclusions and Future Research</i>	<i>81</i>
Conclusions.....	81
Future Work.....	82
<i>Appendix A: Pole Design Approval Letter</i>	<i>83</i>
<i>Appendix B: MG² Internal-Type CLD and Pole Packing List</i>	<i>86</i>
<i>Appendix C: MG² Internal-Type CLD Installation Guide</i>	<i>87</i>
<i>Appendix D: MG² External-Type CLD Installation Guide</i>	<i>120</i>

LIST OF FIGURES

Figure 1. High-Mast Fixed Camera Mounting with Overpass Access	4
Figure 2. Halo-Style CLD.....	6
Figure 4. Detachable-type System Terminology	11
Figure 5. Stratus Internal Winch Tool with Integrated Electric Motor	12
Figure 6. MG ² Portable Winch Tool and Handheld Drill Motor Driver	13
Figure 7. MOOG Detachable CLD	14
Figure 8. Multiple CLDs Attached to a Single Pole.....	15
Figure 9. MG ² Disconnect Latch Stages	16
Figure 10. MG ² Disconnect Latch	17
Figure 11. MG ² Electrical Disconnect Blocks.....	18
Figure 12. MG ² E-Connector Installed	19
Figure 13. Camera Lowering Systems, Inc. Suspension Coupling Design.....	20
Figure 14. Camera Lowering Systems, Inc. Disconnect Bottom Half.....	21
Figure 15. Electrical Connector Block Comparison	22
Figure 16. Camera Lowering Systems, Inc. Disconnect Top Half.....	23
Figure 17. Camera Lowering Systems, Inc. Camera Pendant Lowered.....	24
Figure 18. MG ² Internal-Type CLD Design	25
Figure 19. Camera Lowering Systems, Inc. Internal-Type CLD Design	26
Figure 20. MG ² External-Type CLD System, CA50 at El Dorado Hills Blvd.	28
Figure 21. Bay Bridge High-Mast MG ² Internal-Type CLD System	29
Figure 22. Halo High-Mast Lighting Application	31
Figure 23. Basic Halo Diagram, Halo-Style CLD Systems Deployed by Caltrans	32
Figure 24. Caltrans District 3 Stratus CLD, I-80 at Rocklin Rd. Exit	34
Figure 25. Caltrans District 3 Stratus CLD, I-5 at Richards Blvd Exit	35
Figure 26. Caltrans Modified Base.....	37
Figure 27. MG ² Internal-Type Mounted Pole	38
Figure 28. Meyers MG ² Internal-Type CLD Site Location.....	40
Figure 29. MG ² Internal-type CLD Pole Footing.....	41
Figure 30. Crane Truck Erecting Pole.....	42
Figure 31. PVC Conduit Assembly	43
Figure 32. Pole Tenon Electrical Connections	44
Figure 33. Inside Pole Base	45
Figure 34. Pole Top Assembly	46
Figure 35. MG ² CLD Winch Tool Attached.....	47
Figure 36. Cable Clamp	48
Figure 37. Attaching Coupling Junction Box.....	49
Figure 38. MG ² Internal-Type Coupling Junction Box.....	50
Figure 39. Fully-Assembled Camera, Pendant Lowered.....	51
Figure 40. El Dorado Hills MG ² External-Type CLD Site Location.....	53
Figure 41. Caltrans External-Type CLD Legacy Retrofit	55
Figure 42. MG ² CLD Upper Box.....	56
Figure 43. MG ² External-Type Lower Box	57
Figure 44. MG ² External-Type CLD Cable Clamp	58
Figure 45. Coupling Junction Box Assembly	59
Figure 46. MG ² External-Type CLD Top of Pole , Fully Assembled	60
Figure 47. Lowering CCTV Camera MG2 External-Type CLD.....	61
Figure 48. Caltrans Meyers Traffic Camera Image	63
Figure 49. As-Built Meyers MG ² Internal-type CLD Site.....	64
Figure 50. Meyers MG ² Lowering Winch Tool.....	65
Figure 51. Meyers MG ² Lowering Camera Pendant	66
Figure 52. Hand Cranking Winch.....	67
Figure 53. CCTV Camera Replacement.....	68
Figure 54. Caltrans El Dorado Hills Traffic Camera Image	69
Figure 55. As-built MG2 External-Type CLD, El Dorado Hills.....	70

Figure 56. Winch Tool Receiver	71
Figure 57. MG² External-Type Lower Box	72
Figure 58. MG² External-Type Camera Lowering	73
Figure 59. CCTV Lens Cleaning	74
Figure 60. Bay Bridge MG² Internal-Type CLD Site	75
Figure 61. Bay Bridge MG2 CLD Remote Eletronics Cabinet	76
Figure 62. Power Driving Winch Tool	77
Figure 63. Attach Winch Tool	78
Figure 64. Hand Guiding Winch Cable	79
Figure 65. Bay Bridge MG² Internal-Type CLD	80

LIST OF ACRONYMS AND ABBREVIATIONS

Acronym	Definition
AHMCT	Advanced Highway Maintenance and Construction Technology Research Center
Caltrans	California Department of Transportation
CLD	Camera Lowering Device
CSPE	Chlorosulfonated Polyethylene
DOT	Department of Transportation
DRISI	Caltrans Division of Research, Innovation and System Information
ITS	Intelligent Transportation System
MVDS	Microwave Vehicle Detection System
NEMA	National Electrical Manufacturers Association
PVC	Polyvinyl Chloride
PTZ	Pan-Tilt-Zoom
SR	State Route
TAG	Technical Advisory Group
TMC	Transportation Management Center

ACKNOWLEDGMENTS

The authors thank the California Department of Transportation (Caltrans) for their support, in particular Sidhu Gurdeep and Richard Hernandez with the Division of Maintenance, Dean Campbell with the District 3 TMC, and Sean Campbell with the Division of Research, Innovation and System Information. The authors acknowledge the dedicated efforts of the AHMCT team who have made this work possible.

CHAPTER 1: INTRODUCTION

Problem

The California Department of Transportation (DOT) (Caltrans), in order to meet Caltrans' 2020 Intelligent Transportation System (ITS) field equipment performance measures to be consistent with MAP-21 performance management targets, is utilizing an increasing number of Closed-Circuit TV (CCTV) cameras to monitor traffic and conditions on California's roadways. These sophisticated CCTV cameras need regular maintenance, troubleshooting, and repair or replacement. Often the necessary roadside cameras locations are innately more difficult to access by Caltrans standard lift equipment due to traffic hazards, roadside obstacles, and greater pole heights. These camera system sites require additional time, cost, and exposure to unsafe conditions to access, which consequently contributes to delayed or deferred camera maintenance and repairs.

Cracked enclosures, foggy or distorted images, power failure, and even network-related troubles are often the symptoms of delayed periodic camera system cleaning schedules of their connections leads, domes, and lenses. Ideally, these cameras are mounted at heights greater than 35 feet to provide the best field of view of a roadway and surrounding area. Caltrans often places CCTV camera systems mounted on standard-height poles on highway overpass structures to obtain a high vantage point while also maintaining service access with standard Caltrans boom trucks. Other locations are relatively flat and require the installation of high-mast poles. Direct personnel access to CCTV camera systems on high-mast poles for service requires the use of special personnel lift equipment, safety training, and additional expense and time on-site. Even if a CCTV camera service agreement is to be purchased, the additional access cost of high-mast mounted camera systems is borne by the agency who pays for the service. Most camera maintenance is labor-related and is relatively quick, such that the access cost is the major component of the overall service cost. This imbalance often leads to deferred camera maintenance, resulting in poorer image quality, increased camera outages, and shortened camera life.

Need

With their expanding use of pole-mounted CCTV camera systems on the highway, Caltrans will be better served by expanding their selection of qualified, cost-effective, and maintainable camera lowering device (CLD) products. Whether Caltrans maintains the system directly or pays a vendor for a service contract, the cost and difficulty of accessing the CCTV cameras at the top of a high-mast pole is prohibitive and expensive if a CLD is not utilized. Therefore, Caltrans is interested in expanding use of CLD systems to simplify camera access at challenging sites. Caltrans has primarily relied on one type of CLD product, but other types of devices and products may provide additional benefits, such as eliminating the possibility of binding, reducing communication cabling requirements, and providing the ability to mount antennas external to the pole. Caltrans needs an evaluation leading towards the qualification of at least one additional, viable, and commercially available CLD system of a different design for Caltrans' purchase and deployment consideration.

Objectives

Purpose

In this study, the Advanced Highway Maintenance and Construction Technology (AHMCT) Research Center's research objective was to procure and evaluate two types of camera lowering devices manufactured by MG², Inc.,¹ in terms of their suitability for Caltrans use. Two types of MG² CLD systems were procured for this study: an Internal-type CLD (procured by AHMCT) designed to be integrated with an adapted pole and an External-mount-type CLD (provided by MG², Inc.) designed as a universal retrofit attachment to any existing pole. This research study also includes an evaluation of the previously installed MG² Internal-type CLD system mounted to a high-mast providing CCTV camera security coverage of the eastern approach to the new east span of the SF-Oakland Bay Bridge. The research will include observing and documenting system installation as well as evaluating these MG² devices for approximately one year of exposure to the environment. This task will also monitor the installation and operation of these MG² systems and explore how their design and performance differences may offer added benefits to the common Halo-style CLDs currently deployed on Caltrans highways.

Expected Benefit

The expected benefit of this research is to provide Caltrans with an expanded selection of pole-mounted CLD product options to choose from when specifying projects. These additional devices may prove to be more cost-effective, provide additional performance benefits, and/or require less effort to maintain in the field. The supplemental devices will be studied and evaluated with respect to consideration for addition to Caltrans Standard Plans and Specifications. Successful systems could significantly ease the maintenance burden for high pole-mounted CCTV cameras while avoiding the known issues of the existing Halo-style CLD systems currently used by Caltrans.

Scope

The goal of this research is to procure, install, and evaluate the performance aspects of both the Internal- and External-type MG² CLD systems. This research does not evaluate the structural integrity or structural acceptability of the CCTV lowering device, pole foundation bolthole pattern, or external mount device for Caltrans' use. The proposed work specifically aims to evaluate both the MG² integrated pole system, including internal lowering device, and the MG² external mount lowering device for retrofit attachment to an existing pole. The focus of the evaluation will be to determine if one or both of these systems provides a viable, cost-effective, and maintainable solution for Caltrans' CCTV lowering needs. Some of the key issues that will be addressed during this research study include:

- Documentation of the Caltrans installation of both the MG² Internal-type integrated pole and External-type add-on CLD systems.

¹ <http://www.loweringsystem.com/>

Advanced Camera Lowering Device for ITS Maintenance

- Documentation of the installation of a Caltrans standard Halo-style CLD system.
- How well the MG² CLD devices perform under a range of conditions, and what issues can be expected to be encountered.
- Observe and assess the necessary maintenance demands of the MG² devices, including lubrication and cleaning practices, and determine if there are any significant maintenance differences between the different device designs.
- Document the Caltrans Maintenance crews' field use of both the MG² internal and external add-on camera-lowering devices and solicit user comments.
- Consider the disconnect design performance characteristics.
- Determine whether any of the CLD designs require specific pole accommodations for the device to operate normally.

Background

Caltrans operates a vast array of CCTV camera systems to monitor highways for ITS transportation management, emergency response, and security purposes. The CCTV cameras are generally placed at high vantage points to maximize the area of view. The high vantage point locations on the highway are commonly structures, steel poles, or a combination of both. Caltrans will often place standard poles on overpass structures to obtain a higher vantage point while retaining access with standard light-duty lift truck equipment (Figure 1). In flat areas where a high vantage point for the CCTV cameras is needed, high-mast poles are often the only option. Since CCTV cameras require periodic maintenance, Caltrans standard boom trucks can be utilized to service Caltrans' standard 35-foot poles. High-mast pole heights are much greater than 35 feet, and therefore require more specialized high-lift equipment to access the camera mounted to the top of the mast for service. Often the additional cost to access these high-mast cameras results in delays in camera service.



Figure 1. High-Mast Fixed Camera Mounting with Overpass Access

CLDs are ideally suited to provide ready access to challenging camera system sites such as mounted up on high-mast structures, or even conventional height poles where standard man-lift trucks cannot park close enough to the pole to provide the required reach. This may be due to inaccessible shoulder terrain, roadside obstructions, or a lack of a safe traffic pullout along the highway or ramp, necessitating difficult lane closures. Utilizing a CLD at these types of challenging locations enables a worker on foot to access the pole and lower the camera package

for maintenance, repair, or replacement, mitigating any of these types of man-lift truck access issues. The deployment of CLD systems at challenging traffic camera sites thereby enhances maintenance crew access, which translates to timelier camera maintenance and repairs, resulting in reduced camera downtime and cost. The deployment of CLD systems also provides cost savings during the installation process. Since the CLD is installed on the pole laying on the ground for Internal-type CLD systems, there is no need for workers to directly access the top of the pole after the pole is installed. This, as previously explained, provides significant cost savings for high-mast and challenging access site applications. Installing the camera system at ground level eliminates the need for man-lift equipment, is safer for the workers, and simplifies the overall task. Only a crane truck, which only needs to reach more than halfway up the pole, is required to erect the pole.

Several manufacturers sell CLD systems that can be integrated with a high-mast pole. Only a few manufacturers offer a device that can be attached to an existing pole. Since all of these devices perform the same basic function of lowering a camera mounting from the top of a pole, they possess many of the same fundamental features, such as a cable winch system to raise and lower the camera/lighting package and locking mechanisms at the top of the high-mast pole.

These systems have a multitude of design differences, but all of the differences can be effectively categorized in one of two types based on how they account for the change in routing length of the electrical and signal cable between the raised and lowered positions on the pole. One design strategy is to maintain the electrical and signal connection to the camera and other devices mounted at the top of the pole and effectively double the cable lengths to accommodate the cable path from the ground to the top of the pole and back down to the ground. The second design strategy is to disconnect the camera and other devices from the electrical and signal cables at the top of the pole and lower only the camera mounting. For the purposes of this report, device designs which remain connected during lowering will be generally categorized as Halo-style camera lowering devices, while devices designed to disconnect the electrical and signal connection at the top of the pole will be generally categorized as Disconnect-type devices.

Halo-style CLD systems typically consist of a steel mounting ring which is wrapped around the pole that can be raised and lowered by cables from the top of the pole (Figure 2). The electrical and signal cables remain connected to the camera and other devices mounted to the lifting ring, and the extra cable length, when raised, remains inside the pole. For this, and other reasons, Halo-style systems are normally integrated with a pole and installed together.

The Detachable-type CLD (Figure 3) separates the camera enclosure and all cabling from the mounting at the top of the pole and only lowers the camera enclosure to the ground. Manufacturers have successfully installed and operated hundreds of both types of CLD systems throughout the world. Caltrans has many of the Halo-style systems installed and operational on California highways as part of their ITS infrastructure. Caltrans designated the subject of this report to focus primary on the MG² commercial line of Detachable-type CLD systems.



Figure 2. Halo-Style CLD



Figure 3. Detachable-Type CLD

Research Methodology

This research project supported the procurement and deployment of both the internal and external types of Detachable-type CLD systems manufactured by MG-Squared (MG²) company for testing on Caltrans highway roadsides. The Caltrans Transportation Management Center (TMC) operated CCTV cameras at these sites and Caltrans Maintenance crews provided all necessary service and maintenance to these CLD systems. AHMCT documented the installation and evaluated their operation and maintenance performance in normal use on the highway. The goal was to determine if one or both of these systems provide a viable, cost-effective, and maintainable solution for Caltrans' CCTV lowering needs. The specific issues addressed in this study include:

- 1) AHMCT procurement of one MG² Internal-type lowering device and integrated 50-foot high pole and one manual crank lowering device. The External-type MG² CLD system was procured by other means outside this project. AHMCT personnel worked with Caltrans and the vendor to coordinate system installation and training of both the Internal and External types of MG² CLD systems on the highway. AHMCT coordinated with Caltrans to attend and document the system installation and attend training on the recommended use and maintenance of the MG² CLD systems.
- 2) AHMCT monitored and evaluated the performance of the MG² CLD systems in the field under a range of conditions and identified any associated issues to be overcome or necessary accommodations. AHMCT visited each of the project's installation sites at reasonable intervals to participate in the lowering and raising of the CCTV camera using the MG² CLD systems. AHMCT acquired video of the lowering and raising the MG² CLD systems by Caltrans maintenance crews.
- 3) AHMCT documented any equipment failures and assessed maintenance demands for both devices.
- 4) AHMCT pursued suggestions and performance feedback from the Caltrans maintenance workers with direct field experience using either the MG² and/or Halo-style CLD systems on the highway.

Overview of Research Results and Benefits

Key contributions of this research project include:

- Description of the features, utility, and configurations of various CLD systems.
- Identification of CLD attributes, which translate to cost benefits for Caltrans.
- Indication of how CLD systems can increase the level of service to ITS camera systems on the highway.
- Documentation of the differences between Internal and External types of MG² CLD versions and their potential beneficial applications.
- Discussion regarding how the use of CLD systems positively contributes to Caltrans worker safety.
- Evaluation of Caltrans' use of CLD systems on the highway.
- Identification of potential problems with CLD systems in field usage.

Advanced Camera Lowering Device for ITS Maintenance

- Development of information to improve and/or broaden the range of CLD products available to Caltrans ITS in their effort to meet MAP-21 management targets.

CHAPTER 2: DETACHABLE-TYPE CLD DESIGN DESCRIPTION

Detachable-Type CLD - Common Features

Detachable-type CLDs are designed to support and lower a pendant, environmental dome, network closed-circuit television camera, lens, housing, Pan-Tilt-Zoom (PTZ) mechanism, cabling, connectors, and other supporting field components without damage and without degradation of camera operations. The lowering device consists of three key components: a suspension coupling, a camera-lowering support arm, and a Tenon pole-top transition adapter (Figure 4). The support arm and receiver brackets are designed to self-align the contact unit with the pole centerline during installation and to insure the contact unit cannot twist under high wind conditions. Detachable-type lowering devices suspension coupling units typically have a load capacity of 300 lb or greater. Locking mechanisms within the coupling are designed to support the full weight of the CCTV, PTZ, and environmental dome enclosure with two latch arms which act between the fixed (top) and moveable (bottom) contacts of the suspension coupling. The latching mechanism securely holds the camera and its control equipment free of vibration or motion between the components. The latching mechanisms operate by alternately raising and lowering the assembly using a winch and lowering cable assembly. When latched, all weight is removed from the lowering cable. The fixed unit has heavy-duty cast tracking guide(s) and means to allow latching in the same position each time. The contact unit housing is weatherproof with a replaceable gasket provided to seal the interior from dust and moisture. Detachable CLD systems are mated to supporting poles in one of two ways. The CLD system can be purchased integrated onto a custom pole, which is typically referred to as an Internal-type system, or attached to an existing in-place pole, referred to as an External-type system.

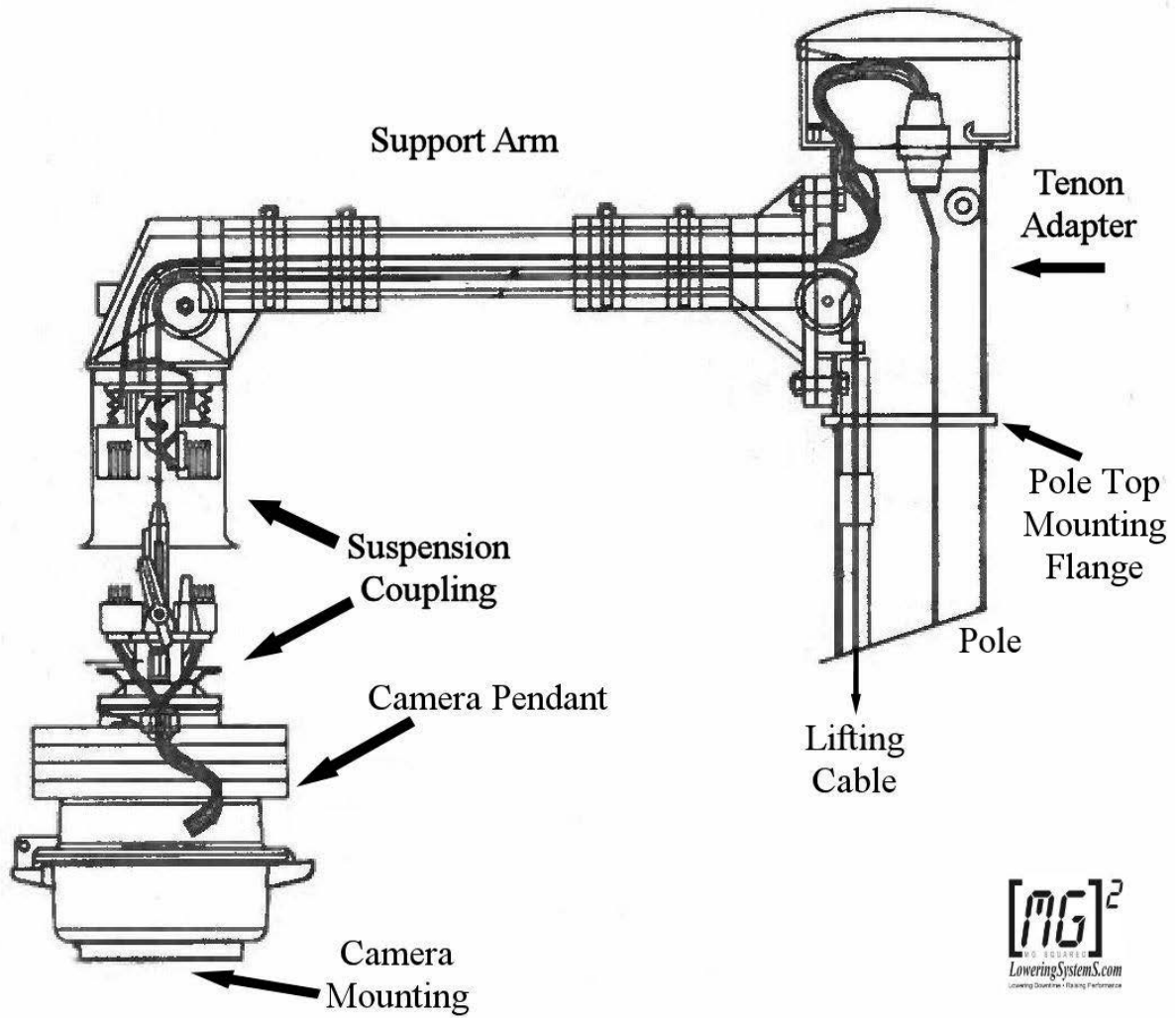

**Figure 3. Detachable-type System Terminology (Internal Mounting Shown)
(Image courtesy of MG²)**

To raise and lower the camera pendant on a conventional Detachable-type CLD system, the free end of the lifting cable is connected to a cable wrapped around the spool of a lifting winch assembly attached near the base of the pole. The lifting winch can either be rigidly mounted inside the pole and accessed through a hand-hole (Figure 5) or be configured for use with a portable winch tool that can be quickly attached to the pole when raising and lowering the camera pendant (Figure 6). Furthermore, the internally-mounted winch tool can be incorporated with an electric motor or as a connection to be driven with a separate handheld electric drill motor and socket adapter. The portable winch tool is provided with attachments such that the lifting can be driven by either a hand crank or a handheld electric drill motor using a socket adapter. Portable winch tools are interchangeable within a product family and can be utilized on any number of similar sites. There are a number of advantages and disadvantages to consider when selecting which winch configuration is best suited for any specific situation. In general, high-mast poles generally benefit

Advanced Camera Lowering Device for ITS Maintenance

from internal winch systems, whereas shorter poles and External-type CLD products tend to warrant the portable winch system.



Figure 4. Stratus Internal Winch Tool with Integrated Electric Motor



Figure 5. MG² Portable Winch Tool and Handheld Drill Motor Driver

An alternative Detachable-type CLD system offered by MOOG is similar in function to conventional CLD products, but the winch mechanism is integrated into the support arm and controlled electrically from the ground (Figure 7). The benefit of this type of design is a more compact, self-contained system. The logical downside of this configuration is that any problems encountered with the winching mechanism would necessitate access to the top of the pole to mitigate. This would be particularly problematic on high-mast poles where direct access to the top of the pole would require special high-lifting equipment.

Detachable-type CLD products can innately be configured with multiple units mounted on the same pole (Figure 8). Each of the CLD systems would be operated independently and could possibly share a common winch tool. The size of the pole must obviously be larger to handle the load due to multiple CLD systems. The maximum number of CLD systems attached to a single pole would theoretically be limited to three spaced at ninety degrees such that the open sector would be the safe zone for a worker to access the winching tool.

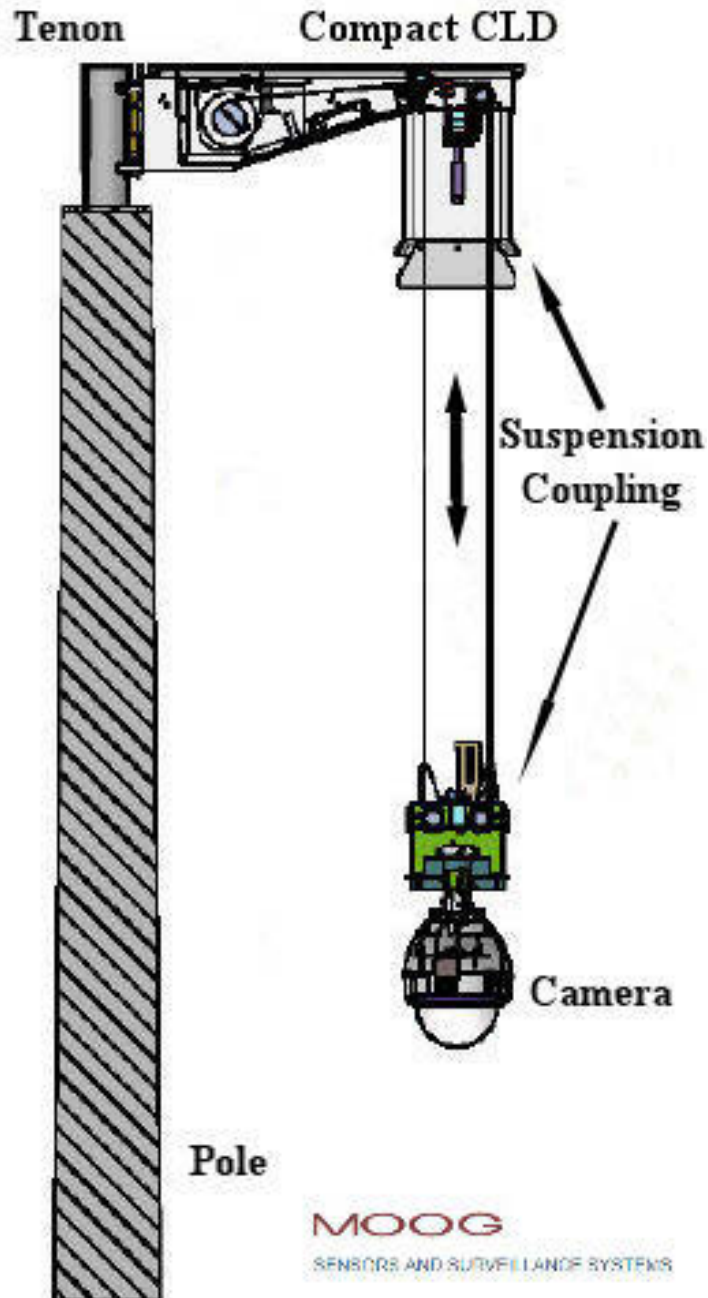

Figure 6. MOOG Detachable CLD (Image courtesy of MOOG)



Figure 7. Multiple CLDs Attached to a Single Pole (Image courtesy of MG²)

Detachable-Type CLD - Suspension Coupling Designs

The design specifics of the suspension coupling are both a unique and critical component of a detachable type of camera lowering system that greatly influences the performance and maintainability of a particular product. Suspension coupling performs two distinctive functions: one as a mechanical latch, and the other as an un-pluggable electrical junction. Means of locking the camera pendant into a repeatable position in the suspension coupling at the top of the pole and relieving all tension on the lifting cable when connected are important performance and safety features. The means of mechanical latching must be remotely actuated from the ground either electrically or, more assuredly, with the lifting cable. The pluggable electrical disconnect connection in the suspension coupling must be weather-resistant and support the connection of various coaxial, electrical power, and signal connections necessary to operate multi-function remote camera systems. Two of the major manufacturers and distributors of disconnect CLD systems with different suspension coupling designs are MG² and Camera Lowering Systems, Inc.² A self-contained compact CLD system offered by MOOG³ will also be briefly described for reference purposes.

² <http://lowering-device.com/camera-lowering-systems>

³ <http://www.moogs3.com/products/video-accessories/poles-lowering-devices.html>

MG² Suspension Coupling Design

The MG² disconnect latch mechanism in the Suspension Coupling operates in a cycle of five stages: Locked, Unlocking, Lowering, Raising, and Locking (Figure 9). The Support Arms travel in a cyclic path of locking and unlocking as the mechanism is repeatedly lifted to the top of travel and lowered. The latching stages always begin and end with the Disconnect Unit in the latched and locked position. During lifting, the latch mechanism is designed to self-align into the same position each time the assembly is raised and locked. The Guide Post in the center of the bottom half of the Disconnect Unit (Figure 10) centers itself in the tracking guide and rotates into its original orientation as the Guide Post's cast-in-place key follows the inclined helical surface of the Tracking Guide. The Guide Post prevents misconnections and provides accurate mating without relying on contact pins to provide the final alignment. In the locked position, the latching mechanism twin tracking Support Arms support the entire weight of the camera with no tension on the lifting cable up to a maximum of 600 lb for safety factor calculations.

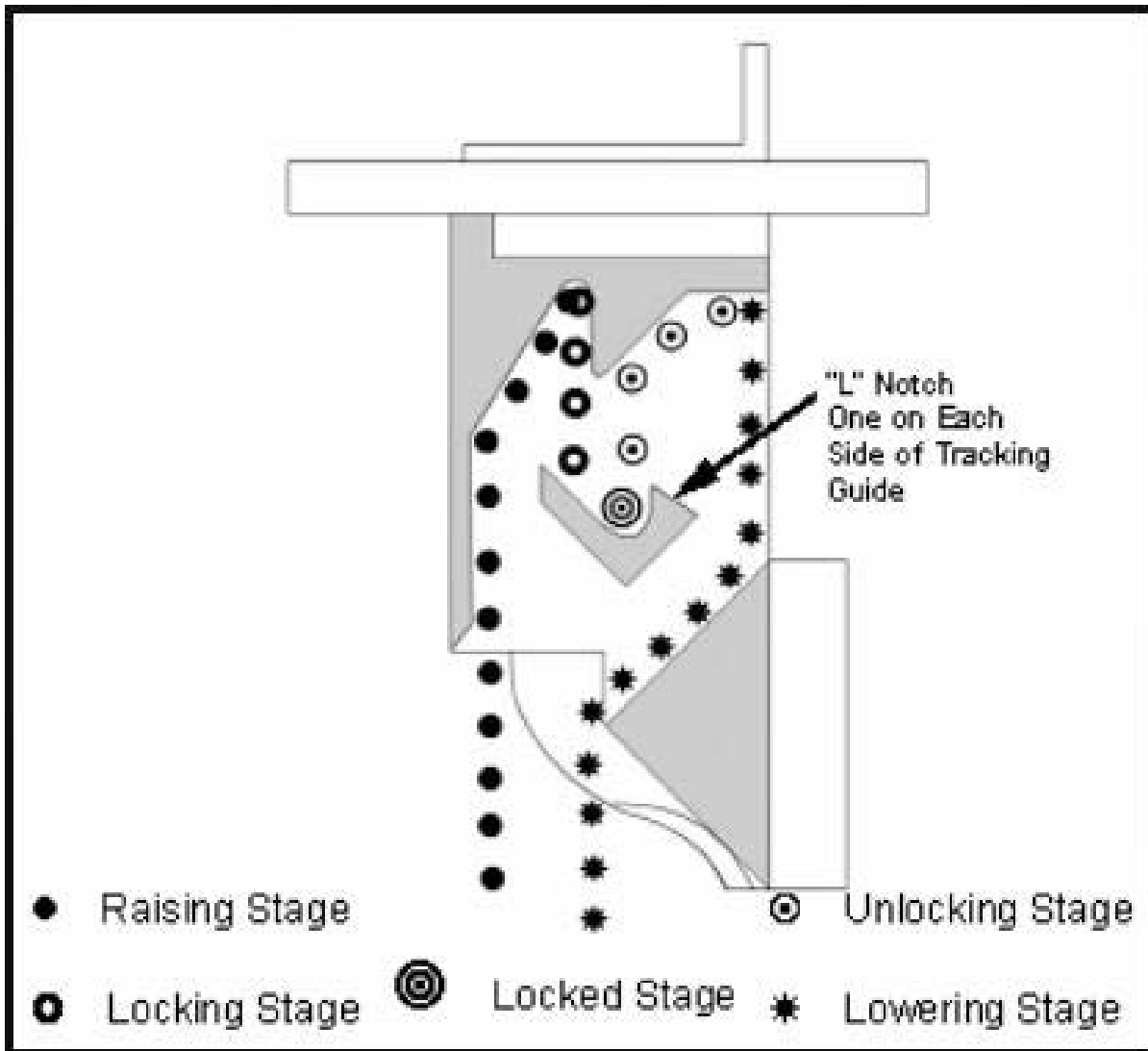

Figure 8. MG² Disconnect Latch Stages (Image courtesy of MG²)

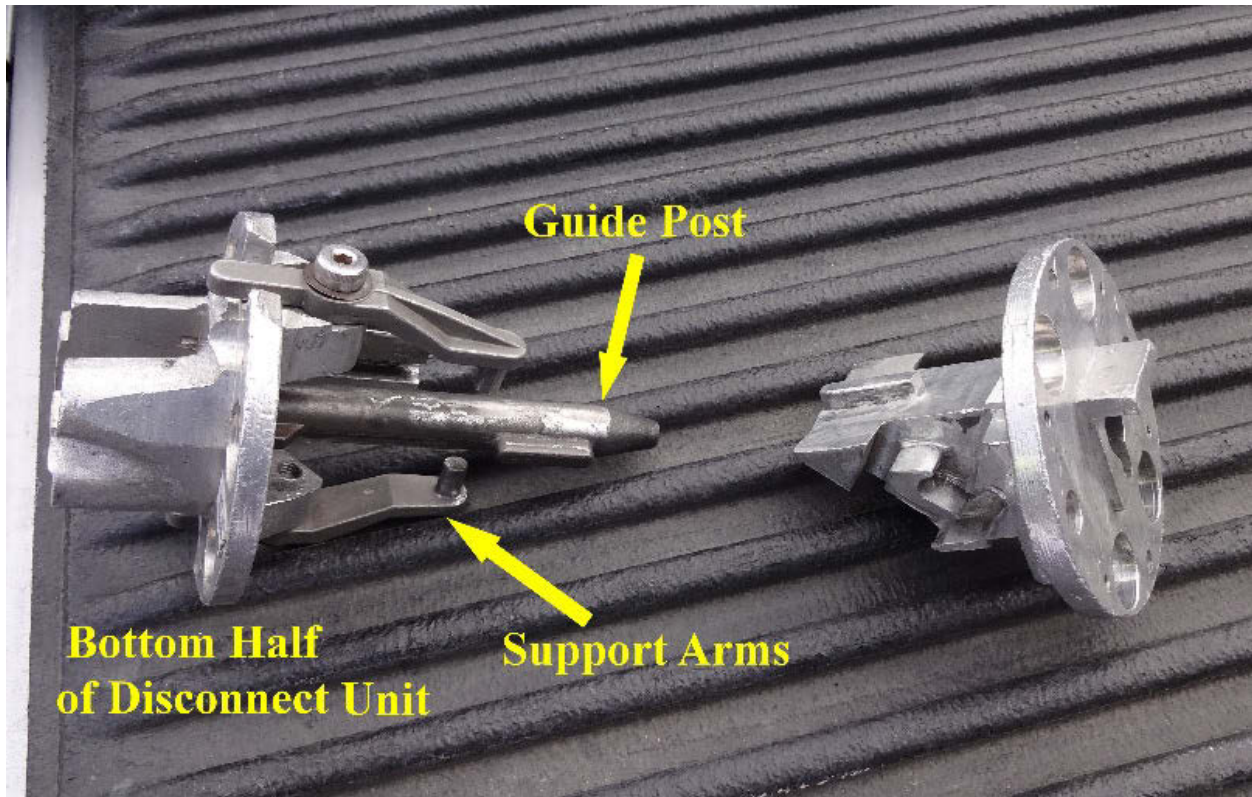

Figure 9. MG² Disconnect Latch

The MG² electrical disconnecter blocks are encased in Haplon® (Chlorosulfonated Polyethylene, CSPE) synthetic rubber with gold-plated electrical contact pins (Figure 11). CSPE is noted for its resistance to chemicals, temperature extremes, and ultraviolet light, which makes it a better choice for this specific application over standard thermoplastic electrical connector body materials. Once connected, the CSPE electrical disconnecter block constricts the pin surfaces so that approximately 10 lb of pull force is required to separate the contact block, which eliminates the probability of developing a loose contact connection.

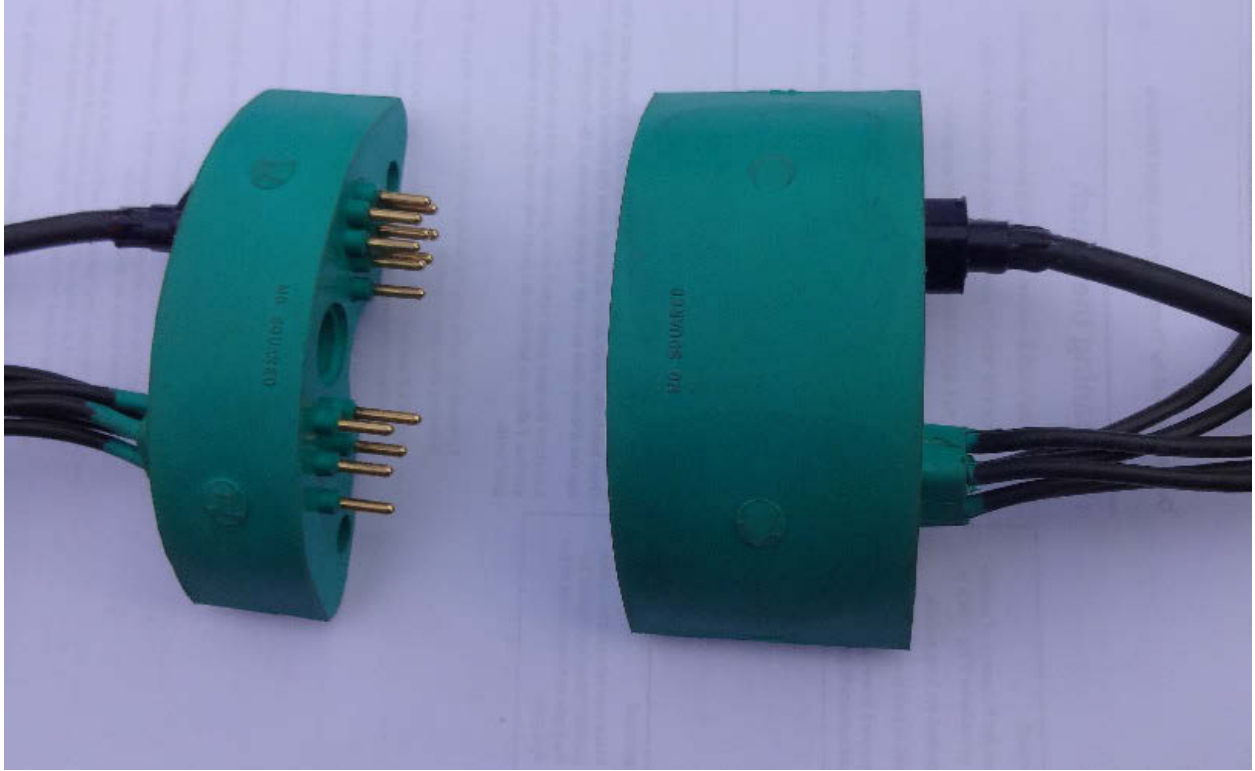

Figure 10. MG² Electrical Disconnect Blocks



Figure 11. MG² E-Connector Installed

The Camera Lowering Systems, Inc., Suspension Coupling has a similar operating principle to the previously described MG² product. The coupling separates at the top of the pole and the camera pendant and the camera, suspended by a lifting cable, can then be lowered to near the ground with a winch tool (Figure 13). The Camera Lowering Systems, Inc., disconnect latch mechanism also has two Locking Cams (Figure 14) that support the entire weight of the camera and camera junction box when the unit is in the locked position. The Locking Cams are rated to withstand loads up to

400 lb, calculating for safety factors. The Guide Post in the center of the bottom half of the Disconnect Unit centers itself in the tracking guide and rotates into its original orientation.



**Figure 12. Camera Lowering Systems, Inc. Suspension Coupling Design
(Image courtesy of Camera Lowering Systems, Inc.)**

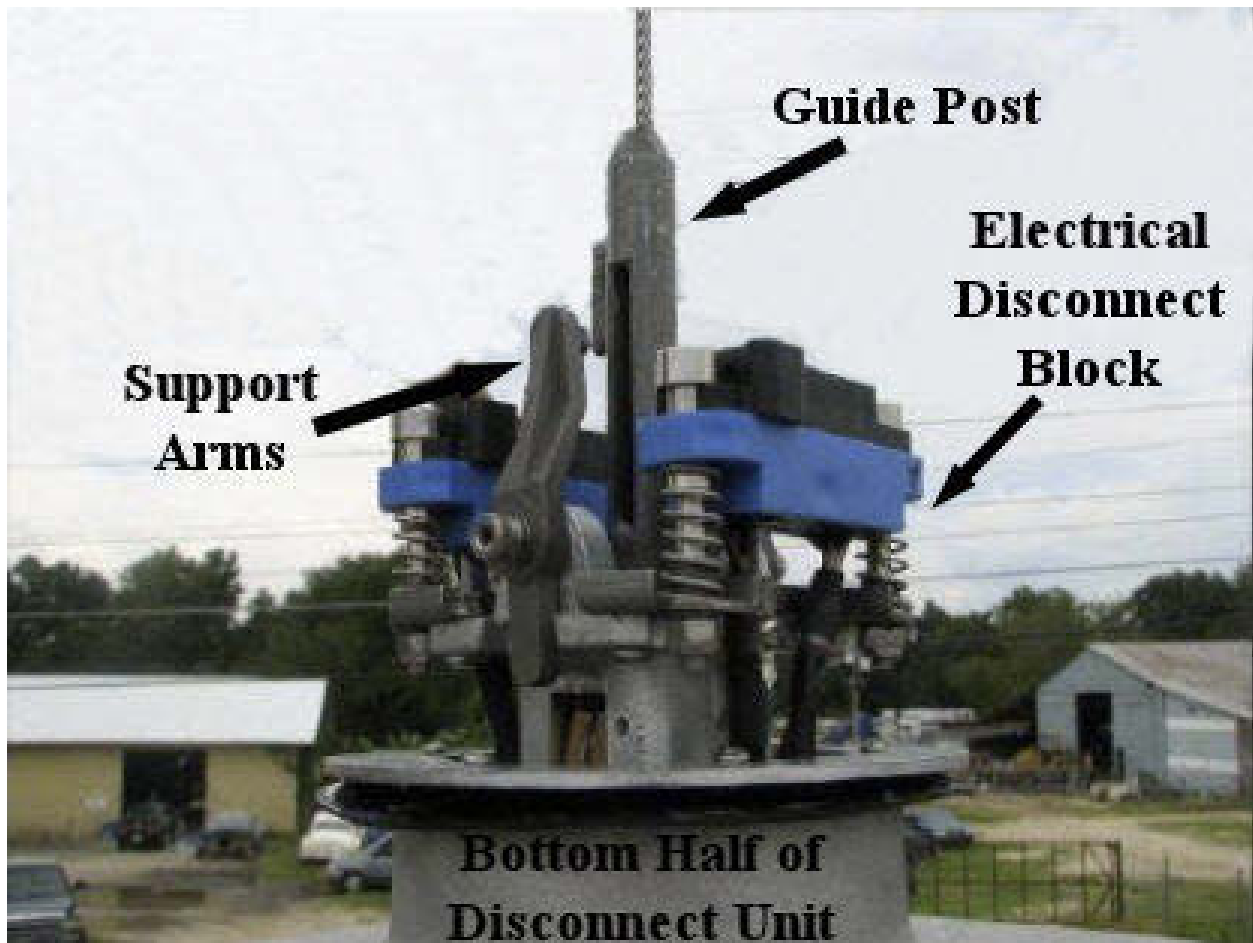

**Figure 13. Camera Lowering Systems, Inc. Disconnect Bottom Half
(Image courtesy of Camera Lowering Systems, Inc.)**

The Camera Lowering Systems, Inc., electrical connector block operates in a similar principle to the MG² version, but there are some critical variations. The key difference lies with the Disconnect Unit design. The Camera Lowering Systems, Inc., electrical disconnect block design relies on lighter-duty electrical pluggable connectors and requires spring and guide pins to ensure a positive mating (Figure 15).



Figure 14. Electrical Connector Block Comparison



**Figure 15. Camera Lowering Systems, Inc. Disconnect Top Half
(Image courtesy of Camera Lowering Systems, Inc.)**



**Figure 16. Camera Lowering Systems, Inc. Camera Pendant Lowered
(Image courtesy of Camera Lowering Systems, Inc.)**

Detachable-Type CLD – Internal Mounting Systems

Internal-type CLD systems entail the customization of the pole to support the attachment of the CLD hardware and cabling. Consequently, the pole and CLD system are normally purchased together as a mated pair. The pole modifications at the base end of the pole mostly consist of supporting the attachment of the winch tool in a hand-hole flange and a parking ring to secure the Lifting Cable. The top end of the pole is terminated with an appropriate flange in which to attach the Tenon Adapter. The Tenon Adapter contains all the necessary connections to mount the CLD hardware. The Lifting Cable and all electrical cables are run through the inside of the pole from bottom to top, providing a clean outside pole appearance. The Lifting Cable, in addition, runs through a 1”-diameter polyvinyl chloride (PVC) conduit to prevent the lifting cable from rubbing against the electrical cables during lifting and potentially causing damage.

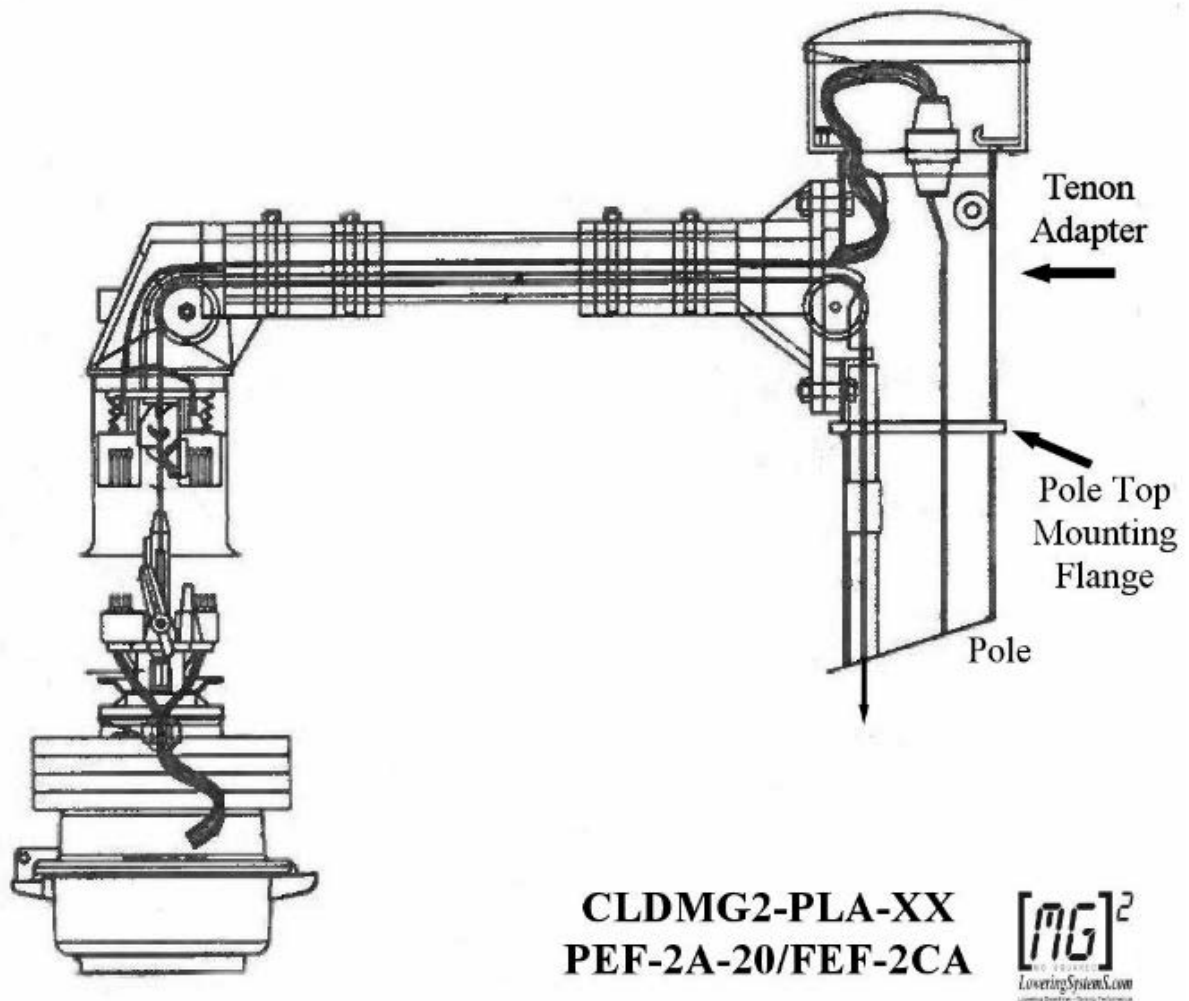

Figure 17. MG² Internal-Type CLD Design (Image courtesy of MG²)

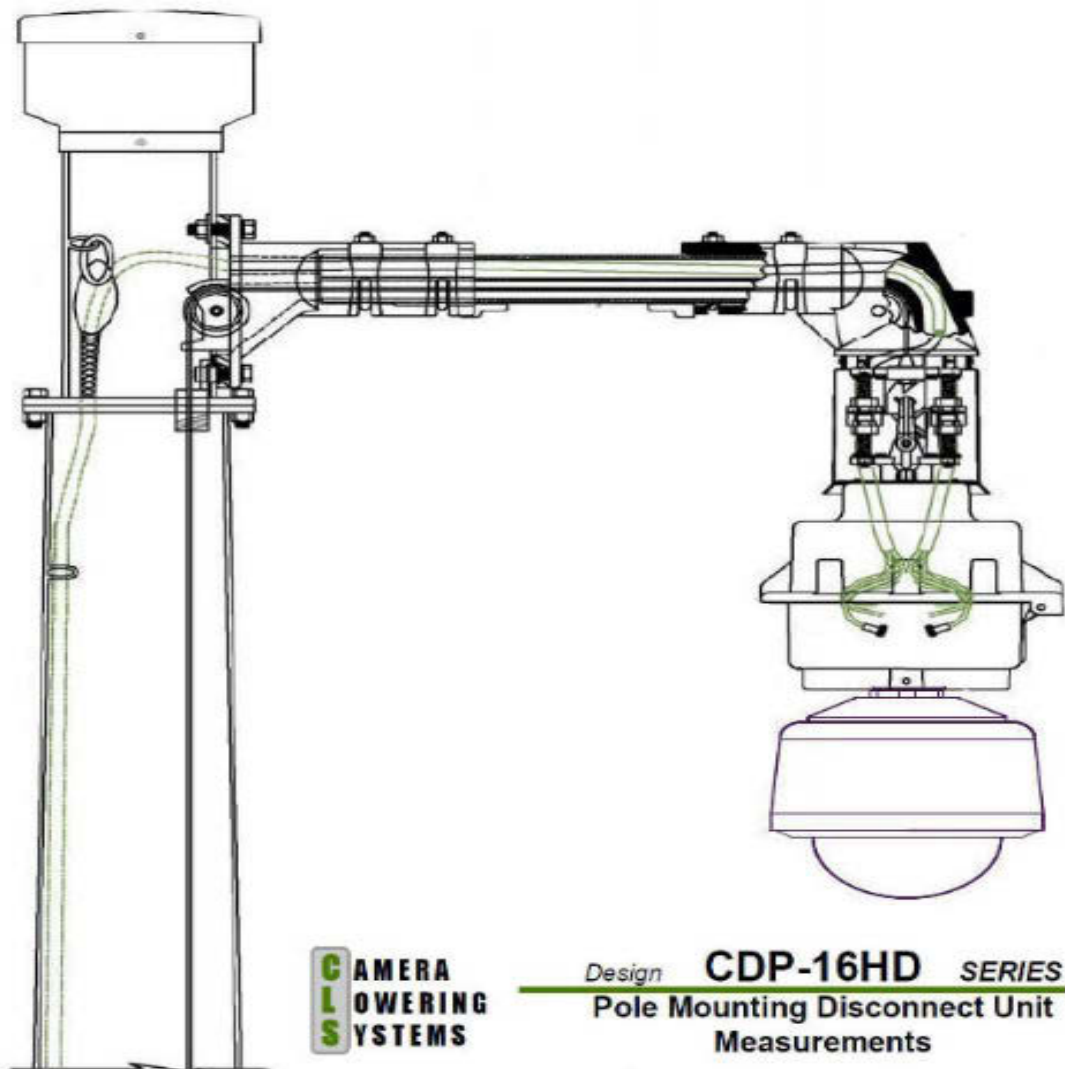

Figure 18. Camera Lowering Systems, Inc. Internal-Type CLD Design
(Image courtesy of Camera Lowering Systems, Inc.)

Detachable-Type CLD – External Mounting Systems

Detachable-Style CLD External Pole Mounting – Common Features

External-type CLD systems are a product line explicitly designed as a means of providing camera-lowering capabilities to existing in-place poles or structures. Unlike Internal-type CLD products, which rely on integrated pole attachment features, External-type CLD systems are specifically designed to be fully self-contained and not contingent upon the supporting structure containing any unique features and/or modifications. Halo-style systems, due to their fundamental operational principle, are innately dependent on integrated support-pole features and consequently cannot be efficiently retrofitted in-place. Only Disconnect-type camera lowering devices with their characteristic cantilevered support arm afford the opportunity of configuring the system for

straightforward attachment to in-place support surfaces. The operating principle of both the Internal and External types of CLD systems are identical, and the bolt-on winching mechanism is interchangeable for each product family.

Since the primary application of External-type CLD products is the retrofitting of common existing tapered steel poles, the commonly stocked CLD mounting hardware components are generally designed to be banded to large round surfaces. Rigid wall galvanized steel 1"-diameter conduit(s) are run from the bottom Winch Box up to the Upper Mounting Box which is securely banded to the supporting pole. The conduit must be axially stiff to resist the compressive loading caused by the weight of the camera pendant which acts to pull the Winch Box up the tapered pole. The Support Arm of the CLD attaches to the Upper Mounting Box which is banded to the top of the pole. The Lifting Cable is run down one conduit to the Winch Box, and the electrical cables are either run down the inside of the pole or in a second external conduit run. Since all of the External-type CLD hardware is attached to the support structure surface, the install does not look nearly as clean as the Internal-type CLD system product line.

Since the installation of the External-type CLD system is conducted on an already erected structure, high-lift equipment is an essential necessity to access the top of the pole. In contrast, the Internal-type CLD system is assembled on the ground and then raised up such that high-lift equipment is not required, which improves worker safety as well. Therefore, External-type CLD systems are far less cost efficient than Internal-type CLD systems for high-mast pole applications. For example, consider the SF-Oakland Bay Bridge MG² Internal-type CLD system which is mounted on a 90-foot high-mast pole (Figure 20). Direct access to the top of a pole of this height to install an External-type CLD system would be prohibitively expensive and hazardous. Therefore, External-type CLD installations should ideally be limited to sites where ready access to the support structure is practical.



Figure 19. MG² External-Type CLD System, CA50 at El Dorado Hills Blvd.



Figure 20. Bay Bridge High-Mast MG² Internal-Type CLD System

CHAPTER 3: HALO-STYLE CLD – DESIGN DESCRIPTION

Halo-Style CLD - Common Features

Halo-style lowering systems are ideally suited for high-mast lighting applications (Figure 21) but can also support a multitude of other electronic packages, such as CCTV cameras, antennas, and electrical enclosures. The distinctive element which defines a Halo-style CLD system is a steel mounting platform ring which wraps around the pole and is raised and lowered by cables from the top of the pole. All electrical and signal cables remain connected to the various electronic devices mounted on the lifting ring when lowered. Consequently, the length of the connecting electrical cables is almost twice as long as the pole height to account for the extra distance when the mounting ring is lowered to the ground. Lifting is accomplished by a single lifting wire cable running from a winch system attached to the pole near the ground up the inside of the pole. The lifting cable splits into three cables and connects the lifting ring over three pulleys mounted at the end of short cantilever arms equally spaced radially at the top of the pole (Figure 22). A latching mechanism, which locks the mounting ring at the top of the pole and takes all the weight off the lifting cable when latched, is a common safety option. Better latching mechanism designs account for a fair amount of misalignment of the mounting ring during mating caused by unbalanced loading and wind effects. The design configuration of the Halo system implicitly necessitates that a custom pole be included to support the functional operation of the Halo system.



Figure 21. Halo High-Mast Lighting Application



Figure 22. Basic Halo Diagram, Halo-Style CLD Systems Deployed by Caltrans

Advanced Camera Lowering Device for ITS Maintenance

Several companies manufacture similar variations of Halo-style CLD systems. Caltrans District 3 has several Halo-style CLD systems deployed throughout their district; most of these are sold and supported by Stratus Products. These Stratus CLD systems are designed with three separate equipment mounting arms equally spaced on the Ring Platform. Additional electronic devices can be attached to each of these mounting arms. Weight plates are utilized to account for the potential of uneven loading keeping the whole assembly balanced and minimizing docking misalignment when raising the Ring Platform. One benefit of the Halo-style system is that the mounting of a wide array of electronic packages on the mounting ring enables much of the electronic support components to be mounted in electrical enclosures attached directly to the mounting ring, which possibly reduces the overall number of conductors running up the pole. Another advantage is that the camera system can be operated when lowered to the ground, aiding in troubleshooting and commissioning.



Figure 23. Caltrans District 3 Stratus CLD, I-80 at Rocklin Rd. Exit



Figure 24. Caltrans District 3 Stratus CLD, I-5 at Richards Blvd Exit

CHAPTER 4: TRIAL MG² CLD SYSTEMS PROCUREMENT AND INSTALLATION

MG² Internal-Type System Procurement

The MG² product line of camera lowering devices was selected by Caltrans as the subject of this evaluation study. The goal of this research project was to procure one MG² Internal-type CLD and one MG² External-type CLD, have Caltrans install both systems on the highway, and conduct evaluations. Caltrans based the equipment budget of this research project on a MG²-supplied cost quote, which was based on a standard 50-foot steel pole and mounting flange. During the actual procurement process, the standard pole specification provided by MG² was reviewed by Caltrans structural engineer(s) and a determination was made that the size of the pole mounting base flange needed to be significantly increased to meet Caltrans minimal structural requirements (see Appendix A). MG² updated their purchase quote to reflect the change in the pole specification, which resulted a substantial purchase price increase for the Internal-type camera lowering system pole. This price increase exceeded the research project budget for both systems, such that only the Internal-type lowering system could be purchased with the available funds. The AHMCT purchase was consequently changed to procure only the MG² Internal-type system. The External-type system had to be procured by Caltrans through different means. The MG² Internal-type CLD and pole were delivered to Caltrans in December 2017 (Appendix B).



Figure 25. Caltrans Modified Base



Figure 26. MG² Internal-Type Mounted Pole

MG² Internal-Type System Installation

Caltrans' selected site for the installation of the AHMCT trial MG² Internal-type CLD system and integrated 50-foot pole was at the intersection of US 50 and State Route (SR) 89 in the South Lake Tahoe area (Figure 28). It was mounted on the north side right of way of the intersection adjacent to US 50. This location will provide the CCTV camera and integrated PTZ unit at the top of the pole a view of both directions on US 50 and an eastward view of SR 89. A concrete footing for this specific pole had been previously installed (Figure 29). The pole was delivered to the installation site and the MG² CLD components brought to the site by Caltrans TMC personnel. The pole purchase specifications were for a galvanized outer finish, but special Lake Tahoe environmental restrictions apply to this site, requiring that tall poles be color-matched to the natural surroundings. In this case, Caltrans crews painted the pole brown at the work site to satisfy this

Advanced Camera Lowering Device for ITS Maintenance

restriction. Several Caltrans Electrical Maintenance and TMC personal, including service vehicles, were involved in the installation, which was conducted on December 19, 2017. AHMCT was present to observe the installation. An MG² factory-trained installation representative was on-hand to guide the installation procedure and assist Caltrans with the assembly and testing of the lowering system on the pole. It is common policy among the major manufacturers to require that a manufacturer representative be present to guide every installation of their products in the field to ensure the CLD system is installed and operating correctly. In addition to the on-site installation training, MG² provided a written set of installation instructions that provide a step-by-step set of instructions for the recommended installation procedure (Appendix C).

Advanced Camera Lowering Device for ITS Maintenance

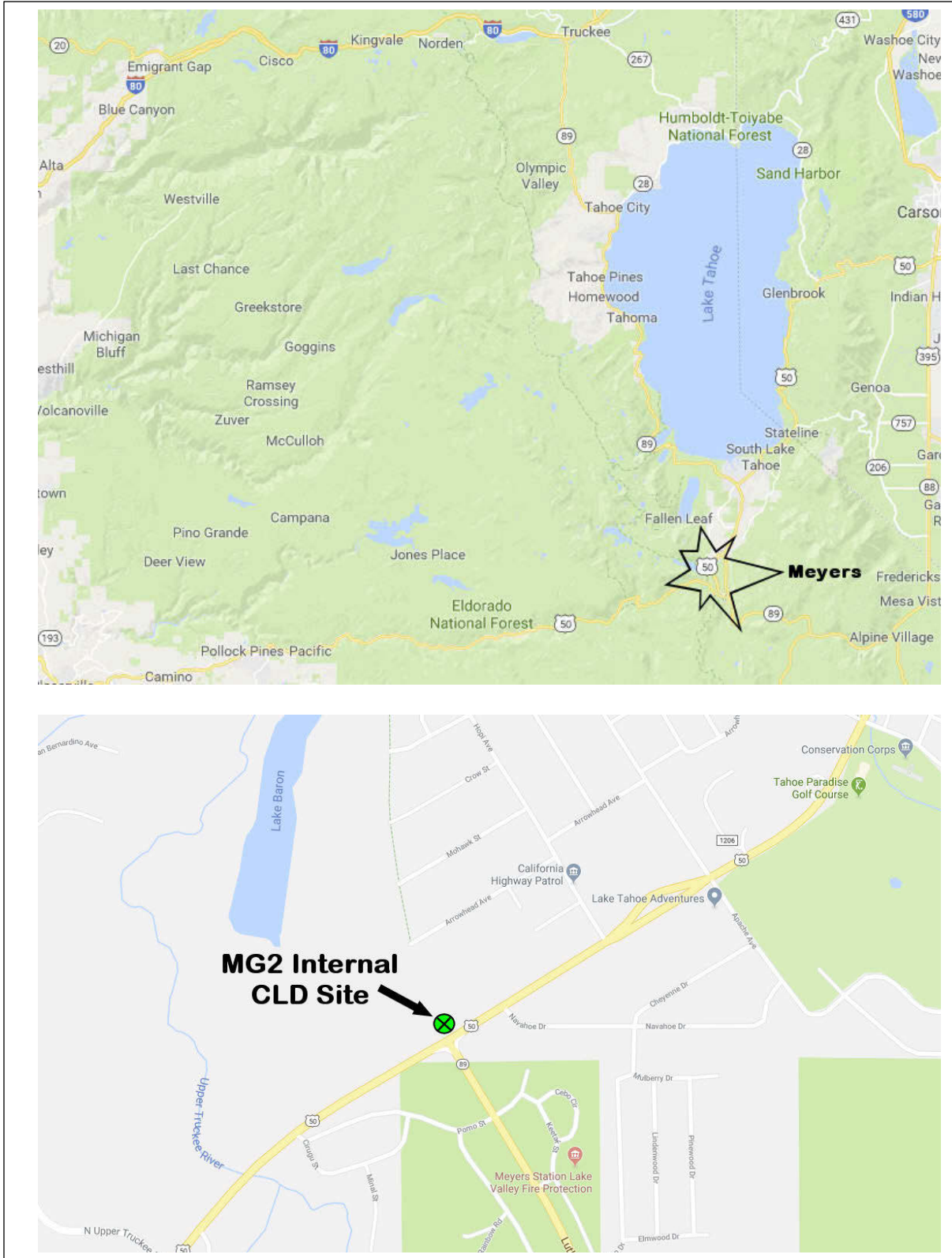

Figure 27. Meyers MG² Internal-Type CLD Site Location

The on-site installation team consisted of a combination of Caltrans personnel and contractors who concentrated on completing different tasks, but often collaborated together. The Caltrans Maintenance electrical personnel were generally responsible for the CLD hardware installation-related tasks: the Caltrans TMC electrical personnel and video network contractor focused on the camera connections and operation, and the electrical contractor attended to pole erection-related tasks. Since all of the MG² system assembly tasks are completed with the pole laying on the ground, a bucket lift truck was not needed to access the top of the pole. The only piece of heavy equipment required was a crane truck that was brought by the electrical contractor to lift the fully assembled pole in place (Figure 30). Otherwise, PVC conduit and common hand tools listed on page 4 in Appendix C were all that was needed to assemble the MG² Internal-type CLD system. MG² supplies all the hardware and components necessary to assemble the Internal-type CLD except the 1”-diameter PVC conduit.



Figure 28. MG² Internal-type CLD Pole Footing



Figure 29. Crane Truck Erecting Pole

The MG² CLD installation process begins with a pre-installation checklist described in detail in Appendix C. The pole is then prepared for assembly by determining the site-specific orientation of the pole base hand-hole and the camera support arm. The camera support arm should be pointed toward the direction of the highway for the least obstructed camera view, and the hand-hole should be in a safe location for workers to stand when accessing the hand-hole, but for safety purposes not directly under the camera pendant. A pole-top Tenon Adapter is bolted to the flange at the top of the pole, taking notice of the camera support arm attachment point orientation. A PVC conduit is assembled inside the pole running from the hand-hole up to the Conduit Fitter adapter which attaches to the Tenon (Figure 31). The Lowering Device arm assembly is then placed next to the pole-mounted Tenon Adapter and the steel lifting cable is fished down through the PVC conduit in the pole. At the same time, the electrical and signal cables are run through the main body of the

pole from the hand-hole to the Tenon Adapter where all of the electrical connections join together with the Lowering Device arm assembly (Figure 32).

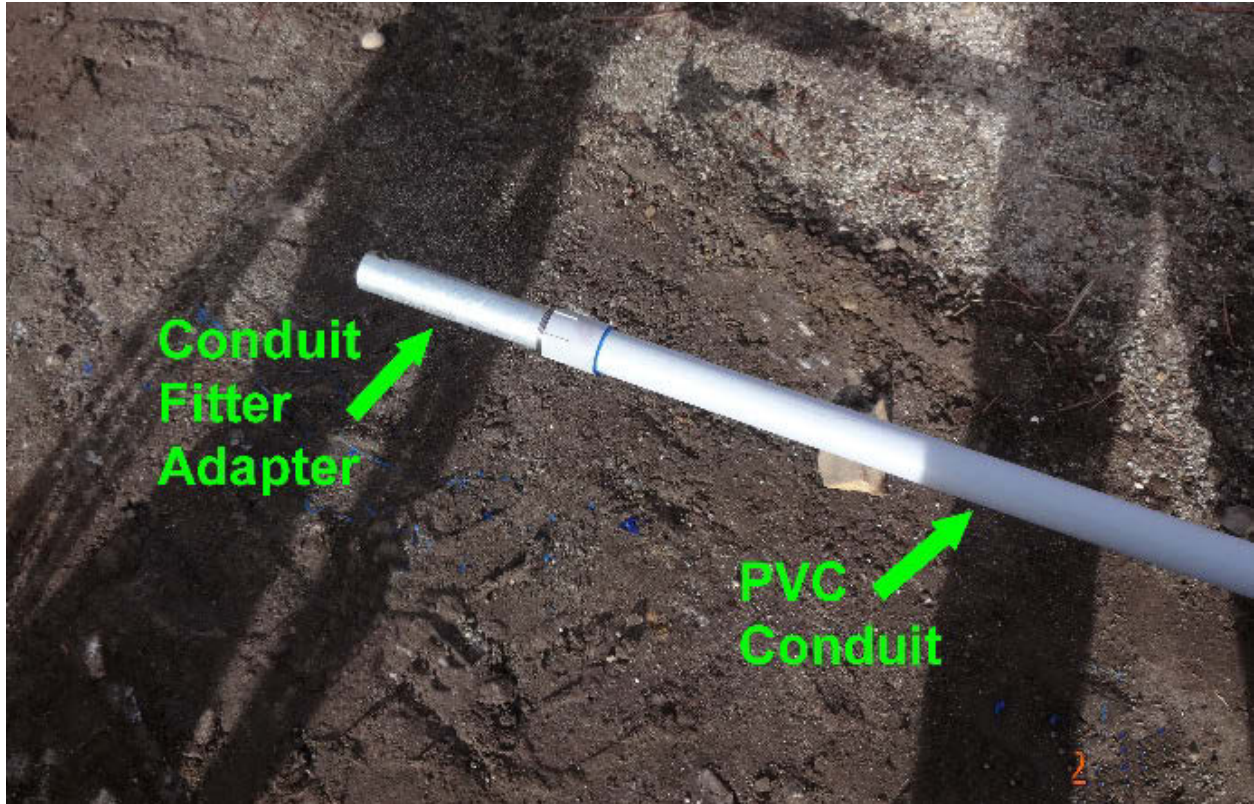

Figure 30. PVC Conduit Assembly



Figure 31. Pole Tenon Electrical Connections

Once the Lowering Device is bolted to the Tenon, the Quicklink (oval-shaped, threaded connecting link) is attached to the Parking Stand mounting ring welded near the upper edge of the hand-hole (Figure 33). During installation only, it is a useful time saver to add one additional Quicklink in the series to aid in determining where to terminate the opposite end of the cable. The Pole-Top Junction Box is attached to the Tenon Adapter which protects the pole top electrical connections from environmental exposure (Figure 34). A pull cord is attached to the bottom contact of the lowering device coupling to ensure the partially assembled pendant can be lowered. It is important to have the Coupling unlatched while setting the pole. The pole is then stood up and the anchoring bolts are tightened.

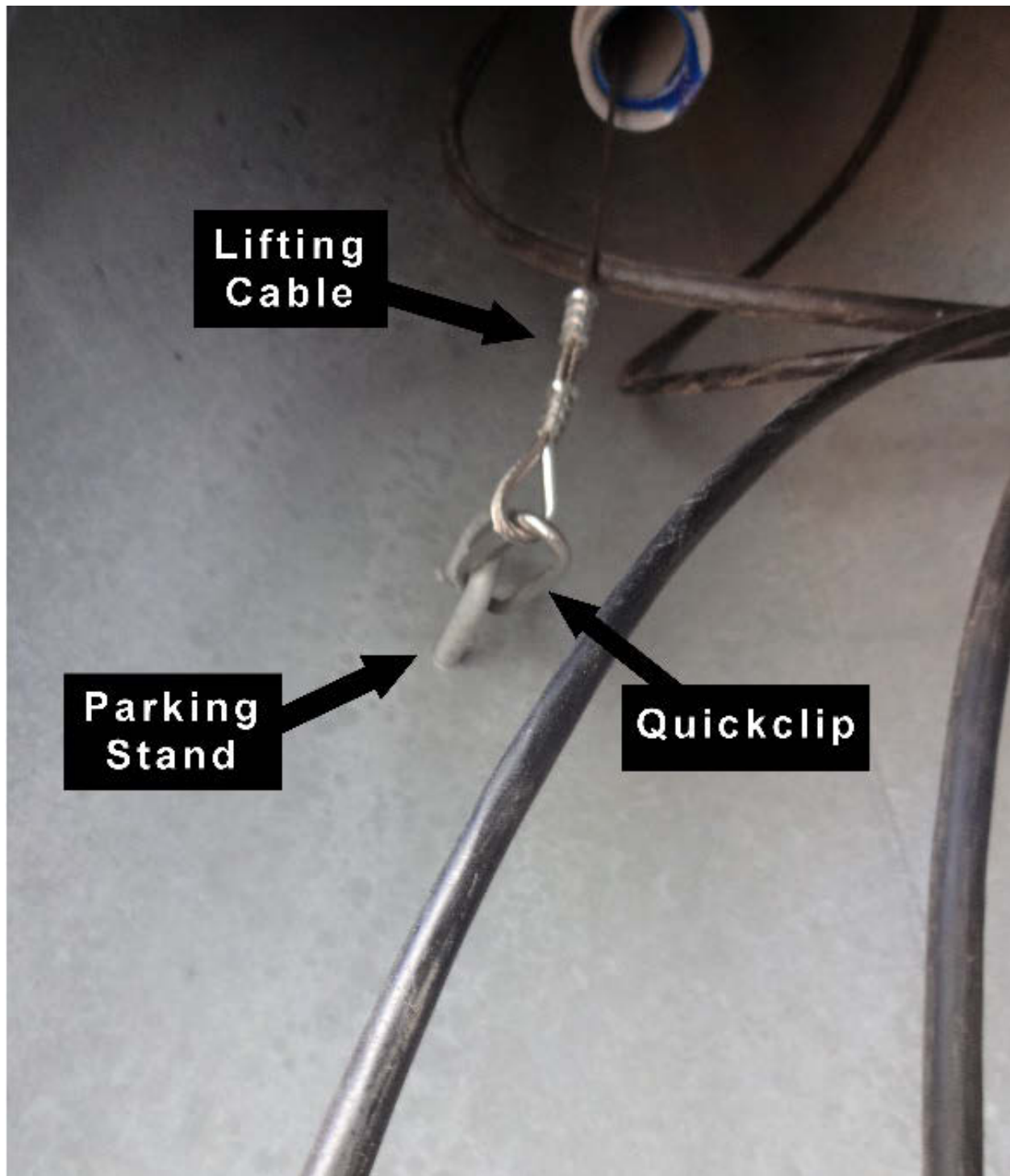

Figure 32. Inside Pole Base

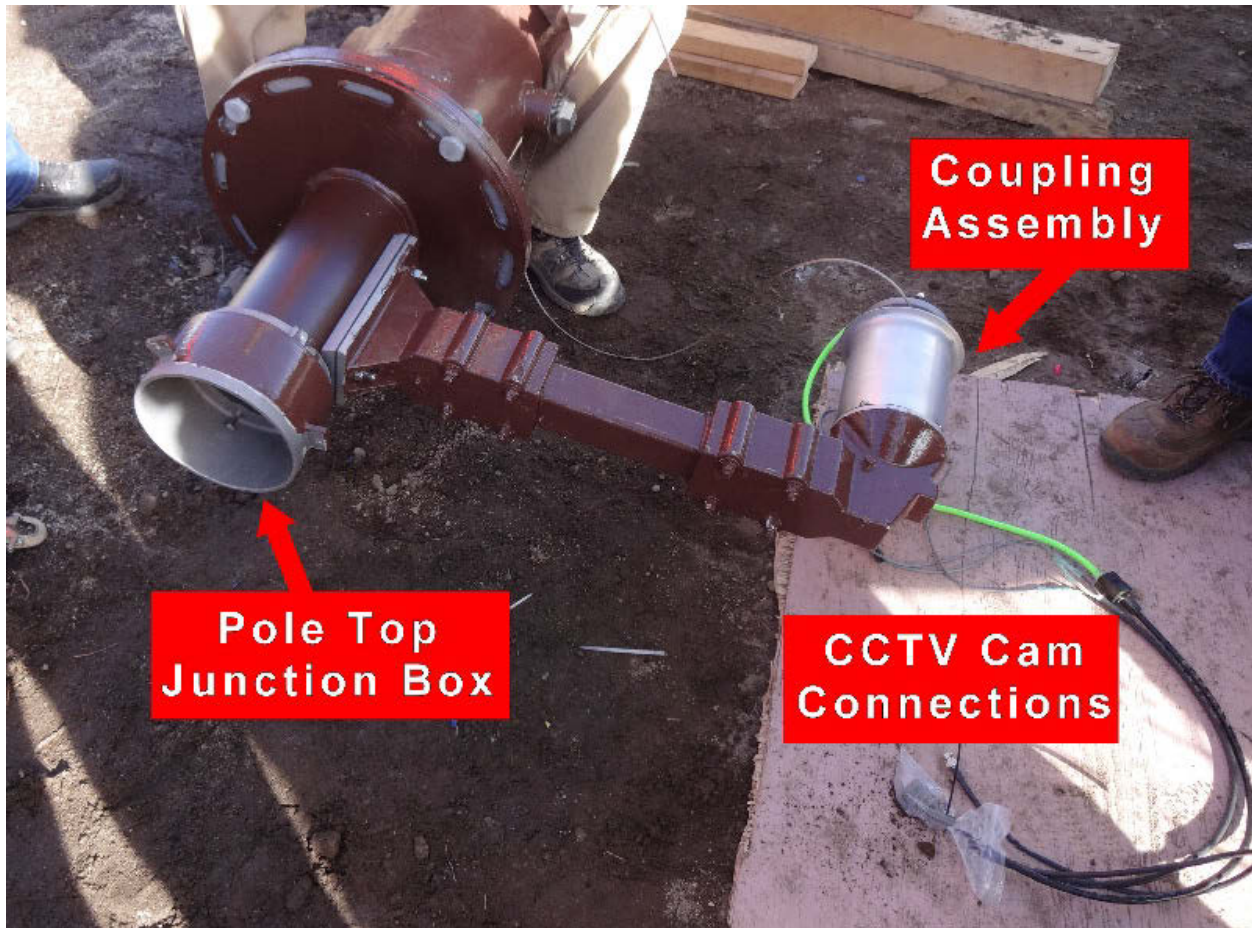

Figure 33. Pole Top Assembly



Figure 34. MG² CLD Winch Tool Attached

With the pole standing, the lowering winch tool is attached to the pole and the lowering cable is connected (Figure 35). The MG² installation representative suggested that hand cranking the lowering winch for poles 50 feet or less is efficient. A power drill attachment has also been included with the winch kit; this is valuable for use with high-mast poles. The lower half of the Coupling is lowered to the ground to complete the assembly of the camera pendant. The Cable Clamp is removed from the lower half of the Coupling and the extra lifting cable slack is pulled through coupling until taut. The Cable Clamp is removed and reinstalled as close as possible to the lower half of the Coupling. The excess lifting cable length is trimmed off. The Cable Clamp is then pressed back into the lower half of the Coupling (Figure 36). Meanwhile the CCTV camera and PTZ unit can be attached to the bottom half of the Coupling Junction Box, and those electrical cables feed through an access hole in the center of the cover. The upper half of the Coupling Junction Box is attached to the lower half of the Coupling (Figure 37). The Coupling Junction Box is designed with a detachable hinge which enables the fully assembled lower half of the Coupling Junction Box to hang from the upper half, supporting the camera so the electrical connections can

Advanced Camera Lowering Device for ITS Maintenance

be more easily joined together (Figure 38). The weight plates are then mounted on the lowered camera pendant. It is critical that the weight plates be attached before the camera pendant is raised, because the additional weight is needed to separate the electrical contacts at the top of the pole during the Coupling unlatching process.

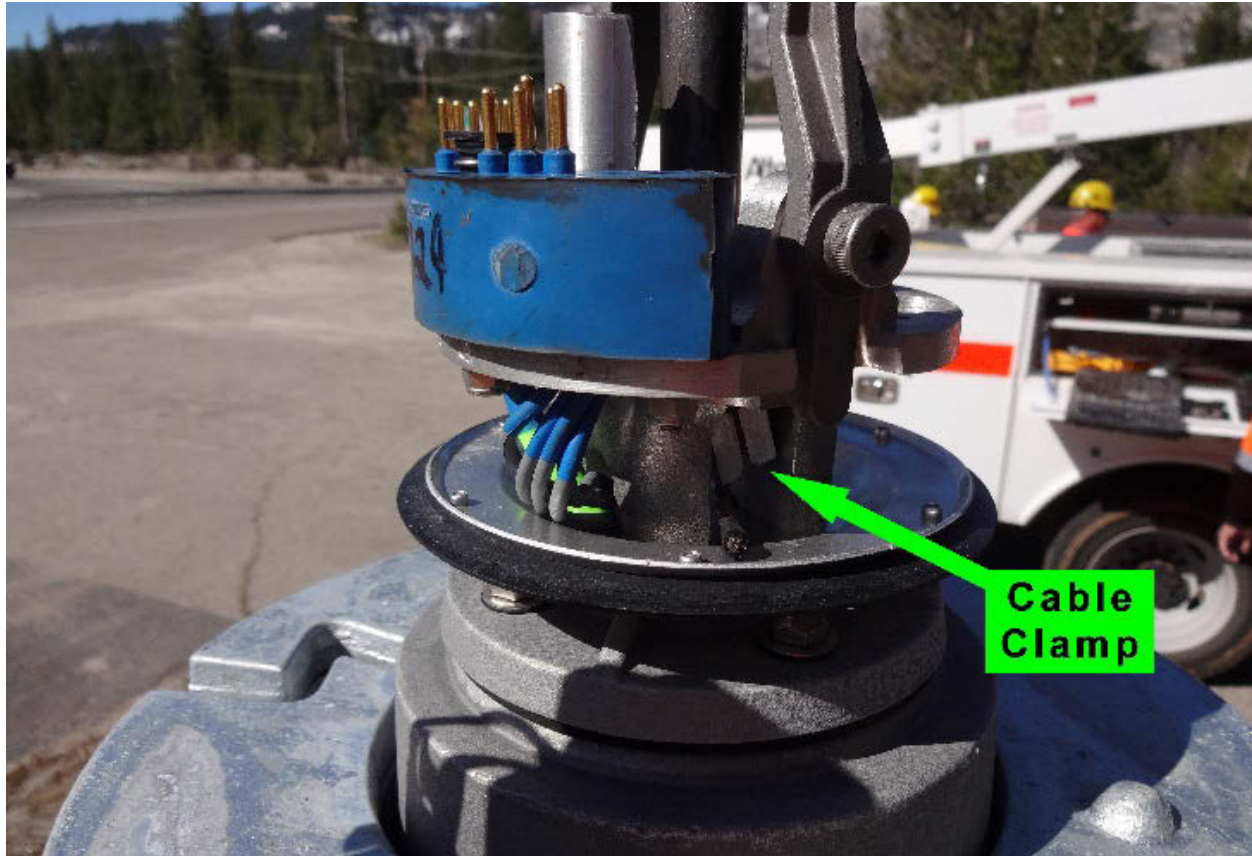

Figure 35. Cable Clamp



Figure 36. Attaching Coupling Junction Box

The fully-assembled camera pendant (Figure 39) is raised and latched at the top of the pole to verify that the length of the lifting cable is correct. If the cable is too long, then the hardware on the portable winch can get caught in the pulley on the winch frame, possibly not allowing the CLD to latch or unlatch. If the cable is too short, then it will be difficult to attach the Lowering cable to the Parking Stand. Adjustments are made by lowering the camera pendant and adjusting the position of the cable clamp on the lifting cable.

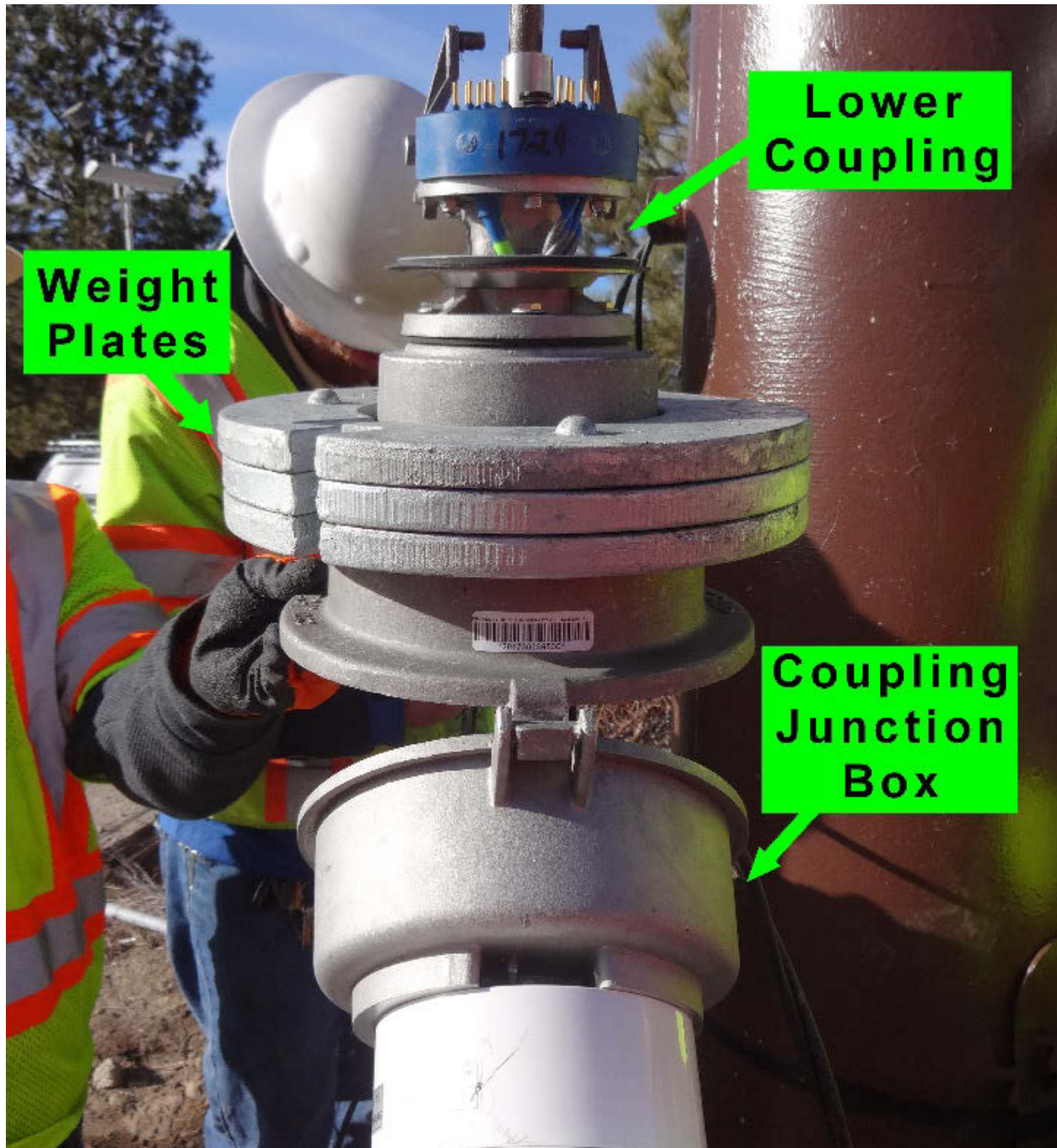

Figure 37. MG² Internal-Type Coupling Junction Box



Figure 38. Fully-Assembled Camera, Pendant Lowered

MG² External-Type System Procurement

Since AHMCT did not have the sufficient research budget remaining to purchase the External-type CLD system, MG² provided a slightly used External-type camera lowering system for Caltrans installation and use. The MG² External-type CLD system hardware was delivered to the installation site by Caltrans TMC personnel. The MG² External-type CLD system was to be retrofitted to an existing Caltrans highway CCTV traffic camera pole site already in operation.

MG² External-Type System Installation

The Caltrans-selected site for the installation of the MG²-supplied External-type CLD system is on the north right of way of US 50 adjacent to the El Dorado Hills Boulevard overcrossing (Figure 40). This site already contained an active pole-mounted traffic camera system operated by the Caltrans District TMC. This integrated CCTV camera and PTZ unit is attached to the top of an ordinary Caltrans steel pole with a standard fixed placement mounting requiring a common 30-foot lift truck to directly access the camera. As is often the case with these types of Caltrans pole-mounted traffic camera systems, Caltrans mounted all the necessary camera support electronic components in a steel National Electrical Manufacturers Association (NEMA) enclosure near the top of the pole. Therefore, Caltrans' plan was to remove the existing camera system, retrofit the existing pole with the MG² External-type CLD system, and reattach the same camera system to the MG² camera-mounting pendant. The only modification to the existing hardware of any significance was related to establishing a new electrical conduit connection between the existing electrical component enclosure mounted near the top of the pole and the MG² upper mount box. It should be noted that this particular installation was chosen out of convenience as a demonstration site. The value and benefits of CLD systems could perhaps have been better showcased at either a high-mast pole site or a challenging site which is difficult to access with a standard lift truck. The camera support electronics enclosure would also logically be mounted near the base of the pole, not at the top as is the case of this demonstration site. There are many Caltrans traffic camera sites with standard 30-foot poles where access by Caltrans Maintenance crews is difficult due to traffic hazards. These sites would be an ideal application for the deployment of the MG² External-type retrofit product; however, these sites are also very difficult to access to install the CLD system and require a long lead-time to schedule.

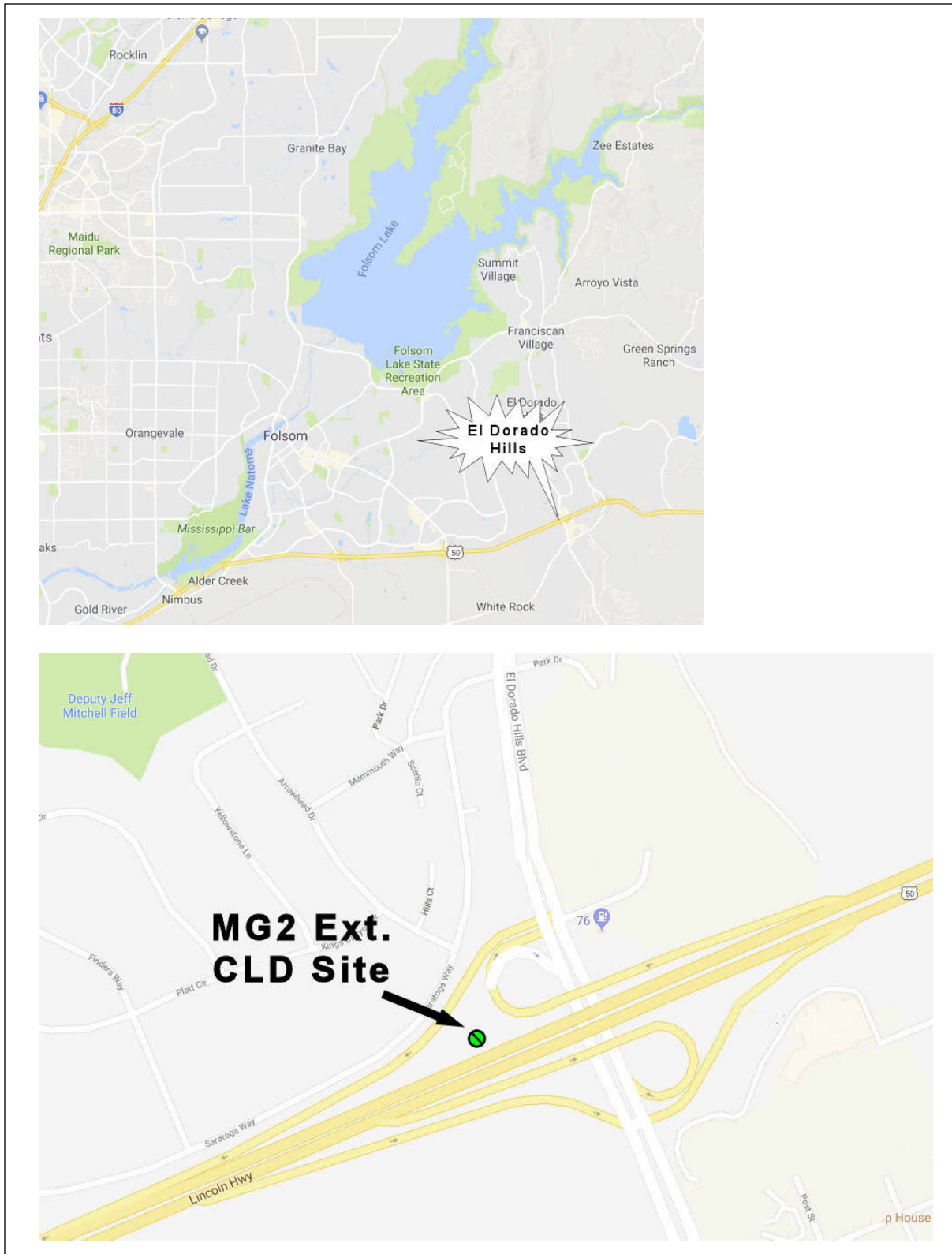

Figure 39. El Dorado Hills MG² External-Type CLD Site Location

Caltrans performed the MG² External-type CLD retrofit on December 20, 2017 at the El Dorado Hills legacy site. An MG² installation representative was on-hand to guide the installation procedure and assist Caltrans with the assembly and testing of the lowering system on the pole. The installation team consisted of a combination of Caltrans personal and contractors who concentrated on completing different tasks, but often collaborated together. The Caltrans Maintenance electrical personnel generally focused on the installation of CLD hardware, while the Caltrans TMC electrical personnel and video network contractor focused on establishing the camera electrical and network connections. The Caltrans Maintenance electrical crews were using two lift trucks during this installation: a standard 30-foot man-lift truck and a less ordinary 45-foot man-lift truck. The 30-foot lift truck needed to be parked up close to the pole on the soft shoulder to be capable of reaching almost to the top of the pole. The 45-foot lift truck could easily reach the very top of the pole while being parked a greater distance away from the pole. In this case, the 45-foot lift truck was able to reach the top of the pole while being parked on paved shoulder of the roadway (Figure 41). Both lift trucks were utilized in unison throughout the installation process. Other than the man-lift trucks, only basic hand tools were required to complete the MG² External-type CLD installation.

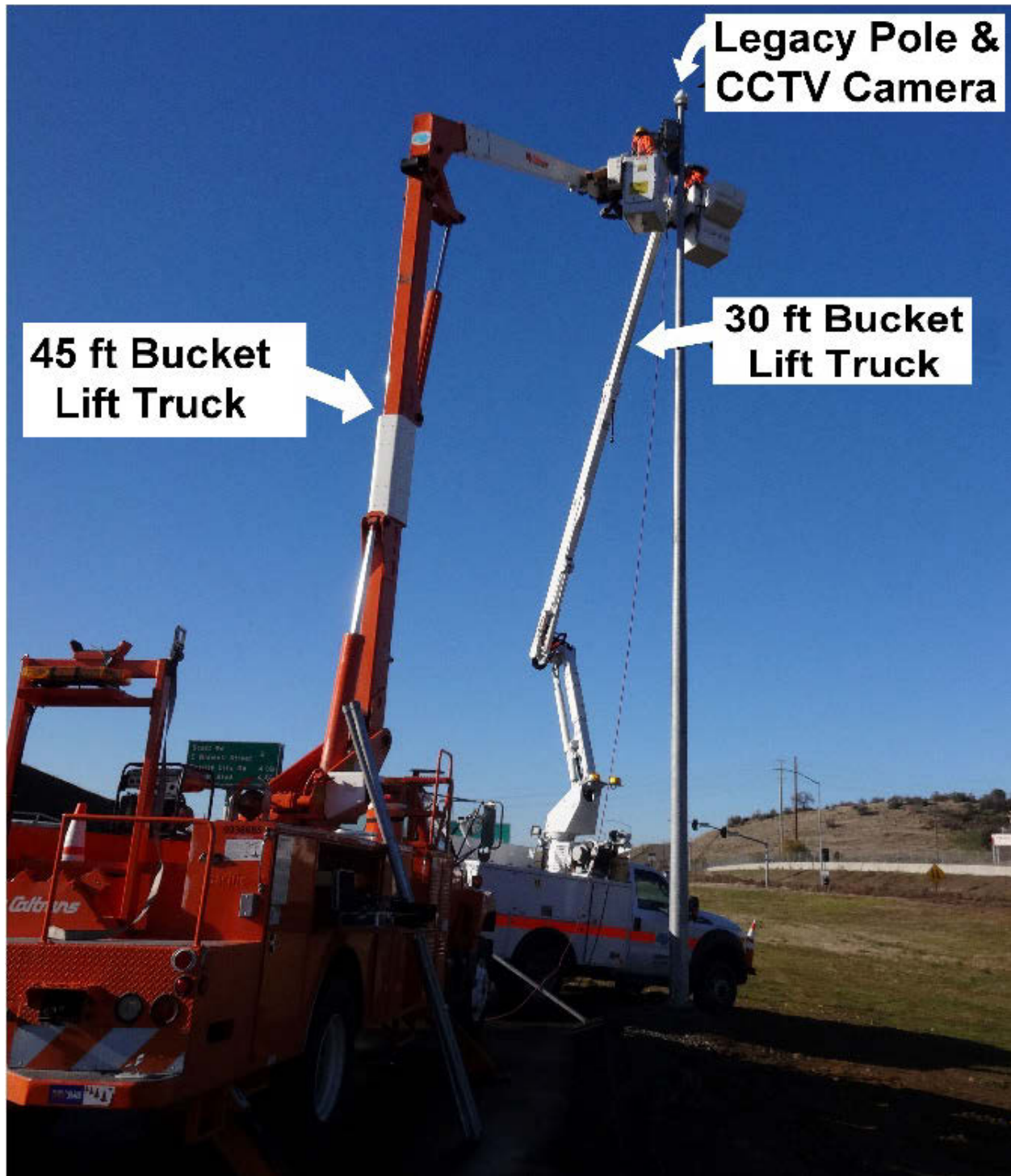

Figure 40. Caltrans External-Type CLD Legacy Retrofit

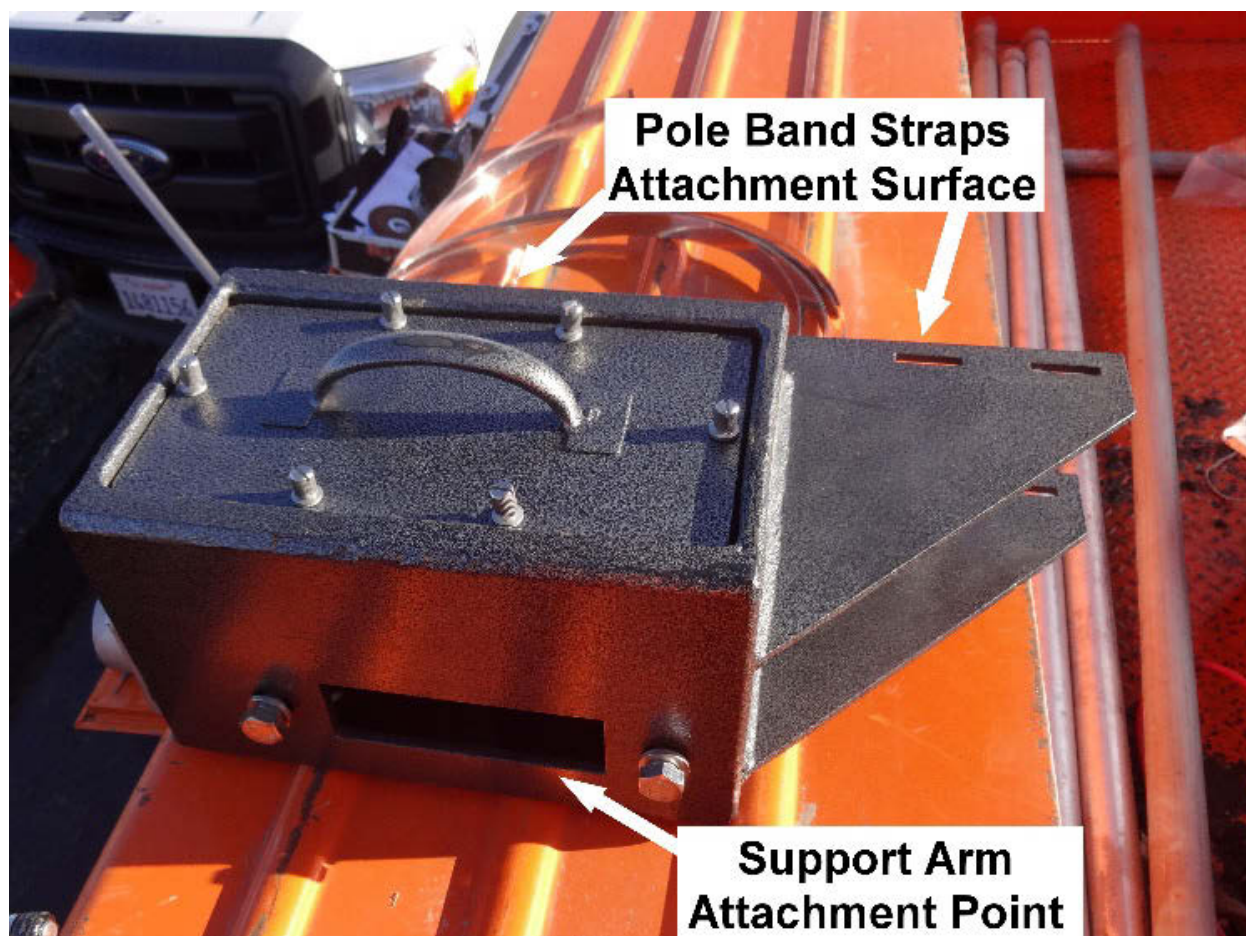

Figure 41. MG² CLD Upper Box

In addition to the MG² on-site installation representative, a written set of installation instructions was also provided which provides a step-by-step set of instructions for the recommended installation procedure (Appendix D). Although, the operations of the MG² Internal- and External-type CLD systems are almost identical, the installation procedures are remarkably different. The key difference is that the External-type system is assembled on a standing pole/structure, requiring workers to conduct the majority of their installation tasks in a lift high off the ground. First, the existing legacy camera package is removed from the top of the pole and remounted onto the MG² Camera Mounting component. The Upper Box (Figure 42) is then banded to the top of the pole and the Lower Box (Figure 43) is banded to the bottom. The steel conduit is run between the two boxes and securely banded to the pole. In this case, only a single conduit was necessary to house the lifting cable. All the existing electrical cables necessary to operate the camera system were already run up the inside of the pole. The Support Arm is brought up to the top of the pole and attached to the Upper Box with the Coupling only partially connected. The lifting cable is fed through the Upper Box and run down the conduit to the Lower Box. The eyelet of the Lifting Cable is then connected to the Parking Stand with an extra Quicklink added to assist with establishing the correct length of the cable. The Coupling is then separated, and the Cable Clamp pulled out of the Lower Junction Box. The Cable Clamp is removed, and the additional Lifting Cable slack taken out. The Cable Clamp is then attached to the Lifting Cable, paying

attention to clamp it as close to the Lower Half Coupling as possible (Figure 44). The excess Lifting Cable is trimmed, and the Cable Clamp is reinserted into the Lower Coupling. From the bottom of the pole, the Winch Tool is then used to lower the Camera Pendant to the ground. The Upper Half of the Junction Box is attached to the bottom of the Coupling, and then the Lower Half of the Junction Box, with the legacy camera already attached, is hung on the Junction Box detachable hinge (Figure 45). The Weight Plates are then placed on the Camera Pendant, and the Junction Box is closed. The fully assembled Camera Pendant can then be lifted to the top of the pole using the Winch Tool and latched in place. The Lifting Cable Eyelet is attached to the Parking Stand and the extra Quicklink removed. The Lifting Cable Eyelet should be positioned in the middle of the Lower Box as illustrated in Figure 43. In the unlikely event that further adjustment in the length of the Lifting Cable is necessary, the camera pendant is lowered and the adjustment is made on the ground. The Cable Clamp is simply removed from the Lower Coupling, adjusted, and then reinserted. Typically, the Weight Plates and the Lower Junction Box assembly are removed to reduce the hanging weight on the Upper Coupling to simplify the procedure.

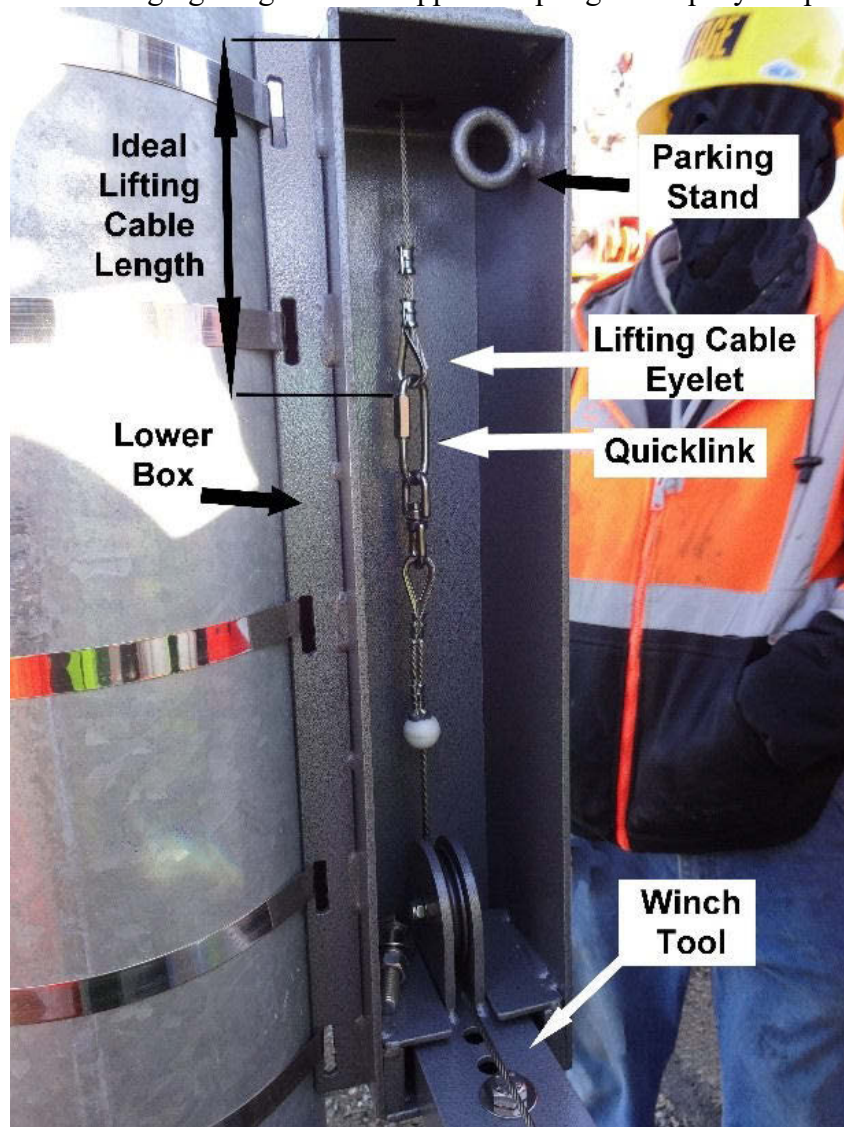

Figure 42. MG² External-Type Lower Box



Figure 43. MG² External-Type CLD Cable Clamp

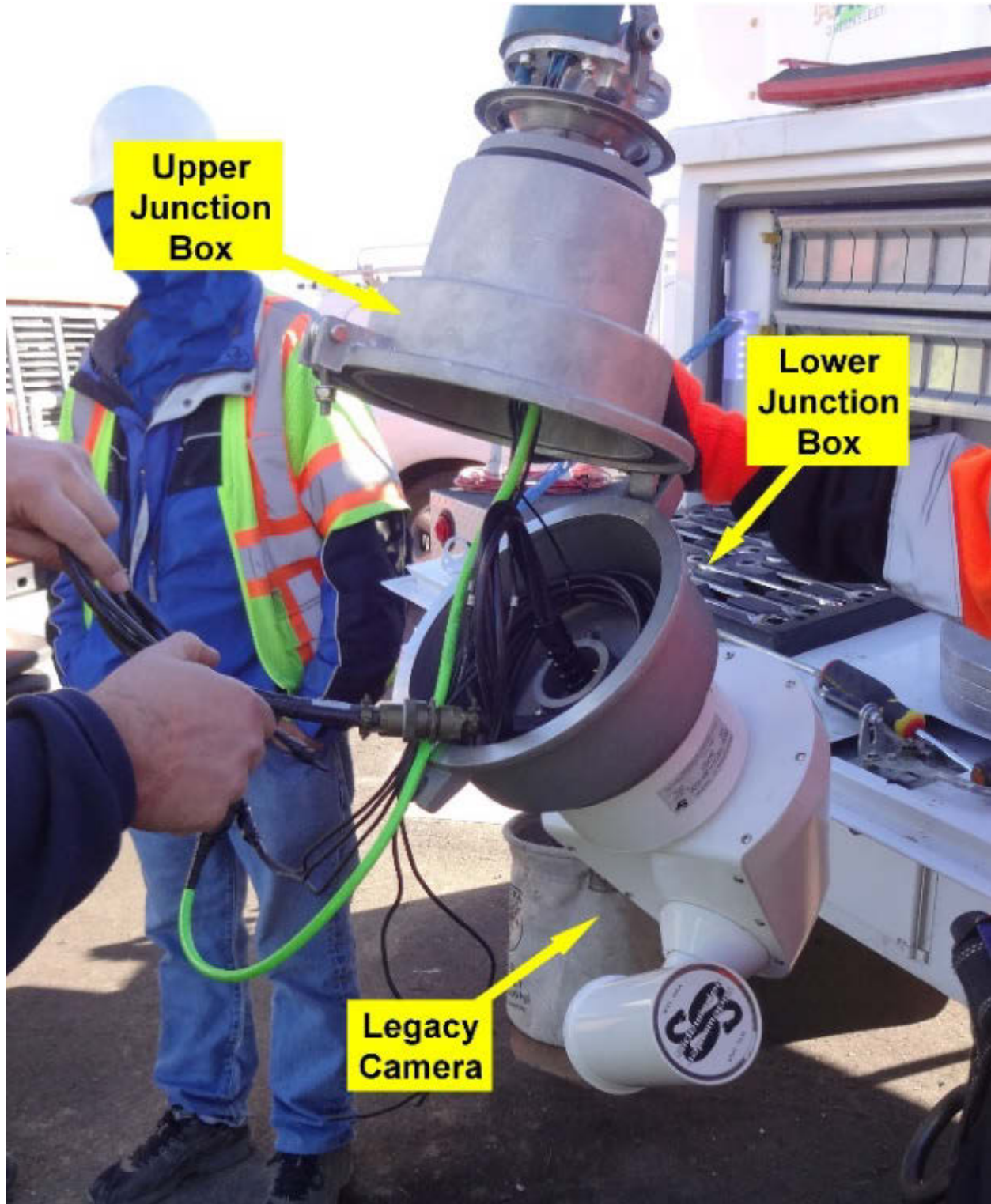

Figure 44. Coupling Junction Box Assembly



Figure 45. MG² External-Type CLD Top of Pole , Fully Assembled



Figure 46. Lowering CCTV Camera MG2 External-Type CLD

CHAPTER 5: MG² CLD SYSTEM PERFORMANCE EVALUATION

The major lowering device manufacturers provide a factory-trained representative to assist the customer with the assembly and testing of the first lowering system onto every pole assembly. Even if a customer's assembly crew has been trained, the manufacturers require a factory representative to be on-hand to ensure their product is properly installed and operated. The manufacturers also typically provide written documentation certifying that the customer's technicians have been instructed on the installation, operation, and safety features of the lowering device. Since the CLD installation procedure involves CLD operation, the manufacturer's product operational instruction is conducted on-site intermingled with the installation instruction. For both of the MG² CLD installations related to this research, operator training was conducted on-site, and several Caltrans Maintenance electrical workers were on-hand to participate in the training at one or both sites. For the Caltrans Stratus CLD installation at Richards Blvd, Caltrans sub-contracted out the installation, and Caltrans Maintenance personnel were not on-site for training. Therefore, the factory representative scheduled a classroom operational training session the following day. The Stratus factory representative noted that on-site training was the preferred approach when possible. The SF-Oakland Bay Bridge MG² system maintenance is sub-contracted, and those technicians were also trained on-site during installation.

MG² Internal-Type System Performance

AHMCT visited the MG² Internal-type system in Meyers on May 8, 2018 to observe the exercising of the CLD system. Caltrans District 3 maintenance electricians were at the Meyers site to replace the CCTV camera. This was Caltrans Maintenance's first visit to the site since the pole and CLD system were installed in December 2017.



Figure 47. Caltrans Meyers Traffic Camera Image



Figure 48. As-Built Meyers MG² Internal-type CLD Site

Advanced Camera Lowering Device for ITS Maintenance

The Caltrans Maintenance electricians arrived at the Meyers site in a Caltrans standard bucket lift truck, but did not need to use the lift to access the camera and conduct the camera switch-out. To access the CCTV camera at the top of the pole, only a few basic hand tools and the MG² hand Winch Tool are necessary. Similarly, as few as one worker would be necessary to lower the CLD pendant, conduct any repairs and maintenance, return the camera pendant to the top of the pole, and latch it in place. The Meyers pole is set back some twenty feet from the roadway, so traffic control was not required to create a safe workspace at the pole base.



Figure 49. Meyers MG² Lowering Winch Tool



Figure 50. Meyers MG² Lowering Camera Pendant

Advanced Camera Lowering Device for ITS Maintenance

The CLD lowering procedure for this MG² CLD system is a basic four-step process. The Winch Tool is attached to the hand-hole (Figure 50). The winch cable is clipped to the lifting cable ring, and then the lifting cable is detached from the Parking Stand inside the pole. The winch is cranked to lift and release the latch at the top of the pole. When the operator feels the weight of the camera pendant on the winch handle, this indicates that the camera pendant is unlatched and can be lowered toward the ground. It takes approximately a minute to hand-crank the camera pendant from the top down to where it is readily accessible by workers on the ground to conduct camera maintenance. In this visit, a temporary camera was removed and replaced with a repaired camera originally intended for this location (Figure 53).

The process is reversed to return the camera to the top of the pole. The winch is cranked until tension increases as the camera pendant reaches the top of the pole. Then the crank direction is reversed to complete the latch lock. When all tension is released from the cable, the cable tends to spin which provides a positive indication the coupling is fully latched. The lifting cable is first attached to the Parking Stand in the pole, and then the winch cable is detached. The Winch Tool is unbolted from the pole and removed. The hand-hole cover is then reattached, which completes the lowering process.



Figure 51. Hand Cranking Winch



Figure 52. CCTV Camera Replacement

Performance Evaluation

The MG² Internal-type CLD system seems easy to operate, requires minimal setup, and appears very robust. A single worker can operate the system after minimal training, and the MG² CLD does not require the worker to have to look up at the pole top to determine when the camera latches as is required for Halo-style systems. The only potential maintenance issue indicated by MG² may be a need to shorten the lifting cable periodically due to cable stretch. This seems unlikely, though, since all tension is taken off the lifting cable while the camera is latched.

One small issue did arise with the MG² Winch Tool. The plastic indicator ball became unglued from the winch tool cable and was sliding down the cable as the winch was unspooled. It is unclear if this would cause any problems, but just in case, the Caltrans Maintenance electricians temporarily taped the plastic ball in place for this visit. A more permanent fix may be desired before the Winch Tool is used in the future.

This MG² CLD system was exposed to the winter snow/ice/salt environment for a full winter in the Lake Tahoe area and no noticeable corrosion or oxidation was observed on the lowering mechanism or the camera pendant assembly. The camera Junction Box on the camera pendant appeared to be weather-tight, and no evidence of moisture was observed. The Electrical Connector contact pins were clean, and no additional preparation was required before reconnection.

MG² External-Type System Performance

AHMCT visited the MG² External-type system in El Dorado Hills on May 8, 2018 to observe the exercising of the CLD system. Caltrans District 3 Maintenance electricians were at this site to clean the CCTV camera. This was the first visit to the site by Caltrans maintenance crews since the MG² External-type CLD system was attached to a legacy pole in December 2017.



Figure 53. Caltrans El Dorado Hills Traffic Camera Image



Figure 54. As-built MG2 External-Type CLD, El Dorado Hills

The El Dorado Hills site has a wide paved pull-out such that service vehicles can be safely parked near the pole without the need for traffic control measures. Caltrans Maintenance electricians parked their service trucks in the pull-out, shielding their access to the pole. The procedure to lower the External-type MG² CLD is identical to the procedure for the MG² Internal-type CLD described previously. The only difference is in the mounting of the hand winch. The Lower Box of the MG² External-type system contains a receiver that enables the Winch Tool to be attached without depending on a bolt to secure it for operation (Figure 56).



Figure 55. Winch Tool Receiver

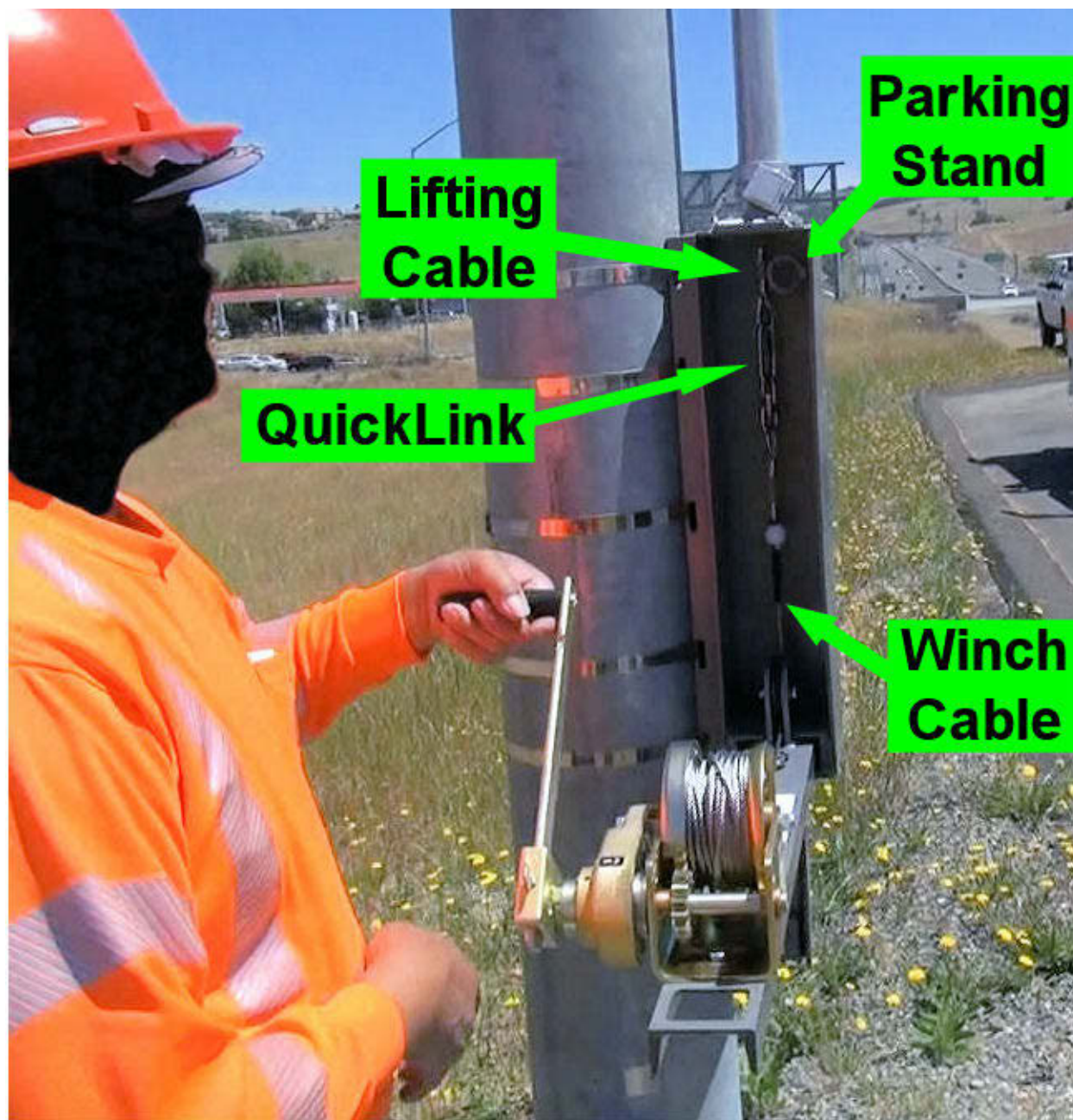

Figure 56. MG² External-Type Lower Box

Performance Evaluation

Fewer weight plates were installed on this camera pendant to keep the weight on the legacy pole to a minimum. The camera pendant seemed to unlatch and lower effectively without the extra two weight plates recommended by the manufacturer. The camera lowered near to the ground in about a minute with the operator using only the winch hand crank (Figure 58). The camera was then cleaned (Figure 59), returned to top of the pole, and latched in place. The critical banding, which mounts the CLD components to the pole, did not appear to have loosened. The MG² system did not exhibit any signs of corrosion or oxidation, and no sign of wear was observed. Overall the

Advanced Camera Lowering Device for ITS Maintenance

MG² External-type CLD system seems easy to operate, requires minimal setup, and seems to be very robust.



Figure 57. MG² External-Type Camera Lowering



Figure 58. CCTV Lens Cleaning

SF-Oakland Bay Bridge MG² Internal-Type System Performance

On June 15, 2017, AHMCT visited a Caltrans security/traffic camera site on the approach to the eastern span of the SF-Oakland Bay Bridge which is fitted with an MG² Internal-type CLD system (Figure 60). Caltrans subcontracted the installation and maintenance of this PTZ camera system to IndustrialENET Company. The camera system was not fully commissioned at the time of the visit, but the on-site IndustrialENET technicians were able to provide a demonstration of the CLD portion of the system. Since this system is attached to the top of a 90-foot high pole, it is characterized as a high-mast structure requiring specialized ultra-high-reach lift equipment to install and access the top of the pole if a conventional mounting was used. Since the MG² Internal-type CLD mounting was used, the camera and cabling were installed with the pole lying on the ground. Following installation, the pole was then tilted up and attached to the footing. High-lift bucket equipment was not needed for this installation or subsequent commissioning—only a crane was necessary to lift and place the pole. All the necessary camera system electronics and support components were contained in a ground-mounted enclosure adjacent to the pole (Figure 61). Only the cables that connect the camera to the support electronics are run up the inside of the pole to the top and connected to the CLD upper coupling.



Figure 59. Bay Bridge MG² Internal-Type CLD Site

Advanced Camera Lowering Device for ITS Maintenance

The SF-Oakland Bay Bridge high-mast camera system is mounted off the right of way adjacent to, but separated from, traffic by a concrete barrier wall from the highway. Access to the pole site was from a service road that parallels the highway. The camera pendant was locked at the top of the pole when we arrived at the site. The IndustrialENET technician operating the MG² CLD lowered and raised the camera pendant by himself using the portable winch tool and a portable battery-powered driver fitted with the standard equipment socket adapter (Figure 62).



Figure 60. Bay Bridge MG2 CLD Remote Eletronics Cabinet



Figure 61. Power Driving Winch Tool

Advanced Camera Lowering Device for ITS Maintenance

The first step is to remove the hand-hole cover and attach the winch tool to its mounting guide in the pole using only an adjustable wrench (Figure 63). Then the winch cable Quicklink is attached to the lifting cable eyelet before then disconnecting the lifting cable from the Parking stand. Then the hand crank is attached to the winch and cranked by hand, putting tension on the lifting cable to unlatch the coupling at the top of the pole. Then the crank direction is reversed and lowered by hand a short distance to ensure the camera pendant is unlatched. The hand crank is then replaced with the socket driver which is used to quickly spool out the winch cable lowering the camera pendant. It takes about a minute to lower the pendant to near the ground. AHMCT was then able to inspect the camera package and ensure the mating pins were clean and dry.

The camera pendant is then winched back up close to the top of the coupling in about a minute's time, stopping before reaching the coupling. The hand crank is then reattached. The manufacturer recommends that only the hand crank be used to latch and unlatch the coupling, so that the operator can directly feel the latching phases through the change in the cable tension. The pendant is then raised the remaining distance until the lifting cable tension increases, indicating the coupling has begun to latch. Reversing the winch lowers the coupling into full latching position, indicated by the relaxing of all tension in the lifting cable. The lifting cable is then reattached to the parking stand and the winch cable and removed.

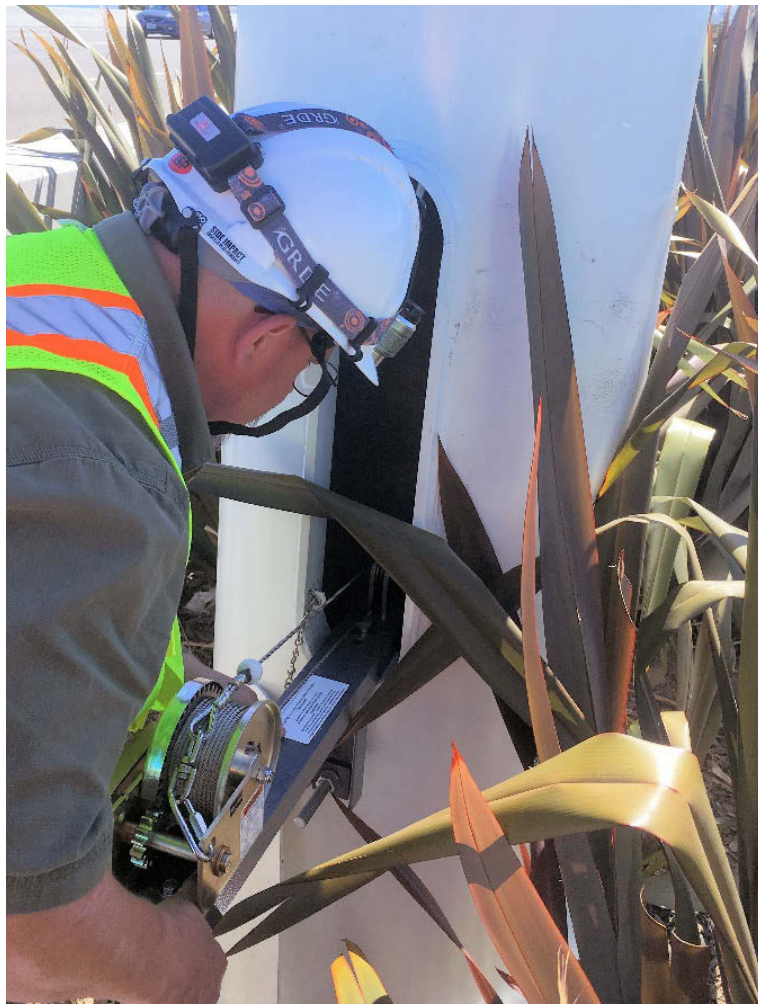

Figure 62. Attach Winch Tool

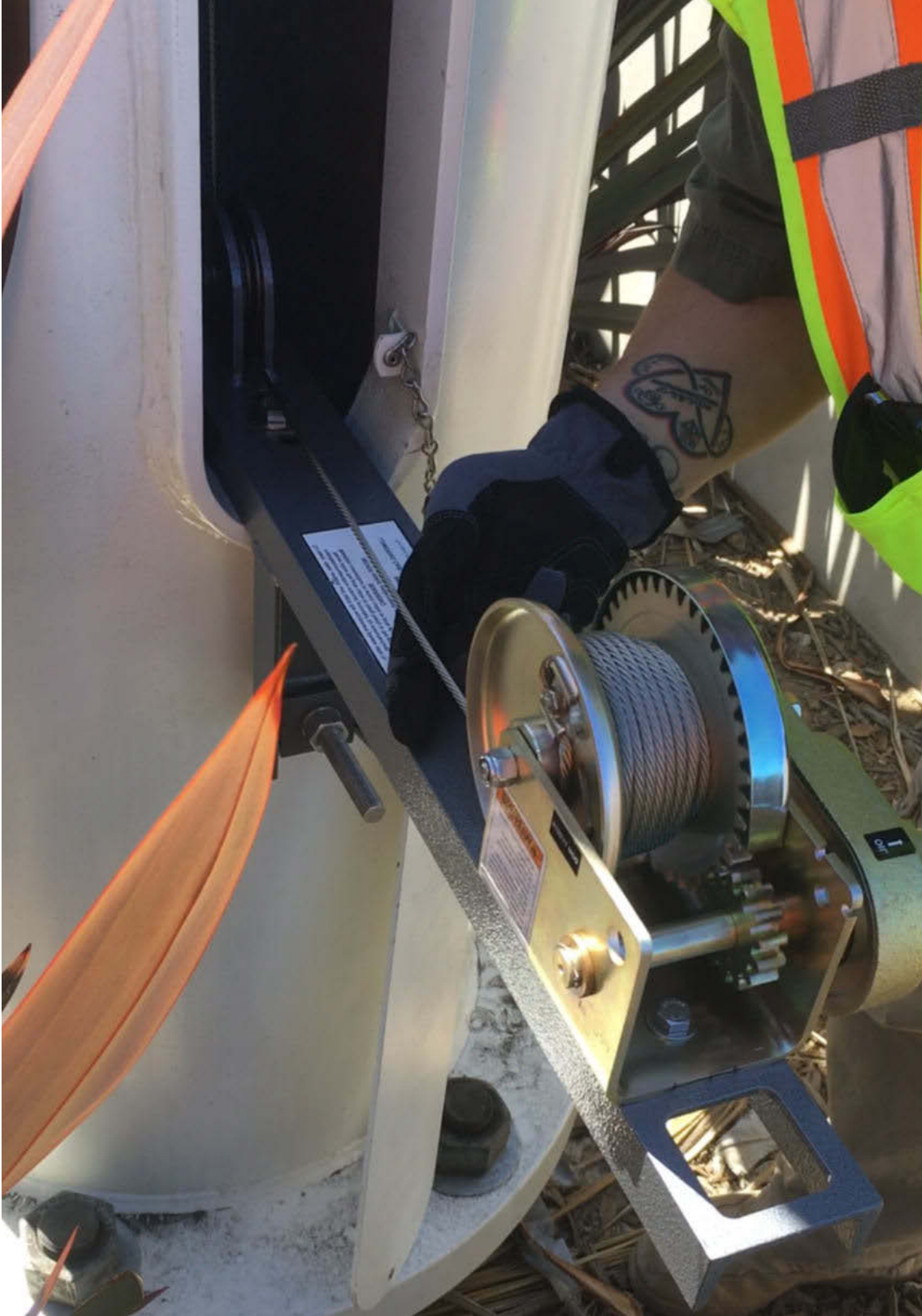

Figure 63. Hand Guiding Winch Cable

The SF-Oakland Bay Bridge MG² CLD exercise demonstration was conducted without any problems or negative issues. The system was quick and easy to operate and appeared to be rugged in construction. The only potential issue that might present some future problems is wind-related, and this site is notoriously windy. As the camera pendant is lowered in high winds, it tends to spin, twisting the lifting cable. Then when the twisted lifting cable is reeled in for pendant lifting, the twisting causes the cable not to wind evenly on the winch spool. The operator is instructed to use a gloved hand to guide the cable winding manually (Figure 64). The winch spool is completely filled with the wrapped lifting cable when spooled in correctly. Should the cable not spool evenly and bunch up, the lifting cable may jam. If this happens, the lifting cable must be spooled out past the bunching and re-spooled. The manufacturer is aware of this issue, which is judged to be a small enough effect that further mitigation is not necessary. It appears that with a little operator vigilance, spooling problems can be avoided.



Figure 64. Bay Bridge MG² Internal-Type CLD

CHAPTER 6: CONCLUSIONS AND FUTURE RESEARCH

Conclusions

CLD systems provide a safe and efficient means for maintenance workers to access pole-mounted traffic camera systems. CLD systems are especially beneficial in challenging site highway locations where maintenance crews have a difficult task of accessing the top of the pole due to height, access too near the base with a bucket lift truck, or both. A CLD system enables a worker standing at the base of the pole to directly access the camera by lowering it to ground level to perform maintenance or make repairs. The deployment of CLD systems eliminates the often difficult task of bringing a bucket lift truck in near the pole base to access the camera due to traffic safety, physical obstructions, or rough terrain issues. This effectively translates to timelier camera maintenance and repairs, resulting in reduced camera downtime and thereby increasing the level of services. Keeping the worker on the ground also improves worker safety and lessens any potential traffic disruptions for sites difficult to access with standard bucket lift trucks.

Caltrans has years of experience utilizing Halo-style CLD systems based on the multitude of these systems Caltrans has deployed on highway ITS camera sites throughout the state. The primary goal of this research was to improve and/or broaden the range of CLD products available to Caltrans ITS in their effort to meet MAP-21 management targets. This project specifically sought to introduce an alternative CLD product that is new to Caltrans but has been successfully utilized by other agencies for some time.

The MG² CLD system was specifically designed to support traffic camera applications, unlike the aforementioned Halo-style CLD systems, which were primarily developed to support high-mast lighting applications. This research procured and deployed the two versions of the MG² CLD system. The Internal-type of the MG² CLD is intended for Caltrans applications involving a new pole installation such that the pole can be customized by the manufacturer to support the integration of the CLD device. The External-type of the MG² CLD is intended for Caltrans applications involving retrofitting of an existing camera system or standing pole. This project provided the installation and evaluation of both the Internal and External types of Detachable-style CLD systems.

Both the Internal and External types of MG² CLD systems perform the same basic function of lowering a CCTV camera to the ground for maintenance, providing obvious worker safety and time saving benefits especially when applied to difficult to access and hazardous CCTV pole sites. In addition, the Internal-type CLD systems offer the prospect of reducing installation costs by enabling the entire CCTV system to be assembled on/from the ground. This eliminates the cost and hazard of relying on high lift equipment to conduct the installation, which is especially valuable for high mast applications.

The installation of the MG² External-type CLD is ideally suited for applications where a legacy pole is involved, which is not possible with Halo-style CLD systems. Since the External-type system is to be attached to an already-erected pole, workers conduct much of their installation tasks high in the air in man-lift buckets. Therefore, any potential installation benefits are negligible, but once installed the External-type CLD provides the ongoing benefit of enabling any further CCTV system maintenance to be conducted from the ground.

The field trials of the both types of MG² CLD systems were successful, and no negative issues were observed or experienced. The systems were simple to operate and trouble-free over the duration of this research study. The systems operated as required. The camera pendant can be

lowered to the ground or raised up to latch in less than two minutes time by hand with minimal effort. An internal electric winch or the drive socket attachment included with the detachable winch may be necessary for high-mast applications, but the poles in this study were 50 feet or less, which made winching by hand very appropriate.

Future Work

It may be useful to investigate CLD devices in the field over a longer period of time and potentially determine a value for an average service life. It would also be beneficial to examine CLD systems that have seen many years of service and/or are in service in harsh climates, such as saltwater environments, to better understand how these CLD systems perform as the mechanisms degrade and which parts are most prone to failure. In addition, a study could be conducted to determine the ideal application of CLD systems for Caltrans. A detailed cost-benefit study could be developed which examines the characteristics of CCTV site locations and determines the type of sites which justify the additional expense of CLD systems. Some expected factors would include access, traffic, pole height, space, infrastructure, and legacy equipment. This study could ultimately serve as a guide for Caltrans to refer to when determining and justifying which site locations would benefit from CLD system deployment.

APPENDIX A:
POLE DESIGN APPROVAL LETTER



August 23, 2017

MG 2 Inc.

Valmont Order: 370901-P1
Customer Order: B1705023

Enclosed is the revised drawing package for your approval. This drawing represents the ITS Products to be furnished by Valmont Industries, Inc.

Please return one (1) complete set of drawings marked **Approved** to Mandy Robinson, or provide other written authorization at the time of order release.

Send to:

VALMONT INDUSTRIES, INC.
Lighting, Traffic and Communication Structures
28800 Ida St.
P.O. Box 358
Valley, Nebraska 68064-8016

Valmont approval policy: *It is important that all verification information must accompany the order release. Omission of the information may cause a delay in the shipping schedule. Also note: should we require additional information, clarification, or if there is a customer initiated change, the quoted lead-time is subject to when we receive this information. Our quoted lead-time begins once we receive the completed information or the final customer change. Damages resulting from delays in receiving complete information or customer changes will not be the responsibility of Valmont Industries, Inc.*

Sincerely,
Chad A. Naeve
chad.naeve@valmont.com

cc: file

Structures-North America
Valmont Industries, Inc. 28800 Ida Street P.O. Box 358 Valley, Nebraska 68064-0358 USA
402-359-2201 800-825-6668 Fax 402-359-4025 valmont.com valmontstructures.com

Advanced Camera Lowering Device for ITS Maintenance

LOADING INFORMATION
 CAMERA EPA: 3.00 SQ. FT.
 CAMERA WEIGHT: 100 LBS.
 CABINET EPA: 5.0 SQ. FT.
 CABINET WEIGHT: 100 LBS.
 VDS WEIGHT LOWER: 200 LBS.
 VDS EPA LOWER: 14 OR 10 SQ. FT.
 VDS WEIGHT UPPER: 50 LBS.
 VDS EPA UPPER: 2.50 SQ. FT.

THE ASSUMED LOADING CONSISTS OF THE CAMERA LOWERING DEVICE, CABINET, AND VDS DEVICE ONLY.

POLE DATA																	
ITEM	QTY.	DESIGNATION	POLE HEIGHT (FT)	NO. L. D. ARMS REQ'D	POLE TUBE			POLE BASE			ANCHOR BOLT						
					BASE DIAMETER (IN)	TOP DIAMETER (IN)	LENGTH (FT)	GALVE OR THICK (IN)	ROUND "X" (IN)	BOLT CIRCLE "X" (IN)	BOLT THICK "X" (IN)	POLE DIA. "X" (IN)	DIA. "X" (IN)	LENGTH "L" (IN)	THREAD LENGTH "H" (IN)	NUMBER REQ'D	
1	1	50' CAMERA POLE-VDS-6V-HH-LAB	50.00	1	18.00	11.00	50.00	0.313	28.00	23.00	2.00	2.50	2.25	45.00	12.00	8.00	12

MATERIAL DATA			FINISH DATA		
COMPONENT	ASTM DESIGNATION	MIN YIELD (KSI)	SYSTEM		
TAPERED SHAFTS	A575 GR. A OR A572	55	GALVANIZED (GV)		
BASE PLATE	A572 GR. 50	50	BASE COAT:	HOT-DIP GALVANIZED TO ASTM A123	
POLE TOP PLATE	A36	26	PRIME COAT:	NONE	
TENON - D.O.M. TUBING	A513	50	FINISH COAT:	NONE	
HARDWARE - COATING	HOT DIP ZINC	--	COLOR:	NONE	
ANCHOR BOLT	F1554 GR. 55	55	SPEC:	F-1	

THE CAMERA STRUCTURES SHOWN ON THIS DRAWING HAVE BEEN DESIGNED IN ACCORDANCE WITH THE LOADING AND THE ALLOWABLE STRESS REQUIREMENTS OF THE 2013 AASHTO STANDARD SPECIFICATIONS FOR STRUCTURAL SUPPORTS FOR HIGHWAY SIGNS, LUMINAIRES AND TRAFFIC SIGNALS, SIXTH EDITION, L13-6. THE WIND LOADS WERE CALCULATED FROM A BASIC WIND VELOCITY OF 100 MPH WITH A RECURRENT INTERVAL OF 50 YEARS.

AASHTO 2013 SPECIFICATIONS

DETAIL 1
TENON ASSEMBLY

5.25" X 1.75" SLOT OUT IN POLE WALL FOR CABLE AND PULLEY ACCESS.
 (2) 0.656" DIA. HOLES
 0.25"
 0.38" THICK TENON PLATE WITH 5.56" DIA CENTER HOLE
 (4) 0.75" X 2.75" A320 BOLT W/ HEX NUT (1) WASHER (1) LOCK WASHER

DETAIL 2
POLE TOP PLATE

17.00" DIA
 POLE TOP DIA: +0.00"
 (8) 0.88" DIA BOLT HOLES
 1.00"
 0.25"
 0.25"

DETAIL 4
HANDHOLE

0.250" THICK H.R.M.S. HANDHOLE MOUNTING BAR
 0.51" - 1.618 IN K X 2.00" HEX SOCKET FLAT HEAD SERIES STAINLESS STEEL
 HANDHOLE COVER- 11 GA. H.R.M.S. W/ COUNTERSINK POLE
 5.63"
 2.00"
 7.51"
 0.432"
 POLE WALL WELD THICKNESS SIZE
 E. 315" 0.38"

DETAIL 3
POLE COUPLING

1.69"
 1.00" FULL COUPLING 90° FROM HANDHOLE
 SEE TABLE

1.00" COUPLING LOCATION DATA		
LEVELS	QUANTITY	HEIGHT
1	1	10'-0" FROM BASE OF POLE
2	1	15'-0" FROM BASE OF POLE
3	VERTICES	5' SPACING
4	1	4' FROM HIGHEST LEVEL 3 CPLG
5	1	1' FROM TOP OF THE POLE

VIBRATION DISCLAIMER

ALTHOUGH RARE, VIBRATIONS SEVERE ENOUGH TO CAUSE DAMAGE CAN OCCASIONALLY OCCUR IN STRUCTURES OF ALL TYPES. BECAUSE THEY ARE INFLUENCED BY MANY INTERACTING VARIABLES, VIBRATIONS ARE GENERALLY UNPREDICTABLE. THE USER'S MAINTENANCE PROGRAM SHOULD INCLUDE OBSERVATION FOR EXCESSIVE VIBRATION AND EXAMINATION FOR ANY STRUCTURAL DAMAGE OR BOLT LOOSENING. THE VALMONT WARRANTY SPECIFICALLY EXCLUDES FATIGUE FAILURE OR SIMILAR PHENOMENA RESULTING FROM INDUCED VIBRATION, HARMONIC OSCILLATION OR RESONANCE ASSOCIATED WITH MOVEMENT OF AIR CURRENTS AROUND THE PRODUCT.

REV	DATE	BY	DATE	DESCRIPTION
B	06/23/17	CNS	08/23/17	UPDATED COUPLING LOCATION/ADDED HH @ TOP
A	06/29/17	CNS	06/29/17	POLE SIZE WAS CHANGED PER CUSTOMER REQUEST
CNS	06/09/17	CNS	06/09/17	

SALE TO M&E INC.
 SHIP TO TBD
 P.O. #: 01705623
 AGENT: M&E INC.

JOB: CCTV W/VDS POLES 50'
 CALTRANS 2015 PLANS & SPEC.
 TITLE: CAMERA POLE STRUCTURES

VALMONT INDUSTRIES, INC. RESERVES THE RIGHT TO INSTALL VARIOUS ENGINEER APPROVED, MATERIAL HANGING ACCOMMODATIONS TO FACILITATE THE MANUFACTURING PROCESS.

Valley, NE 68064
 (402) 359-2201

REGISTERED PROFESSIONAL ENGINEER
 STATE OF NEBRASKA
 CIVIL
 DATE OF EXPIRATION: 12/31/17

ORDER NUMBER: 378901-01
 PAGE NUMBER: 1 OF 2
 DRAWING NUMBER: CA37901P1
 REV

Advanced Camera Lowering Device for ITS Maintenance

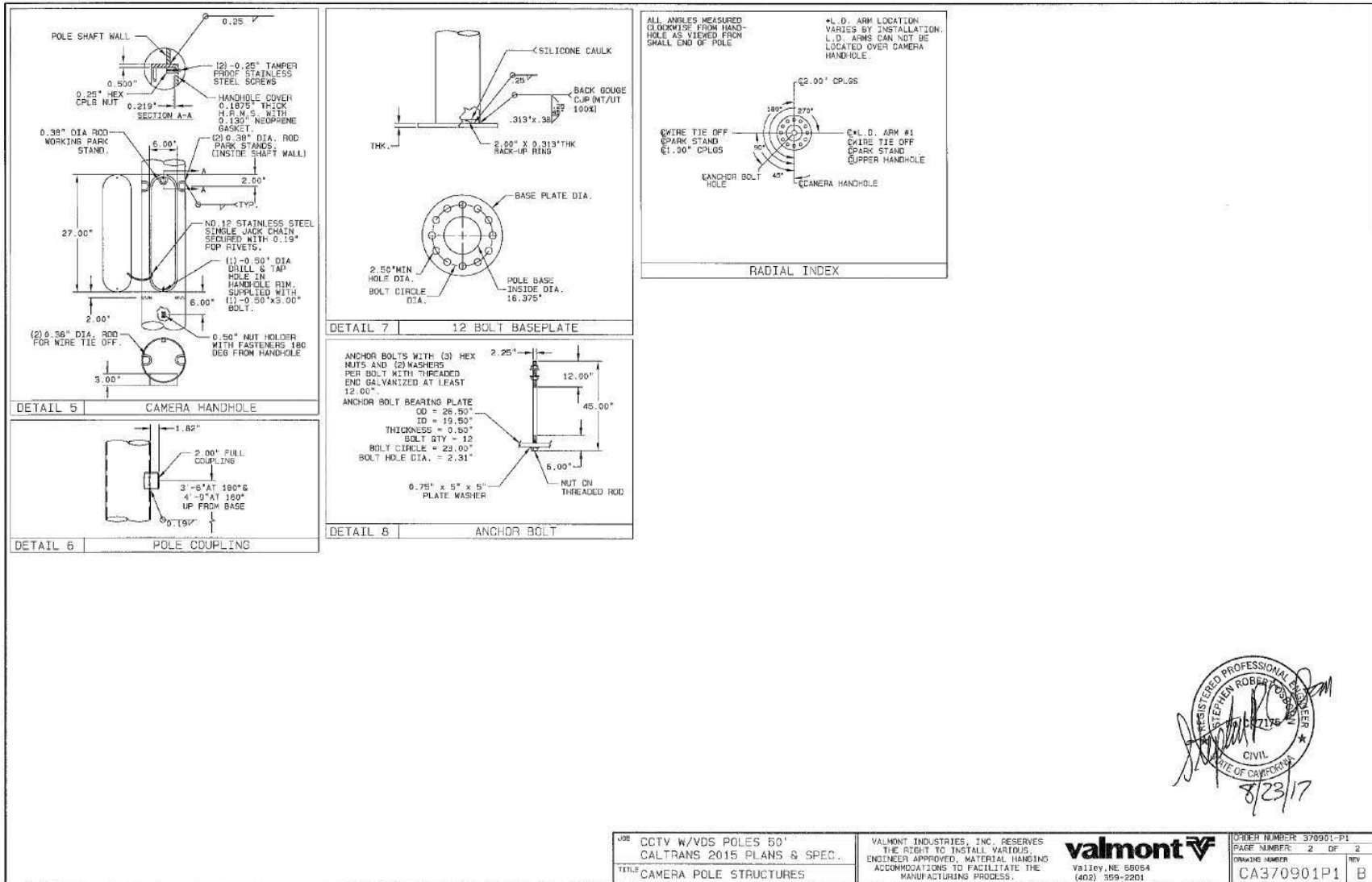

APPENDIX B:
MG² INTERNAL-TYPE CLD AND POLE PACKING LIST

PACKING LIST

SHIP TO:	Dean Campbell, P.E. Chief, Electrical Systems Branch Caltrans - District 3 TMC 3165 Gold Valley Dr Rancho Cordova, Ca. 95742	BILL TO:	ORDER #: B1708028 SHIP DATE: 12/05/17
			[MG] ² , INC. 3301 OAK HILL DRIVE BIRMINGHAM, AL 35216

Caltrans Sample
PO#UCS320096

Skid	Box #	Qty. Shipped	Description
1	1	1	CAMERA LOWERING DEVICES (EMCLD2-80) completely assembled , IP Contacts, and PEF/Support Arm/FEF and all hardware, and lowering cables installed. Portable Winch.
1	1	1	LOWER WINCH CONNECTION BOX, with 1.5" Conduit Hub.
1	1	1	UPPER MOUNTING BOX, with 1.5" Conduit Hub
1	1	1	CAMERA JUNCTION BOX with hardware installed
1	1	3	CAMERA JUNCTION BOX WEIGHTS, 14 LB.
1	1	1	LOWERING TOOL LWR5-85
1	1	1	CLUTCH ASSEMBLY DWAC-200
1	2	1	CAMERA LOWERING DEVICE (PEF-2C-20/FEF-2CP/SS55) completely assembled, IP Contacts, PEF/Support Arm/FEF and all hardware, and lowering cables (with screw link) installed. Conduit Hanger Attached
1	2	1	CAMERA JUNCTION BOXES with hardware installed
1	2	3	CAMERA JUNCTION BOX WEIGHTS, 14 LB.
1	2	1	POLETOP JUNCTION BOX
1	2	1	CUSTOM PELICAN CASE W00805
1	2	1	LOWERING TOOL LWR5-85
1	2	1	CLUTCH ASSEMBLY DWAC-200

Any discrepancies must be reported to [MG]², Inc. within 48 hours.
UPS Freight 312 912 821

Inspected by _____ Date _____

Packing List postfile L7 external & polemount 1/07/00

APPENDIX C:
MG² INTERNAL-TYPE CLD INSTALLATION GUIDE
(Guide courtesy of MG²)

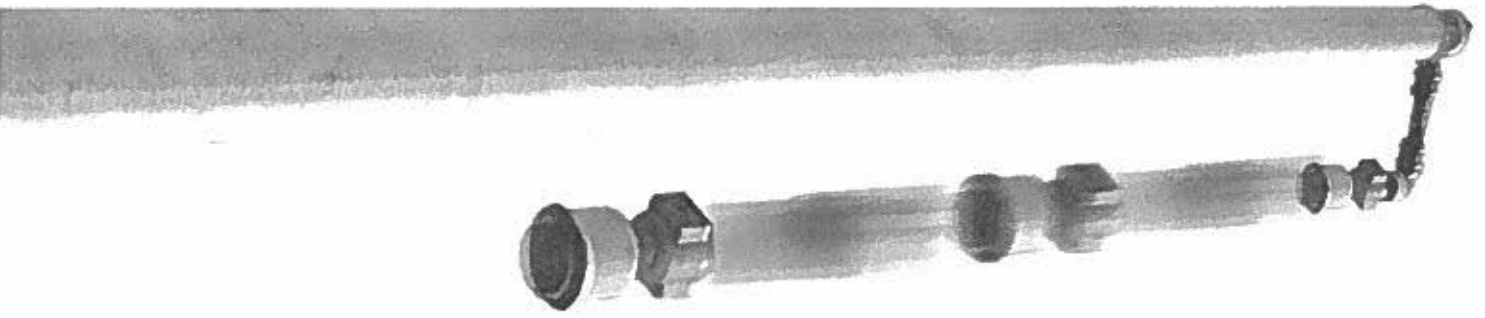

Owner's Manual

Guide to installing and operating a camera lowering system

MG Squared, Inc. • 3301 Oak Hill Drive • Birmingham, AL 35216
Ph: 205-823-6688 • **Fx:** 205-823-6615
www.LoweringSystems.com

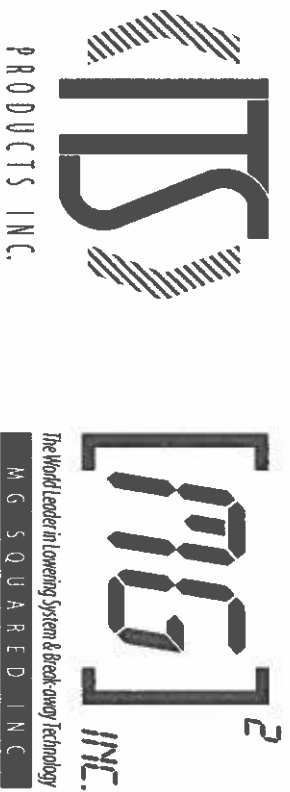

CLD

CLD - Stands for Camera Lowering Device
 FLD - Stands for Fixture Lowering Device
 ILD - Is a general term that stands for Individual Lowering Device

Camera Lowering Device for Pole Mounting Multi-Function Surveillance Cameras

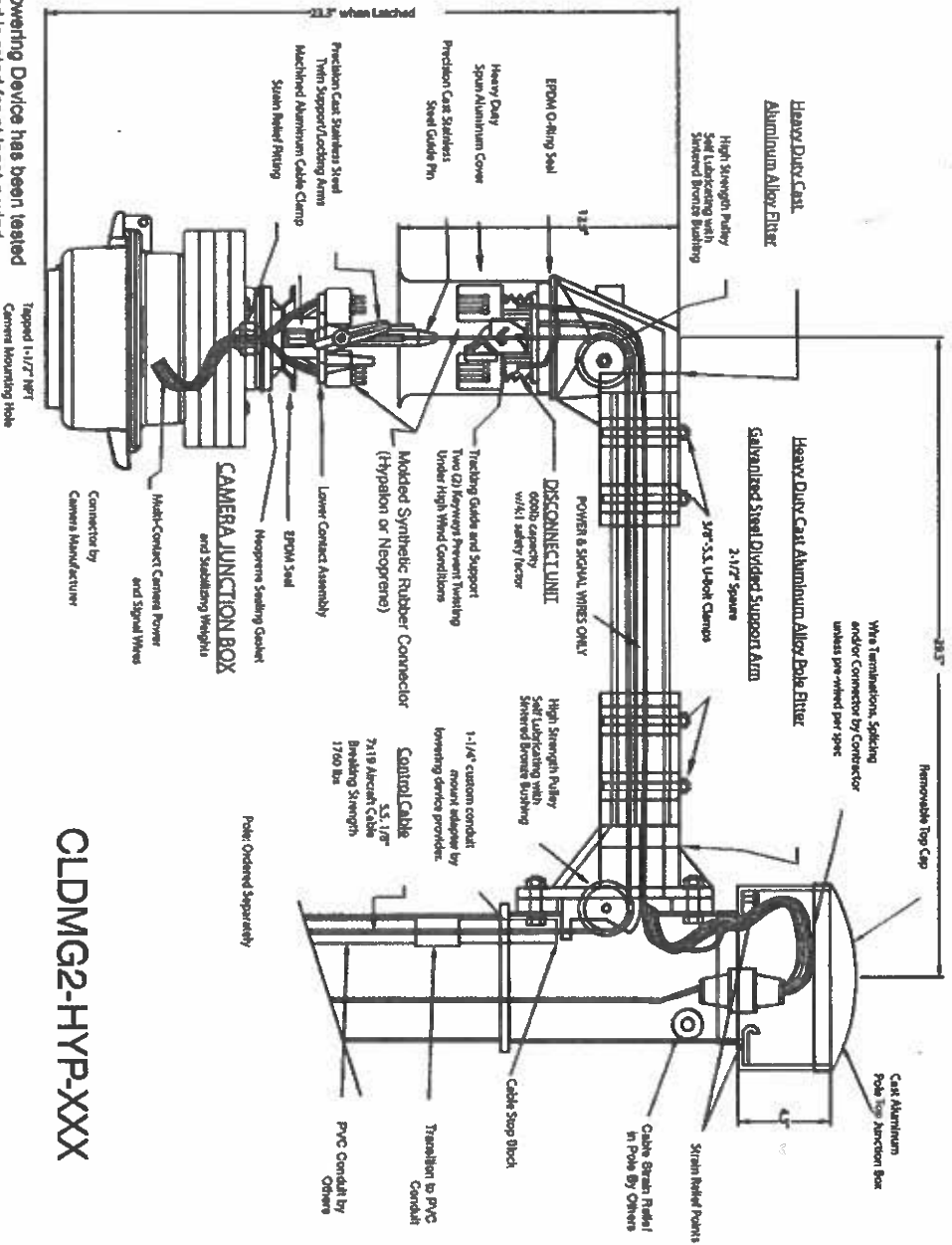

CLDMG2-HYP-XXX

Lowering Device has been tested and is rated for at least a wind load of 100mph w/ 30% gust with a 1.5 factor of safety

• DO NOT BEGIN INSTALLATION UNTIL A FACTORY REPRESENTATIVE HAS CONDUCTED ON-SITE TRAINING

If Specifications require On-site Training, any installation of Lowering Device Equipment prior to on-site training by a factory rep. may void certification. This does not include the mating of poles with multiple sections.

Use this Cut-Sheet to familiarize yourself with the CLD and the parts and terms.

This sheet is for reference only. Actual job/project cut sheet may differ. See project submittals for full details.



CLD

CLD - Stands for Camera Lowering Device
 FLD - Stands for Fixture Lowering Device
 ILD - Is a general term that stands for Individual Lowering Device

Camera Lowering Device w/ Heavy Duty Pin Contacts inserted in plastic contact carriers

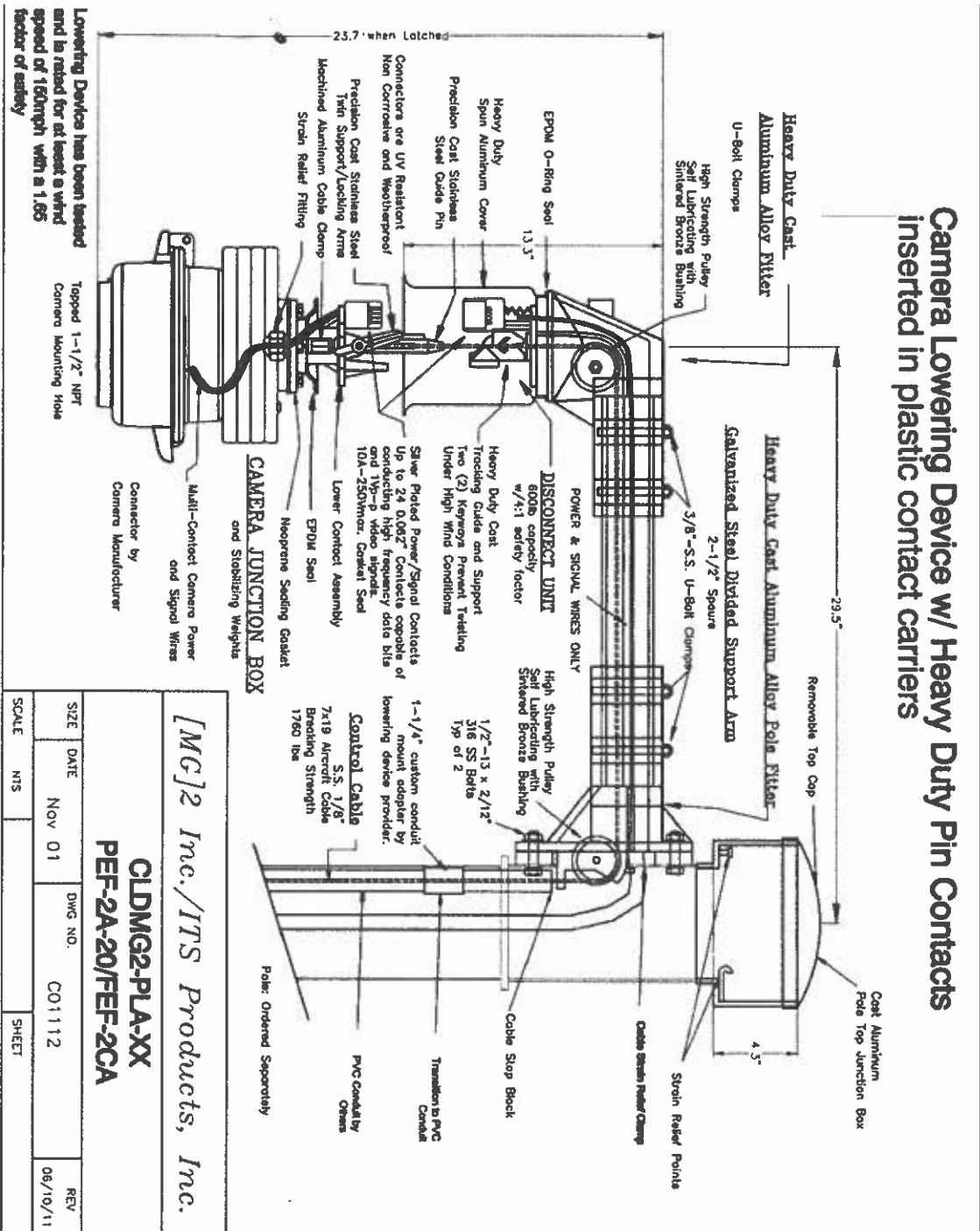

[MC]2 Inc./ITS Products, Inc.

CLDMG2-PLA-XX
 PEF-2A-20/FEF-2CA

SIZE	DATE	DWG. NO.	REV
SCALE	NOV 01	CO1112	06/10/11
SHEET		SHEET	

• DO NOT BEGIN INSTALLATION UNTIL A FACTORY REPRESENTATIVE HAS CONDUCTED ON-SITE TRAINING

If Specifications require On-site Training, any installation of Lowering Device Equipment prior to on-site training by a factory rep. may void certification. This does not include the mating of poles with multiple sections.

Use this Cut-Sheet to familiarize yourself with the CLD and the parts and terms.

This sheet is for reference only. Actual job/project cut sheet may differ. See project submittals for full details.

Version 5.9 (10/30/2014) page 02B
 p.20-ADB-CIB



Introduction

The [MG]², Inc. / ITS Products lowering device provides a locking mechanism which ensures that the full weight of the camera/lighting fixture or other device is carried by the contact suspension, thus, relieving the winch, pulleys, and steel cable from tension. These parts are in tension only during actual raising and lowering of the camera/lighting fixture.

The electrical connection is broken during unlocking and lowering, thus, no live cables are lowered with the camera/fixture.

The camera/lighting fixture can be lowered to ground level by one person without the need for ladders, bucket trucks, lifts, scaffolding, etc.

GENERAL NOTES/FACTS

- Please read **ALL** instructions prior to assembly. If there is something you do not understand, contact [MG]², Inc (205-823-6688) before installation.
- The erected pole must be vertical/plumb.
- Camera/Luminaire or other device **MUST BE** balanced vertically in all planes.
- Camera/Luminaire balance is very important so as not to create difficulty in locking and unlocking.
- The contact unit must have a minimum weight sufficient to disengage the locking mechanism (additional weight can be supplied).
- The bottom and top halves of the connector assembly are tested as a set. **DO NOT INTERCHANGE** bottom and top halves without written consent from the factory. Each half has a serial numbered hard stamped to help ensure sets are maintained.

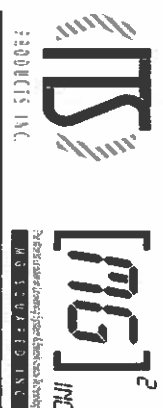

• DO NOT BEGIN INSTALLATION UNTIL A FACTORY REPRESENTATIVE HAS CONDUCTED ON-SITE TRAINING

If Specifications require On-site Training, any installation of Lowering Device Equipment prior to on-site training by a factory rep. may void certification. This does not include the mating of poles with multiple sections.

Tools

MG Squared/ITS Products recommends the following tools for the Assembly of the Camera/Fixture Lowering Device.



Ratchet with:

- 1 1/16" Socket
- 1 1/8" Socket
- 3/4" Deep Socket
- 9/16" Deep Socket
- 7/16" Socket or Nut Driver



Wrenches:

- 1 1/16" wrench
- 1 1/8" wrench
- 3/4" wrench
- 9/16" wrench
- 7/16" wrench
- 1/2" wrench



10" Socket Extension



Nut Driver:

- 7/16"
- 1/2"



Heavy Duty Cutting Pliers



Screw Drivers

- Flat-Head
- Phillips-Head



Fish Tape



Wire Strippers



Voltage Meter



Allen Wrenches (SAE)



Adjustable Crescent Wrench



Silicone Sealant



Mule Tape
(standard rope or cable pulling twine)



• DO NOT BEGIN INSTALLATION UNTIL A FACTORY REPRESENTATIVE HAS CONDUCTED ON-SITE TRAINING

If Specifications require On-site Training, any installation of Lowering Device Equipment prior to on-site training by a factory rep. may void certification. This does not include the mating of poles with multiple sections.



Electrical Tape



PVC Primer & Glue



PVC Cutter able to cut 1 1/4" minimum

(A Hack Saw may be used as an alternate)



Loctite Heavy Duty Anti-Seize For Stainless Steel

Pre-Installation Check List

Most Important: read through the installation manual thoroughly before installation. If Onsite Training/Certification is required, contact MG Squared a minimum of two weeks before the initial install date for scheduling.

Before mobilizing and scheduling instruction, please confirm:

- All material has been received including:
 - Poles/hardware
 - Lowering Devices/hardware

Inspect material for missing parts and damage

Pole Check (concrete)

Concrete Pole: concrete poles are shipped with a custom pole top tenon that allows attachment of the lowering device. Tenons may, and typically, ship pre-attached to the pole. *The contractor/customer is responsible for the off-loading of the poles on delivery.*



Shipping/Delivery Notes



CLD Box on Skid: Details of Contents Marked on Box

- CLD Materials ship separate from the poles and usually arrives in boxes and/or on skids.
- Some Accessories (Electric Drill), ship separately from Poles and from CLD Material.

Confirm you have the tenon and hardware needed for the tenon

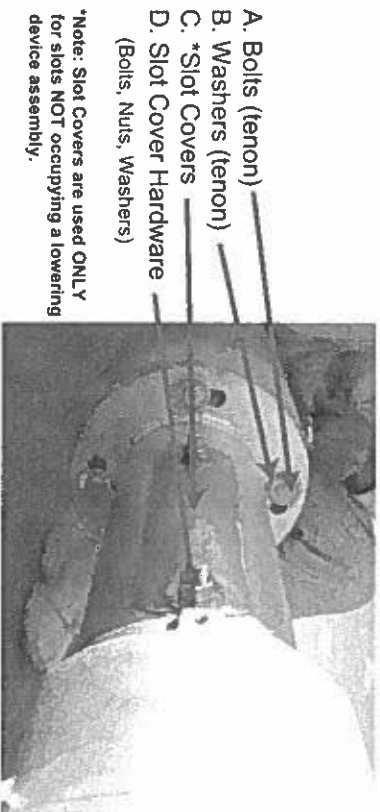

Hand Hole Inspection:

- A. Remove the hand hole cover and confirm there are a minimum of two "Parking Stands" (welded or cast rings/eylets).
- B. Please confirm there is also a 1/2" tapped hole in the bottom of the hand hole. Typically a "Throw-away" bolt is pre-installed in the 1/2" tapped hole to prevent debris from clogging the hole.

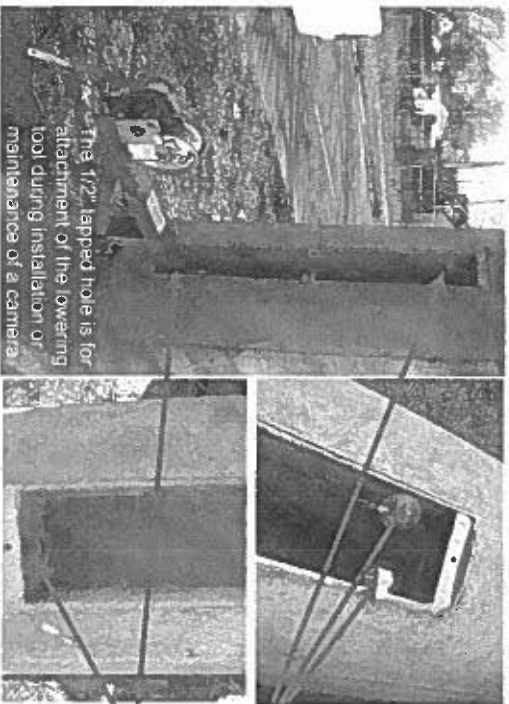
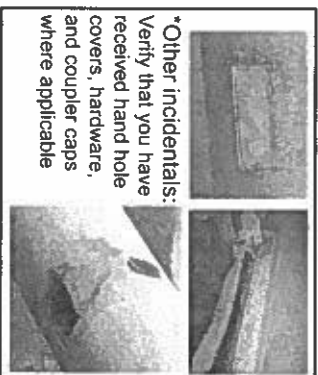
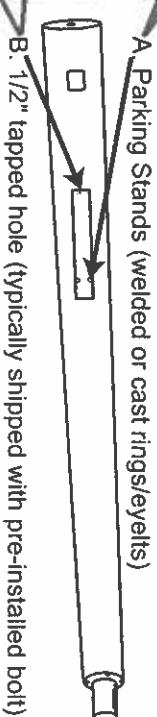

Pre-Installation Check List cont.

Pole Check (steel)

Steel Pole: Steel poles are shipped with a custom pole top tenon that allows attachment of the lowering device. Tenons and tenon hardware typically ship and are delivered with the poles either loose, boxed, skidded, or pre-installed onto the poles. Please verify delivery of the tenon and other pole hardware including: covers, bolts, nuts, washers, grounding lugs. Some items including Anchor Bolts may be shipped separately. *The contractor/customer is responsible for the off-loading of the poles on delivery.*

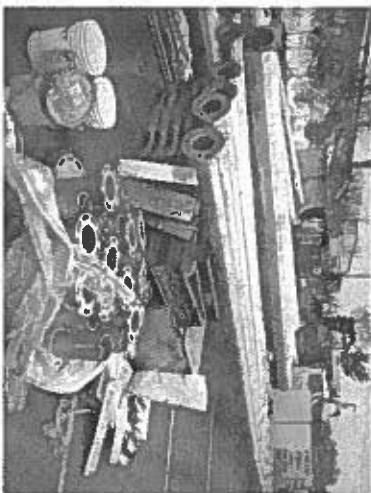

Verify you have received pole top tenons and included tenon hardware from the pole manufacturer

Confirm you have the tenon and hardware needed for the tenon

- A. Bolts (tenon)
- B. Washers (tenon)
- C. *Slot Covers
- D. Slot Cover Hardware (Bolts, Nuts, Washers)

***Note: Slot Covers are used ONLY for slots NOT occupying a lowering device assembly. Most Steel poles are designed with a single slot**

Hand Hole Inspection:

A. Remove the hand hole cover and confirm there is a minimum of one "Parking Stand" in the upper portion of the hand hole (welded or cast rings/eylets). Typically a "U" shaped parking stand is welded or bolted to the upper portion of the hand hole. An additional one to two may be included on the interior of the pole

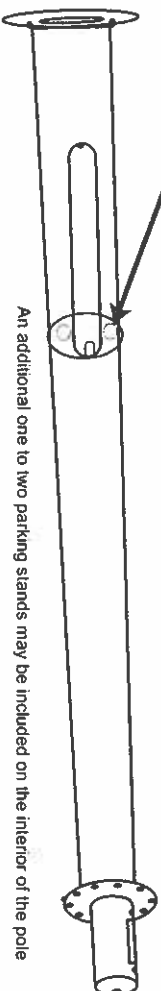

B. Please confirm there is also a 1/2" tapped hole in the bottom of the hand hole. Typically a "Throw-away" bolt is pre-installed in the 1/2" tapped hole to prevent debris from clogging the hole.

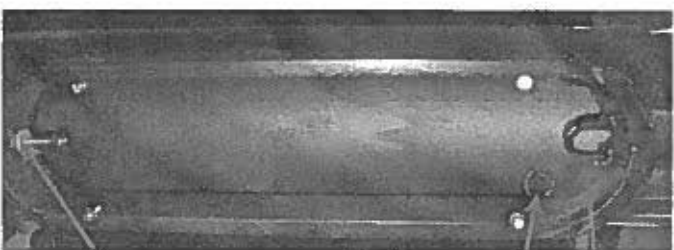

Pre-installation Check List cont.

Camera Lowering Device

1. CLD which stands for "Camera Lowering Device" (see figure 1)

- A. CLD
 - i. square support arm with pole fitter & disconnect unit fitter
 - ii. disconnect unit (upper/bottom contact unit) inside bell cover
 - iii. stainless steel cable
- B. Camera Junction Box plus 4 external circular weights
- C. Pole Top Junction Box
- D. Conduit Fitter (can be found attached to support arm/bell for shipment)
- E. Accessories
 - i. Winch (Safety Clutch/CLD Installation Manual packaged with the winch)
 - ii. Electric Drill & Clutch Package (if ordered from MG2)
 - iii. Optional Composite Cable (if ordered from MG2)

The following item is NOT Provided by MG Squared and is required in order to complete the installation

2. 1.25" PVC Conduit: Each pole will require enough conduit to be installed from the pole top to the top of the hand hole



DO NOT BEGIN INSTALLATION UNTIL A FACTORY REPRESENTATIVE HAS CONDUCTED ON-SITE TRAINING

If Specifications require On-site Training, any installation of Lowering Device Equipment prior to on-site training by a factory rep. may void certification. This does not include the

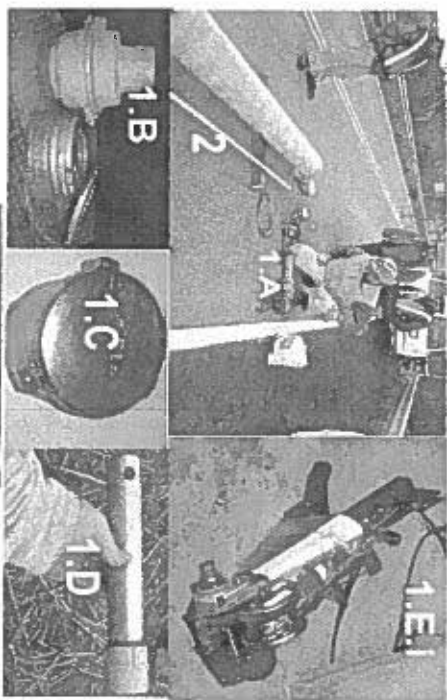

Shipping/Delivery Notes

- Typically Poles and Pole Top Tenons (along with miscellaneous bolts, nuts, and washers) ship together
- CLD Materials ship separate from the poles and usually arrives in boxes on skids.
- Some Accessories (Electric Drill), ship separately from Poles and from CLD Material.

CLD Box on Skid
Details of Contents
Marked on Box

Installation

Pole Preparation

Poles are custom designed and engineered to accommodate the MG Squared Lowering Device. MG Squared has OEM arrangements with the Major Steel & Concrete Manufacturers to provide you with a reliable system that meets or exceeds the specifications. It is important to refer to the instructions provided by the pole manufacturer for details on Loading, Unloading, Assembly (telescoping joints, multiple sections), Lifting, Setting, Plumbing, and other requirements.

1. Start with the pole in a horizontal position with the top of the pole ideally 3 feet off the ground. The pole should be positioned so that the hand holes, are accessible. Refer to the project plans/notes/ or engineer for the mounting location of the arm/camera in relation to the roadway. With this in mind, position the pole so that when the tenon is later attached (if not already attached), and the CLD (arm) attached to the tenon, the hand hole WILL BE 90° or more from the mounted position of the CLD. See figure 1 & 2.

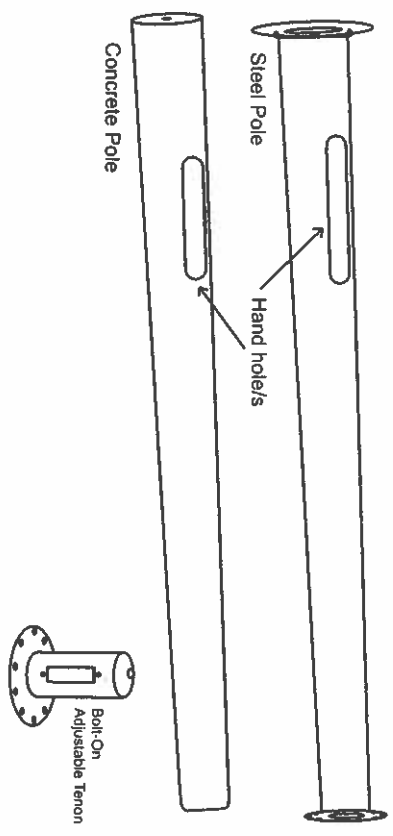

Figure 2

*Determine Camera and hand hole orientation before installing CLD

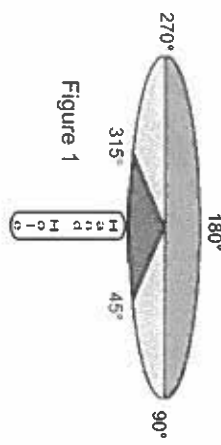
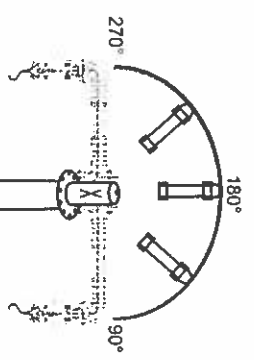

Figure 1

- **DO NOT BEGIN INSTALLATION UNTIL A FACTORY REPRESENTATIVE HAS CONDUCTED ON-SITE TRAINING**
- If Specifications require On-site Training, any installation of Lowering Device Equipment prior to on-site training by a factory rep. may void certification. This does not include the making of poles with multiple sections.*



Installation

Conduit & Tenon

2. Bolt on the adjustable tenon. If the tenon is already attached, be sure the tenon slot is aligned to the desired location in relation to the handhole. If the tenon has more than 4 slots, it is only necessary to use 4 bolts/washers/nuts. Remember that the slot in the tenon, where the CLD arm will attach, must never be positioned over the handhole. See previous sheet for more details.



3. Assemble the 1 1/2" PVC Conduit (Not provided by MG²) the length from the handhole to the pole top using PVC primer and PVC Glue and allow to dry.

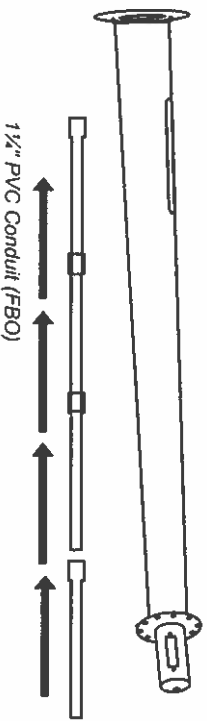

4. Assemble the provided 1 1/2" rigid Conduit Fitter to the to one end of the PVC conduit using primer and glue. Allow to dry.

It is not necessary to unscrew the provided coupling from rigid Conduit Fitter. The rigid Conduit Fitter is usually found wrapped to the bell housing on the CLD.

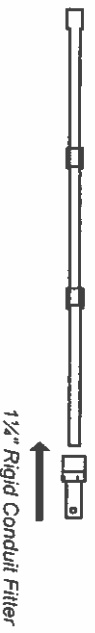

Assembly of Adjustable Tenon to Pole Top

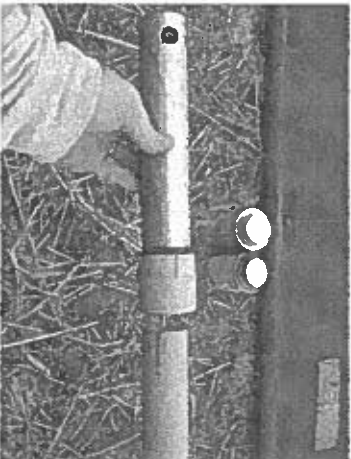

Assembly of 1 1/2" Rigid Conduit Fitter to PVC Conduit

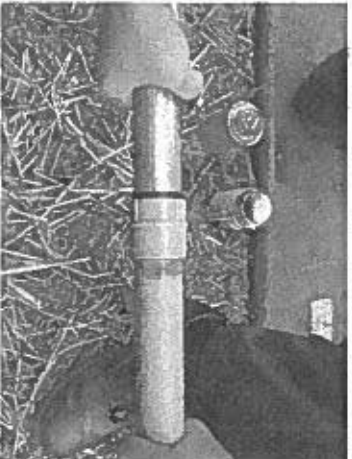

• DO NOT BEGIN INSTALLATION UNTIL A FACTORY REPRESENTATIVE HAS CONDUCTED ON-SITE TRAINING

If Specifications require On-site Training, any installation of Lowering Device Equipment prior to on-site training by a factory rep. may void certification. This does not include the mating of poles with multiple sections.



PVC Primer & Glue

PVC Cutter able to cut 1 1/2" minimum (A Hack Saw may be used as an alternate)

Installation

Conduit & Tenon cont.

5. Feed the conduit through the tenon and down towards the hand hole.

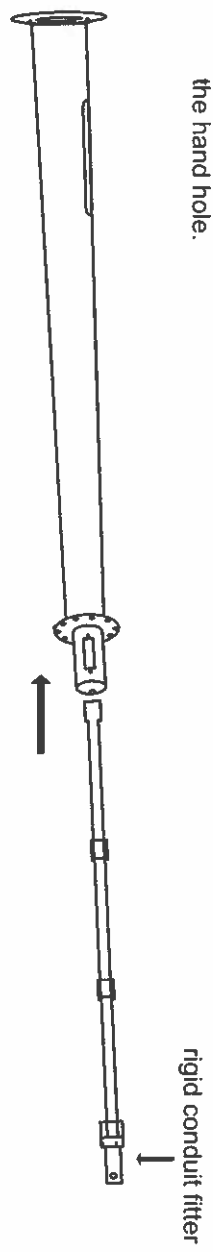

rigid conduit fitter

6. Continue feeding the conduit down the pole until the hole on the rigid conduit Fitter is aligned with the bottom bolt hole on the tenon with the slot. Mark the conduit flush with the top of the hand hole and cut off the excess PVC. Glue on the provided Bell Coupler (Fig 1) to the freshly cut end of the PVC. Be sure not to cut the conduit above the top of the hand hole (Fig 2).
**It may be necessary to remove the entire Conduit if you are having difficulty cutting the excess.*



Fig 2

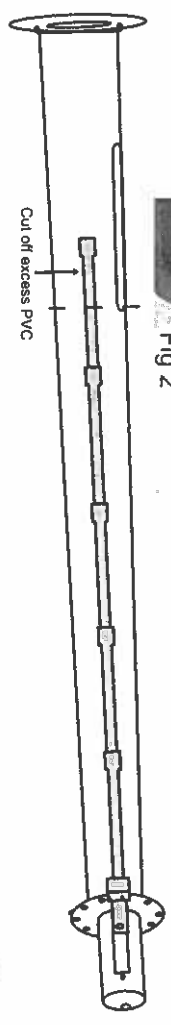

Cut off excess PVC



Fig 1

7. Remove the Bolt/Nut/Washer from the bottom hole of the CLD. Line up the small hole in the Rigid Conduit Fitter with the bottom hole in the tenon. Temporarily attach the Rigid Conduit Fitter to the tenon by inserting the bolt through the large hole on the Fitter and securing with the bolt and washer.

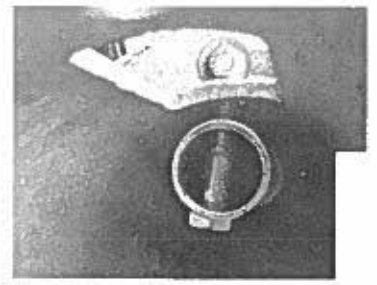
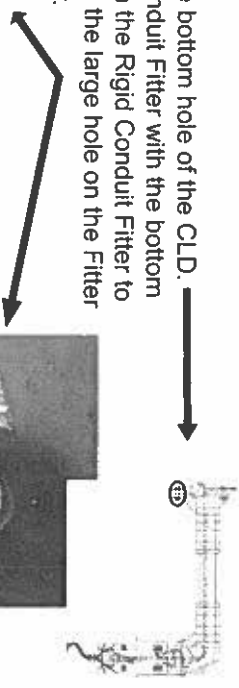
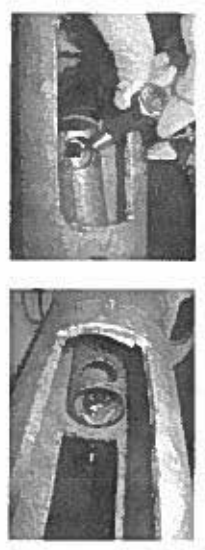

• DO NOT BEGIN INSTALLATION UNTIL A FACTORY REPRESENTATIVE HAS CONDUCTED ON-SITE TRAINING

If Specifications require On-site Training, any installation of Lowering Device Equipment prior to on-site training by a factory rep. may void certification. This does not include the mating of poles with multiple sections.

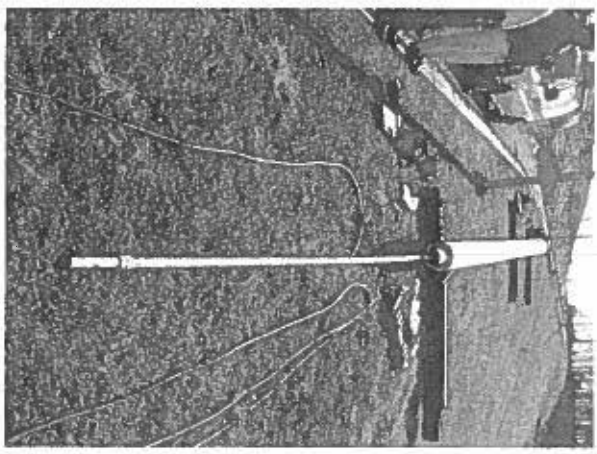

**at the time the conduit is pushed down the pole, some contractors prefer to use the conduit as a push rod by lapping the power/signal cable to the outside*



Installation

CLD Attachment

- Fetch the CLD and place it next to the pole top tenon near the slot where the CLD will be mounted. ***Be sure to keep the CLD clean and clear of dirt and debris. Dirt can foul the locking mechanism.**

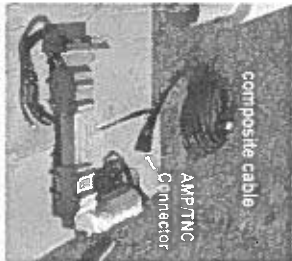

If your Device came "Pre-wired" from our factory, it will be easier if you disconnect the composite cable from the CLD by the quick disconnect AMP/TNC connectors. ***Be sure to keep the exposed connectors free from any dirt or debris.**

- Locate the Stainless Steel Cable attached to the CLD. Unroll the Stainless Steel Cable(s) in a hand over hand method to avoid curls in the cable. ***Curls or kinks in the Stainless Steel Cable can prevent the device from functioning properly.**



- Bring the end of the Stainless Steel Cable back to the tenon and thread the thimble end with the quick-link through the slot in the tenon and pull down through the fitter/conduit with fishtape.

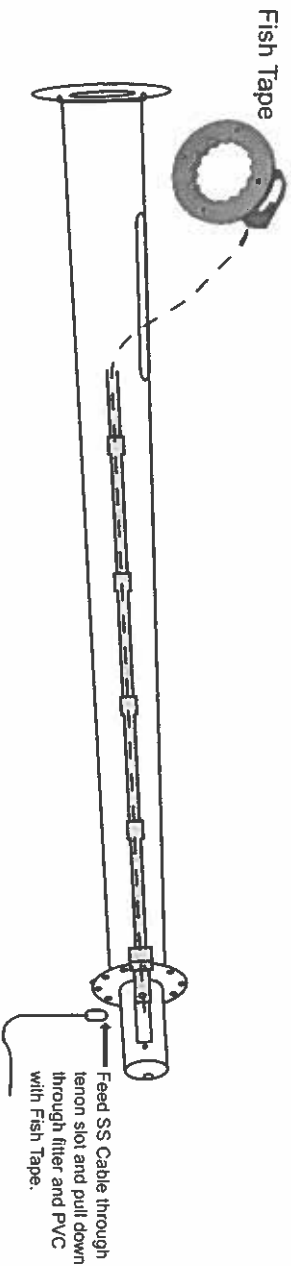

Place the CLD Near the top of the pole



• DO NOT BEGIN INSTALLATION UNTIL A FACTORY REPRESENTATIVE HAS CONDUCTED ON-SITE TRAINING

If Specifications require On-site Training, any installation of Lowering Device Equipment prior to on-site training by a factory rep. may void certification. This does not include the making of poles with multiple sections.



Installation

CLD Attachment cont.

11. As the Fish Tape Pulls the SS (Stainless Steel) Cable down the conduit, it will be necessary to lift the CLD and begin to attach the arm to the tenon. While doing this, several procedures must occur:

- (a.) Remove the Nut/Washer from the bottom bolt that is threaded through the Conduit Filter/Tenon.
- (b.) The Electrical conductors in the arm pass through the slot and out the top of the tenon.

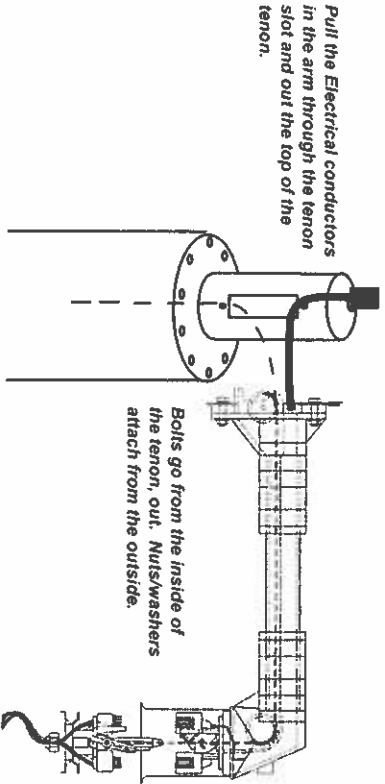

***Be sure to keep the stainless steel cable from being pinched behind any bolts. Damage to the SS cable can cause the CLD to malfunction.**



• DO NOT BEGIN INSTALLATION UNTIL A FACTORY REPRESENTATIVE HAS CONDUCTED ON-SITE TRAINING

If Specifications require On-site Training, any installation of Lowering Device Equipment prior to on-site training by a factory rep. may void certification. This does not include the mating of poles with multiple sections.

12. Attach the CLD to the Tenon with the bolts provided (nuts go on the outside of the tenon). **BE CAREFUL NOT TO PINCH CONDUCTORS OR SS LOWERING CABLE.** (recommended torque on the 1/2" bolts is 42ft-lbs)
**Tip: Coating of stainless steel bolts with anti-seize lubricant is recommended*
13. Once the CLD is attached, remove the SS Cable from the Fish-Tape and connect the Quick-Link onto the Parking Stand (Ablate) located in the closest vertical plane as the CLD orientation.

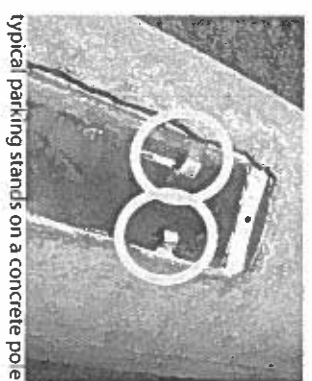
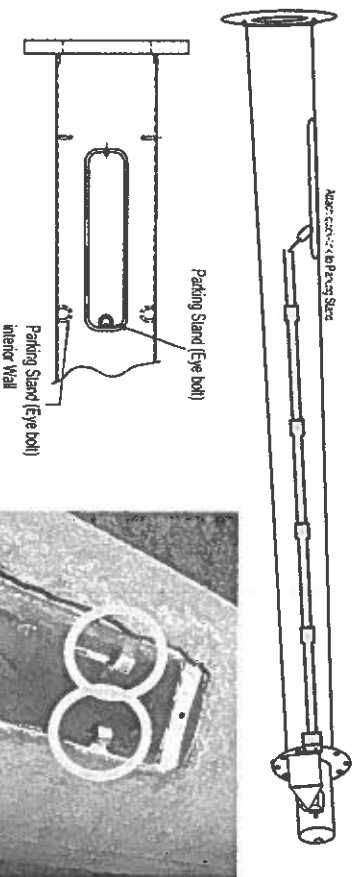

***DO NOT INSTALL THE CAMERA JUNCTION BOX UNTIL THE POLE IS ERECTED AND SET.** Installing the Camera Junction Box prior to setting of pole may damage the alignment probe and void all warranties.



Installation

CLD SS Cable and Cable Clamp



- Now that the Lowering Device is attached to the Tenon & the Quicklink is attached to the appropriate Parking Stand and secured, detach the bottom contact unit from the upper unit by pulling down on the contact and locate the Cable Clamp at the end of the SS Cable.

Notes: The Cable Clamp ships with a Green Sticker attached that says to refer to these Instructions before proceeding.
(Sticker Color may also be yellow or orange)

• DO NOT BEGIN INSTALLATION UNTIL A FACTORY REPRESENTATIVE HAS CONDUCTED ON-SITE TRAINING

If Specifications require On-site Training, any installation of Lowering Device Equipment prior to on-site training by a factory rep. may void certification. This does not include the mating of poles with multiple sections.

Grip Lower Contact with fingers and use thumbs to push against the bell housing to release contact

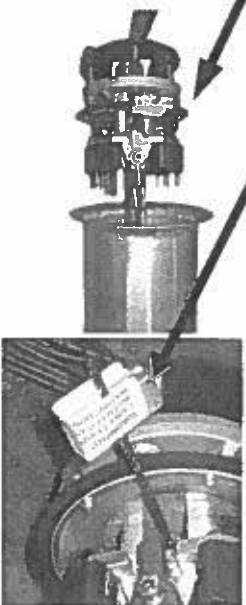
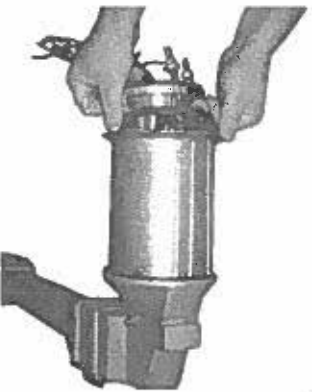
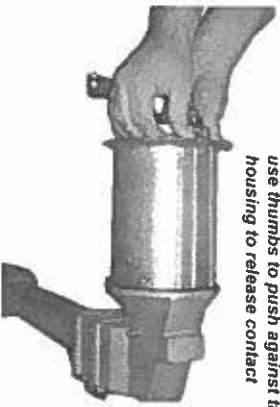

The Units are shipped Unlatched from the factory. However, if the contact unit is latched, you will need to push in the contact unit up and then down to unlatch, and then pull the unit out. see illustration below.

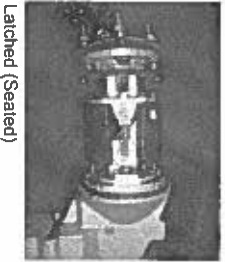
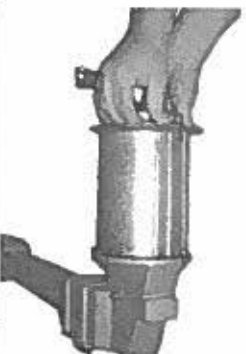

Latched (Seated)



Grip Bell with fingers and push up on contact using thumbs to squeeze spring-loaded contact.



Grip Lower Contact with fingers and use thumbs to push against the bell housing to release contact



Unlatched

Installation

CLD SS Cable and Cable Clamp cont.

15. Now that you have detached the bottom contact unit and located the cable clamp, with the SS cable (lowering cable) secured to the appropriate parking stand, grip the cable clamp and take out all of the slack. With the slack out and slight positive tension on the lowering cable (to keep it on the pulleys), push the bottom contact unit back into the bell until the rubber gasket around the bottom unit is in contact with the bell. *It is not necessary to latch the unit. During installation, NEVER engage or disengage the lowering device without first maintaining tension on the lowering cable at the hand hole. This is to prevent the unlikely event of the lowering cable coming off one of the pulleys inside the CLD.*

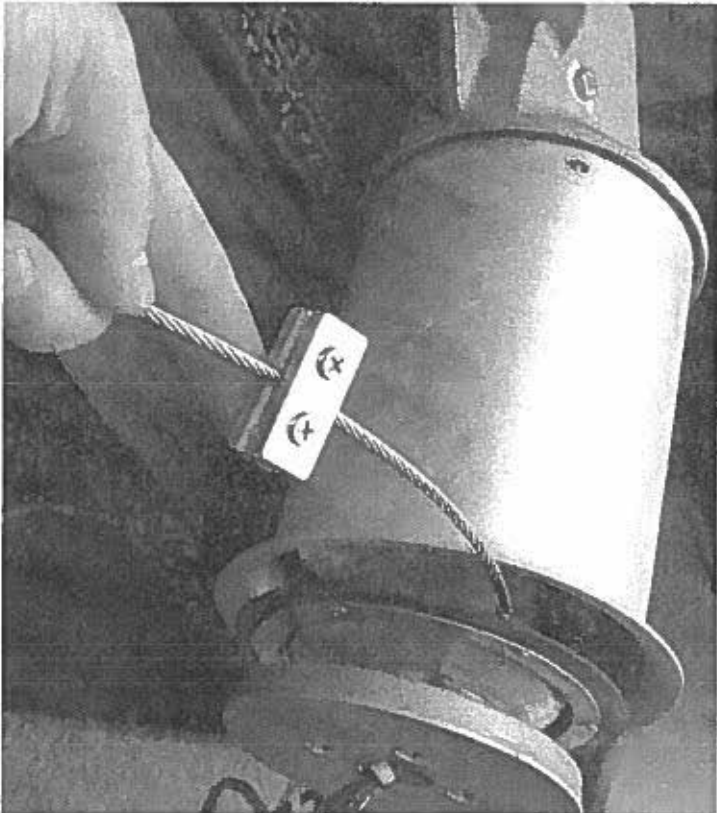

• DO NOT BEGIN INSTALLATION UNTIL A FACTORY REPRESENTATIVE HAS CONDUCTED ON-SITE TRAINING

If Specifications require On-site Training, any installation of Lowering Device Equipment prior to on-site training by a factory rep. may void certification. This does not include the making of poles with multiple sections.

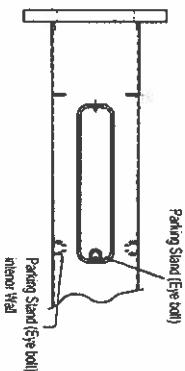

During installation, never engage or disengage the lowering device without first maintaining tension on the lowering cable either at the hand hole, or by pulling tension from the cable clamp.

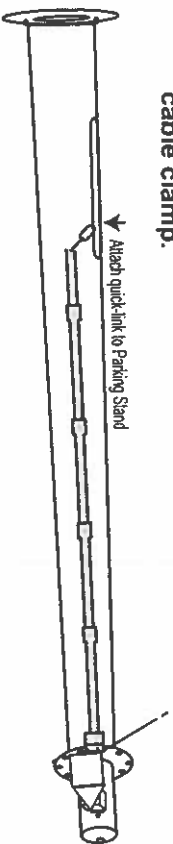

Installation

CLD SS Cable and Cable Clamp cont.

16. Make up the NON-SLIP SAFETY KNOT to the clamping hardware as close to the bottom contact unit as possible to prevent excess cable slack. Wrap the SS cable with Electrical tape about 1.25" from the clamp before cutting the excess cable to prevent fraying. Cut the cable through the electrical tape.

See instructions below:

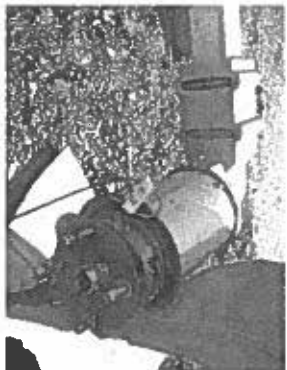

CABLE CLAMP ASSEMBLY AND USE FOR SYSTEMS WITH CAPACITIES UP TO 400 POUNDS (181 kg)

- To facilitate ease of feeding the wire through the cable clamp, if necessary trim leading end of cable square making sure there are no protruding strands of wire. Do Not Use Lubricant of Any Kind On The Portion of Cable That Is To Be Within The Cable Clamp.
- Loosen screws of clamp to separate the clamp halves enough to fit the cable through the notches but do not remove the screws completely.
- Feed cable end coming from the bottom of the contact unit into the center notches of the cable clamp. Pull approximately 5 inches of cable through the clamp.
- Insert the end of the cable through one of the side notches. Cable should move easily through the notches of the clamp. If the cable is too loose and moves out of the notches, tighten the screws slightly until the cable stays within the notches. Do not pull cable tight.
- Pass the end of the cable across to the other side notch and through the clamp.
- End of cable must be fed through loop formed by cable coming from center notch and first side notch so that when cable is pulled tight the loop closes on the end portion of the cable.
- Carefully pull the cable loops tight by back pulling on the cable portion coming from the disconnect unit. Be sure cable remains within the notches of the clamp. With all loops small as possible, tighten screws in an alternating pattern until tight. After wrapping with electrical tape, trim cable end as necessary leaving 1.25" to 1.75" extruding from knot.
- Insert the Cable Clamp into slot in the bottom contact.
- Check cable clamp, cable, and screws for tightness every time cable clamp is lowered when the system is operated.

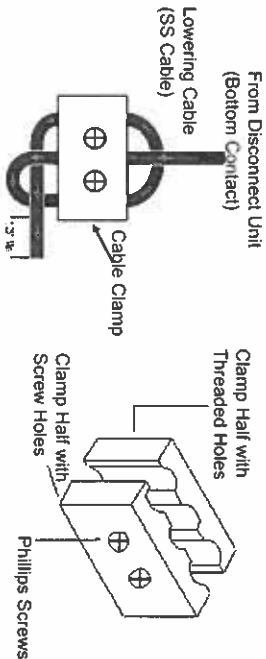

DO NOT BEGIN INSTALLATION UNTIL A FACTORY REPRESENTATIVE HAS CONDUCTED ON-SITE TRAINING

If Specifications require On-site Training, any installation of Lowering Device Equipment prior to on-site training by a factory rep. may void certification. This does not include the mating of poles with multiple sections.

WARNING: TO PREVENT SERIOUS PERSONAL INJURY, THE CABLE CLAMP MUST BE PROPERLY ASSEMBLED AND THE CABLE MUST BE PROPERLY ROUTED THROUGH THE CLAMP AS SPECIFIED WITHIN. NO ATTEMPT AT LIFTING ANY LOAD SHOULD BE MADE UNTIL ALL SPECIFICATION CONDITIONS ARE MET.

DO NOT LIFT PEOPLE OR OPERATE ANY LOWERING SYSTEM OVER PEOPLE. NEVER STAND DIRECTLY BELOW LOWERING DEVICE DURING OPERATION.

USE ONLY 1/8 INCH OR 5/32 INCH DIAMETER 7x19 CONSTRUCTION CABLE WITH THIS CLAMP.

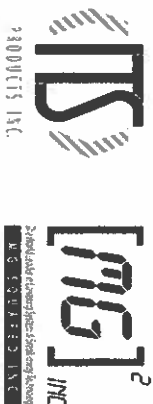

Installation

CLD SS Cable and Cable Clamp additional info.

Please refer to the previous sheet for details and and Specifications on the assembly of the Cable Clamp. This Sheet contains extra information, photos and tips when assembling the Cable Clamp to the Lowering Cable.

Important Notes on the Lowering Cable (SS Cable)

The length of the Lowering Cable is crucial to the proper and safe functioning of the CLD.

*If the Cable is too long, then the hardware on the portable winch will get caught in the pulley on the winch frame, not allowing the CLD to latch or unlatch.

*If the Cable is too short, then it will be difficult to attach the Lowering Cable to an available parking stand located on/or inside the hand hole.

By attaching the Lowering Cable (SS Cable) to a parking stand during installation, pulling out all slack, and assembling the cable clamp as close to the bell housing as possible - this will typically give you the desired length of cable to properly latch (engage) and unlatch (disengage) the device.

However, the proper length can not be confirmed until after the pole is erected, the camera-junction box attached and the unit operated. Final adjustments, if necessary, can easily be made at ground level following the procedures discussed later in this manual.

Lastly, the Stainless Steel Lowering Cable is subject to stretching over time and use. This is a normal and natural occurrence. Therefore, over time it may be necessary to shorten the length of the Lowering Cable during routine maintenance.

Additional Photos of the Cable Clamp Assembly

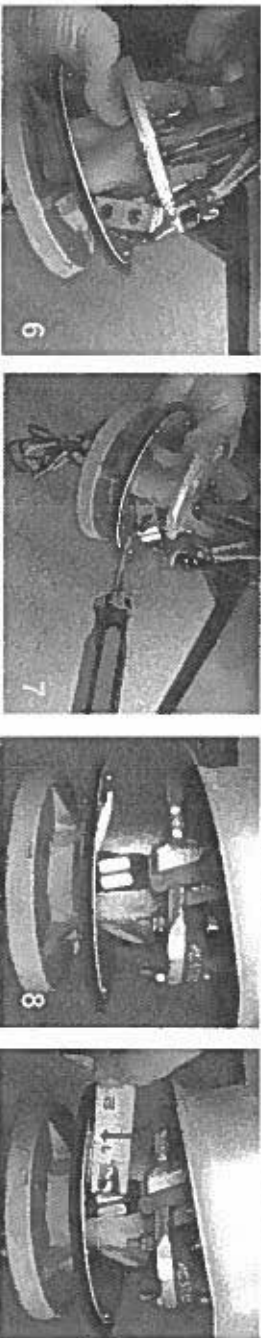

Cable Clamp Must be installed into the slot correctly with the shortened end on the bottom of the contact slot. See Image to the right for reference.

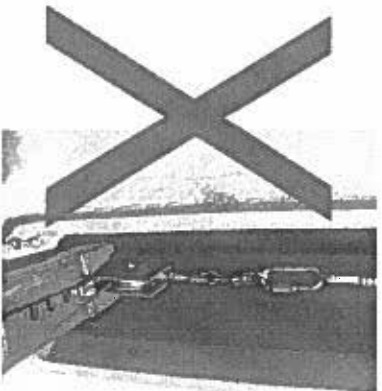
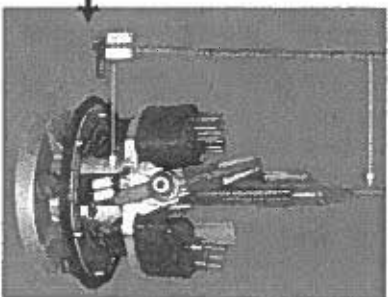

If Specifications require On-site Training, any installation of Lowering Device Equipment prior to on-site training by a factory rep. may void certification. This does not include the mating of poles with multiple sections.

This photo shows a lowering cable that is too long. The hardware is getting caught in the pulley of the winch, thus not allowing the CLD to engage or disengage. Cranking this hardware into the pulley can damage the crimps and cable, causing the cable to break. Refer to the section on making final adjustments to the lowering cable later in this manual.

Installation

Composite/Power Signal Cable

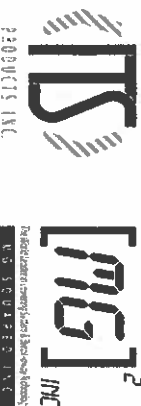

17. Now that the CLD is attached and the Lowering cable secured with the Cable Clamp Assembly, Feed the Composite/Power Signal Cable down through the tenon to the bottom of the pole. It is permissible to have fed the composite cable down the pole while the conduit was being installed in the pole. Be sure to properly strain relieve the composite/power signal cable to either the J-hook/Eyebolt located inside the tenon, or it can be strain relieved inside the pole-top Junction Box.

• DO NOT BEGIN INSTALLATION UNTIL A FACTORY REPRESENTATIVE HAS CONDUCTED ON-SITE TRAINING

If Specifications require On-site Training, any installation of Lowering Device Equipment prior to on-site training by a factory rep. may void certification. This does not include the making of poles with multiple sections.

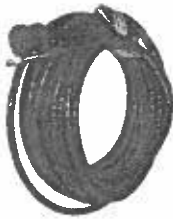

Optional MG Squared Composite Power/Signal Cable



Unroll Composite Cable Hand over Hand to avoid Kinks



Feed Power/Signal Cable Down Pole



If using pre-wired composite cable, simply plug the connectors

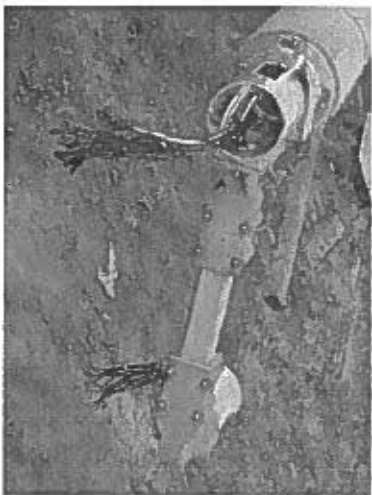

For Non-prewired systems, terminate the numbered CLD leads to your desired wire for Camera control, power, and video. It is up to the Contractor/Installer to determine the procedure for terminating the wires (example: butt-splice, solder, terminal strip, etc.) Be sure to make a record of your wiring diagram for later reference. It is **HIGHLY** recommended to run a continuity check of all splices.

Using a Kellums Grip, Strain relieve the power/signal cable to the J-hook/Eyebolt located in the tenon or pole-top J-box

Installation

Pole Top Junction Box & Final Check

18. After terminating all conductor/wires, secure the Pole-Top Junction Box to the tenon. Strain relieve the composite/power signal cable to either the J-hook inside the tenon, or onto the J-hook inside the Pole-Top Junction Box. Adjust the strain relief so that all cable/connectors fit inside the Pole-Top Junction Box. Keep power/signal cable clear from the Lowering Cable. Before erecting each pole, Check all conductor/leads for continuity to verify a clean signal throughout each utilized pin. This will require you to engage the bottom contact. When doing so, be sure to keep positive tension on the cable by pulling the Lowering Cable at the hand hole. *With continuity confirmed, secure the lid of the Pole-Top Junction Box and disengage the bottom contact (Unlatch) and leave in the unlatched position to place positive tension on the cable until the pole is raised and set. **ATTACH A PULL CORD (MULE TAPE/ROPE) TO THE BOTTOM CONTACT AS THERE WILL BE VERY LITTLE OR NO WEIGHT ON THE CONTACT AT THIS TIME.** The pull cord will help guide the Bottom Contact near the hand hole once the pole is erect.



Secure Power/Signal Cable inside Pole Top Junction Box



Keeping slight tension on the Lowering cable, engage the bottom contact and perform a continuity check



Secure the Pole-Top Junction Box and cover.

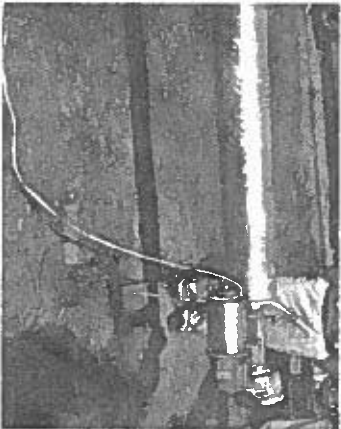

Disengage (Unlatch) the bottom contact and attach a Pull Cord to the bottom contact unit

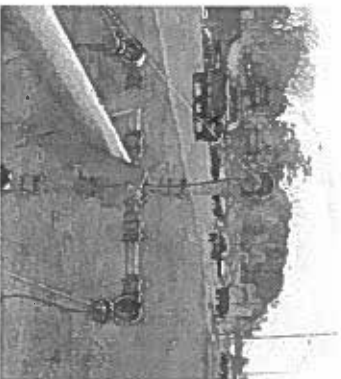

Be sure the bottom contact unit is unlatched before erecting the pole.

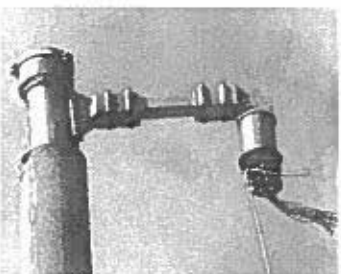

• DO NOT BEGIN INSTALLATION UNTIL A FACTORY REPRESENTATIVE HAS CONDUCTED ON-SITE TRAINING

If Specifications require On-site Training, any installation of Lowering Device Equipment prior to on-site training by a factory rep. may void certification. This does not include the mating of poles with multiple sections.



***Before Securing the lid of the pole-top J-Box, it is the contractor/integrator discretion whether to place any additional sealants, heat shrinks, or tape around the splices or connectors in the pole-top J-Box.**



***DO NOT INSTALL THE CAMERA JUNCTION BOX UNTIL THE POLE IS ERECTED AND SET.** Installing the Camera Junction Box prior to setting of pole may damage the alignment probe and void all warranties.

*** Raise the pole using care not to allow the arm to come into contact with the ground or the lifting hoist. Secure pole to the foundation**

Installation

Raise Pole, Attach Camera Junction Box

*** Raise the pole using care not to allow the arm to come into contact with the ground or the lifting hoist. Secure pole to the foundation**



19. After the pole is set, insert the lowering tool (winch) into the hand hole and secure it to the pole.

Feed the winch cable up and attach the winch cable to the tear drop eyelet of the Lowering Cable, using the Quick Link while leaving the Lowering Cable attached to the Parking Stand. Make sure that the threads of the Quick Link are completely engaged. The Lowering Cable should now be attached to both the winch and the parking stand. Once the winch cable is secured to the Lowering Cable, detach the Lowering Cable from the Quick Link that is attached to Parking Stand. **DO NOT DETACH THE WINCH CABLE UNTIL THE LOWERING CABLE IS REATTACHED TO THE PARKING STAND.** Lower the bottom contact unit and pull on the pull cord as necessary. Attach the Camera Junction Box to the bottom contact unit with all four bolts. ***See the Next Page for Details on installing the Camera Junction Box and External Weights.** Make sure gasket forms a weather-tight seal. The installer should place a bead of ultraviolet resistant outdoor use silicone around the gasket between the camera junction box and the bottom disconnect unit). See Camera Manufacturer's instructions for attaching camera.

***Non-Pressurized Cameras should be sealed/potted to prevent any moisture from entering the housing. Consult your Camera Manufacturer for proper procedures.**



Attach Winch to Pole

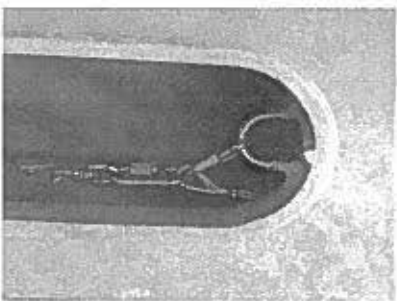

Secure Winch Cable to Lowering Cable, while leaving the lowering cable attached to the parking stand
***Be sure to fully engage all threads on the screw link (quick link).**



Once the Winch Cable is secure, remove the lowering cable from parking stand



Lower Bottom Contact Unit, using Pull Cord as necessary



Attach Camera Junction Box ***see next page (addendum A) for specific detail**

***Non-Pressurized Cameras should be sealed/potted to prevent any moisture from entering the housing. MG Squared takes no responsibility for water intrusion inside cameras/fixtures or other devices. Consult your Camera Manufacturer for proper procedures.**

• DO NOT BEGIN INSTALLATION UNTIL A FACTORY REPRESENTATIVE HAS CONDUCTED ON-SITE TRAINING

If Specifications require On-site Training, any installation of Lowering Device Equipment prior to on-site training by a factory rep. may void certification. This does not include the mating of poles with multiple sections.

torque for the 1/4" bolts that attach the Camera Junction box is 6 ft/lbs or 75 in/lbs

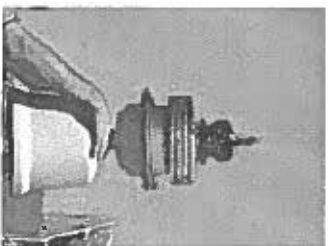

Attach Camera per Camera Manufacturer's instructions.

Please read ALL instructions prior to assembly. If there is something you do not understand, contact [MG]?, Inc. (205-923-6688) before installation.

- The erected pole must be vertical/plumb.
- Luminaires/camera must be balanced vertically in all planes.
- Luminaires/camera balance is very important so as not to create difficulty in locking and unlocking.
- The contact unit must have a minimum weight sufficient to disengage the locking mechanism (additional weight can be supplied).
- The bottom and top halves of the connector assembly are tested as a set. Do not interchange bottom and top halves without written consent from the factory.

Camera Junction Box Detail



***DO NOT INSTALL THE CAMERA JUNCTION BOX UNTIL THE POLE IS ERECTED AND SET.** Installing the Camera Junction Box prior to setting of pole may damage the alignment probe and void all warranties.

Current CJB (2013—Present)

*Included with 3 (three) stabilizing weights

Top View

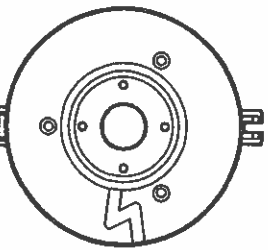

Stabilizing Weights Galvanized Cast Iron

9.9

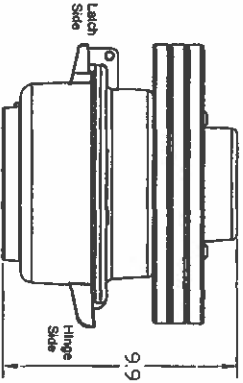

11.7

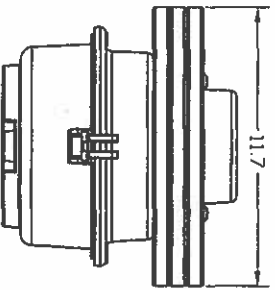

Two Piece Aluminum Junction Box

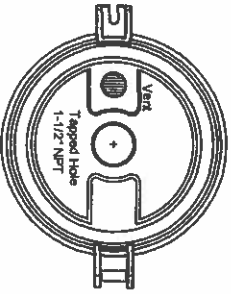

Bottom View

3 weight system
*Install Camera Junction Box AFTER the pole is erected and the lower contact assembly is lowered. ALL 3 (Three) weights **MUST BE INSTALLED** prior to latching system

Current Model Camera JB (2013—2014)

Top Section is slightly larger than the Older Model and requires Slightly Larger Diameter (Outside and Interior) Weights.

Current CJB Weights (2013-Present)

Inside Diameter = 6 1/8

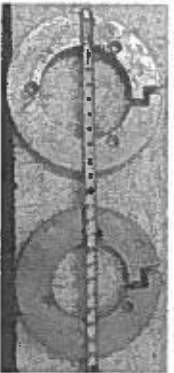

Older Model CJB Weights (2004—2012)

*Included with 4 (four) stabilizing weights

Top View

Stabilizing Weights Galvanized Cast Iron

9.8

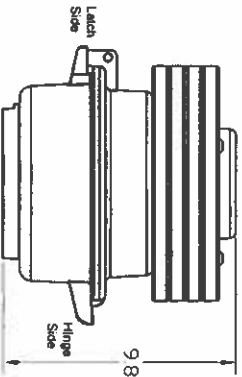

10.0

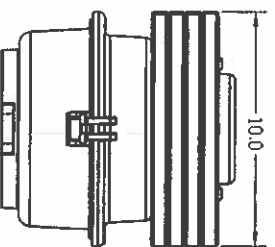

Two Piece Aluminum Junction Box

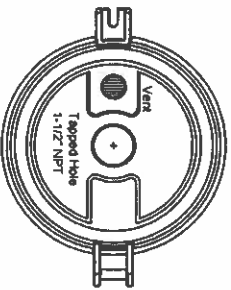

Bottom View

4 weight system
*Install Camera Junction Box AFTER the pole is erected and the lower contact assembly is lowered. ALL 4 (Four) weights **MUST BE INSTALLED** prior to latching system

Older Model Camera JB (2004—2012)

Older Model CJB Weights (2004-2012)

Inside Diameter = 5 1/8

Installation

Attachment of Camera Junction Box



***DO NOT INSTALL THE CAMERA JUNCTION BOX UNTIL THE POLE IS ERECTED AND SET.** Installing the Camera Junction Box prior to setting of pole may damage the alignment probe and void all warranties.



1. Lower Bottom Contact Unit using Pull Cord as necessary



2. Unhinge and remove Top Half of Camera Junction Box



3. Feed the wires/cables/leads from the bottom contact unit through the Top-Section of the Camera Junction Box

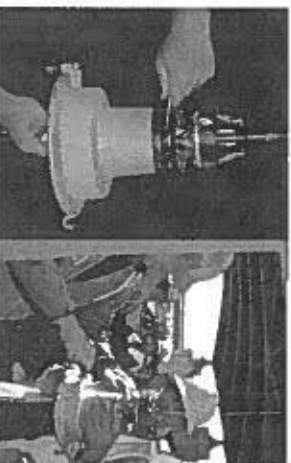

4. Using 7/16" wrench and a 7/16" Nut Driver (or 7/16" socket with extension), attach the Top-Section of the Camera Junction Box to the Bottom Contact with the included bolts/nuts/washers. (Recommended torque for 1/4" bolts is 6ft/lbs or 75 in/lbs)

**Tip: It is recommended to coat the stainless steel bolts with anti-seize lubricant prior to installing nuts*



5. Re-attach the bottom side of the hinged camera junction box to the top portion and tighten the bolt/latch using a 1/2" nut driver (or 1/2" wrench or socket)



6. Carefully guide the balancing weights (that were provided with each camera junction box) over the connector block then onto the top section of the camera junction box. The nipples on each of the weights should face upward and rotate each weight to match the indentions on the bottom of each weight



7. All included weights **MUST BE INSTALLED** prior to raising the CLD into the Latched/Locked Position. Failure to install the balancing weights will result in insufficient weight required to unlatch the CLD and your system will not operate properly

ALL INCLUDED WEIGHTS MUST BE INSTALLED PRIOR TO LATCHING SYSTEM.
Current Systems include 3 (Three) weights per Camera Junction Box.
Systems prior to 2014 include 4 (four) weights per Camera Junction Box.

*** DO NOT BEGIN INSTALLATION UNTIL A FACTORY REPRESENTATIVE HAS CONDUCTED ON-SITE TRAINING**
If Specifications require On-site Training, any installation of Lowering Device Equipment prior to on-site training by a factory rep. may void certification. This does not include mating of poles with multiple sections



ITS [mg]²
20090115 PRC
16 5 SQUARE

Operation

INSTRUCTIONS FOR LOWERING & RAISING THE UNIT

Attention **MUST** be paid throughout the raising and lowering process to prevent bunching of wire rope on the winch. The winch should be oiled prior to **EACH** use according to the recommendations in the winch manual. A heavy-duty gear oil is acceptable. **NEVER OIL WINCH WITH WD-40, BRAKE FLUID, or HYDRAULIC FLUID/OIL.**

To Lower: Mount and secure the lowering tool to the pole. Feed the cable from the winch up to the pole cable coming down the pole. While the pole cable remains attached to the eye bolt (parking stand) attach the winch cable to the pole cable eyelet using the provided quick-link connector.

THE POLE CABLE MUST ALWAYS REMAIN ATTACHED EITHER TO THE EYE BOLT (PARKING STAND) IN THE POLE OR THE WINCH CABLE. DO NOT ALLOW THE LOWERING CABLE TO HANG UNATTACHED INSIDE THE POLE.

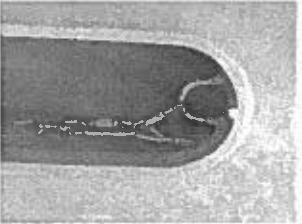

Secure Winch Cable to Lowering Cable, while leaving the lowering cable attached to the parking stand
***Be sure to fully engage all threads on the screw link (quick link).**

Once the Winch Cable is secure, remove the lowering cable from parking stand



The quick-link must be completed screwed shut before any pressure is applied. There should be no tension in the pole cable at this time. Once the winch cable is secured to the pole cable, remove the pole cable from the parking stand quick-link.

Assemble handle on winch. The handle is turned in the direction of "lift" to unlock the contact suspension unit. The operator should feel resistance in the hand crank as the movable portion of the disconnect unit travels upwards to the top of the locking maze as it prepares to disengage. Then, turning the handle in the opposite direction (pushing through the winch break) lowers the movable part of the suspension unit straight down. ***BE SURE TO GUIDE THE QUICK-LINK, LOWERING CABLE, AND HARDWARE (CRIMPS) PAST THE LIP AND INTO THE CONDUIT.**

The latching and unlatching of the CLD is similar to a ball-point pen. In order to lower the unit, you will turn the winch handle in the direction of "lift" in order to unseat the contact from its "locked stage" as seen in the diagram to the left. You should feel some resistance and the contact travels upwards a few inches to become "unlocked" as it disengages.

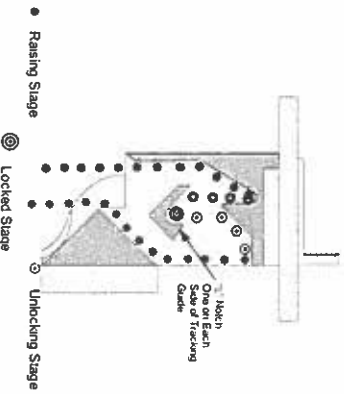

Once the unit is "unlocked" or disengaged, turn the winch handle the opposite direction to begin to lower the Camera. There may be slight resistance as you push back through the breaking mechanism on the winch.

***If you are unsuccessful in your first attempt to unlock/disengage the unit, repeat the process and slightly increase your tension when turning the handle in the "lift" direction.**

• DO NOT BEGIN INSTALLATION UNTIL A FACTORY REPRESENTATIVE HAS CONDUCTED ON-SITE TRAINING

If Specifications require On-site Training, any installation of Lowering Device Equipment prior to on-site training by a factory rep. may void certification. This does not include the mating of poles with multiple sections.



FOR YOUR SAFETY, NEVER STAND DIRECTLY BELOW THE UNIT WHEN RAISING OR LOWERING



Operation

INSTRUCTIONS FOR LOWERING & RAISING THE UNIT CONTINUED

If utilizing a factory provided electric drill motor and clutch assembly, first lower the camera/fixture 2-3 feet manually before attaching and operating the variable speed drill. You should operate your drill at the low setting.



**NEVER ENGAGE OR DISENGAGE THE LOWERING UNIT WITH THE DRILL MOTOR
ALWAYS ENGAGE OR DISENGAGE THE LOWERING UNIT USING THE MANUAL
HANDLE**

Lower the Camera to your desired height for maintenance. It is recommended not to lower the bottom contact below the top lip of the Hand Hole. Doing so will cause the hardware on the lowering cable to come into contact with the cable stop on the back of the CLD arm located at the top of the pole. This will cause slack on the cable and may result in the hardware wedging into the cable stop, making it difficult to release. If you lower your camera to this point, turn the winch handle in the "lift" direction until slack is removed and tension is back on the lowering cable.

To Raise: Simply raise camera/fixture by cranking the winch. If using the electric drill assembly, raise to about 2-3 feet from the top and operate the remaining distance manually. Always disengage and re-engage the device by use of the manual handle.

When winding up – use caution the last 1 foot as guide pins are aligning. If plunger fails to enter, re-lower 1 foot and retry. If difficulty persists lower to ground and check the lines of balance.

When the movable parts are hard home (indicated by the obvious resistance while attempting to crank the winch) release tension by cranking in the opposite direction and crank down one or two turns of handle to lock in the suspension arms. Slack will be visually confirmed in the cable indicating the device is properly latched at the top.

Once latched, reconnect the pole cable to the quick link on the eye bolt (parking stand). Always keep the pole cable affixed to the winch cable until the pole cable is clearly affixed to the parking stand.

THE POLE CABLE MUST ALWAYS REMAIN ATTACHED EITHER TO THE EYE BOLT (PARKING STAND) IN THE POLE OR THE WINCH CABLE. DO NOT ALLOW THE LOWERING CABLE TO HANG UNATTACHED INSIDE THE POLE.

ALWAYS CHECK THAT THE LOWERING CABLE IS SLACK BEFORE YOU LEAVE IT; you then KNOW that the fitting is suspended by the unit and is not hanging on the cable.

Unfasten the winch from the pole and place hand hole cover back on pole.



**• DO NOT BEGIN INSTALLATION
UNTIL A FACTORY REPRESENTATIVE
HAS CONDUCTED ON-SITE TRAINING**

*If Specifications require On-site Training,
any installation of Lowering Device Equipment
prior to on-site training by a factory rep. may
void certification. This does not include the
mating of poles with multiple sections.*



**FOR YOUR SAFETY, NEVER STAND DIRECTLY
BELOW THE UNIT WHEN RAISING OR LOWERING**



THE 5 OPERATING STAGES OF THE DISCONNECT UNIT

When lowering or raising an ITS device, there are 5 basic steps, or stages that the Disconnect Unit goes through.

The principal part responsible for moving the support arms through the 5 stages is the **TRACKING GUIDE**. This guide is a precision cast series of angular surfaces strategically located to push the support arms in the required direction toward the center "L" notch. The two "L" notches support the entire load of the camera and components when the support arms are in the **LOCKED** stage. The drawing at right shows the path the support arms take through the tracking guide. Each Symbol represents one of the 5 stages.

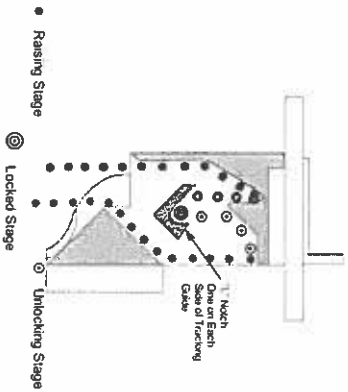

Ⓞ Locked Stage

STAGE 1

The first and most important stage is **LOCKED**. Generally, all aspects of the operation of the Disconnect Unit will begin and end in the locked stage. In the locked position, the twin support arms hold all the weight of the surveillance camera. There is no tension on the operating cable, no locking of gears, and no pressure on braking devices to hold the camera secure in its operating position. The electrical and signal contacts are fully engaged and fully insulated and all camera functions are operational when the Disconnect Unit is **LOCKED**.

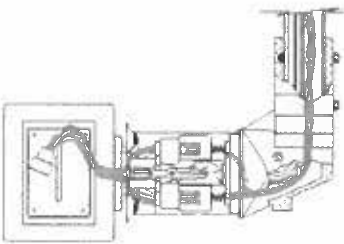

Ⓞ Unlocking Stage

STAGE 2

The second stage is **UNLOCKING**. Before lowering the camera, the Disconnect Unit must first be raised approximately 3/4 inch. During the slight raising operation, the support arms will be pushed to one side by the tracking guide to clear the support notches. Springs inside the socket half of the connector compress as the Disconnect Unit is raised. Electrical and signal contacts are still engaged during this stage. Each Disconnect Unit has a built-in positive stop that, when reached, will alert the operator to begin lowering the camera. Every time the Disconnect Unit is raised from the "locked" position, the support arms will move and unlock the Disconnect Unit.

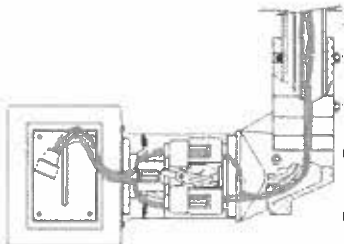

• DO NOT BEGIN INSTALLATION UNTIL A FACTORY REPRESENTATIVE HAS CONDUCTED ON-SITE TRAINING

If Specifications require On-site Training, any Installation of Lowering Device Equipment prior to on-site training by a factory rep. may void certification. This does not include the mating of poles with multiple sections.



FOR YOUR SAFETY, NEVER STAND DIRECTLY BELOW THE UNIT WHEN RAISING OR LOWERING



THE 5 OPERATING STAGES OF THE DISCONNECT UNIT

Continued



* Lowering Stage

STAGE 3

With the Disconnect Unit unlocked, LOWERING is the next stage. As the camera is lowered, the bottom portion of the Disconnect Unit begins to separate from the tracking guide and the top portion of the Disconnect Unit. Next, the electrical and signal connector disconnects followed by the coming apart of all stabilizing guides. All the weight of the camera and equipment now hangs from the control cable. There are no live electrical contacts to contend with as the camera is lowered to the desired height above the ground for maintenance. Cleaning and repair work can be accomplished at ground level.

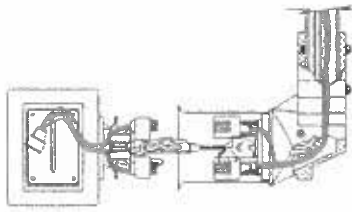

● Raising Stage

STAGE 4

After maintenance to the camera, RAISING is the fourth of the operating stages. During this part, the camera and moveable portion of the Disconnect Unit are raised to the top. As the camera slowly approaches the upper portion of the Disconnect Unit, the control cable initially pre-positions the main guide post in the center hole of the tracking guide. With continued raising, the guide post centers itself in the tracking guide and rotates into its original orientation as the guide post's cast-in-place key follows the inclined helical surface of the tracking guide. Sustained raising of the camera will engage the next stabilizing key and guide slot of the Disconnect Unit as the support arms toggle through the tracking guide. Electrical and signal pins and sockets of the connector engage as the last step before the lower portion of the Disconnect Unit reaches the very top. Proceed to the final stage: LOCKING.

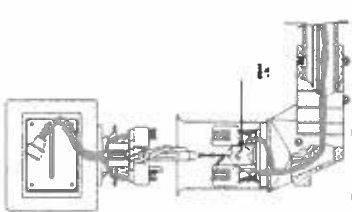

◎ Unlocking Stage

STAGE 5

The final phase of the 5 operating stages is LOCKING. During this stage, the camera must be lowered approximately 3/4 inch so that the support arms of the lower portion of the Disconnect Unit move toward the center "L" notches of the tracking guide. Springs within the socket half of the connector that were compressed during the final part of the raising stage are now extending and exerting force on the pin half of the connector to assure complete isolation and insulation of the contacts. After the slight lowering operation, the dual support arms are secured in the "L" notches. The Disconnect Unit is now the LOCKED stage. The operating stages 1 through 5 may now be repeated over and over again with the camera returning to its original operating position each time. The operating stages of the Disconnect Unit always begin and end with the Disconnect Unit in the LOCKED position.

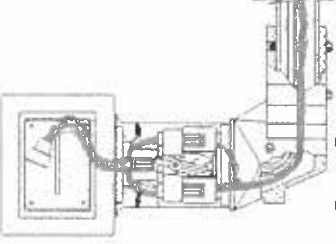

• DO NOT BEGIN INSTALLATION UNTIL A FACTORY REPRESENTATIVE HAS CONDUCTED ON-SITE TRAINING

If Specifications require On-site Training, any Installation of Lowering Device Equipment prior to on-site training by a factory rep. may void certification. This does not include the mating of poles with multiple sections.



FOR YOUR SAFETY, NEVER STAND DIRECTLY BELOW THE UNIT WHEN RAISING OR LOWERING



Routine Maintenance and Inspections

Checking SS Cable Length & Adjustment

Typically when the instructions are followed and the Lowering Cable is installed properly, there should be little more than routine checks of the stainless steel (SS) lowering cable during maintenance. However due to factors such as: *stretching, settling (multiple section poles only), and unfortunately improper installation; an adjustment of the lowering cable may be necessary.

This photo shows a lowering cable that is too long. The hardware is getting caught in the pulley of the winch, thus not allowing the CLD to engage or disengage. Cranking this hardware into the pulley can damage the crimps and cable, causing cable to break.

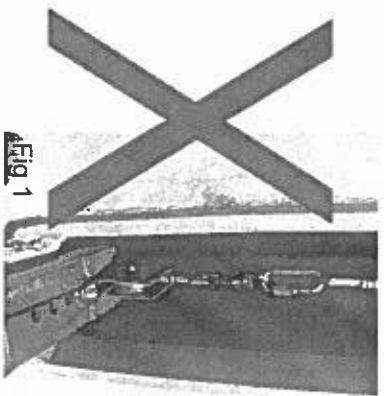

Fig 1

Never allow the winch hardware to be cranked into the winch pulley (Fig 1). Doing so will create a hazardous situation that may cause damage to the cable and/or crimps and ultimately breaking the cable (Fig 2).

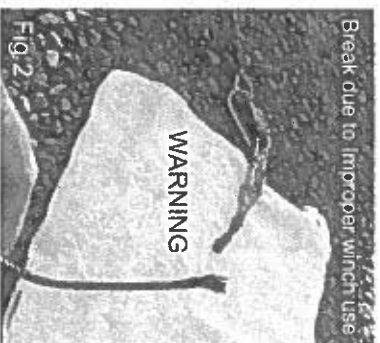

Fig 2

• DO NOT BEGIN INSTALLATION UNTIL A FACTORY REPRESENTATIVE HAS CONDUCTED ON-SITE TRAINING

If Specifications require On-site Training, any installation of Lowering Device Equipment prior to on-site training by a factory rep. may void certification. This does not include the mating of poles with multiple sections.

***Stainless Steel Lowering Cable is subject to stretching over time and use. This is a normal and natural occurrence. Therefore, over time it may be necessary to shorten the length of the Lowering Cable during routine maintenance.**

Important Notes on the Lowering Cable (SS Cable)

The length of the Lowering Cable is crucial to the proper and safe functioning of the CLD. If the Cable is too long, then the hardware on the portable winch will get caught in the pulley on the winch frame, not allowing the CLD to latch or unlatch. If the Cable is too short, then it will be difficult to attach the Lowering Cable to an available parking stand locator/ on/or inside the hand hole.

By attaching the Lowering Cable (SS Cable) to a parking stand during installation, pulling out all slack, and assembling the cable clamp as close to the ball housing as possible - this will typically give you the desired length of cable to properly latch (engage) and unlatch (disengage) the device.

However, the proper length can not be confirmed until after the pole is erected, the camera-junction box attached and the unit operated. Final adjustments can easily be made at ground level. Consult the factory if assistance is needed.

Ground Adjustment of SS Lowering Cable

Attach the winch to the pole and attach the winch cable to the lowering cable

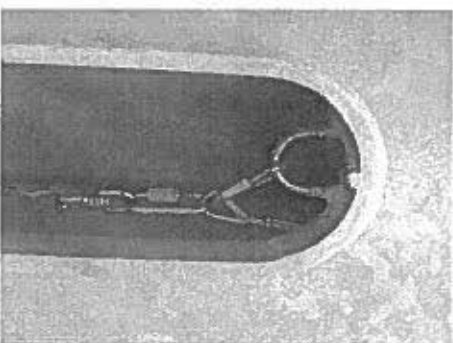

If the cable needs to be shortened, measure the amount that it needs to be shortened and then lower the camera. Remove the Camera and the camera junction box as necessary. Then shorten the lowering cable by adjusting the cable in the cable clamp and special knot that is at the bottom of the cable clamp. Cut off the excess cable and replace the cable clamp back in to the slot under the lowering device probe. Reconnect the camera junction box and the camera and raise the unit back to the latch position. Be sure to leave enough cable in order to attach the quick-link (screw-link) to the parking stand when the Lowering Device is raised and locked.

Refer to Pages 13-14 of this manual for details on the cable-clamp assembly

Routine Maintenance and Inspections

LOWERING DEVICE MAINTENANCE
Perform During Each Lowering cycle / Or at least once every six months

Check that all screws, nuts and fasteners are tight. Check that the nuts used to fasten the camera junction box to the disconnect unit are tight.

Check wiring to fixture or camera for signs of wear or unsoundness.

The plunger of the contact unit **MUST** be kept clean and well greased and should be inspected and greased with petroleum jelly as needed.

The locking cams should be checked to ensure the setscrew spindles are tight. If necessary apply a small amount of good quality lubricating oil at the spindle.

Oil and Grease winch as per manufacturer's instructions in the winch manual. *Perform all required winch inspections & maintenance as per the winch manual prior to each operation.

Inspect Contacts. Contacts should be cleaned **ONLY** if needed with LPS No-Flash Electro Contact Cleaner (Trico Industries - non-flammable, non-conductive). After cleaning, contacts should be lubricated with a good quality electrical grade lubricant, such as CRC-2-26 Precision Lubricant.

On applicable projects where an electric hoist motor and clutch adapter are utilized:

- The **ACTUAL** locking and unlocking of the devices **MUST** be completed while the lowering winch is in the **MANUAL** mode.
- Once the device is unlocked, the **MANUAL** winch arm may be removed and the clutch adapter with hoist motor attached for the majority of the lowering and raising.
- When raising the device, cease the use of the electric hoist at least 2-3 feet before the bottom half reaches the top half of the lowering assembly. Then, reattach the manual hand crank and manually lock the device in place.

Maintenance of Male Connector Contact Block

- (1) Can of Electrical Contact Cleaner (Citrus Base)
- (1) Can of Silicone Spray Lubricant (Non-Conductive like duty)
- (1) Extension tube for spray can

Non-Conductive Spray: Non-Conductive spray is recommended since the lubrication spray can come in contact with the entire unit. Non-conductive spray will not make the pins not conduct. It just means that the silicone is simply "non-conductive" and therefore safe to apply.

Cleaning procedure for Male contacts in multi-pin connectors

To clean male contacts ranging in diameter from .187 (3/16") through .625 (5/8"), follow the steps below:

- Disconnect/shut down power to connector(s) to be cleaned.
- Verify that power has been disconnected with a voltmeter before proceeding.
- Using an OSHA compliant reduced-flow air gun and eye protection, blow any loose material from the contact surface.
- Using Electrical contact cleaner (Citrus Base) with guide tube installed, spray the cleaner onto the contact to be cleaned. Allow to soak for 2-3 minutes.
- If contact is mildly dirty, rub with a rag to clean and remove cleaning fluid.
- If contact has evidence of corrosion, or if rag cleaning does not satisfactorily remove dirt, rub contact with a strip of emery cloth (fine grit). For convenience and ease of use, a 3/8" to 1/2" wide strip of emery cloth should work well for all Duraline multi-pin connectors (emery cloth can easily be torn by hand into even strips.) Be careful not to remove too much material during this process. Remove only enough to restore the bright yellow finish of the brass contact. Do not use emery cloth on sealing portion of the rubber-molded area.
- Wipe any loose material from the connector.
- Use the reduced-flow air gun and wear eye protection to blow away the remaining material on the connector.
- Spray the rubber sealing area between the face surface of the connector and the contact with non-conductive silicon spray-on lubricant to lubricate and protect.
- Return connector to service.



**• DO NOT BEGIN INSTALLATION
UNTIL A FACTORY REPRESENTATIVE
HAS CONDUCTED ON-SITE TRAINING**

*If Specifications require On-site Training,
any installation of Lowering Device Equipment
prior to on-site training by a factory rep. may
void certification. This does not include the
mating of poles with multiple sections.*

GUIDE FOR MAINTAINING INDIVIDUAL LOWERING DEVICES

DO NOT OPERATE A LOWERING DEVICE UNLESS YOU HAVE BEEN PROPERLY TRAINED AND HAVE READ ALL INSTRUCTION MANUALS

Internal Systems: (Systems where the lowering cable is inside the pole and a portable lowering winch is used to operate the system)

This maintenance guide should be followed each time a camera is lowered or a minimum of every 6 months.

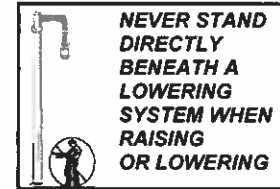

1. Inspect the lowering winch.

Inspect the lowering cable for evidence of any burr or kink in the cable. Damaged lowering cable must be replaced. Ensure cable is wound tight and snug on the spool. Ensure there is no cable coming off the winch spool or wrapped around the gears or winch spindle.

2. The Winch must be properly oiled.

Refer to the Winch Manual on page 10 section 3.2 for instructions on Cleaning and Lubricating the Winch. See also the last page of this guide for quick reference.
Never Use WD-40 or other drying compounds.

3. Inspect the Lowering cable length inside the pole.

Ensure the lowering cable in the pole is attached to the parking stand on the pole. The lowering cable eyelet should not hang more than 3 inches below the parking stand. Over time the lowering cable may stretch and need adjusting.

NOTE: If the lowering cable is too long it will allow the hardware to make contact with the lowering winch pulley when attempting to disconnect the camera. If this is permitted to occur, it is possible to break the hardware or winch cable resulting in camera damage/destruction and potential serious bodily injury or **DEATH**.

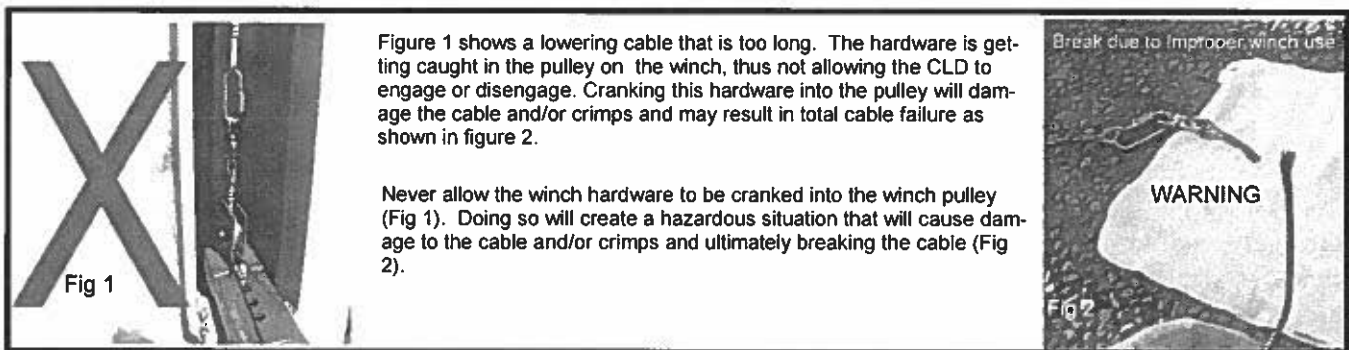

Figure 1 shows a lowering cable that is too long. The hardware is getting caught in the pulley on the winch, thus not allowing the CLD to engage or disengage. Cranking this hardware into the pulley will damage the cable and/or crimps and may result in total cable failure as shown in figure 2.

Never allow the winch hardware to be cranked into the winch pulley (Fig 1). Doing so will create a hazardous situation that will cause damage to the cable and/or crimps and ultimately breaking the cable (Fig 2).

4. If the cable is too long per # 3 above - the cable must be shortened:

Measure the amount that it needs to be shortened and then lower the camera. If you are unable to safely support the camera while in the lowered position to affect removing the tension off the cable clamp, remove the Camera and the camera junction box. Then, shorten the lowering cable as necessary by adjusting the cable in the cable clamp located at the base of the center guide probe. Cut off the excess cable, properly remake the safety knot and replace the cable clamp back into the slot under the center guide probe. If needed, reconnect the camera junction box and the camera then raise the unit back to the latched position.

5. Confirm the seals of the camera junction box.

Once the camera is lowered, inspect the top of the camera junction box to make sure that the bolts on the top are tight and that a silicone seal is maintained around the gasket on the top of the camera junction box.

6. Inspect male pins and probes.

Make sure that the male electrical pins and the male probe are free from any debris that might prevent or hinder their connections into the female sockets at the top of the pole.

7. Contact the Manufacturer for any questions.

If the operator of the system is unsure of something before installing, operating, adjusting, or maintaining the system, Contact MG Squared immediately at (205) 823-6688.

GUIDE FOR MAINTAINING INDIVIDUAL LOWERING DEVICES

DO NOT OPERATE A LOWERING DEVICE UNLESS YOU HAVE BEEN PROPERLY TRAINED AND HAVE READ ALL INSTRUCTION MANUALS

External Systems: (Systems where the lowering cable is not in the pole but in conduit on the surface of a structure).

This maintenance guide should be followed each time a camera is lowered or a minimum of every 6 months.

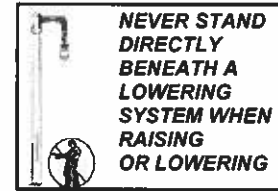

1. Inspect the lowering winch.

Inspect the lowering cable for evidence of any burr or kink in the cable. Damaged lowering cable must be replaced. Ensure cable is wound tight and snug on the spool. Ensure there is no cable coming off the winch spool or wrapped around the gears or winch spindle.

2. The Winch must be properly oiled.

Refer to the Winch Manual on page 10 section 3.2 for instructions on Cleaning and Lubricating the Winch. See also the last page of this guide for quick reference. **Never Use WD-40 or other drying compounds.**

3. Inspect Winch Spool for Excess Cable.

If there appears to be a large amount of excess cable left on the winch spool when the camera is lowered to its lowest position, then remove the excess cable from the spool by shortening the lowering cable. There need not be more than 10 extra feet of cable on the spool when the camera is in its lowest position.

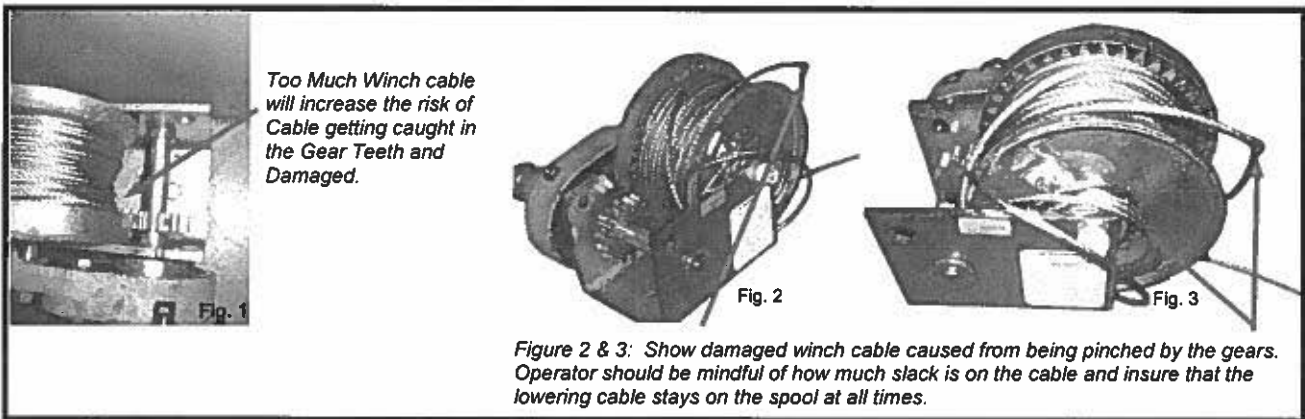

4. If the cable is too long per # 3 above - the cable must be shortened:

Lower the camera. If you are unable to safely support the camera while in the lowered position to affect removing the tension off the cable, remove the Camera and the camera junction box. Remove the Lowering Cable from the Winch. Cut excess cable **being sure to leave at least 10 extra feet of cable on the spool when the camera is in its lowest position.** If needed, reconnect the camera junction box and the camera then raise the unit back to the latched position.

5. Confirm the seals of the camera junction box.

Once the camera is lowered, inspect the top of the camera junction box to make sure that the bolts on the top are tight and that a silicone seal is maintained around the gasket on the top of the camera junction box.

6. Inspect male pins and probes.

Make sure that the male electrical pins and the male probe are free from any debris that might prevent or hinder their connections into the female sockets at the top of the pole.

7. Contact the Manufacturer for any questions.

If the operator of the system is unsure of something before installing, operating, adjusting, or maintaining the system, Contact MG Squared immediately at (205) 823-6688.

Important!

Increase the frequency of maintenance procedures if the winch is:

- Operated for long periods.
- Used to pull heavy loads.
- Operated in wet, dirty, hot, or cold surroundings.

3.1 Cleaning the Winch

Clean the winch to remove dirt and help prevent rust and corrosion.

- 3.1.1 CLEAN THE WINCH every six months or whenever it is dirty.
- a WIPE ALL EQUIPMENT to remove dirt and grease.
 - b LEAVE A LIGHT FILM of oil on all surfaces to protect them against rust and corrosion.
 - c WIPE OFF excessive amounts of oil to avoid the accumulation of dirt.
- 3.1.2 REMOVE ALL UNNECESSARY OBJECTS from the area surrounding the winch.

Important!

- Make sure lubricant has a temperature rating appropriate for the ambient temperatures of the operation.

3.2 Lubricating the Winch

CAUTION

Do not over lubricate the brake bushings on models equipped with a brake. Over lubricating may cause oil to leak onto the friction discs, which may damage the friction discs or result in poor operation of the disc brake.

Lubricate the spur gears before each operation, and periodically during operation. Failure to lubricate the gears will cause damage or deformation of gear teeth.

Lubricate the winch properly to help protect it from wear and rust. Read the following instructions carefully.

- 3.2.1 CONSULT MANUFACTURER'S RECOMMENDATIONS for specific information on lubricating the wire rope and other equipment.
- 3.2.2 LUBRICATE WINCH BEARINGS AND SHAFTS at least every 6 months.
- a APPLY 2 TO 3 DROPS of SAE 30 non-detergent oil to bearings and shafts at all friction points.
 - b ROTATE THE DRUM several times to allow the oil to penetrate, and wipe off excess oil to avoid accumulation of dirt.
- 3.2.3 LUBRICATE WINCH GEARS before every operation and at least every 10 hours during operation.
- a APPLY A LIGHT FILM of open gear lubricant to the gear teeth on all gears.
 - b USE SPRAYON 201 or equivalent open gear lube. For dirty conditions use a dry lubricant such as dry graphite or Moly.
- 3.2.4 LUBRICATE THE DISC BRAKE IF APPLICABLE at least every 6 months. Place 1 or 2 drops of SAE 30 non-detergent oil into the hole in the brake housing marked "oil", and turn the brake several times to allow the oil to penetrate.
- 3.2.5 LUBRICATE THE WIRE ROPE and other equipment by following the manufacturer's recommendations.

APPENDIX D:
MG² EXTERNAL-TYPE CLD INSTALLATION GUIDE
(Guide courtesy of MG²)

External/Retrofit Lowering System Installation Guide

Version 102413A

Portable Winch with Winch Connection Box Option (WCB)

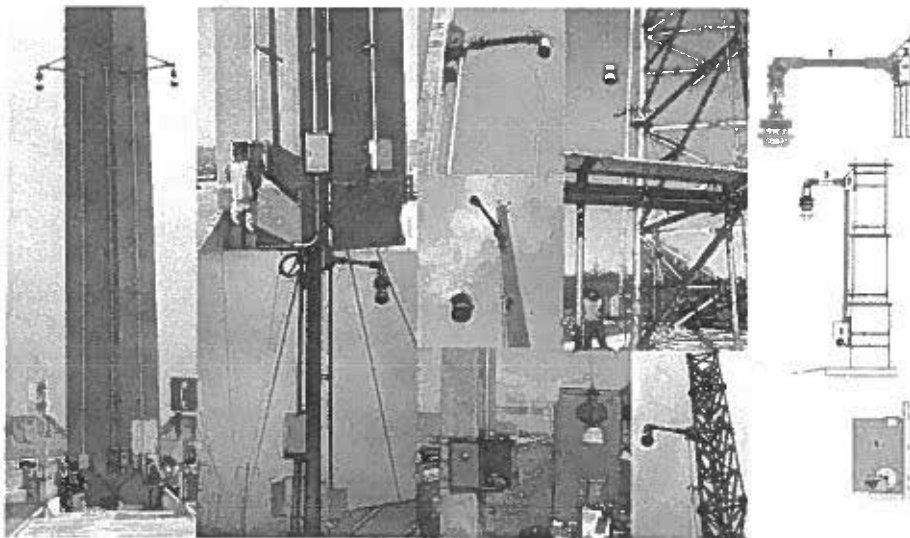

MG Squared
3301 Oak Hill Drive • Birmingham, AL • 35216
www.LoweringSystems.com
(205) 823-6688

External/Retrofit Systems

An external system provides a simple solution to add or retrofit a lowering system to existing infrastructure, such as towers, buildings, bridges, spans, and of course existing poles. The lowering device is attached to a customized upper mounting box. The upper mounting box is mounted at the desired height onto the structure via either banding straps, bolting, or welding depending on the application. One of two styles of bottom winch boxes is mounted to the lower portion of the structure to provide access to either a permanently mounted winch, or provide attachment for a portable lowering tool. The upper and bottom box are connected via contractor provided and installed conduit to provide a protected raceway for the lowering cable.

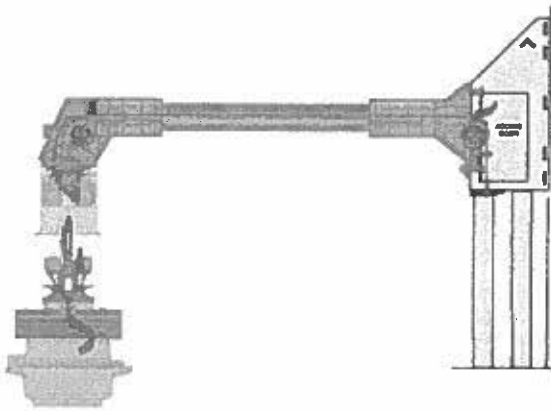

Upper Mounting Box

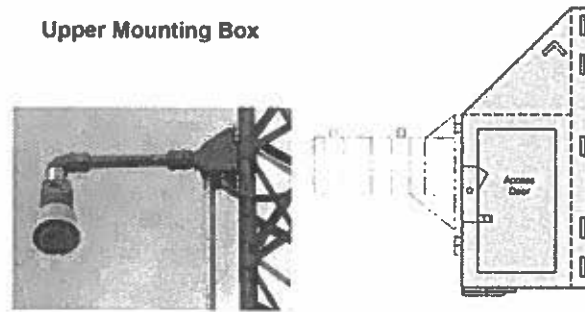

**Bottom Winch Box STD
 Permanently Mounted Winch**

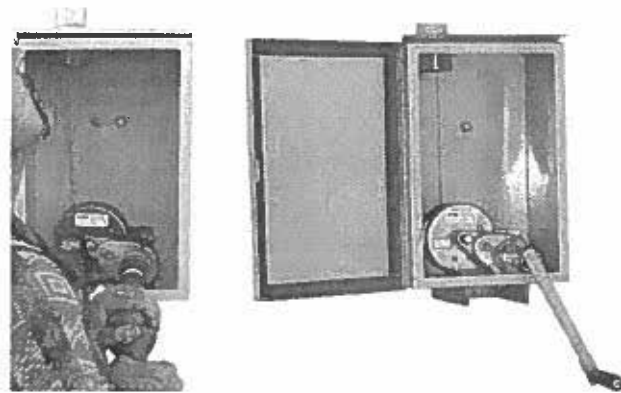

**Winch Connection Box
 for Portable Mounted Winches**

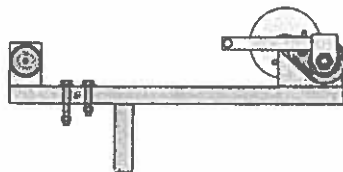

*Note: A portable winch is not provided for each winch connection box. Actual quantity to be determined per project specification

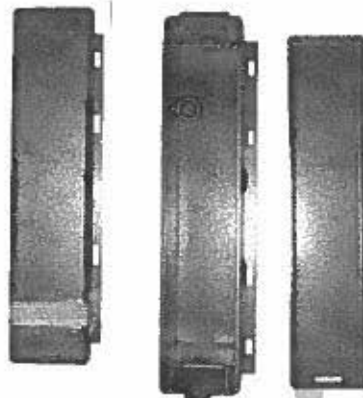

This Dimension Must Be Known Before Item Can Be Released for Production

Height: Grade to CLD Support Arm=

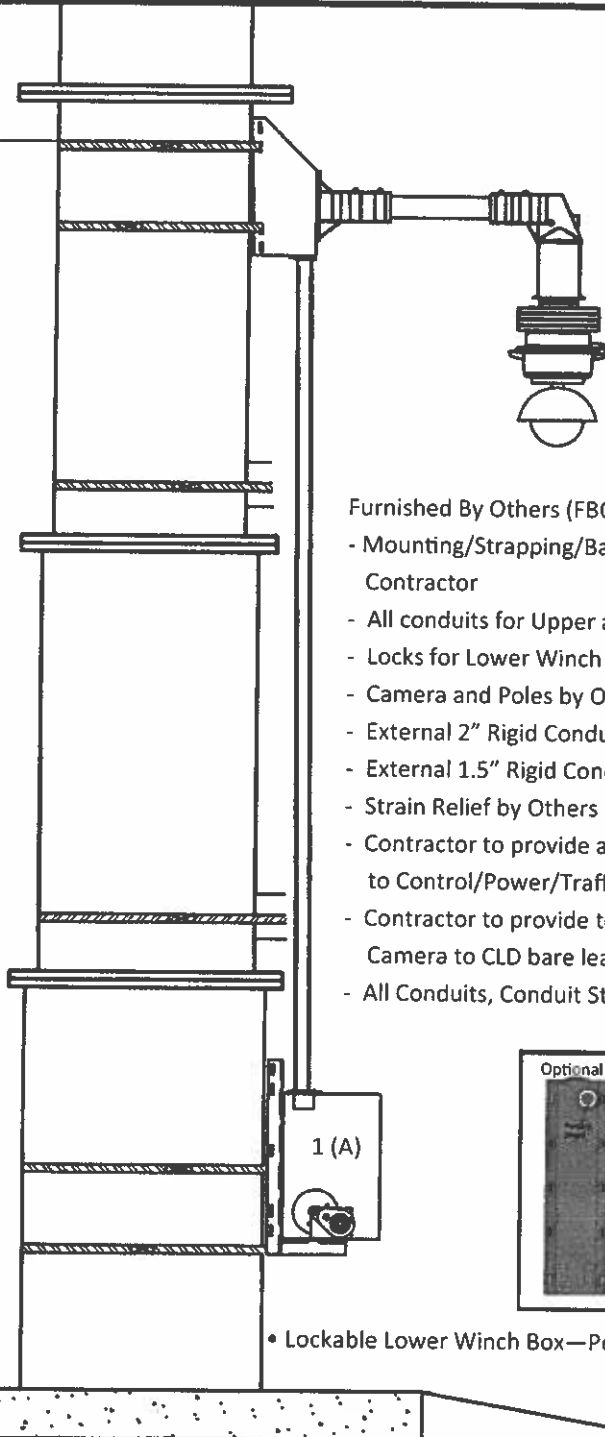

Materials to be Supplied by MG Squared:

- 1) Winch Box: (A) Permanent winch model or (B) *Winch Connection box model for portable mounted winch (see note)
- 2) Upper Mounting Box for attachment of CLD
- 3) Camera Lowering Device (CLD)

• Upper Mounting Box provides structural support of lowering device arm and suspension contact unit. Upper Mounting Box also provides secure location for terminations/connections (by others)

Furnished By Others (FBO):

- Mounting/Strapping/Banding and incidental hardware provided by Installer/Contractor
- All conduits for Upper and Lower Winch Boxes FBO
- Locks for Lower Winch Box FBO
- Camera and Poles by Others
- External 2" Rigid Conduit for Permanent Winch Box Models FBO
- External 1.5" Rigid Conduit for Portable Winch Box Models FBO
- Strain Relief by Others
- Contractor to provide appropriate power/signal cable from upper mounting box to Control/Power/Traffic Cabinet
- Contractor to provide terminate appropriate connections/leads/pigtails from Camera to CLD bare leads
- All Conduits, Conduit Stand Offs, Shims, and mounts by others

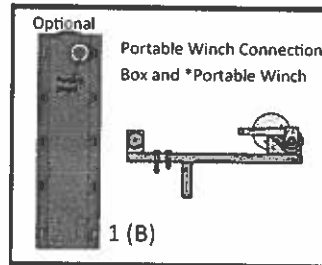

• Lockable Lower Winch Box—Permanent or Portable Model per project requirements.

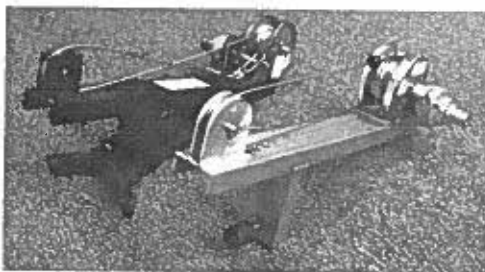

*Note: A portable winch is not provided for each winch connection box. Actual quantity to be determined per project specification

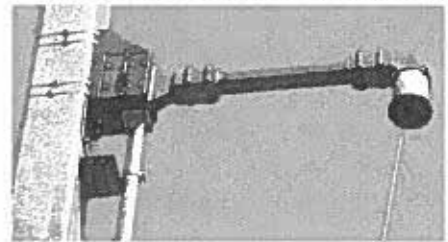
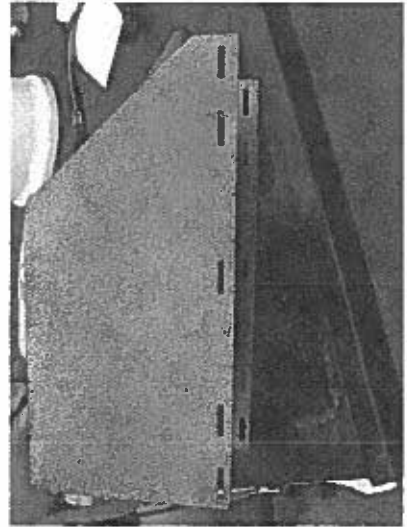
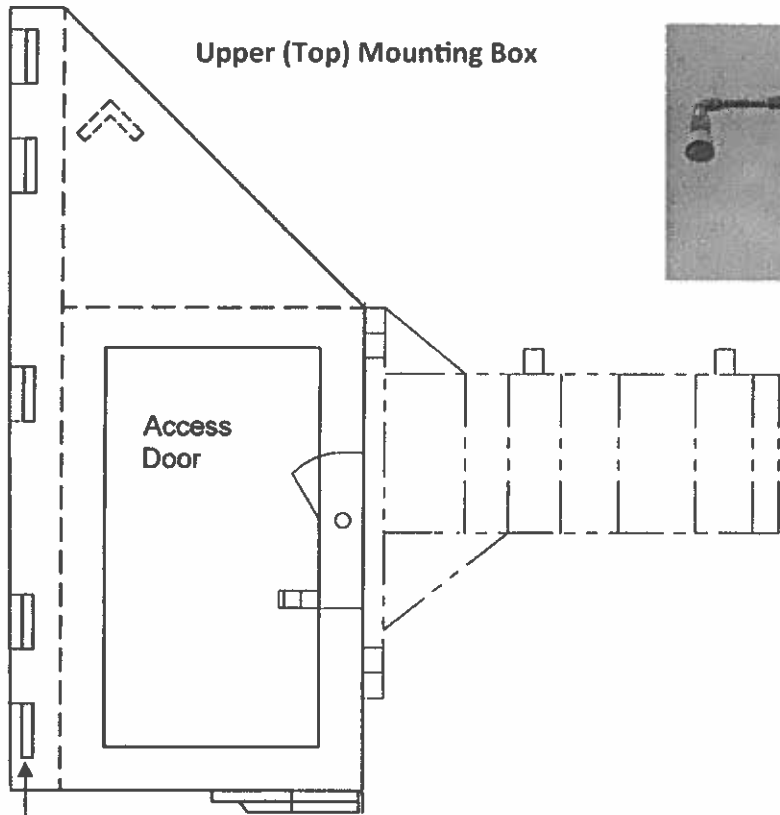

The Standard External System includes slots for easy banding (banding straps/hardware by others)

(Lower) Winch Connection Box for Portable Mounted Winches

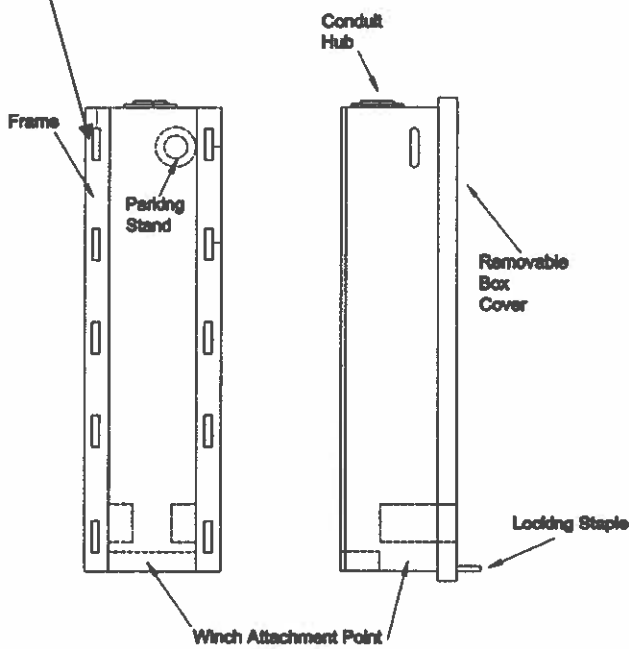

customizations and banding by others

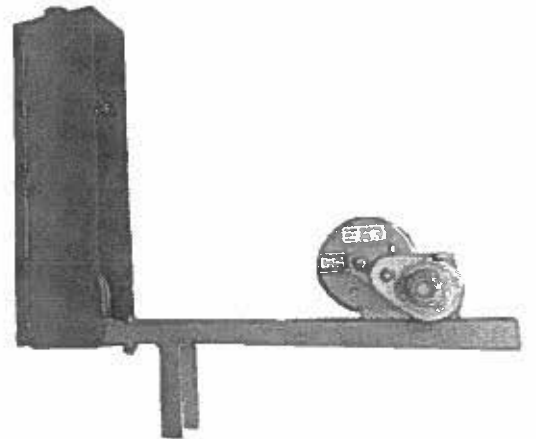
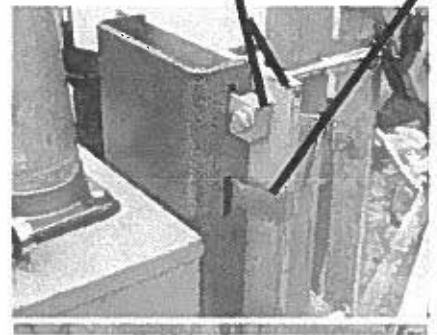

Field Photos of an Installation of External Camera Lowering System

(For reference only - read all instructions prior to this page)

Reference Sheet

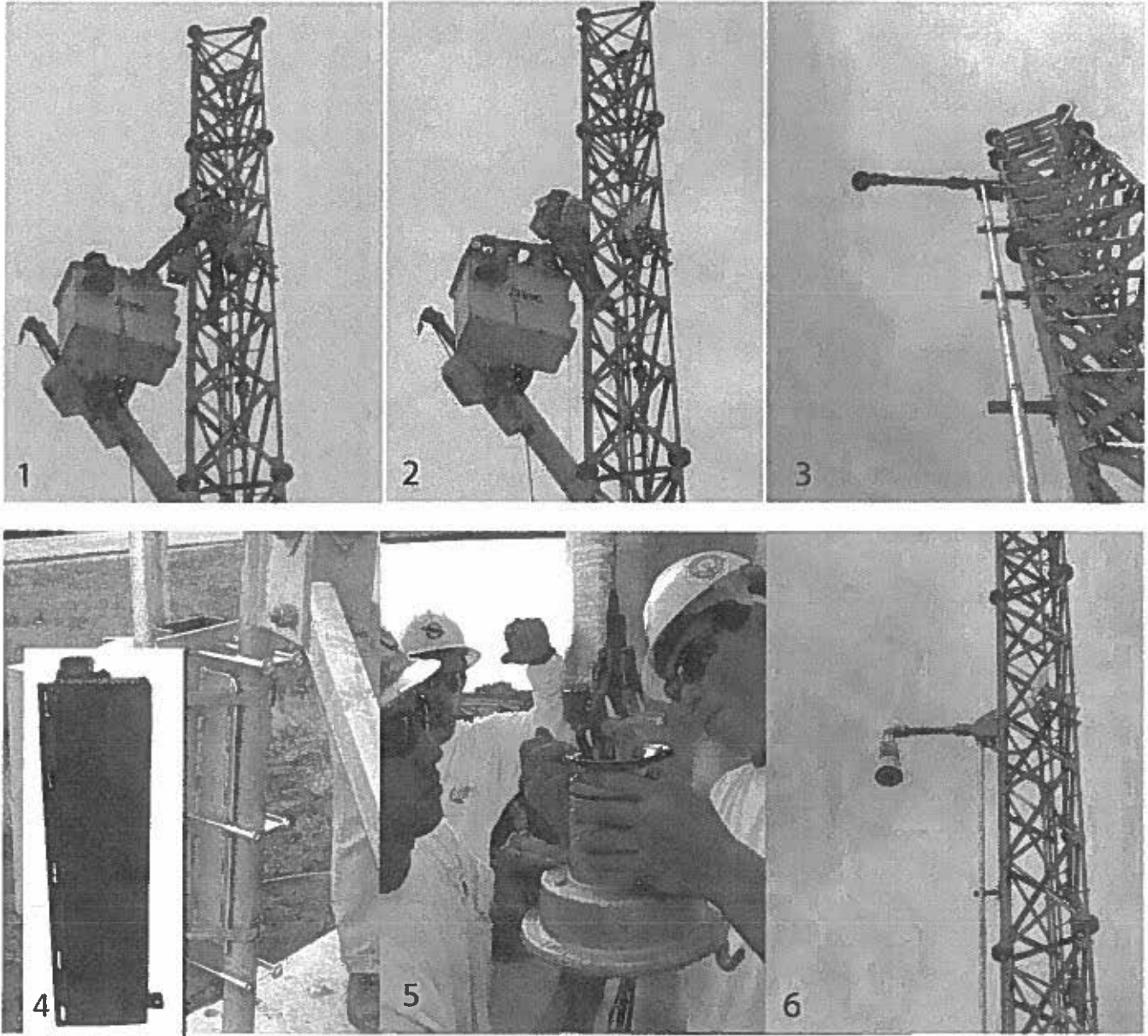

Conceptual Overview of Installation—Reference Only—Read All instructions

1. Installation of Top Mounting Box. Use Shims (FBO) to level Box as needed. After installation of Top Mounting Box most installers will install the rigid conduit and stand-offs (as see in photo #3)
2. Attachment of CLD Unit/Arm to Top Mounting Box. **The CLD arm MUST be horizontally level (plumb).**
3. Reference photo showing Top Mounting Box, Rigid Conduit, Stand-Offs for Conduit, and CLD Unit/Arm
4. Lower Winch Box Mounted/Banded (Banding, mounting hardware, and mounting customizations by others)

NOT SHOWN: Lowering Cable Installed to Parking Stand inside Winch Box and Cable Clamp Assembly (Safety Knot) installation

5. Camera Junction Box installed at ground level
6. Reference Photo showing a completed Installation

RECOMMENDED EXTERNAL MOUNT LOWERING DEVICE ASSEMBLY INSTRUCTIONS

****IF REQUIRED IN JOB SPECIFICATIONS, DO NOT BEGIN INSTALLATION**
UNTIL FACTORY REPRESENTATIVE HAS CONDUCTED ON-SITE TRAINING!**

GENERAL INSTRUCTIONS

1. Attach the Upper Mounting box to the structure. This can be done using either banding material (FBO) or bolts through the slots at the back of the box. The contractor is responsible for ensuring the connection between the boxes and the structure is adequate. The face (mounting slot) of the upper mounting box should be **vertical and plumb**. Use shims (FBO) as necessary to ensure vertical and plumb alignment.

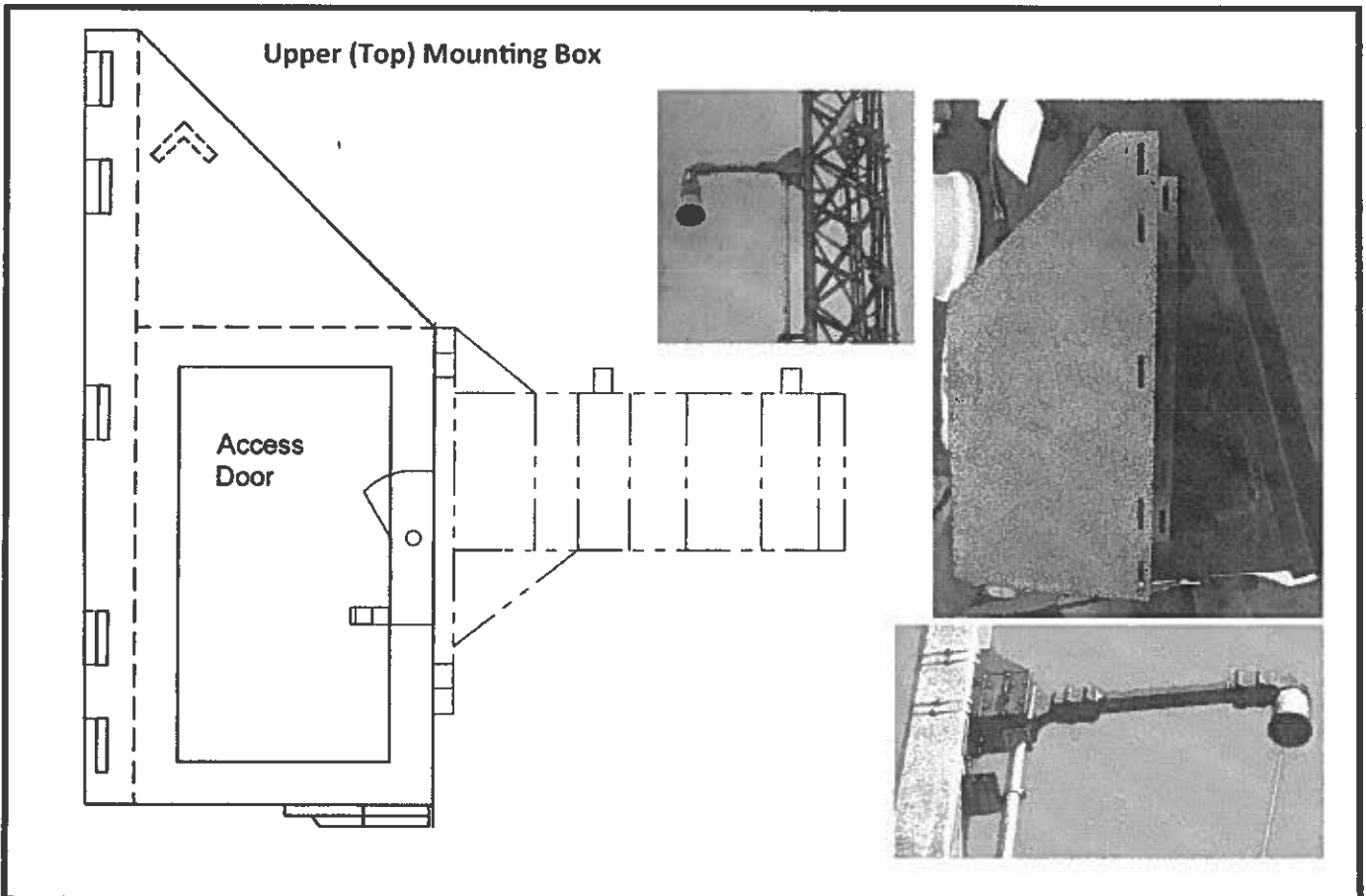
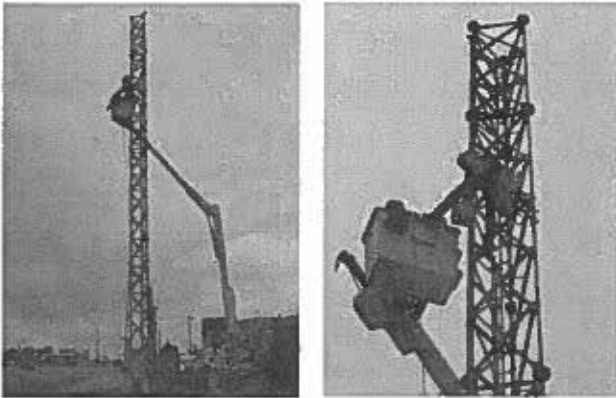

2. Secure Conduits from the Upper Mounting Box to the point where the Lower Winch Box will be mounted. *Winch Connection Lower Box Hubs are designed for 1 1/2" conduit*

3. A: **Winch Connection Lower Box:** Attach the lower winch box to the structure in the same vertical plane as the upper box. *This can be done using either banding material (FBO) or bolts through the slots at the back of the box. The contractor is responsible for ensuring the connection between the boxes and the structure is adequate.*

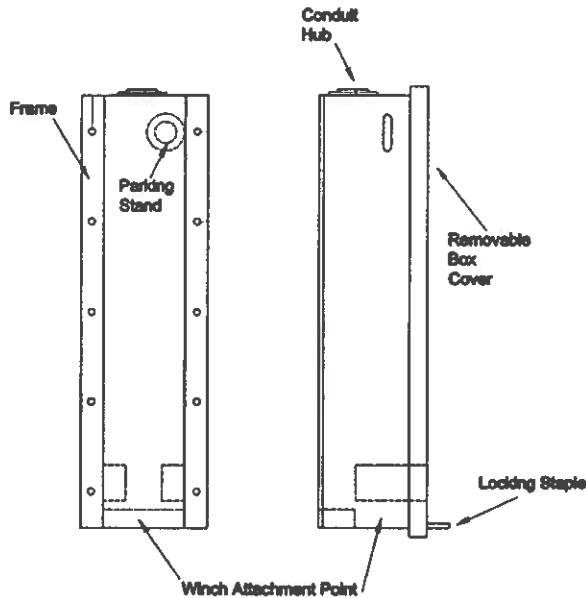

customizations and banding by others

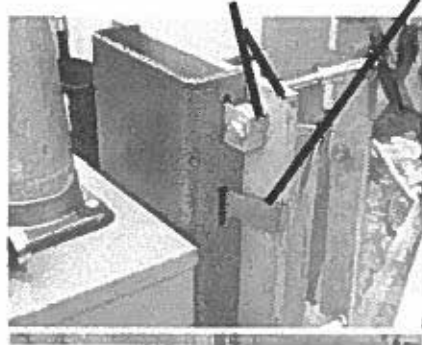

- B: **Winch Connection Lower Box** Join 1 1/2" conduit (FBO) to/from the upper mounting box to the lower winch box. This conduit must be smooth on the interior and should be in a straight line between boxes to avoid the lowering cable dragging on the sides of the conduit.

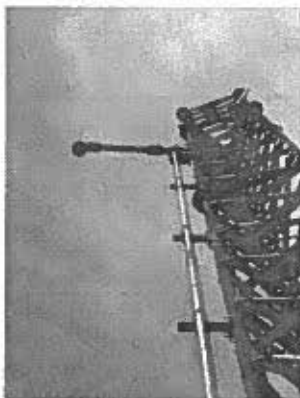
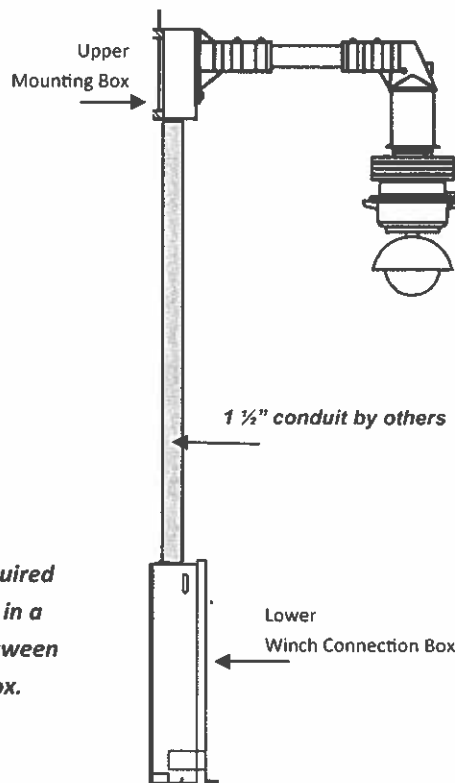
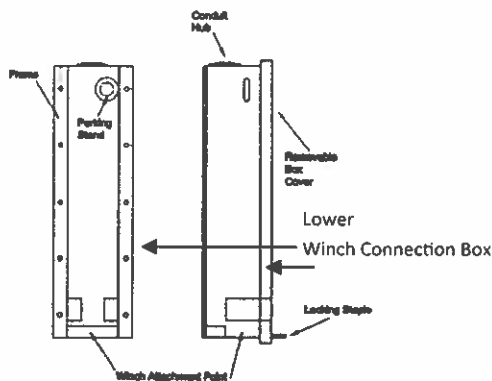

Install Stand-offs as required (FBO) and keep conduit in a straight vertical run between upper box and winch box.

- Determine the best place for the power/signal cable and/or conduit (for power/signal cable) to enter the upper mounting box and make appropriate size hole. After conduit (FBO) for power/signal cable is installed, make sure to seal around the power/signal entry point created in the upper junction box with good quality sealant.

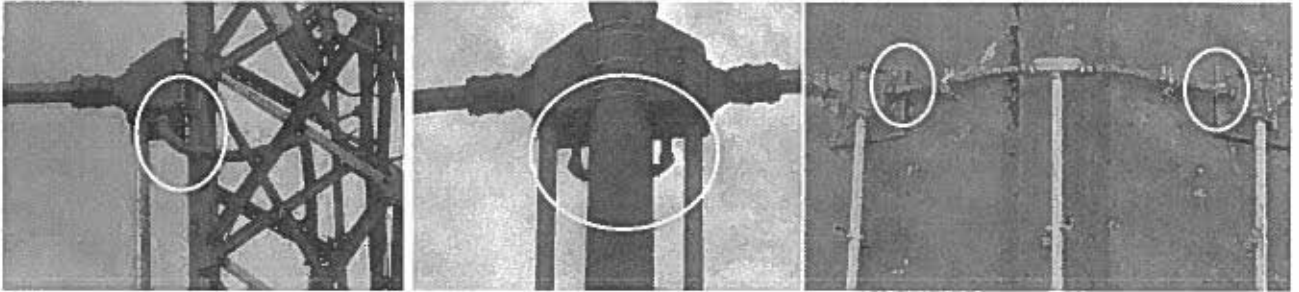

Attachment of CLD to Upper Mount Box

- First: Unroll stainless steel lowering cable avoiding any bends or kinks in the cable. Hand over hand unrolling is recommended to prevent twisting. Prior to CLD attachment, feed the stainless steel lowering cable through the rectangle slot on the upper mounting box and feed the cable down the lowering cable conduit to the lower winch box. **Do not push the cable back up into the lowering device but keep tension on the cable to ensure that the lowering cable does not come off the pulleys in the lowering device.**

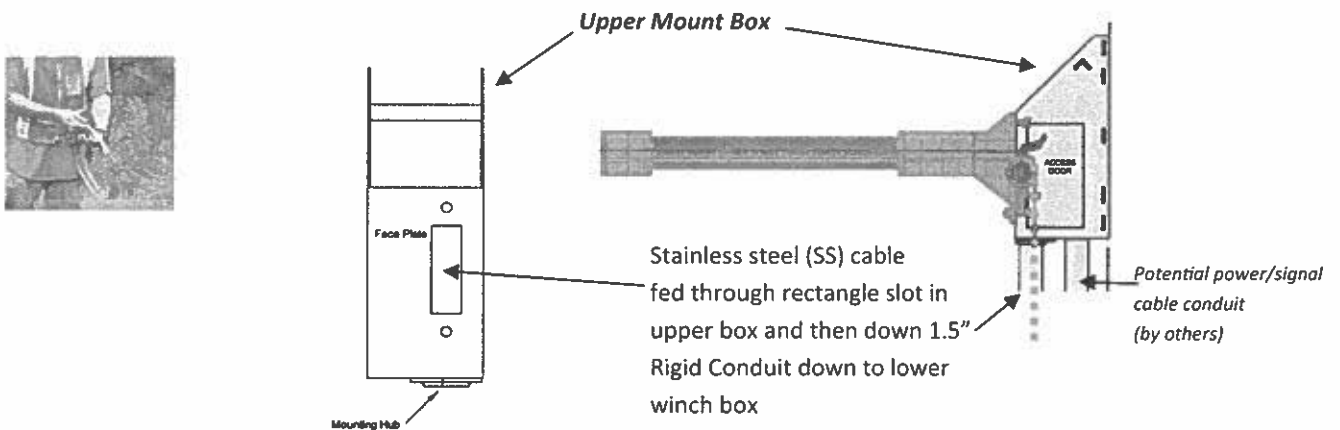

- Attach the lowering device arm assembly to the upper mounting box using the two included bolts and washers. While doing this several procedures must occur:
 - The electrical conductors at the back of the CLD are carefully guided through the rectangle slot of the upper mounting box and out the side of the upper mounting box
 - Attach the lowering device to the pole with the bolts provided. Be careful not to pinch conductors or lowering cable.

- Continue to Feed SS cable from upper mounting box, down the rigid conduit (use fish tape in necessary), and into the portable winch box. Attach the SS cable to the Parking Stand (Eyelet) located in the upper portion of the winch box using the included Quicklink (Screw Link).

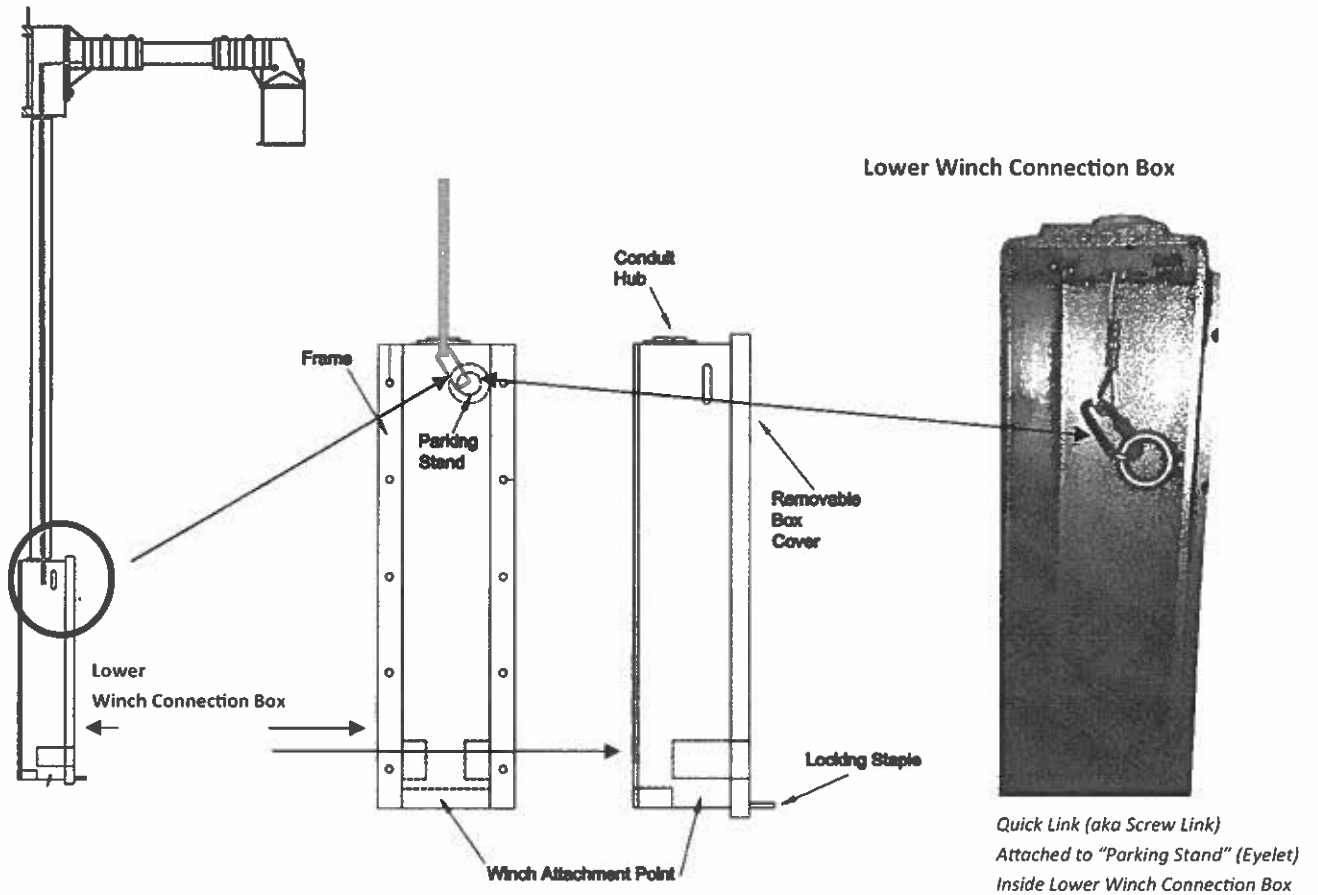

- Now that the Lowering Device is attached to the Upper Mounting Box & the Quicklink (aka: Screw Link) is attached to the Parking Stand located in the Lower Winch Box, detach the bottom contact unit from the upper unit (bell housing) by pulling down on the contact and locate the Cable Clamp Assembly at the end of the SS Cable. *More details are found on the following page.*

Installation

OLD SS Cable and Cable Clamp

Now that the Lowering Device is attached to the Tower & the Quarantine is attached to the appropriate Parking Stand and secured, detach the bottom contact and from the upper unit by pulling down on the contact and locate the Cable Clamp at the end of the SS Cable.

Note: The Cable Clamp ships with a Green Sticker attached that says to refer to these instructions before proceeding. (Sticker Color may differ in color or shape)



The wires are attached to the contact from the factory. However, if the contact unit is removed, you will need to push in the wires and use the green sticker to attach and label and fill out the attached label.



DO NOT BEGIN INSTALLATION UNTIL A FACTORY REPRESENTATIVE HAS CONDUCTED ON-SITE TRAINING.
If modifications require On-site Training after installation of Lowering Device Assembly, refer to on-site training for a factory rep. only after modification. This does not include the making of parts with multiple editions.

See this Detail on the follow Page

Installation

8. Detail

GLD SS Cable and Cable Clamp

Now that the Lowering Device is secured to upper mounting box & the Quick Link is attached to the appropriate Parking Stand and secured, detach the bottom contact unit from the upper unit by pulling down on the contact and locate the Cable Clamp at the end of the SS Cable.

Notes: The Cable Clamp ships with a Green Sticker attached that says to refer to these instructions before proceeding.
(Sticker Color may also be yellow or orange)

Grip Lower Contact with fingers and use thumbs to push against the bell housing to release contact

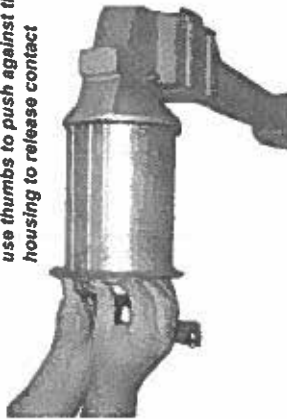

• DO NOT BEGIN INSTALLATION UNTIL A FACTORY REPRESENTATIVE HAS CONDUCTED ON-SITE TRAINING

If Specifications require On-site Training, any installation of Lowering Device Equipment prior to on-site training by a factory rep. may void certification. This does not include the mating of poles with multiple sections.

The Units are shipped Unlatched from the factory. However, if the contact unit is latched, you will need to push in the contact unit up and then down to unlatch, and then pull the unit out. see illustration below.

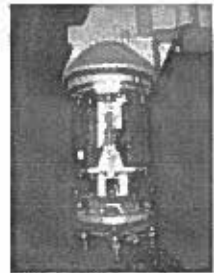
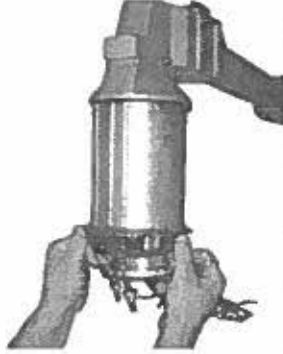
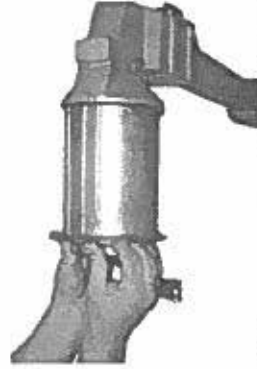
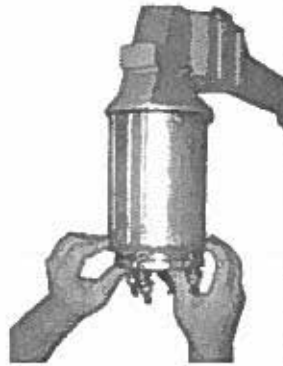

Latched (Seated)

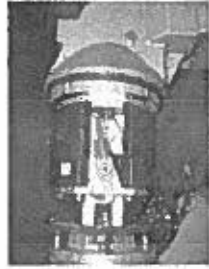

Grip Bell with fingers and push up on contact using thumbs to squeeze spring-loaded contact.

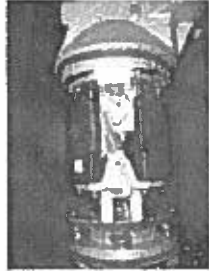

Grip Lower Contact with fingers and use thumbs to push against the bell housing to release contact



Unlatched

9. Pre-Cable Clamp/Safety Knot check list

- (A) Confirm you have detached the bottom contact unit and located the cable clamp assembly (See prior page for details locating the cable clamp assembly)
- (B) Confirm the SS cable end located in the Lower Winch Connection Box is secured to the parking stand with the included Quick Link.
- (C) From the Bottom Contact (located at the bell housing), grasp the cable clamp assembly and the SS cable attached to the cable clamp and remove slack from the parking stand to the bottom contact unit/bell housing end.
- (D) With the slack out and slight positive tension on the lowering cable (to keep the cable onto the pulleys hidden inside the CLD arm), carefully push the bottom contact unit back into the bell housing until the rubber gasket around the bottom unit is in contact with the bell. Do not latch the unit.

During installation, NEVER engage or disengage the lowering device without first maintaining tension on the lowering cable at the Parking Stand. This is to prevent the unlikely event of the lowering cable coming off one of the pulleys inside the CLD

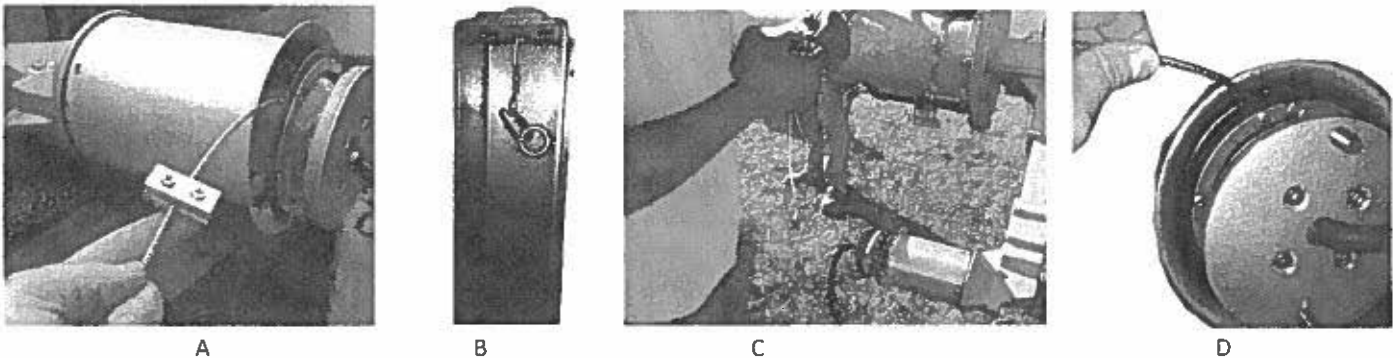

- 10. Make up the NON-SLIP SAFETY KNOT to the clamping hardware as close to the bottom contact unit as possible to prevent excess cable slack. Wrap the SS cable with Electrical tape about 1.25" from the clamp before cutting the excess cable to prevent fraying. Cut the cable through the electrical tape. ****SEE THE DETAILED SS CABLE CLAMP ASSEMBLY INSTRUCTION ON THE FOLLOWING PAGES**

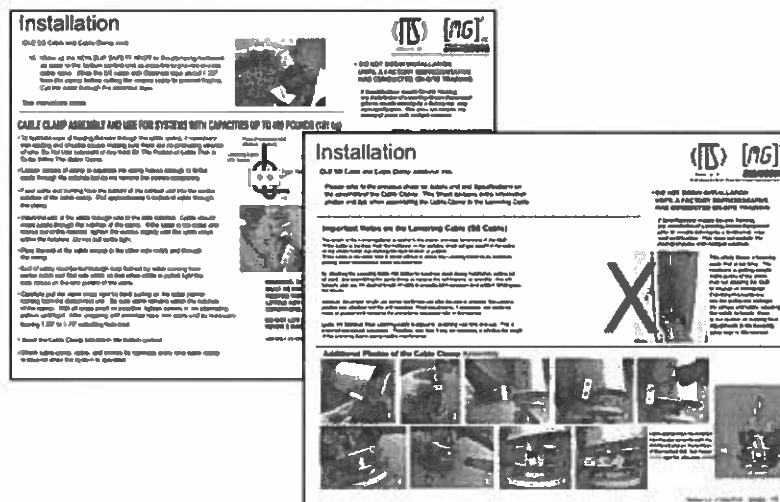

****SEE THE DETAILED SS CABLE CLAMP ASSEMBLY INSTRUCTION ON THE FOLLOWING PAGES**



CABLE CLAMP ASSEMBLY AND USE FOR SYSTEMS WITH CAPACITIES UP TO 600 POUNDS

- To facilitate ease of feeding the wire through the cable clamp, trim leading end of cable square making sure there are no protruding strands of wire. **Do Not Use Lubricant of Any Kind On The Portion of Cable That Is To Be Within The Cable Clamp.**
- Loosen screws of clamp to separate the clamp halves enough to fit the cable through the notches but do not remove the screws completely.

ADJUSTING CABLE IN CLAMP

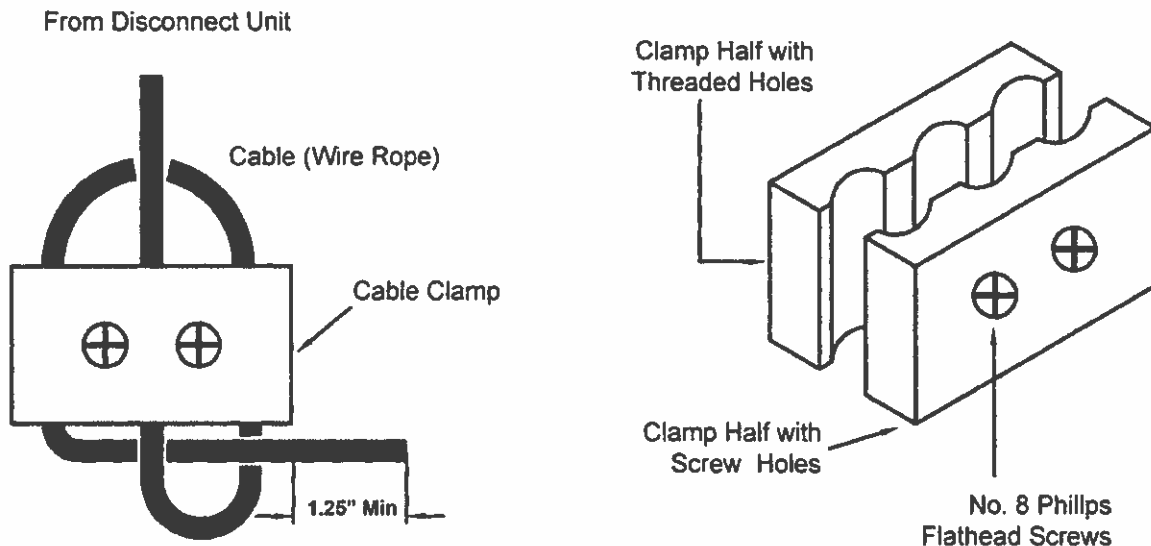

- Feed cable end coming from the bottom of the disconnect unit into the center notches of the cable clamp. Pull approximately 5 inches of cable through the clamp.
- Insert the end of the cable through one of the side notches. Cable should move easily through the notches of the clamp. If the cable is too loose and moves out of the notches, tighten the screws slightly until the cable stays within the notches. Do not pull cable tight.
- Pass the end of the cable across to the other side notch and through the clamp.
- End of cable must be fed through loop formed by cable coming from center notch and first side notch so that when cable is pulled tight the loop closes on the end portion of the cable.
- Carefully pull the cable loops tight by back pulling on the cable portion coming from the disconnect unit. Be sure cable remains within the notches of the clamp. With all loops small as possible, tighten screws in an alternating pattern until tight. End of cable should extend approximately 1.25 inch past edge of cable clamp. Trim cable end as required.
- Check cable clamp, cable, and screws for tightness every time cable clamp is lowered when the system is operated.

WARNING: TO PREVENT SERIOUS PERSONAL INJURY, THE CABLE CLAMP MUST BE PROPERLY ASSEMBLED AND THE CABLE MUST BE PROPERLY ROUTED THROUGH THE CLAMP AS SPECIFIED WITHIN. NO ATTEMPT AT LIFTING ANY LOAD SHOULD BE MADE UNTIL ALL SPECIFICATION CONDITIONS ARE MET.

**DO NOT LIFT PEOPLE OR OPERATE ANY LOWERING SYSTEM OVER PEOPLE.
USE ONLY 1/8 INCH OR 5/32 INCH DIAMETER 7x19 CONSTRUCTION CABLE WITH THIS CLAMP.**



Installation

OLD SS Cable and Cable Clamp cont.

Make up the NON-SLIP SAFETY KNOT to the clamping hardware as close to the bottom contact unit as possible to prevent excess cable slack. Wrap the SS cable with Electrical tape about 1.25" from the clamp before cutting the excess cable to prevent fraying. Cut the cable through the electrical tape.

See instructions below:

CABLE CLAMP ASSEMBLY AND USE FOR SYSTEMS WITH CAPACITIES UP TO 400 POUNDS (181 kg)

- To facilitate ease of feeding the wire through the cable clamp, if necessary trim leading end of cable square making sure there are no protruding strands of wire. Do Not Use Lubricant of Any Kind On The Portion of Cable That is To Be Within The Cable Clamp.
- Loosen screws of clamp to separate the clamp halves enough to fit the cable through the notches but do not remove the screws completely.
- Feed cable end coming from the bottom of the contact unit into the center notches of the cable clamp. Pull approximately 5 inches of cable through the clamp.
- Insert the end of the cable through one of the side notches. Cable should move easily through the notches of the clamp. If the cable is too loose and moves out of the notches, tighten the screws slightly until the cable stays within the notches. Do not pull cable tight.
- Pass the end of the cable across to the other side notch and through the clamp.
- End of cable must be fed through loop formed by cable coming from center notch and first side notch so that when cable is pulled tight the loop closes on the end portion of the cable.
- Carefully pull the cable loops tight by back pulling on the cable portion coming from the disconnect unit. Be sure cable remains within the notches of the clamp. With all loops small as possible, tighten screws in an alternating pattern until tight. After wrapping with electrical tape, trim cable end as necessary leaving 1.25" to 1.75" extruding from knot.
- Properly insert the Cable Clamp into the slot in the bottom contact
- Check cable clamp, cable, and screws for tightness every time cable clamp is lowered when the system is operated.

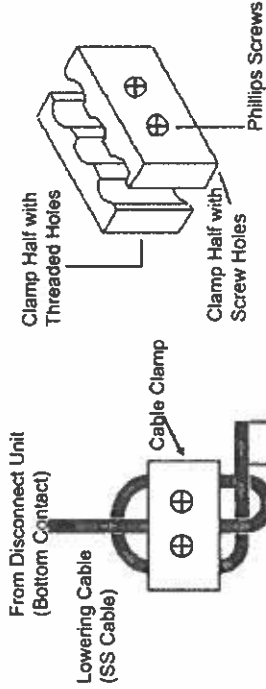

- DO NOT BEGIN INSTALLATION UNTIL A FACTORY REPRESENTATIVE HAS CONDUCTED ON-SITE TRAINING

If Specifications require On-site Training, any installation of Lowering Device Equipment prior to on-site training by a factory rep. may void certification. This does not include the mating of poles with multiple sections.

WARNING: TO PREVENT SERIOUS PERSONAL INJURY, THE CABLE CLAMP MUST BE PROPERLY ASSEMBLED AND THE CABLE MUST BE PROPERLY ROUTED THROUGH THE CLAMP AS SPECIFIED WITHIN. NO ATTEMPT AT LIFTING ANY LOAD SHOULD BE MADE UNTIL ALL SPECIFICATION CONDITIONS ARE MET.

DO NOT LIFT PEOPLE OR OPERATE ANY LOWERING SYSTEM OVER PEOPLE. NEVER STAND DIRECTLY BELOW LOWERING DEVICE DURING OPERATION.

USE ONLY 1/8 INCH OR 5/32 INCH DIAMETER 7x19 CONSTRUCTION CABLE WITH THIS CLAMP.
13 of 24



Installation

CLD SS Cable and Cable Clamp additional info.

Please refer to the previous sheet for details and and Specifications on the assembly of the Cable Clamp. This Sheet contains extra information, photos and tips when assembling the Cable Clamp to the Lowering Cable.

Important Notes on the Lowering Cable (SS Cable)

The length of the Lowering Cable is crucial to the proper and safe functioning of the CLD.

*If the Cable is too long, then the hardware on the portable winch will get caught in the pulley on the winch frame, not allowing the CLD to latch or unlatch.

*If the Cable is too short, then it will be difficult to attach the Lowering Cable to an available parking stand located on/or inside the hand hole.

By attaching the Lowering Cable (SS Cable) to a parking stand during installation, pulling out all slack, and assembling the cable clamp as close to the bell housing as possible - this will typically give you the desired length of cable to properly latch (engage) and unlatch (disengage) the device.

However, the proper length can not be confirmed until after the pole is erected, the camera-junction box attached and the unit operated. Final adjustments, if necessary, can easily be made at ground level following the procedures discussed later in this manual.

Lastly, the Stainless Steel Lowering Cable is subject to stretching over time and use. This is a normal and natural occurrence. Therefore, over time it may be necessary to shorten the length of the Lowering Cable during routine maintenance.



Due to Cable & Lowering Device / Installation Technology
© 2018 PRODUCTS INC.

• DO NOT BEGIN INSTALLATION UNTIL A FACTORY REPRESENTATIVE HAS CONDUCTED ON-SITE TRAINING

If Specifications require On-site Training, any Installation of Lowering Device Equipment prior to on-site training by a factory rep. may void certification. This does not include the mating of poles with multiple sections.

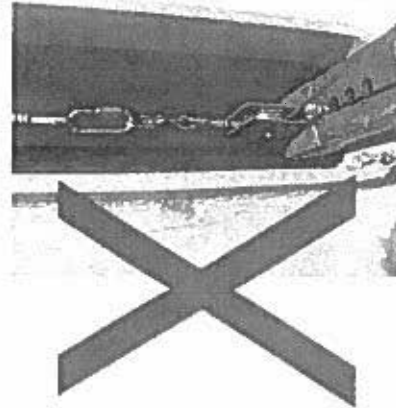

This photo shows a lowering cable that is too long. The hardware is getting caught in the pulley of the winch, thus not allowing the CLD to engage or disengage. Cranking this hardware into the pulley can damage the crimps and cable, causing the cable to break. Refer to the section on making final adjustments to the lowering cable later in this manual.

Additional Photos of the Cable Clamp Assembly

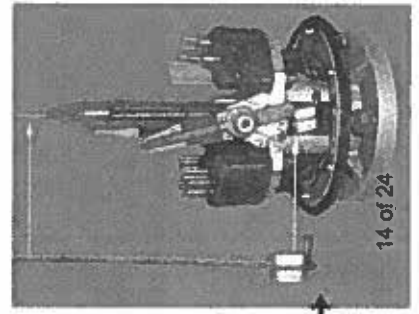
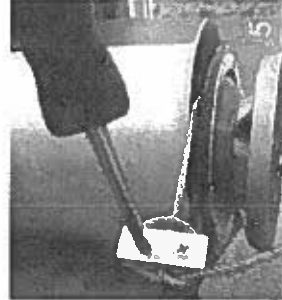
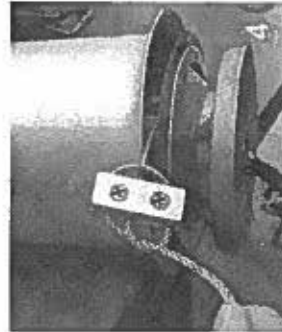
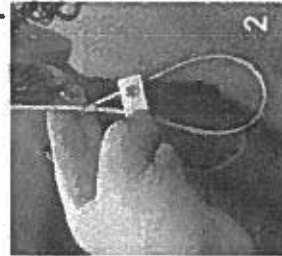

Cable Clamp Must be installed into the slot correctly with the shortened end on the bottom of the contact slot. See image to the right for reference.

11. Once the Cable Clamp Assembly (Safety Knot) is installed properly, with the SS cable still connected to the parking stand with the quicklink inside the lower winch box, unlatch the device (if not already unlatched) allowing it to hang slightly outside of the housing and attach a pull cord (mule tape or rope) to the bottom contact unit as there will be very little or no weight on the unit at this time.

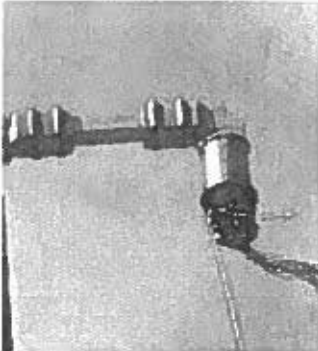

12. Insert the portable lowering tool (winch) fully into the winch receiver and secure it with the included ½” bolt to the locking staple. Feed the winch cable up and attach the winch cable to the tear drop eyelet of the Lowering Cable, using the Quick Link while leaving the Lowering Cable attached to the Parking Stand. ****The Lowering Cable from the CLD MUST ALWAYS BE 100% TIED OFF to either the parking stand, to the winch, or to both. DO NOT ALLOW LOWERING CABLE TO HANG FREELY AT ANY POINT.*** Make sure that the threads of the Quick Link are completely engaged. The Lowering Cable should now be attached to both the winch and the parking stand.

Once the winch cable is secured to the Lowering Cable,

Release the lowering cable from the quicklink attached to the parking stand. **DO NOT DETACH THE WINCH CABLE UNTIL THE LOWERING CABLE IS REATTACHED TO THE PARKING STAND.**

Lower the bottom contact unit while keeping positive tension on the pull cord as necessary

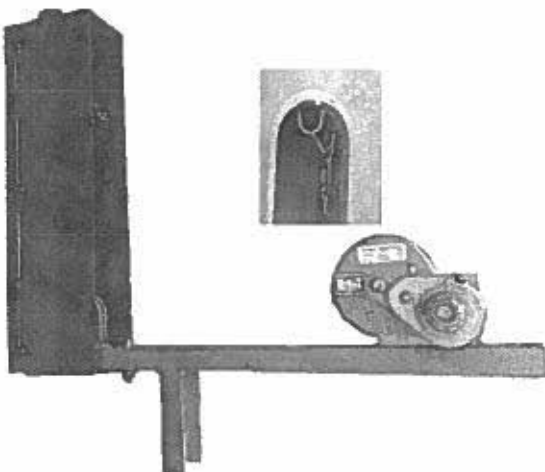

Lower Bottom Contact Unit, using Pull Cord as necessary



Attach Camera Junction Box

13. From Ground Level - Attach the Camera Junction Box to the bottom contact unit with all four bolts, washers, and nuts and install the counter weights. SEE CAMERA JUNCTION BOX INSTALLATION DETAIL ON THE FOLLOWING PAGE

Installation

Attach Camera Junction Box

CAMERA JUNCTION BOX INSTALLATION DETAIL



***DO NOT INSTALL THE CAMERA JUNCTION BOX UNTIL THE POLE IS ERECTED AND SET.** Installing the Camera Junction Box prior to setting of pole may damage the alignment probe and void all warranties.



PRODUCTS INC.

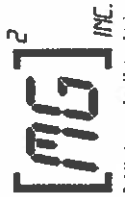

26 130 119 111

• DO NOT BEGIN INSTALLATION UNTIL A FACTORY REPRESENTATIVE HAS CONDUCTED ON-SITE TRAINING

If Specifications require On-site Training, any installation of Lowering Device Equipment prior to on-site training by a factory rep. may void certification. This does not include the mating of poles with multiple sections.



1. Lower Bottom Contact Unit, using Pull Cord as necessary

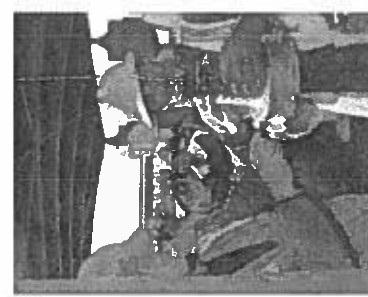

2. Attach Camera Junction Box

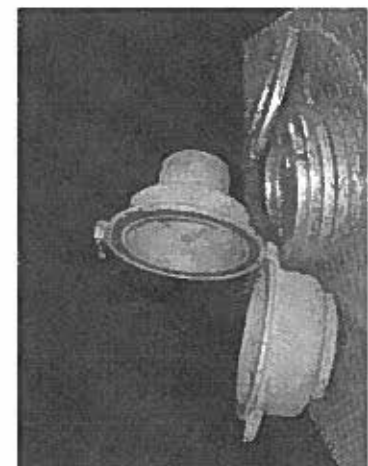

3. Unhinge and Remove Top Half of Camera Junction Box

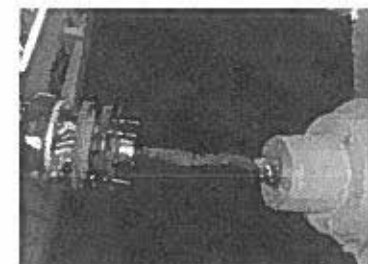

4. Feed CLD Cable down Through Top-Section Of Junction Box



5. Using 7/16" wrench and a 7/16" Nut Driver (or 7/16" socket with Extension), attach the Junction Box to the CLD with the included bolts, nuts, and washers. (Recommended torque for 1/4" bolts is 68/75 or 75 in/lbs) **Tip: Coating of stainless steel bolts with anti-seize lubricant is recommended*

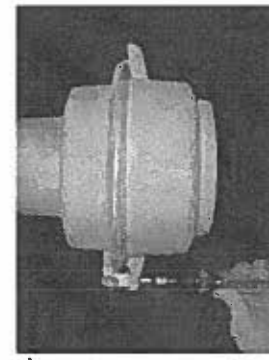

6. Re-attach the bottom side of the hinged box to the top side



7. Guide the weights onto the top of the JB with the nipples up (indentions down) and rotate each weight to match the indentions with the nipples in order to keep weights from rotating. ***ALL FOUR (4) WEIGHTS MUST BE INSTALLED BEFORE RAISING THE CLD INTO THE LATCHED POSITION. FAILURE TO INSTALL THE WEIGHTS PRIOR TO LATCHING WILL RESULT IN INSUFFICIENT WEIGHT REQUIRED TO UNLATCH THE CLD**



8. ***ALL FOUR (4) WEIGHTS MUST BE INSTALLED BEFORE RAISING THE CLD INTO THE LATCHED POSITION. FAILURE TO INSTALL THE WEIGHTS PRIOR TO LATCHING WILL RESULT IN INSUFFICIENT WEIGHT REQUIRED TO UNLATCH THE CLD**

****IMPORTANT****

**AFTER COMPLETING GENERAL INSTRUCTIONS FOLLOW THE APPLICABLE
INSTRUCTIONS ON BELOW.**

**FOR CAMERA LOWERING UNITS WITH CONTRACTOR PROVIDED POWER/SIGNAL CABLE
INSTALLED IN THE FIELD**

1. Prepare all your conductors for termination.
2. Terminate all used conductors to the appropriate wires or in the appropriate connector (FBO) and strain relieve the cable appropriately. Ensure all terminations/connections are sealed.
3. Secure all unused conductors as SPARES.
4. Install the upper mounting box door cover.
5. With the bottom unit engaged, Check all conductors for continuity from the bare leads from the bottom connector of the lowering device through to the bare leads of the power signal cable before leaving the upper mounting box.
6. See Camera Manufacture's instructions for attaching camera.

****Non-Pressurized Cameras should be sealed/potted to prevent any moisture from entering the housing. MG Squared takes no responsibility for water intrusion inside cameras/fixtures or other devices. Consult your Camera Manufacturer for proper procedures.***

**FOR CAMERA LOWERING UNITS USING MG2/FACTORY PROVIDED PRE-WIRED
POWER/SIGNAL CABLE**

1. Adjust strain-relief on Power/Signal cable so that there is sufficient slack to mate Power/Signal cable with the mating ends located on the leads from the back side of the CLD.
2. Mate connectors and seal with self-fusing sealing tape or by using other sealing components/methods.
3. Slide Power/Signal cable back down the pole/tower/structure and secure strain relief to hook inside upper mounting box.
4. Continue installation from #5 above.

****Non-Pressurized Cameras should be sealed/potted to prevent any moisture from entering the housing. MG Squared takes no responsibility for water intrusion inside cameras/fixtures or other devices. Consult your Camera Manufacturer for proper procedures.***

WARNING

Keep the male guide probe and connector clean of dirt. Do Not handle the male guide probe, male contacts or dual locking cams with your hands or gloves. Handling of the lower disconnect unit is to be done around the base and gasket ONLY.

Reference Photos

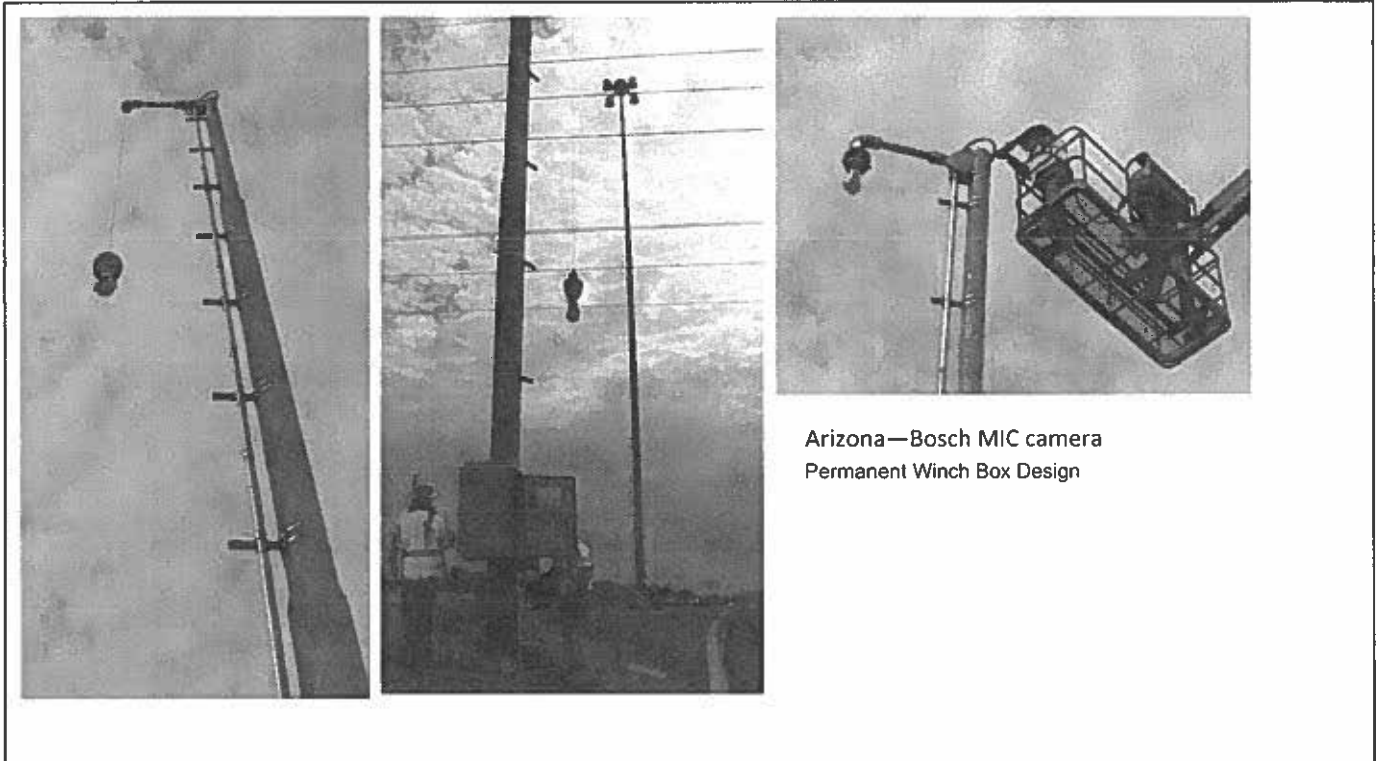

Arizona—Bosch MIC camera
 Permanent Winch Box Design

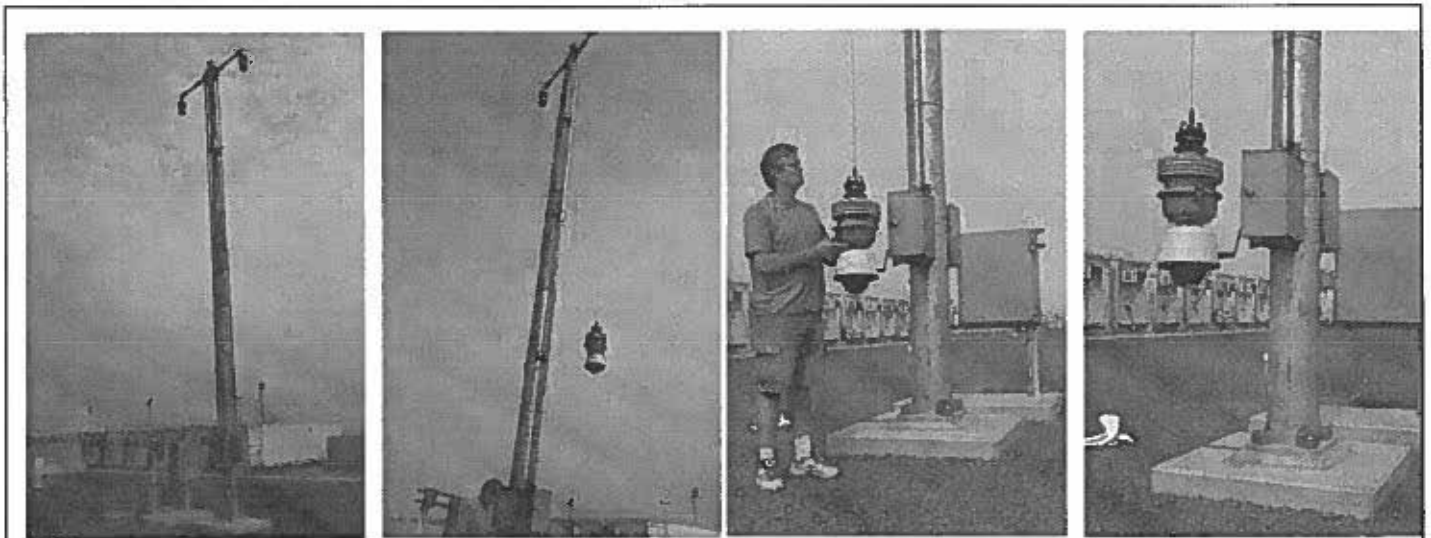

Djibouti , Africa

Pelco Spectra IV Camera
 Permanent Winch Box Design

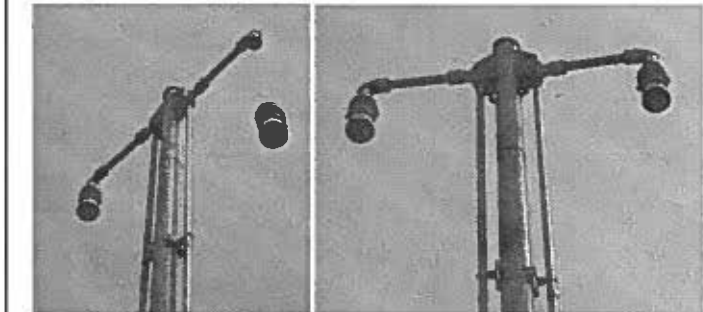

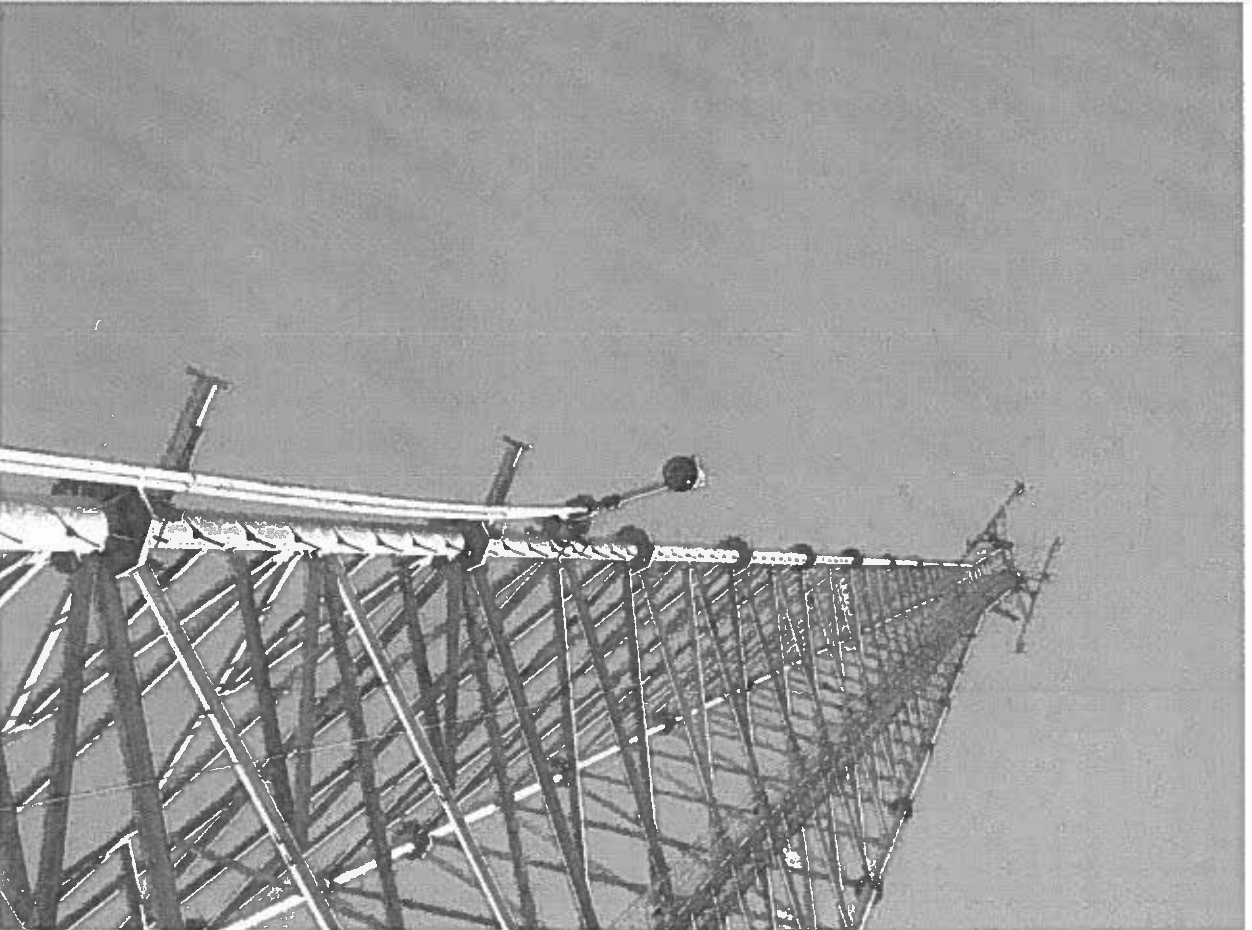
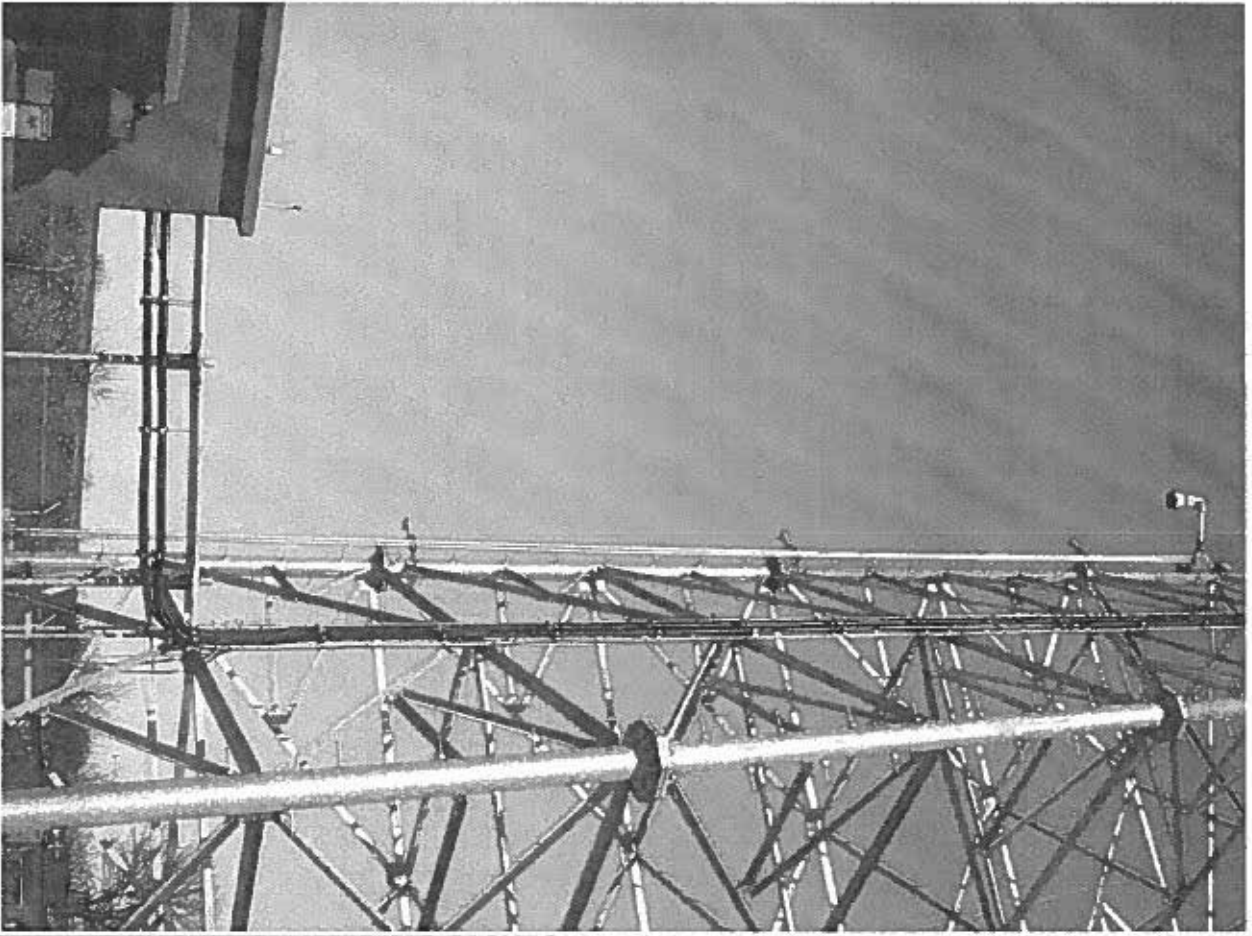

Reference Photos - Various Sites - Permanent Winch Box Designs



Reference Photos - Various Sites - Permanent Winch Box Designs

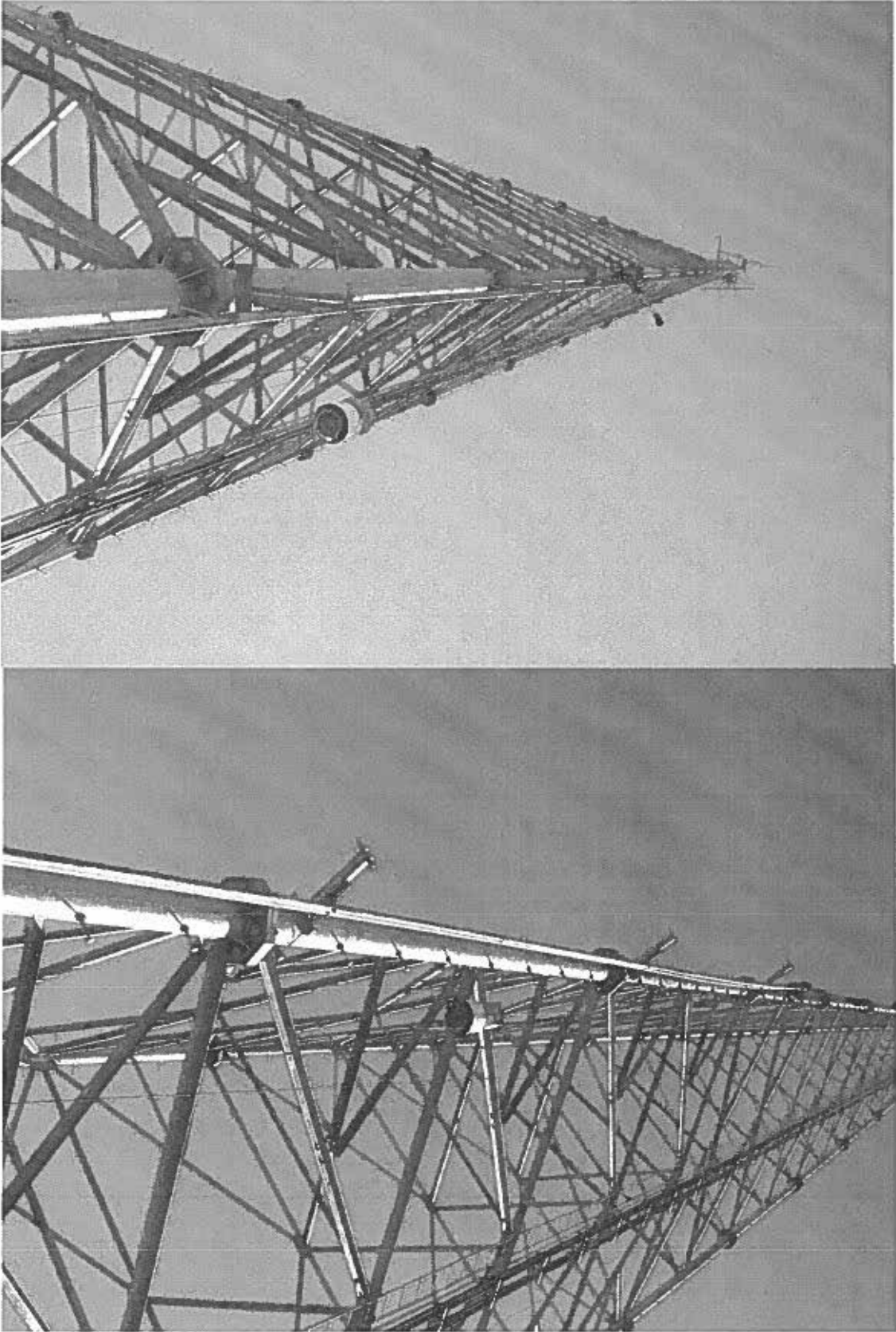

Reference Photos - Various Sites - Permanent Winch Box Designs

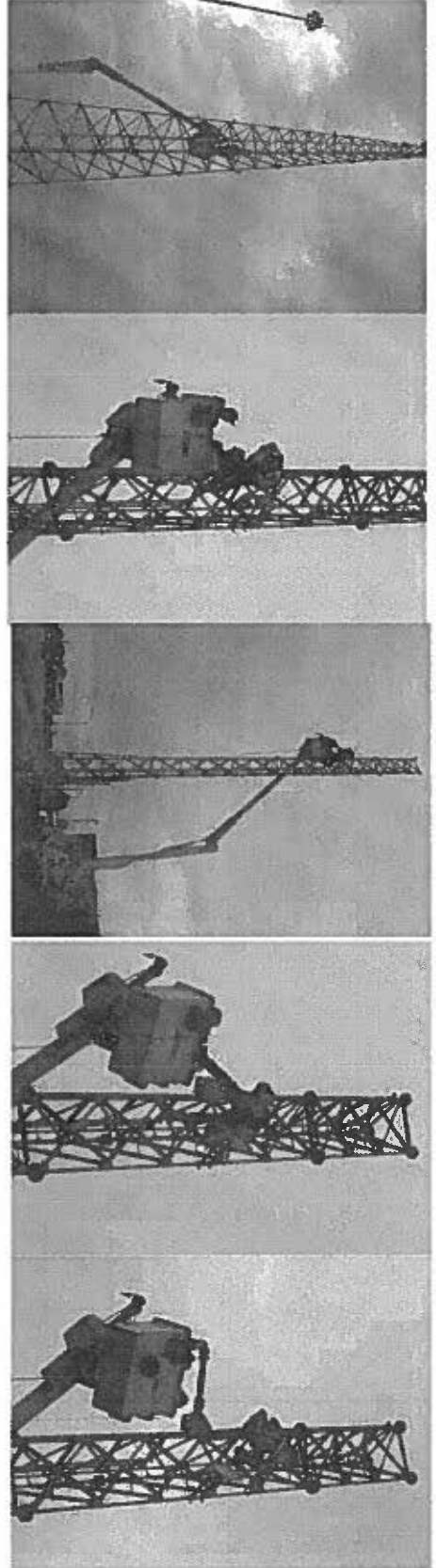
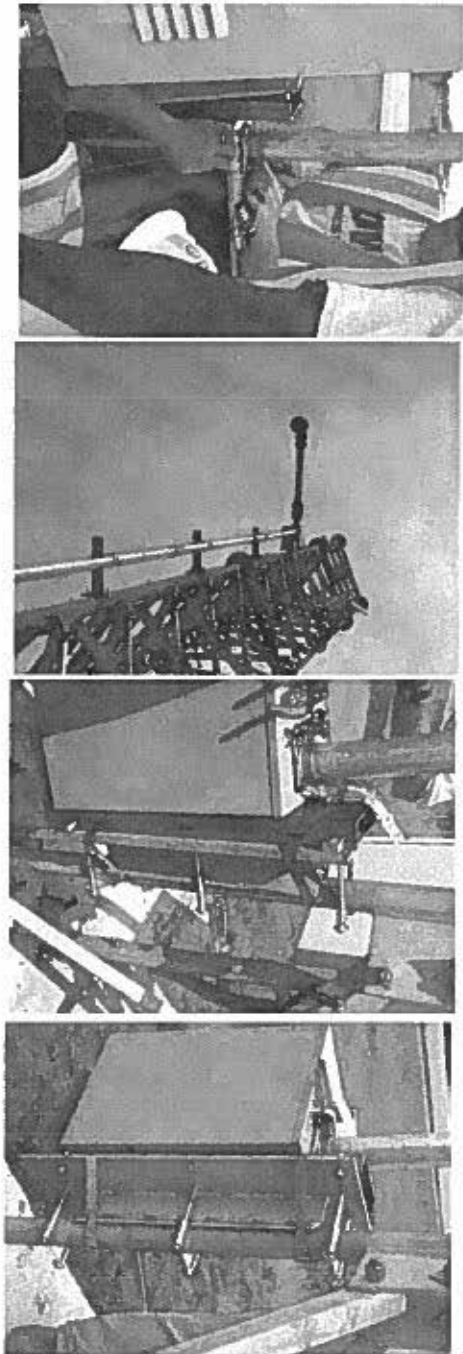

Reference Photos - Various Sites - Permanent Winch Box Designs

Reference Photos - Various Sites - Permanent Winch Box Designs

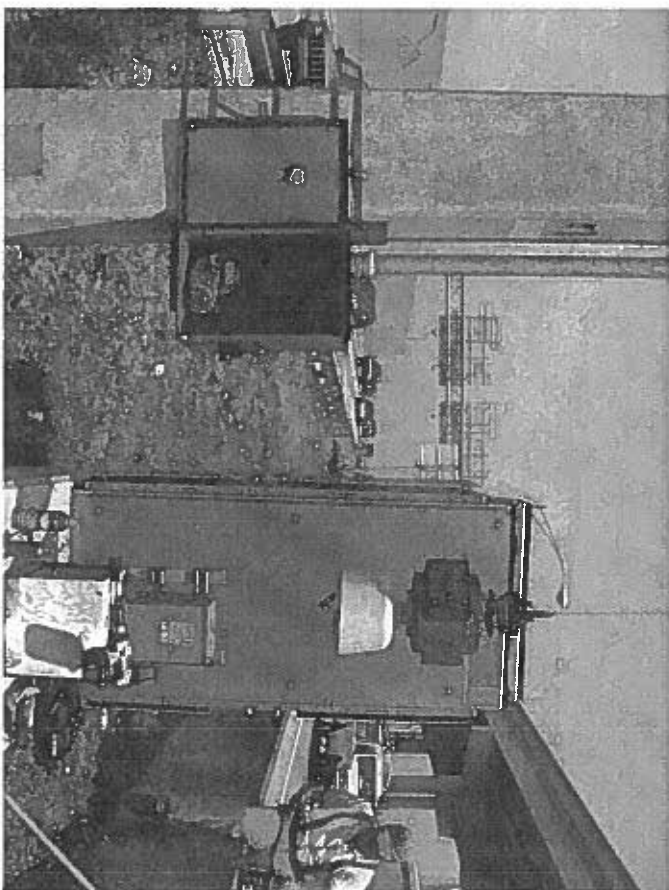
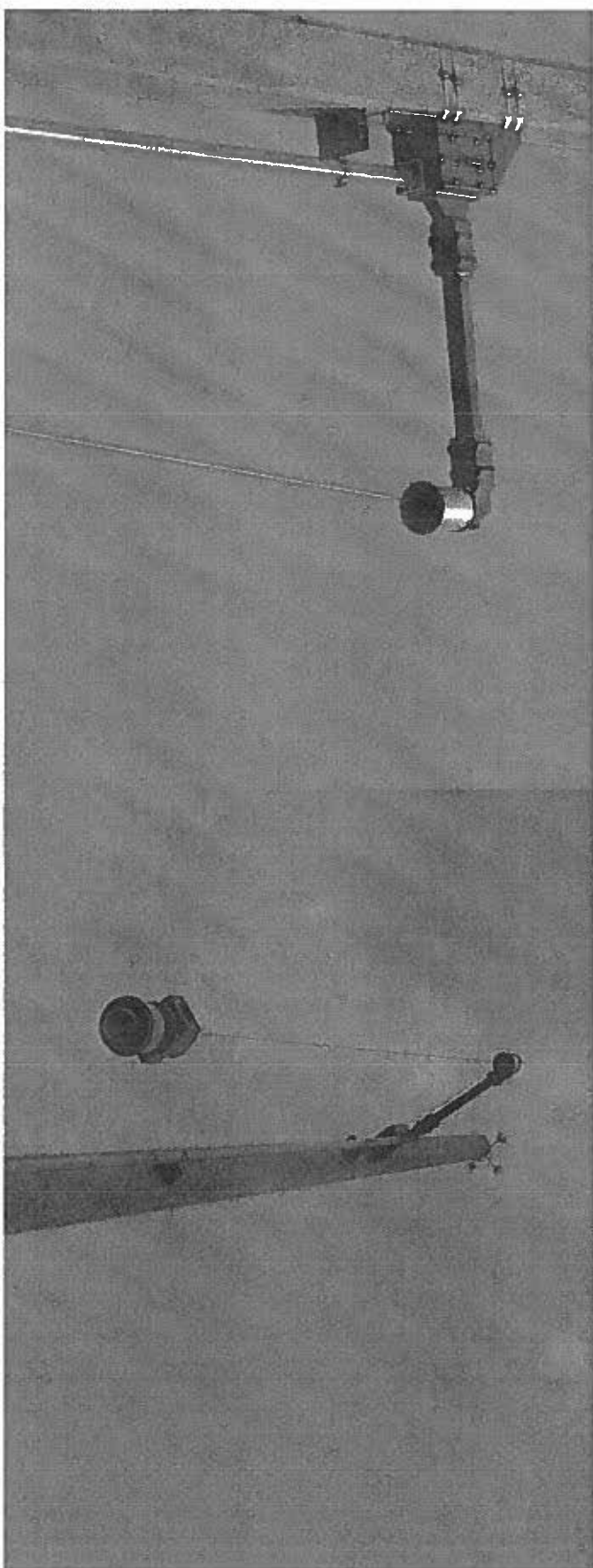

Reference Photos - Various Sites - Permanent Winch Box Designs

