

Fuzzy Practical Exponential Tracking of an Electrohydraulic Servosystem

Radiša Ž. Jovanović

Teaching Assistant
University of Belgrade
Faculty of Mechanical Engineering

Zoran B. Ribar

Full Professor
University of Belgrade
Faculty of Mechanical Engineering

The aim of this paper is to contribute to the theoretical and practical applications of fuzzy logic control using practical tracking concept. A new fuzzy control algorithm is proposed to achieve the desired tracking performance of a nonlinear electrohydraulic position servo system, which can be found in many manufacturing devices. The fuzzy logic controller is one of the simplest. It employs only one input, with linear fuzzy inference method. The practical tracking control algorithm is based on the self-adjustment principle. The structural characteristic of such a control system is the existence of two feedback sources: the global negative of the output value and the local positive of the control value. Such a structure ensures the synthesis of the control without the internal dynamics knowledge and without measurements of disturbance values. The proposed fuzzy practical control algorithm ensures the change of the output error value according to a prespecified exponential law. The simulation results of the nonlinear mathematical model of the hydraulic servosystem are presented.

Keywords: fuzzy control, practical tracking, electrohydraulic servosystem.

1. INTRODUCTION

Electrohydraulic servosystems have been used in industry in a wide number of applications due to their small size-to-power ratio and the ability to apply a very large force and torque. However, the dynamics of hydraulic systems are highly nonlinear [1], the system can be subjected to non-smooth and discontinuous nonlinearities due to control input saturation, directional change of valve opening, friction, and valve overlap. Aside from the nonlinear nature of hydraulic dynamics, electrohydraulic servosystems also have a large extent of model uncertainties, such as the external disturbances and leakage that cannot be modelled exactly, and the nonlinear functions that describe them may not be known.

The traditional and widely used approach to the control of electrohydraulic systems is based on the local linearization of the nonlinear dynamics about operating point, [1]. In general, tracking problems are more difficult than stabilization problems, especially for nonlinear systems. For nonlinear system design, various control schemes are introduced, including exact feedback linearization, sliding mode control and adaptive control. The technique of exact feedback linearization requires perfect knowledge of the nonlinear system and uses that knowledge to reduce the influence of the nonlinearities of the system. Since perfect knowledge of the system is almost impossible, the technique of exact feedback linearization seems impractical for nonlinear system design [2,3]. Recently, based on feedback linearization technique, adaptive fuzzy control schemes have been introduced to deal

with nonlinear systems. However, the complicated parameter update law and control algorithm make this control scheme impractical [3]. An advantage of sliding mode control is its robustness to uncertainties, [4]. However, the chattering phenomenon that results in low control accuracy and high heat loss in electrical power circuits is inevitable in the sliding mode control. It may also excite unmodelled high-frequency dynamics, which degrades the performance of the system and may even lead to instability.

An alternative to the model-based control is the fuzzy control. Classical fuzzy controllers are obtained from conventional controllers by fuzzification of all input variables of the controller. These controllers have nonlinear characteristics, and they are suitable for control of nonlinear systems. Fuzzy controllers are inherently nonlinear controllers, and hence fuzzy control technology can be viewed as a new, cost effective and practical way of developing nonlinear controllers. The major advantage of this technology over the traditional control technology is its capability of capturing and utilizing qualitative human experience and knowledge in a quantitative manner through the use of fuzzy sets, fuzzy rules and fuzzy logic. However, carrying out analytical analysis and design of fuzzy control systems is difficult not only because the explicit structure of fuzzy controllers is generally unknown, but also due to their inherent nonlinear and time-varying nature. There exist two major types of fuzzy controllers, namely Mamdani fuzzy controllers, and Takagi-Sugeno fuzzy controllers. They mainly differ in the consequent of fuzzy rules: the former uses fuzzy sets whereas the latter employs (linear) functions. For the historical reason, Mamdani fuzzy controllers have received wider attention and their analytical structures, including some rather complicated ones, have been revealed in relation to classical controllers through rigor derivation, e.g. [5-12]. The majority of applications during the past two decades belong to the class of fuzzy PID controllers.

Received: December 2010, Accepted: January 2011

Correspondence to: Radiša Jovanović, M.Sc.
Faculty of Mechanical Engineering,
Kraljice Marije 16, 11120 Belgrade 35, Serbia
E-mail: rjovanovic@mas.bg.ac.rs

Summarily, most Mamdani fuzzy controllers, if not all, are nonlinear controllers with variable gains. In particular, the Mamdani fuzzy PI, PD and PID controllers are, respectively, nonlinear PI, PD and PID controllers with variable gains.

The aim of this paper is to design a fuzzy logic controller (FLC) based on the concept practical tracking, developed by Grujić in 1984, [13]. This nonconventional control concept has further been developed by Grujić [14-16] and Lazić [17].

From the technical viewpoint, the concept of practical tracking has a great importance. The consideration of the dynamics behaviour of technical plants on limited time intervals, with a prespecified quality of that behaviour, requires constraints to be placed on any technical plant. For many technical plants the most adequate tracking concept is the practical tracking concept. The concept most completely satisfies practical technical requirements on the dynamics behaviour as well as the quality of the dynamics behaviour. Elementwise exponential tracking was introduced by Grujić and Mounfield, [18-22]. The nonuniform practical exponential tracking was introduced by Lazić [17], where definitions, criteria and algorithms for such tracking are presented for a certain class of technical objects. FLC based on the concept practical tracking has been introduced by Jovanović, [23-25].

2. PROBLEM STATEMENTS

Various technical objects can be described by a mathematical model expressed by the state space and output equations:

$$\begin{aligned}\dot{\mathbf{x}}(t) &= \mathbf{f}[\mathbf{x}(t), \mathbf{d}(t)] + \mathbf{B}\mathbf{u}(t), \\ \mathbf{y}(t) &= \mathbf{g}[\mathbf{x}(t)].\end{aligned}\quad (1)$$

where $\mathbf{x} \in R^q$, $\mathbf{y} \in R^n$, $\mathbf{u} \in R^r$ and $\mathbf{d} \in R^p$ are the state, output, control and disturbance vectors, respectively. Time is denoted by t , the control vector function is $\mathbf{u}(\cdot): R \rightarrow R^r$, the disturbance vector function is $\mathbf{d}(\cdot): R \rightarrow R^p$, and the desired output vector (function) is $\mathbf{y}_d \in R^n$ ($\mathbf{y}_d(\cdot): R \rightarrow R^n$). Similarly, $\mathbf{y}[t; \mathbf{y}_0; \mathbf{u}(\cdot), \mathbf{y}_d(\cdot), \mathbf{d}(\cdot)]$ denotes the real output response, which at time t equals the real output vector at the same time, $\mathbf{y}[t; \mathbf{y}_0; \mathbf{u}(\cdot), \mathbf{y}_d(\cdot), \mathbf{d}(\cdot)] = \mathbf{y}(t)$. The output error vector is $\mathbf{e} \in R^n$, $\mathbf{e}[t; \mathbf{e}_0; \mathbf{u}(\cdot), \mathbf{y}_d(\cdot), \mathbf{d}(\cdot)]$ denotes the output error response which at time t represents the output error vector $\mathbf{e}(t)$ at the same time, $\mathbf{e}[t; \mathbf{e}_0; \mathbf{u}(\cdot), \mathbf{y}_d(\cdot), \mathbf{d}(\cdot)] = \mathbf{e}(t)$. The continuous vector functions $\mathbf{f}(\cdot): R^q \times R^p \rightarrow R^q$, $\mathbf{f}(\mathbf{x}, \mathbf{d}) \in C(R^q \times R^p)$ and $\mathbf{g}(\cdot): R^q \rightarrow R^n$ describe plant internal dynamics and output function, respectively, $\mathbf{B} \in R^{q \times r}$ is matrix.

It is required that the real dynamic behaviour of the system (1) tracks its desired dynamic behaviour with prescribed quality as long as initial real output values are allowable and real dynamic behaviour is realizable. The sets of all accepted desired outputs $\mathbf{y}_d(\cdot)$, realizable controls $\mathbf{u}(\cdot)$ and permitted disturbances $\mathbf{d}(\cdot)$ on R_τ are S_y , S_u and S_d , respectively, where $R_\tau = [0, \tau]$ is the continuous time set over which tracking is considered, and $\mathbf{y}_d(t) \in C(R_\tau, R^n)$.

The admitted bounds of the vector \mathbf{y} of the object real dynamic behaviour are determined by the vector of the desired dynamic behaviour \mathbf{y}_d and sets E_1 and E_A , as follows:

$$I_1(\mathbf{y}_{d0}; E_1) = \{\mathbf{y}_0 : \mathbf{y}_0 = \mathbf{y}_{d0} - \mathbf{e}_0, \mathbf{e}_0 \in E_1\}, \quad (2)$$

$$I_A(t; \mathbf{y}_d(\cdot); E_A) = \{\mathbf{y} : \mathbf{y} = \mathbf{y}_d(t) - \mathbf{e}, \mathbf{e} \in E_A\}, \quad (3)$$

where $E_A \subset R^n$ is the set of all admitted errors $\mathbf{e}(t)$ on R_τ , $E_1 \subset R^n$ is the set of all admitted initial errors $\mathbf{e}(0)$ on R_τ , E_A and E_1 are closed connected neighbourhood of $\mathbf{0}_e$. $I_A(\cdot)$ and $I_1(\cdot)$ denote the set functions of all admitted vector functions $\mathbf{y}(\cdot)$ and $\mathbf{y}_d(\cdot)$ on R_τ with respect to \mathbf{y}_d and E_A , and to \mathbf{y}_{d0} and E_1 , respectively.

3. PRACTICAL EXPONENTIAL TRACKING

By referring to Lazić [17], the following definition and theorem are introduced. Let $\Lambda \in R^{n \times n}$, $\Lambda = \text{diag}\{\alpha_1 \alpha_2 \dots \alpha_n\}$, $\alpha_i \in [1, +\infty[$, $\forall i = 1, 2, \dots, n$, and I be the identity matrix of the appropriate order.

Definition 1: The system (1) controlled by $\mathbf{u}(\cdot) \in S_u$ exhibits the practical exponential tracking with respect to $\{\tau, \Lambda, \beta, I_1(\cdot), I_A(\cdot), S_y, S_d\}$, Fig. 1, if and only if $[\mathbf{y}_0, \mathbf{y}_d(\cdot), \mathbf{d}(\cdot)] \in I_1(\mathbf{y}_{d0}) \times S_y \times S_d$ implies

$$\mathbf{y}[t; \mathbf{y}_0; \mathbf{u}(\cdot), \mathbf{y}_d(\cdot), \mathbf{d}(\cdot)] \in I_A(t), \quad \forall t \in R_\tau \quad (4)$$

and for $\forall i \in \{1, 2, \dots, n\}$ and $\forall t \in R_\tau$ holds

$$\begin{aligned}y_i[t; y_{i0}; \mathbf{u}(\cdot), \mathbf{y}_d(\cdot), \mathbf{d}(\cdot)] &\geq \\ &\geq y_{di}(t) - \alpha_i(y_{di0} - y_{i0})e^{-\beta t}, \quad y_{i0} \leq y_{di0}\end{aligned}\quad (5)$$

and

$$\begin{aligned}y_i[t; y_{i0}; \mathbf{u}(\cdot), \mathbf{y}_d(\cdot), \mathbf{d}(\cdot)] &\leq \\ &\leq y_{di}(t) - \alpha_i(y_{di0} - y_{i0})e^{-\beta t}, \quad y_{i0} \geq y_{di0}.\end{aligned}\quad (6)$$

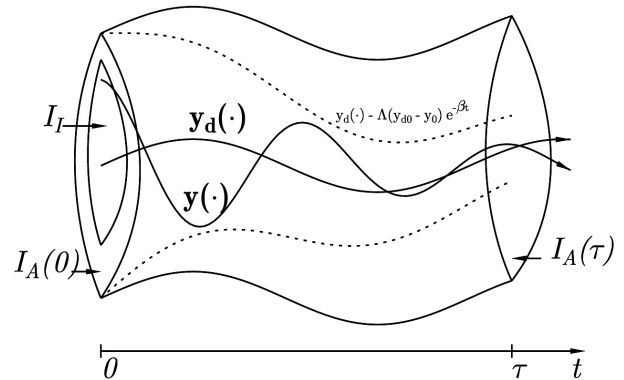

Figure 1. Practical exponential tracking

Theorem 1: In order for the system (1) controlled by $\mathbf{u}(\cdot)$ to exhibit the practical exponential tracking with respect to $\{\tau, I, \beta, I_1(\cdot), I_A(\cdot), S_y, S_d\}$ it is sufficient that control $\mathbf{u}(\cdot)$ guaranties:

$$\begin{aligned}\dot{\mathbf{e}}[t; \mathbf{e}_0; \mathbf{u}(\cdot), \mathbf{y}_d(\cdot), \mathbf{d}(\cdot)] &= -\gamma \mathbf{e}(t), \\ \forall [t, \mathbf{e}_0, \mathbf{y}_d(\cdot), \mathbf{d}(\cdot)] &\in R_\tau \times E_1 \times S_y \times S_d\end{aligned}\quad (7)$$

where $\gamma \in [\beta, +\infty[$.

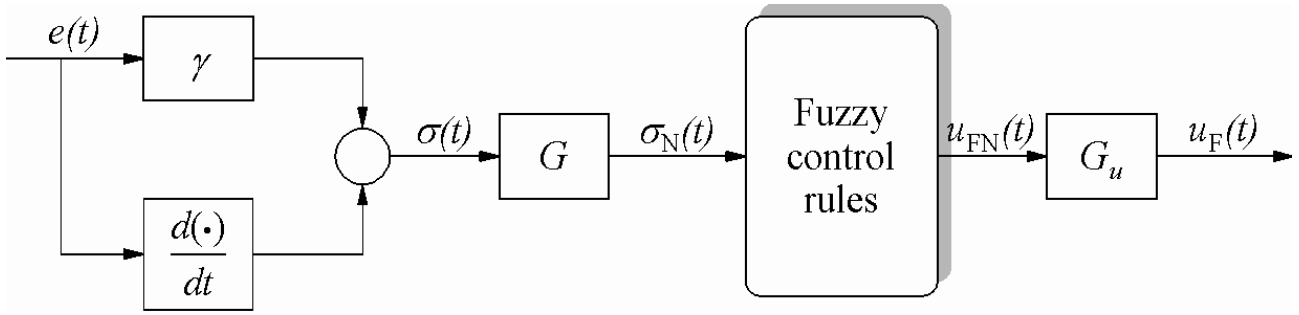

Figure 2. The proposed fuzzy logic controller

4. STRUCTURE OF FLC

The fuzzy logic controller that will be evaluated is one of the simplest, Fig. 2. It employs only one input variable, $\sigma(t)$, which is defined as:

$$\sigma(t) = \dot{e}(t) + \gamma \cdot e(t), \quad (8)$$

where $\gamma > 0$. This section introduces the principal structure of the proposed controller. The principal components of fuzzy controller are: fuzzification and defuzzification modules, rule base and inference engine.

4.1 Scaling factors

The use of normalized domains requires a scale transformation, which maps the physical values of the input variable (σ in the present study) into a normalized domain. This is called input normalization. Furthermore, output denormalization maps the normalized value of the control output variable (u_{FN}) into its respective physical domain (u_F). The relationships between scaling factors (G , G_u) and the input and output variables are as follows:

$$\sigma_N(t) = G \cdot \sigma(t), \quad (9)$$

$$u_F(t) = G_u \cdot u_{FN}(t). \quad (10)$$

4.2 Fuzzification module

It converts instantaneous value of a process state variable into a linguistic value with the help of the represented fuzzy set. The parametric functional description of the triangular shaped membership function is the most economic one and hence it is considered here.

Let σ^* be the one crisp input. Then, the fuzzified version of σ^* is its degree of membership in $\mu_N(\sigma_N^*)$ and $\mu_P(\sigma_N^*)$ where N and P are the linguistic values taken by σ_N . Here, symbols N and P have common meanings *negative* and *positive*, respectively. The inputs are fuzzified by triangular type membership functions, shown in Figure 3, whose mathematical description is respectively given by:

$$\mu_N(\sigma_N) = \frac{-\sigma_N + L}{2L}, \quad \mu_P(\sigma_N) = \frac{\sigma_N + L}{2L}. \quad (11)$$

It is noticed that:

$$\mu_N(\sigma_N) + \mu_P(\sigma_N) = 1. \quad (12)$$

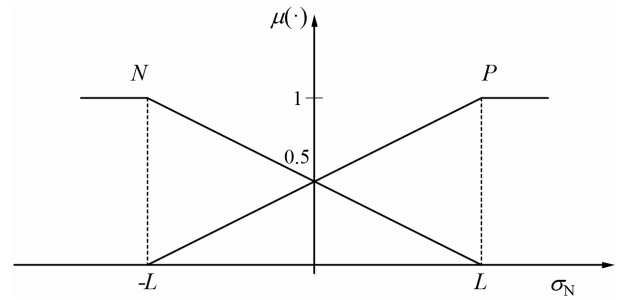

Figure 3. The input membership functions

The membership functions for the normalized output (u_{FN}) are singleton and shown in Figure 4. In these two figures, L and H are two positive constants chosen by the designer, which can be fixed after being determined.

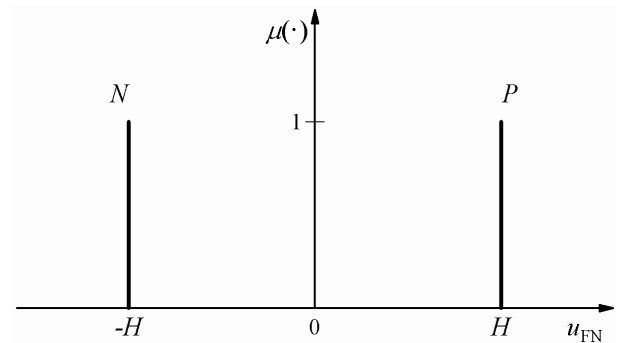

Figure 4. The output membership functions

Assumption 1: The value $\sigma_N(t)$ satisfies:

$$\sigma_N(t) \in [-L, L], \quad \forall t \in R_\tau. \quad (13)$$

4.3 Fuzzy control rules

Using the aforementioned membership functions, the following control rules are established for the fuzzy logic control part:

$$\begin{aligned} \text{if } \sigma_N \text{ is } N \text{ then } u_{FN} \text{ is } N, \\ \text{if } \sigma_N \text{ is } P \text{ then } u_{FN} \text{ is } P. \end{aligned} \quad (14)$$

4.4 Inference engine

The basic function of the inference engine is to compute the overall value of control output variable based on the individual contribution of each rule in the rule base. A degree of match for each rule is established by using the defined membership functions. Based on this degree of match, the value of control output variable in the rule-

consequent is modified using the Larsen product inference method.

4.5 Defuzzification module

Defuzzification module converts the set of modified control output values into a crisp value. Defuzzification is done using the well-known COS (center of sum) method. According to this method, the crisp value of control output is given by:

$$u_{FN} = \frac{\mu_N(\sigma_N) \cdot (-H) + \mu_P(\sigma_N) \cdot H}{\mu_N(\sigma_N) + \mu_P(\sigma_N)}. \quad (15)$$

Behaviour of the proposed fuzzy logic controller can be represented by the functional expressions as follows:

$$u_F(t) = \Phi(e(t), \dot{e}(t), G, G_u, \gamma). \quad (16)$$

5. ALGORITHM

The electrohydraulic servosystem, which is considered, consists of an electrohydraulic servovalve with a hydraulic cylinder. In this study, it is considered as single input-single output control system described by (17):

$$\begin{aligned} \dot{\mathbf{x}}(t) &= \mathbf{f}[\mathbf{x}(t)] + \mathbf{B}u(t) + \mathbf{D}d(t), \\ y(t) &= \mathbf{C}\mathbf{x}(t). \end{aligned} \quad (17)$$

The algorithm is based on the natural tracking control concept introduced by Grujić. The main characteristic of this concept, which follows from the self-adaptive principle, Grujić [18-22], is the existence of the local positive feedback in the control \mathbf{u} (with possible derivative and/or integrals of \mathbf{u}). The information about disturbances and the internal dynamics of the controlled object is not used when the control signal is calculated. The character of the change output error value $\mathbf{e}(t)$ can be exactly defined by means of this algorithm.

Assumption 2: The values of $y(t)$ and $\dot{y}(t)$ from (17) are measurable in any time instant $t \in R_\tau$.

Theorem 2: Let Assumption 1 and Assumption 2 hold, let $S_u = \{u(\cdot)\}$ and control $u(\cdot)$:

$$\begin{aligned} u(t) &= u(t^-) + \Phi(e(t), \dot{e}(t), G, G_u, \gamma), \\ \forall [t, e_0, y_d, d(\cdot)] &\in R_\tau \times E_I \times S_y \times S_d \end{aligned} \quad (18)$$

where $\Phi(e(t), \dot{e}(t), G, G_u, \gamma)$ is functional characteristic of the proposed FLC, (16), G and G_u are arbitrary scaling factors satisfied:

$$G > 0, G_u > 0, G \leq \frac{L}{\sigma_M}, \quad (19)$$

where σ_M is defined as:

$$\sigma_M = \max_t |\sigma(t)| = \max_t |\dot{e}(t) + \gamma \cdot e(t)|, \quad (20)$$

and $\gamma \in [\beta, +\infty[$.

System (1) controlled by $u(\cdot)$, (18), exhibits the practical exponential tracking with respect to $\{\tau, I, \beta, I_1(\cdot), I_A(\cdot), S_y, S_d\}$.

Proof 2: From definition variable σ_M in (20), relation between the scaling factor and input variable, (9), and the condition (19) of Theorem 2 it follows that:

$$|\sigma_N(t)| = G \cdot |\sigma(t)| \leq \frac{L}{\sigma_M} \cdot |\sigma(t)| \leq \frac{L}{\sigma_M} \cdot \sigma_M = L. \quad (21)$$

Then,

$$\sigma_N(t) \in [-L, L], \quad (22)$$

and Assumption 1 holds.

Due to the nature of the chosen membership functions of the input fuzzy sets, (12), the nominator of (15) is always equal to 1. Taking into account the mathematical description of the input membership (11), from (15) the resulting control law of the proposed fuzzy controller is obtained:

$$u_{FN}(t) = \frac{H}{L} \cdot G \cdot (\dot{e}(t) + \gamma e(t)). \quad (23)$$

Based on (10), (16) and (23) it follows that:

$$\begin{aligned} u_F(t) &= \Phi(e(t), \dot{e}(t), G, G_u, \gamma) = \\ &= \frac{H}{L} \cdot G \cdot G_u \cdot (\dot{e}(t) + \gamma e(t)) \end{aligned} \quad (24)$$

and (18) becomes:

$$\begin{aligned} u(t) &= u(t^-) + \frac{H \cdot G \cdot G_u}{L} \cdot (\dot{e}(t) + \gamma e(t)), \\ \forall [t, e_0, y_d, d(\cdot)] &\in R_\tau \times E_I \times S_y \times S_d. \end{aligned} \quad (25)$$

If there is no delay in the feedback loop then $u(t) = u(t^-)$, Grujić [18-22] and following (25) one gets:

$$\frac{H}{L} \cdot G \cdot G_u \cdot (\dot{e}(t) + \gamma e(t)) = 0. \quad (26)$$

Since $G > 0$ and $G_u > 0$, the following equation is obtained:

$$\begin{aligned} \dot{e}[t; e_0; u(\cdot), y_d(\cdot), d(\cdot)] &= -\gamma e(t), \\ \forall [t, e_0, y_d(\cdot), d(\cdot)] &\in R_\tau \times E_I \times S_y \times S_d \end{aligned} \quad (27)$$

which, based on $\gamma \in [\beta, +\infty[$ and the condition (7) of the Theorem 1 in scalar case, proves this theorem.

6. SYSTEM DESCRIPTION

The hydraulic servosystem is shown in Figure 5. The basic parts of the electrohydraulic servosystem are: 1 – hydraulic power supply; 2 – accumulator; 3 – charge valve; 4 – pressure gauge device; 5 – filter; 6 – electrohydraulic servovalve; 7 – hydraulic cylinder; 8 – potentiometer; 9 – personal computer; 10 – U/I converter.

The electrohydraulic servovalve is two-stage with force feedback. Hydraulic cylinder characteristics are:

- piston diameter, 50 mm;
- rod diameter, 32 mm;
- piston pitch, 200 mm.

The nonlinear mathematical model of the hydraulic position servosystem, which includes influences of

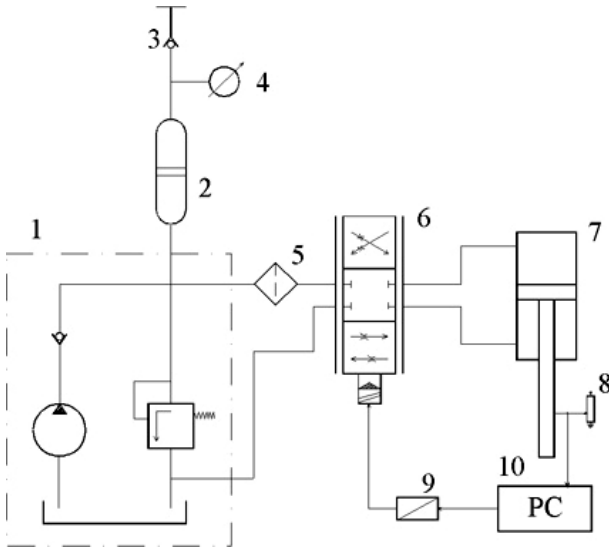

Figure 5. The electrohydraulic servosystem

Coulomb friction and linear viscous friction, in the form of the state and output equations, is given as [26]:

$$\begin{aligned} \dot{x}_1 &= x_2, \\ \dot{x}_2 &= \frac{1}{M_t} \{ A_1 x_3 - A_2 x_4 - \delta_0 x_2 - \delta_1 \operatorname{sgn} x_2 - F_L \}, \\ \dot{x}_3 &= \frac{\beta_e}{V_{10} + A_1 x_1} \left\{ -A_1 x_2 - C_{im} (x_3 - x_4) + \right. \\ &+ C_d x_5 \sqrt{\frac{1}{\rho} \left((P_S - x_3)(1 + \operatorname{sign} x_5) + x_3(1 - \operatorname{sign} x_5) \right)} \left. \right\}, \\ \dot{x}_4 &= \frac{\beta_e}{V_{20} - A_2 x_1} \left\{ A_2 x_2 + C_{im} (x_3 - x_4) - \right. \\ &- C_d x_5 \sqrt{\frac{1}{\rho} \left(x_4(1 + \operatorname{sign} x_5) + (P_S - x_4)(1 - \operatorname{sign} x_5) \right)} \left. \right\}, \\ \dot{x}_5 &= \frac{1}{T_r} \left\{ -x_5 + \frac{K_r}{K_q} u \right\}, \\ y &= x_1, \end{aligned} \quad (28)$$

where: $x_1 = X_p$ – displacement of piston [m], $x_2 = \dot{X}_p$ – velocity of piston [m/s], $x_3 = P_1$ – pressure in the cylinder [Pa], $x_4 = P_2$ – pressure in the cylinder [Pa], and $x_5 = X_v$ – valve displacement [m], are elements of the state vector for hydraulic position servosystem, and: $x_1 = F_L$ is disturbance (load force on piston) [N], $M_t = 2.6$ kg is total mass of piston, $A_1 = 1.96 \cdot 10^{-3}$ m² is large area of piston, $A_2 = 1.16 \cdot 10^{-3}$ m² is small area of piston,

$\delta_0 = 770$ Ns/m is viscous damping coefficient, $\delta_1 = 16$ N is internal friction coefficient, $V_{10} = V_{20} = 1.75 \cdot 10^{-4}$ m³ is initial volume of both chambers, $\beta_e = 1.4 \cdot 10^9$ Pa is oil bulk modulus, $C_d = 0.61$ is dimensionless damping coefficient, $C_{im} = 1.69 \cdot 10^{-12}$ m³/Pas is internal or cross-port leakage coefficient, $\rho = 850$ kg/m³ is oil density, $P_S = 10^7$ Pa is supply pressure, $T_r = 0.01$ s is valve time constant, $K_r = 0.001588$ m³/sV is valve gain, and $K_q = 1.44$ m²/s is valve flow gain.

7. SIMULATION RESULTS

The configuration of the closed-loop control system with the proposed fuzzy practical tracking algorithm is shown in Figure 6, where *Plant* is the given process to be controlled, in our case electrohydraulic servosystem.

Let the set of permitted outputs be given by:

$$S_y = \{ y : 0.04 \text{ m} \leq y \leq 0.16 \text{ m} \}, \quad (29)$$

and let the time varying desired outputs $y_d(t)$ be given as in Figure 8, with the initial value $y_{d0} = 0.08$ m.

The bounds of the admitted output error are prespecified by the sets of errors (E_I – initial, E_A – actual) as follows:

$$\begin{aligned} E_I &= \{ e_0 : -0.04 \text{ m} \leq e_0 \leq 0.04 \text{ m} \}, \\ E_A &= \{ e(t) : -0.04 \text{ m} \leq e(t) \leq 0.04 \text{ m} \}. \end{aligned} \quad (30)$$

The set of allowable controls is:

$$S_u = \{ u : -5 \text{ V} \leq u \leq 5 \text{ V} \}, \quad (31)$$

and the estimated set of disturbances may be given as:

$$S_d = \{ d : -1000 \text{ N} \leq d \leq 1500 \text{ N} \}. \quad (32)$$

The change load force F_L on cylinder is shown in Figure 7.

Finally, the time set and scalars α and β from Definition 1 are determined as:

$$\tau = 20 \text{ s}, R_\tau = [0, 20[, \alpha = 1, \beta = 0.51/\text{s}. \quad (33)$$

The digital computer simulation is carried out with parameters:

$$\gamma = 1, G = 2, G_u = 0.25, L = 1, H = 1. \quad (34)$$

Simulation results are shown in Figures 8, 9 and 10. The change disturbance (force F_L) shown in Figure 7 is quite unusual, but it has been adopted to illustrate the effectiveness of disturbance compensation. Simulation

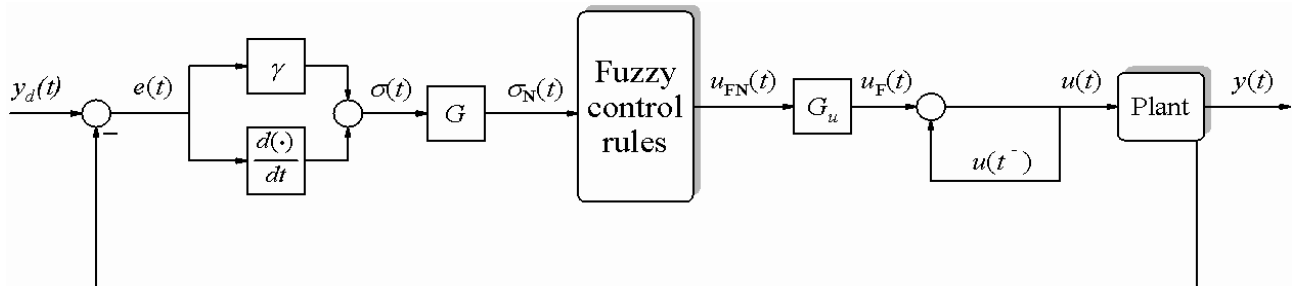

Figure 6. Symbolic block diagram of the system

results show that the proposed fuzzy practical tracking control algorithm provides high tracking quality with action of disturbance. From Figure 9 it can be seen that the exponential error change $e(t)$ is in permitted boundaries $e_0 e^{-\beta t}$.

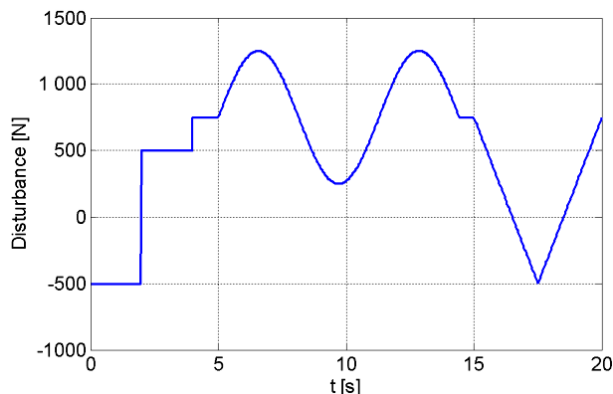

Figure 7. Change of load force on cylinder

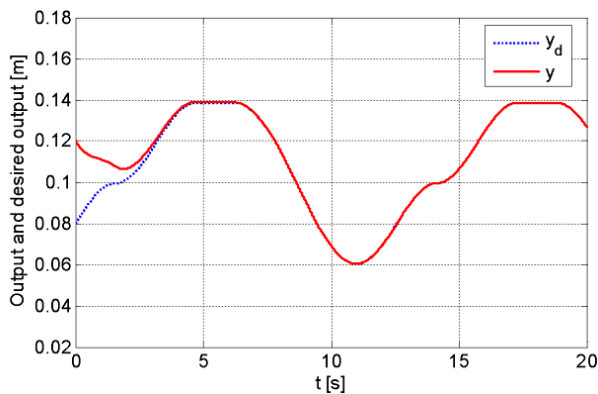

Figure 8. The output and desired output

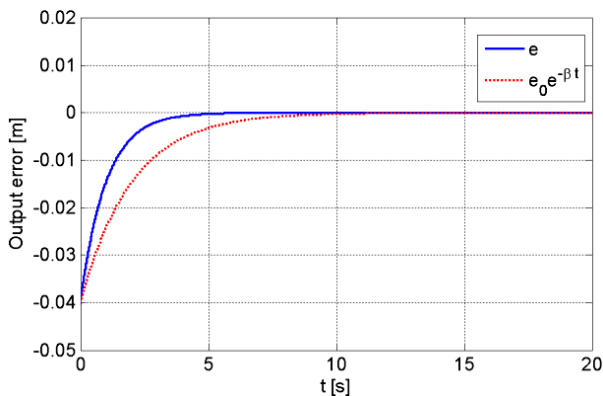

Figure 9. The tracking error

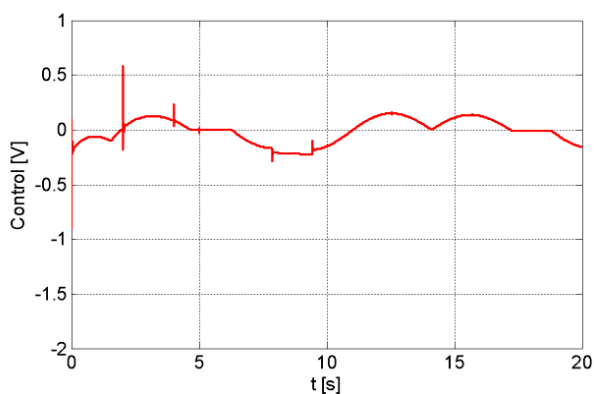

Figure 10. The control signal

It is clear that this fuzzy controller has a linear structure in the input variable $\sigma_N(t)$. The parameters G and G_u are used to exploit the full range of the input or output universe.

G can be selected in such a way that the normalized input variable $\sigma_N(t)$ almost covers the entire domain $[-L;L]$ to make efficient use of the rule base. Then G_u is to be tuned to achieve the desired tracking quality. On the other hand, if $u(t) \in [-U_{\max}, U_{\max}]$, then G_u can be U_{\max}/H , and G is used for tuning the output response.

8. CONCLUSION

A new fuzzy control algorithm based on the concept of practical tracking has been presented in this paper. The fuzzy logic controller, which is a part of the algorithm, is one of the simplest. This algorithm requires only one input variable which is a combination of the signal of error and the first derivation of error, while internal dynamics of the electrohydraulic servosystem need not be known. Based on the existing definitions, the new fuzzy algorithm that ensures practical exponential tracking has been proven by the appropriated choice of the structure of the fuzzy logic controller and with the assumption that there is no delay in the local positive feedback loop. The simulation results show the high quality of fuzzy practical exponential control. The proposed algorithm has linear structure in the input signals. Future research will focus on the nonlinear fuzzy tracking algorithms.

REFERENCES

- [1] Merritt, H.E.: *Hydraulic Control Systems*, John Wiley and Sons, New York, 1967.
- [2] Khalil, H.K.: *Nonlinear Systems*, Prentice-Hall, Upper Saddle River, 1996.
- [3] Hwang, G.-C. and Lin, S.-C.: A stability approach to fuzzy control design for nonlinear systems, *Fuzzy Sets and Systems*, Vol. 48, No. 3, pp. 279-287, 1992.
- [4] Wang, W.-J. and Lin, H.-R.: Fuzzy control design for the trajectory tracking on uncertain nonlinear systems, *IEEE Transactions on Fuzzy Systems*, Vol. 7, No. 1, pp. 53-62, 1999.
- [5] Mizumoto, M.: Realization of PID controls by fuzzy control methods, *Fuzzy Sets and Systems*, Vol. 70, No. 2-3, pp. 171-182, 1995.
- [6] Malki, H.A., Huaidong, Li. and Guanrong, C.: New design and stability analysis of fuzzy proportional-derivative control systems, *IEEE Transactions on Fuzzy Systems*, Vol. 2, No. 4, pp. 245-254, 1994.
- [7] Filev, D.P. and Yager, R.R.: On the analysis of fuzzy logic controllers, *Fuzzy Sets and Systems*, Vol. 68, No. 1, pp. 39-66, 1994.
- [8] Ying, H., Siler, W. and Buckley, J.J.: Fuzzy control theory: A nonlinear case, *Automatica*, Vol. 26, No. 3, pp. 513-520, 1990.
- [9] Ying, H.: The simplest fuzzy controllers using different inference methods are different nonlinear proportional-integral controllers with variable

- gains, *Automatica*, Vol. 29, No. 6, pp. 1579-1589, 1993.
- [10] Ying, H.: A nonlinear fuzzy controller with linear control rules is the sum of a global two-dimensional multilevel relay and a local nonlinear proportional-integral controller, *Automatica*, Vol. 29, No. 2, pp. 499-505, 1993.
- [11] Ying, H.: *Fuzzy Control and Modeling: Analytical Foundations and Applications*, IEEE Press, New York, 2000.
- [12] Ying, H.: A general technique for deriving analytical structure of fuzzy controllers using arbitrary trapezoidal input fuzzy sets and Zadeh AND operator, *Automatica*, Vol. 39, No. 7, pp. 1171-1184, 2003.
- [13] Grujić, Lj.T.: Stability versus tracking in automatic control systems, in: *Proceedings of the Conference JUREMA 29, Part 1*, April 1984, Zagreb, Croatia, pp. 1-4, (in Serbian).
- [14] Grujić, Lj.T.: Tracking with prespecified performance index limits: Control synthesis for non-linear objects, in: *Proceedings of the 2nd International Seminar and Symposium: Automaton and Robot*, 27-29.10.1987, Belgrade, Serbia, pp. S20-S52.
- [15] Grujić, Lj.T.: Tracking versus stability: Theory, in: *Proceedings of the 12th World Congress on Scientific Computation IMACS, Vol. 1*, 18-22.07.1988, Paris, France, pp. 319-327.
- [16] Grujić, Lj.T.: Tracking control obeying prespecified performance index, in: *Proceedings of the 12th World Congress on Scientific Computation IMACS, Vol. 1*, 18-22.07.1988, Paris, France, pp. 332-336.
- [17] Lazić, D.V.: *Analysis and Synthesis of Automatic Practical Tracking Control*, PhD thesis, Faculty of Mechanical Engineering, University of Belgrade, Belgrade, 1995, (in Serbian).
- [18] Grujić, Lj.T. and Mounfield Jr., W.P.: Natural tracking PID process control for exponential tracking, *American Institute of Chemical Engineers Journal*, Vol. 38, No. 4, pp. 552-562, 1992.
- [19] Mounfield Jr., W.P. and Grujić, Lj.T.: Natural tracking control for exponential tracking: Lateral high-gain PI control of an aircraft system with state-space description, *Neural, Parallel & Scientific Computations*, Vol. 1, No. 3, pp. 357-370, 1993.
- [20] Mounfield Jr., W.P. and Grujić, Lj.T.: High-gain PI natural tracking control for exponential tracking of linear MIMO systems with state-space description, *International Journal of Systems Science*, Vol. 25, No. 11, pp. 1793-1817, 1994.
- [21] Grujić, Lj.T. and Mounfield, W.P.: Natural PD exponential tracking control: State-space approach to linear systems, in: *Proceedings of the Cairo Third IASTED International Conference Computer Applications in Industry*, 26-29.12.1994, Cairo, Egypt, pp. 432-435.
- [22] Mounfield, W.P. and Grujić, Lj.T.: Natural PD exponential tracking control. Part II: Computational resolutions, in: *Proceedings of the Cairo Third IASTED International Conference Computer Applications in Industry*, 26-29.12.1994, Cairo, Egypt, pp. 436-439.
- [23] Jovanović, R.Ž.: *Application of the Fuzzy Logic in Control Systems*, MSc thesis, Faculty of Mechanical Engineering, University of Belgrade, Belgrade, 1999, (in Serbian).
- [24] Jovanović, R.Ž.: Fuzzy control of an electrohydraulic servosystem based on the natural tracking control, in: *Proceedings of the 44th Conference ETRAN*, 26-29.06.2000, Soko Banja, Serbia, pp. 370-373, (in Serbian).
- [25] Ribar, Z., Jovanović, R.Ž. and Sekulić, D.: Fuzzy control of a hydraulic servosystem based on practical tracking algorithms, in: Burrows C.R. and Edge, K.A. (Eds.): *Power Transmission and Motion Control (PTMC 2000)*, Professional Engineering Publishing, London, pp. 73-87, 2000.
- [26] Čebašek, N.: *Control of Pneumatic and Hydraulic Cylinders Using Unconventional Control Algorithms*, MSc thesis, Faculty of Mechanical Engineering, University of Belgrade, Belgrade, 1996, (in Serbian).

ФАЗИ ПРАКТИЧНО ЕКСПОНЕНЦИЈАЛНО ПРАЋЕЊЕ ЕЛЕКТРОХИДРАУЛИЧКОГ СЕРВОСИСТЕМА

Радиша Ж. Јовановић, Зоран Б. Рибар

Циљ овог рада је да допринесе теоријској и практичној примени фази логичког управљања коришћењем концепта практичног праћења. Предлаже се нови фази управљачки алгоритам за остваривање жељеног квалитета праћења једног електрохидрауличног позиционог сервосистема, који се може наћи у многим индустријским уређајима. Фази логички контролер је један од најједноставнијих. Он користи само једну улазну величину, са линеарном методом закључивања. Фази праћећи алгоритам управљања је заснован на принципу самоприлагодљивости. Структурна карактеристика таквог система управљања је постојање две повратне спреге: глобалне, негативне по излазној величини и локалне, позитивне по управљачкој величини. Таква структура обезбеђује синтезу управљања без познавања унутрашње динамике објекта и без мерења поремећајних величина. Предложени фази праћећи алгоритам управљања обезбеђује промену грешке излазне величине по унапред дефинисаном експоненцијалном закону. Презентују се резултати симулације нелинеарног математичког модела хидрауличног сервосистема.