

A Methodological Approach to Evaluate Seismic Vulnerability of Masonry Cathedrals

Original

A Methodological Approach to Evaluate Seismic Vulnerability of Masonry Cathedrals / Aoki, Takayoshi; Sabia, Donato; Rovesti, Manuel. - In: INTERNATIONAL JOURNAL OF ARCHITECTURAL HERITAGE. - ISSN 1558-3058. - ELETTRONICO. - (2022), pp. 1-19. [10.1080/15583058.2022.2152763]

Availability:

This version is available at: 11583/2974027 since: 2022-12-21T15:53:43Z

Publisher:

Taylor & Francis

Published

DOI:10.1080/15583058.2022.2152763

Terms of use:

openAccess

This article is made available under terms and conditions as specified in the corresponding bibliographic description in the repository

Publisher copyright

(Article begins on next page)

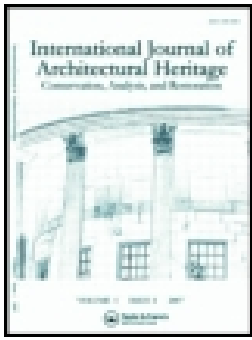

International Journal of Architectural Heritage

Conservation, Analysis, and Restoration

ISSN: (Print) (Online) Journal homepage: <https://www.tandfonline.com/loi/uarc20>

A Methodological Approach to Evaluate Seismic Vulnerability of Masonry Cathedrals

Takayoshi Aoki, Donato Sabia & Manuel Rovesti

To cite this article: Takayoshi Aoki, Donato Sabia & Manuel Rovesti (2022): A Methodological Approach to Evaluate Seismic Vulnerability of Masonry Cathedrals, International Journal of Architectural Heritage, DOI: [10.1080/15583058.2022.2152763](https://doi.org/10.1080/15583058.2022.2152763)

To link to this article: <https://doi.org/10.1080/15583058.2022.2152763>



© 2022 The Author(s). Published with license by Taylor & Francis Group, LLC.



Published online: 18 Dec 2022.



Submit your article to this journal [↗](#)



View related articles [↗](#)



View Crossmark data [↗](#)

A Methodological Approach to Evaluate Seismic Vulnerability of Masonry Cathedrals

Takayoshi Aoki^a, Donato Sabia^b, and Manuel Rovesti^c

^aGraduate School of Design and Architecture, Nagoya City University, Nagoya, Japan; ^bDepartment of Structural, Geotechnical and Building Engineering, Politecnico di Torino, Turin, Italy; ^cMaffei Engineering S.p.A., Solagna, VI, Italy

ABSTRACT

The seismic analysis of historical and monumental masonry buildings, especially churches and cathedrals, is challenging and expensive. These difficulties are mainly related to complex geometry and the mechanical modelling of historic masonry structures. This paper aims to show the methodological approach to evaluate the seismic vulnerability of Masonry Cathedrals by modelling seismic analysis. The numerical finite element model, modelled with solid elements, was optimised based on identifying the primary dynamic properties performed in ambient and seismic excitations recorded by a continuous dynamic monitoring system in operation since 2015. We carried out linear dynamic analyses for the optimised model of the entire structure. We also carried out non-linear dynamic analyses for the vaults, where damage concentrations were detected after various seismic events. The linear dynamic analysis of the optimised entire structural model aimed to estimate the time histories of acceleration at the connection areas between the vaults to the vertical structures. The numerical analysis results were consistent with the damage maps identified for the actual structure. Furthermore, the numerical model and the analysis procedure showed an excellent ability to reproduce the accurate structural response.

ARTICLE HISTORY

Received 28 July 2022
Accepted 22 November 2022

KEYWORDS

Masonry cathedral; modelling; Modena cathedral; seismic assessment; structural monitoring; world heritage building

1. Introduction

The Italian cultural heritage is represented by a historical structure built mainly in ancient masonry with a high state of deterioration. In order to preserve these structures for future generations, it is essential to study their structural behaviour from the seismic point of view.

Settlements, earthquakes, and other problems encountered over the years have led to the realisation of structural reinforcement interventions, thus generating variability in the characteristics of the building materials (Lancellotta 2009). In addition, the geometrical irregularities of the structural elements, the different materials used over the years, the degree of connection between the perimeter walls, and the deterioration of the materials complicate the study of the safety level.

Thus, in situ materials testing can reduce the uncertainties characterising each structure. However, it is impossible to achieve destructive tests in some cases as these structures are often part of the UNESCO heritage. Therefore, as reported in “*Linee Guida per la valutazione e riduzione del rischio sismico del patrimonio culturale allineate alle nuove Norme tecniche per le costruzioni (d. m. 14 gennaio 2008)*” (MiC (Ministero della Cultura

2011), it is impossible to remove part of them to carry out mechanical tests. Therefore, the most efficient method for knowing the structure’s dynamic behaviour is monitoring with measurement systems such as accelerometers (Lancellotta and Sabia 2013, Di Tomasso et al. 2013; Caselles et al. 2015).

Masonry buildings, in general, show horizontal structures at regular intervals along the height and, if they are sufficient stiffness in their plane, give a box-like behaviour entrusted the ability to resist seismic action. Churches, on the contrary, have an intrinsic atypically due to the presence of tall and slender walls with very weak interconnections that are difficult to quantify, long and wide naves and very slender columns. These characteristics make the structures difficult to schematise or refer to simple standard schemes. The ‘Italian Guidelines’ for Cultural Heritage suggest a conventional approach based on identifying partial failure mechanisms (Macro-elements) and assessing ultimate capacity by applying the kinematic theorem of limit analysis (MiC (Ministero della Cultura) 2011). The definition of macro-elements is not a straightforward task that relies on the experience of operators and/or the



Figure 1. 3D view of the Modena Cathedral (Google Maps images 2019)

analysis of damage detected due to past seismic events. The cited guidelines provide a list of 28 possible macro-elements. In recent years, some authors have proposed simplified pre-analyses to define macro-elements. (Milani and Valente 2015a).

In the literature, there are many works on the reliability of the non-linear static analysis to evaluate the seismic capacity of masonry structures. Di Napoli applied non-linear static analysis (push-over analysis) by mass-proportional load pattern to Santa Maria Maddalena, Ischia (Di Napoli et al. 2021). Endo applied various pushover analyses (mass-proportional, first-mode proportional, first-mode by mass proportional, and adaptive) and non-linear dynamic analysis (NDA) to two simple benchmark case studies (Endo, Pelà, and Roca 2017). The advantages and limitations of each approach were reported by comparing their results. The method with the distribution of horizontal forces proportional to masses appears to provide the best results. In general, it turns out that the push-over analysis underestimates the displacement capacity and shows damage scenarios and failure mechanisms inconsistent with the results of the NDA.

Milani mentioned that the sensitivity study states that such complex structures' seismic vulnerability should be evaluated through different procedures, including standard eigenfrequency approaches and limit and non-linear static analyses. The behaviour factors evaluated through pushover analyses are systematically higher than those provided by the NDA (Milani and Valente 2015b).

An equivalent frame model for in-plane non-linear seismic analysis of masonry buildings has been applied to the Pelella Palace (Casapulla, Maione, and Argiento

2017) and registered as a historical masonry building (Demirlioglu et al. 2018). Nevertheless, it isn't easy to use this method for complex cathedrals.

This paper aims to show the methodological approach to evaluate the seismic vulnerability of Masonry Cathedrals by seismic analysis. As NDA is computationally expensive without a high-performance computer. It is often not applicable to complex, atypical and irregular structures such as large cathedrals. We propose to start with a global finite element model and focus on a regional NDA of the vaults to evaluate the seismic vulnerability of the whole structure. The numerical finite element model, modelled with solid elements, was optimised based on identifying the primary dynamic properties performed in ambient and seismic excitations recorded by a continuous dynamic monitoring system since 2015. We carried out linear dynamic analyses for the optimised model of the entire structure. We also conducted NDA for the vaults, where damage concentrations were detected after various seismic events. The linear dynamic analysis of the optimised entire structural model aimed to estimate acceleration time histories at the connection areas between the vaults to the vertical structures. The numerical analysis results were consistent with the damage maps identified for the actual structure. Furthermore, the numerical model and the analysis procedure showed an excellent ability to reproduce the accurate structural response.

2. Modena cathedral

Modena Cathedral constitutes one of the most significant pieces of Romanesque culture in Europe (Figure 1). Since 1997 it has become part of the World Heritage in the UNESCO cultural, historical, artistic, and environmental sites list.

The construction of the Modena Cathedral began in 1099 by the architect Lanfranco with the subsequent collaboration of the sculptor Wiligelmo and continued by the Campionesi masters. Finally, in 1319, the construction was completed. Next to the Cathedral is the Ghirlandina, the bell tower over 86 meters high, a symbol of the city of Modena.

The main dimensions of the Cathedral are 25 m wide and 66 m long in plan, and the highest point of the roof is about 23 m. It consists of three naves, each one ending with an apse and without a transept. The presbytery and the choir locate above the crypt. The vaults of the central nave and the aisles rest on the pillars and columns, respectively. The central nave and aisles consist of four-span vaults of approximately 9×10 m and eight-span vaults of 5×5 m in the plan, respectively.

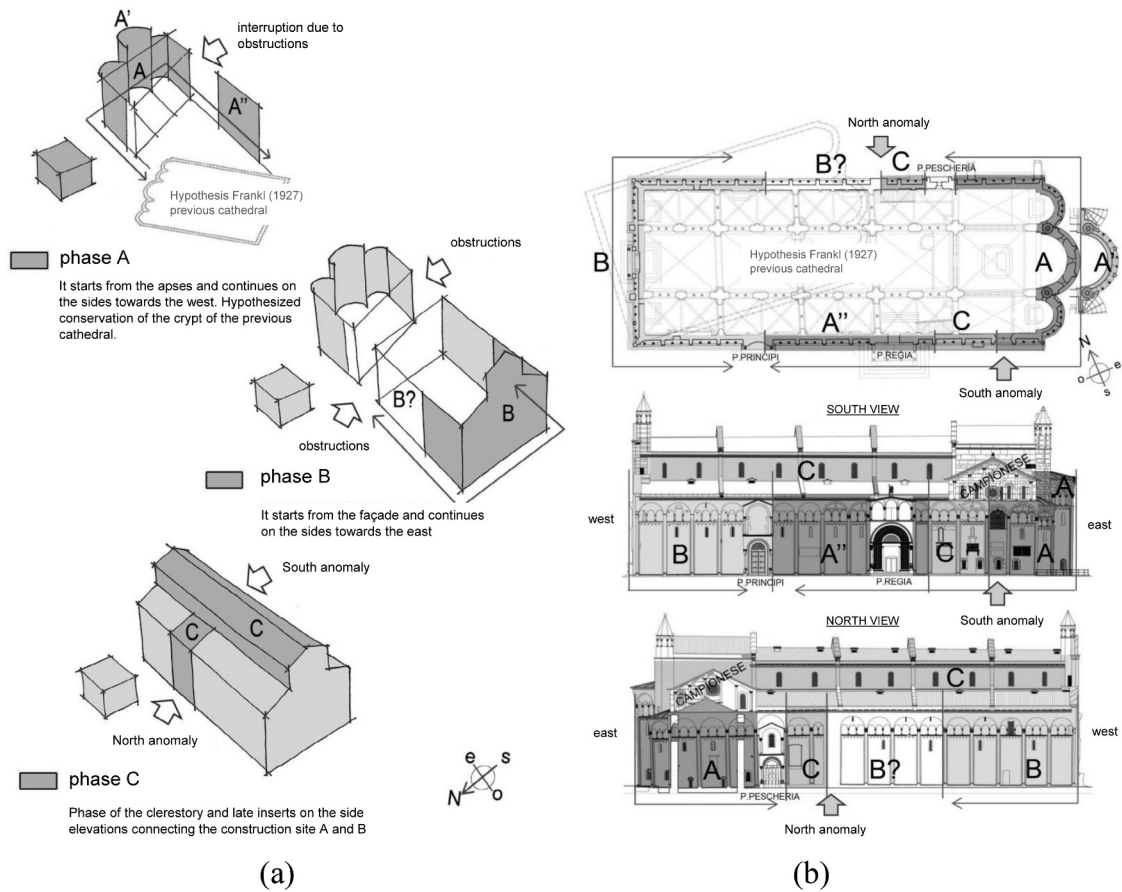

Figure 2. State of the art on construction phases (Modified from Di Francesco et al. 2021). (a) diagram of the division into stages proposed by Peroni (Peroni 1989) in continuity with the idea of Porter in 1927; (b) illustrative revision of the phases division according to G. Palazzi's drawings (Armandi 1999; Peroni 1989).

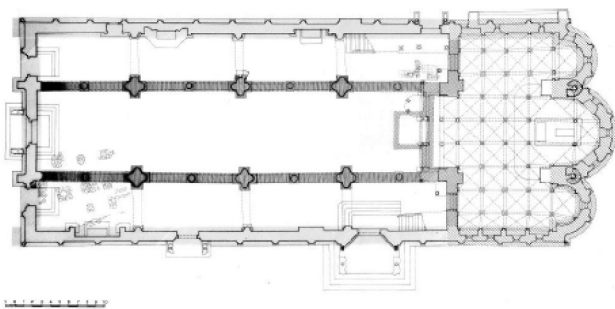

Figure 3. Experimental reconstructive scheme of the foundation (Modified from Di Francesco et al. 2021).

2.1. Construction phases

Learning the cathedral construction phases evolution is fundamental to knowing the materials used and identifying the principal structural elements. It is also essential to observe damage, crack patterns, and past maintenance interventions conducted on buildings to have a complete and in-depth view of the structural behaviour. These analyses are essential in the case of Modena Cathedral for its construction history in different phases

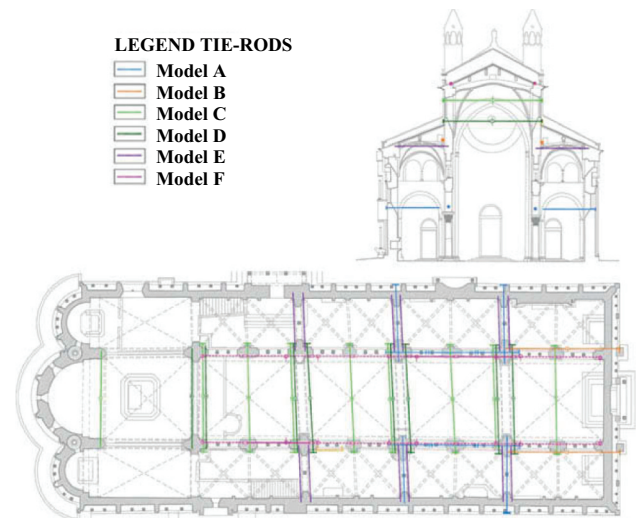

Figure 4. Tie-rods position (in blue dotted the chains added thanks to the inspections) (Modified from Di Francesco et al. 2021).

up to the modifications such as gradual insertion of chains, inversion of the roof frame, support placed in

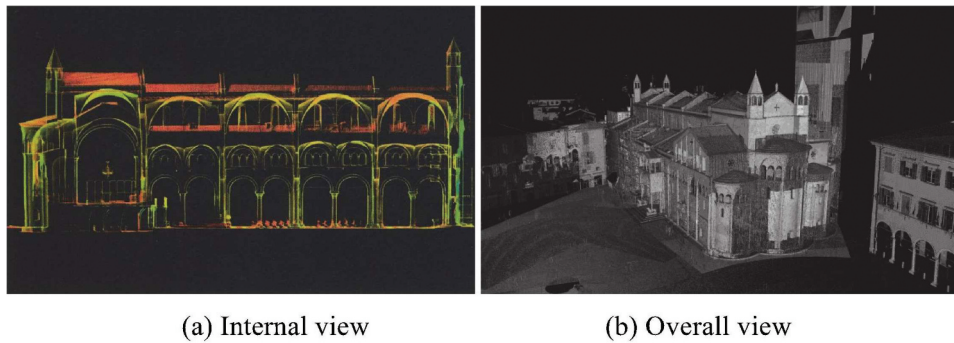

Figure 5. Point cloud model of the Cathedral (Modified from Di Francesco et al. 2021).

adherence with internal and external walls, and post-earthquake consolidation operations made over time.

Studying the settlements and the constituent anomalies of the fronts, the hypotheses previously supported by the researchers have been re-evaluated by E. Silvestri (Silvestri 2013). In addition, she introduced a new perspective that has not been studied on the differential settlement that the structure has suffered since its construction.

Several historians studied the subject in the early 20th century. Arthur Kingsley Porter (Porter 1917) argued that two construction sites existed, beginning with the apse and facade. It is due to the maintenance of the old cathedral part where the remains of the protector

St. Geminiano were kept. Peroni (Peroni 1985) also supports the hypothesis of two opposing building sites due to the various asymmetries and irregularities. Peroni and Lomartire studied the sculptural apparatus and the wall facing and identified three construction phases (Peroni 1985):

- *Phase A*: identified the first primary construction site that began in 1099 from the apses and proceeded to the west;
- *Phase B*: identified the second large construction site that started around 1106 from the facade and then proceeds on the east sides, raising part of the aisles. Wiligelmo's activity is placed in this phase;

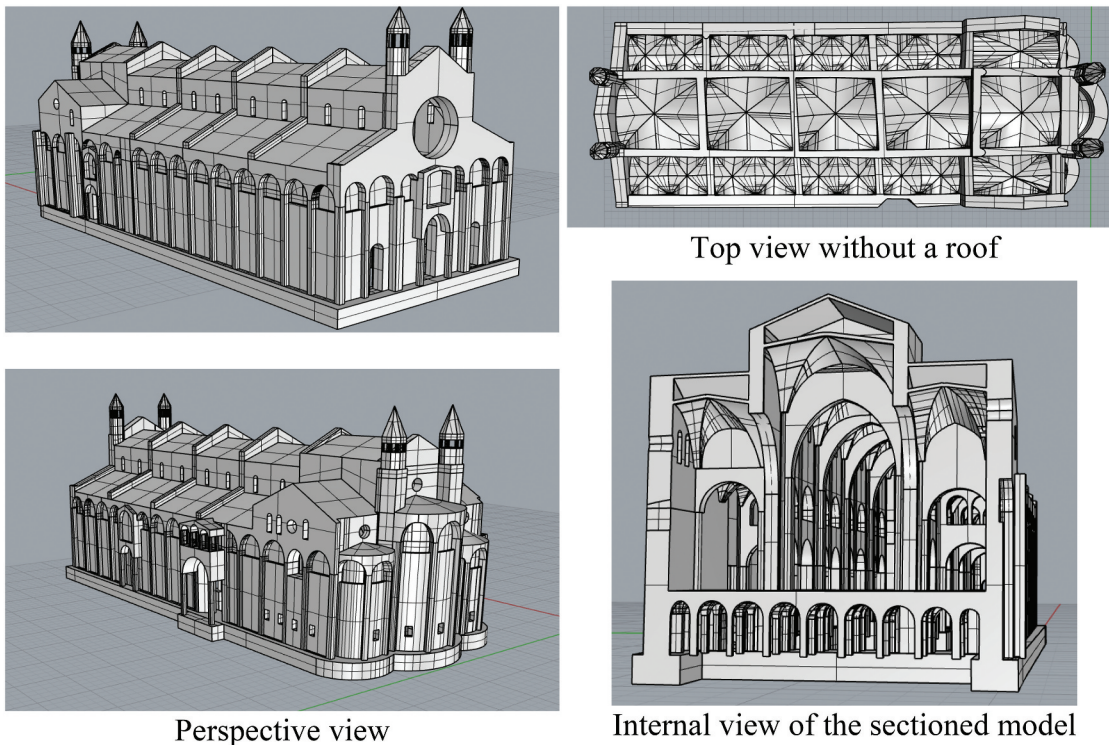

Figure 6. 3D geometric model on Rhinoceros.

- *Phase C*: dated around 1130, is the phase of completions, connections, and anomalies.

Peroni supported Porter's hypothesis, reinforcing the idea of two building sites and maintaining that phase A, the apse, is represented by the figure of Lanfranco. In contrast, phase B, the facade, is represented by Figure 2 of Wiligelmo (Peroni 1985). Thus, historians influenced by a vision of two opposing artistic poles, Architecture and Sculpture, assume this paper.

Information on the foundation of the Cathedral was found in the document created by the Department of Civil, Environmental and Materials Engineering, University of Bologna (Silvestri et al. 2015). The foundation of the Cathedral has a perimeter continuity of 1.20 m thick. At the same time, there is no transverse beam connection at the foundation level between the perimeter walls and the colonnades and between the latter two.

The excavations of 1913 suggest the presence of two colonnade foundations. In addition, 1919's excavation revealed a transversal foundation in front of the nave foundation, corresponding to the delimitation between the choir and the crypt (Figure 3).

A tie-rod system has been installed to prevent structural damage from earthquakes. This system allows the structure behaves as close to a box structure as possible, avoiding the activation of macro-element collapse mechanisms such as the overturning of the facade or perimeter walls.

The information related to the tie-rods installed in 19 Century was found in the document (Baraccani et al. 2016) and based on inspections made inside the structure. Figure 4 shows the position of the tie-rods used in the model.

3. Structural modelling

The first step needed to describe the behaviour of a structure is to realise the geometric model of the principal structural elements.

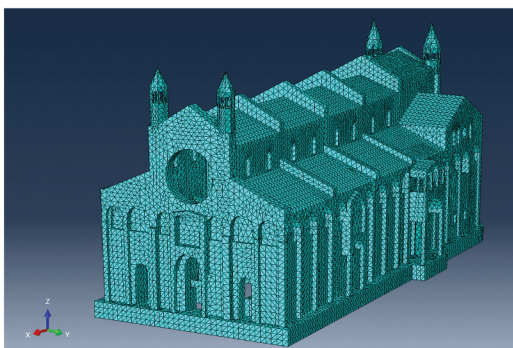

3.1. From the point cloud data to the geometric model

The recent development of 3D scanners and SfM (Structure from Motion) technology has made modelling buildings, including masonry cathedrals, much more convenient (Balado et al. 2021; Chellini et al. 2014; Masciotta et al. 2022). The orthography images of point cloud data obtained with these techniques facilitate the creation of 3D models of buildings and plan, elevation, and section views.

The construction of a FE model of a cathedral has always been a problem, mainly for distinctive elements, inclinations, and curved elements. The geometry of the Cathedral of Modena has many anomalies, and due to the problem of the settlements, the apse has a not negligible vertical inclination. It is essential to consider all these inclinations to have correct structural behaviour, especially in modelling the walls where the vaults will be connected. The vaults are the areas most affected by damage in earthquake events, and they determine some of the main mechanisms of the collapse of macro-elements. On the other hand, the best procedure to consider all these irregularities and speed up the structural model's construction is the use of data from a point cloud acquired with a Laser Scanner.

The point cloud used for modelling the geometry of the Modena Cathedral was acquired by Castagnetti with a terrestrial laser scanner survey, as reported in Castagnetti (Castagnetti, Capra, and Silvestri 2016). The acquisition was carried out with a time-of-flight instrument, model *ScanStation 2* by *Leica Geosystems*. The survey was realised with a resolution of 8 mm, both inside and outside the structure.

Figure 5 shows an internal and external representation of the Cathedral, respectively.

3.2. Geometrical modelling

Suppose TIN (Triangulated Irregular Network) surfaces are created directly from point cloud data to

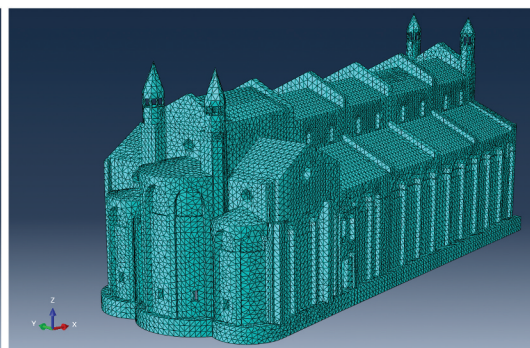

Figure 7. Finite element model of the Modena Cathedral.

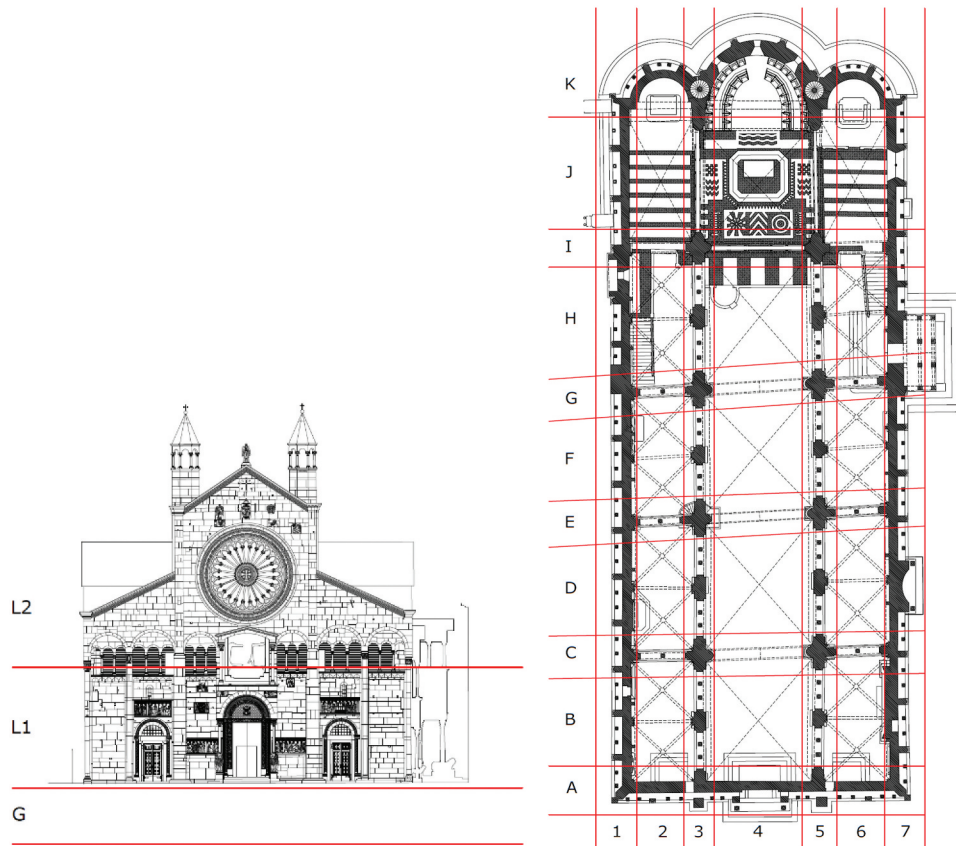

Figure 8. Material ID explanation (Modified from Drawing of Giancarlo Palazzi).

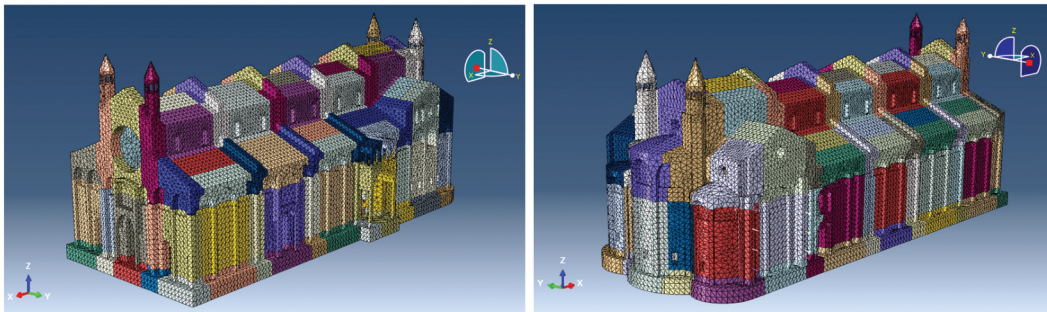

Figure 9. FEA model with the different materials assigned.

make solid elements. In that case, the element shape will be irregular due to the fine irregularities in the point cloud. As a result, the number of nodes and elements becomes larger. Therefore, the geometrical modelling was done by importing the plans and parts of the point cloud into the 3D modelling software Rhinoceros so that the correspondence between the point cloud and the geometric model becomes optimal for the walls, arches, and vaults. [Figure 6](#) shows some views of the model created.

3.3. Structural modelling

The FEM model and the seismic analyses of the Modena cathedral were implemented with the ABACUS/CAE software (Simulia 2006).

Due to the complex geometry of the arches, vaults and wall thicknesses, the structure was modelled with CED 4-node tetrahedral solid elements.

Since 4-node first-order elements tend to overestimate the stiffness, it would be better to use 10-node

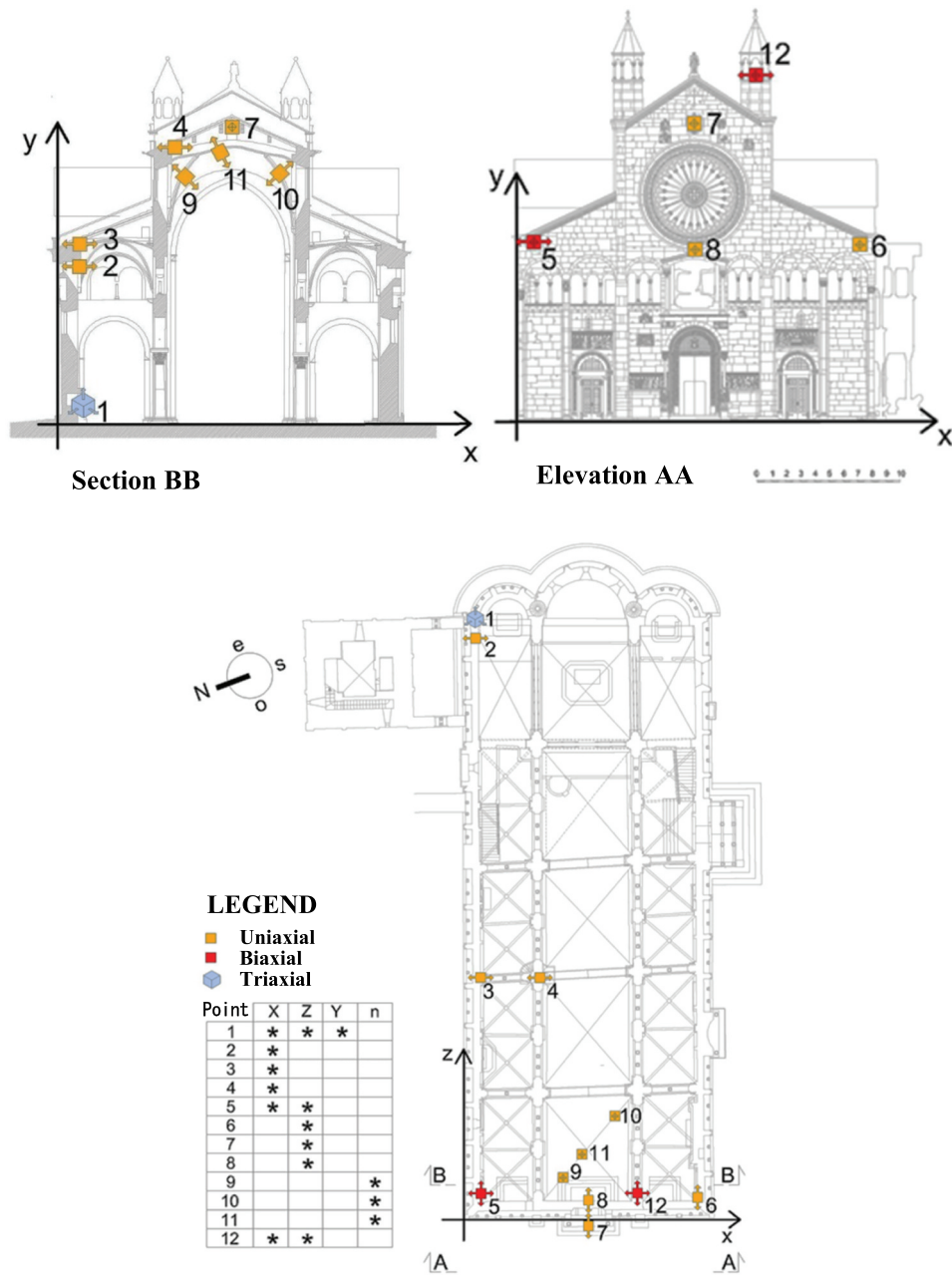

Figure 10. Monitoring positions (Lancellotta and Sabia 2013).

tetrahedral elements. Given the size of the structure in the dynamic analyses, however, computational costs became larger. Therefore 10-node second-order elements were used in the NDA of the vault, being an analysis in which the stress state is the main objective.

Truss elements T3D2 were used to model the tie-rods system. The effect of the arches between the Ghirlandina tower and the cathedral was modelled using truss elements T3D2 (Sabia et al. 2015). First, soil-structure interaction was considered using a continuous model using solid elements and materials with mechanical properties equivalent to the foundation-soil system.

These initial properties were modified by a model update analysis based on dynamic response experiments on the structure. Next, the interaction between the Cathedral and the Ghirlandina Tower was modelled through 8 truss elements. Again, the stiffness of the truss elements was calibrated by comparing the experimental dynamic response to the theoretical ones in the Model Updating Analysis.

The mesh size was selected by considering the dimensions of the main structural elements, avoiding elements that were too small while at the same time minimising distorted elements as much as possible. The average size

of the solid elements was set at 0.7 m by balancing these two criteria. In the end, the finite element model of the Modena Cathedral consists of 79,538 nodes and 304,265 elements, and the DOFs of the model are 231,273. **Figure 7** shows the finite element model of the Modena Cathedral from two different views.

Since material properties are affected by the state of intervention and deterioration over the years, the structure was partitioned into 183 macro elements, each with different properties. The material partitioning of the model is illustrated in **Figures 8 and 9**. Finally, the Model Updating Analysis found a combination of material properties with more realistic structural behaviour.

4. Monitoring system

The monitoring system is necessary for the calibration of the FE model, especially when there are uncertainties in the mechanical masonry parameters. Therefore, using the Model Updating Analysis, it is possible to reduce the error between the analytical model and the actual response

of the structure. The dynamic monitoring system was installed and activated in June 2015 by Nagoya City University and Politecnico di Torino (Lancellotta and Sabia 2015).

4.1. Instrumentation and measuring positions

Monitoring involves the continuous measurement with a sampling frequency of 100 Hz of accelerations in 12 points and temperature in 4 points identified on the structure. The instrumentation installed in the Modena Cathedral consists of 16 servo-type uniaxial accelerometers (frequency range: 0–100 Hz, acceleration range: $\pm 29.42 \text{ m/s}^2$, electrical noise: $\pm 0.000049 \text{ m/s}^2$), four thermocouples, uninterruptible power supply system, National Instruments CompactRIO data acquisition system with 24-Bit Analog Input module.

Accelerometers are arranged individually (uniaxial) or appropriately combined to measure the acceleration component in a plane (biaxial) or space (triaxial) as shown in **Figure 10**.

Table 1. Identified natural frequencies and damping.

Vibration Mode	Frequency (Hz)	Damping
1	1.99	0.0525
2	3.20	0.0331
3	3.41	0.0123

5. Model updating

The structural analysis of a structure requires the knowledge of its real characteristics and the construction of a reliable model that is able to represent the real response, especially for seismic actions. This result can

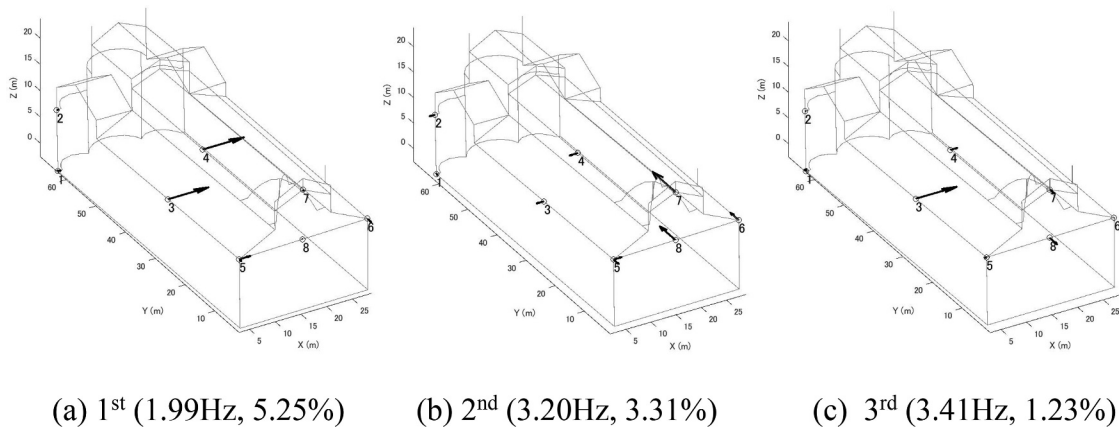

Figure 11. 3D view of the identified mode shapes (Frequency and damping).

Table 2. Results of Model updating.

Mode	Initial model				Updated model			
	Frequency (Hz)		Error (%)	MAC	Frequency (Hz)		Error (%)	MAC
Exp.	Anal.	Exp.			Anal.			
1st	1.99	2.22	11.56	0.96	1.99	1.99	0.00	0.97
2nd	3.20	4.01	25.31	0.73	3.20	3.20	0.00	0.76
3rd	3.41	4.85	42.22	0.94	3.41	3.41	0.00	0.95

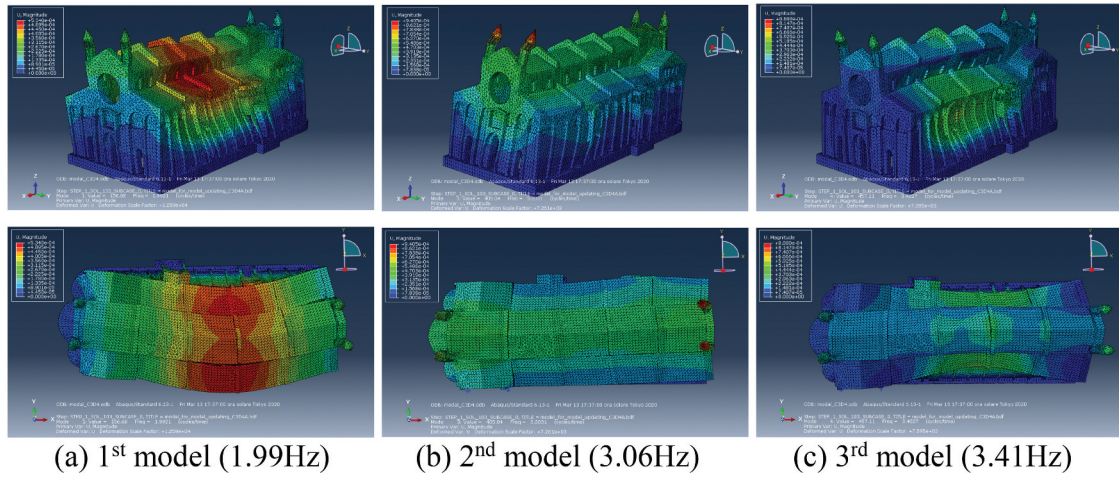

Figure 12. Updated mode shapes.

be obtained through a Model Updating analysis. Model updating aims to minimize the differences between the experimental measurements and the numerical dynamic response of a model (Aoki et al. 2007; Friswell and Mottershead 1995; Sabia et al. 2015).

There are several updating techniques, the one here used is known as the inverse eigensensitivity method (IEM) (Jung and Ewins 1992). It changes specific physical properties, e.g., Young's modulus, density, and damping. Sensitivity-based methods make use of expansions in the Taylor series truncated after the first two terms; this yields a linear approximation that is expressed as follows:

$$\{\Delta w\} = [S] \cdot \{\Delta p\} \quad (1)$$

where, $\{\Delta w\} = \{\Delta \lambda_1, \{\Delta \phi_1\}, \Delta \lambda_2, \{\Delta \phi_2\}, \dots, \Delta \lambda_m, \{\Delta \phi_m\}\}^T$: error in the measured outputs; $\Delta \lambda_i$: error in the i -th eigenvalue; $\{\Delta \phi_i\}$: error in the corresponding mode shape; $\{\Delta p\}$: perturbation in the parameters; $[S]$:

sensitivity matrix containing the first derivatives of the eigenvalues and eigenvectors with respect to the parameters estimated in the previous iteration.

In the expanded form, Eq. (1) becomes:

$$\begin{Bmatrix} \Delta \lambda_r \\ \{\Delta \phi_r\} \end{Bmatrix} = \begin{bmatrix} \frac{\partial \lambda_r}{\partial a_1} / \lambda_{Ar} & \dots & \frac{\partial \lambda_r}{\partial a_l} / \lambda_{Ar} & \frac{\partial \lambda_r}{\partial b_1} / \lambda_{Ar} & \dots & \frac{\partial \lambda_r}{\partial b_l} / \lambda_{Ar} \end{bmatrix} \begin{Bmatrix} \Delta a_1 \\ \vdots \\ \Delta a_l \\ \Delta b_1 \\ \vdots \\ \Delta b_l \end{Bmatrix} \quad (2)$$

The updating parameters, expressed as:

$$\{\Delta r\}_{[(n+1) \times 1]} = [S]_{[(n+1) \times 2L]} \cdot \{\Delta p\}_{[2L \times 1]} \quad (3)$$

the vector $\{p\}$ can be determined through an iterative procedure:

$$\{p\}_{new} = \{p\}_{old} + \{\Delta p\} \quad (4)$$

The estimate of the degree of correlation between the experimental and numerical modal shapes was evaluated through the modal assurance criterion (MAC):

$$MAC_{jk} = \frac{|\phi_{mj}^T \phi_{ak}|^2}{(\phi_{mk}^T \phi_{ak})(\phi_{mj}^T \phi_{aj})} \quad (5)$$

where, ϕ_{mj} : measured mode; ϕ_{aj} : analytical mode.

5.1. Experimental dynamic identification

The dynamic structural identification provides to extract the main dynamic parameters of the structure, such as frequencies, mode shapes, and damping. Dynamic identification was carried out by analysing the monitoring data and applying the "Stochastic Subspace

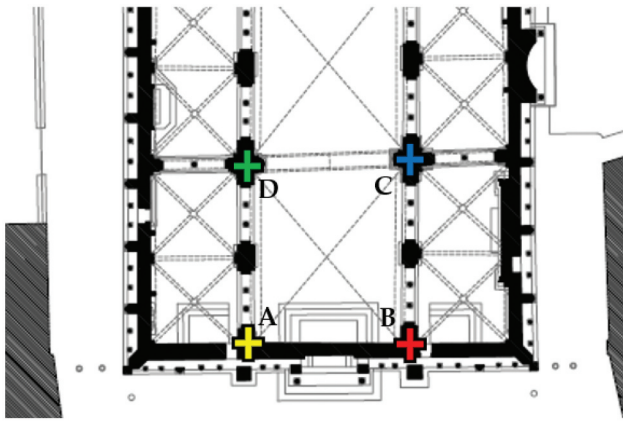
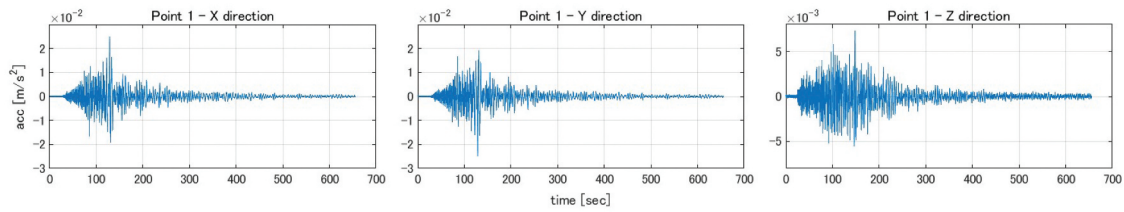
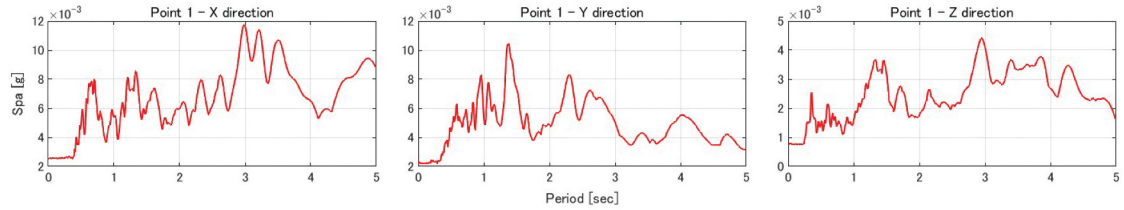

Figure 13. Vault 1. Points of application of the time histories at the base of the vault.



(a) Acceleration time histories



(b) Pseudo acceleration spectra

Figure 14. Acceleration time histories recorded during the earthquake of 24–08–2016 and the pseudo acceleration spectra.

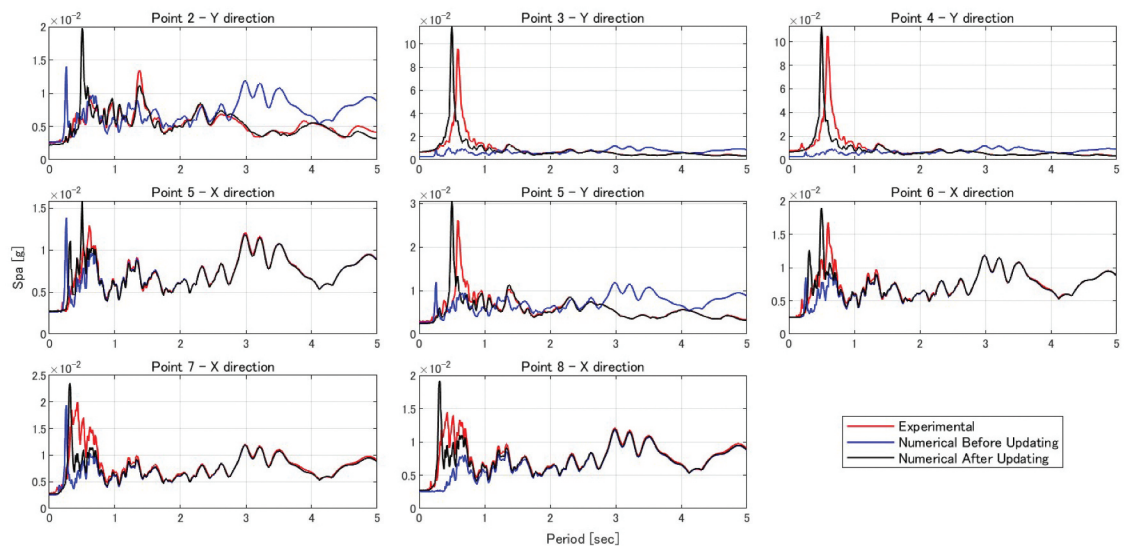

Figure 15. Comparison pseudo acceleration spectrum: Experimental, Initial model, and Updated model.

Identification Method” (Van Overschee and De Moor 1996).

Mainly three vibration modes have been identified, and Table 1 reports the frequencies and damping. The mode shapes are shown in Figure 11..

5.2. Model updating results

The model updating was carried out using the Inverse Eigensensitivity Method (IEM). The model was divided into 183 macro-elements, and each macro-element was associated with parts of the structure with homogeneous material (Figures 8 and 9).

5.2.1. Modal analysis of the initial model

Before adopting the model updating technique, a modal analysis was carried out on the model with the starting material; Young’s modulus 2 GPa, Poisson’s ratio 0.2, and specific mass 2000 kg/m³. Comparing the experimental mode shapes with those of the model was correspondence between them (Aoki, Sabia, and Rivella 2008).

5.2.2. Comparison between the experimental and the initial model data

With both numerical and experimental data, it was possible to compare them. The model updating was carried out by comparing the numerical model’s

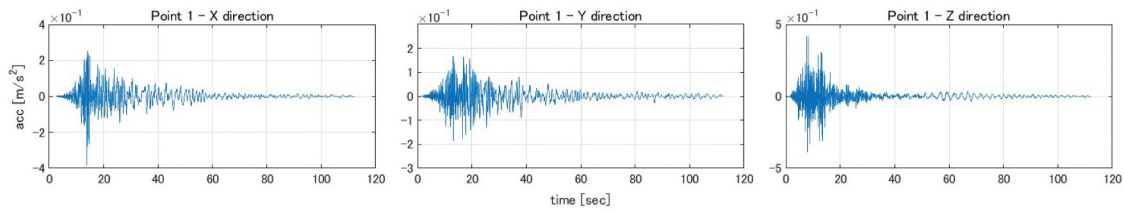

(a) Acceleration time histories

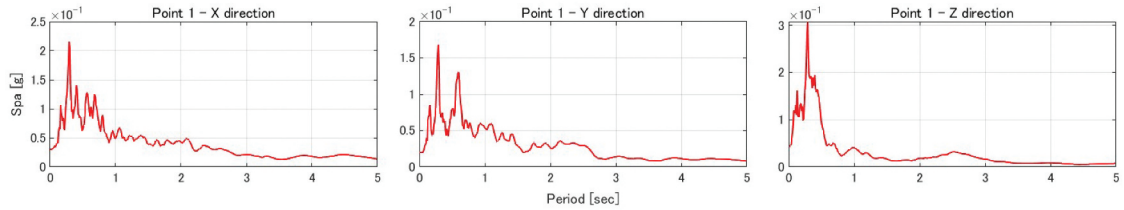

(b) Pseudo acceleration spectra

Figure 16. Acceleration time histories recorded during the earthquake of 29–05–2012 and pseudo acceleration spectra.

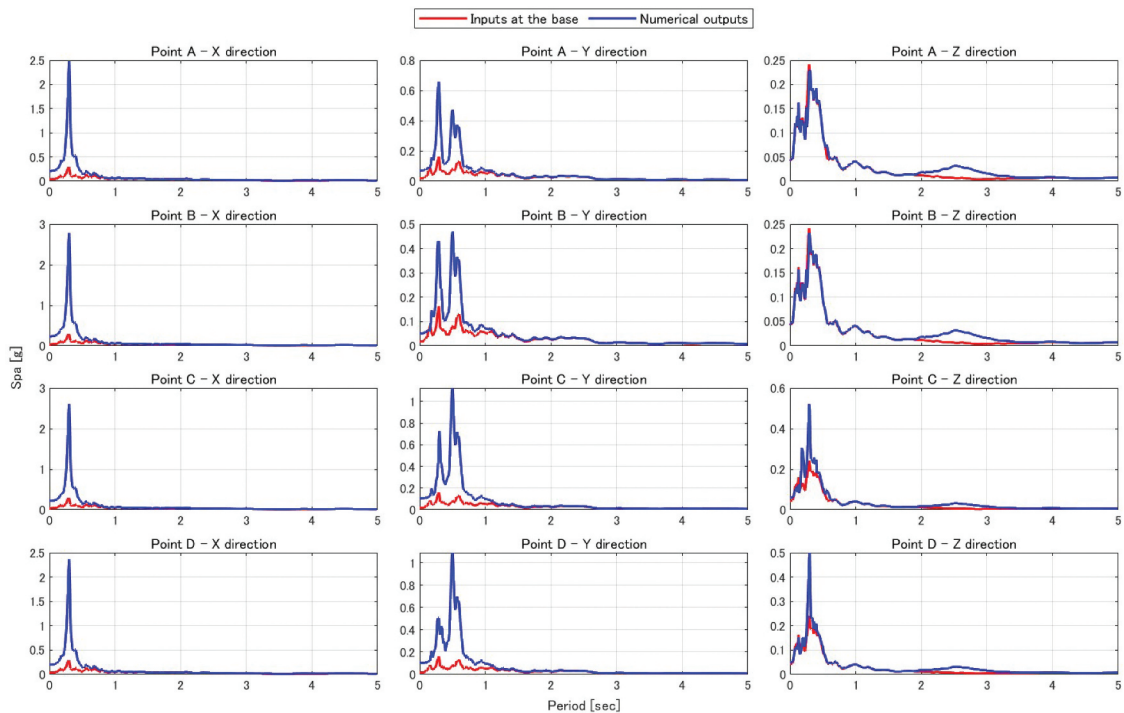

Figure 17. Comparison of input and numerical output of pseudo acceleration spectra.

modes with the corresponding experimental ones. In Table 2, it is possible to observe the remarkable difference between the frequencies.

5.2.3. Updated model

The updating was performed on the model, obtaining exactly all three experimental frequencies. Changing Young's modulus and specific mass of the 183 materials assigned to the structure made it possible to obtain a model

with an overall behaviour close to the actual structure. After the model update, Young's modulus and specific mass varied from 1.04GPa to 3.35GPa and 1229 kg/m³ to 2992 kg/m³, respectively.

The MAC coefficient defines how close the eigenvector of the numerical modal shape is to the experimental one, which is almost equal to 1 for the first and third modes. This means that the two mode shapes are almost coincident. As for

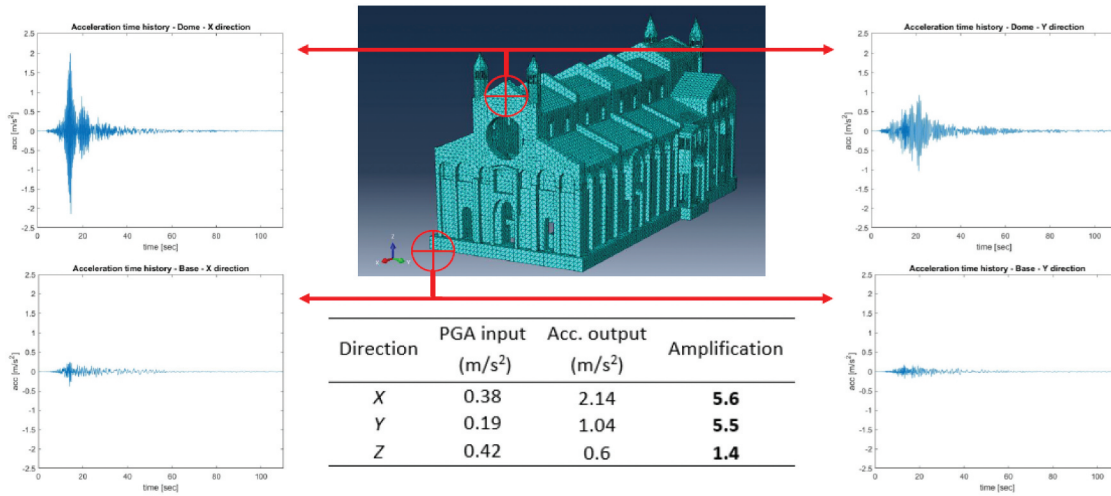

Figure 18. Amplification of input acceleration at the facade.

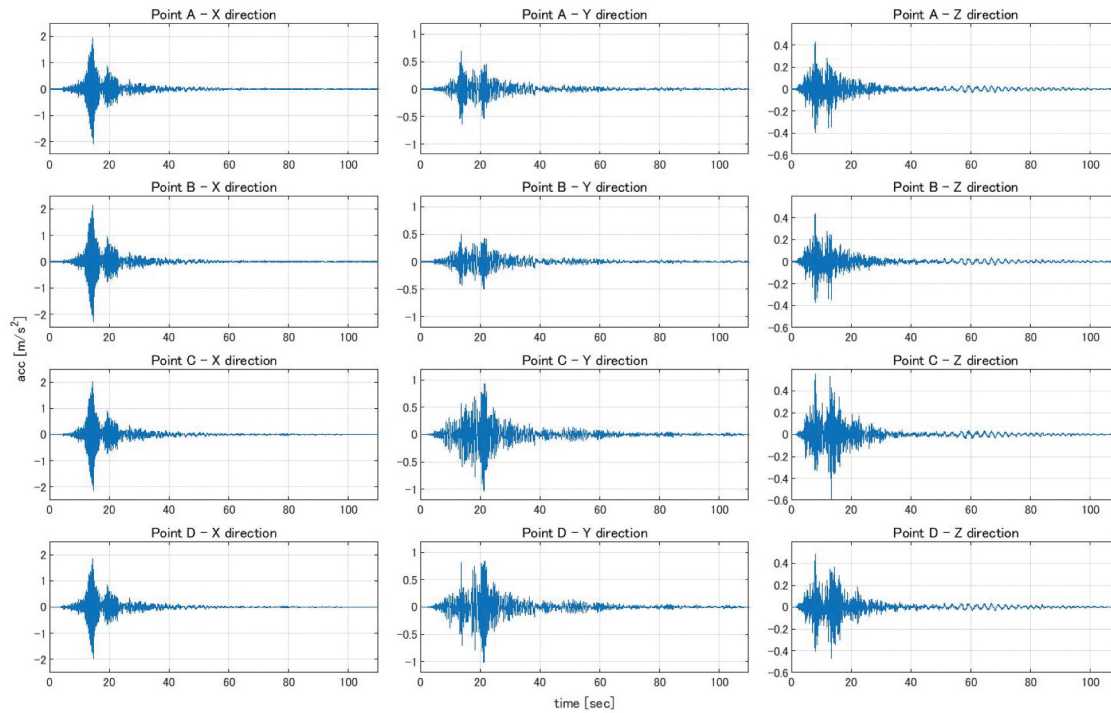

Figure 19. Acceleration time history at the base of Vault 1 by the 2012 earthquake.

the second mode, the MAC is lower but still acceptable. Frequency errors become zero after the model updating. Figure 12 shows the update mode shapes.

6. Seismic analysis

A linear dynamic analysis was performed by applying the earthquakes to the foundation to compare the time history of the updated model with that of monitoring.

Damage from past earthquakes was mainly concentrated in the vaults, while damage to vertical structures

was always negligible. It is therefore highlighted a structural criticality in the vulnerability of the vaults. For this reason, an NDA was also conducted to estimate the structural capacity of the Cathedral for Vault 1 (Figure 13), which suffered the most severe damage from the recent earthquake.

6.1. Linear transient response analysis

A first linear dynamic analysis was performed using a seismic input recorded during the “Amatrice

Earthquake” of August 24 2016, during the operation period of the monitoring system (2015-today) to compare the numerical response with the one detected. A second linear analysis was performed using the acceleration time histories recorded in the Modena seismic station during the 2012 seismic event with its epicentre in Finale Emilia (Emilia Romagna, Italy). The aim was to analyse the structure’s response to an earthquake considered one of the most significant earthquakes in recent years in the Modena area. This event was also used to

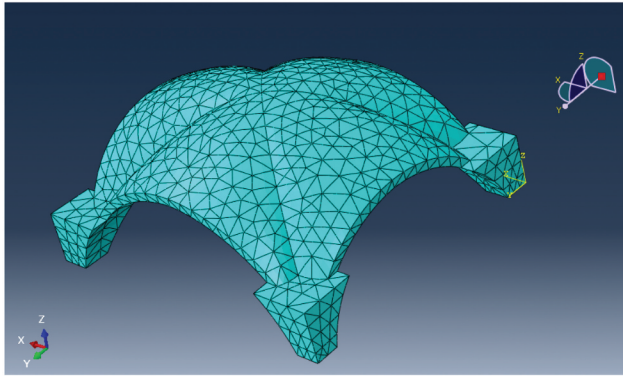

Figure 20. FE model of vault 1.

compare the simulated damage with that detected on the vaults.

6.1.1. Amatrice earthquake of 24-08-2016

The magnitude 6 Amatrice earthquake on August 24, 2016, has a distance of 282.8 km from the epicentre and a PGA of 2.318 cm/s^2 at Modena. The acceleration time histories in the three directions, recorded by accelerometer position No. 1 at the base of the structure and the corresponding pseudo acceleration spectra, are shown in Figure 14.

Acceleration time histories measured at Point No. 1 at the base of the Cathedral in Figure 10 were applied to the structural model to compare the monitoring data with the numerical analysis. In addition, comparisons between the numerical response and the experimental data were made using pseudo-acceleration spectra. Figure 15 compares the results obtained from the model before and after being updated with the experimental results.

As can be seen, Model Updating has improved the structural response by bringing it closer to the real one. Furthermore, the experimental and numerical responses are similar, and therefore the model is calibrated. Therefore, the model can be used for the

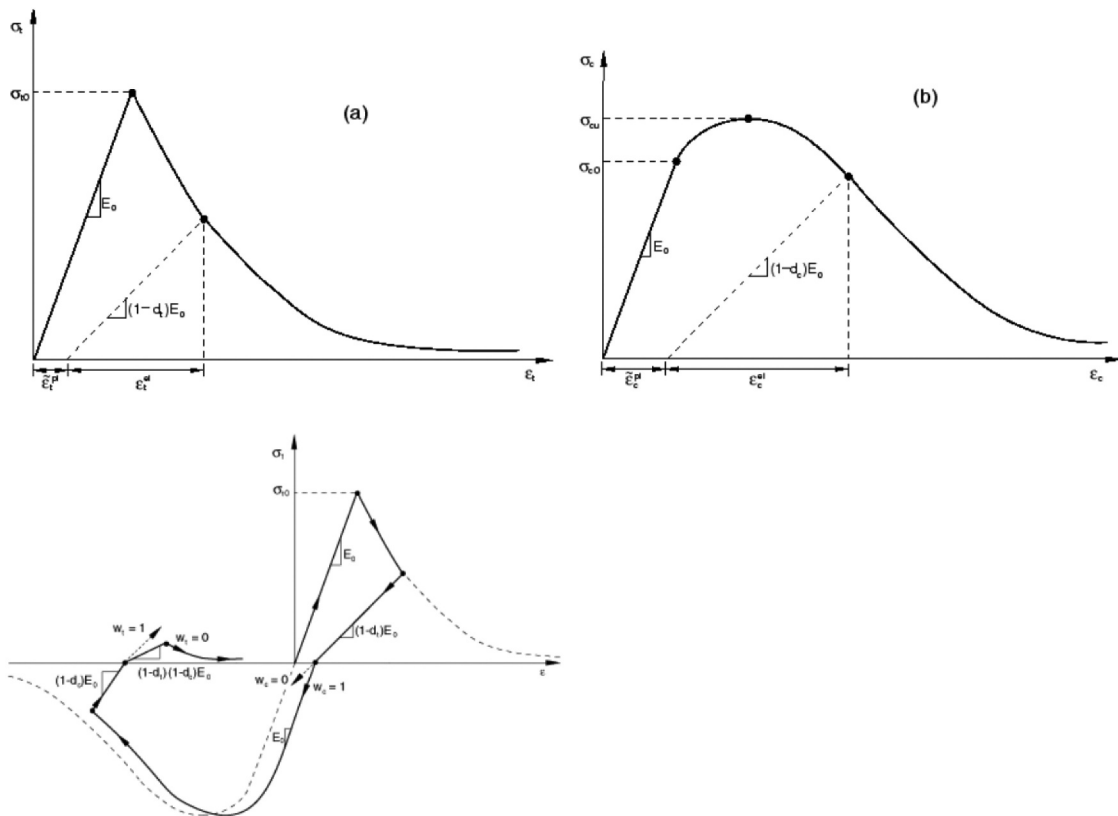

Figure 21. Concrete Damage Plasticity criterion (ABAQUS): (a) Response of masonry to uniaxial loading in tension; (b) compression; (c) circle.

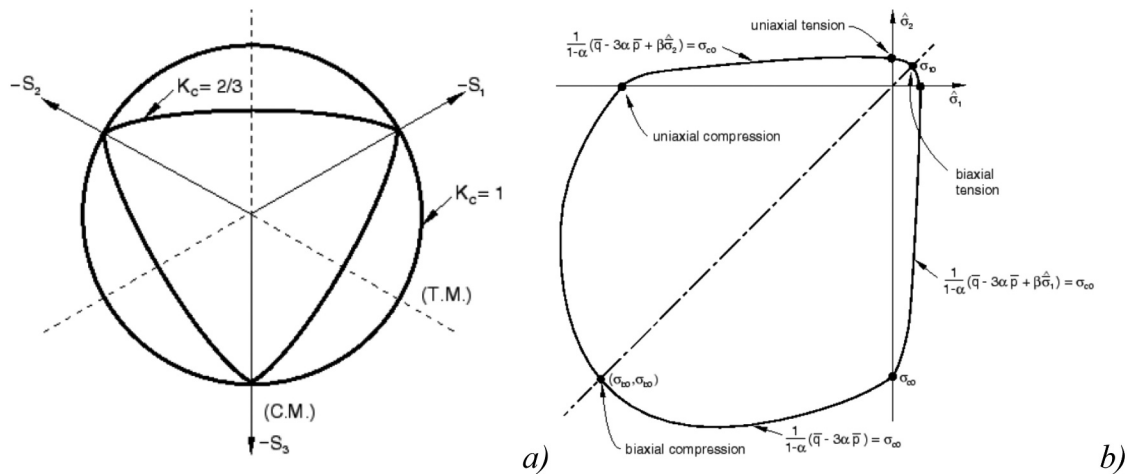

Figure 22. Concrete Damage Plasticity criterion (ABAQUS). (a) Yield surfaces in the deviatoric plane correspond to different K_c values; (b) Yield surface in-plane stress.

Table 3. Material elastic and plasticity parameters.

Young's modulus E (MPa)	Poisson's Ratio ν	Dilatation angle	Eccentricity	f_{b0}/f_{c0}	K	Viscosity parameters
2500	0.2	30°	0.1	1.16	0.667	0.0005

following analysis by applying the desired earthquake to the base.

6.1.2. Finale Emilia (Emilia-Romagna) earthquake of 29-05-2012

The second analysis of the whole structure is carried out with an earthquake not recorded by the monitoring. The acceleration time histories of this event were downloaded from the *INGV Itaca* website. The main characteristics of the data acquisition station are Network code IV-INSN; Station code MODE; EC8 class C; $V_{s,30}$ (m/s) 204. The magnitude 5.8 earthquake on May 29, 2012, has a distance of 25.3 km from the epicentre and a PGA of 42.256 cm/s² at Modena. The acceleration time histories in the three directions and the corresponding pseudo acceleration spectra are shown in Figure 16.

Transient linear analysis of the overall structure was performed. The pseudo acceleration spectrum of the

Table 4. Material compressive inelastic and tensile cracking behaviour.

Compressive behaviour		Tensile cracking behaviour	
Yield stress (MPa)	Inelastic strain	Yield stress (MPa)	Cracking strain
3	0	0.08	0
3	0.002	0.007	0.00025
0.03	0.005	0.003	0.001

Table 5. PGA input at the base of the structure.

Percentage compared to 2012	PGA X (m/s ²)	PGA Y (m/s ²)	PGA Z (m/s ²)
80%	0.30	0.15	0.34
100%	0.38	0.19	0.42
120%	0.46	0.23	0.50
160%	0.61	0.30	0.67

acceleration time histories at the base of the vault (points A, B, C, and D in Figure 13) is shown in Figure 17 compared with the input at the base of the structure. This figure represents the amplification ratio to the inputs. Furthermore, this analysis was necessary to derive the input data at the base of vault 1 for the NDA to obtain the damage scenarios of vault 1. Figure 18 shows the amplification of the response evaluated at the highest point of the façade.

6.2. Non-linear dynamic analysis of vault 1

Modena Cathedral has essentially shown criticalities in the vaults, while the rest of the structure has never suffered significant damage due to seismic events over time. This observation makes it possible to state that the seismic capacity of the cathedral is very close to that of the vaults, which are amplified by the vertical supporting structures in correspondence with the vaults themselves. Therefore, for the most vulnerable vault 1 in Figure 13, an NDA was

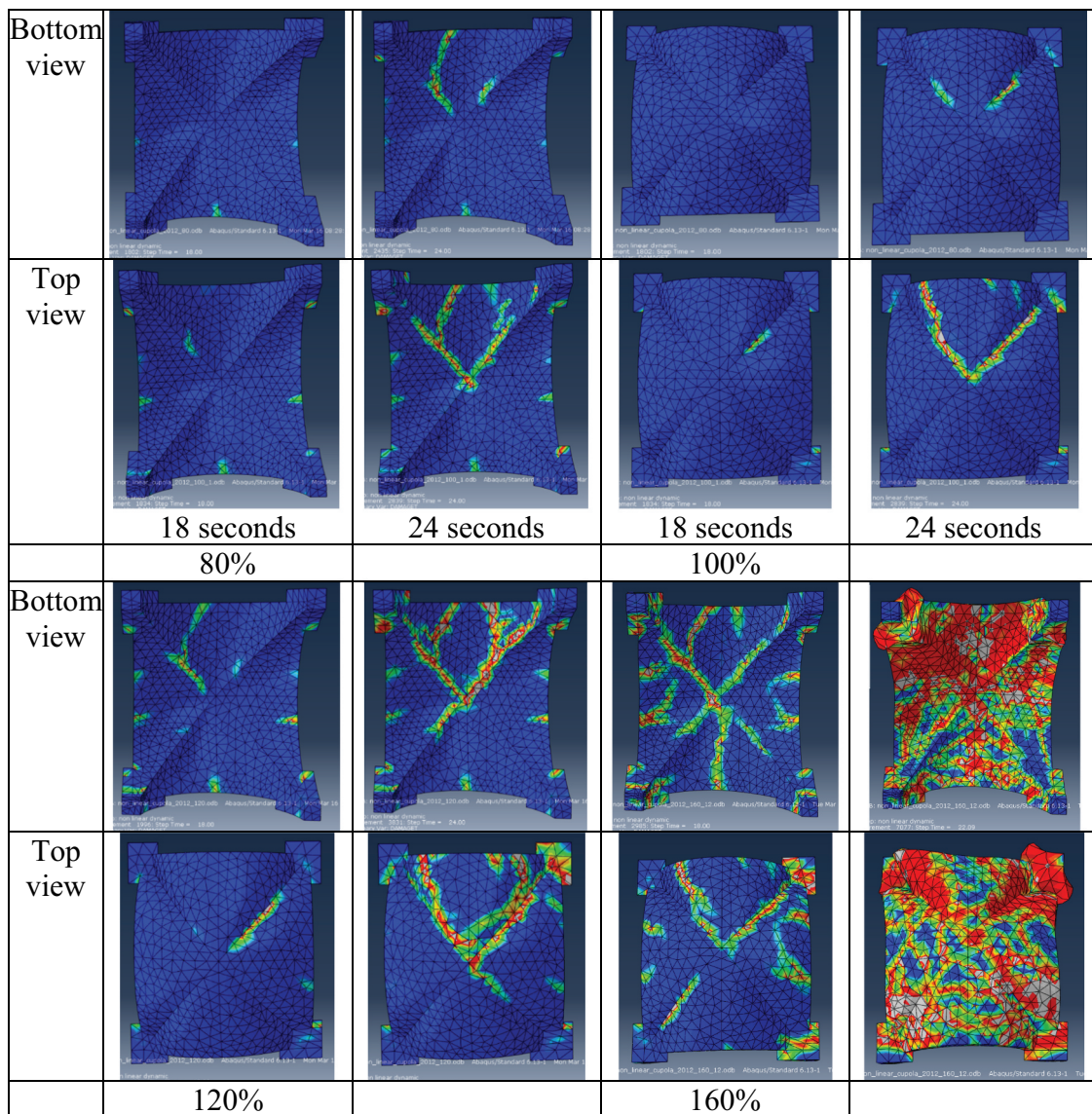

Figure 23. Damage scenarios for several levels of the earthquake in 2012.

carried out to obtain the damage scenarios under seismic action. Here, the time histories at the base of the vault (points A, B, C, and D) obtained from the linear dynamic analysis of the whole structure in the previous section were used as input for the non-linear analysis (Figure 19). The advantage of this approach is the possibility of working on a reduced model realised more accurately and rigorously (e.g. use of tetrahedral elements with 10 nodes instead of those with 4 nodes used in the global model) on which to perform sophisticated non-linear dynamic analyses. Once the elastic phase has passed, the non-linearity of the vaults modifies the input adopted because it changes the global response. Therefore, a rigorous NDA should be performed on the model of the entire structure. On the other hand, the local incremental NDA, starting from a level for which a response comparable to the elastic one of the complete

model is expected, can then provide an acceptable estimate of the overall capacity. In the case under consideration, a starting input of the ground excitation of the 2012 seismic event reduced by 20% was assumed. The time histories at the base were increased until the vault collapsed, obtaining the damage scenarios for various input levels. The comparison with the damage detected after the 2012 Finale Emilia earthquake allowed us to evaluate the reliability of the results obtained and, therefore, the model's capability and the procedure used.

6.2.1. FE Model of vault 1

The vault model consists of 10-nodes C3D10 solid elements since the purpose of the analysis is based on stress states in the non-linear domain, and this type of element allows for a more accurate description. A mesh with an

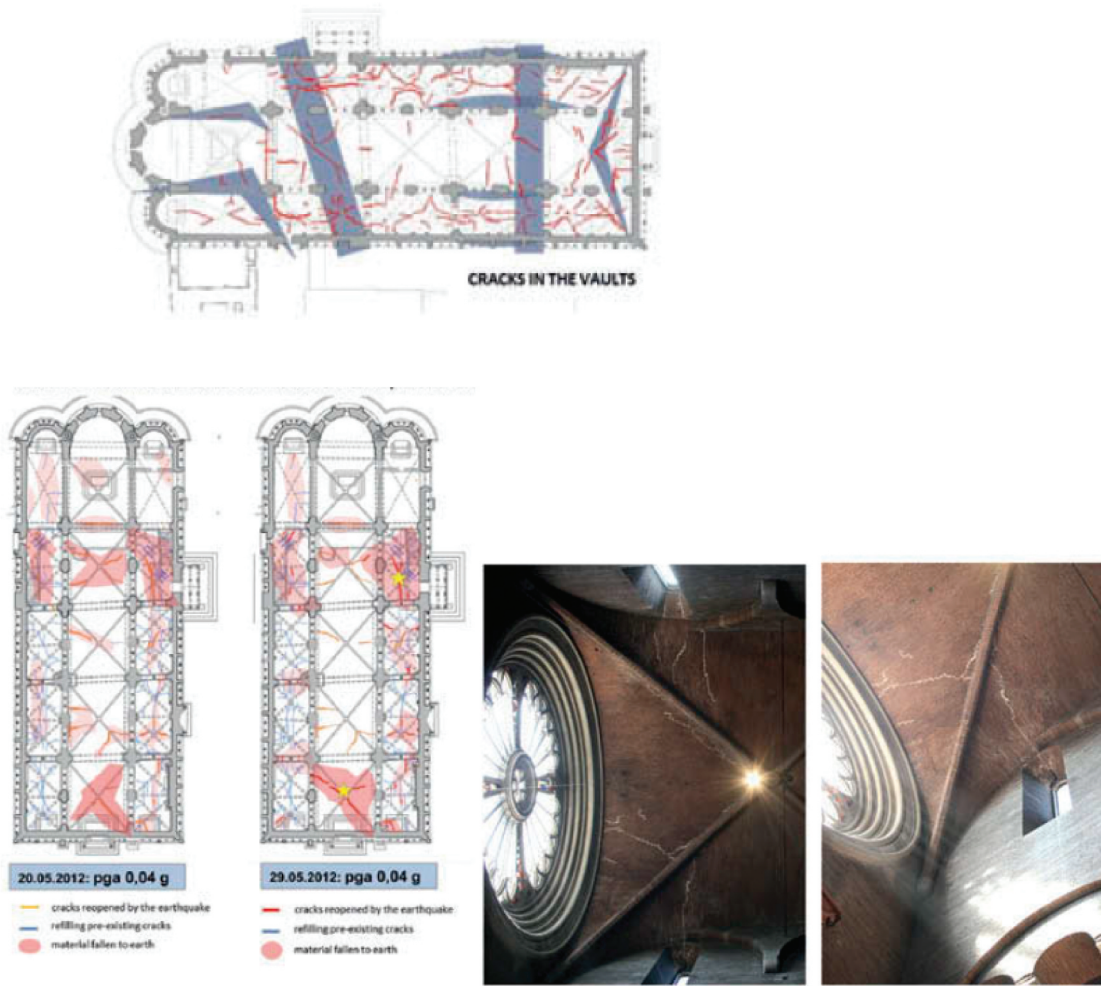
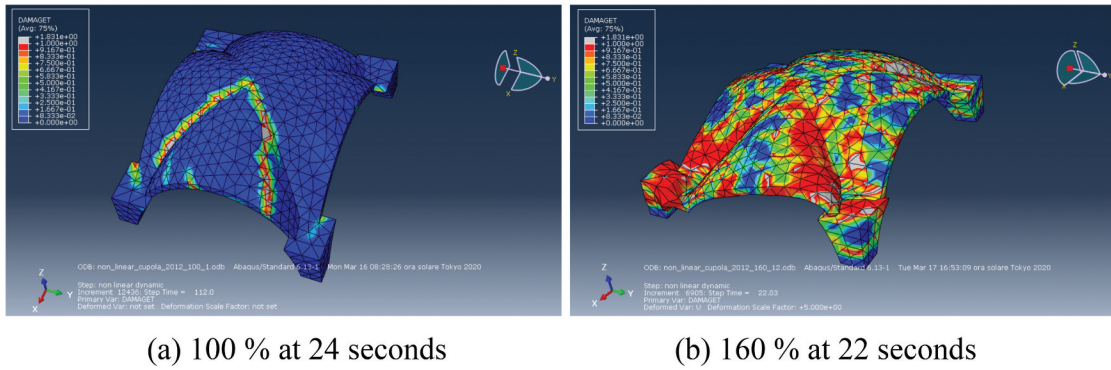

Figure 24. Damage obtained by recent earthquakes (Modified from Di Francesco et al. 2021).



(a) 100 % at 24 seconds

(b) 160 % at 22 seconds

Figure 25. Damage scenario corresponding to 100% and 160% of the 2012 earthquake.

average size of 0.5 m was used, as shown in Figure 20. The main hypothesis adopted in this modelling was to consider that the space between the vault and walls is not adequate. Therefore, connections were made only through the support bases and their surroundings. Likewise, the base of the vault can be enlarged by

increasing the cross-sectional area, thereby simulating a connection with the wall.

The elastic mechanical properties used in this analysis are those obtained in the model updating of the global model. The *Concrete Damage Plasticity criterion* was used for the description of the damage. The *Concrete*

Damage Plasticity criterion is a constitutive model that simulates concrete cracking and crushing behaviours through softening and hardening behaviours and the changes in the elastic stiffness using two scalar damage parameters, namely D_t and D_c in [Figure 21\(a and b\)](#).

The *Concrete Damaged Plasticity* model in *Abaqus* provides a general capability for modelling concrete and other quasi-brittle materials, such as masonry, in all types of structures (beams, trusses, shells, and solids). The criterion uses concepts of isotropic damaged elasticity in combination with isotropic tensile and compressive plasticity to represent the inelastic behaviour of the material. Moreover, it is designed for applications where the material is subjected to monotonic, cyclic, and dynamic loading under low confining pressures ([Figure 21 \(\)](#)).

The *Concrete Damage Plasticity criterion* combines no associated multi-hardening plasticity and scalar (isotropic) damaged elasticity to describe the irreversible damage during the fracturing process. Finally, it allows user control of stiffness recovery effects during cyclic load reversals, and it can be defined as sensitive to the rate of straining ([Figure 22](#)). The material properties used in the model are listed in [Tables 3 and 4](#).

6.2.2. Results

In order to obtain the damage scenarios of the vault, four different analyses were carried out by increasing the acceleration at the base of the structure and observing the variation in damage. The analyses were performed using the 2012 earthquake as 80%, 100%, 120%, and 160% ([Table 5](#)). As a result, the degree of damage to the vault can be plotted on a scale of 0 to 1 using concrete damage criteria. The value 1 means that the material is completely damaged and has lost its resistance, while 0 means undamaged. Therefore, by tracking the damage locations close to 1, the cracking pattern of the vault can be obtained.

Some obtained characteristic steps of the damage scenarios are shown in [Figure 23](#). The results obtained corresponding to the 100% of the 2012 earthquake were compared with some photos and damage maps made from inspections carried out in the aftermath. The data on the damage is shown in [Figure 24](#). Comparing the analysis results with the photos regarding the damage highlights some correspondences in the cracking pattern of recent earthquakes. It is possible to see how the model interprets cracks at the curvature changes, which are the principal damage to the vault, and cracks that start at openings such as rose windows and propagate to the curvature changes in the vault.

Therefore, the model correctly underlines the main problems of the vault, reporting which are the most vulnerable and critical areas under seismic action. Finally, by increasing the 2012 earthquake up to 160%, a collapse of the vault was identified, corresponding to a PGA of 0.67 m/s^2 at the base of the structure. From the results obtained, the damage caused by the 2012 earthquake is well interpreted by the numerical model, as shown in [Figure 25](#). Thus, the model correctly underlines the main critical points of the vault reporting the most vulnerable and critical areas under seismic action.

7. Conclusion

The main objective of the work was to define an optimal procedure for assessing the seismic capacity of historical and monumental masonry buildings. However, this type of construction is complicated to model and analyse, mainly due to the geometric complexity and uncertainty in the mechanical properties of the materials. Therefore, Modena Cathedral was used as a case study.

The structural model was generated from an automated precision survey and a historical analysis of the materials used during the construction phase and subsequent interventions. Subsequently, a model update analysis based on experimental dynamic monitoring data corrected the mechanical properties of the material based on the assumptions made. The updated model result can reproduce the linear dynamic response of the structure.

The analysis of the damage caused by past earthquakes highlighted a severe problem in the vaults. The seismic analysis of the entire structure would require an NDA of the whole structure, but this would be too costly. Therefore, considering the detected critical areas, NDA of the vault was conducted using the acceleration time history of the connection between the vault and the vertical structure obtained from the linear dynamic analysis as input.

By increasing the input at the base of the structure, the collapse occurs with an input having PGA equal to 0.67 m/s^2 , equal to 1.6 times that of the 2012 earthquake ([Figure 25](#)). The results obtained emphasise the importance of good structural knowledge and the procedures employed. Dynamic structural monitoring is essential for building models that reproduce structural responses during earthquakes.

Thus, the numerical analysis results matched the damage maps identified on the actual structures. Furthermore, the present study demonstrates that

the numerical model and analysis procedure can reproduce accurate structural responses. Therefore, the methodological approach proposed in this paper for assessing the seismic vulnerability of masonry cathedrals can be adopted.

Acknowledgments

This work was supported by JSPS KAKENHI Grant-in-Aid for Scientific Research (S) (Grant No. 16H06363), Fostering Joint International Research (B) (Grant No. 21KK0076) and Foundation for Cultural Heritage and Art Research (22-45).

Disclosure statement

No potential conflict of interest was reported by the author(s).

Funding

This work was supported by the JSPS [16H06363, 21KK0076]; Foundation for Cultural Heritage and Art Research [22-45].

References

- Aoki, T., D. Sabia, and D. Rivella. 2008. Influence of experimental data and fe model on updating results of a brick chimney. *Journal of Advances in Engineering Software* 39 (4):327–35. doi:10.1016/j.advengsoft.2007.01.005.
- Aoki, T., D. Sabia, D. Rivella, and T. Komiyama. 2007. Structural characterization of a stone Arch Bridge by experimental tests and numerical model updating. *International Journal of Architectural Heritage* 1 (3):227–50. doi:10.1080/15583050701241208.
- Armandi, M. 1999. Copie e originali. Il repertorio di mensole figurate del Duomo di Modena in Italia. In *Il Duomo di Modena, a cura di Frugoni, C*, edited by C. Frugoni, 1342. Modena: Franco Cosimo Panini.
- Balado, J., L. Díaz-Vilariño, M. Azenha, and P. B. Lourenço. 2021. Automatic detection of surface damage in round brick chimneys by finite plane modelling from terrestrial laser scanning point clouds. *Case Study of Bragança Dukes' Palace, Guimarães, Portugal, International Journal of Architectural Heritage, Online* 1–15.
- Baraccani, S., S. Silvestri, G. Gasparini, M. Palermo, T. Trombetti, E. Silvestri, R. Lancellotta, and A. Capra. 2016. A structural analysis of the Modena Cathedral. *International Journal of Architectural Heritage* 10 (2–3):235–53.
- Casapulla, C., A. Maione, and L. U. Argiento. 2017. Seismic analysis of an existing masonry building according to the multi-level approach of the Italian guidelines on cultural heritage. *Ingegneria Sismica* 34 (1):40–60.
- Caselles, O., G. Martínez, J. Clapés, P. Roca, and M. V. Pérez-Gracia. 2015. Application of particle motion technique to structural modal identification of heritage buildings. *International Journal of Architectural Heritage* 9 (3):310–23. doi:10.1080/15583058.2013.784824.
- Castagnetti, C., A. Capra, and E. Silvestri. 2016. Diagnostic use of laser scanning data to identify current and historical deformations and geometries: The case of the Modena Cathedral. *3rd Joint International Symposium on Deformation Monitoring (JISDM)*, Vienna, Austria, 1–6.
- Chellini, G., L. Nardini, B. Pucci, W. Salvatore, and R. Tognaccini. 2014. Evaluation of seismic vulnerability of Santa Maria del Mar in Barcelona by an integrated approach based on terrestrial laser scanner and finite element modeling. *International Journal of Architectural Heritage* 8 (6):795–819. doi:10.1080/15583058.2012.747115.
- Demirioglu, K., S. Gonen, S. Soyoz, and M. P. Limongelli. 2018. In-plane seismic response analyses of a historical brick masonry building using equivalent frame and 3D FEM modeling approaches. *International Journal of Architectural Heritage* 14 (2):238–56. doi:10.1080/15583058.2018.1529208.
- Di Francesco, C., F. Piccinini, and E. Silvestri. 2021. *Il Duomo di Modena – Studi e ricerche per un approccio interdisciplinare*, 328. Allemandi.
- Di Napoli, B., M. P. Ciocci, T. Celano, L. U. Argiento, C. Casapulla, and P. B. Lourenço. 2021. Seismic behaviour of a mixed iron-masonry church: Santa Maria Maddalena, Ischia. *Proceedings of the Institution of Civil Engineers: Engineering and Computational Mechanics*, 174(2): 114–29.
- Di Tommaso, A., R. Lancellotta, D. Sabia, D. Costanzo, F. Focacci, and F. Romaro. 2013. Dynamic identification and seismic behaviour of the Ghirlandina Tower in Modena (Italy). *Proceedings of the 2nd International Symposium on Geotechnical Engineering for the Preservation of Monuments and Historic Sites*, Naples, Italy, 343–51.
- Endo, Y., L. Pelà, and P. Roca. 2017. Review of different pushover analysis methods applied to masonry buildings and comparison with nonlinear dynamic analysis. *Journal of Earthquake Engineering* 21 (8):1234–55. doi:10.1080/13632469.2016.1210055.
- Friswell, M. I., and J. Mottershead. 1995. *Finite element model updating in structural dynamics*. Dordrecht: Kluwer Academic Publishers, Dordrecht, Netherlands.
- Jung, H., and D. J. Ewins. 1992. Error sensitivity of the inverse eigensensitivity method for model updating. *Proceeding of the 10th. International model analysis conference*, San Diego, CA, USA, 992–98.
- Lancellotta, R. 2009. *Geotechnical aspects related to the preservation of the Ghirlandina Tower*, 178–93. The Ghirlandina Tower, Cadignani, R. Ed., Roma: Sossella.
- Lancellotta, R., and D. Sabia. 2013. The role of monitoring and identification techniques on the preservation of historic towers. *Proceedings of the 2nd International Symposium on Geotechnical Engineering for the Preservation of Monuments and Historic Sites*, Naples, Italy, 57–74.
- Lancellotta, R., and D. Sabia. 2015. *Monitoraggio sismico del Duomo di Modena, Rapporto sulla installazione del sistema di monitoraggio, Torino [in Italian]*. Politecnico di Torino.
- Masciotta, M. G., L. J. Sanchez-Aparicio, D. V. Oliveira, and D. Gonzalez-Aguilera. 2022. Integration of laser scanning technologies and 360° Photography for the digital documentation and management of cultural heritage buildings. *International Journal of Architectural Heritage, Online* 1–20.

- MiC (Ministero della Cultura). 2011. *Linee Guida per la valutazione e riduzione del rischio sismico del patrimonio culturale allineate alle nuove Norme tecniche per le costruzioni (d. m. 14 gennaio 2008) [in Italian]*. https://storico.beniculturali.it/mibac/multimedia/MiBAC/documents/1295444865088_LINEE.pdf
- Milani, G., and M. Valente. 2015a. Comparative pushover and limit analyses on seven masonry churches damaged by the 2012 Emilia-Romagna (Italy) seismic events: Possibilities of non-linear finite elements compared with pre-assigned mechanisms. *Engineering Failure Analysis* 47 (47):129–61. doi:10.1016/j.engfailanal.2014.09.016.
- Milani, G., and M. Valente. 2015b. Failure analysis of seven masonry churches severely damaged during the 2012 Emilia-Romagna (Italy) earthquake: Non-linear dynamic analyses vs conventional static approaches. *Engineering Failure Analysis* 54:13–56. doi:10.1016/j.engfailanal.2015.03.016.
- Peroni, A. 1985. L'architetto Lanfranco e la struttura del duomo [in Italian]. In *Lanfranco e Wiligelmo. Il duomo di Modena*, 845. Modena: Panini.
- Peroni, A. 1989. *Architettura e scultura: Aggiornamenti [in Italian]*, in *Wiligelmo e Lanfranco nell'Europa romanica, Atti del convegno (Modena, 24-27 ottobre 1985)*. Modena: Franco Cosimo Panini.
- Porter, A. K. 1917. *Lombard Architecture*. New Haven: Yale University Press.
- Sabia, D., T. Aoki, R. Cosentini, and R. Lancellotta. 2015. Model updating to forecast the dynamic behavior of the Ghirlandina Tower in Modena, Italy. *Journal of Earthquake Engineering* 19 (1):1–24. doi:10.1080/13632469.2014.962668.
- Silvestri, E. 2013. Una rilettura delle fasi costruttive del Duomo di Modena [in Italian]. In *Atti e Memorie della Deputazione di Storia Patria per le Antiche Province Modenesi*, XI, XXXV, 117–49. Modena: Unesco.
- Silvestri, S., S. Baraccani, M. Palermo, A. Montanari, and T. Trombetti. 2015. Valutazione della sicurezza strutturale del Duomo di Modena [in Italian] - *ACQUISIZIONE DELLE CONOSCENZE - DOCUMENTO 1*. Bologna: Dipartimento di ingegneria civile, ambientale e dei materiali - Università di Bologna
- Simulia, A. 2006. *ABAQUS Theory manual - online documentation*. ABAQUS, Inc. <https://classes.engineering.wustl.edu/2009/spring/mase5513/abaqus/docs/v6.6/books/stm/default.htm>
- Van Overschee, P., and B. De Moor. 1996. *Subspace identification for linear systems: theory-implementation-applications*. Dordrecht, Netherlands: Kluwer Academic Publishers.