



---

# Development of Guidelines for Inspection, Repair, and Use of Portable Concrete Barriers—Volume 1: Technical Report

Technical Report 0-7059-R1-Vol1

---

Cooperative Research Program

TEXAS A&M TRANSPORTATION INSTITUTE  
COLLEGE STATION, TEXAS

sponsored by the  
Federal Highway Administration and the  
Texas Department of Transportation  
<https://tti.tamu.edu/documents/0-7059-R1-Vol1.pdf>



|  |  |  |  |  |           |
|--|--|--|--|--|-----------|
| 1. Report No.<br>FHWA/TX-22/0-7059-R1-Vol1   |  | 2. Government Accession No.                          |  | 3. Recipient's Catalog No.   |           |
| 4. Title and Subtitle<br>DEVELOPMENT OF GUIDELINES FOR INSPECTION, REPAIR,<br>AND USE OF PORTABLE CONCRETE BARRIERS—VOLUME 1:<br>TECHNICAL REPORT  |  |  |  | 5. Report Date<br>Published: September 2022  |           |
|  |  |  |  | 6. Performing Organization Code  |           |
| 7. Author(s)<br>Chiara Silvestri Dobrovolny, Shristi Bhutani, Aniruddha Zalani, Roger P. Bligh, Stefan Hurlebaus, Husain Aldahlki, William Schroeder, and Darrell L. Kuhn  |  |  |  | 8. Performing Organization Report No.<br>Report 0-7059-R1-Vol1                       |           |
| 9. Performing Organization Name and Address<br>Texas A&M Transportation Institute<br>The Texas A&M University System<br>College Station, Texas 77843-3135  |  |  |  | 10. Work Unit No. (TRAVIS)   |           |
|  |  |  |  | 11. Contract or Grant No.<br>Project 0-7059  |           |
| 12. Sponsoring Agency Name and Address<br>Texas Department of Transportation<br>Research and Technology Implementation Office<br>125 E. 11 <sup>th</sup> Street<br>Austin, Texas 78701-2483  |  |  |  | 13. Type of Report and Period Covered<br>Technical Report:<br>November 2019–May 2022 |           |
|  |  |  |  | 14. Sponsoring Agency Code   |           |
| 15. Supplementary Notes<br>Project sponsored by the Texas Department of Transportation and the Federal Highway Administration.<br>Project Title: Develop Guidelines for Inspection, Repair, and Use of Portable Concrete Barriers<br>URL: <a href="https://tti.tamu.edu/documents/0-7059-R1-Vol1.pdf">https://tti.tamu.edu/documents/0-7059-R1-Vol1.pdf</a>  |  |  |  |  |           |
| 16. Abstract<br>Defining the service life of portable concrete barriers (PCBs) is important to reduce the risk of inferior, unsafe barriers being used on Texas roadways. The <i>Manual for Assessing Safety Hardware (MASH)</i> implementation agreement allows state transportation agencies to continue the use of PCBs manufactured on or before December 31, 2019, and successfully tested to standards in National Cooperative Highway Research Program Report 350 or the 2009 edition of <i>MASH</i> throughout their normal service life. Damage to the precast barriers can occur in transit, in storage, or due to vehicular impact. When damage to the connections occurs, cracks, broken corners, and many other forms of damage can be sustained by the barrier. No federal guidance, however, has been developed to determine life expectancy for PCBs. There is a need to develop guidelines addressing the type and extent of barrier damage that constitute replacement of the segment.<br><br>The research team documented best practices with respect to repairing or replacing PCB segments and utilized a combination of engineering evaluation, dynamic component testing, and full-scale crash testing to develop guidelines to assist in designing a process to determine useful service life. |  |  |  |  |           |
| 17. Key Words<br>Portable Concrete Barrier, Guideline, Inspection, Repair, Use, Acceptability, Removal, <i>MASH</i> , Full-Scale Testing, FEA, Impact  |  |  | 18. Distribution Statement<br>No restrictions. This document is available to the public through NTIS:<br>National Technical Information Service<br>Alexandria, Virginia<br><a href="http://www.ntis.gov">http://www.ntis.gov</a> |  |           |
| 19. Security Classif. (of this report)<br>Unclassified   |  | 20. Security Classif. (of this page)<br>Unclassified |  | 21. No. of Pages<br>210  | 22. Price |





# **DEVELOPMENT OF GUIDELINES FOR INSPECTION, REPAIR, AND USE OF PORTABLE CONCRETE BARRIERS—VOLUME 1: TECHNICAL REPORT**

by

Chiara Silvestri Dobrovolny, Ph.D.  
Research Scientist  
Texas A&M Transportation Institute

Srishti Bhutani  
Former Graduate Assistant Researcher  
Texas A&M Transportation Institute

Aniruddha Zalani  
Graduate Assistant Researcher  
Texas A&M Transportation Institute

Roger P. Bligh, Ph.D., P.E.  
Senior Research Engineer  
Texas A&M Transportation Institute

Stefan Hurlebaus, Ph.D.  
Professor  
Texas A&M Transportation Institute

Husain Aldahlki, Ph.D.  
Former Postdoctoral Researcher  
Texas A&M Transportation Institute

William Schroeder  
Research Engineering Associate  
Texas A&M Transportation Institute

Darrell L. Kuhn, P.E.  
Research Specialist  
Texas A&M Transportation Institute

Report 0-7059-R1-Vol1  
Project 0-7059

Project Title: Develop Guidelines for Inspection, Repair, and Use of Portable Concrete Barriers

Sponsored by the  
Texas Department of Transportation  
and the  
Federal Highway Administration

Published: September 2022

TEXAS A&M TRANSPORTATION INSTITUTE  
College Station, Texas 77843-3135



## **DISCLAIMER**

This research was sponsored by the Texas Department of Transportation (TxDOT) and the Federal Highway Administration (FHWA). The contents of this report reflect the views of the authors, who are responsible for the facts and the accuracy of the data presented herein. The contents do not necessarily reflect the official view or policies of FHWA or TxDOT. This report does not constitute a standard, specification, or regulation.

This report is not intended for construction, bidding, or permit purposes. The researcher in charge of the project was Dr. Chiara Silvestri Dobrovlny.

## **ACKNOWLEDGMENTS**

This project was sponsored by TxDOT and FHWA. The authors thank the project manager, Tom Schwerdt, and the members of the Project Monitoring Committee: Christopher Lindsey and Ken Mora from the Design Division, Jennifer Vorster from the Dallas District, Matthew Herbstritt from the Childress District, and Teresa Michalk from the Materials and Tests Division.

# TABLE OF CONTENTS

|  | <b>Page</b> |
|--|-------------|
| <b>List of Figures</b> .....   | <b>x</b>    |
| <b>List of Tables</b> .....  | <b>xiv</b>  |
| <b>1. Introduction</b> .....   | <b>1</b>    |
| <b>2. Portable Concrete Barriers</b> .....   | <b>3</b>    |
| 2.1 Defects Commonly Found in Portable Concrete Barriers .....   | 3           |
| 2.1.1 Spalling .....   | 3           |
| 2.1.2 Cracking.....  | 6           |
| 2.1.3 Damage to JJ Hook Connections .....  | 12          |
| 2.2 Guidelines on the Inspection and Evaluation of Portable Concrete Barriers .....  | 14          |
| 2.2.1 Acceptance Criteria for Damaged Temporary Concrete Barrier, NYSDOT .....   | 14          |
| 2.2.2 Quality Standard for Temporary Concrete Barrier, Illinois State Toll Highway<br>Authority .....  | 16          |
| 2.2.3 Quality Guidelines for Temporary Traffic Control Devices and Features,<br>ATSSA .....  | 17          |
| 2.2.4 Specification for Road Safety Hardware Systems (Appendix C: Temporary<br>Road Safety Barrier Systems), New Zealand Transport Agency..... | 19          |
| 2.2.5 FDOT Evaluation Guide—Temporary Concrete Barrier, FDOT .....   | 19          |
| 2.2.6 Guidelines for Temporary Pre-Cast Concrete Safety Barrier Condition<br>Inspection, KDOT .....  | 21          |
| <b>3. State Department of Transportation Surveys</b> .....   | <b>23</b>   |
| 3.1 Inspection Guidance .....  | 23          |
| 3.1.1 Summary of Agencies with Inspection Guidance.....  | 23          |
| 3.1.2 Summary of Agencies without Inspection Guidance.....   | 32          |
| 3.1.3 Summary of Agencies with “Other” Responses .....   | 33          |
| 3.1.4 Inspection Procedure.....  | 34          |
| 3.2 Evaluation Guidance.....   | 35          |
| 3.2.1 Summary of Agencies with Evaluation Guidance .....   | 35          |
| 3.2.2 Summary of Agencies without Evaluation Guidance .....  | 37          |
| 3.3 Repair Guidance .....  | 38          |
| 3.3.1 Summary of Agencies with Repair Guidance.....  | 39          |
| 3.3.2 Summary of Agencies without Repair Guidance.....   | 40          |
| 3.3.3 Summary of Agencies with “Other” Responses .....   | 42          |
| <b>4. TxDOT District Survey</b> .....  | <b>43</b>   |
| 4.1 Inspection Guidance .....  | 43          |
| 4.1.1 Summary of Districts with Inspection Guidance .....  | 43          |
| 4.1.2 Summary of Districts without Inspection Guidance.....  | 44          |
| 4.1.3 Summary of Districts with “Other” Responses .....  | 44          |
| 4.2 Evaluation Guidance.....   | 44          |
| 4.2.1 Summary of Districts with Evaluation Guidance .....  | 45          |
| 4.2.2 Summary of Districts without Evaluation Guidance .....   | 45          |
| 4.2.3 Summary of Districts with “Other” Responses .....  | 45          |
| 4.3 Repair Guidance .....  | 46          |
| 4.3.1 Summary of Districts with Repair Guidance .....  | 46          |

|           |   |            |
|-----------|---|------------|
| 4.3.2     | Summary of Districts without Repair Guidance .....  | 47         |
| 4.3.3     | Summary of Districts with “Other” Responses .....   | 47         |
| <b>5.</b> | <b>Destructive Dynamic Component Testing on Single-Slope and F-Shape Barrier Profiles .....</b> | <b>49</b>  |
| 5.1       | Five Single-Slope Barrier Installation .....  | 49         |
| 5.1.1     | Test No. 440590-01-B1 (Single-Slope [SS]-1, Centerline of Barrier C).....                       | 50         |
| 5.1.2     | Test No. 440590-01-B8 (SS-4, Centerline of Barrier G).....                                      | 53         |
| 5.2       | Four Single-Slope Barrier Installation .....  | 56         |
| 5.2.1     | Test No. 440591-01-B2 (SS-2, Centerline of Joint E–A).....                                      | 56         |
| 5.2.2     | Test No. 440591-01-B9 (SS-5, Centerline between Joints E–A) .....                               | 59         |
| 5.2.3     | Test No. 440591-01-B7 (SS-3, Centerline between Joints E–A) .....                               | 62         |
| 5.2.4     | Test No. 440591-01-B10 (SS-6, Centerline between Joints E–A) .....                              | 65         |
| 5.3       | Five F-Shape Barrier Installation.....  | 68         |
| 5.3.1     | Test No. 440590-01-B3 (F-1, Centerline of Barrier C) .....                                      | 68         |
| 5.3.2     | Test No. 440590-01-B11 (F-4, Centerline of Barrier G).....                                      | 71         |
| 5.4       | Four F-Shape Barrier Installation .....   | 73         |
| 5.4.1     | Test No. 440591-01-B4 (F-2, between Barriers F and G) .....                                     | 73         |
| 5.4.2     | Test No. 440591-01-B12 (F-5, between Barriers F and G).....                                     | 76         |
| 5.5       | Conclusions.....  | 79         |
| <b>6.</b> | <b>Destructive Dynamic Component Testing on Low-Profile Barrier Profiles .....</b>              | <b>81</b>  |
| 6.1       | Five Low-Profile Barrier Installation .....   | 81         |
| 6.1.1     | Test No. 440591-01-B5 (Low-Profile [LP]-1, Centerline of Barrier C).....                        | 81         |
| 6.2       | Six Low-Profile Barrier Installation .....  | 84         |
| 6.2.1     | Test No. 440591-01-B6 (LP-2, Centerline of Joint E–A).....                                      | 84         |
| 6.3       | Conclusions.....  | 87         |
| <b>7.</b> | <b>Finite Element Computer Simulations .....</b>  | <b>89</b>  |
| 7.1       | Introduction.....   | 89         |
| 7.2       | Computer Model .....  | 89         |
| 7.3       | Model Calibration .....   | 90         |
| 7.4       | Predictive Simulations .....  | 91         |
| 7.5       | Predictive Simulations for the Single-Slope Barrier.....  | 92         |
| 7.5.1     | Predictive Baseline Simulations .....   | 92         |
| 7.5.2     | Predictive Simulations with Pre-damaged Single-Slope Barrier .....                              | 98         |
| 7.5.3     | Conclusion .....  | 99         |
| 7.6       | Predictive Simulations for the F-Shape Barrier .....  | 101        |
| 7.6.1     | Predictive Baseline Simulations .....   | 101        |
| 7.6.2     | Predictive Simulations with Pre-damaged F-Shape Barrier .....                                   | 103        |
| 7.6.3     | F-Shape Barrier System with Pre-deformed JJ Hook Connectors.....                                | 107        |
| 7.7       | Conclusions.....  | 110        |
| <b>8.</b> | <b>Construction and Full-Scale Crash Testing .....</b>  | <b>113</b> |
| 8.1       | Test Article Design and Construction.....   | 113        |
| 8.2       | <i>MASH</i> Test 3-11 (Crash Test No. 440592-1) .....   | 117        |
| 8.2.1     | Test Designation and Actual Test Conditions .....   | 117        |
| 8.2.2     | Test Vehicle .....  | 118        |
| 8.2.3     | Weather Conditions .....  | 118        |
| 8.2.4     | Test Description .....  | 119        |

|            |  |            |
|------------|--|------------|
| 8.2.5      | Test Article/Component Damage .....  | 119        |
| 8.2.6      | Test Vehicle Damage .....  | 120        |
| 8.2.7      | Occupant Risk Values .....   | 121        |
| 8.3        | <i>MASH</i> Test 3-11 (Crash Test No. 440592-2) .....                                | 126        |
| 8.3.1      | Test Designation and Actual Test Conditions .....                                    | 126        |
| 8.3.2      | Test Vehicle .....   | 127        |
| 8.3.3      | Weather Conditions .....   | 127        |
| 8.3.4      | Test Description .....   | 127        |
| 8.3.5      | Test Article/Component Damage .....  | 128        |
| 8.3.6      | Test Vehicle Damage .....  | 129        |
| 8.3.7      | Occupant Risk Values .....   | 130        |
| 8.4        | Conclusions on <i>MASH</i> Test 3-11 (Crash Test No. 440592-1 and No. 440592-2)..... | 135        |
| <b>9.</b>  | <b>Guidelines for the Evaluation and Repair of Portable Concrete Barriers .....</b>  | <b>139</b> |
| 9.1        | Evaluation Guidelines .....  | 139        |
| 9.1.1      | Spalling .....   | 139        |
| 9.1.2      | Cracks .....   | 153        |
| 9.1.3      | Segment Connections.....   | 163        |
| 9.2        | Repair Guidelines .....  | 170        |
| 9.2.1      | Spall Repair.....  | 170        |
| 9.2.2      | Crack Repair .....   | 170        |
| <b>10.</b> | <b>Summary and Conclusions .....</b>   | <b>177</b> |
| <b>11.</b> | <b>Implementation .....</b>  | <b>179</b> |
|            | <b>References .....</b>  | <b>181</b> |
|            | <b>Appendix A. TxDOT Drawings for Different Barrier Shapes.....</b>                  | <b>185</b> |
|            | <b>Appendix B. Value of Research .....</b>   | <b>189</b> |
| B.1        | Introduction .....   | 189        |
| B.2        | Qualitative Benefit Areas.....   | 189        |
| B.2.1      | Engineering Design Improvement .....   | 189        |
| B.2.2      | Safety .....   | 189        |
| B.3        | Economic Benefits .....  | 190        |
| B.4        | References .....   | 193        |

## LIST OF FIGURES

|  | <b>Page</b> |
|--|-------------|
| Figure 2.1. Real-Life Spalling Observed in Crash Barriers from a Stockyard. ....   | 3           |
| Figure 2.2. Corrosion of Reinforcing Bar Embedded in the Toe of the Concrete Barrier.....                                | 4           |
| Figure 2.3. Spalling at the Toe of Barrier E Due to a Vehicle Crashing into the<br>Joint between Barriers A and E. ....  | 5           |
| Figure 2.4. Cracking in Portable Concrete Barriers (8).....  | 7           |
| Figure 2.5. Clustered Horizontal Cracks Due to the Tight Clamping of Lifting Devices<br>(10).....                        | 7           |
| Figure 2.6. Various Stages in the Transportation of PCBs.....  | 8           |
| Figure 2.7. Shrinkage Cracks (18).....   | 9           |
| Figure 2.8. Crack Due to the Formation of More Voluminous Products (20).....   | 10          |
| Figure 2.9. Crack Due to the Corrosion of Reinforcement (22).....  | 11          |
| Figure 2.10. Crack-Like Formation Due to the Lack of Mixing of Two Batches of Concrete<br>during the Pour (19).....      | 11          |
| Figure 2.11. JJ Hook Connections: Top View of a JJ Hook Connection between<br>Barrier Units.....                         | 13          |
| Figure 2.12. Transverse Cracks—NYSDOT (27).....  | 15          |
| Figure 2.13. Longitudinal Cracks—NYSDOT (27).....  | 15          |
| Figure 2.14. Corner Damage—NYSDOT (27).....  | 16          |
| Figure 2.15. Threshold Criteria for Snag Point—NYSDOT (27).....  | 16          |
| Figure 2.16. Unacceptable Barrier Due to Snag Risk—NYSDOT (27).....  | 16          |
| Figure 2.17. Example of Unacceptable Barrier—Illinois (28).....  | 17          |
| Figure 2.18. Barrier Examples—ATSSA (29).....  | 18          |
| Figure 2.19. Example of Unacceptable Barrier with Connection Assembly Damage—<br>FDOT (31).....                          | 20          |
| Figure 2.20. Example of Unacceptable Barrier—FDOT (31).....  | 20          |
| Figure 2.21. Example of Unacceptable Barrier with Broken Concrete at Anchor Slot<br>Due to Shear Cracking—FDOT (31)..... | 20          |
| Figure 3.1. Examples of Connection Systems—ALDOT (33).....   | 25          |
| Figure 3.2. Unacceptable Barrier—IDOT (34).....  | 26          |
| Figure 3.3. Examples of Barrier Conditions—ODOT (38).....  | 28          |
| Figure 3.4. Spalling and Chipping—WisDOT (43).....   | 31          |
| Figure 3.5. Opening in Barrier Causing Snag Point—WisDOT (43).....   | 32          |
| Figure 3.6. Loop Unacceptable Condition—WisDOT (43).....   | 32          |
| Figure 5.1. Surrogate Test Vehicle for Single-Slope Barrier.....   | 49          |
| Figure 5.2. Single-Slope Barrier prior to Test No. 440590-01-B1.....   | 50          |
| Figure 5.3. Target Impact Point on SS-1 for Test No. 440590-01-B1.....   | 50          |
| Figure 5.4. Single-Slope Barrier after Test No. 440590-01-B1.....  | 51          |
| Figure 5.5. Impact Frames for Test No. 440590-01-B1 on Single-Slope Barrier.....   | 52          |
| Figure 5.6. Single-Slope Barrier prior to Test No. 440590-01-B8.....   | 53          |
| Figure 5.7. Target Impact Point on SS-4 for Test No. 440590-01-B8.....   | 53          |
| Figure 5.8. Single-Slope Barrier after Test No. 440590-01-B8.....  | 54          |
| Figure 5.9. Impact Frames for Test No. 440590-01-B8 on Single-Slope Barrier.....   | 55          |
| Figure 5.10. Single-Slope Barrier prior to Test No. 440591-01-B2.....  | 56          |



|  |    |
|--|----|
| Figure 5.11. Target Impact Point on SS-2 for Test No. 440591-01-B2. ....   | 56 |
| Figure 5.12. Single-Slope Barrier after Test No. 440591-01-B2.....   | 57 |
| Figure 5.13. Impact Frames for Test No. 440591-01-B2 on Single-Slope Barrier. ....   | 58 |
| Figure 5.14. Single-Slope Barrier prior to Test No. 440591-01-B9. ....   | 59 |
| Figure 5.15. Target Impact Point on SS-5 for Test No. 440591-01-B9. ....   | 59 |
| Figure 5.16. Single-Slope Barrier after Test No. 440591-01-B9.....   | 60 |
| Figure 5.17. Impact Frames for Test No. 440591-01-B9 on Single-Slope Barrier. ....   | 61 |
| Figure 5.18. Single-Slope Barrier prior to Test No. 440591-01-B7. ....   | 62 |
| Figure 5.19. Target Impact Point on SS-3 for Test No. 440591-01-B7. ....   | 62 |
| Figure 5.20. Single-Slope Barrier after Test No. 440591-01-B7.....   | 63 |
| Figure 5.21. Impact Frames for Test No. 440591-01-B7 on Single-Slope Barrier. ....   | 64 |
| Figure 5.22. Single-Slope Barrier prior to Test No. 440591-01-B10. ....  | 65 |
| Figure 5.23. Target Impact Point on SS-6 for Test No. 440591-01-B10. ....  | 65 |
| Figure 5.24. Single-Slope Barrier after Test No. 440591-01-B10.....  | 66 |
| Figure 5.25. Impact Frames for Test No. 440591-01-B10 on Single-Slope Barrier. ....  | 67 |
| Figure 5.26. F-Shape Barrier prior to Test No. 440590-01-B3. ....  | 68 |
| Figure 5.27. Target Impact Point on F-1 for Test No. 440590-01-B3.....   | 68 |
| Figure 5.28. F-Shape Barrier after Test No. 440590-01-B3. ....   | 69 |
| Figure 5.29. Impact Frames for Test No. 440590-01-B3 on F-Shape Barrier.....   | 70 |
| Figure 5.30. F-Shape Barrier prior to Test No. 440590-01-B11. ....   | 71 |
| Figure 5.31. Target Impact Point on F-4 for Test No. 440590-01-B11.....  | 71 |
| Figure 5.32. F-Shape Barrier after Test No. 440590-01-B11. ....  | 72 |
| Figure 5.33. Impact Frames for Test No. 440590-01-B11 on F-Shape Barrier.....  | 73 |
| Figure 5.34. F-Shape Barrier prior to Test No. 440591-01-B4. ....  | 74 |
| Figure 5.35. Target Impact Point on F-2 for Test No. 440591-01-B4.....   | 74 |
| Figure 5.36. F-Shape Barrier after Test No. 440591-01-B4. ....   | 75 |
| Figure 5.37. Impact Frames for Test No. 440591-01-B4 on F-Shape Barrier.....   | 76 |
| Figure 5.38. F-Shape Barrier prior to Test No. 440591-01-B12. ....   | 76 |
| Figure 5.39. Target Impact Point on F-5 for Test No. 440591-01-B12.....  | 76 |
| Figure 5.40. F-Shape Barrier after Test No. 440591-01-B12.....   | 78 |
| Figure 5.41. Impact Frames for Test No. 440591-01-B12 on F-Shape Barrier.....  | 79 |
| Figure 6.1. Low-Profile Barrier prior to Test No. 440591-01-B5. ....   | 81 |
| Figure 6.2. Target Impact Point on LP-1 for Test No. 440591-01-B5. ....  | 82 |
| Figure 6.3. Low-Profile Barrier after Test No. 440591-01-B5.....   | 83 |
| Figure 6.4. Impact Frames for Test No. 440591-01-B5 on Low-Profile Barrier.....  | 84 |
| Figure 6.5. Low-Profile Barrier prior to Test No. 440591-01-B6. ....   | 84 |
| Figure 6.6. Target Impact Point on LP-2 for Test No. 440591-01-B6. ....  | 85 |
| Figure 6.7. Low-Profile Barrier after Test No. 440591-01-B6.....   | 86 |
| Figure 6.8. Impact Frames for Test No. 440591-01-B6 on Low-Profile Barrier.....  | 87 |
| Figure 7.1. Bogie Positioned to Impact Perpendicularly at the Center of the Four-Segment<br>Barrier Assembly, Nominal Speed = 18 mi/h. ....                                  | 90 |
| Figure 7.2. Comparison of Actual Bogie Test (Left) and Bogie-Barrier Impact Simulation<br>(Right) in LS-DYNA for Both (a) Single-Slope and (b) F-Shape Barrier Systems. .... | 91 |
| Figure 7.3. Initial Position of RAM Pickup Truck. ....   | 93 |
| Figure 7.4. Truck–Single-Slope Barrier Interaction through Various Stages.....   | 94 |
| Figure 7.5. Post-Impact Trajectory of the RAM Pickup Truck. ....   | 95 |

|   |     |
|---|-----|
| Figure 7.6. Initial Position of Toyota Yaris Passenger Car. ....  | 96  |
| Figure 7.7. Car–Single-Slope Barrier Interaction through Various Stages. ....   | 96  |
| Figure 7.8. Post-Impact Trajectory of the Toyota Yaris Passenger Car. ....  | 97  |
| Figure 7.9. Pre-damaged Barrier with Adjacent Toes Having Spall of Length = 13 inches,<br>Width = 4 inches, Depth = 2 inches. ....                  | 98  |
| Figure 7.10. Truck–F-Shape Barrier Interaction through Various Stages. ....   | 102 |
| Figure 7.11. Post-Impact Trajectory of the RAM Pickup Truck. ....   | 103 |
| Figure 7.12. Pre-damaged F-Shape Barrier with Adjacent Toes Having Spall of Length =<br>13 inches, Width = 4 inches, Depth = 2 inches. ....         | 104 |
| Figure 7.13. Car–F-Shape Barrier Interaction through Various Stages. ....   | 105 |
| Figure 7.14. Post-Impact Trajectory of the Toyota Yaris Passenger Car. ....   | 106 |
| Figure 7.15. Undeformed JJ Hook Connectors with $d_{b0} = 28$ mm. ....  | 107 |
| Figure 7.16. Pre-deformed JJ Hook Connectors with $d_{b1} = 35.8$ mm and Rotation Angle<br>( $a_1$ ) = 4 deg. ....                                  | 107 |
| Figure 7.17. Pre-deformed JJ Hook Connectors with $d_{b1} = 35.8$ mm Open to $d_{b2} = 39$ mm<br>and Rotation Angle Increased from 4 deg. ....      | 108 |
| Figure 7.18. Pre-deformed JJ Hook Connectors with $d_{b1} = 35.8$ mm and Rotation Angle<br>( $a_2$ ) = 16.4 deg. ....                               | 108 |
| Figure 7.19. Pre-deformed JJ Hook Connectors with $d_{b1} = 35.8$ mm Open to $d_{b4} = 52.4$ mm<br>and Rotation Angle Increased from 16.4 deg. .... | 108 |
| Figure 7.20. Pair of Undeformed and Pre-deformed JJ Hook Connectors: $d_{b1} = 35.8$ mm,<br>$a_2 = 16.4$ deg. ....                                  | 109 |
| Figure 7.21. Pre-deformed JJ Hook Open to $d_{b5} = 50.5$ mm; Originally Undeformed Hook<br>Open to $d_{b6} = 50.0$ mm. ....                        | 109 |
| Figure 8.1. Damaged Portable Concrete Barrier before Test No. 440592-1. ....  | 114 |
| Figure 8.2. Damaged Portable Concrete Barrier before Test No. 440592-2. ....  | 114 |
| Figure 8.3. Test Installation Layout for Test No. 440592-1. ....  | 115 |
| Figure 8.4. Test Installation Layout for Test No. 440592-2. ....  | 116 |
| Figure 8.5. Reinforcement Details for PCB Segments Used in Test Nos. 440592-1 and -2. ....  | 116 |
| Figure 8.6. Connection Details for PCB Segments Used in Test Nos. 440592-1 and -2. ....   | 117 |
| Figure 8.7. Damaged Portable Concrete Barrier after Test No. 440592-1. ....   | 120 |
| Figure 8.8. Vehicle after Test No. 440592-1. ....   | 121 |
| Figure 8.9. Summary of Results for Test No. 440592-1, Sequential Test Pictures. ....  | 125 |
| Figure 8.10. Summary of Results for Test No. 440592-1, Summary Drawing. ....  | 126 |
| Figure 8.11. Damaged Portable Concrete Barrier after Test No. 440592-2. ....  | 129 |
| Figure 8.12. Vehicle after Test No. 440592-2. ....  | 130 |
| Figure 8.13. Summary of Results for Test No. 440592-2, Sequential Test Pictures. ....   | 134 |
| Figure 8.14. Summary of Results for Test No. 440592-2, Summary Drawing. ....  | 135 |
| Figure 9.1. Spalling—Evaluation Criteria Flowchart. ....  | 141 |
| Figure 9.2. Cracking—Evaluation Criteria Flowchart. ....  | 155 |
| Figure 9.3. Quantification of the Rotation of the JJ Hook Using a Ruler and Protractor. ....  | 164 |
| Figure 9.4. Measurement of JJ Hook Rotation Using Geometry. ....  | 164 |
| Figure 9.5. JJ Hook Connections—Evaluation Criteria Flowchart. ....   | 165 |
| Figure 9.6. Drilling Holes in the Concrete Member (54). ....  | 172 |
| Figure 9.7. Section Showing Holes Drilled at an Angle (54). ....  | 172 |
| Figure 9.8. Installing Injection Ports (54). ....   | 173 |

|  |     |
|--|-----|
| Figure 9.9. Injection of Epoxy Resin into the Holes (54).....  | 174 |
| Figure 9.10. Injection of Epoxy: (a) Using a Gun That Does Not Require Fittings to Be Bonded to the Concrete Surface; (b) Section Showing Drilled Holes and a Crack Filled with Repair Material (54). .... | 174 |
| Figure 9.11. Removal of Surface Sealer and Installation Ports after the Resin Cures (54).....  | 175 |
| Figure A.1. Single-Slope Concrete Barrier with JJ Hook.....  | 185 |
| Figure A.2. F-Shape Concrete Barrier with JJ Hook.....   | 186 |
| Figure A.3. Low-Profile Concrete Barrier.....  | 187 |
| Figure B.1. Summary of VOR Calculations for Project 0-7059.....  | 192 |

## LIST OF TABLES

|   | <b>Page</b> |
|---|-------------|
| Table 2.1. NYSDOT Criteria for Acceptability of PCBs (27).....                    | 14          |
| Table 2.2. Illinois Criteria for Acceptability of PCBs (28).....                  | 17          |
| Table 2.3. ATSSA Criteria for Acceptability of PCBs (29). ....                    | 18          |
| Table 2.4. FDOT Criteria for Acceptability of PCBs (31). ....                     | 19          |
| Table 2.5. KDOT Criteria for Acceptability of PCBs (32).....                      | 21          |
| Table 3.1. Responses to State DOT Survey on PCB Inspection Guidance. ....         | 23          |
| Table 3.2. Summary of Agencies with Inspection Guidance.....                      | 24          |
| Table 3.3. IDOT Evaluation Criteria for PCBs (34).....                            | 26          |
| Table 3.4. NJDOT Unacceptable Deficiencies in PCBs (36).....                      | 27          |
| Table 3.5. ODOT Evaluation Criteria for PCBs (37). ....                           | 28          |
| Table 3.6. SCDOT Evaluation Criteria for PCBs (40). ....                          | 29          |
| Table 3.7. WisDOT Acceptable PCB Conditions (43).....                             | 31          |
| Table 3.8. Summary of Agencies without Inspection Guidance. ....                  | 33          |
| Table 3.9. Summary of Agencies with “Other” Responses (Inspection Guidance). .... | 34          |
| Table 3.10. DOT Inspection Procedures.....  | 34          |
| Table 3.11. Responses to State DOT Survey on PCB Evaluation Guidance.....         | 35          |
| Table 3.12. Summary of Agencies with Evaluation Guidance.....                     | 36          |
| Table 3.13. IADOT Evaluation Criteria for PCBs (44).....                          | 37          |
| Table 3.14. Summary of Agencies without Evaluation Guidance.....                  | 38          |
| Table 3.15. Responses of State DOTs on PCB Repair Guidance.....                   | 39          |
| Table 3.16. Summary of Agencies with Repair Guidance.....                         | 39          |
| Table 3.17. Summary of Agencies without Repair Guidance. ....                     | 41          |
| Table 3.18. Summary of Agencies with “Other” Responses (Repair Guidance). ....    | 42          |
| Table 4.1. Summary of Districts with Inspection Guidance.....                     | 43          |
| Table 4.2. Summary of Districts without Inspection Guidance.....                  | 44          |
| Table 4.3. Summary of Districts with “Other” Responses (Inspection Guidance)..... | 44          |
| Table 4.4. Summary of Districts with Evaluation Guidance.....                     | 45          |
| Table 4.5. Summary of Districts without Evaluation Guidance.....                  | 45          |
| Table 4.6. Summary of Districts with “Other” Responses (Evaluation Guidance)..... | 45          |
| Table 4.7. Summary of Districts with Repair Guidance.....                         | 46          |
| Table 4.8. Summary of Districts without Repair Guidance.....                      | 47          |
| Table 4.9. Summary of Districts with “Other” Responses (Repair Guidance).....     | 47          |
| Table 5.1. Events during Test No. 440590-01-B1.....                               | 50          |
| Table 5.2. Occupant Risk Factors for Test No. 440590-01-B1.....                   | 52          |
| Table 5.3. Events during Test No. 440590-01-B8.....                               | 53          |
| Table 5.4. Occupant Risk Factors for Test No. 440590-01-B8.....                   | 55          |
| Table 5.5. Events during Test No. 440591-01-B2.....                               | 56          |
| Table 5.6. Occupant Risk Factors for Test No. 440591-01-B2.....                   | 58          |
| Table 5.7. Events during Test No. 440591-01-B9.....                               | 59          |
| Table 5.8. Occupant Risk Factors for Test No. 440591-01-B9.....                   | 61          |
| Table 5.9. Events during Test No. 440591-01-B7.....                               | 62          |
| Table 5.10. Occupant Risk Factors for Test No. 440591-01-B7.....                  | 64          |
| Table 5.11. Events during Test No. 440591-01-B10.....                             | 65          |

|   |     |
|---|-----|
| Table 5.12. Occupant Risk Factors for Test No. 440591-01-B10. ....  | 67  |
| Table 5.13. Events during Test No. 440590-01-B3. ....   | 68  |
| Table 5.14. Occupant Risk Factors for Test No. 440590-01-B3. ....   | 70  |
| Table 5.15. Events during Test No. 440590-01-B11. ....  | 71  |
| Table 5.16. Occupant Risk Factors for Test No. 440590-01-B11. ....  | 72  |
| Table 5.17. Events during Test No. 440591-01-B4. ....   | 74  |
| Table 5.18. Occupant Risk Factors for Test No. 440591-01-B4. ....   | 75  |
| Table 5.19. Events during Test No. 440591-01-B12. ....  | 77  |
| Table 5.20. Occupant Risk Factors for Test No. 440591-01-B12. ....  | 78  |
| Table 6.1. Events during Test No. 440591-01-B5. ....  | 82  |
| Table 6.2. Occupant Risk Factors for Test No. 440591-01-B5. ....  | 83  |
| Table 6.3. Events during Test No. 440591-01-B6. ....  | 85  |
| Table 6.4. Occupant Risk Factors for Test No. 440591-01-B6. ....  | 86  |
| Table 7.1. TRAP Values for RAM Pickup Truck Impacting an Undamaged Single-Slope<br>Barrier. ....                          | 95  |
| Table 7.2. TRAP Values for Toyota Yaris Passenger Car Impacting an Undamaged<br>Single-Slope Barrier. ....                | 98  |
| Table 7.3. TRAP Values for RAM Pickup Truck Impacting a Single-Slope Barrier with<br>Two Spalled Toes. ....               | 99  |
| Table 7.4. TRAP Values for Toyota Yaris Passenger Car Impacting a Single-Slope Barrier<br>with Two Spalled Toes. ....     | 99  |
| Table 7.5. Comparison of TRAP Results for Simulations Involving Pickup Truck<br>Impacting the Single-Slope Barrier. ....  | 100 |
| Table 7.6. Comparison of TRAP Results for Simulations Involving Passenger Car<br>Impacting the Single-Slope Barrier. .... | 100 |
| Table 7.7. TRAP Values for RAM Pickup Truck Impacting an Undamaged F-Shape<br>Barrier. ....                               | 103 |
| Table 7.8. TRAP Values for RAM Pickup Truck Impacting an F-Shape Barrier with Two<br>Spalled Toes. ....                   | 104 |
| Table 7.9. TRAP Values for Toyota Yaris Passenger Car Impacting an F-Shape Barrier<br>with Two Spalled Toes. ....         | 107 |
| Table 7.10. F-Shape Barriers with Preexisting Deformations in JJ Hooks. ....  | 110 |
| Table 8.1. Impact Conditions for <i>MASH</i> Test 3-11, Test No. 440592-1. ....   | 117 |
| Table 8.2. Exit Parameters for <i>MASH</i> Test 3-11, Test No. 440592-1. ....   | 118 |
| Table 8.3. Vehicle Measurements for Test No. 440592-1. ....   | 118 |
| Table 8.4. Weather Conditions for Test No. 440592-1. ....   | 118 |
| Table 8.5. Events during Test No. 440592-1. ....  | 119 |
| Table 8.6. Barrier Movement of Damaged Portable Concrete Barrier, Test No. 440592-1. ....                                 | 119 |
| Table 8.7. Damage to Damaged Portable Concrete Barrier, Test No. 440592-1. ....   | 120 |
| Table 8.8. Occupant Compartment Deformation, Test No. 440592-1. ....  | 121 |
| Table 8.9. Damage to Vehicle, Test No. 440592-1. ....   | 121 |
| Table 8.10. Occupant Risk Factors for Test No. 440592-1. ....   | 122 |
| Table 8.11. Summary of Results for Test No. 440592-1, General Information, Impact and<br>Exit Conditions. ....            | 123 |
| Table 8.12. Summary of Results for Test No. 440592-1, Occupant Risk, Vehicle and Test<br>Article Damage. ....             | 124 |

|  |     |
|--|-----|
| Table 8.13. Impact Conditions for <i>MASH</i> 3-11, Test No. 440592-2.....   | 126 |
| Table 8.14. Exit Parameters for <i>MASH</i> 3-11, Test No. 440592-2. ....  | 126 |
| Table 8.15. Vehicle Measurements for Test No. 440592-2.....  | 127 |
| Table 8.16. Weather Conditions for Test No. 440592-2.....  | 127 |
| Table 8.17. Events during Test No. 440592-2.....   | 127 |
| Table 8.18. Barrier Movement of Damaged Portable Concrete Barrier, Test No. 440592-2.....  | 128 |
| Table 8.19. Damage to Damaged Portable Concrete Barrier, Test No. 440592-2. ....   | 128 |
| Table 8.20. Occupant Compartment Deformation, Test No. 440592-2.....   | 129 |
| Table 8.21. Damage to Vehicle, Test No. 440592-2. ....   | 130 |
| Table 8.22. Occupant Risk Factors for Test No. 440592-2. ....  | 131 |
| Table 8.23. Summary of Results for <i>MASH</i> Test 3-11 on Damaged Portable Concrete<br>Barrier, Test No. 440592-2. ....            | 132 |
| Table 8.24. Summary of Results for Test No. 440592-2, Occupant Risk, Vehicle and Test<br>Article Damage. ....                        | 133 |
| Table 8.25. Performance Evaluation Summary for <i>MASH</i> Test 3-11 on Damaged Portable<br>Concrete Barrier, Test No. 440592-1..... | 136 |
| Table 8.26. Performance Evaluation Summary for <i>MASH</i> Test 3-11 on Damaged Portable<br>Concrete Barrier, Test No. 440592-2..... | 136 |
| Table 8.27. Assessment Summary for <i>MASH</i> TL-3 Tests on Damaged Portable Concrete<br>Barriers.....                              | 137 |
| Table 9.1. Spalling—Acceptable Barriers. ....  | 142 |
| Table 9.2. Spalling—Acceptable Barriers with Repair. ....  | 147 |
| Table 9.3. Spalling—Unacceptable Barriers. ....  | 150 |
| Table 9.4. Cracking—Acceptable Barriers. ....  | 156 |
| Table 9.5. Cracking—Acceptable Barriers with Repair. ....  | 157 |
| Table 9.6. Cracking—Unacceptable Barriers. ....  | 161 |
| Table 9.7. JJ Hook Segment Connections—Acceptable Barriers.....  | 167 |
| Table 9.8. JJ Hook Segment Connections—Unacceptable Barriers.....  | 168 |
| Table B.1. Selected Benefit Areas for Project 0-7059.....  | 189 |

# 1. INTRODUCTION

Portable concrete barriers (PCBs) are roadway safety hardware designed to protect workers in construction zones from traffic. A PCB assembly contains and redirects vehicles during accidents and prevents vehicles from entering a construction zone while also protecting drivers. PCBs are made of precast shaped sections (e.g., F-shape, single slope, and low profile) joined together with appropriate connections to form a continuous longitudinal barrier.

Defining the service life of PCBs is important to reduce the risk of inferior, unsafe barriers being used on Texas roadways. The *Manual for Assessing Safety Hardware (MASH)* implementation agreement allows state transportation agencies to continue the use of PCBs manufactured on or before December 31, 2019, and successfully tested to standards in National Cooperative Highway Research Program (NCHRP) Report 350 or the 2009 edition of *MASH* throughout their normal service life. Damage to the precast barriers can occur in transit, in storage, or due to vehicular impact. When damage to the connections occurs, cracks, broken corners, and many other forms of damage can be sustained by the barrier. No federal guidance, however, has been developed to determine life expectancy for PCBs. There is a need to develop guidelines addressing the type and extent of barrier damage that constitute replacement of the segment. Continuing to use severely damaged barriers and not replacing them in a timely manner can pose a safety risk, while replacing them too early underestimates their design life and creates an economic burden on state departments of transportation (DOTs).

To help meet this need, the research team documented best practices with respect to repairing or replacing PCB segments and utilized a combination of engineering evaluation, dynamic component testing, and full-scale crash testing to develop guidelines to assist in designing a process to determine useful service life.

These guidelines aim to help the engineer in charge determine if the PCB is appropriate to use at several work stages, such as upon delivery to the project site, during initial setup, during phase changes, and periodically throughout the duration of the project. The guidelines require the engineer to thoroughly assess the condition of the concrete surface and reinforcement; match the findings with the expectations of acceptability, repairability, and unacceptability illustrated in this guidance; and accordingly classify the PCB as acceptable, acceptable with repair, or unacceptable.

Repair has been recommended in cases of minor defects. The repair methodology prescribed is in line with the 2021 *Concrete Repair Manual*, issued by the Texas Department of Transportation (TxDOT).

The most common profiles of portable barrier sections used by TxDOT are:

- F-shape.
- Single slope.
- Low profile.

Appendix A provides TxDOT drawings with the required dimension, reinforcement, and connection details for these barriers.

Chapter 2 of this report summarizes the literature that was reviewed to identify existing guidance on determining life expectancy of PCBs. Chapters 3 and 4 report the results from surveys distributed to state DOTs and TxDOT districts, respectively. These surveys were designed to identify existing PCB inspection, assessment, and repair guidance. Chapters 5 and 6 summarize the efforts and results from dynamic component testing conducted on typical TxDOT PCB segments (single slope, F-shape, and low profile). The scope of the component testing was to assess the (a) baseline strength/deflection capacities of new barrier segments; (b) corresponding residual capacities of damaged barrier segments; and (c) defects, delamination, voids, cracks, cover depth, and rebar spacing. Chapter 7 describes the finite element (FE) computer simulations conducted to predict impact behavior of a vehicle impacting PCB segments with specific damage(s). Chapter 8 presents the damaged system segment crashworthiness results of the full-scale crash testing conducted according to *MASH* standards. A visual guidebook is proposed in Chapter 9 based on the information collected and the outcome of research/testing conducted and described in the previous chapters. Chapters 10 and 11 summarize the project objectives and products, as well as the proposed project research implementation directions, respectively.



## 2. PORTABLE CONCRETE BARRIERS

This chapter presents background information on PCBs, including common defects, inspection and evaluation criteria, and repair guidance.

### 2.1 DEFECTS COMMONLY FOUND IN PORTABLE CONCRETE BARRIERS

#### 2.1.1 Spalling

Spalling is the breaking of flakes of concrete from the barrier body. Spalled concrete zones look like depressions along the barrier surface and corners. Figure 2.1 shows spalled zones at different locations in PCBs.



a. Spall on the Middle Base of the Barrier



b. Spall on the Toe of the Barrier

**Figure 2.1. Real-Life Spalling Observed in Crash Barriers from a Stockyard.**

#### 2.1.1.1 Causes of Spalling

Spalling can be caused by mishandling during transportation and placement, corrosion of embedded rebars, improper construction practices (e.g., inadequate curing, using a non-air-entrained concrete mix), fire accidents, vehicle impacts, and more.

#### **2.1.1.1.1 Transportation, Handling, and Placement of Portable Concrete Barrier Segments**

Portions of PCBs are likely to get spalled off by varying degrees depending on the extent to which they are impacted when they are transported from the precast yard to the jobsite and placed next to each other by forklift or crane.

The heavy weight of PCBs makes their transportation and handling inconvenient and expensive. Weight of a PCB ranges from 4800 lb to over 20,000 lb depending on the segment length and cross-sectional dimensions. In addition to the weight, the size of PCBs also plays an important role in deciding the number of PCB segments that can be transported in a single truckload. The typical width of a PCB is approximately 24 inches. The available length and width of a trailer are 40 ft and 7.5 ft, respectively. This allows three PCB segments to fit along the width of a trailer (1).

Given these considerations of size and weight, several truckloads are required to achieve the desired protected length. An increase in the number of trips needed to transport PCBs from the yard to the jobsite therefore increases the chances of the PCBs getting damaged during transit and placement.

#### **2.1.1.1.2 Corrosion of Rebars Embedded within the Concrete Barrier**

When the rebar is exposed to moisture and water, possibly because of inadequate cover or surface irregularity, a chemical reaction takes place, resulting in the formation of iron oxide (rust) on the rebar surface. Due to the production of iron oxide, the rebar volumetrically expands by up to six times its original volume. This increase in volume imposes significant expansive forces on the surrounding concrete, which can cause a chunk of the concrete to spall and break off. Spalling increases access of air and water to the rebar embedded within the barrier and creates a cycle of corrosion, exacerbating the process with each subsequent cycle (2). Figure 2.2 shows an example of a barrier with a corroded rebar and spalled concrete.



**Figure 2.2. Corrosion of Reinforcing Bar Embedded in the Toe of the Concrete Barrier.**

### 2.1.1.1.3 Use of Non-Air-Entrained Concrete Mix

Air-entrained concrete uses a chemical admixture to produce a system of small voids during the mixing process. This admixture stabilizes the voids and keeps them suspended in the hardened concrete paste. During a freeze event, air voids provide pressure relief sites, allowing the water inside the concrete to freeze without inducing large internal stresses. The air voids also provide relief against the buildup of salt concentrations and the pressures that result due to concentration gradients. Having non-air-entrained concrete mix instead weakens the resistance against the freeze-thaw cycle, sulfates, and alkali-silica reactivity, which causes the concrete to flake or spall off (3).

### 2.1.1.1.4 Inadequate Curing

The curing of concrete is the process of maintaining moisture inside the concrete body during early life and beyond to develop the desired properties in terms of strength and durability. A good practice of curing involves keeping the concrete damp until it reaches the desirable strength (4). Insufficient curing leads to a weak surface skin susceptible to spall off if exposed to freezing and thawing in the presence of moisture and deicing salts (5).

### 2.1.1.1.5 Fire Damage

During fires, concrete can suffer extensive damage from temperature shock. When concrete is subjected to extreme heat, its outer layers expand more quickly than the inner sections. This differential expansion causes the concrete layers to separate and eventually break away (6).

### 2.1.1.1.6 Impact/Crash Loading

Vehicles crashing against the barrier during road accidents results in portions of the concrete breaking away (Figure 2.3). Depending on the vehicle type, impact speed, and angle, the extent of spalling may vary.



**Figure 2.3. Spalling at the Toe of Barrier E Due to a Vehicle Crashing into the Joint between Barriers A and E.**

## **2.1.1.2 How Spalling Affects Performance of Concrete Barriers**

### **2.1.1.2.1 Potential Snag Points**

A snag point is a projection or depression that is of such magnitude that it can impart a strong longitudinal force to an impacting vehicle. If the vehicle snags, the strong force can cause high rates of deceleration and potential injuries to the occupants. If the strong force acts on a corner of the vehicle, the force can cause the vehicle to yaw, resulting in a potential rollover. The snagged element might also get deformed and penetrate the passenger compartment.

The effect of a snag point differs according to the type of vehicle. If a small vehicle hits the barrier, the vehicle can lean and get exposed to a snag point on the top of the barrier. If a large vehicle hits the barrier, the vehicle can cause the barrier to tilt, lift the toe, and snag strong elements low on the vehicle.

Snag points can be created at different locations, such as the top, edge, or toe. Depending on where the snag point is present, post-impact barrier performance and vehicle trajectory are affected differently. For example:

- If the top edge is broken out at the lift point, the vehicle could get snagged to either the left or right. The snag point could catch the leading part of a door frame and crush it toward the passenger sitting in the vehicle.
- If the snag point is at the toe, the barrier leans when it is strongly impacted. Areas broken out of the toe may be lifted above the bottom of the tire rims. At this height, they could snag other elements of the vehicle (6).

### **2.1.1.2.2 Increased Risk of Corrosion of Reinforcement Bars**

Spalling exposes the embedded steel rebar to both water and air, which causes it to rust. Iron from the steel rebar reacts with water and air to produce iron oxide (rust). Rust is up to six times more massive than the steel on which it deposits. The increase in rust mass creates a tensile stress that causes the surrounding concrete to crack and spall more. Spalling increases access of air and water to the reinforcing steel within a member, which creates a cycle of corrosion, exacerbating the process with each subsequent cycle (2, 7).

### **2.1.1.2.3 Increased Deflection of the Concrete Barrier**

Spalling leads to a reduced cross-sectional area of the concrete member and decreases its ability to safely carry imposed loads. The reduced cross-sectional area causes a significant reduction in the moment of inertia, which causes the deflection of the barrier to increase.

## **2.1.2 Cracking**

Cracks in concrete are complete or incomplete separation of the material into two or more parts through breaking or fracturing. Figure 2.4 shows cracks of varying extent at different locations of PCBs.



**Figure 2.4. Cracking in Portable Concrete Barriers (8).**

### **2.1.2.1 Causes of Cracking**

Cracking may be caused by a variety of factors, such as tight clamping of lifting devices; mishandling during stacking, lifting, and loading; errors in design and detailing; shrinkage; chemical reactions; corrosion of reinforcement; poor construction practices; and more (9).

#### **2.1.2.1.1 Tight Clamping of Lifting Devices**

The excessively tightened grip of lifting devices may lead to clustered horizontal cracks in the upper portion of the barrier stem. Figure 2.5 shows an example of clustered horizontal cracks.



**Figure 2.5. Clustered Horizontal Cracks Due to the Tight Clamping of Lifting Devices (10).**

#### **2.1.2.1.2 Mishandling during Stacking, Lifting, and Loading**

Figure 2.6 shows the various stages of the transportation of PCBs: stacking, lifting, and loading. At any of these stages, precast reinforced concrete barriers may be subject to stresses that overload them. If these stresses are encountered in the concrete's early life, the stresses may lead to permanent cracks in the barrier (11). Precast concrete barrier units should be lifted after the concrete has gained the required strength. Lifting before the development of the desired strength causes the concrete to crack. Insufficient capacity of the lifting devices also causes damage to the barrier.





a. Stacking (12)



b. Single-point lifting (13)



c. Loading (14)



d. Two-point lifting (15)

**Figure 2.6. Various Stages in the Transportation of PCBs.**

### 2.1.2.1.3 Errors in Design and Detailing

One important aspect of design is ensuring sufficient and properly detailed reinforcement to withstand the bending stresses during lifting. Depending on the way the barrier is lifted, it could behave either as a cantilever beam (Figure 2.6b) or as a continuous beam (Figure 2.6d). The design engineer must have the correct sense of these support conditions to design the reinforcement area. Otherwise, the barrier is bound to crack on the tension side.

#### 2.1.2.1.4 Shrinkage

Water in excess of the required amount is added to concrete mix to provide adequate workability for its placement and consolidation. Loss of some of this excess water from the concrete matrix as it hardens results in a volume reduction, which is known as *shrinkage*.

If the volume reduction occurs before the concrete has hardened, it is called *plastic shrinkage*. Plastic shrinkage occurs via two modes: evaporation and absorption. Evaporation, the predominant mode, depends on a combination of factors: wind speed, relative humidity, and temperature. If the loss of moisture from an exposed surface exceeds the rate at which bleed water reaches the surface, the plastic shrinkage mechanism sets in.

The volume reduction that occurs due to moisture loss after the concrete has hardened is called *drying shrinkage*. Drying shrinkage occurs via complex mechanisms, but in general it involves the loss of adsorbed water from the hydrated cement paste. When concrete is initially exposed to a drying condition in which there is a difference between the relative humidity of the environment and that of the concrete, it first loses free water. In larger capillary pores, this leads to little or no shrinkage, whereas in the finer water-filled capillary pores (2.5 to 50 nm), due to the loss of moisture, menisci (the curved upper surface of a liquid in a tube) are formed, and the surface tension of water pulls the walls of the pores. Internal negative pressure developed due to the formation of menisci in the capillary pores results in a compressive force that leads to concrete shrinkage. The thickness of the adsorbed water layer is reported to increase with increasing humidity. Therefore, a higher water content leads to a thicker layer of adsorbed water and more drying shrinkage.

When the shrinkage movement is opposed by external or internal restraint, stresses develop. When these stresses exceed the tensile capacity of the concrete, cracks develop. Therefore, shrinkage should be considered at the design stage with appropriate detailing of reinforcement to minimize cracking. Usually, it takes several months to 4 years after casting for these cracks to form, depending on the rate of drying.

Concrete near the corners and edges is vulnerable to cracking because loss of moisture takes place from the adjacent surfaces. There is no typical pattern that drying shrinkage cracking follows because the cracks form at any location where there is a restraint to shrinkage movement. Shrinkage cracks usually develop approximately at right angles to the direction of restraint (16, 17). Figure 2.7 shows examples of shrinkage cracks.



**Figure 2.7. Shrinkage Cracks (18).**

### 2.1.2.1.5 Chemical Reactions

Chemical reactions can be due to the materials used in the concrete mix employed to cast the barrier or the materials the concrete mix may have encountered. Cracking is caused by the expansive reactions that take place between the aggregate and alkalis in the cement paste. The chemical reaction taking place between active silica and alkalis produces an alkali-silica gel as a byproduct. This gel forms around the aggregate surface, increasing its volume and putting pressure on the surrounding concrete. The increase in pressure can cause the tensile stresses to increase beyond the concrete's tensile strength, leading to cracks in concrete, as shown in Figure 2.8 (19).



**Figure 2.8. Crack Due to the Formation of More Voluminous Products (20).**

### 2.1.2.1.6 Corrosion of Steel Reinforcement

Three conditions that must be present to initiate corrosion are oxygen, moisture, and electron flow within steel. Elimination or limitation of any of these conditions reduces the corrosion of the steel reinforcement embedded in the concrete member, reducing the risk of cracking. Concrete provides a passive protection to the steel by forming a protective oxide coating around it in an alkaline environment. However, as carbonation alters the concrete's levels of alkalinity, corrosion may take place. Iron oxides and hydroxides are formed as byproducts during the corrosive reaction. As these byproducts form on the surface of the steel reinforcement, the volume of the rebar increases. This increase in volume increases the pressure on the concrete and causes radial cracking in the member because the tensile stresses developed in the concrete exceed the tensile strength (Figure 2.9). Repairing these cracks at the initial stage is important because as they become larger, oxygen and water have a greater chance to penetrate the concrete and accelerate the corrosion of the reinforcement (21).





**Figure 2.9. Crack Due to the Corrosion of Reinforcement (22).**

#### **2.1.2.1.7 Poor Construction Practices**

Numerous poor construction practices, such as increasing the cement content to offset a decrease in strength from the addition of water, inadequate curing, etc., can lead to cracking in concrete, as shown in Figure 2.10 (11).



**Figure 2.10. Crack-Like Formation Due to the Lack of Mixing of Two Batches of Concrete during the Pour (19).**

#### **2.1.2.2 How Cracking Affects Performance of Concrete Barriers**

##### **2.1.2.2.1 Separation of Concrete into Loose Debris and Reduced Ability to Redirect Vehicles**

Having multiple closely spaced horizontal cracks caused by the tightened grip of lifting devices weakens the strength of the stem. During an impact, these cracks reduce the ability of the barrier to redirect the vehicle and cause the concrete to separate in layers, flying off as debris that is detrimental to the safety of workers and incoming traffic (11).

##### **2.1.2.2.2 Corrosion of Embedded Reinforcement**

Cracks have a considerable impact on the durability of the barrier. Cracks enable the entry of foreign matter and aggressive substances into the concrete thickness. Studies have found that the eventual development of corrosion is independent of the crack width, whereas the time required

for corrosion to start *is* a function of crack width. Corrosion of the embedded reinforcement starts as soon as an electrolytic cell is established. This occurs when the carbonization of concrete reaches the steel or when the chlorides penetrate the concrete thickness and make their way to the bar surface. The time taken for this cell to establish depends not only on the presence of a crack, the crack width, and the surrounding environment but also on the thickness of cover and concrete permeability. After 5 to 10 years, the amount of corrosion is essentially independent of crack width (23).

In addition to chlorides, relative humidity and ambient temperatures also have an important role to play in initiating corrosion. Corrosion is most likely to occur if the relative humidity exceeds 60 percent. Alternate wetting and drying of the concrete at the level of steel also increases the chances of corrosion. High ambient temperature acts as a catalyst for the chemical reaction that is responsible for the corrosion action (23).

#### **2.1.2.2.3 Increase in Deflection**

When a reinforced concrete barrier section cracks, its moment of inertia decreases, leading to a decrease in its stiffness. When the barrier is further impacted, cracking increases, which causes a further reduction in stiffness. Eventually, the reinforcement yields at the impact point, leading to a large increase in deflection with minor change in load. Therefore, more impact loads lead to more cracking, which causes a progressive reduction of stiffness, which ultimately results in increased deflection.

Increased deflection of a PCB because of damage has some serious safety consequences, such as (24):

- PCB may slide farther than expected into the construction zone, making the workers prone to serious injuries.
- PCB may fall from an elevated structure into traffic, causing a fatal accident.
- More deflection of the barrier may lead to the redirection of the impacting vehicle away from the barrier at a very high angle, potentially into incoming traffic.
- PCB may fall into an excavation, injuring a worker or damaging a utility.

#### **2.1.2.2.4 Fatigue**

During service conditions when a barrier is repeatedly subject to loads (below the yielding point), slow propagation of microcracks can occur. These microcracks later form larger cracks, which eventually result in the failure of the barrier. Also, the barrier may be subject to cyclic loading of a magnitude higher than the yielding point, which leads to the failure of the barrier after a small number of cycles (25).

### **2.1.3 Damage to JJ Hook Connections**

F-shape and single-slope PCBs are connected via JJ hook connections, which consist of two identical J-shaped steel hooks connected internally with multiple steel rebars welded to each J hook (Figure 2.11). This assembly provides a self-aligning continuous steel connection throughout the barrier installation. The connection automatically hooks into place without

requiring workers to place their hands between the barrier units to make the connection. The major advantage of using JJ hooks to connect the barrier segments is that they are easy to install since the hooks are identical on both ends of the barrier. Since barriers can be vertically lifted, a single barrier unit can be removed without having to disturb the adjacent barrier units. There is no concern of lost or stolen hardware (bolts and pins) since this system is integrated in nature (26).



**Figure 2.11. JJ Hook Connections: Top View of a JJ Hook Connection between Barrier Units.**

The JJ hook connection may be damaged for various reasons, as discussed next.

### **2.1.3.1 Causes of Damage to JJ Hook Connection**

#### **2.1.3.1.1 Manufacturing Flaws or Insufficient Material Properties**

Any material discontinuity produced during the manufacturing of the JJ hook or plate may propagate to a bigger size because of repeated loading or corrosion, leading to the failure of the plate by brittle fracture (i.e., the plate fails at a stress well below the yield stress, and there is no or very little plastic deformation of the material, implying the full tensile capacity is not used).

The fracture toughness of the steel used to make the JJ hook and plate may be low because the steel may have had nonuniform properties as a result of improper heat treatment. If the barriers are used at a low service temperature (less than or equal to  $-20^{\circ}\text{F}$ ), the material of the JJ hook plate may become brittle because its operating temperature is near its transition temperature.

#### **2.1.3.1.2 Improper Transportation, Handling, and Placement**

Just as initial discontinuities during manufacturing can later propagate to a bigger size because of fatigue or corrosion and lead to brittle fracture, cracks caused by improper transportation and handling have the same effect on the JJ hook.

In addition, the hooks may get deformed, bent, or rotated if they are inadvertently impacted during transportation or handling.

### 2.1.3.1.3 Impact during Vehicular Collisions

Impact by vehicles during accidents transfers to JJ hooks, which in turn get deformed/rotated or suffer brittle failure. Rapid collision of the vehicle with the barrier assembly leads to an increase in the plate’s tendency to fail by brittle fracture, owing to the resulting low fracture toughness.

### 2.1.3.2 How Deformation of JJ Hook Connection Affects Performance of Concrete Barriers

Deformation or rotation of the JJ hook leads to the opening of the connection between the two barrier segments. Repeated vehicle collisions with the barrier assembly reduce its ability to redirect the vehicle and cause the eventual separation of the segments.

## 2.2 GUIDELINES ON THE INSPECTION AND EVALUATION OF PORTABLE CONCRETE BARRIERS

In the following subsections, several guidelines that deal with the inspection and evaluation of PCBs are presented. In general, the guidelines provide some quantitative measurements for cracks (longitudinal and transverse) and concrete spalling. Some guidelines provide more details about other types of damage, such as corner damage, snag risk, and connection system. When guidelines provide more details about other types of damage, the additional details are presented as well.

### 2.2.1 Acceptance Criteria for Damaged Temporary Concrete Barrier, NYSDOT

The main purpose of the New York State Department of Transportation (NYSDOT) criteria (27) is to provide guidance to inspectors on the acceptability of PCBs. The guideline has some pictures as examples for concrete barrier damage. Table 2.1 provides the criteria to determine the acceptability of PCBs.

**Table 2.1. NYSDOT Criteria for Acceptability of PCBs (27).**

| Defects                  | Unacceptable   |
|--------------------------|--|
| <b>Cracks</b>            | <p>A PCB piece has more than one transverse crack through the section, it is not acceptable (Figure 2.12).</p> <p>A PCB piece has an open crack running more than 4 ft longitudinally, it is not acceptable (Figure 2.13).</p> <p>A single crack exhibits evidence that the reinforcing bar is rusting, the piece is not acceptable.</p> |
| <b>Concrete Spalling</b> | <p>If spalled areas exceeding 12 inches in any direction, it is not acceptable.</p> <p>A corner of PCB has the depth of the spalling is 3 or more inches, it is not acceptable (Figure 2.14).</p>  |
| <b>Snag Risk</b>         | <p>A PCB has a surface that projects towards traffic by more than 30 degrees and that is exposed to a depth of greater than 1.75 inches for traffic approaching the barrier at a 25-degree angle, it is not acceptable (Figure 2.15 and Figure 2.16).</p>  |



a. Acceptable barrier



b. Unacceptable barrier

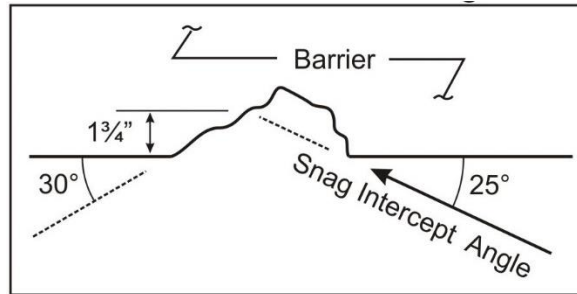
**Figure 2.12. Transverse Cracks—NYSDOT (27).**



**Figure 2.13. Longitudinal Cracks—NYSDOT (27).**



**Figure 2.14. Corner Damage—NYSDOT (27).**



**Figure 2.15. Threshold Criteria for Snag Point—NYSDOT (27).**



**Figure 2.16. Unacceptable Barrier Due to Snag Risk—NYSDOT (27).**

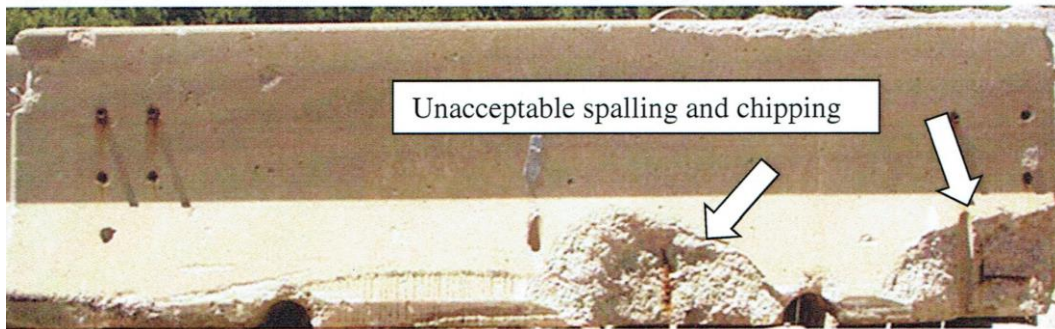
### **2.2.2 Quality Standard for Temporary Concrete Barrier, Illinois State Toll Highway Authority**

The Illinois State Toll Highway Authority guideline (28) presents three levels of evaluation: acceptable, marginal, and unacceptable. The guideline focuses on two important defects within the concrete barrier spalling of concrete and cracks. Table 2.2 provides the criteria to determine the acceptability of PCBs. Figure 2.17 provides examples of unacceptable PCBs.



**Table 2.2. Illinois Criteria for Acceptability of PCBs (28).**

| <b>Defects</b>           | <b>Acceptable</b>  | <b>Marginal</b>   | <b>Unacceptable</b>  |
|--------------------------|--|---|--|
| <b>Cracks</b>            | Cracks are tightly compressed, exhibiting no displacement and do not compromise the structural integrity of the wall.  | Cracks are tightly compressed, exhibiting no displacement and do not compromise the structural integrity of the wall. | Open cracks that extending completely through the barrier shall not be accepted. Barrier with cracks that extend from the edge of the wall base to the pinholes shall not be accepted. |
| <b>Concrete Spalling</b> | Concrete spalling, not greater than 1.5 inches in depth and 4.0 inches in length measured horizontally, vertically, or diagonally will not require patching if the exposed cavity has side slopes of at least 1:3 (V:H). | Concrete spalling, greater than 1.5 inches and up to and including a depth of 2.5 inches.                             | Concrete spalling, greater than 2.5 inches in depth.   |
| <b>Connection System</b> | The connecting loop bars are in place and in good condition.   | The connecting loops are all in place and in good condition.  | The connecting loop bars may be broken or damaged.   |



**Figure 2.17. Example of Unacceptable Barrier—Illinois (28).**

### 2.2.3 Quality Guidelines for Temporary Traffic Control Devices and Features, ATSSA

The American Traffic Safety Services Association’s (ATSSA’s) guideline (29) has qualitative measurements without providing any quantitative metrics to evaluate the conditions of the barrier. Three types of conditions (acceptable, marginal, and unacceptable) are utilized to evaluate the barrier conditions. Table 2.3 provides the criteria in the evaluation guide to determine the acceptability of PCBs. The guideline has some pictures as examples for the conditions of the barrier, as shown in Figure 2.18.

**Table 2.3. ATSSA Criteria for Acceptability of PCBs (29).**

| <b>Defects</b>             | <b>Acceptable</b>  | <b>Marginal</b>   | <b>Unacceptable</b>   |
|----------------------------|--|---|---|
| <b>Cracks and Spalling</b> | The walls appear new with few minor blemishes. Spalls and chipped concrete pose no threat of damaging or snagging tires. | The walls have minor spalls with hairline cracks and minor imperfections along the base but are still structurally sound. | Large spalls and cracks, with exposed rebar or unsound concrete that could be easily removed when hit. Any spalled concrete could cause the vehicle to “snag” and twist from the direction it is going. |
| <b>Connection System</b>   | The connecting system is all sound and in place with no broken parts.  | The connecting system is all sound and in place with no broken parts.   | The connecting system is broken or damaged.   |



a. Acceptable



b. Marginal



c. Unacceptable

**Figure 2.18. Barrier Examples—ATSSA (29).**



**2.2.4 Specification for Road Safety Hardware Systems (Appendix C: Temporary Road Safety Barrier Systems), New Zealand Transport Agency**

The New Zealand Transport Agency document (30) contains the important required specification for the temporary road safety barrier systems that are used in New Zealand. One of the systems is the JJ hook concrete barrier. The document provides some important considerations for the selection and installation of this barrier. A pre-inspection process is required to evaluate the conditions of the connections, and any concerns about the connection conditions should lead to disposal of the barrier. In addition, rewelding or retrofitting of the damaged connections (hooks) is prohibited.

**2.2.5 FDOT Evaluation Guide—Temporary Concrete Barrier, FDOT**

This Florida DOT (FDOT) guide (31) was developed to aid in evaluating the condition of PCBs used in work zones and is based, in part, on information published by ATSSA. This guide illustrates examples of FDOT-specific PCBs, which include Type K, proprietary concrete (i.e., JJ hook), and low-profile barriers, categorized into acceptable and unacceptable conditions. FDOT notes that this document should be used in conjunction with good engineering judgment. Table 2.4 provides the FDOT criteria to determine the acceptability of PCBs. Figure 2.19 through Figure 2.21 show examples.

**Table 2.4. FDOT Criteria for Acceptability of PCBs (31).**

| <b>Defects</b>           | <b>Acceptable</b>   | <b>Unacceptable</b>   |
|--------------------------|---|---|
| <b>Cracks</b>            | No structural cracks or cracks that exist through the entire cross-section                        | The barrier has multiple cracks throughout, structural cracks or cracks through the entire cross-section, and anchored barrier with broken concrete with shear cracks                                       |
| <b>Concrete Spalling</b> | Minor spalls with a depth of 1.5 inches or less, and no exposed rebar                             | Spalls with a depth greater than 1.5 inches, any location with exposed rebar, and cracked or broken concrete that could easily be dislodged if hit, resulting in spall with a depth greater than 1.5 inches |
| <b>Connection System</b> | Connection assemblies are functional with no damage, are all intact, and fixed in their positions | Connection assemblies are deformed, bent, broken, or no longer in a fixed position  |



**Figure 2.19. Example of Unacceptable Barrier with Connection Assembly Damage—*FDOT (31)*.**



**Figure 2.20. Example of Unacceptable Barrier—*FDOT (31)*.**



**Figure 2.21. Example of Unacceptable Barrier with Broken Concrete at Anchor Slot Due to Shear Cracking—*FDOT (31)*.**

## 2.2.6 Guidelines for Temporary Pre-Cast Concrete Safety Barrier Condition Inspection, KDOT

The Kansas DOT (KDOT) guide (32) is based in part on the ATSSA document mentioned previously. The guide evaluates the conditions of concrete barriers as acceptable, marginal, and unacceptable. Table 2.5 provides the criteria to determine the acceptability of PCBs.

**Table 2.5. KDOT Criteria for Acceptability of PCBs (32).**

| <b>Defects</b>           | <b>Acceptable</b>                                      | <b>Marginal</b>  | <b>Unacceptable</b>  |
|--------------------------|--|--|--|
| <b>Cracks</b>            | Superficial gouges or minor cracks                     | Cracks if present, they should not propagate through both sides of the barrier       | Cracks propagate through both sides of the barrier                               |
| <b>Concrete Spalling</b> | Minimal spalls and chipped concrete or exposed rebar   | Spall dimension less than or equal to 12 inches long × 3 inches deep × 3 inches high | Spall dimension greater than 12 inches long × 3 inches deep × 3 inches high      |
| <b>Connection System</b> | Loop and pins are all intact, fixed in their positions | Loop and pins are all intact, fixed in their position                                | Loops and pins are deformed, bent, broken, and no longer fixed in their position |



### 3. STATE DEPARTMENT OF TRANSPORTATION SURVEYS

This chapter presents the results of the state DOT online surveys conducted as part of this research. The state DOTs were asked to share information regarding their agency’s inspection, evaluation, and repair guidance related to acceptability of portable concrete barrier segments. Detailed requested information and obtained results are reported in the following sections.

#### 3.1 INSPECTION GUIDANCE

The state DOTs were asked if they have guidance for inspecting PCB segments. Answer choices were “Yes,” “No,” and “Other.” A text box was provided with each choice so that the respondents could give more information if desired. According to the survey’s logic, answering “Yes” presented three more questions to the respondents. One question asked about providing a copy of or a link to the inspection guidance. In another question, the respondent was asked what basis the agency used when adopting the inspection guidance. The choices for answering were “From specifications of another Agency,” “Conducted research by your Agency,” “Past experience,” and “Other.” The third question asked how often the agency conducts the required inspection according to its inspection guidance. If a respondent chose “No” or “Other,” the survey presented a new question about the procedure that the respondent’s agency typically follows to inspect a PCB. The results are depicted in Table 3.1.

**Table 3.1. Responses to State DOT Survey on PCB Inspection Guidance.**

| <b>Response</b> | <b>Agency</b>  |
|-----------------|--|
| Yes             | AL, FL, IL, IN, NJ, NY, OH, OR, PA, SC, VA, WA, WI                                     |
| No              | AK, CO, CT, ID, LA, ME, MN, NC, ND TN, UT, WV  |
| Other           | MI, NH   |
| No Answer       | AZ, AR, CA, DE, GA, HI, KS, KY, MD, MA, MS, MO, MT, NE, NV, NM, OK, RI, SD, TX, VT, WY |

##### 3.1.1 Summary of Agencies with Inspection Guidance

This section summarizes the survey responses and attachments provided by state DOTs with inspection guidance. Table 3.2 provides a brief overall summary.

**Table 3.2. Summary of Agencies with Inspection Guidance.**

| <b>Agency</b> | <b>Comment</b>   | <b>Attachment</b>  |
|---------------|--|--|
| AL            | We use the ATSSA Quality Guidelines for Temporary Traffic Control Device.  | State of Alabama Department of Transportation Traffic Control Through Construction Work Zones  |
| FL            | NA   | FDOT Evaluation Guide—Temporary Concrete Barrier   |
| IL            | PCB and other work zone devices are supplied by the contractor. IDOT inspects them when they are delivered to the job site. What is considered “acceptable,” “marginal,” or “unacceptable” is depicted in a field guide called the “Traffic Control Field Manual.”   | Traffic Control Field Manual Quality Standard for Temporary Concrete Barrier   |
| IN            | We use the guidance in the ATSSA Quality Guidelines for Temporary Traffic Control Devices and Features and Section 801.03 of our Standards and Specifications Book.  | Standards and Specifications, Section 801.03   |
| NJ            | Info in Standard Specifications.   | Standard Specifications for Road and Bridge Construction 2019  |
| NY            | Information provided via separate e-mail.  |  |
| OH            | Our Construction and Material Specification (614.03B/C) requires that TTCDs (including PB) conform to our Quality Standards for TTCDs & Acceptable Delineation Methods for Vehicles (January 2020). This document is the best that we have that outlines inspection guidance as well as inspection criteria. We do also have general MOT inspection requirements, intervals, etc; however, they do not drill down to the specifics of TTCD quality standards inspection but rather are more general and reference it as a whole. We would like feedback on this element for us to consider for inclusion in our standards. | Quality Standards for Temporary Traffic Control Devices and Acceptable Delineation Methods for Vehicles, ODOT, 2020  |
| OR            | See ODOT Standard Specifications Sections 225.12 & 225.62.   | Oregon Standard Specifications for Construction, 2018  |
| PA            | Yes  | At the construction project: Publication 2, POM, Section C.9.8<br>During Fabrication: Pub 145 “Inspection of Prestressed/Precast Concrete Products and Reinforced Concrete Pipe” -inspection during the fabrication process - PennDOT inventories and checks for damage of permanent barriers every 4 years: Pub 33, STAMPP procedure for checking inventory. Inventory survey every 4 years. Includes check for damage. (See Deterioration Section, pg104- 110) |
| SC            | NA   | Standard Specifications for Highway Construction, SCDOT, 2007, Section 605.2.3.2 Temporary Concrete Barrier  |
| VA            | We have a specification that defines the criteria for rejection.   | Road and Bridge Specifications-VDOT  |
| WA            | NA   | Standard Specifications for Road, Bridge, and Municipal Construction 2020, WSDOT   |
| WI            | NA   | Construction and Materials Manual, Chapter 1 General Provisions, Section 45 Traffic Control  |

### 3.1.1.1 Alabama DOT

Alabama DOT's (ALDOT's) *State of Alabama Department of Transportation Traffic Control Through Construction Work Zones (33)* includes pictures of concrete barriers for quality guidance. The pictures mainly show the condition of the connections (Figure 3.1). One picture displays the physical damage only. In addition, the document provides some requirements about the inspection of the traffic control devices: "All traffic control devices should be inspected prior to installation for compliance with plans and specifications. The Project Traffic Control Inspector (PTCI) shall inspect the installation of the devices and make regular inspections of the in-place traffic control devices to determine if they are being properly maintained."



a. Acceptable barrier



b. Unacceptable barrier

**Figure 3.1. Examples of Connection Systems—ALDOT (33).**

### 3.1.1.2 Illinois DOT

Illinois DOT's (IDOT's) *Traffic Control Field Manual—Quality Standard for Temporary Concrete Barrier (34)* provides measurements to evaluate the conditions of a concrete barrier. PCBs are identified as Illinois F-Shape by stamp or paint. PCBs must meet Federal Highway Administration (FHWA) crashworthy standards Category 3, Test Level 3 requirements. The document provides three levels of evaluation: acceptable, marginal, and unacceptable (Table 3.3). Some barrier pictures are provided as examples for the defects in Figure 3.2.

**Table 3.3. IDOT Evaluation Criteria for PCBs (34).**

| <b>Defects</b>              | <b>Acceptable</b>  | <b>Marginal</b>  | <b>Unacceptable</b>   |
|-----------------------------|--|--|---|
| <b>Cracks</b>               | A barrier wall is new or in like-new condition with few blemishes.   | Crack tightly compressed, no longer than 1 ft, exhibiting no surface displacement and not combined with other defects. | The barrier wall has large cracks, with unsound concrete that could easily dislodge when hit. |
| <b>Spalling of Concrete</b> | Spalls and chipped concrete are no greater than 1.5 inches in depth. | Spall on a barrier, less than 4 inches measured horizontally, vertically, or diagonally. No exposed rebar.             | Any spall greater than 1.5 inches in depth. A rebar is exposed.                               |
| <b>Connections</b>          | Connecting loop bars are in place and in good condition.             | Connecting loop bars are in place and in good condition.   | A broken/damaged connecting loop is cause for rejection.                                      |



**Figure 3.2. Unacceptable Barrier—IDOT (34).**

### **3.1.1.3 Indiana DOT**

Indiana DOT's (INDOT's) *Standards and Specifications*, Section 801.03 (35) states that the ATSSA brochure titled "Quality Standards for Work Zone Traffic Control Devices" will be used as a guide to determine if temporary traffic control devices are acceptable, marginal, or unacceptable. In addition, Section 801.03 deems the traffic control device to be in noncompliance when its condition is unacceptable. A type of temporary traffic control device will be deemed to be in noncompliance when 25 percent or more of the individual devices are considered marginal.

### **3.1.1.4 New Jersey DOT**

For the inspection of concrete barriers, the New Jersey DOT (NJDOT) specifications (36) do not allow use of any barrier having any of the deficiencies noted in Table 3.4.



**Table 3.4. NJDOT Unacceptable Deficiencies in PCBs (36).**

| <b>Defects</b>                     | <b>Unacceptable</b>   |
|------------------------------------|---|
| <b>Cracks</b>                      | Cracking through the cross-section of the barrier             |
| <b>Spalling of concrete</b>        | Spalling area greater than 3 inches × 3 inches                |
| <b>Connections</b>                 | Non-functioning anchor bolt holes<br>Non-functioning rod hole |
| <b>Other types of deficiencies</b> | Previous repair<br>Paint applied to the barrier surface       |

NJDOT’s inspection procedure is as follows (36):

1. At least 30 days before delivering the barriers to the project site, the contractor should provide the RE (RE means the Department’s field representative having direct supervision of the administration of the Contract) notice that the barrier is available for inspection. The RE will inspect the barriers, along with the Contractor representative, to determine what pieces are not approved for delivery to the project.
2. Final determination of barrier approval is made at the time of placement at the project site.

The NJDOT repair procedure is (36):

1. Replace a barrier that has any of the deficiencies (mentioned above).
2. Do not patch or repair the concrete barrier.

### **3.1.1.5 Ohio DOT**

For the quality inspection of concrete barriers, the Ohio DOT (ODOT) quality standards document (37) has three categories: acceptable, marginal, and unacceptable. Table 3.5 and Figure 3.3 provide guidance on determination.

**Table 3.5. ODOT Evaluation Criteria for PCBs (37).**

| <b>Defects</b>              | <b>Acceptable</b>   | <b>Marginal</b>   | <b>Unacceptable</b>  |
|-----------------------------|---|---|--|
| <b>Cracks</b>               | The wall shall have smooth, flat surfaces made up of the original cast concrete material, with few minor blemishes.   | The wall has a combination of minor blemishes and cracking but is still structurally sound.   | One or more cracks with evidence of rusting. Or, two or more cracks that are located within, or extend to, the lower half of the wall.   |
| <b>Spalling of Concrete</b> | No more than 3 spalls and no spall greater than 12 inches in any surface direction; and no spall or chipped concrete greater than one and one-half (1.5) inches in depth. | Wall with repaired concrete areas less than 12 inches in any surface direction. No repairs are permitted to any aspect of the connection. | The wall has one or more spalls 12 inches or larger in any surface direction. Unsound concrete that could be easily removed when hit. Spall(s) greater than one and one-half (1.5) inches in depth. Exposed reinforcing steel. |
| <b>Connections</b>          | The connecting loops are all sound and in place with no broken strands.   |   | One (1) or more incomplete or improper connections.  |



a. Acceptable



b. Marginal



c. Unacceptable

**Figure 3.3. Examples of Barrier Conditions—ODOT (38).**

### 3.1.1.6 Oregon DOT

Sections 225.12 and 225.62 of Oregon DOT’s (ORDOT’s) *Standard Specifications (39)* entail some qualitative measurements for inspection of concrete barriers. The specifications state to provide concrete barriers that are in acceptable condition, without cracks, chips, spalls, or corroded connectors and loops. In addition, Section 225.10 requires using the most current version of ATSSA in effect to evaluate the conditions of traffic control devices.

The respondent provided a link to the *ODOT Inspector’s Manual*, which contains some inspection procedures. The inspection procedure for concrete barriers contains some generic points for the inspectors to check. Section 820 in the *Inspector’s Manual* requires that the barrier conform to contract requirements, especially if it was salvaged (free of visible cracks, chips, spalls, or corroded loops; of uniform surface texture and appearance; free of markings, other than those specified; and given two coats of water-based coating after installation).

### 3.1.1.7 South Carolina

South Carolina DOT’s (SCDOT’s) *Standard Specifications for Highway Construction*, Section 605.2.3.2—Temporary Concrete Barrier (40), requires that concrete barriers be produced only by a producer that is included on the most recent SCDOT Qualified Producers List 54. Any fabrication facility on List 54 of an approved barrier should be inspected every 24 months.

The specifications require that a concrete barrier be in good condition. The defects that may disqualify a concrete barrier are given in Table 3.6.

**Table 3.6. SCDOT Evaluation Criteria for PCBs (40).**

| Defects              | Criteria   |
|----------------------|--|
| Cracks               | A defect that exposes reinforcing steel warrants immediate disqualification.   |
| Spalling of Concrete | <ul style="list-style-type: none"> <li>• Spalling area of 1 inch or more, entirely or partially within the boundaries of the end connection areas and the drainage slot areas.</li> <li>• Spalling area of 4 inches or more for all areas beyond the end connection areas.</li> </ul> (These measurements shall exceed the specified dimensions in all three directions, width, height, and depth) |

### 3.1.1.8 Virginia DOT

According to Section 412.03 in the Virginia DOT (VDOT) specifications (41), replacement and correction of ineffective work zone traffic control devices must be accomplished in accordance with the ATSSA “Quality Standards for Work Zone Traffic Control Devices.” In addition, the specifications give qualitative measurements for acceptability of concrete barriers. Acceptable requirements are (41):

- A. Concrete barrier sections shall be structurally sound with no concrete missing along the top, bottom, sides, or end sections.
- B. No through cracks.
- C. No exposed rebar.

- D. Concrete barrier service shall be cleaned or coated sufficiently to afford good visibility and uniformity of appearance.
- E. Repairs to traffic barrier service shall match existing barrier so that positive connections can be maintained.

### **3.1.1.9 Washington State DOT**

Section 6-10 of the Washington State DOT (WSDOT) specifications (42) is about concrete barriers and entails requirements for raw materials of concrete barriers, construction, removing and resetting of barriers, and more. For the inspection requirements, the specifications note the following: “Judgment of the quality of devices furnished will be based upon ATSSA’s ‘Quality Guidelines for Temporary Traffic Control Devices and Features.’”

- Section 6-10 has additional qualitative requirements, such as (42):
  - After removing the forms, the barrier shall be finished to an even, smooth, dense surface, free from any rock pockets or holes larger than 0.24 inch across. The barrier shall be free from stains, smears, and any discoloration.
  - All barrier shall be in good condition, without cracks, chips, spalls, dirt, or traffic marks.
  - If any barrier segment is damaged during or after placement, the contractor shall immediately repair it to the Engineer’s satisfaction or replace it with an undamaged section.

### **3.1.1.10 Wisconsin DOT**

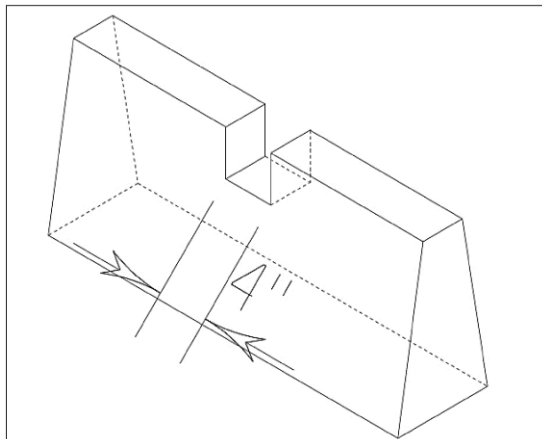
Section 1-45.12.5 of the Wisconsin DOT (WisDOT) guidelines (43) is about the quality standards for PCBs. As Table 3.7 shows, guidance is based on three levels of device quality: acceptable, marginal, and unacceptable. PCBs introduced to the work site must be in acceptable condition. A PCB may degrade to marginal quality during the project, but once the barrier has been determined to be unacceptable, it must be replaced with an acceptable barrier. The guidance entails some barrier pictures as examples for the acceptability conditions (see Figure 3.4 through Figure 3.6).

**Table 3.7. WisDOT Acceptable PCB Conditions (43).**

| <b>Defects</b>              | <b>Acceptable</b>  | <b>Marginal</b>   | <b>Unacceptable</b>  |
|-----------------------------|--|---|--|
| <b>Cracks</b>               | Cracks that are being tightly compressed by the barrier's reinforcement may be acceptable providing that the barrier does not have other damage (e.g. anchor hole damage, end section loss, loop damage...) and that the barrier does not require anchoring. | Barriers that have cracks that are not tightly compressed and do not extend completely through the barrier are marginal and are not to be used in areas where barrier requires anchoring. | Open cracks with the cracks extending completely through the barrier.  |
| <b>Spalling of Concrete</b> | Spalling that does not categorized as unacceptable is acceptable.  | The specification does not give specific guidance for marginal.   | Spalling or chipping that compromises the overall profile of the barrier or causes a potential snag point during an impact. Spalling or chipping that is greater than 4" in width and abrupt in character. |
| <b>Snag Points</b>          | N/A  | N/A   | If a longitudinal opening is 4 inches or greater in width. Perpendicular differences in barriers of 2 inches or greater.   |
| <b>Connections</b>          | N/A  | N/A   | A loop that is out of alignment. The steel loop is not firmly connected to the concrete barrier.   |



**Figure 3.4. Spalling and Chipping—WisDOT (43).**



**Figure 3.5. Opening in Barrier Causing Snag Point—WisDOT (43).**



**Figure 3.6. Loop Unacceptable Condition—WisDOT (43).**

### **3.1.2 Summary of Agencies without Inspection Guidance**

Table 3.8 summarizes the survey responses and current procedures adopted for PCB inspection by state DOTs without guidance.

**Table 3.8. Summary of Agencies without Inspection Guidance.**

| <b>Agency</b> | <b>Comment</b>                                   | <b>Current Procedure</b>  |
|---------------|--|---|
| AK            | NA   | Depend on judgement of maintenance or work zone personnel, review: alignment of barrier segments, integrity of connection between segments and/or anchoring to the surface, visual evidence of cracks or spalling, etc. Evidence of impact is not in itself sufficient to require replacement of CB segments. |
| CO            |  | We have none.   |
| CT            |  | The Department does not have a formal procedure to follow for inspecting portable concrete barrier. We are very interested in the best effective practice used by others.   |
| IA            | We currently do not have guidance for inspection | We currently don't have a written procedure. Look for major cracked and spalled concrete. Check connecting pins and loops for wear.   |
| ID            |  | ITD uses visual inspection to identify PCB that are no longer serviceable.  |
| LA            |  | There is no formal inspection procedure. Our specifications only require that the units be satisfactorily repaired or replaced (at the direction of the project engineer).  |
| ME            |  | The connection details are inspected for compliance to specs & standard details. The overall condition of concrete is inspected. For example, if it's cracked around the whole barrier cross section it is not allowed.   |
| MN            |  | It is part of the daily inspection on the project.  |
| NC            |  | Our inspectors typically perform visual inspections of PCB.   |
| ND            |  |   |
| TN            |  | Visible damage.   |
| UT            |  | During the precast process, normal concrete inspection procedures (i.e. forms, rebar, placement, curing). During placement, inspect for cracks, breaks, spalls.   |
| WV            |  | Visual, very subjective for acceptance.   |

### 3.1.3 Summary of Agencies with “Other” Responses

Table 3.9 summarizes the “Other” survey responses and current procedures adopted for PCB inspection by state DOTs.

**Table 3.9. Summary of Agencies with “Other” Responses (Inspection Guidance).**

| <b>Agency</b> | <b>Comment</b>   |
|---------------|--|
| MI            | MDOT relies on the ATSSA Quality Guidelines for Work Zone Traffic Control Devices. |
| NH            | Not aware of formal guidance by the agency.  |

### 3.1.4 Inspection Procedure

The DOTs were asked how often they conduct the inspection of PCBs according to their inspection guidance. Table 3.10 summarizes the answers provided.

**Table 3.10. DOT Inspection Procedures.**

| <b>DOT</b>       | <b>Answer</b>  |
|------------------|--|
| Alabama          | A PCB would be inspected at initial installation, a reset and after an impact.   |
| Florida          | Routine/Reoccurring, but not prescribed.   |
| Illinois         | Each time the PCB is brought to the job site and also during the project if the PCB is hit or damaged during handling.   |
| Indiana          | Upon initial setup and phase changes of temporary traffic control devices, all individual devices shall be of the Acceptable classification.   |
| New Jersey       | The inspection is required for each project having construction barrier curb.  |
| New York         | The inspection is supposed to take place as the contractor delivers TSB to a job site.   |
| Ohio             | At the time of initial installation and major phase changes.   |
| Oregon           | Typically the barrier is inspected when it shows up onsite, then during contract if deficiencies are found, barrier is repaired or replaced as needed.   |
| Pennsylvania     | PCB’s are inspected when barriers are delivered to the construction site.<br>For permanent barriers, inventory check and check for damage is done every 4 years.<br>If there is damage due to an incident, there a separate procedure (under development). |
| South Carolina   | Plant inspections are every 2 years.   |
| Virginia         | As the barrier is installed on a project.  |
| Washington State | During installation and resetting.   |
| Wisconsin        | In our contract the responsibility to monitor and maintain the barrier condition is the contractor’s responsibility.   |



### 3.2 EVALUATION GUIDANCE

The state DOTs were asked if they have guidance for evaluating the acceptability of PCB segments. Answer choices were “Yes,” “No,” and “Other.” A text box was provided with each choice so that the respondents could give more information if desired. According to the survey’s logic, answering “Yes” presented four more questions to the respondents. One question asked about providing a copy of or a link to the evaluation guidance. Another question asked what basis the agency used when adopting the evaluation guidance. The choices for answering were “From specifications of another Agency,” “Conducted research by your Agency,” “Past experience,” and “Other.” The third question was about evaluation guidance to determine the conditions of unrepairable PCB. The fourth question focused on the evaluation guidance for the conditions of PCB connections. If a respondent chose “No” or “Other,” the survey presented a new question about the procedure that the respondent’s agency typically follows to evaluate the PCB. The results are depicted in Table 3.11.

**Table 3.11. Responses to State DOT Survey on PCB Evaluation Guidance.**

| <b>Response</b> | <b>Agency</b>  |
|-----------------|--|
| Yes             | AL, FL, IL, IA, MI, NH, NJ, NY, OH, OR, PA, SC, VA, WA, WI                                 |
| No              | AK, CO, CT, ID, LA, ME, MN, NC, TN, UT, WV   |
| Other           | —  |
| No Answer       | AZ, AR, CA, DE, GA, HI, KS, KY, MD, MA, MS, MO, MT, NE, NV, NM, ND, OK, RI, SD, TX, VT, WY |

#### 3.2.1 Summary of Agencies with Evaluation Guidance

Table 3.12 summarizes the survey responses and attachments provided by state DOTs with evaluation guidance.

**Table 3.12. Summary of Agencies with Evaluation Guidance.**

| <b>Agency</b> | <b>Comment</b>  | <b>Attachment</b>  |
|---------------|---|--|
| AL            | ATSSA Quality Guidelines, also Construction Manual Pages 13 and 14 of 17.   |  |
| FL            | NA  | FDOT Evaluation Guide—Temporary Concrete Barrier   |
| IL            | Same as question 2.   |  |
| IN            | ATSSA Quality Guidelines for Temporary Traffic Control Devices and Features.  |  |
| IA            | NA  | Section 2513. Concrete Barrier   |
| MI            |   |  |
| NH            |   |  |
| NJ            | It is part of the previous stated info.   | The respondent referred to the same Specification documents for this question. The requirements of the specification are presented in the inspection guidance section. |
| NY            |   |  |
| OH            | Yes, “Quality Standards for TTCD’s & Acceptable Delineation Methods for Vehicles” (January 2020).   |  |
| OR            | ODOT has guidance in the ODOT Inspectors manual, but it is generic. ODOT does use the same barrier for both permanent and temporary applications. Inspectors are familiar with the barrier. |  |
| PA            | See Pub 2, POA, Section C.9.8.  | Publication 2, POM, Section C.9.8  |
| SC            | NA  |  |
| VA            | Just the specification.   | The specifications were discussed in the section of inspection guidance question.  |
| WA            | Per the ATSSA quality guidelines.   |  |
| WI            | NA  | The respondent referred to the same specifications document as in the inspection guidance question.  |

**3.2.1.1 Iowa DOT**

Section 2513—Concrete Barrier of Iowa DOT’s (IADOT’s) guidelines (44) describes the production and construction of concrete barriers, both permanent and temporary. The document entails some requirements for the raw materials and the produced concrete. The inspection and evaluation criteria for concrete barriers after being produced are summarized in Table 3.13.

**Table 3.13. IADOT Evaluation Criteria for PCBs (44).**

| <b>Defects</b>              | <b>Criteria</b>   |
|-----------------------------|---|
| <b>Spalling of concrete</b> | <ul style="list-style-type: none"><li>• Corner breaks and bottom spalls after shipping and placement do not exceed 1 square foot of total surface area, which includes the base.</li><li>• Each barrier should not have spalls, corner breaks, and bottom spalls totaling more than 5 square feet of surface area, including the base.</li><li>• Shallow voids on the barrier surface, not exceeding 3/4-inch diameter will not be considered as surface defects.</li></ul> |
| <b>Connection</b>           | Connecting loops on all barriers are not deformed.  |

### **3.2.2 Summary of Agencies without Evaluation Guidance**

The responses and current PCB evaluation procedures for state DOTs without any specified evaluation guidance are summarized in Table 3.14.

**Table 3.14. Summary of Agencies without Evaluation Guidance.**

| <b>Agency</b> | <b>Comment</b>  | <b>Current Procedure</b>  |
|---------------|---|---|
| AK            | PCB must be MASH compliant if manufactured after Dec 31, 2019. Otherwise, PCB segments anticipated to be in good physical condition, but no written guidance for evaluation of condition. | Based on judgement of the maintenance, work zone or construction staff, the PCB should be: in good condition and without damage that would prevent it from being installed and/or serving its purpose.  |
| CO            |   |   |
| CT            |   |   |
| IA            | The manufacturer is required to stamp the manufacture date on each section.   | Visual inspection.  |
| ID            |   | ITD usually adopts criteria from surrounding state DOTs.  |
| LA            | There is no formal guidance or criteria in place.   | There is no formal guidance or criteria used to evaluate PCB units. It is a judgement call made by the project engineer in the field as to whether the damage or cracking is severe enough to warrant repair / replacement.   |
| ME            | See previous notes.   | See previous notes.   |
| MN            | Currently under development.  | Inspecting the loops and checking for spalling or cracking that looks severe.   |
| NC            |   |   |
| TN            |   | Flare section loss, visible concrete or mechanical connection damages.  |
| UT            |   | We have criteria for the properties of the concrete (mix, strength, air entrainment, etc.), which are evaluated using testing. There are plans that have dimensions that must be met, which are measured. Also, barrier has to be placed without cracks, breaks, or spalls, which is inspected. |
| WV            |   | None.   |

### **3.3 REPAIR GUIDANCE**

The state DOTs were asked if they have guidance for repairing damaged PCB segments. The answer choices were “Yes,” “No,” and “Other.” A text box was provided with each choice so that the respondents could give more information if desired. According to the survey’s logic, answering “Yes” presented three more questions to the respondents. One question asked about providing a copy of or a link to the repair guidance. Another question asked what basis the agency used when adopting the repair guidance. The choices for answering were “From specifications of another Agency,” “Conducted research by your Agency,” “Past experience,” and “Other.” The third question asked about a maximum allowance of repairs for PCB segments before disposing of them. If a respondent chose “No” or “Other,” the survey presented a new

question about the procedure that the respondent’s agency typically follows to repair the PCB. The results are depicted in Table 3.15.

**Table 3.15. Responses of State DOTs on PCB Repair Guidance.**

| <b>Response</b> | <b>Agency</b>  |
|-----------------|--|
| Yes             | FL, IN, NJ, NY, OR, PA, SC, UT   |
| No              | AL, AK, CO, CT, ID, IL, IA, LA, ME, MI, MN, NH, NC, TN, VA, WA, WV, WI                     |
| Other           | OH   |
| No Answer       | AZ, AR, CA, DE, GA, HI, KS, KY, MD, MA, MS, MO, MT, NE, NV, NM, ND, OK, RI, SD, TX, VT, WY |

### 3.3.1 Summary of Agencies with Repair Guidance

Table 3.16 summarizes the survey responses and attachments provided by state DOTs with repair guidance.

**Table 3.16. Summary of Agencies with Repair Guidance.**

| <b>Agency</b> | <b>Comment</b>  | <b>Attachment</b>   |
|---------------|---|---|
| FL            | NA  | Specification 102-9 Revisions (Temporary Concrete Barrier), Section 102-9.6.2.4 Temporary Concrete Barrier Repair   |
| IN            | Replace if it is determined to be Unacceptable or 25% or more the barrier is considered Marginal. |   |
| NJ            | Very minor repairs.   | The respondent referred to the same Specification documents for this question. The requirements of the specification for repairing are presented in the inspection guidance section.  |
| NY            |   |   |
| OR            | Yes criteria includes guidance on repair.   |   |
| PA            | Yes, for permanent PCB. Policy should be issued very soon.  | Permanent PCB Repair policy in Pub 23, Maintenance Manual, Chapter 17. Also, Specifications, i.e., Standard Special Provisions will also be issued soon. This policy will give direction on how to repair PCB and a priority matrix. This is based on NCHRP #656. |
| SC            | NA  | Standard Specifications for Highway Construction, SCDOT, 2007, Section 605.2.3.2 Temporary Concrete Barrier   |
| UT            | The attached is not formal nor contractual, it is guidance only.                                  | Basic Acceptable Repair Guidelines for Precast Concrete   |

### 3.3.1.1 Florida DOT

Section 102-9.6.2.4—Temporary Concrete Barrier Repair was recently added to FDOT’s specifications (31) to provide a specific repair procedure for deficient temporary concrete barriers. The following information appears directly in the document.

Unacceptable Repair: a barrier with the following conditions should be considered unrepairable.

- A. Structural cracking or cracks that exist through the entire cross-section.
- B. Unit-to-unit connection assemblies or anchor slots are broken or no longer in a fixed position.

Repair Procedure:

- A. Remove all laitance, loose material, and any other deleterious matter to sound concrete or a minimum depth of one inch.
- B. When reinforcing bars, inserts or weldments are exposed, remove the concrete to provide a minimum one-inch clearance all around.
- C. Fill the repair area with an approved high-performance concrete repair material in accordance with 930-5 and the manufacturer’s recommendations.
- D. Restore surfaces and edges to the original dimensions and shape of the barrier.

### 3.3.1.2 South Carolina DOT

The following information appears in SCDOT’s *Standard Specifications for Highway Construction*, Section 605.2.3.2—Temporary Concrete Barrier (40).

Repairing a concrete barrier is prohibited in the following cases:

- A. A barrier has exposed reinforcing steel rebar.
- B. A spall area of 6 inches or more in all three dimensions (depth, width, and height)

For repair of concrete barriers with spalling area less than 6 inches in all three directions (depth, width, and height) that do not expose reinforcing steel, repair with a premanufactured patching material specifically fabricated for patching structural concrete.

### 3.3.2 Summary of Agencies without Repair Guidance

Table 3.17 summarizes the survey responses and attachments provided by state DOTs without repair guidance.

**Table 3.17. Summary of Agencies without Repair Guidance.**

| <b>Agency</b> | <b>Comment</b>  | <b>Current Procedure</b>  |
|---------------|---|---|
| AL            |   |   |
| AK            | PCB must be MASH compliant if manufactured after Dec 31, 2019. Otherwise, PCB segments anticipated to be in good physical condition, but no written guidance for evaluation of condition. | Based on judgement of the maintenance, work zone or construction staff, the PCB should be: in good condition and without damage that would prevent it from being installed and/or serving its purpose.  |
| CO            |   | None  |
| CT            |   | The Department does not have a procedure established to repair portable concrete barrier. By specification the contractor is responsible for removing any damaged material to be replaced at its expense. We are very interested in the best effective practice used by others.   |
| IA            | The manufacturer is required to stamp the manufacture date on each section.   | Visual inspection.  |
| ID            |   | PCBs will be replaced if no longer serviceable.   |
| IL            | We don't really allow "repair" of PCB. Repairs are typically cosmetic and do not restore the crash capacity of PCB.   | N/A   |
| LA            |   | There is no established procedures for making repairs to PCB segments. Any repair method proposed by a contractor would have to be reviewed and approved by the design office prior to application. (For what it's worth, I have never heard of a PCB unit being repaired. It is probably easier for a contractor to simply replace it with another unit from his stockpile). |
| ME            | If deemed not acceptable the PCB is not repaired for use.   |   |
| MI            |   | Determined by the Project Engineer on a project-by-project basis.   |
| MN            |   | Replace.  |
| NH            |   | I am not aware of one.  |
| NC            |   |   |
| TN            | Remove from service.  | Usually damaged segments retire.  |
| VA            | See Q3d.  |   |
| WA            |   |   |
| WV            |   | No repair permitted.  |
| WI            |   | We don't have any guidance on repair.   |

### 3.3.3 Summary of Agencies with “Other” Responses

Table 3.18 summarizes the “Other” survey responses and current procedure adopted for PCB inspection by state DOTs.

**Table 3.18. Summary of Agencies with “Other” Responses (Repair Guidance).**

| Agency | Comment   |
|--------|---|
| OH     | Nothing other than what is in the Quality Standards document (see document). No official repair procedure. Repairs are only acceptable if directed by the Engineer. These would fall under Marginal in the Quality Standards document and would not be allowed to be used on future projects. For what we do have, it is unclear when or how it originated. We would really like guidance in this area as we remain concerned about repairs. Would like additional information such as limitations or restrictions on repairs. The current and archived copies can be found here: <a href="http://www.dot.state.oh.us/Divisions/Engineering/Roadway/DesignStandards/traffic/qualityguidelines/Pages/default.aspx">http://www.dot.state.oh.us/Divisions/Engineering/Roadway/DesignStandards/traffic/qualityguidelines/Pages/default.aspx</a> |



## 4. TXDOT DISTRICT SURVEY

This chapter presents the results of the TxDOT district survey conducted as part of this research. The TxDOT districts were asked to share information regarding their inspection, evaluation, and repair guidance related to acceptability of portable concrete barrier segments. Detailed requested information and obtained results are reported in the following sections.

### 4.1 INSPECTION GUIDANCE

The TxDOT districts were asked if they have guidance for inspecting PCB segments. The answer choices were “Yes,” “No,” and “Other.” A text box was provided with each choice so that the respondents could give more information if desired. According to the survey’s logic, answering “Yes” presented three more questions to the respondents. One question asked about providing a copy of or a link to the inspection guidance. In another question, the respondent was asked what the agency based its decision on when adopting the inspection guidance. The choices for answering were “From specifications of another Agency,” “Conducted research by your Agency,” “Past experience,” and “Other.” The third question asked how often the agency conducts the required inspection according to the inspection guidance. If a respondent chose “No” or “Other,” the survey presented a new question about the procedure that the respondent’s agency typically follows to inspect the PCB.

#### 4.1.1 Summary of Districts with Inspection Guidance

Table 4.1 summarizes the survey responses and attachments provided by TxDOT districts with inspection guidance.

**Table 4.1. Summary of Districts with Inspection Guidance.**

| <b>District</b> | <b>Comment</b>  | <b>Attachment</b>  |
|-----------------|---|--|
| ODA             | We just use txdot specifications combined with the project specific contract to inspect |  |
| Odessa          | Inspect to follow TxDOT standard  |  |
| Pharr           | NA  | Quality guidelines for temporary traffic control devices and features from ATSSA                       |
| Waco            | NA  | <i>Standard Specifications for Construction and Maintenance of Highways, Streets, and Bridges (45)</i> |

##### 4.1.1.1 Standard Specifications for Construction and Maintenance of Highways, Streets, and Bridges (TxDOT)

*Standard Specifications for Construction and Maintenance of Highways, Streets, and Bridges (45)* has two sections (512 and 514) on portable traffic barriers and permanent concrete barriers. In both sections, the specifications entail the requirement for the raw materials (cement, sand, gravel, steel rebars). In addition, some requirements are about the construction, measurements, and payment methods. For inspection of the concrete barrier, the specifications do not have

quantitative measurements. The specifications note that the engineer may approve the use of a barrier if:

1. The barrier sections substantially meet typical cross-section dimension requirements.
2. There is no evidence of structural damage such as major spalls or cracks.
3. The general condition of both the barrier sections and their connectors is acceptable.

#### 4.1.2 Summary of Districts without Inspection Guidance

Table 4.2 summarizes the survey responses and attachments provided by TxDOT districts without inspection guidance.

**Table 4.2. Summary of Districts without Inspection Guidance.**

| District    | Comment                    | Current Procedure  |
|-------------|----------------------------|--|
| Atlanta     | Use visual inspection only | By visual inspection to look for cracks etc.   |
| Austin      | NA                         | Visual inspection.   |
| Laredo      | NA                         | Usually, we supply the contractor with the PCB. We have not had any issues with the Barrier. However, if damaged during transport the contractor shall repair at his expense and we would have to make sure they follow our concrete repair manual, but what type/size of damage requires repair is not specified. |
| Lufkin      | NA                         | Check for spalls and the connections.  |
| San Antonio | NA                         | Visual inspection for damage and connections in working order.   |

#### 4.1.3 Summary of Districts with “Other” Responses

Table 4.3 summarizes the “Other” survey responses and attachments provided by TxDOT districts.

**Table 4.3. Summary of Districts with “Other” Responses (Inspection Guidance).**

| District | Comment  | Current Procedure |
|----------|--|-------------------|
| Laredo   | There is no written guidance. Our PM and inspectors coordinate with the contractor to ensure that the barrier that is placed is in good condition. | NA                |

## 4.2 EVALUATION GUIDANCE

The TxDOT districts were asked if they have guidance for evaluating the acceptability of PCB segments. The answer choices were “Yes,” “No,” and “Other.” A text box was provided with each choice so that the respondents could give more information if desired. According to the survey’s logic, answering “Yes” presented four questions to the respondents. One question asked about providing a copy of or a link to the evaluation guidance. Another question asked what

basis the agency used when adopting the evaluation guidance. The choices for answering were “From specifications of another Agency,” “Conducted research by your Agency,” “Past experience,” and “Other.” The third question asked about evaluation guidance to determine the conditions of unrepairable PCBs. The fourth question was regarding the evaluation guidance for the conditions of PCB connections. If a respondent chose “No” or “Other,” the survey presented a new question about the procedure that the respondent’s agency typically follows to evaluate the PCB.

#### 4.2.1 Summary of Districts with Evaluation Guidance

Table 4.4 summarizes the survey responses and attachments provided by TxDOT districts with evaluation guidance.

**Table 4.4. Summary of Districts with Evaluation Guidance.**

| District | Comment   | Attachment   |
|----------|---|--|
| Waco     | Item 512 primarily, but reference Items 420, 421, 424, 440, 442 | <i>Standard Specifications for Construction and Maintenance of Highways, Streets, and Bridges (45)</i> |

#### 4.2.2 Summary of Districts without Evaluation Guidance

Table 4.5 summarizes the survey responses and attachments provided by TxDOT districts without evaluation guidance.

**Table 4.5. Summary of Districts without Evaluation Guidance.**

| District    | Comment | Current Procedure                                 |
|-------------|---------|---|
| Atlanta     | NA      | To check for cracks and connecting bolts and nuts |
| Austin      | NA      | Experience and judgment                           |
| Laredo      | NA      | We inspect PCB for major cracks and spalling      |
| Lufkin      | NA      | Engineering judgement                             |
| San Antonio | NA      | Visual inspection                                 |

#### 4.2.3 Summary of Districts with “Other” Responses

Table 4.6 summarizes the “Other” survey responses and attachments provided by TxDOT districts.

**Table 4.6. Summary of Districts with “Other” Responses (Evaluation Guidance).**

| District | Comment  | Current Procedure |
|----------|--|-------------------|
| Laredo   | Not that I am aware of.  | NA                |
| Odessa   | Must visually be accepted to be used. Damaged PTB will be replaced as needed.  | NA                |
| Pharr    | We use the ATSSA guidance. If determination is made that barrier needs to be repaired we reference the txdot Concrete repair manual. | NA                |

### 4.3 REPAIR GUIDANCE

The TxDOT districts were asked if they have guidance for repairing damaged PCB segments. The answer choices were “Yes,” “No,” and “Other.” A text box was provided with each choice so that the respondents could give more information if desired. According to the survey’s logic, answering “Yes” presented three questions to the respondents. One question asked about providing a copy of or a link to the repair guidance. Another question asked what basis the agency used when adopting the repair guidance. The choices for answering were “From specifications of another Agency,” “Conducted research by your Agency,” “Past experience,” and “Other.” The third question asked about a maximum allowance of repairs for PCB segments before disposing of them. If a respondent chose “No” or “Other,” the survey presented a new question about the procedure that the respondent’s agency typically follows to repair the PCB.

#### 4.3.1 Summary of Districts with Repair Guidance

Table 4.7 summarizes the survey responses and attachments provided by TxDOT districts with repair guidance.

**Table 4.7. Summary of Districts with Repair Guidance.**

| District | Comment   | Attachment  |
|----------|---|---|
| Lufkin   | NA  | The respondent referred to concrete repair in the specifications of TxDOT |
| Pharr    | We refer to the TxDOT concrete repair manual  | <i>Concrete Repair Manual (46)</i>  |
| Waco     | We typically don’t repair SSTB or low-profile barrier but if we did repair it we would use the spec and standard guidelines |   |

##### 4.3.1.1 Concrete Repair Manual (TxDOT)

TxDOT’s 2019 *Concrete Repair Manual* entails repair procedures for use on new and existing concrete elements cast for TxDOT (46). Chapter 2 of the manual includes information on assessing type of damage, distress limits, and common types of concrete repair. The various repair materials and procedures are discussed in Chapter 3 of the manual. For the damage related to concrete barriers, spalling of concrete and voids due to honeycombing are the most common damage within concrete barriers that are discussed.

The manual categorizes the spalling defects into three groups based on severity of damage. Once the spall damage is categorized, then an appropriate repair material and installation procedure can be selected. The spall can be categorized into (46):

##### A. Minor Spall

1. Damage is less than 1 inch deep and covers an area less than 12 square inches.
2. A deeper spall (2-inch maximum) can be categorized as minor as long as it does not progress beyond the outer layer of reinforcement.

3. If the majority (more than 50%) of a reinforcing bar circumference is exposed due to inadequate cover, then the spall would be classified as Intermediate even if it is less than 1-inch deep.
- B. Intermediate Spall
1. The damage exposes a majority (more than 50%) of the outer cage of reinforcing bar circumference, or the damage is greater than 2 inches deep.
  2. The maximum depth of an intermediate spall is 6 inches.
- C. Major Spall
1. Damage extends well beyond the outer layer of reinforcement.

As mentioned above, the repair materials and procedures depend on the type of spall. The manual recommends using the neat epoxy for repairing the minor spall, while using bagged concrete repair materials to patch intermediate spalls. The structural capacity of a concrete member with major spall is reduced due to the severity of damage. Therefore, the main purpose of the repair procedure is to restore the member’s capacity to sustain loads. The repair manual recommends using batched concrete with properties like the parent material.

#### 4.3.2 Summary of Districts without Repair Guidance

Table 4.8 summarizes the survey responses and attachments provided by TxDOT districts without repair guidance.

**Table 4.8. Summary of Districts without Repair Guidance.**

| District    | Comment | Current Procedure  |
|-------------|---------|--|
| Atlanta     | NA      | Chip off to solid concrete and repair using concrete repair material                                   |
| Austin      | NA      | We refer to the concrete structure repair item specification (Item 429) and the Concrete Repair Manual |
| Odessa      | NA      | NA   |
| San Antonio | NA      | Contractors are required to maintain the PCB elements in working order                                 |

#### 4.3.3 Summary of Districts with “Other” Responses

Table 4.9 summarizes the “Other” survey responses and attachments provided by TxDOT districts.

**Table 4.9. Summary of Districts with “Other” Responses (Repair Guidance).**

| District | Comment  | Current Procedure |
|----------|--|-------------------|
| Laredo   | Not specifically, I figure we would follow our Concrete Repair Manual    | NA                |
| Laredo_2 | If the barrier can be repair, we follow the TxDOT Concrete repair manual | NA                |



## 5. DESTRUCTIVE DYNAMIC COMPONENT TESTING ON SINGLE-SLOPE AND F-SHAPE BARRIER PROFILES

Texas A&M Transportation Institute (TTI) researchers constructed test installations for PCBs and conducted bogie tests on these installations to assess the baseline strength/deflection capacities of new barrier segments as well as the corresponding residual capacities of damaged barrier segments. The impacting speed of the bogie vehicle was determined in such a way that a predetermined impact force was achieved to help ensure capacity for American Association of State Highway and Transportation Officials (AASHTO) *MASH* Test 3-11.

This chapter describes the various destructive tests performed by crashing a bogie vehicle perpendicularly into the barrier and reports the quantitative and qualitative characteristics of post-impact damages seen in the barriers (e.g., cracks, spalls, exposure of rebar, deformation of connections, etc.), along with the resulting values of barrier deflections.

The surrogate test vehicle was modeled after a *MASH* 2270P pickup truck (47). This vehicle represents the 90<sup>th</sup> percentile in terms of vehicle weight for all passenger vehicles sold in 2002 and has a similar weight and center of gravity as large SUVs. A bogie vehicle, shown in Figure 5.1, was used for the crash tests. The test inertia weight of the vehicle was 4980 lb, and the height to the upper edge of the pipe nose was 26.5 inches. The bogie vehicle was directed into the installation using the cable reverse tow and guidance system and was released to be free-wheeling and unrestrained just prior to impact.



Figure 5.1. Surrogate Test Vehicle for Single-Slope Barrier.

### 5.1 FIVE SINGLE-SLOPE BARRIER INSTALLATION

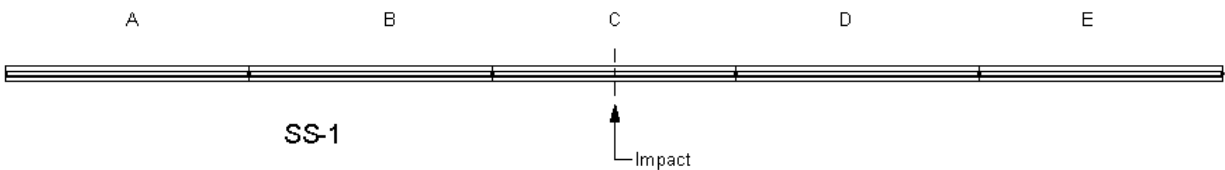
Figure 5.2 shows a typical five single-slope barrier installation. The installation consisted of five 30-ft long single-slope barriers joined together by JJ hook connections, which maintained a consistent 2-inch spacing between the barriers. The overall length of the installation was 150 ft 8 inches. Each barrier was 2 ft wide at the base and uniformly sloped upward on both sides, for a final width of 8 inches at the top with a height of 42 inches above grade. Each barrier also had two 3-inch tall, 3-ft long scuppers beginning 6 ft from either end of each barrier.

### 5.1.1 Test No. 440590-01-B1 (Single-Slope [SS]-1, Centerline of Barrier C)

Figure 5.2 shows the installation prior to the test. Figure 5.3 shows the target impact point. Table 5.1 lists events that occurred during Test No. 440590-01-B1.



**Figure 5.2. Single-Slope Barrier prior to Test No. 440590-01-B1.**



**Figure 5.3. Target Impact Point on SS-1 for Test No. 440590-01-B1.**

**Table 5.1. Events during Test No. 440590-01-B1.**

| Time (s) | Events   |
|----------|--|
| 0.0000   | Vehicle impacts barrier while traveling 27.1 mi/h and at an impact angle of 90.6 degrees |
| 0.0090   | Barrier deflects toward field side   |
| 0.0110   | First crack on field side of barrier begins to form                                      |
| 0.0300   | Tubes on bogie bumper are fully compressed   |
| 0.0440   | All cracks on backside of barrier are formed   |
| 0.4400   | Barrier stops moving toward field side   |

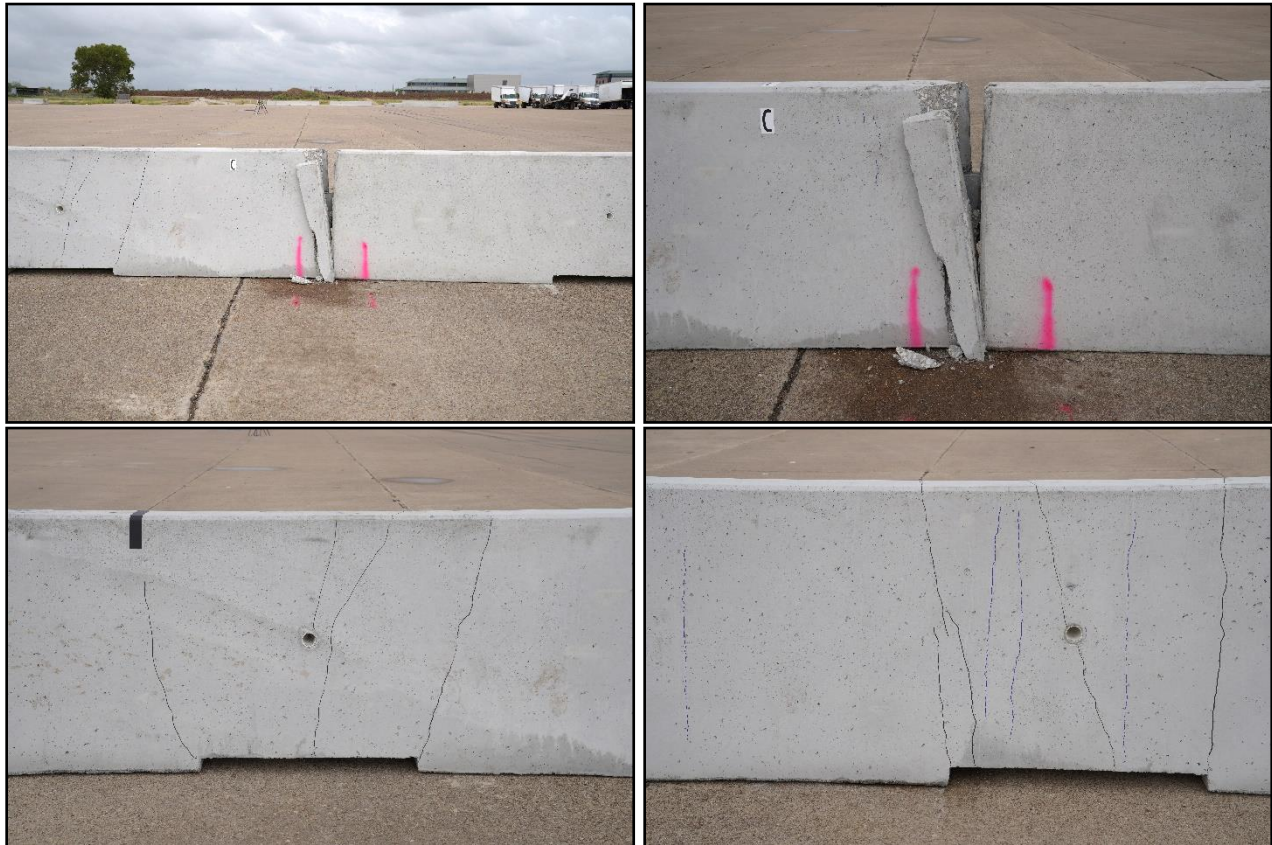
#### 5.1.1.1 Test Results

Figure 5.4 shows damage to the barrier. The blue lines indicate existing cracks, and the black lines indicate the cracks post impact. The larger, more visible cracks were not marked. The left end of barrier A moved 2 inches back, and the joint at barriers A and B moved forward by 3 inches. The joint at barriers B and C moved 1 ft back, and the joint at barriers C and D moved 13 inches back. The joint at barriers D and E moved 3 inches forward, and the right end of barrier E moved 1 inch back. Measured from the top of the joints, the gaps between the barriers were as follows: the joint of barriers A and B was 2¼ inches at the front and 2 inches at the back; the joint of barriers B and C was 2 inches at the front and 2¼ inches at the back; the joint of barriers C and D was not measurable at the front and 2½ inches at the back; and the joint of



barriers D and E was 2¼ inches at the front and 1¾ inches at the back. There was some cracking at the top of the right end of barrier B. Barrier C had cracks all along the front and back side of the barrier and had some spalling on the backside of the barrier near the bottom. Barrier D had some spalling of the concrete at the right scupper. There was a crack on the bottom of barrier D near the joint of barriers C and D. Maximum dynamic deflection during the test was 16.4 inches, and maximum permanent deformation was 13.0 inches.

Data from the accelerometers were digitized for evaluation of occupant risk, and the results are shown in Table 5.2. Figure 5.5 summarizes pertinent test impact frames.



**Figure 5.4. Single-Slope Barrier after Test No. 440590-01-B1.**

**Table 5.2. Occupant Risk Factors for Test No. 440590-01-B1.**

| Test Parameter                                | MASH         | Measured | Time                             |
|---|--------------|----------|----------------------------------|
| OIV, Longitudinal (ft/s)                      | $\leq 40.0$  | 30.5     | at 0.0930 s on front of interior |
| OIV, Lateral (ft/s)                           | $\leq 40.0$  | 0.7      | at 0.0930 s on front of interior |
| Ridedown, Longitudinal (g)                    | $\leq 20.49$ | 6.8      | 0.0933–0.1033 s                  |
| Ridedown, Lateral (g)                         | $\leq 20.49$ | 0.8      | 0.1462–0.1562 s                  |
| Theoretical Head Impact Velocity (THIV) (m/s) | N/A          | 9.3      | at 0.0930 s on front of interior |
| Acceleration Severity Index (ASI)             | N/A          | 1.9      | 0.0286–0.0786 s                  |
| 50-ms MA Longitudinal (g)                     | N/A          | -18.6 g  | 0.0000–0.0500 s                  |
| 50-ms MA Lateral (g)                          | N/A          | 0.5 g    | 0.0323–0.0823 s                  |
| 50-ms MA Vertical (g)                         | N/A          | 1.7 g    | 0.0391–0.0891 s                  |
| Roll (deg.)                                   | $\leq 75$    | 1°       | 0.1883 s                         |
| Pitch (deg.)                                  | $\leq 75$    | 3°       | 0.9669 s                         |
| Yaw (deg.)                                    | N/A          | 1°       | 0.1645 s                         |



a. 0.000 s



b. 0.100 s



c. 0.200 s



d. 0.300 s

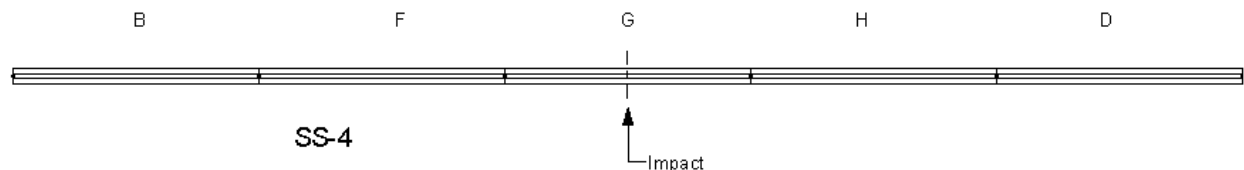
**Figure 5.5. Impact Frames for Test No. 440590-01-B1 on Single-Slope Barrier.**

### 5.1.2 Test No. 440590-01-B8 (SS-4, Centerline of Barrier G)

Figure 5.6 shows the installation prior to the test. Figure 5.7 shows the target impact point. Table 5.3 lists events that occurred during Test No. 440590-01-B8.



**Figure 5.6. Single-Slope Barrier prior to Test No. 440590-01-B8.**



**Figure 5.7. Target Impact Point on SS-4 for Test No. 440590-01-B8.**

**Table 5.3. Events during Test No. 440590-01-B8.**

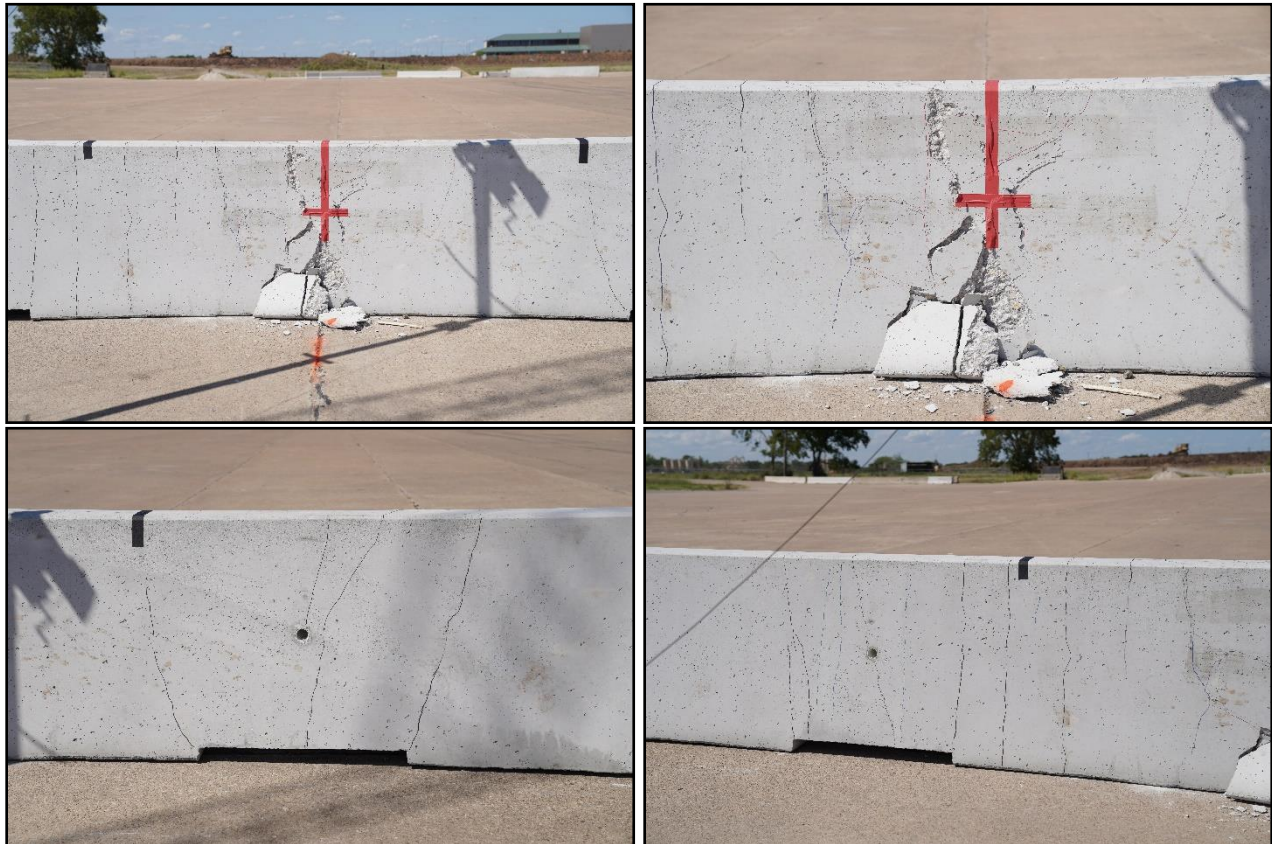
| Time (s) | Events   |
|----------|--|
| 0.0000   | Vehicle impacts barrier while traveling 27.3 mi/h and at an impact angle of 90.3 degrees |
| 0.0060   | Barrier deflects toward field side   |
| 0.0330   | Tubes on bogie bumper are fully compressed   |
| 0.0390   | Front of barrier lifts off pavement  |
| 0.3270   | Front side of barrier returns to pavement  |
| 0.3700   | Barrier stops moving toward field side   |

#### 5.1.2.1 Test Results

Figure 5.8 shows damage to the barrier. The black and blue lines indicate existing cracks, and the orange outlines indicate existing spalling. The right end of barrier E moved 1 inch back, and the joint of barriers E and D moved 2 inches forward. The joint at barriers C and D moved 11½ inches back, and the joint at barriers B and C moved 6½ inches back. The joint at barriers A and B moved 1 inch forward, and the left end of barrier A moved 1 inch back. Measured from the top of the joints, the gaps between the barriers were as follows: the joint of barriers A and B was 2 inches at both the front and back; the joint at barriers B and C was 2½ inches at the front and 2 inches at the back; the joint at barriers C and D was 2½ inches at the back, and the front was not measurable due to spalling; and the joint at barriers D and E was 2¼ inches at the front



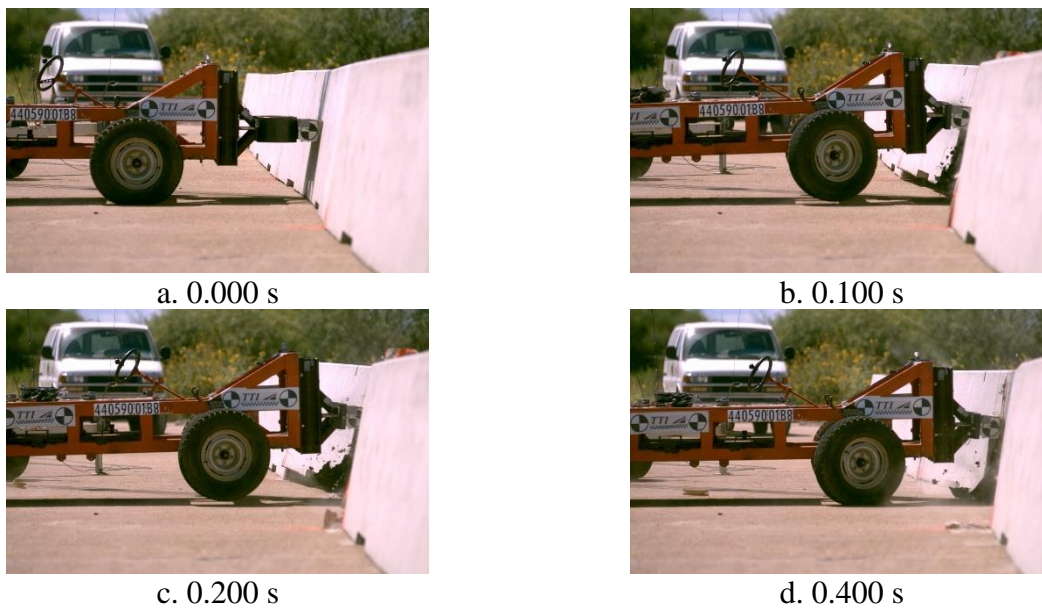
and 2 inches at the back. Barrier C had multiple cracks on both the front and the back, with one being a very large crack on the back of the barrier at impact, with rebar both exposed and broken in several places. There was some additional spalling of the concrete at the joint of barriers C and D and also at impact. Barrier B also had some cracking on both the front and the back. Maximum dynamic deflection during the test was 19.8 inches, and maximum permanent deformation was 19.0 inches. Data from the accelerometers were digitized for evaluation of occupant risk, and the results are shown in Table 5.4. Figure 5.9 summarizes pertinent test impact frames.



**Figure 5.8. Single-Slope Barrier after Test No. 440590-01-B8.**

**Table 5.4. Occupant Risk Factors for Test No. 440590-01-B8.**

| Test Parameter                                | MASH   | Measured | Time                             |
|---|--------|----------|----------------------------------|
| OIV, Longitudinal (ft/s)                      | ≤40.0  | 29.5     | at 0.0949 s on front of interior |
| OIV, Lateral (ft/s)                           | ≤40.0  | 0.3      | at 0.0949 s on front of interior |
| Ridedown, Longitudinal (g)                    | ≤20.49 | 6.1      | 0.1019–0.1119 s                  |
| Ridedown, Lateral (g)                         | ≤20.49 | 1.1      | 0.0950–0.1050 s                  |
| Theoretical Head Impact Velocity (THIV) (m/s) | N/A    | 9.0      | at 0.0950 s on front of interior |
| Acceleration Severity Index (ASI)             | N/A    | 1.9      | 0.0299–0.0799 s                  |
| 50-ms MA Longitudinal (g)                     | N/A    | −18.5    | 0.0007–0.0507 s                  |
| 50-ms MA Lateral (g)                          | N/A    | 0.4      | 0.0383–0.0883 s                  |
| 50-ms MA Vertical (g)                         | N/A    | −1.9     | 0.0015–0.0515 s                  |
| Roll (deg.)                                   | ≤75    | 2°       | 0.9139 s                         |
| Pitch (deg.)                                  | ≤75    | 11°      | 0.9700 s                         |
| Yaw (deg.)                                    | N/A    | 1°       | 0.8757 s                         |



**Figure 5.9. Impact Frames for Test No. 440590-01-B8 on Single-Slope Barrier.**

## 5.2 FOUR SINGLE-SLOPE BARRIER INSTALLATION

The installation consisted of four 30-ft long single-slope barriers joined together by JJ hook connections, which maintained a consistent 2-inch spacing between the barriers. The overall length of the installation was 120 ft 6 inches. Each barrier was 2 ft wide at the base and uniformly sloped upward on both sides, for a final width of 8 inches at the top with a height of 42 inches above grade. Each barrier also had two 3-inch tall, 3-ft long scuppers beginning 6 ft from either end of each barrier.

### 5.2.1 Test No. 440591-01-B2 (SS-2, Centerline of Joint E–A)

Figure 5.10 shows the installation prior to the test. Figure 5.11 shows the target impact point. Table 5.5 lists events that occurred during Test No. 440591-01-B2.



Figure 5.10. Single-Slope Barrier prior to Test No. 440591-01-B2.

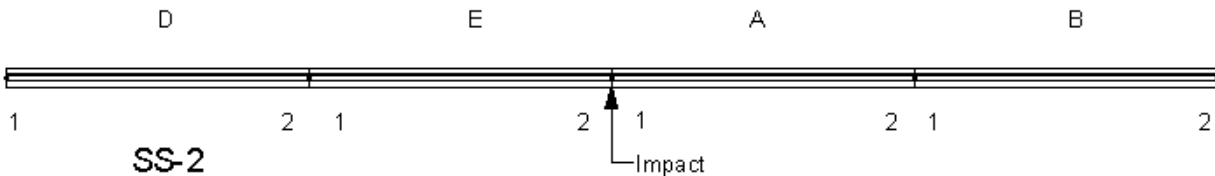


Figure 5.11. Target Impact Point on SS-2 for Test No. 440591-01-B2.

Table 5.5. Events during Test No. 440591-01-B2.

| Time (s) | Events   |
|----------|--|
| 0.0000   | Vehicle impacts barrier while traveling 18.5 mi/h and at an impact angle of 89.4 degrees |
| 0.0280   | Barrier deflects toward field side   |
| 0.0510   | Tubes on bogie bumper are fully compressed   |
| 0.4600   | Barrier stops moving toward field side   |

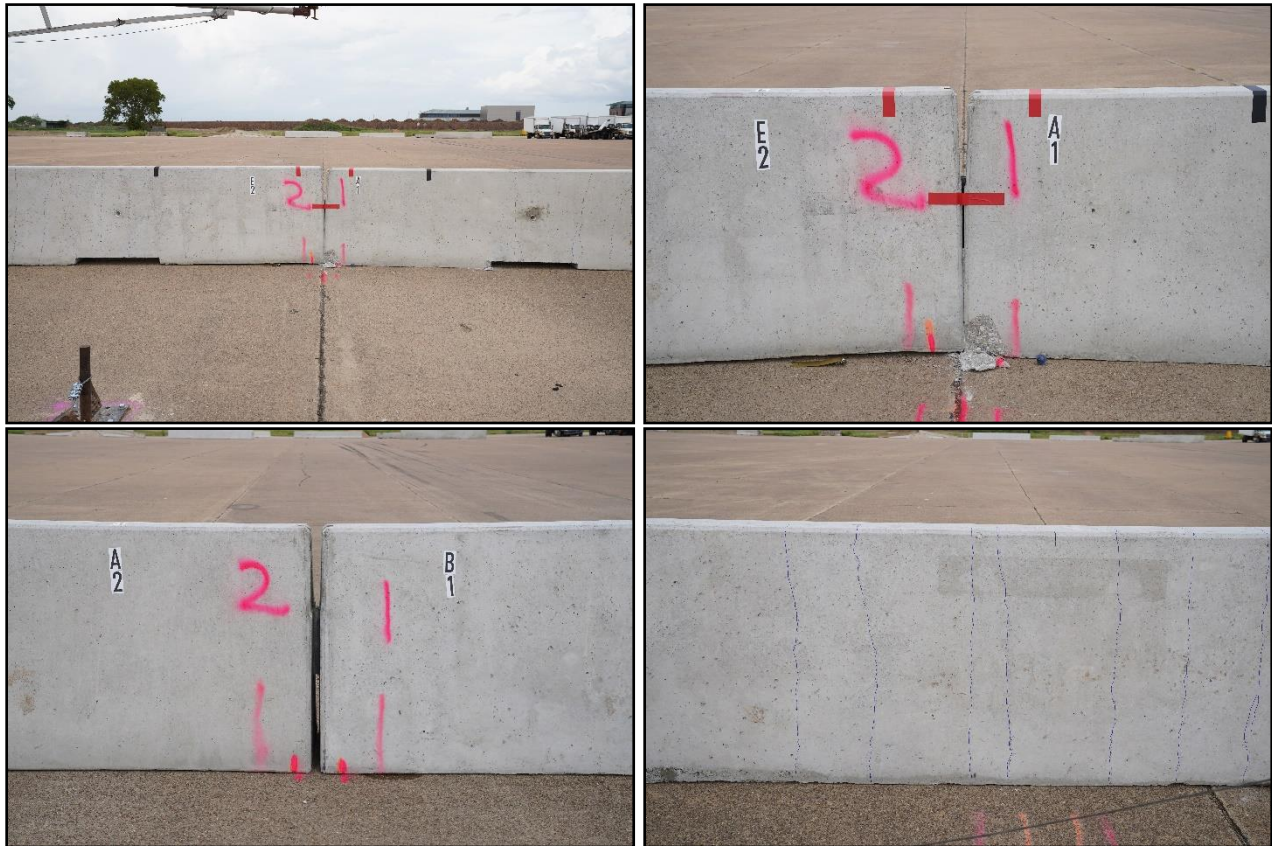
#### 5.2.1.1 Test Results

Figure 5.12 shows damage to the barrier. The black lines indicate existing cracks, and the blue lines indicate the cracks post impact. The orange paint indicates existing spalling. No movement



was noted on either the far left or far right ends of the installation. The joint at barriers D and E moved 1½ inches forward and 1½ inches to the right. The joint at barriers E and A moved 15¼ inches back, and the joint at barriers A and B moved 1 inch to the left. At the top of the joint between barriers D and E, there was a 2½-inch gap at the front and a 2-inch gap in the back. The bottom of the barrier had a 1¾-inch gap in the front and a ½-inch gap in the back. At the top of the joint between barriers E and A, there was a 1⅞-inch gap in the front and a 2⅜-inch gap in the back. The bottom of the barrier had a 2⅜-inch gap in the front and no gap in the back. At the joint between barriers A and B, there was a 2⅞-inch gap in the front and a 1⅞-inch gap in the back. The bottom of the joint had a 1¾-inch gap in the front and a ⅜-inch gap in the back. There was some spalling on the base of barrier A at the joint between barriers E and A, and also on the bottom of the backside of barrier A at the joint between barriers A and B. There was also cracking noted on all barriers and marked as indicated above. Maximum dynamic deflection during the test was 15.25 inches, and maximum permanent deformation was 15.25 inches.

Data from the accelerometers were digitized for evaluation of occupant risk, and the results are shown in Table 5.6. Figure 5.13 summarizes pertinent test impact frames.



**Figure 5.12. Single-Slope Barrier after Test No. 440591-01-B2.**

**Table 5.6. Occupant Risk Factors for Test No. 440591-01-B2.**

| Test Parameter                                | MASH   | Measured | Time                             |
|---|--------|----------|----------------------------------|
| OIV, Longitudinal (ft/s)                      | ≤40.0  | 21.7     | at 0.1229 s on front of interior |
| OIV, Lateral (ft/s)                           | ≤40.0  | 1.0      | at 0.1229 s on front of interior |
| Ridedown, Longitudinal (g)                    | ≤20.49 | 1.0      | 0.3147–0.3247 s                  |
| Ridedown, Lateral (g)                         | ≤20.49 | 0.4      | 0.1728–0.1828 s                  |
| Theoretical Head Impact Velocity (THIV) (m/s) | N/A    | 6.6      | at 0.1229 s on front of interior |
| Acceleration Severity Index (ASI)             | N/A    | 1.0      | 0.0343–0.0843 s                  |
| 50-ms MA Longitudinal (g)                     | N/A    | −12.0    | 0.0047–0.0547 s                  |
| 50-ms MA Lateral (g)                          | N/A    | −0.8     | 0.0022–0.0522 s                  |
| 50-ms MA Vertical (g)                         | N/A    | −0.6     | 0.0040–0.0540 s                  |
| Roll (deg.)                                   | ≤75    | 7°       | 2.0000 s                         |
| Pitch (deg.)                                  | ≤75    | 5°       | 1.9341 s                         |
| Yaw (deg.)                                    | N/A    | 15°      | 2.0000 s                         |



a. 0.000 s



b. 0.200 s



c. 0.400 s



d. 0.500 s

**Figure 5.13. Impact Frames for Test No. 440591-01-B2 on Single-Slope Barrier.**



### 5.2.2 Test No. 440591-01-B9 (SS-5, Centerline between Joints E–A)

Figure 5.14 shows the installation prior to the test. Figure 5.15 shows the target impact point. Table 5.7 lists events that occurred during Test No. 440591-01-B9.



Figure 5.14. Single-Slope Barrier prior to Test No. 440591-01-B9.

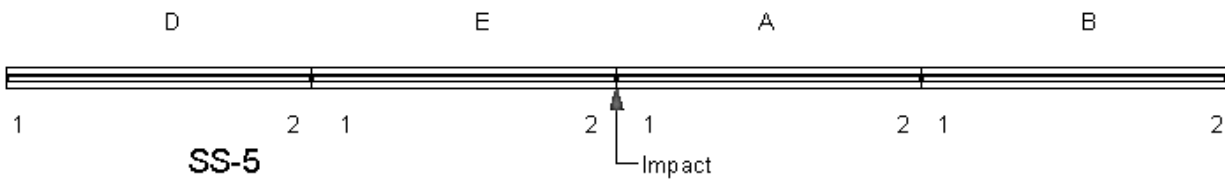


Figure 5.15. Target Impact Point on SS-5 for Test No. 440591-01-B9.

Table 5.7. Events during Test No. 440591-01-B9.

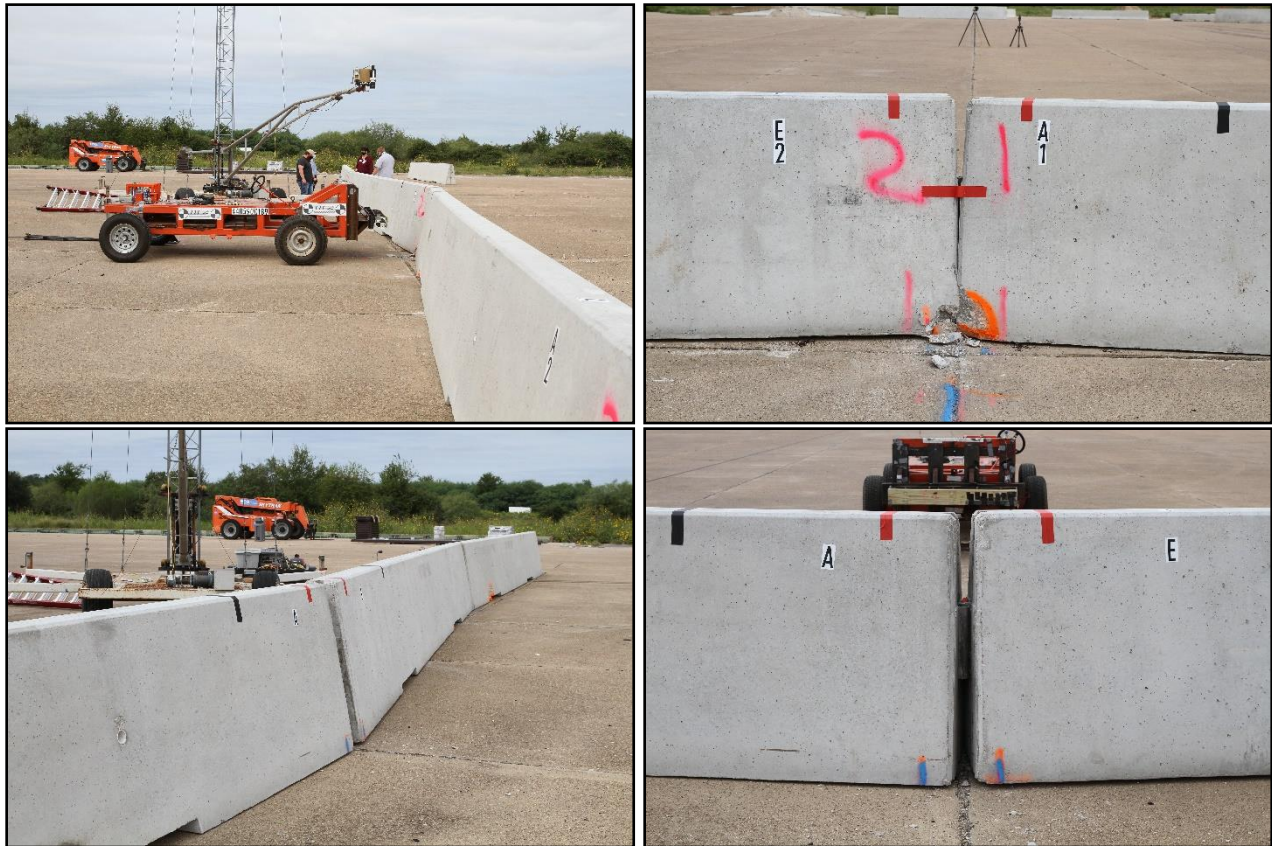
| Time (s) | Events   |
|----------|--|
| 0.0000   | Vehicle impacts barrier while traveling 23.0 mi/h and at an impact angle of 89.6 degrees |
| 0.0090   | Barrier deflects toward field side   |
| 0.0370   | Tubes on bogie bumper are fully compressed   |
| 0.0380   | Barriers G and F begin to lift off pavement  |
| 0.1610   | Barriers G and F return to pavement  |
| 0.4810   | Barrier stops moving toward field side   |

#### 5.2.2.1 Test Results

Figure 5.16 shows damage to the barrier. The black and blue lines indicate existing cracks, the orange paint indicates existing spalling, and the red lines indicate cracks post impact. The left end of barrier D moved 1 inch to the right. The joint of barriers D and E moved 4½ inches forward, and the joint of barriers E and A moved 31½ inches back. The joint of barriers A and B moved 3 inches forward, and the right end of barrier B moved ¾ inches to the left. At the top of the joint between barriers D and E, there was a 2½-inch gap in the front and a 2-inch gap in the back. The bottom of the barriers had a 2-inch gap in the front and no gap in the back. At the top of the joint between barriers E and A, there was a 2-inch gap in the front and a 3¾-inch gap in

the back. The bottom of the barriers had no gap in the front and a 4-inch gap in the back. At the top of the joint between barriers A and B, there was a 2¼-inch gap in the front and a 1⅞-inch gap in the back. The bottom of the barriers had a 2½-inch gap in the front and no gap in the back. There was some spalling at the joint between barriers E and A on the front base of both barriers. Barrier A also had some spalling at its base on the backside of the barrier at the joint between barriers A and B. There were cracks on the front and back of barriers E and A, and also one small crack on the front of barrier D. Maximum dynamic deflection during the test was 31.6 inches, and maximum permanent deformation was 31.5 inches.

Data from the accelerometers were digitized for evaluation of occupant risk, and the results are shown in Table 5.8. Figure 5.17 summarizes pertinent test impact frames.



**Figure 5.16. Single-Slope Barrier after Test No. 440591-01-B9.**

**Table 5.8. Occupant Risk Factors for Test No. 440591-01-B9.**

| Test Parameter                                | MASH   | Measured | Time                             |
|---|--------|----------|----------------------------------|
| OIV, Longitudinal (ft/s)                      | ≤40.0  | 25.3     | at 0.1068 s on front of interior |
| OIV, Lateral (ft/s)                           | ≤40.0  | 1.6      | at 0.1068 s on front of interior |
| Ridedown, Longitudinal (g)                    | ≤20.49 | 5.8      | 0.4132–0.4232 s                  |
| Ridedown, Lateral (g)                         | ≤20.49 | 0.9      | 0.1382–0.1482 s                  |
| Theoretical Head Impact Velocity (THIV) (m/s) | N/A    | 7.7      | at 0.1068 s on front of interior |
| Acceleration Severity Index (ASI)             | N/A    | 1.4      | 0.0316–0.0816 s                  |
| 50-ms MA Longitudinal (g)                     | N/A    | -15.7    | 0.0020–0.0520 s                  |
| 50-ms MA Lateral (g)                          | N/A    | 0.7      | 0.0059–0.0559 s                  |
| 50-ms MA Vertical (g)                         | N/A    | 1.1      | 0.0140–0.0640 s                  |
| Roll (deg.)                                   | ≤75    | 2°       | 1.9815 s                         |
| Pitch (deg.)                                  | ≤75    | 7°       | 2.0000 s                         |
| Yaw (deg.)                                    | N/A    | 3°       | 2.0000 s                         |



a. 0.000 s



b. 0.200 s



c. 0.400 s



d. 0.500 s

**Figure 5.17. Impact Frames for Test No. 440591-01-B9 on Single-Slope Barrier.**



### 5.2.3 Test No. 440591-01-B7 (SS-3, Centerline between Joints E–A)

Figure 5.18 shows the installation prior to the test. Figure 5.19 shows the target impact point. Table 5.9 lists events that occurred during Test No. 440591-01-B7.

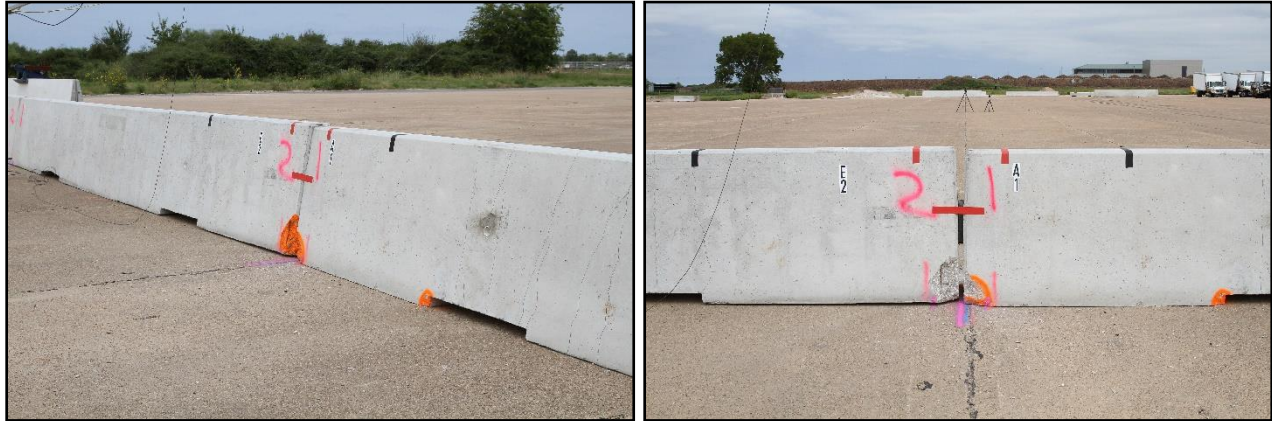


Figure 5.18. Single-Slope Barrier prior to Test No. 440591-01-B7.

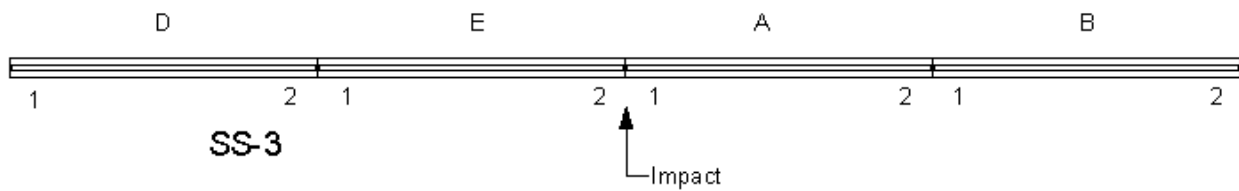


Figure 5.19. Target Impact Point on SS-3 for Test No. 440591-01-B7.

Table 5.9. Events during Test No. 440591-01-B7.

| Time (s) | Events   |
|----------|--|
| 0.0000   | Vehicle impacts barrier while traveling 26.2 mi/h and at an impact angle of 90.1 degrees |
| 0.0130   | Barrier deflects toward field side   |
| 0.0320   | Tubes on bogie bumper are fully compressed   |
| 0.0430   | Barriers G and F begin to lift off pavement  |
| 0.1880   | Barriers G and F return to pavement  |
| 0.5580   | Barrier stops moving toward field side   |

#### 5.2.3.1 Test Results

Figure 5.20 shows damage to the barrier. Black, blue, and red lines indicate existing cracks; orange paint indicates existing spalling; and green lines indicate cracks post impact. The left end of barrier D moved ½ inch forward and 3 inches to the right. The joint of barriers D and E moved 4½ inches forward, and the joint of barriers E and A moved 45½ inches back. The joint of barriers A and B moved 3 inches forward, and the right end of barrier B moved ½ inch back and 2 inches to the left. At the top of the joint between barriers D and E, there was a 2½-inch gap in the front and a 2-inch gap in the back. The bottom of the barriers had a 2¾-inch gap in the front and no gap in the back. There was some slight cracking and spalling on the base of barrier D on

the backside of the barrier at the joint between barriers D and E. At the top of the joint between barriers E and A, there was a 2½-inch gap in the front and a 4¼-inch gap in the back. The bottom of the barriers had no gap in the front and a 5¾-inch gap in the back. The JJ hooks were deformed at the joint, and there was spalling on the front of each barrier near the base. At the joint between barriers A and B, there was a 2¾-inch gap in the front and a 2-inch gap in the back. The bottom of the barriers had a 2¾-inch gap in the front and no gap in the back. There was some spalling on the back of barrier A near the base at the joint. There were cracks on the front and back of barriers E and A, and also on the backside of barrier B. The front of barrier E had some spalling in the middle of the barrier at its base. Maximum dynamic deflection during the test was 45.5 inches, and maximum permanent deformation was 45.5 inches.

Data from the accelerometers were digitized for evaluation of occupant risk, and the results are shown in Table 5.10. Figure 5.21 summarizes pertinent test impact frames.



**Figure 5.20. Single-Slope Barrier after Test No. 440591-01-B7.**

**Table 5.10. Occupant Risk Factors for Test No. 440591-01-B7.**

| Test Parameter                                | MASH   | Measured | Time                             |
|---|--------|----------|----------------------------------|
| OIV, Longitudinal (ft/s)                      | ≤40.0  | 26.9     | at 0.1031 s on front of interior |
| OIV, Lateral (ft/s)                           | ≤40.0  | 2.3      | at 0.1031 s on front of interior |
| Ridedown, Longitudinal (g)                    | ≤20.49 | 4.9      | 0.1031–0.1131 s                  |
| Ridedown, Lateral (g)                         | ≤20.49 | 1.4      | 0.1141–0.1241 s                  |
| Theoretical Head Impact Velocity (THIV) (m/s) | N/A    | 8.3      | at 0.1032 s on front of interior |
| Acceleration Severity Index (ASI)             | N/A    | 1.6      | 0.0297–0.0797 s                  |
| 50-ms MA Longitudinal (g)                     | N/A    | −16.3    | 0.0004–0.0504 s                  |
| 50-ms MA Lateral (g)                          | N/A    | 1.8      | 0.0385–0.0885 s                  |
| 50-ms MA Vertical (g)                         | N/A    | −1.1     | 0.3062–0.3562 s                  |
| Roll (deg.)                                   | ≤75    | 3°       | 2.0000 s                         |
| Pitch (deg.)                                  | ≤75    | 3°       | 1.8637 s                         |
| Yaw (deg.)                                    | N/A    | 3°       | 1.9072 s                         |



a. 0.000 s



b. 0.200 s



c. 0.400 s



d. 0.600 s

**Figure 5.21. Impact Frames for Test No. 440591-01-B7 on Single-Slope Barrier.**



### 5.2.4 Test No. 440591-01-B10 (SS-6, Centerline between Joints E–A)

Figure 5.22 shows the installation prior to the test. Figure 5.23 shows the target impact point. Table 5.11 lists events that occurred during Test No. 440591-01-B10.



Figure 5.22. Single-Slope Barrier prior to Test No. 440591-01-B10.

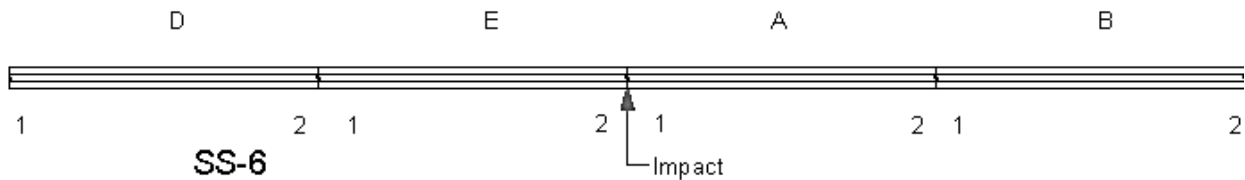


Figure 5.23. Target Impact Point on SS-6 for Test No. 440591-01-B10.

Table 5.11. Events during Test No. 440591-01-B10.

| Time (s) | Events   |
|----------|--|
| 0.0000   | Vehicle impacts barrier while traveling 26.4 mi/h and at an impact angle of 89.4 degrees |
| 0.0130   | Barrier deflects toward field side   |
| 0.0320   | Tubes on bogie bumper are fully compressed   |
| 0.0440   | Barriers G and F begin to lift off pavement  |
| 0.1830   | Barriers G and F return to pavement  |
| 0.6740   | Barrier stops moving toward field side   |

#### 5.2.4.1 Test Results

Figure 5.24 shows damage to the barrier. The black, blue, red, and green lines indicate existing cracks; orange paint indicates existing spalling; and red lines labeled “-B10” indicate cracks post impact. The left end of barrier D moved ½ inch back and 3½ inches to the right. The joint of barriers D and E moved 4½ inches forward, and the joint of barriers E and A moved 49 inches back. The joint of barriers A and B moved 3½ inches forward, and the right end of barrier B moved 3½ inches left and 1 inch back. At the top of the joint between barriers D and E, there was a 2¾-inch gap in the front and a 2-inch gap in the back. The bottom of the barriers had a 3-inch gap in the front and no gap in the back. At the top of the joint between barriers E and A,

there was a 2¾-inch gap in the front and a 4¾-inch gap in the back. The bottom of the barriers had no gap in the front and a 6¼-inch gap in the back. At the joint between barriers A and B, there was a 2¾-inch gap in the front and a 2-inch gap in the back. The bottom of the barriers had a 2¾-inch gap in the front and no gap in the back. The right end of barrier B moved 3½ inches left and 1 inch back. The front of barrier D had some spalling near the top of the barrier at the joint between barriers D and E. The front of barriers A and B had spalling at the base of the barriers at the joint, and barrier A also had some spalling on the backside of the barrier at its base at the joint between barriers A and B. There was some cracking on barriers A, B, and E. Maximum dynamic deflection during the test was 49.3 inches, and maximum permanent deformation was 49.0 inches.

Data from the accelerometers were digitized for evaluation of occupant risk, and the results are shown in Table 5.12. Figure 5.25 summarizes pertinent test impact frames.



**Figure 5.24. Single-Slope Barrier after Test No. 440591-01-B10.**



**Table 5.12. Occupant Risk Factors for Test No. 440591-01-B10.**

| Test Parameter                                | MASH   | Measured | Time                             |
|---|--------|----------|----------------------------------|
| OIV, Longitudinal (ft/s)                      | ≤40.0  | 26.6     | at 0.1049 s on front of interior |
| OIV, Lateral (ft/s)                           | ≤40.0  | 0.7      | at 0.1049 s on front of interior |
| Ridedown, Longitudinal (g)                    | ≤20.49 | 3.6      | 0.3170–0.3270 s                  |
| Ridedown, Lateral (g)                         | ≤20.49 | 1.8      | 0.1049–0.1149 s                  |
| Theoretical Head Impact Velocity (THIV) (m/s) | N/A    | 8.1      | at 0.1049 s on front of interior |
| Acceleration Severity Index (ASI)             | N/A    | 1.6      | 0.0293–0.0793 s                  |
| 50-ms MA Longitudinal (g)                     | N/A    | -15.8    | 0.0013–0.0513 s                  |
| 50-ms MA Lateral (g)                          | N/A    | 0.8      | 0.1038–0.1538 s                  |
| 50-ms MA Vertical (g)                         | N/A    | 1.7      | 0.0141–0.0641 s                  |
| Roll (deg.)                                   | ≤75    | 3°       | 2.0000 s                         |
| Pitch (deg.)                                  | ≤75    | 13°      | 2.0000 s                         |
| Yaw (deg.)                                    | N/A    | 8°       | 1.9875 s                         |



a. 0.000 s



b. 0.200 s



c. 0.400 s



d. 0.500 s

**Figure 5.25. Impact Frames for Test No. 440591-01-B10 on Single-Slope Barrier.**

### 5.3 FIVE F-SHAPE BARRIER INSTALLATION

The installation consisted of five 30-ft long F-shape barriers joined together by JJ hook connections, which maintained a consistent 2-inch spacing between the barriers. The overall length of the installation was 150 ft 8 inches. Each barrier was 24 inches wide at the base and began a compound upward slope on both sides of the barrier, for a final width of 9½ inches at the top with a height of 32 inches above grade. Each barrier also had two 3-inch tall, 3-ft long scuppers beginning 6 ft from either end of each barrier.

#### 5.3.1 Test No. 440590-01-B3 (F-1, Centerline of Barrier C)

Figure 5.26 shows the installation prior to Test No. 440590-01-B3. Figure 5.27 shows the target impact point. Table 5.13 lists events that occurred during Test No. 440590-01-B3.



Figure 5.26. F-Shape Barrier prior to Test No. 440590-01-B3.

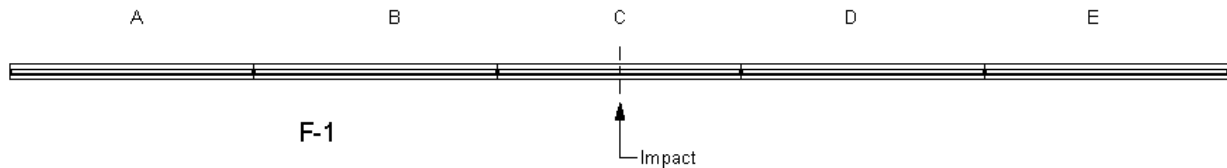


Figure 5.27. Target Impact Point on F-1 for Test No. 440590-01-B3.

Table 5.13. Events during Test No. 440590-01-B3.

| Time (s) | Events   |
|----------|--|
| 0.0000   | Vehicle impacts barrier while traveling 22.1 mi/h and at an impact angle of 90.6 degrees |
| 0.0020   | First crack on field side of barrier begins to form                                      |
| 0.0070   | Barrier begins to move toward field side   |
| 0.0110   | Additional cracks on field side of barrier begin to form                                 |
| 0.0390   | Tubes on bogie bumper are fully compressed   |
| 0.0830   | All cracks on field side of barrier are formed   |
| 0.0910   | Barrier lifts off pavement   |
| 0.2820   | Barrier returns to pavement  |
| 0.3280   | Barrier stops moving toward field side   |

### 5.3.1.1 Test Results

Figure 5.28 shows damage to the barrier. The red lines indicate existing cracks, and the black lines indicate the cracks post impact. The larger, more visible cracks were not marked. No movement was noted on either the far left or far right ends of the installation. The joint at barriers A and B moved 2½ inches forward, and the joint at barriers B and C moved 12½ inches back. The joint at barriers C and D moved 14 inches back, and the joint at barriers D and E moved 1 inch forward. Measured from the top of the joints, the gaps between the barriers were as follows: the joint of barriers A and B was 2¼ inches at the front and 2 inches at the back; the joint of barriers B and C was 2 inches at the front and 2½ inches at the back; the joint of barriers C and D was 2 inches at the front, and the back was not measurable due to spalling; and the joint of barriers D and E was 2½ inches at the front and 2 inches at the back. There were cracks at the scuppers of all the barriers. There was exposed rebar on the backside of barrier D at the joint of barriers C and D, and barrier C had some spalled concrete at this joint as well. Barrier D also had major cracking on its base at the middle of the barrier. There was some spalling at the base of barrier E at the joint of barriers D and E. Barrier C had some spalling at various locations along the backside of the barrier, and there was also a ¼-inch crack starting from the inner corner of the right scupper on the backside of the barrier. There was some spalling at the base of barrier B, as well as at the end and left corner of barrier A. Maximum dynamic deflection during the test was 20.2 inches, and maximum permanent deformation was 14.0 inches.

Data from the accelerometers were digitized for evaluation of occupant risk, and the results are shown in Table 5.14. Figure 5.29 summarizes pertinent test impact frames.

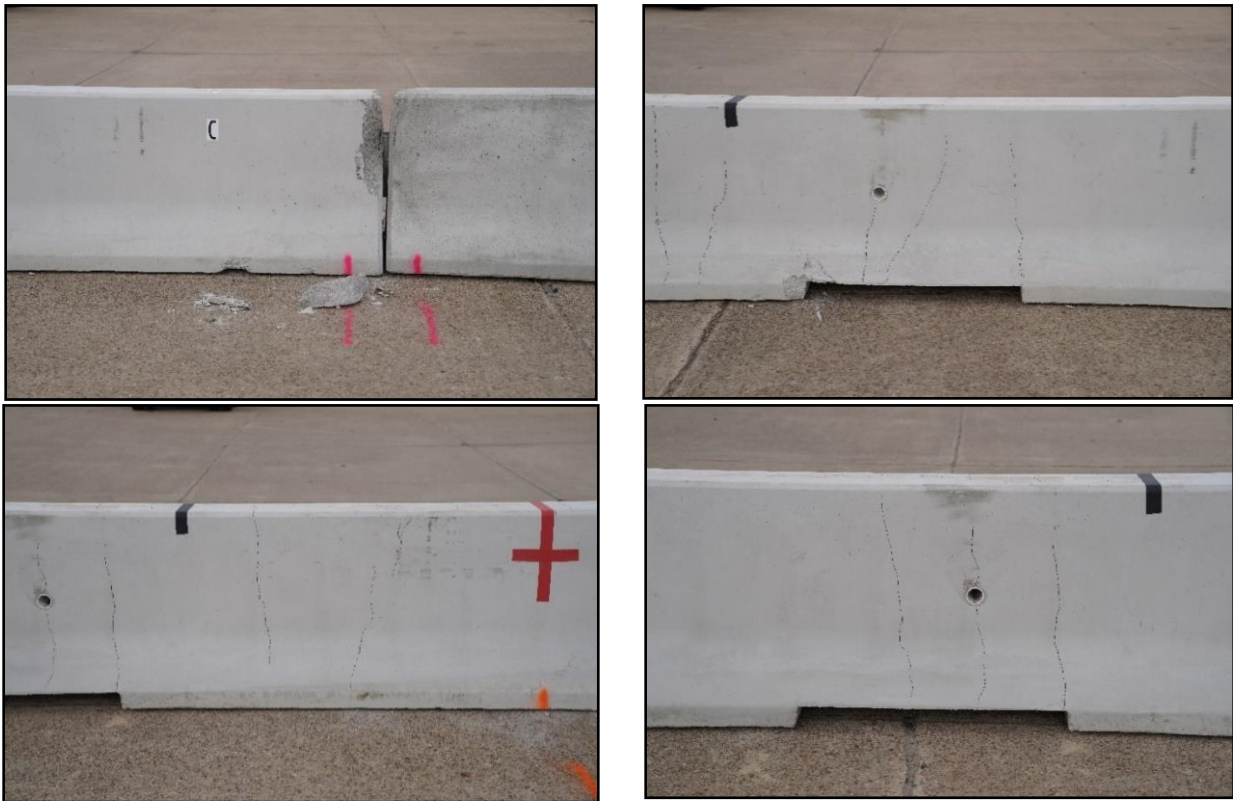


Figure 5.28. F-Shape Barrier after Test No. 440590-01-B3.

**Table 5.14. Occupant Risk Factors for Test No. 440590-01-B3.**

| Test Parameter                                | MASH         | Measured | Time                             |
|---|--------------|----------|----------------------------------|
| OIV, Longitudinal (ft/s)                      | $\leq 40.0$  | 25.3     | at 0.1182 s on front of interior |
| OIV, Lateral (ft/s)                           | $\leq 40.0$  | 0.3      | at 0.1182 s on front of interior |
| Ridedown, Longitudinal (g)                    | $\leq 20.49$ | 3.3      | 0.2898–0.2998 s                  |
| Ridedown, Lateral (g)                         | $\leq 20.49$ | 0.7      | 0.1259–0.1359 s                  |
| Theoretical Head Impact Velocity (THIV) (m/s) | N/A          | 7.7      | at 0.1182 s on front of interior |
| Acceleration Severity Index (ASI)             | N/A          | 1.3      | 0.0356–0.0856 s                  |
| 50-ms MA Longitudinal (g)                     | N/A          | -13.8    | 0.0038–0.0538 s                  |
| 50-ms MA Lateral (g)                          | N/A          | -0.3     | 0.0021–0.0521 s                  |
| 50-ms MA Vertical (g)                         | N/A          | -1.3     | 0.0001–0.0501 s                  |
| Roll (deg.)                                   | $\leq 75$    | 1°       | 0.9672 s                         |
| Pitch (deg.)                                  | $\leq 75$    | 2°       | 0.9353 s                         |
| Yaw (deg.)                                    | N/A          | 1°       | 0.2249 s                         |



a. 0.000 s



b. 0.100 s



c. 0.200 s



d. 0.400 s

**Figure 5.29. Impact Frames for Test No. 440590-01-B3 on F-Shape Barrier.**

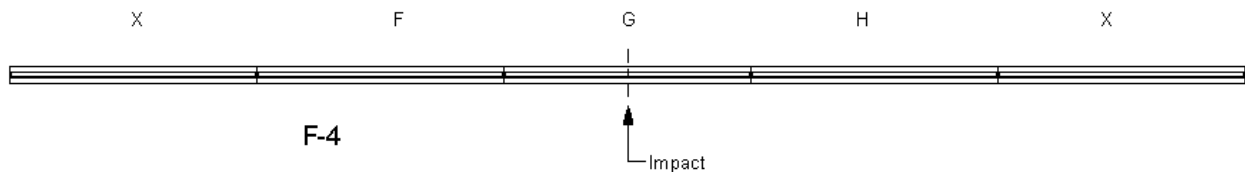


### 5.3.2 Test No. 440590-01-B11 (F-4, Centerline of Barrier G)

Figure 5.30 shows the installation prior to the test. Figure 5.31 shows the target impact point. Table 5.15 lists events that occurred during Test No. 440590-01-B11.



**Figure 5.30. F-Shape Barrier prior to Test No. 440590-01-B11.**



**Figure 5.31. Target Impact Point on F-4 for Test No. 440590-01-B11.**

**Table 5.15. Events during Test No. 440590-01-B11.**

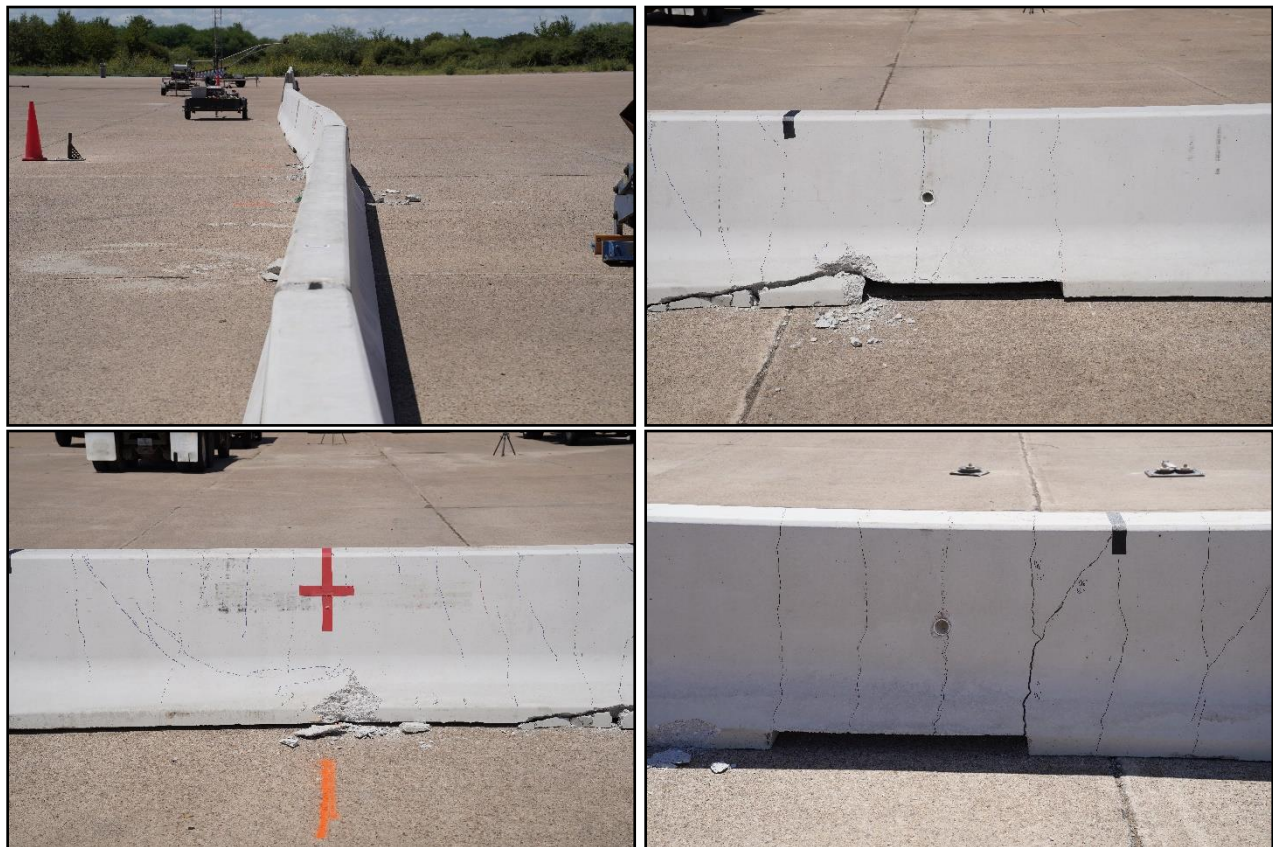
| Time (s) | Events   |
|----------|--|
| 0.0000   | Vehicle impacts barrier while traveling 22.3 mi/h and at an impact angle of 91.4 degrees |
| 0.0140   | Barrier deflects toward field side   |
| 0.0430   | Tubes on bogie bumper are fully compressed   |
| 0.0870   | Barrier lifts off pavement   |
| 0.3370   | Front side of barrier returns to pavement  |
| 0.5100   | Barrier stops moving toward field side   |

#### 5.3.2.1 Test Results

Figure 5.32 shows the damage to the barrier. The black and red lines indicate existing cracks, and blue lines indicate cracks post impact. Green indicates existing concrete spalling. There was no movement noted on the left end of barrier A. The right end of barrier A moved ½ inch forward, and the left end of barrier B moved ¼ inch forward. The right end of barrier B moved 13 inches back, and the left end of barrier C moved 12½ inches back. The right end of barrier C moved 16½ inches back, and the left end of barrier D moved 14½ inches back. The right end of barrier D and the left end of barrier E moved ½ inch forward. There was no movement noted at the right end of barrier E. Measured from the top of the joints, the gaps between the barriers were as follows: the joint of barriers A and B was 2¼ inches at the front and 2 inches at the back; the

joint of barriers B and C was 2¼ inches at the front and 2 inches at the back; the joint of barriers C and D was 2⅝ inches at the front, and the back was not measurable due to spalling; and the joint at barriers D and E was 2½ inches at the front and 2⅝ inches at the back. There was spalling of the concrete at barrier C on the backside of the barrier at both joints and on the front of the barrier at the joint of barriers C and D. There was also some spalling of the concrete at the base of the barrier at impact. There was some major spalling on the front of barrier C just to the left of the right scupper. There was cracking on the front and backside of barriers C and D, with a ⅛-inch crack on the backside of barrier C widening to ¼ inch. Barrier D had some concrete spalling on the front of the base in the middle. There was also cracking on the backside of barrier E and the front of barriers A and B. Maximum dynamic deflection during the test was 16.6 inches, and maximum permanent deformation was 16.5 inches.

Data from the accelerometers were digitized for evaluation of occupant risk, and the results are shown in Table 5.16. Figure 5.33 summarizes pertinent test impact frames.

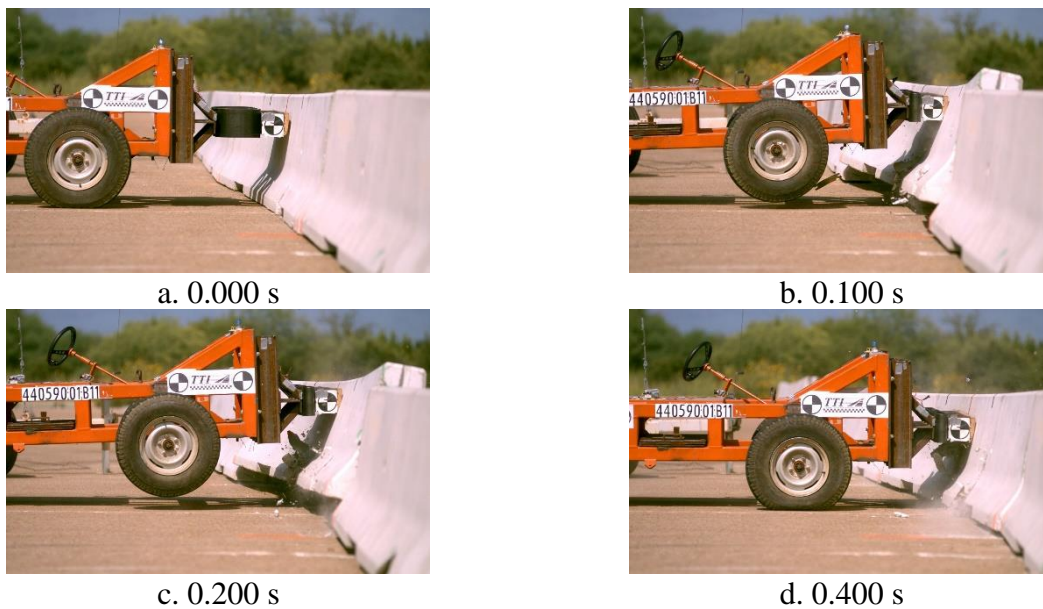


**Figure 5.32. F-Shape Barrier after Test No. 440590-01-B11.**

**Table 5.16. Occupant Risk Factors for Test No. 440590-01-B11.**

| <b>Test Parameter</b>      | <b>MASH</b> | <b>Measured</b> | <b>Time</b>                      |
|----------------------------|-------------|-----------------|----------------------------------|
| OIV, Longitudinal (ft/s)   | ≤40.0       | 25.9            | at 0.1157 s on front of interior |
| OIV, Lateral (ft/s)        | ≤40.0       | 0.7             | at 0.1157 s on front of interior |
| Ridedown, Longitudinal (g) | ≤20.49      | 3.0             | 0.1157–0.1257 s                  |
| Ridedown, Lateral (g)      | ≤20.49      | 0.9             | 0.3593–0.3693 s                  |

|   |     |       |                                  |
|---|-----|-------|----------------------------------|
| Theoretical Head Impact Velocity (THIV) (m/s) | N/A | 8.0   | at 0.1157 s on front of interior |
| Acceleration Severity Index (ASI)             | N/A | 1.4   | 0.0358–0.0858 s                  |
| 50-ms MA Longitudinal (g)                     | N/A | -14.4 | 0.0026–0.0526 s                  |
| 50-ms MA Lateral (g)                          | N/A | -0.5  | 0.0709–0.1209 s                  |
| 50-ms MA Vertical (g)                         | N/A | -1.9  | 0.0012–0.0512 s                  |
| Roll (deg.)                                   | ≤75 | 5°    | 1.0000 s                         |
| Pitch (deg.)                                  | ≤75 | 3°    | 0.1510 s                         |
| Yaw (deg.)                                    | N/A | 2°    | 0.6665 s                         |



**Figure 5.33. Impact Frames for Test No. 440590-01-B11 on F-Shape Barrier.**

## 5.4 FOUR F-SHAPE BARRIER INSTALLATION

The installation consisted of four 30-ft long F-shape barriers joined together by JJ hook connections, which maintained a consistent 2-inch spacing between the barriers. The overall length of the installation was 120 ft 6 inches. Each barrier was 24 inches wide at the base and began a compound upward slope on both sides of the barrier, for a final width of 9½ inches at the top with a height of 32 inches above grade. Each barrier also had two 3-inch tall, 3-ft long scuppers beginning 6 ft from either end of each barrier.

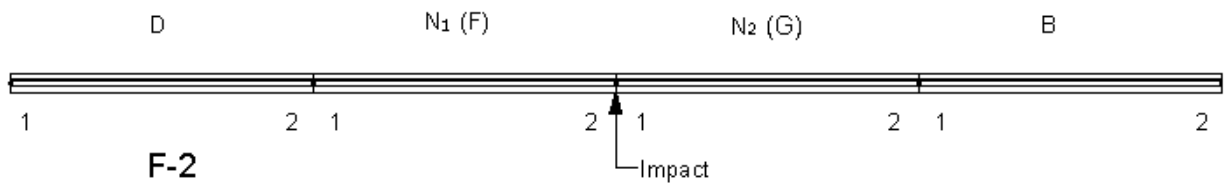
### 5.4.1 Test No. 440591-01-B4 (F-2, between Barriers F and G)

Figure 5.34 shows the installation prior to Test No. 440591-01-B4. Figure 5.35 shows the target impact point. Table 5.17 lists events that occurred during Test No. 440591-01-B4.





**Figure 5.34. F-Shape Barrier prior to Test No. 440591-01-B4.**



**Figure 5.35. Target Impact Point on F-2 for Test No. 440591-01-B4.**

**Table 5.17. Events during Test No. 440591-01-B4.**

| Time (s) | Events   |
|----------|--|
| 0.0000   | Vehicle impacts barrier while traveling 19.0 mi/h and at an impact angle of 87.7 degrees |
| 0.0080   | Barrier deflects toward field side   |
| 0.0440   | Tubes on bogie bumper are fully compressed   |
| 0.0560   | Barriers G and F begin to lift off pavement  |
| 0.1680   | Barriers G and F return to pavement  |
| 0.4520   | Barrier stops moving toward field side   |

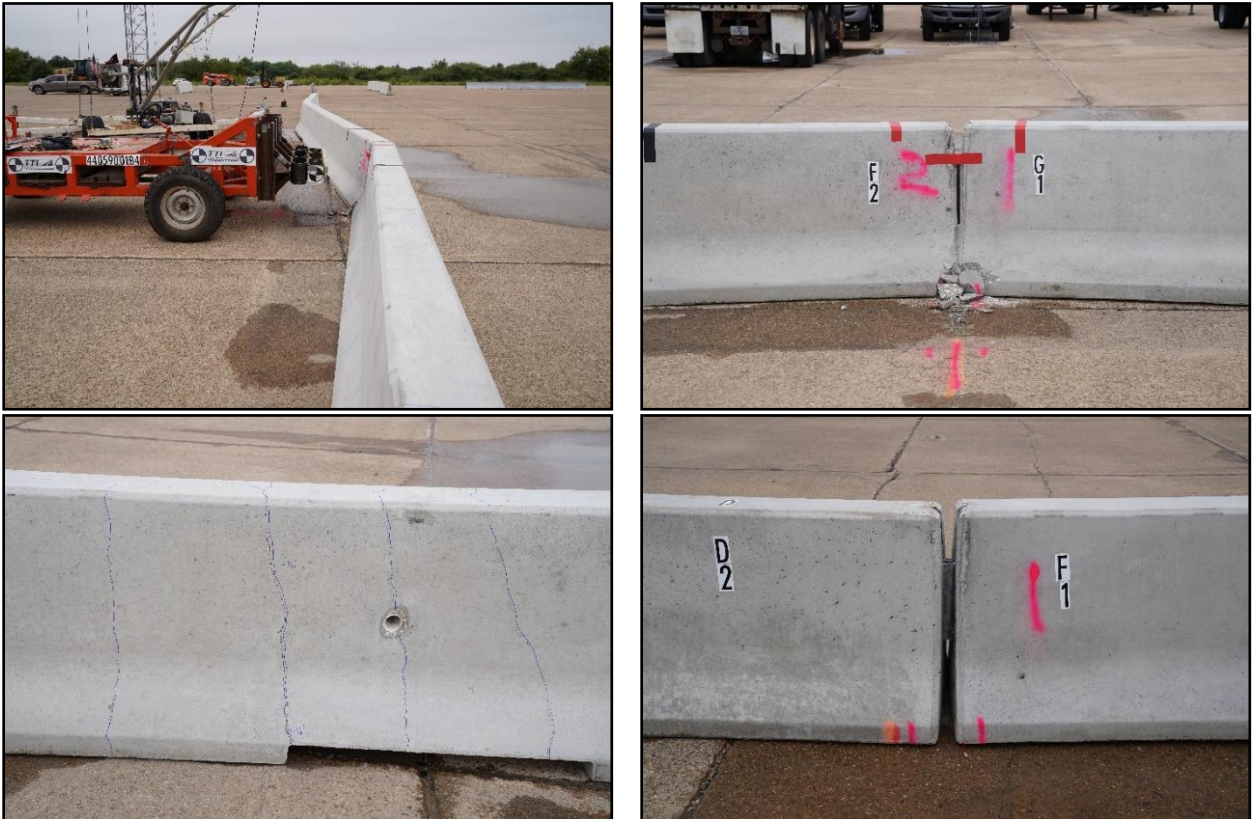
### 5.4.1.1 Test Results

Figure 5.36 shows damage to the barrier. The black lines indicate existing cracks, and the orange paint indicates existing concrete spalling. The blue lines indicate cracks that occurred post impact. The left end of barrier D moved 4½ inches back. The joint at barriers D and F moved 5 inches forward, and the joint at barriers F and G moved 31 inches back. The joint at barriers G and B moved 3 inches forward, and the right end of barrier B moved 2½ inches back. At the top of the joint between barriers D and F, there was a 3-inch gap in the front and a 2-inch gap in the back. The bottom of the barriers had a 3-inch gap in the front and no gap in the back. At the top of the joint between barriers F and G, there was a 2-inch gap in the front and a 3½-inch gap in the back. The bottom of the barriers had no gap in the front and a 4-inch gap in the back. There was also some spalling at the base of both barriers at the joint. At the top of the joint between barriers G and B, there was a 2½-inch gap in the front and a 1¾-inch gap in the back. The bottom of the barriers had a 2¼-inch gap in the front and no gap in the back. There was some spalling



present on the back base of both barriers at the joint. Barrier F had a  $\frac{1}{16}$ -inch crack on the left end of the right scupper on the front face of the barrier. This crack narrowed as it traveled up the barrier to  $\frac{1}{32}$  of an inch. Maximum dynamic deflection during the test was 31.3 inches, and maximum permanent deformation was 31.0 inches.

Data from the accelerometers were digitized for evaluation of occupant risk, and the results are shown in Table 5.18. Figure 5.37 summarizes pertinent test impact frames.

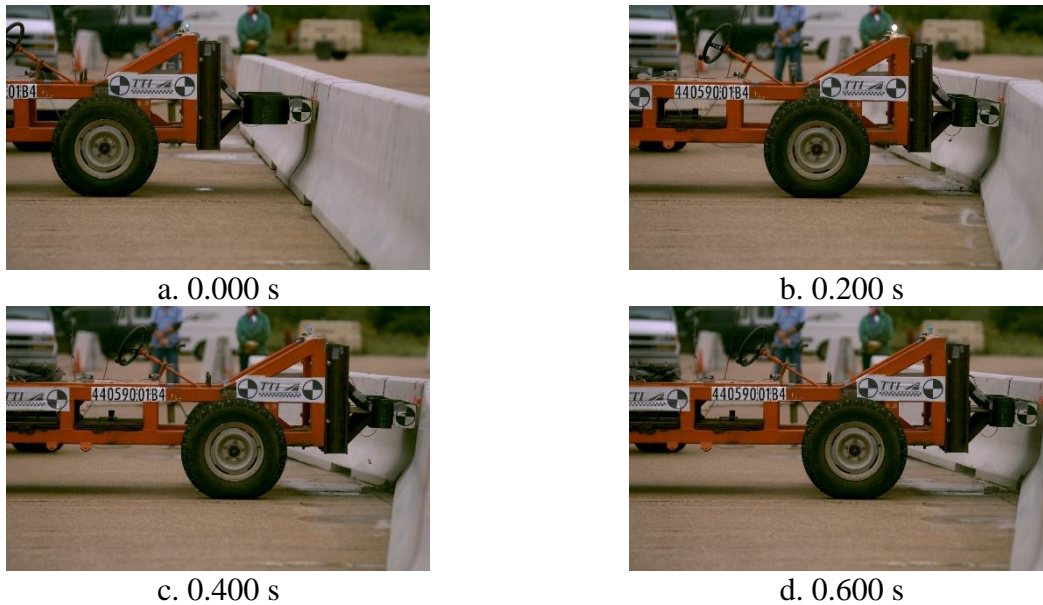


**Figure 5.36. F-Shape Barrier after Test No. 440591-01-B4.**

**Table 5.18. Occupant Risk Factors for Test No. 440591-01-B4.**

| Test Parameter                                | MASH   | Measured | Time                             |
|---|--------|----------|----------------------------------|
| OIV, Longitudinal (ft/s)                      | ≤40.0  | 20.0     | at 0.1313 s on front of interior |
| OIV, Lateral (ft/s)                           | ≤40.0  | 1.6      | at 0.1313 s on front of interior |
| Ridedown, Longitudinal (g)                    | ≤20.49 | 1.6      | 0.2648–0.2748 s                  |
| Ridedown, Lateral (g)                         | ≤20.49 | 0.6      | 0.2529–0.2629 s                  |
| Theoretical Head Impact Velocity (THIV) (m/s) | N/A    | 6.2      | at 0.1313 s on front of interior |
| Acceleration Severity Index (ASI)             | N/A    | 1.0      | 0.0328–0.0828 s                  |
| 50-ms MA Longitudinal (g)                     | N/A    | -11.4    | 0.0044–0.0544 s                  |
| 50-ms MA Lateral (g)                          | N/A    | -0.8     | 0.0068–0.0568 s                  |
| 50-ms MA Vertical (g)                         | N/A    | 0.7      | 0.0157–0.0657 s                  |

|              |           |            |          |
|--------------|-----------|------------|----------|
| Roll (deg.)  | $\leq 75$ | $11^\circ$ | 1.9963 s |
| Pitch (deg.) | $\leq 75$ | $1^\circ$  | 0.2503 s |
| Yaw (deg.)   | N/A       | $1^\circ$  | 1.9959 s |



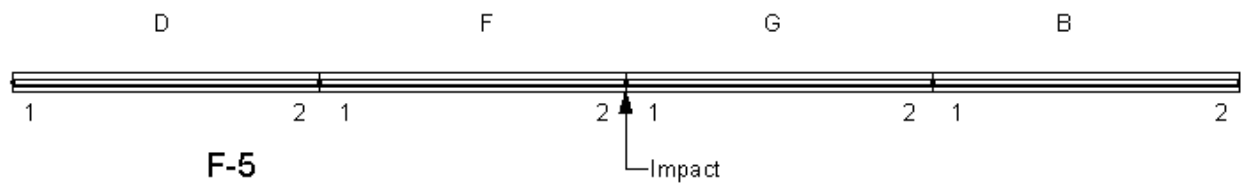
**Figure 5.37. Impact Frames for Test No. 440591-01-B4 on F-Shape Barrier.**

**5.4.2 Test No. 440591-01-B12 (F-5, between Barriers F and G)**

Figure 5.38 shows the installation prior to Test No. 440591-01-B12. Figure 5.39 shows the target impact point. Table 5.19 lists events that occurred during Test No. 440591-01-B12.



**Figure 5.38. F-Shape Barrier prior to Test No. 440591-01-B12.**



**Figure 5.39. Target Impact Point on F-5 for Test No. 440591-01-B12.**

**Table 5.19. Events during Test No. 440591-01-B12.**

| <b>Time (s)</b> | <b>Events</b>  |
|-----------------|--|
| 0.0000          | Vehicle impacts barrier while traveling 21.3 mi/h and at an impact angle of 89.3 degrees |
| 0.0090          | Barrier deflects toward field side   |
| 0.0410          | Tubes on bogie bumper are fully compressed   |
| 0.0510          | Barriers G and F begin to lift off pavement  |
| 0.1700          | Barriers G and F return to pavement  |
| 0.4870          | Barrier stops moving toward field side   |

#### **5.4.2.1 Test Results**

Figure 5.40 shows damage to the barrier. The black and blue lines indicate existing cracks, orange paint indicates existing spalling, and red lines indicate cracks post impact. The left end of barrier D moved 2½ inches back. The joint of barriers D and F moved 3¼ inches forward, and the joint of barriers F and G moved 42 inches back. The joint of barriers G and B moved 4 inches forward, and the right end of barrier B moved 3½ inches back. At the top of the joint between barriers D and F, there was a 3-inch gap in the front and a 1⅞-inch gap in the back. The bottom of the barriers had a 3-inch gap in the front and no gap in the back, and there was some spalling on the base of both barriers on the backside at the joint. At the top of the joint between barriers F and G, there was a 2¼-inch gap in the front and a 4-inch gap in the back. The bottom of the barriers had no gap in the front and a 5½-inch gap in the back. The JJ hooks at this joint were deformed, and there was also some spalling on the base of both barriers on the front of the joint. There were cracks on both the front and backside of barriers F and G. Barrier G had a ¼-inch crack on the front face of the barrier on the right end of the left scupper that narrowed to ⅛ inch at the top. Barrier F had an existing 1/16-inch crack on the front face of the barrier on the left end of the right scupper, which widened to ½ inch at the base and then narrowed to ¼ inch at the top. Barrier G had some more spalling at the left rear scupper, and barrier F had more spalling at the right rear scupper. At the top of the joint of barriers G and B, there was a 3-inch gap in the front and a 2-inch gap in the back. The bottom of the barrier had a 3-inch gap in the front and no gap in the back. There was some spalling at the base of both barriers on the backside at the joint. Maximum dynamic deflection during the test was 42.2 inches, and maximum permanent deformation was 42.0 inches.

Data from the accelerometers were digitized for evaluation of occupant risk, and the results are shown in Table 5.20. Figure 5.41 summarizes pertinent test impact frames.



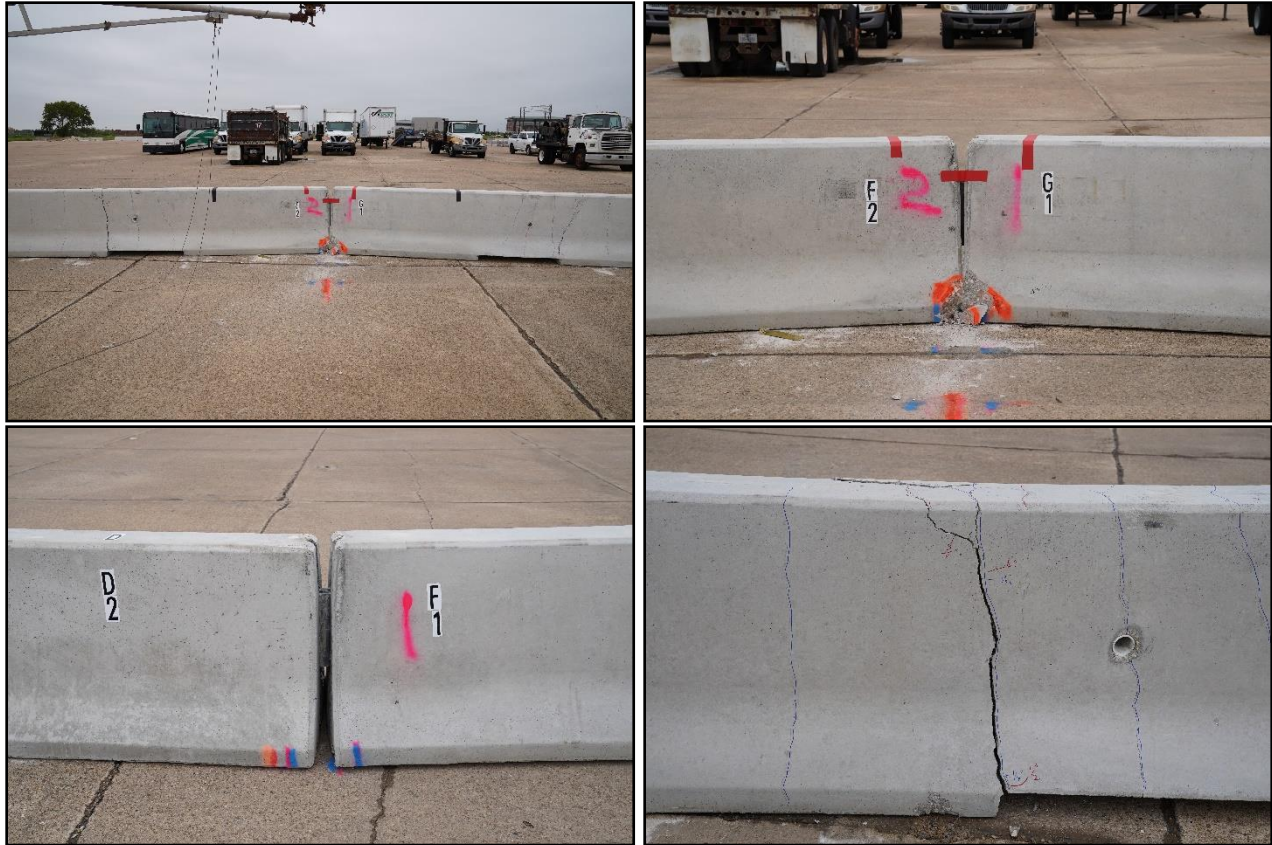
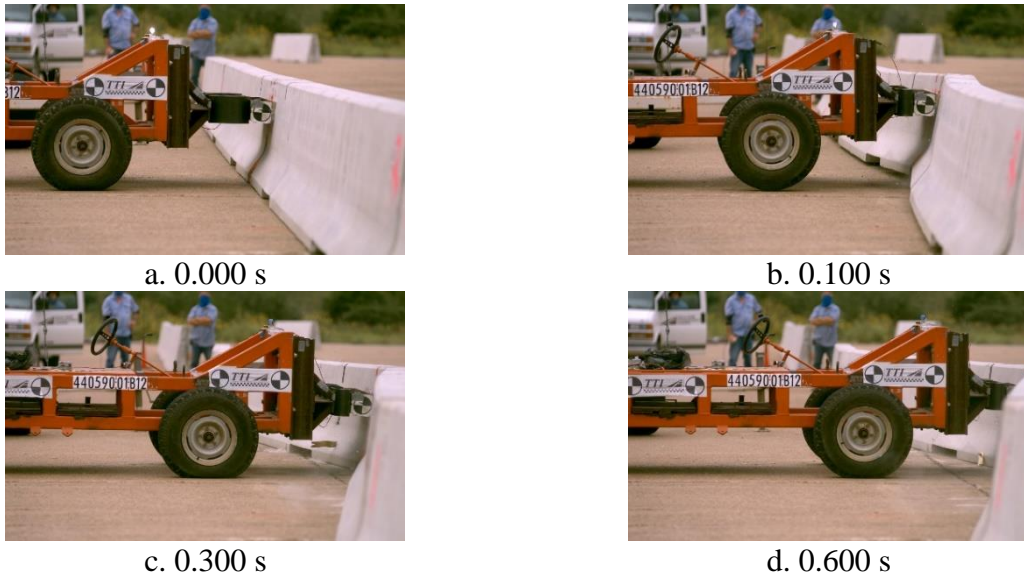


Figure 5.40. F-Shape Barrier after Test No. 440591-01-B12.

Table 5.20. Occupant Risk Factors for Test No. 440591-01-B12.

| Test Parameter                                | MASH   | Measured | Time                             |
|---|--------|----------|----------------------------------|
| OIV, Longitudinal (ft/s)                      | ≤40.0  | 22.0     | at 0.1243 s on front of interior |
| OIV, Lateral (ft/s)                           | ≤40.0  | 1.3      | at 0.1243 s on front of interior |
| Ridedown, Longitudinal (g)                    | ≤20.49 | 4.2      | 0.3533–0.3633 s                  |
| Ridedown, Lateral (g)                         | ≤20.49 | 0.4      | 0.3854–0.3954 s                  |
| Theoretical Head Impact Velocity (THIV) (m/s) | N/A    | 6.8      | at 0.1243 s on front of interior |
| Acceleration Severity Index (ASI)             | N/A    | 1.1      | 0.0301–0.0801 s                  |
| 50-ms MA Longitudinal (g)                     | N/A    | −12.1    | 0.0020–0.0520 s                  |
| 50-ms MA Lateral (g)                          | N/A    | −0.9     | 0.0032–0.0532 s                  |
| 50-ms MA Vertical (g)                         | N/A    | 0.8      | 0.0520–0.1020 s                  |
| Roll (deg.)                                   | ≤75    | 7°       | 1.9992 s                         |
| Pitch (deg.)                                  | ≤75    | 12°      | 2.0000 s                         |
| Yaw (deg.)                                    | N/A    | 3°       | 1.9647 s                         |



**Figure 5.41. Impact Frames for Test No. 440591-01-B12 on F-Shape Barrier.**

## 5.5 CONCLUSIONS

Destructive dynamic component testing was conducted on single-slope and F-shape PCB segment installations to assess the baseline strength/deflection capacities of new barrier segments as well as the corresponding residual capacities of damaged barrier segments. The impacting speed of the bogie vehicle was determined in such a way that a predetermined impact force was achieved to help ensure capacity for AASHTO *MASH* Test 3-11.

This dynamic component testing was helpful to understand and relate the quantitative and qualitative characteristics of post-impact damages seen in barriers (e.g., cracks, spalls, exposure of rebar, deformation of connections, etc.), along with the resulting values of barrier deflections.



## 6. DESTRUCTIVE DYNAMIC COMPONENT TESTING ON LOW-PROFILE BARRIER PROFILES

TTI researchers constructed test installations for low-profile PCBs and conducted bogie tests on these installations to assess the baseline strength/deflection capacities of new barrier segments as well as the corresponding residual capacities of damaged barrier segments. The impacting speed of the bogie vehicle was determined in such a way that a predetermined impact force was achieved to help ensure capacity for AASHTO *MASH* Test 2-11 (5000-lb pickup truck, 44 mi/h nominal impact speed, 25-degree nominal orientation impact angle).

This chapter describes the various destructive tests performed by crashing a bogie vehicle perpendicularly into the barrier and reports the quantitative and qualitative characteristics of post-impact damages seen in the barriers (e.g., cracks, spalls, exposure of rebar, deformation of connections, etc.), along with the resulting values of barrier deflections.

The surrogate test vehicle was modeled after a *MASH* 2270P pickup truck (47). This vehicle represents the 90<sup>th</sup> percentile in terms of vehicle weight for all passenger vehicles sold in 2002 and has a similar weight and center of gravity as large SUVs. The test inertia weight of the vehicle was 5020 lb, and the height to the upper edge of the pipe nose was 20 inches. The bogie vehicle was directed into the installation using the cable reverse tow and guidance system and was released to be free-wheeling and unrestrained just prior to impact.

### 6.1 FIVE LOW-PROFILE BARRIER INSTALLATION

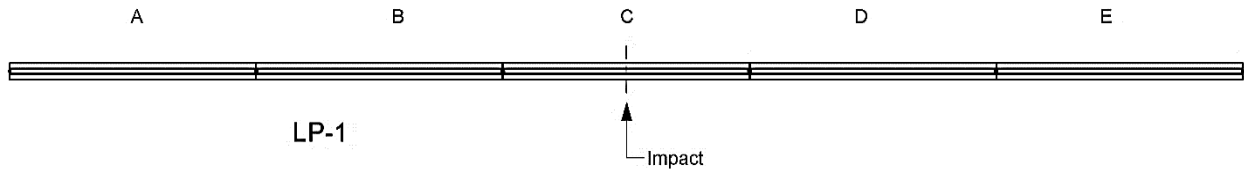
The installation consisted of five 20-ft long low-profile barriers joined together by two 1¼-inch diameter through-bolts that held the barriers flush to each other. The overall length of the installation was 100 ft. The barriers were 28 inches wide at the top, 26 inches wide at the bottom, and 20 inches tall.

#### 6.1.1 Test No. 440591-01-B5 (Low-Profile [LP]-1, Centerline of Barrier C)

Figure 6.1 shows the installation prior to Test No. 440591-01-B5, and Figure 6.2 shows the target impact point. Table 6.1 lists events that occurred during Test No. 440591-01-B5.



Figure 6.1. Low-Profile Barrier prior to Test No. 440591-01-B5.



**Figure 6.2. Target Impact Point on LP-1 for Test No. 440591-01-B5.**

**Table 6.1. Events during Test No. 440591-01-B5.**

| <b>Time (s)</b> | <b>Events</b>  |
|-----------------|--|
| 0.0000          | Vehicle impacts barrier while traveling 26.0 mi/h and at an impact angle of 90.0 degrees |
| 0.0180          | Cracks begin to form on field side of barrier C  |
| 0.0190          | Barrier deflects toward field side   |
| 0.0310          | Tubes on bogie bumper are fully compressed   |
| 0.7170          | Barrier stops moving toward field side   |

### 6.1.1.1 Test Results

Figure 6.3 shows damage to the installation. The black lines indicate existing cracks, and the red lines indicate cracks post impact. The left end of barrier A moved 13 inches forward, and the joint of barriers A and B moved 2 inches to the right and 2½ inches back. The joint of barriers B and C moved 25 inches back and 1 inch to the right. The joint of barriers C and D moved 27½ inches back, and the joint of barriers D and E moved 7 inches back. The right end of barrier E moved 12 inches forward. Maximum dynamic deflection during the test was 36.7 inches, and maximum permanent deformation was 35.0 inches.

Data from the accelerometers were digitized for evaluation of occupant risk, and the results are shown in Table 6.2. Figure 6.4 summarizes pertinent test impact frames.

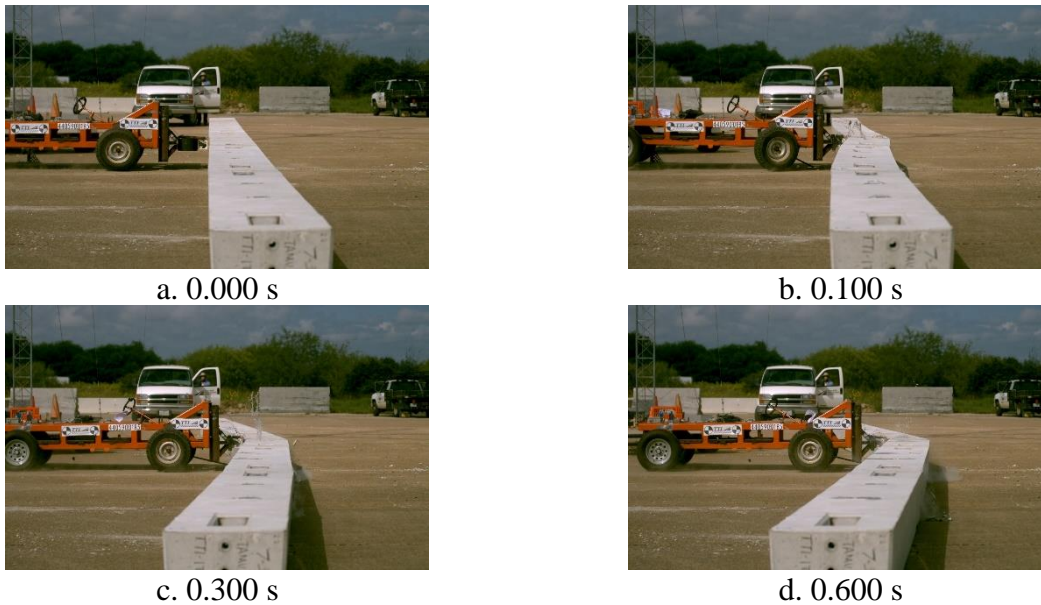




**Figure 6.3. Low-Profile Barrier after Test No. 440591-01-B5.**

**Table 6.2. Occupant Risk Factors for Test No. 440591-01-B5.**

| <b>Test Parameter</b>                         | <b>MASH</b> | <b>Measured</b> | <b>Time</b>                      |
|---|-------------|-----------------|----------------------------------|
| OIV, Longitudinal (ft/s)                      | ≤40.0       | 27.9            | at 0.0986 s on front of interior |
| OIV, Lateral (ft/s)                           | ≤40.0       | 1.3             | at 0.0986 s on front of interior |
| Ridedown, Longitudinal (g)                    | ≤20.49      | 6.0             | 0.1122–0.1222 s                  |
| Ridedown, Lateral (g)                         | ≤20.49      | 0.8             | 0.1127–0.1227 s                  |
| Theoretical Head Impact Velocity (THIV) (m/s) | N/A         | 8.5             | at 0.0986 s on front of interior |
| Acceleration Severity Index (ASI)             | N/A         | 1.8             | 0.0302–0.0802 s                  |
| 50-ms MA Longitudinal (g)                     | N/A         | -17.6           | 0.0000–0.0500 s                  |
| 50-ms MA Lateral (g)                          | N/A         | -0.9            | 0.0161–0.0661 s                  |
| 50-ms MA Vertical (g)                         | N/A         | 3.2             | 0.0472–0.0972 s                  |
| Roll (deg.)                                   | ≤75         | 2°              | 0.4974 s                         |
| Pitch (deg.)                                  | ≤75         | 11°             | 2.0000 s                         |
| Yaw (deg.)                                    | N/A         | 1°              | 1.2161 s                         |



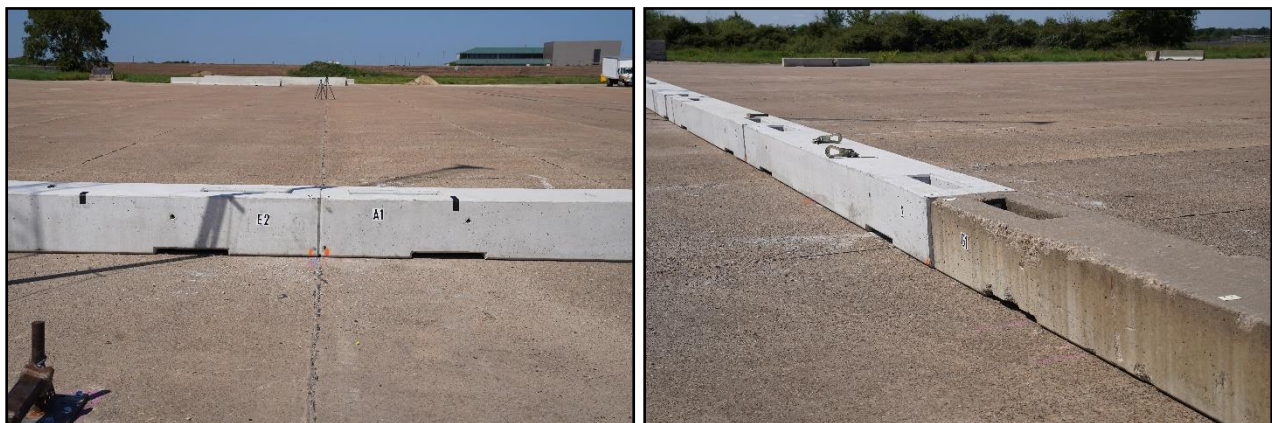
**Figure 6.4. Impact Frames for Test No. 440591-01-B5 on Low-Profile Barrier.**

## 6.2 SIX LOW-PROFILE BARRIER INSTALLATION

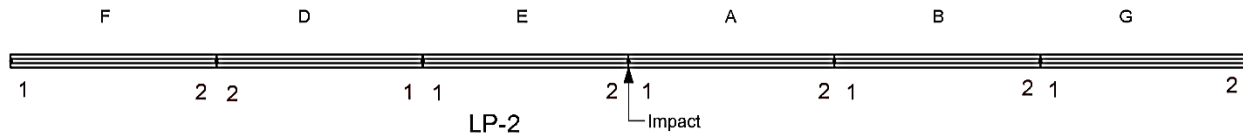
The installation consisted of six 20-ft long low-profile barriers joined together by two 1¼-inch diameter through-bolts that held the barriers flush to each other. The overall length of the installation was 120 ft. The barriers were 28 inches wide at the top, 26 inches wide at the bottom, and 20 inches tall.

### 6.2.1 Test No. 440591-01-B6 (LP-2, Centerline of Joint E–A)

Figure 6.5 shows the installation prior to Test No. 440591-01-B6, and Figure 6.6 shows the target impact point. Table 6.3 lists events that occurred during Test No. 440591-01-B6.



**Figure 6.5. Low-Profile Barrier prior to Test No. 440591-01-B6.**



**Figure 6.6. Target Impact Point on LP-2 for Test No. 440591-01-B6.**

**Table 6.3. Events during Test No. 440591-01-B6.**

| Time (s) | Events   |
|----------|--|
| 0.0000   | Vehicle impacts barrier while traveling 18.7 mi/h and at an impact angle of 89.4 degrees |
| 0.0190   | Barrier begins to move toward field side   |
| 0.0490   | Tubes on bogie bumper are fully compressed   |
| 0.0530   | Cracks begin to form in barrier E  |
| 0.4610   | Barrier stops moving toward field side   |

### 6.2.1.1 Test Results

Figure 6.7 shows damage to the installation. The black and red lines indicate existing cracks, and the green lines indicate cracks post impact. The left end of barrier F moved 7 inches forward, and the joint of barriers F and D moved 1½ inches back. The joint of barriers D and E moved 8½ inches back, and the joint of barriers E and A moved 14 inches back. The joint of barriers A and B moved 9 inches back, and the joint of barriers B and G moved 2½ inches back. The right end of barrier G moved 4 inches forward. The protected left top corner of barrier E spalled off and exposed rebar. Maximum dynamic deflection during the test was 15.4 inches, and maximum permanent deformation was 14.0 inches.

Data from the accelerometers were digitized for evaluation of occupant risk, and the results are shown in Table 6.4. Figure 6.8 summarizes pertinent test impact frames.

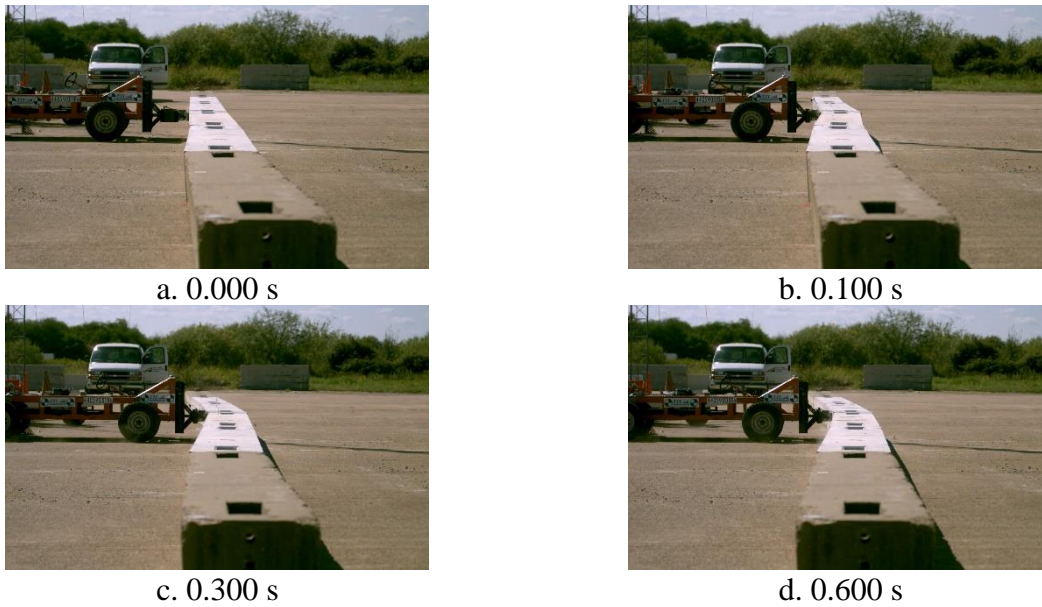




**Figure 6.7. Low-Profile Barrier after Test No. 440591-01-B6.**

**Table 6.4. Occupant Risk Factors for Test No. 440591-01-B6.**

| Test Parameter                                | MASH   | Measured | Time                             |
|---|--------|----------|----------------------------------|
| OIV, Longitudinal (ft/s)                      | ≤40.0  | 21.3     | at 0.1290 s on front of interior |
| OIV, Lateral (ft/s)                           | ≤40.0  | 0.7      | at 0.1290 s on front of interior |
| Ridedown, Longitudinal (g)                    | ≤20.49 | 2.9      | 0.1709–0.1809 s                  |
| Ridedown, Lateral (g)                         | ≤20.49 | 0.4      | 0.1613–0.1713 s                  |
| Theoretical Head Impact Velocity (THIV) (m/s) | N/A    | 6.5      | at 0.1290 s on front of interior |
| Acceleration Severity Index (ASI)             | N/A    | 1.1      | 0.0406–0.0906 s                  |
| 50-ms MA Longitudinal (g)                     | N/A    | −12.1    | 0.0085–0.0585 s                  |
| 50-ms MA Lateral (g)                          | N/A    | −0.6     | 0.0054–0.0554 s                  |
| 50-ms MA Vertical (g)                         | N/A    | 0.8      | 0.0089–0.0589 s                  |
| Roll (deg.)                                   | ≤75    | 1°       | 1.9685 s                         |
| Pitch (deg.)                                  | ≤75    | 12°      | 2.0000 s                         |
| Yaw (deg.)                                    | N/A    | 4°       | 2.0000 s                         |



**Figure 6.8. Impact Frames for Test No. 440591-01-B6 on Low-Profile Barrier.**

### 6.3 CONCLUSIONS

Destructive dynamic component testing was conducted on low-profile PCB segment installations to assess the baseline strength/deflection capacities of new barrier segments as well as the corresponding residual capacities of damaged barrier segments. The impacting speed of the bogie vehicle was determined in such a way that a predetermined impact force was achieved to help ensure capacity for AASHTO *MASH* Test 2-11.

This dynamic component testing was helpful to understand and relate the quantitative and qualitative characteristics of post-impact damages seen in barriers (e.g., cracks, spalls, exposure of rebar, deformation of connections, etc.), along with the resulting values of barrier deflections.





## 7. FINITE ELEMENT COMPUTER SIMULATIONS

### 7.1 INTRODUCTION

This chapter documents the finite element analysis (FEA) performed to predict the crash behavior of pre-damaged TxDOT crash barriers (single-slope and F-shape) under *MASH* testing conditions. Finite element models of the single-slope barrier and F-shape barrier along with the connection details were developed in LS-DYNA (48). Each of the models was first calibrated against the bogie tests conducted as part of Task 4, and then predictive simulations were performed with the *MASH* vehicle models, a 0.5-ton four-door quad RAM pickup truck and a Toyota Yaris passenger car.

The scope of the FEA was restricted to evaluate the preexisting damage in barriers in the form of spalls and deformed JJ hooks. Cracks were evaluated in the FEA. In the past, since the recommendations on cracks have been made with the overriding concern of durability, crack evaluation was not included in the finite element investigation. Researchers suggest referring to the final guidelines for the quantification of crack acceptability.

A model was developed to replicate the bogie test results in terms of the connection behavior, relative rotation of segments, and lateral displacement of the barrier system at the impacted joint. The simulations with the bogie were assessed, and the resulting D3 plots were compared with the frames of the actual crash test. Lateral displacement of the barrier system as well as the general behavior of the impacted barriers during the crash were considered the basis of validation.

Angular velocities and linear acceleration values from the predictive simulation (with an undamaged barrier system and barrier system with a specific failure mode) were extracted and processed further in the Test Risk Assessment Program (TRAP) software. Results from TRAP gave the yaw, pitch, and roll angles; OIV; and ridedown accelerations (RAs) for the RAM pickup truck and Yaris passenger car. The TRAP values were compared with the corresponding limits prescribed for Test 3-11 in *MASH*.

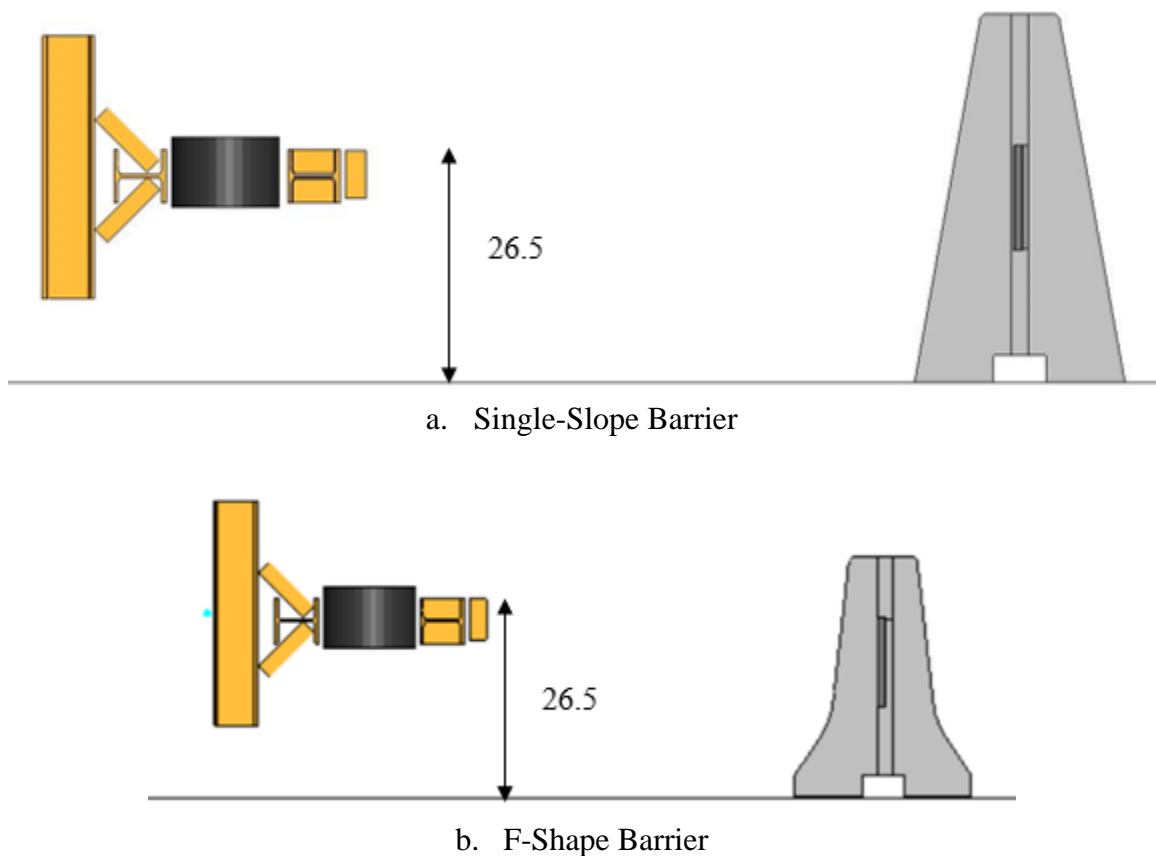
### 7.2 COMPUTER MODEL

Finite element models were developed for the single-slope barrier and F-shape barrier using the geometric details from the provided TxDOT drawings. The barriers were modeled using solid elements and 159\_CSCM\_Concrete Model. The reinforcement was explicitly modeled using beam elements and the material model, 024\_Piecewise\_Linear\_Plasticity. The connection details consisted of JJ hooks, angle plates, and additional rebars. JJ hooks and angle plates were modeled using shell elements and constrained in the solid concrete barrier using “lagrange in solid.” The reinforcement cage consisting of longitudinal rebars and stirrups was also constrained in the barrier using “lagrange in solid.” Automatic single-surface contact (with SOFT=2) between the curved portion of JJ hooks (protruding from the barrier) and the solid concrete barrier ensured that there was no penetration between them during and after the impact. An hourglass property was assigned to the concrete to eliminate hourglass modes. The contacts between the barrier and ground, barrier and vehicle, and vehicle and ground used properties previously validated in completed projects.

A model of the bogie nose was developed at TTI and was used to impact the 120-ft long barrier assembly. The RAM pickup truck was represented by a beta model developed by the Center for Collision Safety and Analysis at George Mason University. The Toyota Yaris passenger car was represented by a finite element model developed at the same institute (49). This model conforms to *MASH* requirements outlined for an 1100C test vehicle.

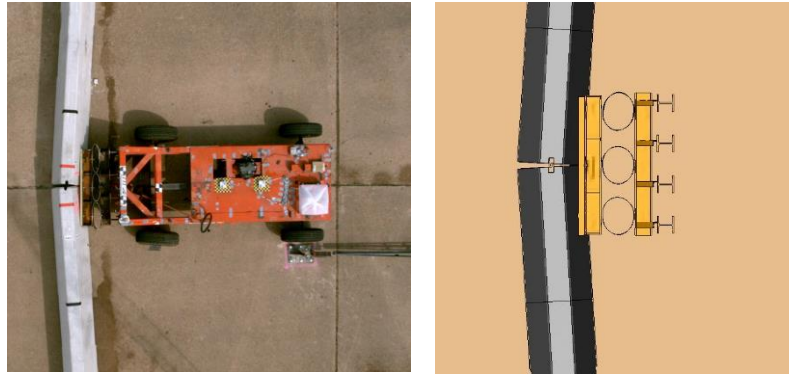
### 7.3 MODEL CALIBRATION

A bogie model weighing 5000 lb was made to impact perpendicularly at the center of a four-segment barrier assembly with a nominal speed of 18 mi/h. Height of the top edge of the frontal piece attached to the bogie nose frame was kept 26.5 inches above the ground, in conformance with the bogie vehicle used in the actual component crash test. Figure 7.1 shows the initial setup of the bogie and barrier assembly.

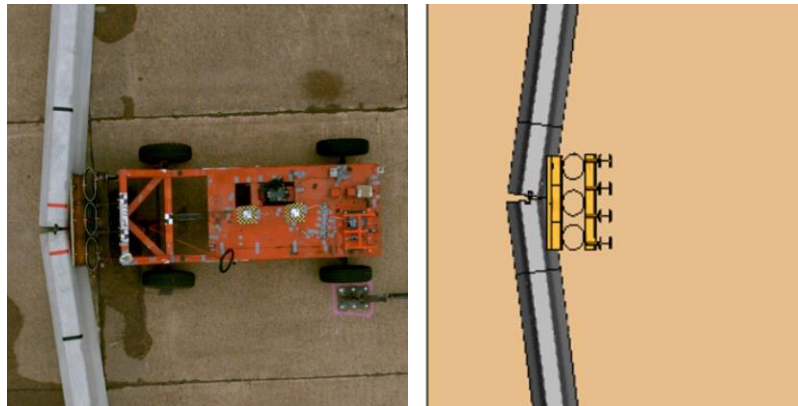


**Figure 7.1. Bogie Positioned to Impact Perpendicularly at the Center of the Four-Segment Barrier Assembly, Nominal Speed = 18 mi/h.**

The obtained D3 plots were compared with the frames of the crash videos from the actual component crash test, and a significant correlation was observed. Figure 7.2 shows the comparison of the actual crash test (left) and the simulation (right), illustrating the similar barrier segment behavior after the impact for both single-slope and F-shape barrier systems.



a. Single-Slope Barrier



b. F-Shape Barrier

**Figure 7.2. Comparison of Actual Bogie Test (Left) and Bogie-Barrier Impact Simulation (Right) in LS-DYNA for Both (a) Single-Slope and (b) F-Shape Barrier Systems.**

The comparison of frames from the actual test and the simulation showed that the model closely replicated the actual behavior of the barriers in terms of the following results:

- Lateral displacement at the impacted joint in both the F-shape and single-slope barrier simulations compared well with the actual test displacement. The displacement value in the single-slope simulation was 14 inches, which deviated by 8 percent from the actual displacement value of 15.25 inches. As for the F-shape simulation, displacement in the simulation was 31.3 inches, which matched the actual displacement value of 31.3 inches.
- General behavior of barrier toes compared well with the actual test behavior.
- Opening in the back of the impacted joint compared favorably with the actual test system opening between the two impacted segments.

Thus, the model was considered calibrated with the component crash test, and this model was further used in the predictive simulations with the RAM pickup truck and Toyota Yaris passenger car.

#### 7.4 PREDICTIVE SIMULATIONS

A 210-ft long barrier assembly was modeled in LS-DYNA with inclusion of seven 30-ft long barrier segments. Also, specific failure modes were purposely included in the developed finite

element model, such as preexisting concrete spalling and deformed JJ hook connections. These failure modes were included through acceptable numerical techniques, such as deletion of model elements and geometry modifications.

First, the pre-damaged barrier system was impacted by the RAM pickup truck model and Toyota Yaris passenger car model. Each vehicle model was positioned at an angle of 25 degrees and given an initial impact velocity of 62 mi/h. The simulations were mainly focused on finding the OIV and RA, as well as assessing the crashworthiness of the barrier system and the post-impact vehicle trajectory quantified in terms of roll, pitch, and yaw angles. The initial impact locations were determined through parametric analyses, where the vehicles were impacting the barrier's segments at different locations to identify the critical ones. These simulations are predictive in nature.

The predictive simulations were carried out after achieving a realistic behavior of the barrier segments, the JJ hook connectors, and the vehicle during and after the impact. The process of achieving realistic behavior was not simple; the researchers faced numerous challenges in validating the behavior of the barrier-vehicle system. In the initial stages, the barriers were kept partially rigid (in the middle) and partially flexible (on the ends), but when this barrier model was impacted by the pickup truck/bogie at a speed of 18 mi/h or beyond, it was found that the connection between the impacted barriers opened, which was not expected to happen in real life. This was a numerical issue since when the material of the barriers was changed to concrete (flexible) from the usual partially rigid and partially concrete (flexible) material, the connection, though deformed, did not open out and was found to be consistent with the actual behavior. There was an excessive deformation of the concrete at the ends during the impact. Multiple attempts were made to eliminate the distortion, such as refining the mesh size from 1 inch by 1 inch to 0.6 inches by 0.6 inches, changing the model of the connection, using an hourglass card, and so on. It was seen that using the hourglass card alone made a considerable difference and eliminated the hourglass modes. The mesh size was changed back to the original 1 inch by 1 inch with an hourglass property that ensured there was no excessive distortion at the barrier ends. Selection of the erosion value was a rigorous process, and a couple of simulations were run with different erosion values, such as 1, 1.05, 1.1, 1.15, and 1.2. The erosion value of 1.1 worked well for the simulations and showed realistic damage to the barriers. Different combinations of contacts were tried for the overall system. An inappropriate contact/contact property yielded odd behavior, such as torsion in the reinforcement even before the vehicle impacted the barrier, interpenetration between JJ hooks or the JJ hook and barrier during impact, barrier toes not touching each other when they should have been touching, and so on. Thus, multiple simulations were run with changes to contact parameters to get the most precise behavior of the JJ hook connection and barrier segments. The following sections present the results of the simulations.

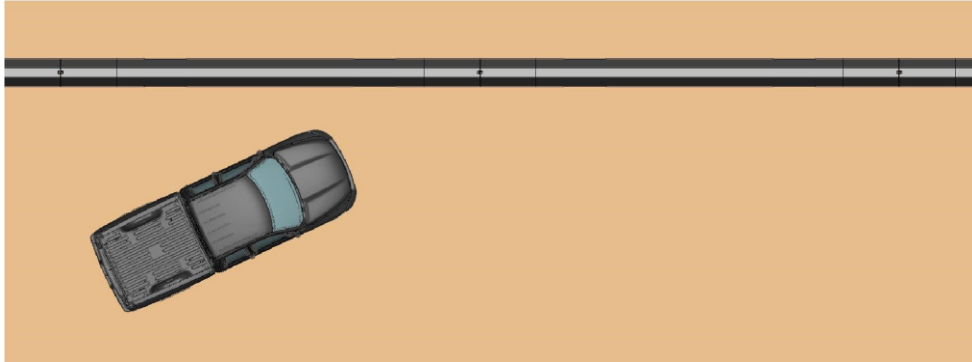
## **7.5 PREDICTIVE SIMULATIONS FOR THE SINGLE-SLOPE BARRIER**

### **7.5.1 Predictive Baseline Simulations**

The purpose of this simulation was to ascertain the baseline values of OIV; RA; yaw, pitch, and roll values; and lateral displacement of the undamaged barrier. Results from all subsequent simulations with preexisting damages in the barrier assembly were compared with the values obtained from the baseline simulation.

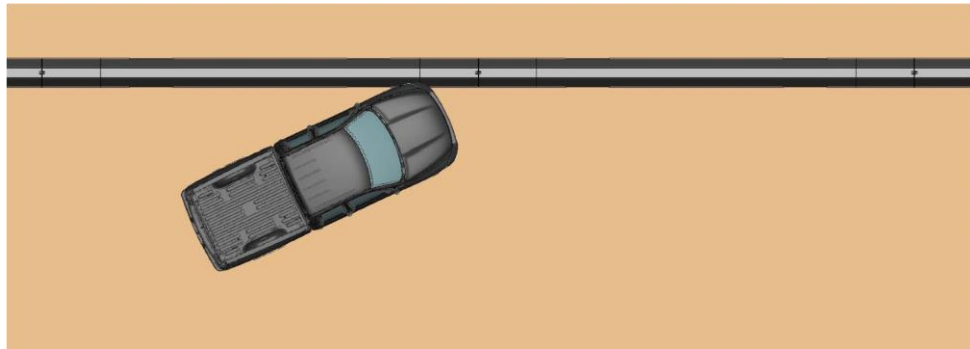
### 7.5.1.1 Single-Slope Barrier with RAM Model Representing a 5000-lb (2270P) MASH Pickup Truck Test Vehicle

A baseline simulation was carried out with the RAM pickup truck model weighing 5000 lb, positioned at 4.3 ft upstream of the joint at an angle of 25 degrees with respect to the undamaged barrier system and with an impact speed of 62 mi/h. Figure 7.3 shows the initial position of the pickup truck with respect to the barrier.

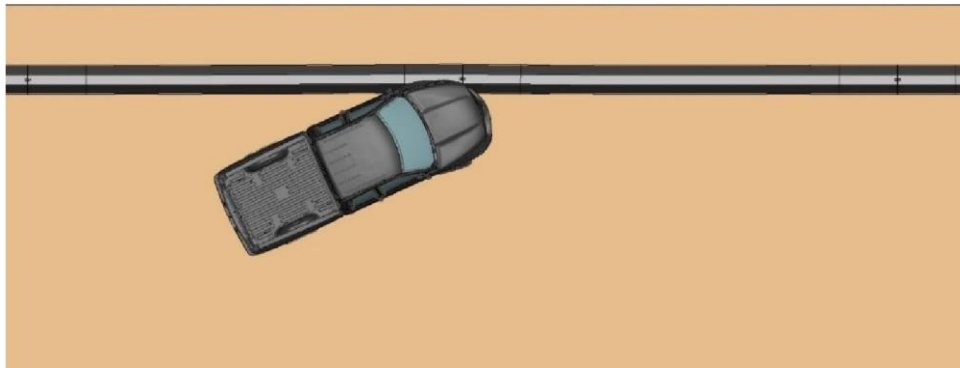


**Figure 7.3. Initial Position of RAM Pickup Truck.**

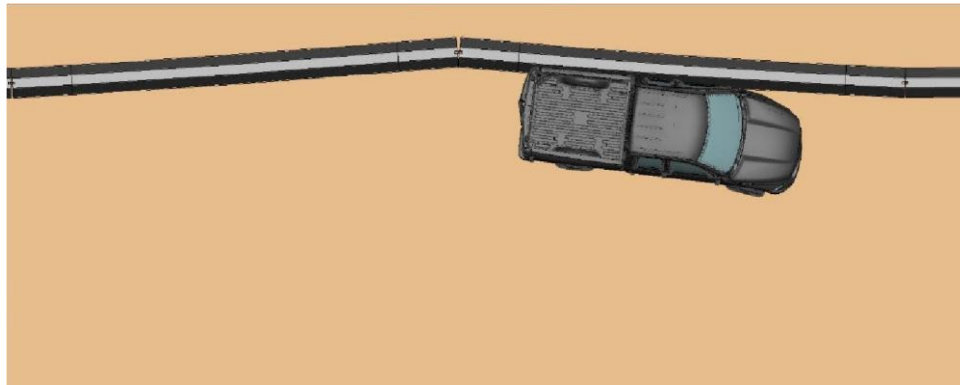
Figure 7.4 illustrates the interaction between the barrier and the vehicle at various times.



a.  $t = 0.090$  s, event = pickup truck strikes the barrier



b.  $t = 0.13$  s, event = pickup truck contacts the joint



c.  $t = 0.40$  s, event = pickup truck redirected by the barrier

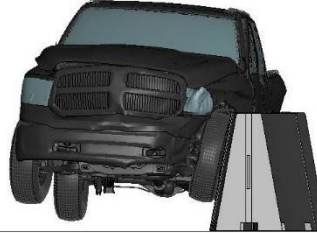
**Figure 7.4. Truck–Single-Slope Barrier Interaction through Various Stages.**



Figure 7.5 illustrates the behavior of the RAM pickup truck at various times.



a.  $t = 0.10$  s, event = front right tire contacts the barrier



b.  $t = 0.31$  s, event = rear right tire contacts the barrier



c.  $t = 0.54$  s, event = front right tire touches ground

**Figure 7.5. Post-Impact Trajectory of the RAM Pickup Truck.**

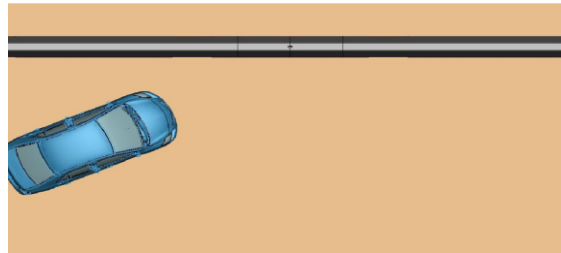
Lateral displacement of the impacted barrier was obtained as 28 inches. TRAP analysis was performed to calculate OIV, RA, and yaw, pitch, and roll. Table 7.1 summarizes the results from TRAP.

**Table 7.1. TRAP Values for RAM Pickup Truck Impacting an Undamaged Single-Slope Barrier.**

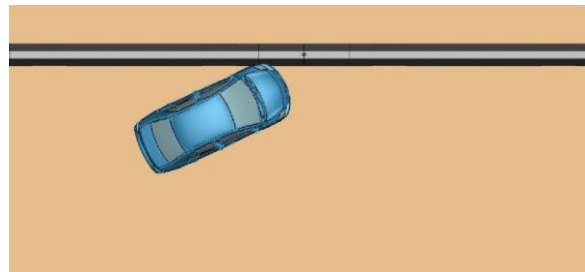
| Parameter    | Absolute Value |
|--------------|----------------|
| OIV (ft/s)   | 23.6           |
| RA           | 14.4           |
| Yaw (deg.)   | 31.6           |
| Pitch (deg.) | 7.5            |
| Roll (deg.)  | 16.5           |

### 7.5.1.2 Single-Slope Barrier with Toyota Yaris Model Representing a 2420-lb (1100C) *MASH* Small Car Test Vehicle

A baseline simulation was carried out with the Toyota Yaris passenger car model weighing 2420 lb, positioned 3.6 ft upstream of the joint at an angle of 25 degrees with the undamaged barrier system to impact at a speed of 62 mi/h. Figure 7.6 shows the initial position of the car with respect to the barrier. Figure 7.7 illustrates the interaction between the barrier and the car at various times.



**Figure 7.6. Initial Position of Toyota Yaris Passenger Car.**



a.  $t = 0.090$  s, event = car strikes the barrier



b.  $t = 0.13$  s, event = car contacts the joint



c.  $t = 0.33$  s, event = car redirected by the barrier

**Figure 7.7. Car–Single-Slope Barrier Interaction through Various Stages.**

Figure 7.8 illustrates the post-impact trajectory of the car.



a.  $t = 0.10$  s, event = front right tire contacts the barrier



b.  $t = 0.23$  s, event = rear right tire contacts the barrier, window pane snags against the barrier



c.  $t = 0.45$  s, event = front right tire touches ground



d.  $t = 0.62$  s, event = rear right tire touches ground



e.  $t = 0.91$  s, event = rear right tire stabilizes on ground

**Figure 7.8. Post-Impact Trajectory of the Toyota Yaris Passenger Car.**

Lateral displacement of the impacted barrier was 11 inches. TRAP analysis was performed to calculate OIV, RA, and yaw, pitch, and roll. Table 7.2 summarizes the results from TRAP.

**Table 7.2. TRAP Values for Toyota Yaris Passenger Car Impacting an Undamaged Single-Slope Barrier.**

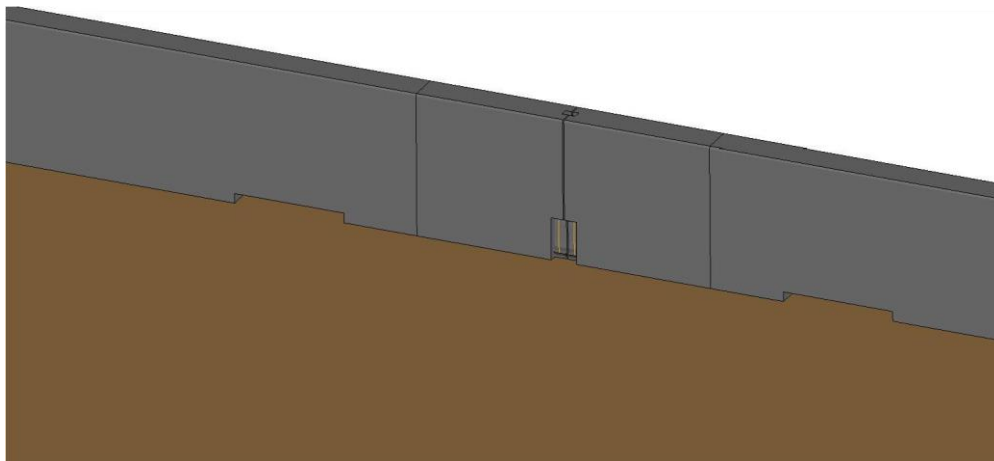
| <b>Parameter</b> | <b>Absolute Value</b> |
|------------------|-----------------------|
| OIV (ft/s)       | 24.6                  |
| RA               | 17.2                  |
| Yaw (deg.)       | 37.2                  |
| Pitch (deg.)     | 8.2                   |
| Roll (deg.)      | 27.7                  |

### **7.5.2 Predictive Simulations with Pre-damaged Single-Slope Barrier**

The purpose of these simulations was to ascertain the values of OIV; RA; yaw, pitch, and roll values; and lateral displacement of the damaged barrier. Preexisting damage was introduced into the barrier system by deleting elements to make a spall of certain size.

#### **7.5.2.1 Pre-damaged Single-Slope Barrier (13-inch × 4-inch × 2-inch spall on adjacent toes) with RAM Model Representing a 5000-lb (2270P) MASH Pickup Truck Test Vehicle**

Preexisting damage in the form of a 13-inch (length) by 4-inch (width) by 2-inch (depth) spall was created on adjacent toes of the barriers. Figure 7.9 illustrates the damage created in the barrier.



**Figure 7.9. Pre-damaged Barrier with Adjacent Toes Having Spall of Length = 13 inches, Width = 4 inches, Depth = 2 inches.**

Lateral displacement of the impacted barrier was 29 inches. TRAP analysis was performed to calculate OIV, RA, and yaw, pitch, and roll. Table 7.3 summarizes the results from TRAP.

**Table 7.3. TRAP Values for RAM Pickup Truck Impacting a Single-Slope Barrier with Two Spalled Toes.**

| <b>Parameter</b> | <b>Absolute Value</b> |
|------------------|-----------------------|
| OIV (ft/s)       | 23.4                  |
| RA               | 14.2                  |
| Yaw (deg.)       | 32.0                  |
| Pitch (deg.)     | 6.1                   |
| Roll (deg.)      | 16.6                  |

**7.5.2.2 Pre-damaged Single-Slope Barrier (13-inch × 4-inch × 2-inch spall on toe) with Toyota Yaris Model Representing a 2420-lb (1100C) MASH Small Car Test Vehicle**

Lateral displacement of the impacted barrier was 11 inches. TRAP analysis was performed to calculate OIV, RA, and yaw, pitch, and roll. Table 7.4 summarizes the results from TRAP.

**Table 7.4. TRAP Values for Toyota Yaris Passenger Car Impacting a Single-Slope Barrier with Two Spalled Toes.**

| <b>Parameter</b> | <b>Absolute Value</b> |
|------------------|-----------------------|
| OIV (ft/s)       | 25.2                  |
| RA               | 16.9                  |
| Yaw (deg.)       | 32.9                  |
| Pitch (deg.)     | 8.2                   |
| Roll (deg.)      | 30.8                  |

**7.5.3 Conclusion**

The researchers evaluated the crashworthiness of the full-scale single-slope barrier assembly through FEA simulations under *MASH* TL-3 impact conditions. Baseline simulations were carried out with the RAM pickup truck and Toyota Yaris passenger car. The results of the baseline simulation with the pickup truck were compared with the results from the subsequent simulations of (a) damaged single-slope barrier assembly with one spalled toe impacted by the pickup truck, and (b) damaged single-slope barrier assembly with two adjacent spalled toes impacted by the pickup truck. The size of the spall was selected as 13 inches (height) by 4 inches (width) by 2 inches (depth) for two reasons:

1. Based on the review of the guidelines provided by other DOTs, a portable concrete crash barrier is usually considered unacceptable if it has a spall of a size equal to or greater than 12 inches in any surface dimension and a depth greater than the cover.
2. Nearby spall sizes were witnessed in the barriers damaged during crash testing.

Therefore, the researchers decided to evaluate this particular spall size through FEA simulations.

Since the spall on the ends could make a barrier rotate more in the case of a vehicle impact with the threat of a tire getting snagged, the spall was strategically created on the toe(s). Despite the damaged toe, it was found that the single-slope barrier maintained its crashworthiness without

any considerable difference in vehicle occupant risk (OIV, RA) or stability values (yaw, pitch, roll).

Table 7.5 summarizes the FEA simulations of the single-slope barrier and pickup truck, including the maximum and minimum absolute values of OIV, RA, and yaw, pitch, and roll, as well as the percent variation.

**Table 7.5. Comparison of TRAP Results for Simulations Involving Pickup Truck Impacting the Single-Slope Barrier.**

| Parameter    | Maximum Absolute Value | Minimum Absolute Value | % Variation = $100 * (\text{Max.} - \text{Min.}) / \text{Min.}$ |
|--------------|------------------------|------------------------|---|
| OIV (ft/s)   | 23.6                   | 23.4                   | 0.9   |
| RA (g)       | 14.7                   | 14.2                   | 3.5   |
| Yaw (deg.)   | 32.0                   | 31.6                   | 1.3   |
| Pitch (deg.) | 7.5                    | 6.1                    | 0.2   |
| Roll (deg.)  | 16.6                   | 13.0                   | 0.3   |
| Deflection   | 29.0                   | 28.0                   | 0.04  |

Table 7.5 shows that the OIV of 23.6 ft/s is less than the corresponding preferred value of 30 ft/s, and the RA of 14.7 g is less than the corresponding preferred value of 15 g. Pitch and roll values are much less than the *MASH* limit of 75 degrees.

Similar comparisons were done for the corresponding FEA simulations with the passenger car, and Table 7.6 summarizes those results.

**Table 7.6. Comparison of TRAP Results for Simulations Involving Passenger Car Impacting the Single-Slope Barrier.**

| Parameter    | Maximum Absolute Value | Minimum Absolute Value | % Variation = $100 * (\text{Max.} - \text{Min.}) / \text{Min.}$ |
|--------------|------------------------|------------------------|---|
| OIV (ft/s)   | 25.2                   | 24.6                   | 0.02  |
| RA (g)       | 17.2                   | 16.3                   | 0.06  |
| Yaw (deg.)   | 40.4                   | 32.9                   | 0.2   |
| Pitch (deg.) | 8.2                    | 8.2                    | 0.0   |
| Roll (deg.)  | 30.8                   | 27.7                   | 0.1   |
| Deflection   | 11.1                   | 11.0                   | 0.01  |

Table 7.6 shows that the OIV of 25.2 ft/s is less than the corresponding preferred value of 30 ft/s, and the RA of 17.2 g is less than the corresponding maximum value of 20.49 g. The maximum roll of the car is 30.8 degrees, which is less than the limit of 75 degrees but is still considerable. Although the behavior of a portable single-slope barrier with JJ hooks has not been investigated with full-scale crash testing in the past, the level of instability that the simulations appear to show in terms of roll is questionable.



The next section on predictive simulations with the F-shape barrier shows that the car is much more stable after impacting a damaged F-shape barrier, which is much less heavy than the single-slope barrier. Since experience has shown that the single-slope barrier is crashworthy, this discrepancy in instability should not exist, especially considering that the single-slope barrier has deflected almost 50 percent less than the F-shape barrier.

The researchers believe this questionable level of instability recorded for the car after impacting a single-slope barrier is dictated by a potential modeling characteristic of the available passenger car. It is not rare within FEA simulations to notice unrealistic characteristics of a vehicle that are generally related to tire, rim, suspension, joint, and related failure mode modeling characteristics.

Although potentially major modifications may need to be investigated to realistically depict impact behavior against the single-slope barrier, testing such changes could be very time intensive and was outside the scope of this project.

It is not uncommon to complement predictive simulation results with researcher experience in testing similar barrier shapes to best identify the disparities between real crash testing and predictive simulations (with new barrier systems).

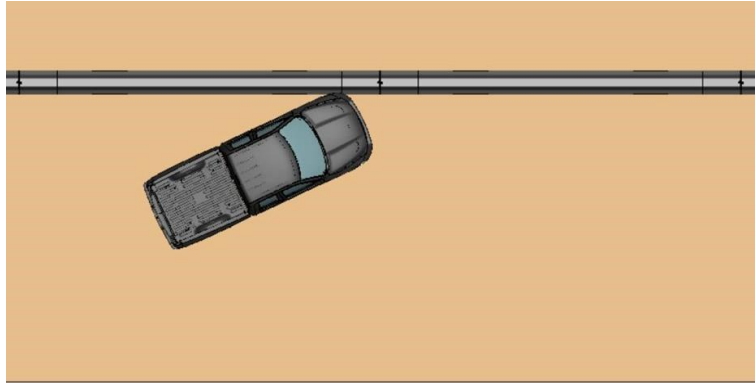
## **7.6 PREDICTIVE SIMULATIONS FOR THE F-SHAPE BARRIER**

### **7.6.1 Predictive Baseline Simulations**

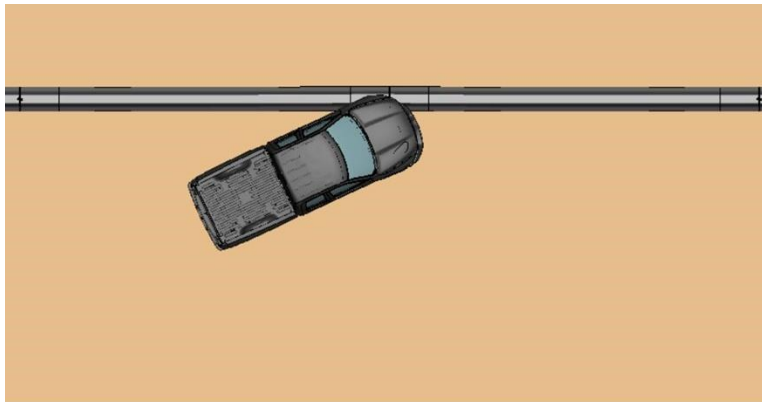
The purpose of this simulation was to ascertain the baseline values of OIV; RA; yaw, pitch, and roll values; and lateral displacement of the undamaged barrier. Results from all the subsequent simulations with preexisting damages in the barrier assembly were compared with the values obtained from the baseline simulation.

#### **7.6.1.1 F-Shape Barrier with RAM Model Representing a 5000-lb (2270P) MASH Pickup Truck Test Vehicle**

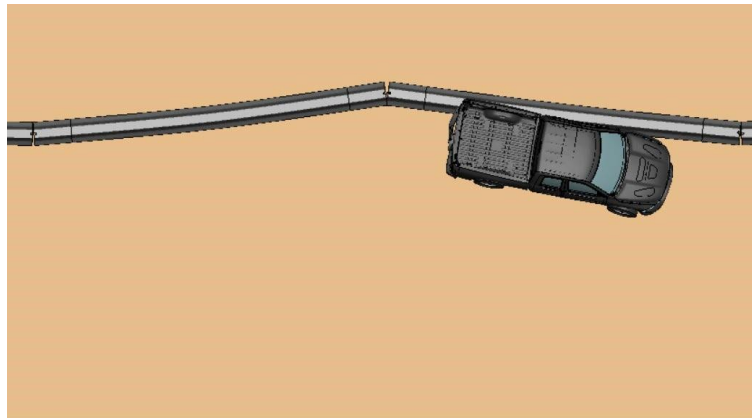
A baseline simulation was carried out with the RAM pickup truck model weighing 5000 lb, positioned 4.3 ft upstream of the joint at an angle of 25 degrees with the undamaged barrier system to impact at a speed of 62 mi/h. Figure 7.10 illustrates the interaction between the barrier and the vehicle at various times.



a.  $t = 0.090$  s, event = pickup truck strikes the barrier



b.  $t = 0.13$  s, event = pickup truck contacts the joint



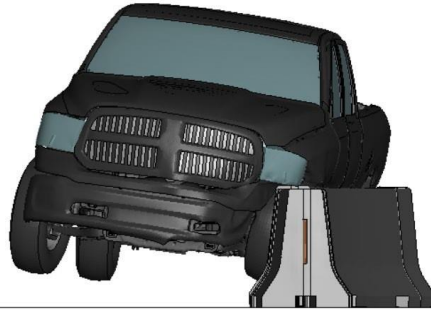
c.  $t = 0.40$  s, event = pickup truck redirected by the barrier

**Figure 7.10. Truck–F-Shape Barrier Interaction through Various Stages.**

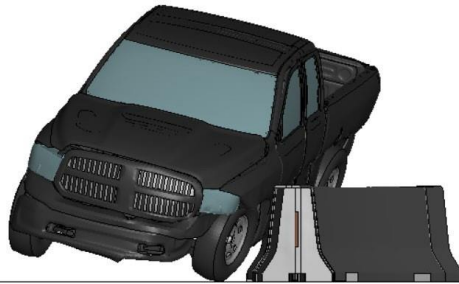
Figure 7.11 illustrates the post-impact trajectory of the truck. Lateral displacement of the impacted barrier was 55 inches. TRAP analysis was performed to calculate OIV, RA, and yaw, pitch, and roll. Table 7.7 summarizes the results from TRAP.



a.  $t = 0.10$  s, event = front right tire contacts the barrier



b.  $t = 0.31$  s, event = rear right tire contacts the barrier



c.  $t = 0.54$  s, event = front right tire touches ground

**Figure 7.11. Post-Impact Trajectory of the RAM Pickup Truck.**

**Table 7.7. TRAP Values for RAM Pickup Truck Impacting an Undamaged F-Shape Barrier.**

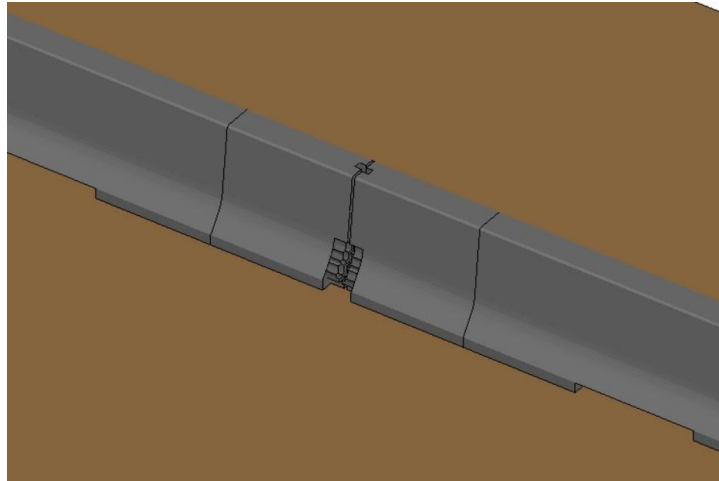
| Parameter    | Absolute Value |
|--------------|----------------|
| OIV (ft/s)   | 21.98          |
| RA           | 14.1           |
| Yaw (deg.)   | 41.1           |
| Pitch (deg.) | 12.9           |
| Roll (deg.)  | 13.1           |

### 7.6.2 Predictive Simulations with Pre-damaged F-Shape Barrier

The purpose of these simulations was to ascertain the values of OIV; RA; yaw, pitch, and roll values; and lateral displacement of the damaged barrier. Preexisting damage was introduced into the barrier system by deleting elements to make a spall of a certain size.

**7.6.2.1 Pre-damaged F-Shape Barrier (13-inch × 4-inch × 2-inch spall on adjacent toes) with RAM Model Representing a 5000-lb (2270P) MASH Pickup Truck Test Vehicle**

Preexisting damage in the form of a 13-inch (length) by 4-inch (width) by 2-inch (depth) spall was created on adjacent toes of the barrier. Figure 7.12 illustrates the damage created in the barrier.



**Figure 7.12. Pre-damaged F-Shape Barrier with Adjacent Toes Having Spall of Length = 13 inches, Width = 4 inches, Depth = 2 inches.**

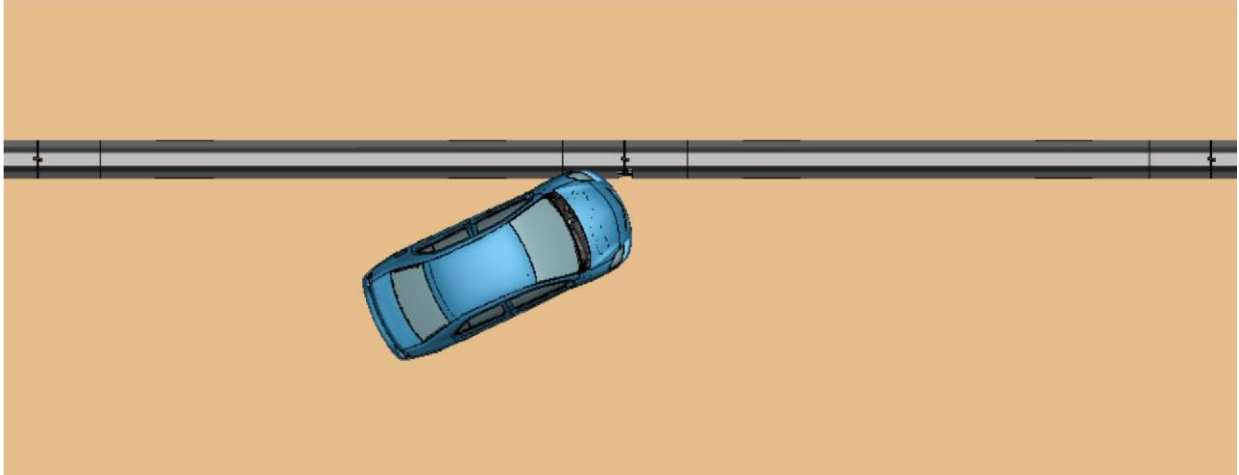
Lateral displacement of the impacted barrier was 55.4 inches. TRAP analysis was performed to calculate OIV, RA, and yaw, pitch, and roll. Table 7.8 summarizes the results from TRAP.

**Table 7.8. TRAP Values for RAM Pickup Truck Impacting an F-Shape Barrier with Two Spalled Toes.**

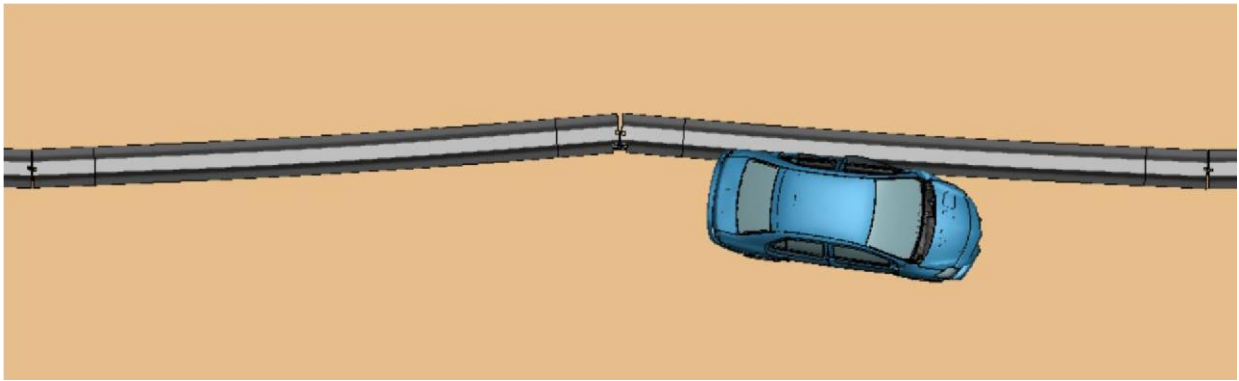
| Parameter    | Absolute Value |
|--------------|----------------|
| OIV (ft/s)   | 21.98          |
| RA           | 13.8           |
| Yaw (deg.)   | 49.1           |
| Pitch (deg.) | 13.2           |
| Roll (deg.)  | 12.9           |

**7.6.2.2 Pre-damaged F-Shape Barrier (13-inch × 4-inch × 2-inch spall on adjacent toes) with Toyota Yaris Model Representing a 2420-lb (1100C) MASH Small Car Test Vehicle**

Figure 7.13 illustrates the interaction between the barrier and the car at various times.



a.  $t = 0.090$  s, event = car strikes the barrier



b.  $t = 0.13$  s, event = car contacts the joint



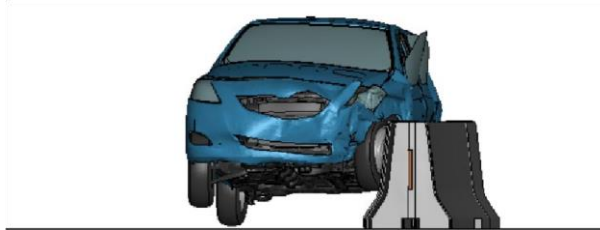
c.  $t = 0.33$  s, event = car redirected by the barrier

**Figure 7.13. Car–F-Shape Barrier Interaction through Various Stages.**

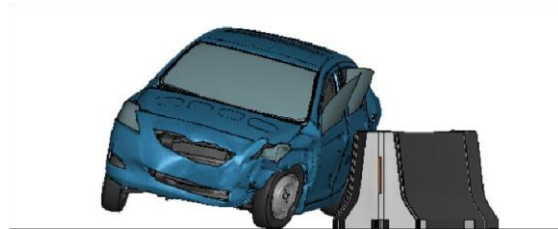
Figure 7.14 illustrates the post-impact trajectory of the car.



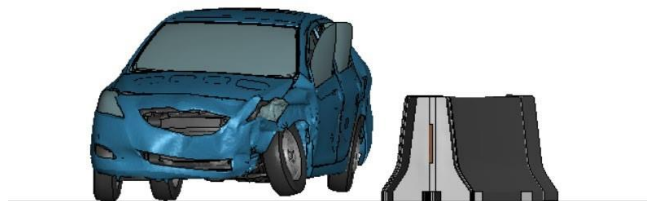
a.  $t = 0.10$  s, event = front right tire contacts the barrier



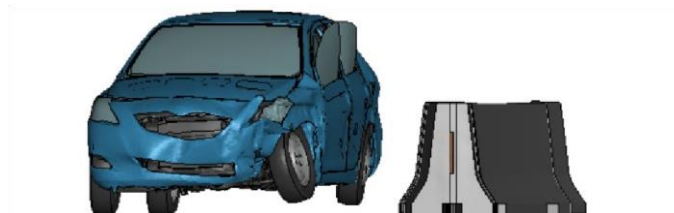
b.  $t = 0.23$  s, event = rear right tire contacts the barrier, window pane snags against the barrier



c.  $t = 0.45$  s, event = front right tire touches ground



d.  $t = 0.62$  s, event = rear right tire touches ground



e.  $t = 0.91$  s, event = rear right tire stabilizes on ground

**Figure 7.14. Post-Impact Trajectory of the Toyota Yaris Passenger Car.**

Lateral displacement of the impacted barrier was 27 inches. TRAP analysis was performed to calculate OIV, RA, and yaw, pitch, and roll. Table 7.9 summarizes the results from TRAP.

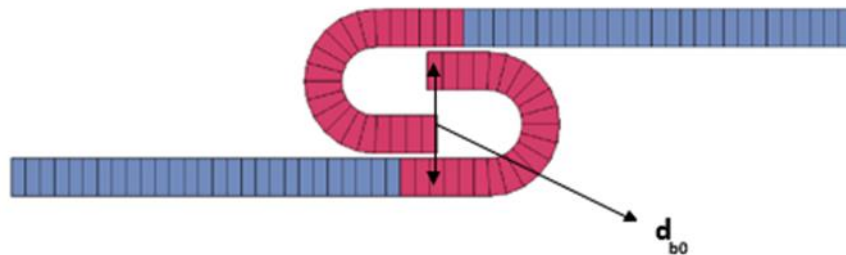


**Table 7.9. TRAP Values for Toyota Yaris Passenger Car Impacting an F-Shape Barrier with Two Spalled Toes.**

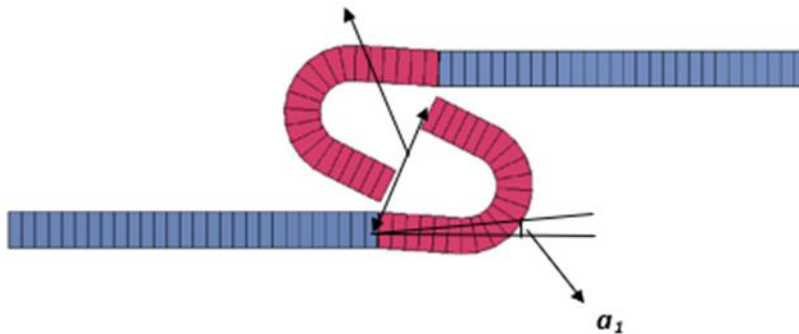
| Parameter    | Absolute Value |
|--------------|----------------|
| OIV (ft/s)   | 24.6           |
| RA           | 18.8           |
| Yaw (deg.)   | 36.6           |
| Pitch (deg.) | 5.7            |
| Roll (deg.)  | 15.8           |

### 7.6.3 F-Shape Barrier System with Pre-deformed JJ Hook Connectors

This series of simulations was carried out to assess the crashworthiness of the F-shape barrier system with pre-deformed JJ hooks and associated changes in the vehicle stability. JJ hook connectors were deformed in the model by making changes in the original geometry. Figure 7.15 shows a pair of undeformed hooks (diameter = 28 mm), and Figure 7.16 shows a pair of JJ hook connectors, where each hook is opened to 35.8 mm from the original diameter of 28 mm.

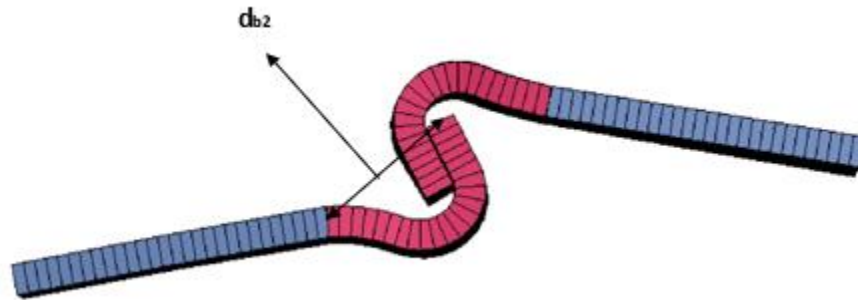


**Figure 7.15. Undeformed JJ Hook Connectors with  $d_{b0} = 28$  mm.**



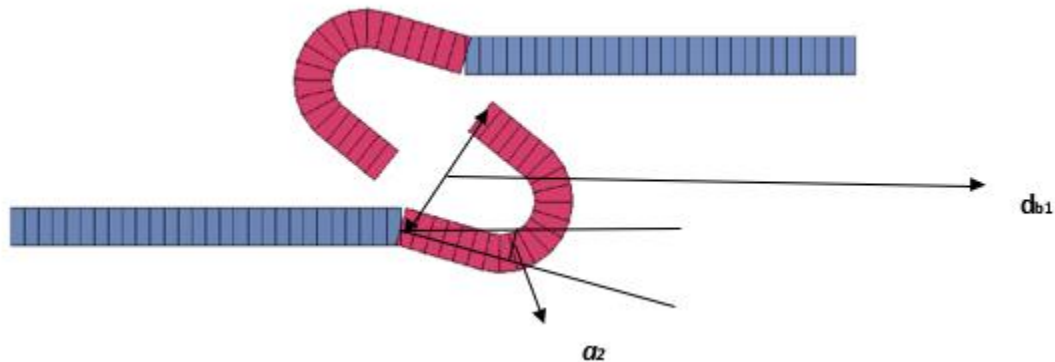
**Figure 7.16. Pre-deformed JJ Hook Connectors with  $d_{b1} = 35.8$  mm and Rotation Angle ( $\alpha_1$ ) = 4 deg.**

This deformation was comparable to the maximum JJ hook deformation recorded at the end of the predictive FEA simulation replicating *MASH* Test 3-11. A second predictive FEA simulation was conducted to replicate *MASH* Test 3-11 with inclusion of the above recorded JJ hook deformation. The critical impact point was chosen as suggested by *MASH* (4.3 ft upstream of the joint). Results of the second predictive FEA simulation showed that JJ hook connectors increased their deformation as expected (Figure 7.17). The pre-impact distance,  $d_{b1}$ , increased from 35.8 mm to 39 mm.



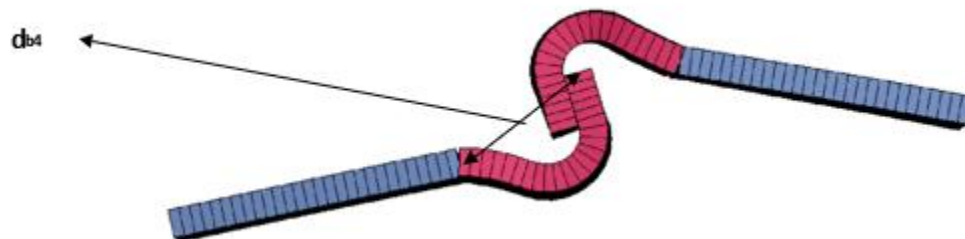
**Figure 7.17. Pre-deformed JJ Hook Connectors with  $d_{b1} = 35.8$  mm Open to  $d_{b2} = 39$  mm and Rotation Angle Increased from 4 deg.**

Further, the deformation in JJ hook connectors was increased by complementing the opening of the hook with maximum hook rotation. Figure 7.18 illustrates the next deformation level that was introduced in the JJ hook connectors.



**Figure 7.18. Pre-deformed JJ Hook Connectors with  $d_{b1} = 35.8$  mm and Rotation Angle ( $a_2$ ) = 16.4 deg.**

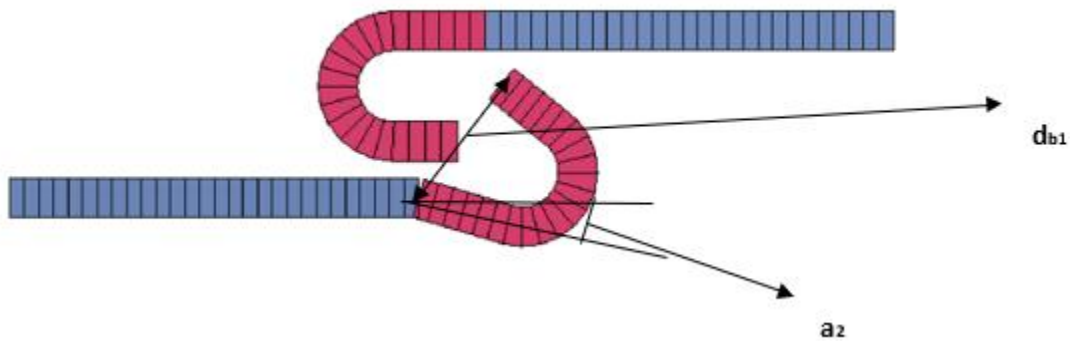
When the barrier system with pre-deformed JJ hook connectors shown in Figure 7.18 was impacted by the RAM pickup truck, the JJ hook connectors opened to a maximum distance of 52.4 mm. Figure 7.19 shows the resulting deformation in the JJ hook connectors.



**Figure 7.19. Pre-deformed JJ Hook Connectors with  $d_{b1} = 35.8$  mm Open to  $d_{b4} = 52.4$  mm and Rotation Angle Increased from 16.4 deg.**

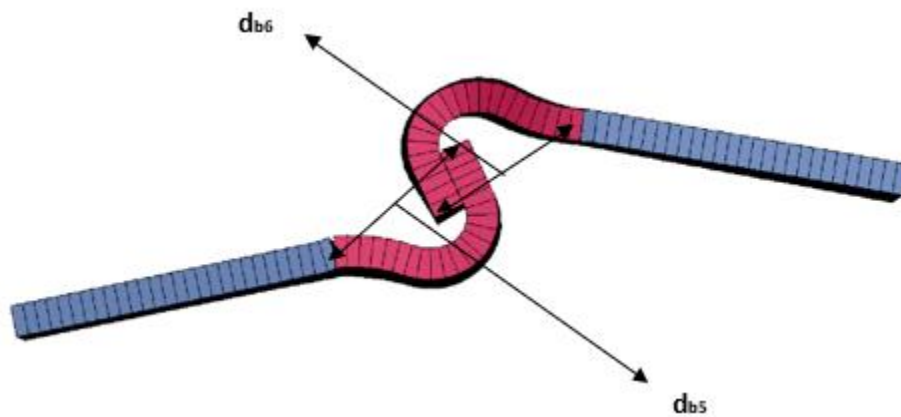
Since it is also possible to have the individual JJ hooks in a pair rotated at different angles, a simulation was run with the RAM pickup truck and a barrier system with one undeformed

JJ hook and another rotated JJ hook. Figure 7.20 shows the JJ connector pair with an undeformed hook and a deformed hook.



**Figure 7.20. Pair of Undeformed and Pre-deformed JJ Hook Connectors:  $d_{b1} = 35.8$  mm,  $a_2 = 16.4$  deg.**

Figure 7.21 illustrates the resulting deformation in the JJ hook connectors at the end of the simulation.



**Figure 7.21. Pre-deformed JJ Hook Open to  $d_{b5} = 50.5$  mm; Originally Undeformed Hook Open to  $d_{b6} = 50.0$  mm.**

Table 7.10 summarizes the system deflection, barrier segment openings at the back, and TRAP values for the F-shape barrier systems with the different pre-deformed JJ hook connections impacted by the RAM pickup truck. An erosion value of 1.1 was used in all these simulations.

**Table 7.10. F-Shape Barriers with Preexisting Deformations in JJ Hooks.**

| Parameter              | Pre-deformed JJ hook connectors with $d_{b1}=35.8$ mm and rotation angle $a_1=4$ deg. | Pair of undeformed and pre-deformed JJ connectors with $d_{b1}=35.8$ mm and rotation angle $a_2=16.4$ deg. | Pre-deformed JJ hook connectors with $d_{b1}=35.8$ mm and rotation angle $a_2=16.4$ deg. | Pre-deformed JJ hook connectors with $d_{b1}=35.8$ mm and rotation angle $a_2=16.4$ deg. combined with two spalls on toes |
|------------------------|---|--|--|---|
| Deflection (inch)      | 55.7  | 57.2   | 59.2   | 61.0  |
| Opening at back (inch) | 7.9   | 8.3  | 8.6  | 8.4   |
| OIV (ft/s)             | 22.2  | 22.2   | 22.1   | 21.7  |
| RA (g)                 | 13.9  | 13.9   | 13.4   | 12.9  |
| Roll (deg.)            | 13.0  | 10.6   | 12.3   | 12.7  |
| Pitch (deg.)           | 12.8  | 12.0   | 12.7   | 13.2  |
| Yaw (deg.)             | 48.7  | 46.2   | 48.7   | 49.5  |

Table 7.10 shows that the deflection of the barrier system increased from 55.7 inches (when pre-deformed JJ hook connectors had the hook open to a diameter of 35.8 mm) to 61 inches (when the maximum deformation level in JJ hooks was complemented by spalls on the adjacent toes). TRAP values for OIV, RA, and roll, pitch, and yaw are comparable and within the prescribed limits given in *MASH*.

## 7.7 CONCLUSIONS

Computer simulations were conducted to study the crashworthiness behavior of identified full-scale barrier systems (specifically with induced failure modes) under *MASH* TL-3 impact conditions through an engineering analysis. Finite element models of portable roadside barriers (single-slope and F-shape) along with the connection details were developed in LS-DYNA. The models were calibrated against component testing reported in Chapter 5. Next, predictive simulations were performed using available finite element *MASH* vehicle models: a RAM pickup truck and Toyota Yaris passenger car.

The finite element analyses were restricted to evaluate the preexisting damage in barriers in the form of spalls and deformed JJ hooks. Cracks were excluded from this task since the researchers made recommendations on cracks previously based on the overriding concern of durability.

The barrier model was considered validated since it replicated the component test results in terms of segment connection behavior, relative rotation of segments, and lateral displacement of the barrier system at the impacted joint. Different damage modes such as preexisting spalls and deformed JJ hooks were introduced into the barrier model.

Angular velocities and linear acceleration values from the predictive simulation (with an undamaged barrier system and barrier system with a specific failure mode) were extracted and

processed through the TRAP software. Results from TRAP were given in terms of yaw, pitch, and roll angles; OIV; and RA for the RAM pickup truck and Yaris passenger car. The TRAP values were compared with the corresponding limits prescribed for TL-3 in *MASH*.

Simulations indicated that the maximum spall of 13 inches (height) by 4 inches (width) by 2 inches (depth) did not alter the crashworthiness of the single-slope and F-shape barriers when impacted under *MASH* TL-3 conditions. Simulations that were conducted with the various deformation levels in the F-shape barrier indicated that the maximum JJ hook deformation considered by the researchers did not have a detrimental effect on the crashworthiness of the barrier system.

The modeling process had some limitations. The deformation of JJ hooks was introduced by applying changes to the original geometry of the JJ hook. The material properties of the JJ hook were not modified (i.e., no pre-stress or pre-strain was included in the material input, whereas certain levels of pre-strain would be realistically anticipated during full-scale testing). JJ hook deformations are accompanied by damage in the concrete surrounding the hooks, but in the model, such modification was not included.

Based on the modeling limitations discussed above, the researchers recommended conducting full-scale crash testing to verify the results recorded in the FEA simulations. Physical full-scale crash testing results will also provide additional material that can be used for future predictive simulations involving similar failure mode characteristics.



## 8. CONSTRUCTION AND FULL-SCALE CRASH TESTING

As noted in Chapter 7, the researchers recommended conducting full-scale crash testing to verify the results recorded in the FEA simulations and provide information useful to draft PCB segment acceptability due to various failure modes. The purpose of the full-scale crash tests reported in this chapter was to assess the performance of TxDOT's damaged portable concrete barriers according to the safety-performance evaluation guidelines included in *MASH* (47). The crash tests were performed in accordance with *MASH* Test 3-11. Details on the conducted full-scale crash testing are reported in a separate volume (50). Installations of F-shape profile PCB segments were used for the testing. The F-shape segment evaluation was deemed more critical than the single-slope PCB segment because of its shorter height (32 inches for the F-shape vs. 42 inches for the single slope) and its lower weight. A shorter height might induce vehicle instability during the vehicle impact event. A lower segment weight would result in higher subsequent barrier system deformation, which in turn could cause more vehicle instability and potential vehicle pocketing issues.

### 8.1 TEST ARTICLE DESIGN AND CONSTRUCTION

Each installation consisted of seven 30-ft long, 32-inch tall F-shape barriers connected end to end with JJ hook connections, for a total length of 210 ft 6 inches. For both tests, the barrier segments were specifically selected based on their existing damage modes, which included concrete spalling, concrete cracks, and segment connection deformations.

Specifically, the test installation for Test No. 440592-1 included a barrier segment (segment 3) that was selected due to a large 6-mm wide crack located on the field side of the installation that ran vertically 246 inches downstream from the joint of barriers 2 and 3. The downstream JJ hook on barrier 2 was bent 8 degrees. The upstream JJ hook on barrier 3 was not damaged, and the downstream JJ hook was bent 12 degrees. The upstream JJ hook on barrier 4 was not damaged.

For the Test No. 440592-2 test installation, spalling was manufactured by TTI personnel on the traffic side toe of barriers 3 and 4 at their joint. Each had a spall measuring approximately 3¾ inches wide by 13 inches high by 2 inches deep. At the same joint on the field side, the toe of barrier 4 was intentionally spalled and measured approximately 24 inches wide by 5 inches high by 2 inches deep. The JJ hooks at the joint of barriers 2 and 3 were not damaged. The downstream JJ hook on barrier 3 was bent 19 degrees, and the upstream JJ hook of barrier 4 was bent 15 degrees.

Figure 8.1 and Figure 8.2 provide photographs of the installation. Figure 8.3 through Figure 8.6 provide further details on the damaged portable concrete barriers. Drawings were provided by the TTI Proving Ground, and construction was performed by TTI Proving Ground personnel.

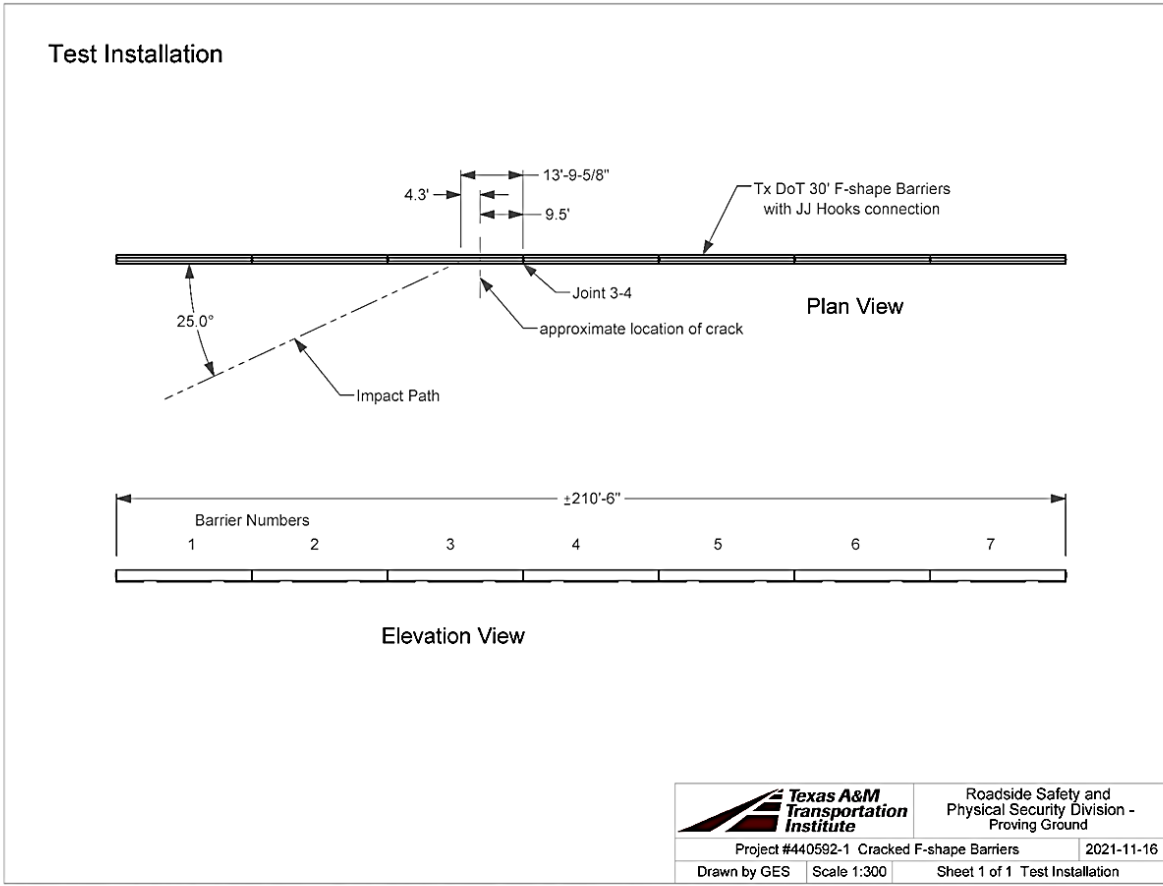




**Figure 8.1. Damaged Portable Concrete Barrier before Test No. 440592-1.**



**Figure 8.2. Damaged Portable Concrete Barrier before Test No. 440592-2.**



**Figure 8.3. Test Installation Layout for Test No. 440592-1.**

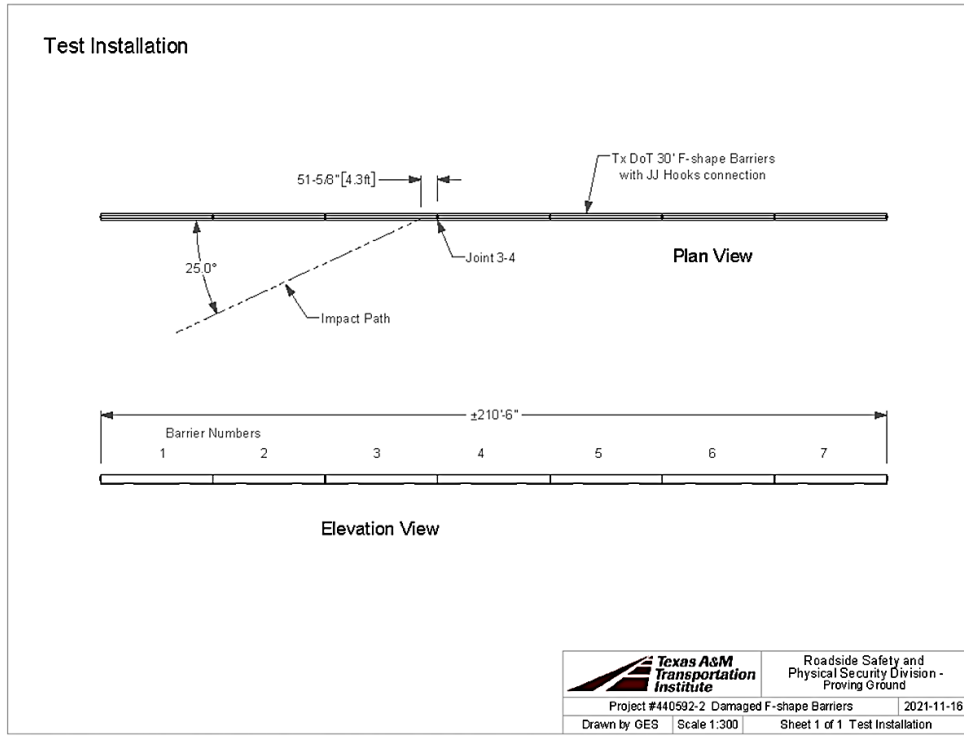


Figure 8.4. Test Installation Layout for Test No. 440592-2.

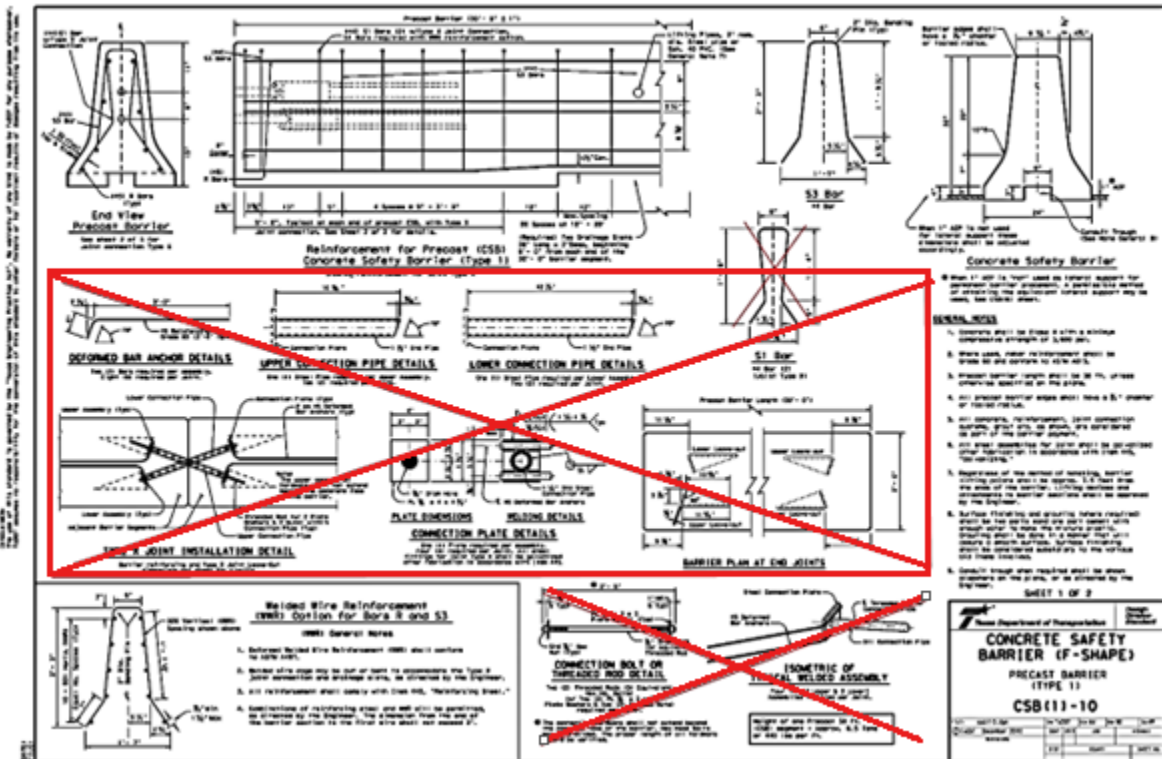


Figure 8.5. Reinforcement Details for PCB Segments Used in Test Nos. 440592-1 and -2.

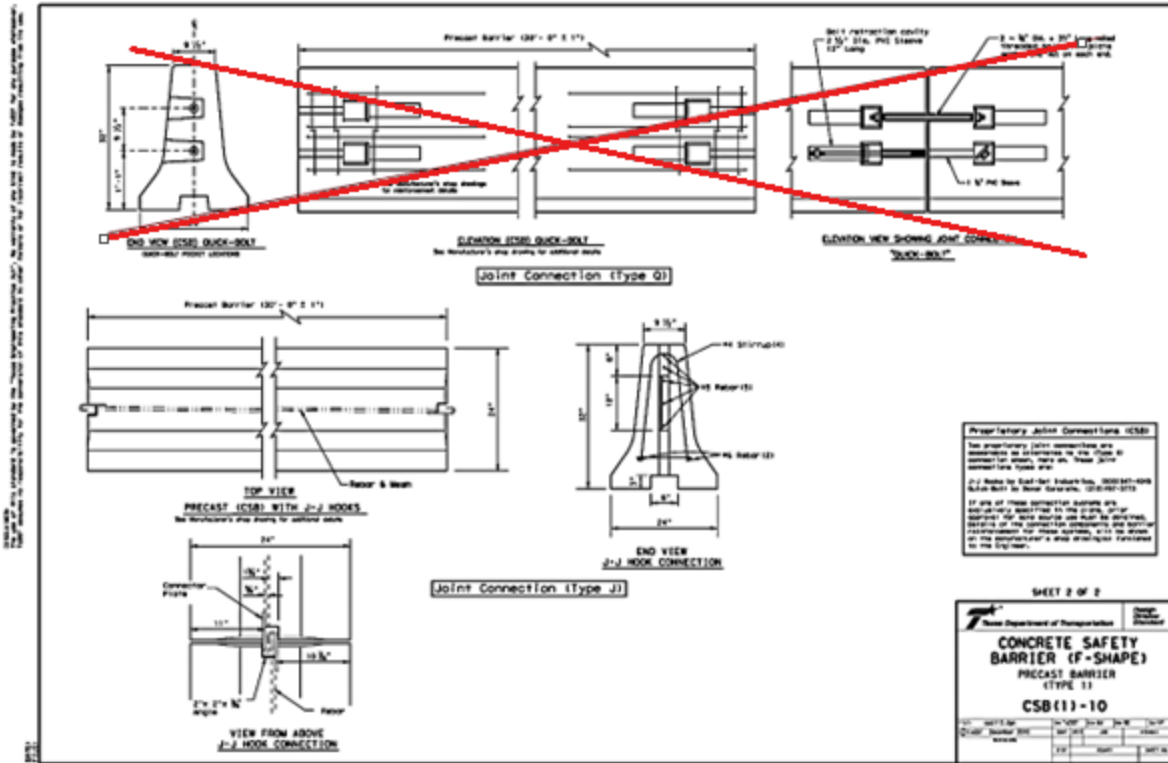


Figure 8.6. Connection Details for PCB Segments Used in Test Nos. 440592-1 and -2.

## 8.2 MASH TEST 3-11 (CRASH TEST NO. 440592-1)

### 8.2.1 Test Designation and Actual Test Conditions

Table 8.1 and Table 8.2 provide details on MASH impact conditions for Test No. 440592-1.

Table 8.1. Impact Conditions for MASH Test 3-11, Test No. 440592-1.

| Test Parameter               | Specification   | Tolerance   | Measured   |
|------------------------------|---|-------------|--|
| Impact Speed (mi/h)          | 62  | ±2.5 mi/h   | 61.8   |
| Impact Angle (deg.)          | 25  | ±1.5°       | 25.2   |
| Vehicle Inertial Weight (lb) | 5000  | ±110 lb     | 5025   |
| Impact Severity (kip-ft)     | 106   | ≥106 kip-ft | 116.3  |
| Impact Location              | 13.8 ft ± 1 ft upstream of the center of the joint between barriers 3 and 4 | ±1 ft       | 13.9 ft upstream of the center of the joint between barriers 3 and 4 |

**Table 8.2. Exit Parameters for MASH Test 3-11, Test No. 440592-1.**

| <b>Exit Parameters</b>         | <b>Values</b>   |
|--------------------------------|---|
| Speed (mi/h)                   | 53.3  |
| Trajectory (deg.)              | 7   |
| Heading (deg.)                 | 18  |
| Brakes applied post impact (s) | Brakes not applied  |
| Vehicle at rest position       | 203 ft downstream of impact point<br>10 ft to the field side<br>85° left  |
| Comments:                      | Vehicle remained upright and stable.<br>Vehicle crossed exit box 77 ft downstream from loss of contact.<br>Not less than 32.8 ft downstream from loss of contact for cars and pickups is optimal. |

### 8.2.2 Test Vehicle

A 2016 RAM 1500 was used for the crash test. Table 8.3 shows the vehicle measurements.

**Table 8.3. Vehicle Measurements for Test No. 440592-1.**

| <b>Test Parameter</b>                      | <b>MASH</b> | <b>Allowed Tolerance</b> | <b>Measured</b> |
|--|-------------|--------------------------|-----------------|
| Curb Weight (lb)                           | 5000        | N/A                      | 5083            |
| Gross Static (lb)                          | 5000        | ±110                     | 5025            |
| CG aft of Front Axle <sup>a</sup> (inches) | 63          | ±4                       | 59.6            |
| CG above Ground <sup>a,b</sup> (inches)    | 28          | ≥28                      | 28.6            |

<sup>a</sup> For test inertial mass.

<sup>b</sup> 2270P vehicle must meet minimum center of gravity (CG) height requirement.

### 8.2.3 Weather Conditions

Table 8.4 displays the weather conditions for Test No. 440592-1.

**Table 8.4. Weather Conditions for Test No. 440592-1.**

|                                |                     |
|--------------------------------|---------------------|
| <b>Date of Test</b>            | December 1, 2021 AM |
| <b>Temperature (°F)</b>        | 67                  |
| <b>Relative Humidity (%)</b>   | 88                  |
| <b>Wind Direction (deg)</b>    | 175                 |
| <b>Vehicle Traveling (deg)</b> | 350                 |
| <b>Wind Speed (mi/h)</b>       | 4                   |

## 8.2.4 Test Description

Table 8.5 lists events that occurred during Test No. 440592-1.

**Table 8.5. Events during Test No. 440592-1.**

| Time (s) | Events  |
|----------|---|
| 0.0000   | Vehicle impacts the installation                                |
| 0.0413   | Upstream end of barrier 3 begins to lift                        |
| 0.0430   | Vehicle begins to redirect                                      |
| 0.0475   | Large preexisting crack on backside of barrier begins to expand |
| 0.0810   | Front passenger side tire lifts off the pavement                |
| 0.1090   | Rear passenger side tire lifts off the pavement                 |
| 0.1940   | Vehicle travels parallel with installation                      |
| 0.4150   | Vehicle loses contact with the barrier                          |
| 0.5540   | Front driver side tire makes contact with pavement              |
| 0.8690   | Front passenger side tire makes contact with pavement           |

## 8.2.5 Test Article/Component Damage

There was major cracking and spalling at the downstream scupper of barrier 3. There was a significant amount of exposed rebar, which was severed by the impact of the test vehicle. The existing cracks before impact ranged in size from 0.1 mm to 6 mm, and post impact, they were between 0.1 mm and 108 mm.

Table 8.6 and Table 8.7 describe the damage to the portable concrete barriers. Figure 8.7 shows the damage to the portable concrete barriers.

**Table 8.6. Barrier Movement of Damaged Portable Concrete Barrier, Test No. 440592-1.**

| Joint/Barrier | Barrier Movement (inches)     |                             |                               |     | Comments  |
|---------------|-------------------------------|-----------------------------|-------------------------------|-----|---|
|               | D/S                           | U/S                         | T/S                           | F/S |   |
| 1             | 7                             | —                           | —                             | 2   |   |
| 1/2           | 6 <sup>1</sup> / <sub>2</sub> | —                           | 3                             | —   |   |
| 2/3           | 7                             | —                           | —                             | 7   |   |
| 3/4           | —                             | —                           | —                             | 59  | Barrier 3 was lifted 4 <sup>1</sup> / <sub>2</sub> inches |
| 4/5           | —                             | 4                           | 3 <sup>1</sup> / <sub>2</sub> | —   |   |
| 5/6           | —                             | <sup>3</sup> / <sub>4</sub> | —                             | 1   |   |
| 6/7           | —                             | 1                           | —                             | —   |   |
| 7             | —                             | <sup>1</sup> / <sub>2</sub> | —                             | 1   |   |

Note: D/S = Downstream; U/S = Upstream; T/S = Traffic Side; F/S = Field Side.



**Table 8.7. Damage to Damaged Portable Concrete Barrier, Test No. 440592-1.**

| Test Parameter                        | Measured  |
|---------------------------------------|---|
| Permanent Deflection/Location         | 61 inches toward field side, 100.5 inches upstream from the joint of barriers 3 and 4 |
| Dynamic Deflection                    | 61 inches toward field side   |
| Working Width <sup>a</sup> and Height | 85 inches, at a height of 3 inches  |

<sup>a</sup> Per *MASH*, “The working width is the maximum dynamic lateral position of any major part of the system or vehicle. These measurements are all relative to the pre-impact traffic face of the test article.” In other words, working width is the total barrier width plus the maximum dynamic intrusion of any portion of the barrier or test vehicle past the field side edge of the barrier.



**Figure 8.7. Damaged Portable Concrete Barrier after Test No. 440592-1.**

### 8.2.6 Test Vehicle Damage

Table 8.8 and Table 8.9 provide details on the occupant compartment deformation and test vehicle damage, and Figure 8.8 displays the damage.



**Table 8.8. Occupant Compartment Deformation, Test No. 440592-1.**

| Test Parameter                | Specification                    | Measured |
|-------------------------------|----------------------------------|----------|
| Roof                          | ≤4.0 inches                      | 0 inches |
| Windshield                    | ≤3.0 inches                      | 0 inches |
| A and B Pillars               | ≤5.0 overall/≤3.0 inches lateral | 0 inches |
| Foot Well/Toe Pan             | ≤9.0 inches                      | 0 inches |
| Floor Pan/Transmission Tunnel | ≤12.0 inches                     | 0 inches |
| Side Front Panel              | ≤12.0 inches                     | 1 inch   |
| Front Door (above Seat)       | ≤9.0 inches                      | 0 inches |
| Front Door (below Seat)       | ≤12.0 inches                     | 1 inch   |

**Table 8.9. Damage to Vehicle, Test No. 440592-1.**

|  |  |
|--|--|
| <b>Side Windows</b>                      | Side windows remained intact   |
| <b>Maximum Exterior Deformation</b>      | 12 inches in the left plane at the front corner at bumper height   |
| <b>VDS</b>                               | 11LFQ5   |
| <b>CDC</b>                               | 11FLEW3  |
| <b>Fuel Tank Damage</b>                  | None   |
| <b>Description of Damage to Vehicle:</b> | The front bumper, hood, grill, left headlight, left front fender, left front tire and rim, left front door, left rear door, left cab corner, left rear quarter fender, left rear tire and rim, left taillight, tailgate, and rear bumper were damaged. |



**Figure 8.8. Vehicle after Test No. 440592-1.**

### 8.2.7 Occupant Risk Values

Data from the accelerometer, located at the vehicle center of gravity, were digitized for evaluation of occupant risk and are reported in Table 8.10. These data and other pertinent information from the test are summarized in Table 8.11,

Table 8.12, Figure 8.9, and Figure 8.10.

**Table 8.10. Occupant Risk Factors for Test No. 440592-1.**

| <b>Test Parameter</b>      | <b>MASH</b> | <b>Measured</b> | <b>Time</b>                       |
|----------------------------|-------------|-----------------|-----------------------------------|
| OIV, Longitudinal (ft/s)   | ≤40.0       | 12.3            | 0.0983 s on left side of interior |
| OIV, Lateral (ft/s)        | ≤40.0       | 21.5            | 0.0983 s on left side of interior |
| Ridedown, Longitudinal (g) | ≤20.49      | 5.0             | 0.1262–0.1362 s                   |
| Ridedown, Lateral (g)      | ≤20.49      | 12.6            | 0.2338–0.2438 s                   |
| THIV (m/s)                 | N/A         | 7.7             | 0.0953 s on left side of interior |
| ASI                        | N/A         | 1.6             | 0.0528–0.1028 s                   |
| 50-ms MA Longitudinal (g)  | N/A         | −6.6            | 0.0141–0.0641 s                   |
| 50-ms MA Lateral (g)       | N/A         | 11.8            | 0.0276–0.0776 s                   |
| 50-ms MA Vertical (g)      | N/A         | −3.8            | 1.0732–1.1232 s                   |
| Roll (deg.)                | ≤75         | 17              | 0.6751 s                          |
| Pitch (deg.)               | ≤75         | 16              | 0.6976 s                          |
| Yaw (deg.)                 | N/A         | 61              | 1.0994 s                          |

**Table 8.11. Summary of Results for Test No. 440592-1, General Information, Impact and Exit Conditions.**

|                            |                           |   |
|----------------------------|---------------------------|---|
| <b>General Information</b> | Test Agency               | Texas A&M Transportation Institute  |
|                            | Test Standard Test No.    | <i>MASH</i> Test 3-11   |
|                            | TTI Test No.              | 440592-1  |
|                            | Test Date                 | 2021-12-01  |
| <b>Test Article</b>        | Type                      | Portable Concrete Barrier   |
|                            | Name                      | Damaged Portable Concrete Barrier   |
|                            | Installation Length       | 210 ft, 6 inches  |
|                            | Material or Key Elements  | Seven F-Shape Concrete Barriers   |
|                            | Foundation Type/Condition | Concrete Apron, Dry   |
| <b>Test Vehicle</b>        | Type/Designation          | 2270P   |
|                            | Make and Model            | 2016, RAM 1500  |
|                            | Curb                      | 5083 lb   |
|                            | Test Inertial             | 5025 lb   |
|                            | Dummy                     | N/A   |
|                            | Gross Static              | 5025 lb   |
| <b>Impact Conditions</b>   | Speed                     | 61.8 mi/h   |
|                            | Angle                     | 25.2 degrees  |
|                            | Location                  | 13.9 ft upstream from the centerline of the joint between barrier 3 and 4 |
|                            | Impact Severity           | 116.3 kip-ft  |
| <b>Exit Conditions</b>     | Speed                     | 53.3 mi/h   |
|                            | Exit Trajectory/Heading   | 7 degrees/18 degrees  |

**Table 8.12. Summary of Results for Test No. 440592-1, Occupant Risk, Vehicle and Test Article Damage.**

|                                 |                                       |   |
|---------------------------------|---------------------------------------|---|
| <b>Occupant Risk Values</b>     | Longitudinal OIV                      | 12.3 ft/s   |
|                                 | Lateral OIV                           | 21.5 ft/s   |
|                                 | Longitudinal RDA                      | 5.0 g   |
|                                 | Lateral RDA                           | 12.6 g  |
|                                 | THIV                                  | 7.7 m/s   |
|                                 | ASI                                   | 1.6   |
| <b>Max. 0.050-s Average</b>     | Longitudinal                          | -6.6 g  |
|                                 | Lateral                               | 11.8 g  |
|                                 | Vertical                              | -3.8 g  |
| <b>Post-Impact Trajectory</b>   | Stopping Distance                     | 203 ft downstream, 10 ft on field side                              |
| <b>Vehicle Stability</b>        | Maximum Roll Angle                    | 17°   |
|                                 | Maximum Pitch Angle                   | 16°   |
|                                 | Maximum Yaw Angle                     | 61°   |
|                                 | Vehicle Snagging                      | No indication of snagging   |
|                                 | Vehicle Pocketing                     | No indication of pocketing  |
| <b>Test Article Deflections</b> | Dynamic                               | 61 inches   |
|                                 | Permanent                             | 61 inches   |
|                                 | Working Width                         | 85 inches   |
|                                 | Height of Working Width               | 3 inches  |
| <b>Vehicle Damage</b>           | VDS                                   | 11LFQ5  |
|                                 | CDC                                   | 11FLEW3   |
|                                 | Max. Exterior Deformation             | 12 inches at left front bumper                                      |
|                                 | Max. Occupant Compartment Deformation | 1 inch at left kick panel area, and 1 inch at lower left front door |



(a) 0.000 s



(b) 0.100 s

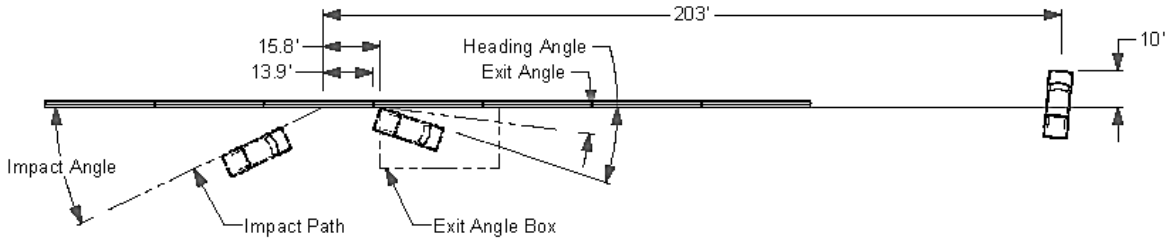


(c) 0.200 s



(d) 0.300 s

**Figure 8.9. Summary of Results for Test No. 440592-1, Sequential Test Pictures.**



**Figure 8.10. Summary of Results for Test No. 440592-1, Summary Drawing.**

### 8.3 MASH TEST 3-11 (CRASH TEST NO. 440592-2)

#### 8.3.1 Test Designation and Actual Test Conditions

Table 8.13 and Table 8.14 provide details on *MASH* impact conditions for this test.

**Table 8.13. Impact Conditions for *MASH* 3-11, Test No. 440592-2.**

| Test Parameter               | Specification   | Tolerance   | Measured  |
|------------------------------|---|-------------|---|
| Impact Speed (mi/h)          | 62  | ±2.5 mi/h   | 60.4  |
| Impact Angle (deg.)          | 25  | ±1.5°       | 24.9  |
| Vehicle Inertial Weight (lb) | 5000  | ±110 lb     | 5064  |
| Impact Severity (kip-ft)     | 106   | ≥106 kip-ft | 109.5   |
| Impact Location              | 4.3 ft upstream of the center of the joint between barriers 3 and 4 | ±1 ft       | 4.3 ft upstream of the center of the joint between barriers 3 and 4 |

**Table 8.14. Exit Parameters for *MASH* 3-11, Test No. 440592-2.**

| Exit Parameters                | Values   |
|--------------------------------|--|
| Speed (mi/h)                   | Out of view (not measurable)   |
| Trajectory (deg.)              | Out of view (not measurable)   |
| Heading (deg.)                 | Out of view (not measurable)   |
| Brakes applied post impact (s) | 2.9  |
| Vehicle at rest position       | 440 ft downstream of impact point<br>95 ft to the traffic side of the installation<br>30° right  |
| Comments:                      | Vehicle remained upright and stable. Vehicle crossed the exit box 131 ft downstream from loss of contact. Not less than 32.8 ft downstream from loss of contact for cars and pickups is optimal. |

### 8.3.2 Test Vehicle

A 2016 RAM 1500 was used for the crash test. Table 8.15 shows the vehicle measurements.

**Table 8.15. Vehicle Measurements for Test No. 440592-2.**

| Test Parameter                             | MASH | Allowed Tolerance | Measured |
|--|------|-------------------|----------|
| Curb Weight (lb)                           | 5000 | N/A               | 4990     |
| Gross Static (lb)                          | 5000 | ±110              | 5064     |
| CG aft of Front Axle <sup>a</sup> (inches) | 63   | ±4                | 60.8     |
| CG above Ground <sup>a,b</sup> (inches)    | 28   | ≥28               | 28.3     |

<sup>a</sup> For test inertial mass.

<sup>b</sup> 2270P vehicle must meet minimum CG height requirement.

### 8.3.3 Weather Conditions

Table 8.16 details the weather conditions for Test No. 440592-2.

**Table 8.16. Weather Conditions for Test No. 440592-2.**

|                         |                     |
|-------------------------|---------------------|
| Date of Test            | December 8, 2021 AM |
| Temperature (°F)        | 67                  |
| Relative Humidity (%)   | 82                  |
| Wind Direction (deg)    | 196                 |
| Vehicle Traveling (deg) | 350                 |
| Wind Speed (mi/h)       | 1                   |

### 8.3.4 Test Description

Table 8.17 lists events that occurred during Test No. 440592-2.

**Table 8.17. Events during Test No. 440592-2.**

| Time (s) | Events   |
|----------|--|
| 0.0000   | Vehicle impacts the installation                               |
| 0.0410   | Vehicle begins to redirect                                     |
| 0.0425   | Crack begins to form on field side of barrier 4 near joint 3–4 |
| 0.0790   | Front passenger side tire lifts off the pavement               |
| 0.1440   | Rear passenger side tire lifts off the pavement                |
| 0.2340   | Vehicle travels parallel with installation                     |
| 0.5910   | Front passenger side tire contacts the pavement                |



### 8.3.5 Test Article/Component Damage

There was significant spalling at the upstream end of barrier 4 and a small amount near its scupper. The existing cracks before impact ranged in size from 0.1 mm to 0.15 mm, and post impact, they were between 0.1 mm and 3.0 mm.

Table 8.18 and Table 8.19 describe the damage to the portable concrete barriers. Figure 8.11 shows the damage to the portable concrete barriers.

**Table 8.18. Barrier Movement of Damaged Portable Concrete Barrier, Test No. 440592-2.**

| Joint/Barrier | Barrier Movement (inches) |     |     |     | Comments |
|---------------|---------------------------|-----|-----|-----|----------|
|               | D/S                       | U/S | T/S | F/S |          |
| 1             | 6                         | —   | 1½  | —   |          |
| 1/2           | 6                         | —   | —   | 2   |          |
| 2/3           | 7½                        | —   | 3¼  | —   |          |
| 3/4           | —                         | —   | —   | 56  |          |
| 4/5           | —                         | 1½  | —   | 4.5 |          |
| 5/6           | —                         | 1½  | —   | 2   |          |
| 6/7           | —                         | 1   | —   | —   |          |
| 7             | —                         | 1   | —   | —   |          |

Note: D/S = Downstream; U/S = Upstream; T/S = Traffic Side; F/S = Field Side.

**Table 8.19. Damage to Damaged Portable Concrete Barrier, Test No. 440592-2.**

| Test Parameter                        | Measured  |
|---------------------------------------|---|
| Permanent Deflection/Location         | 56 inches toward field side at the joint between barriers 3 and 4 |
| Dynamic Deflection                    | 56 inches toward field side                                       |
| Working Width <sup>a</sup> and Height | 79.9 inches, at a height of 3 inches                              |

<sup>a</sup> Per *MASH*, “The working width is the maximum dynamic lateral position of any major part of the system or vehicle. These measurements are all relative to the pre-impact traffic face of the test article.” In other words, working width is the total barrier width plus the maximum dynamic intrusion of any portion of the barrier or test vehicle past the field side edge of the barrier.



**Figure 8.11. Damaged Portable Concrete Barrier after Test No. 440592-2.**

### 8.3.6 Test Vehicle Damage

Table 8.20 and Table 8.21 provide details on the test vehicle damage, and Figure 8.12 displays the damage.

**Table 8.20. Occupant Compartment Deformation, Test No. 440592-2.**

| Test Parameter                | Specification                    | Measured   |
|-------------------------------|----------------------------------|------------|
| Roof                          | ≤4.0 inches                      | 0 inches   |
| Windshield                    | ≤3.0 inches                      | 0 inches   |
| A and B Pillars               | ≤5.0 overall/≤3.0 inches lateral | 0 inches   |
| Foot Well/Toe Pan             | ≤9.0 inches                      | 8.5 inches |
| Floor Pan/Transmission Tunnel | ≤12.0 inches                     | 0 inches   |
| Side Front Panel              | ≤12.0 inches                     | 1 inch     |
| Front Door (above Seat)       | ≤9.0 inches                      | 0 inches   |
| Front Door (below Seat)       | ≤12.0 inches                     | 1 inch     |

**Table 8.21. Damage to Vehicle, Test No. 440592-2.**

|  |  |
|--|--|
| <b>Side Windows</b>                      | Side windows remained intact   |
| <b>Maximum Exterior Deformation</b>      | 14 inches in the left plane at the front corner at bumper height   |
| <b>VDS</b>                               | 11LFQ5   |
| <b>CDC</b>                               | 11FLEW3  |
| <b>Fuel Tank Damage</b>                  | None   |
| <b>Description of Damage to Vehicle:</b> | The front bumper, hood, grill, left headlight, left front tire and rim, left front upper and lower control arms, left tire rod, left front quarter fender, left front door, left front toe panel, left rear door, left rear cab corner, left rear quarter fender, left rear taillight, and rear bumper were damaged. |



**Figure 8.12. Vehicle after Test No. 440592-2.**

### 8.3.7 Occupant Risk Values

Data from the accelerometer, located at the vehicle center of gravity, were digitized for evaluation of occupant risk and are reported in Table 8.22. These data and other pertinent information from the test are summarized in Table 8.23, Table 8.24, Figure 8.13, and Figure 8.14.

**Table 8.22. Occupant Risk Factors for Test No. 440592-2.**

| <b>Test Parameter</b>      | <b>MASH</b> | <b>Measured</b> | <b>Time</b>                       |
|----------------------------|-------------|-----------------|-----------------------------------|
| OIV, Longitudinal (ft/s)   | ≤40.0       | 19.6            | 0.0969 s on left side of interior |
| OIV, Lateral (ft/s)        | ≤40.0       | 23.1            | 0.0969 s on left side of interior |
| Ridedown, Longitudinal (g) | ≤20.49      | 5.1             | 0.0969–0.1069 s                   |
| Ridedown, Lateral (g)      | ≤20.49      | 9.9             | 0.2710–0.2810 s                   |
| THIV (m/s)                 | N/A         | 9.1             | 0.0946 s on left side of interior |
| ASI                        | N/A         | 1.6             | 0.0543–0.1043 s                   |
| 50-ms MA Longitudinal (g)  | N/A         | –9.2            | 0.0407–0.0907 s                   |
| 50-ms MA Lateral (g)       | N/A         | 12.3            | 0.0356–0.0856 s                   |
| 50-ms MA Vertical (g)      | N/A         | –3.3            | 0.0136–0.0636 s                   |
| Roll (deg.)                | ≤75         | 14              | 0.4738 s                          |
| Pitch (deg.)               | ≤75         | 11              | 0.6330 s                          |
| Yaw (deg.)                 | N/A         | 40              | 1.0316 s                          |

**Table 8.23. Summary of Results for *MASH* Test 3-11 on Damaged Portable Concrete Barrier, Test No. 440592-2.**

|                            |                           |  |
|----------------------------|---------------------------|--|
| <b>General Information</b> | Test Agency               | Texas A&M Transportation Institute                                       |
|                            | Test Standard Test No.    | <i>MASH</i> Test 3-11  |
|                            | TTI Test No.              | 440592-2   |
|                            | Test Date                 | 2021-12-08   |
| <b>Test Article</b>        | Type                      | Portable Concrete Barrier  |
|                            | Name                      | Damaged Portable Concrete Barrier  |
|                            | Installation Length       | 210 ft, 6 inches   |
|                            | Material or Key Elements  | Seven F-Shape Concrete Barriers  |
|                            | Foundation Type/Condition | Concrete Apron, Dry  |
| <b>Test Vehicle</b>        | Type/Designation          | 2270P  |
|                            | Make and Model            | 2016, RAM 1500   |
|                            | Curb                      | 4990 lb  |
|                            | Test Inertial             | 5064 lb  |
|                            | Dummy                     | N/A  |
|                            | Gross Static              | 5064 lb  |
| <b>Impact Conditions</b>   | Speed                     | 60.4 mi/h  |
|                            | Angle                     | 24.9 degrees   |
|                            | Location                  | 4.3 ft upstream from the centerline of the joint between barrier 3 and 4 |
|                            | Impact Severity           | 109.5 kip-ft   |
| <b>Exit Conditions</b>     | Speed                     | Out of view (Not measurable)   |
|                            | Exit Trajectory/Heading   | Out of view (Not measurable)   |

**Table 8.24. Summary of Results for Test No. 440592-2, Occupant Risk, Vehicle and Test Article Damage.**

|                                 |                                       |  |
|---------------------------------|---------------------------------------|--|
| <b>Occupant Risk Values</b>     | Longitudinal OIV                      | 19.6 ft/s                                |
|                                 | Lateral OIV                           | 23.1 ft/s                                |
|                                 | Longitudinal RDA                      | 5.1 g                                    |
|                                 | Lateral RDA                           | 9.9 g                                    |
|                                 | THIV                                  | 9.1 m/s                                  |
|                                 | ASI                                   | 1.6                                      |
| <b>Max. 0.050-s Average</b>     | Longitudinal                          | -9.2 g                                   |
|                                 | Lateral                               | 12.3 g                                   |
|                                 | Vertical                              | -3.3 g                                   |
| <b>Post-Impact Trajectory</b>   | Stopping Distance                     | 440 ft downstream, 95 ft on traffic side |
| <b>Vehicle Stability</b>        | Maximum Roll Angle                    | 14°                                      |
|                                 | Maximum Pitch Angle                   | 11°                                      |
|                                 | Maximum Yaw Angle                     | 40°                                      |
|                                 | Vehicle Snagging                      | No indication of snagging                |
|                                 | Vehicle Pocketing                     | No indication of pocketing               |
| <b>Test Article Deflections</b> | Dynamic                               | 56 inches                                |
|                                 | Permanent                             | 56 inches                                |
|                                 | Working Width                         | 79.9 inches                              |
|                                 | Height of Working Width               | 3 inches                                 |
| <b>Vehicle Damage</b>           | VDS                                   | 11LFQ5                                   |
|                                 | CDC                                   | 11FLEW3                                  |
|                                 | Max. Exterior Deformation             | 14 inches at left front bumper           |
|                                 | Max. Occupant Compartment Deformation | 8½ inches, left toe pan area             |



(a) 0.000 s



(b) 0.100 s



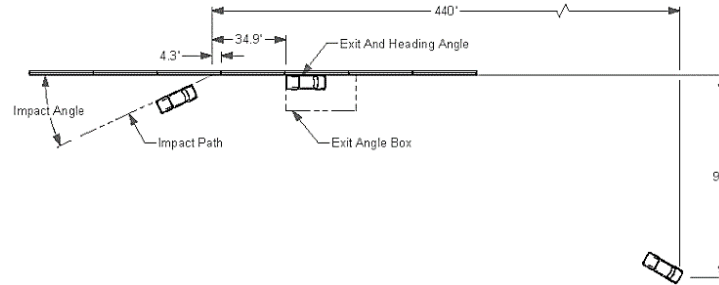
(c) 0.200 s



(d) 0.300 s

**Figure 8.13. Summary of Results for Test No. 440592-2, Sequential Test Pictures.**





**Figure 8.14. Summary of Results for Test No. 440592-2, Summary Drawing.**

#### **8.4 CONCLUSIONS ON *MASH* TEST 3-11 (CRASH TEST NO. 440592-1 AND NO. 440592-2)**

As noted in Chapter 7, the researchers recommended conducting full-scale crash testing to verify the results recorded in the FEA simulations and provide useful information to draft PCB segment acceptability due to various failure modes. The full-scale crash tests reported in this chapter assessed the performance of TxDOT's damaged portable concrete barriers according to the safety-performance evaluation guidelines included in *MASH* (47). Table 8.25 and Table 8.26 show that the two damaged portable concrete barrier systems met the performance criteria for *MASH* Test 3-11. Table 8.27 shows that the damaged portable concrete barriers met the performance criteria for *MASH* Test 3-11.

The full-scale crash test results indicated that the tested barrier installations exhibited crashworthy behavior, even considering the pre-damaged segments and connections utilized in the system. Therefore, those barrier and connection damages were deemed acceptable per *MASH* Test 3-11 testing and evaluation criteria. Since the F-shape segment evaluation was deemed more critical than the single-slope PCB segment for reasons noted earlier in this chapter, it was also concluded that 42-inch single-slope barrier segments would be deemed crashworthy per *MASH* Test 3-11 when considering the same type and level of barrier (spall and cracking) and segment connection damages.

**Table 8.25. Performance Evaluation Summary for MASH Test 3-11 on Damaged Portable Concrete Barrier, Test No. 440592-1**

| <b>Evaluation Factors</b> | <b>Evaluation Criteria</b> |   | <b>Assessment</b> |
|---------------------------|----------------------------|---|-------------------|
| Structural Adequacy       | A.                         | The damaged portable concrete barrier contained and redirected the 2270P vehicle. The vehicle did not penetrate, underride, or override the installation. Maximum dynamic deflection during the test was 60.9 inches.   | Pass              |
| Occupant Risk             | D.                         | No detached elements, fragments, or other debris from the transition was present to penetrate or show potential for penetrating the occupant compartment, or present hazard to others in the area. Maximum occupant compartment deformation was 1.0 inch in the left kick panel area. | Pass              |
|                           | F.                         | The 2270P vehicle remained upright during and after the collision event. Maximum roll and pitch angles were 17 degrees and 16 degrees.  | Pass              |
|                           | H.                         | Longitudinal OIV was 12.3 ft/s, and lateral OIV was 21.5 ft/s.  | Pass              |
|                           | I.                         | Longitudinal occupant RA was 5.0 g, and lateral occupant RA was 12.6 g.   | Pass              |

**Table 8.26. Performance Evaluation Summary for MASH Test 3-11 on Damaged Portable Concrete Barrier, Test No. 440592-2.**

| <b>Evaluation Factors</b> | <b>Evaluation Criteria</b> |  | <b>Assessment</b> |
|---------------------------|----------------------------|--|-------------------|
| Structural Adequacy       | A.                         | The damaged portable concrete barrier contained and redirected the 2270P vehicle. The vehicle did not penetrate, underride, or override the installation. Maximum dynamic deflection during the test was 56 inches.  | Pass              |
| Occupant Risk             | D.                         | No detached elements, fragments, or other debris from the transition was present to penetrate or show potential for penetrating the occupant compartment, or present hazard to others in the area. Maximum occupant compartment deformation was 8.5 inches in the left front toe pan area. | Pass              |
|                           | F.                         | The 2270P vehicle remained upright during and after the collision event. Maximum roll and pitch angles were 14 degrees and 11 degrees.   | Pass              |
|                           | H.                         | Longitudinal OIV was 19.6 ft/s, and lateral OIV was 23.1 ft/s.   | Pass              |
|                           | I.                         | Longitudinal occupant RA was 5.1 g, and lateral occupant RA was 9.9 g.   | Pass              |

**Table 8.27. Assessment Summary for MASH TL-3 Tests on Damaged Portable Concrete Barriers.**

| Evaluation Factors  | Evaluation Criteria | Test No. 440592-1 | Test No. 440592-2 |
|---------------------|---------------------|-------------------|-------------------|
| Structural Adequacy | A                   | S                 | S                 |
| Occupant Risk       | D                   | S                 | S                 |
|                     | F                   | S                 | S                 |
|                     | H                   | S                 | S                 |
|                     | I                   | S                 | S                 |
| Result              | Pass/Fail           | Pass              | Pass              |



## 9. GUIDELINES FOR THE EVALUATION AND REPAIR OF PORTABLE CONCRETE BARRIERS

This chapter contains proposed guidelines for the inspection, use, and repair of portable concrete barriers. The evaluation criteria suggested in this chapter were developed based on the results from previous project tasks involving the literature review, surveys, computer analysis, and component and full-scale testing.

Inspection of PCBs should be done at several stages during a project: upon delivery to the site, during the initial setup, during phase changes, and periodically throughout the duration of the project. Inspectors should check for any damage in the form of concrete spalls, erosion, cracks, rebar exposure, or connection deformation. If unacceptable damages are observed, the inspector should direct the staff to remove the damaged barrier from service. Depending on the severity of the damage observed, the inspector should request that the barrier either be repaired before moving it back into service or be replaced with a new barrier. The decision to repair or replace depends on various factors, such as cost, durability of repair, extension of service life with respect to each of the alternatives, and so forth.

The guidance presented herein discusses the different criteria to classify PCBs into three categories:

- Acceptable.
- Acceptable with repair.
- Unacceptable.

Examples of acceptable, acceptable with repair, and unacceptable barriers are provided to assist the engineer in charge with categorizing PCBs. A PCB can be classified as unacceptable if it meets at least one of the proposed unacceptable conditions.

### 9.1 EVALUATION GUIDELINES

#### 9.1.1 Spalling

The following section discusses evaluation criteria for acceptability of concrete barriers based on spalling (Figure 9.1). *Spalling* is defined as the flaking or peeling away of concrete from the main body, which may result in fractured, compromised concrete or expose underlying reinforcing bars (rebar). On a PCB, concrete spalling can be located near the barrier segment end connection, near segment “toes” (i.e., the bottom longitudinal edge of the barrier), along the barrier face, or near barrier discontinuities such as lifting pipes or drainage scuppers.

A PCB is considered acceptable regardless of the number and location of concrete spalls present on the barrier provided that spalling does not cause exposure of reinforcement.

If concrete spalling results in the exposure of barrier reinforcement, then further inspection is needed to determine whether the exposed reinforcement has signs of corrosion and whether such corrosion is superficial or has already caused obvious loss of the rebar cross-section.

Superficial corrosion is surface corrosion that is confined to the surface of the metal and exhibits the absence of cracks or significant section loss. If the corrosion has propagated further inside the surface and the reinforcement is either cracked or has undergone significant metal loss, the PCB segment is considered unacceptable for further use, and it needs to be removed from service.

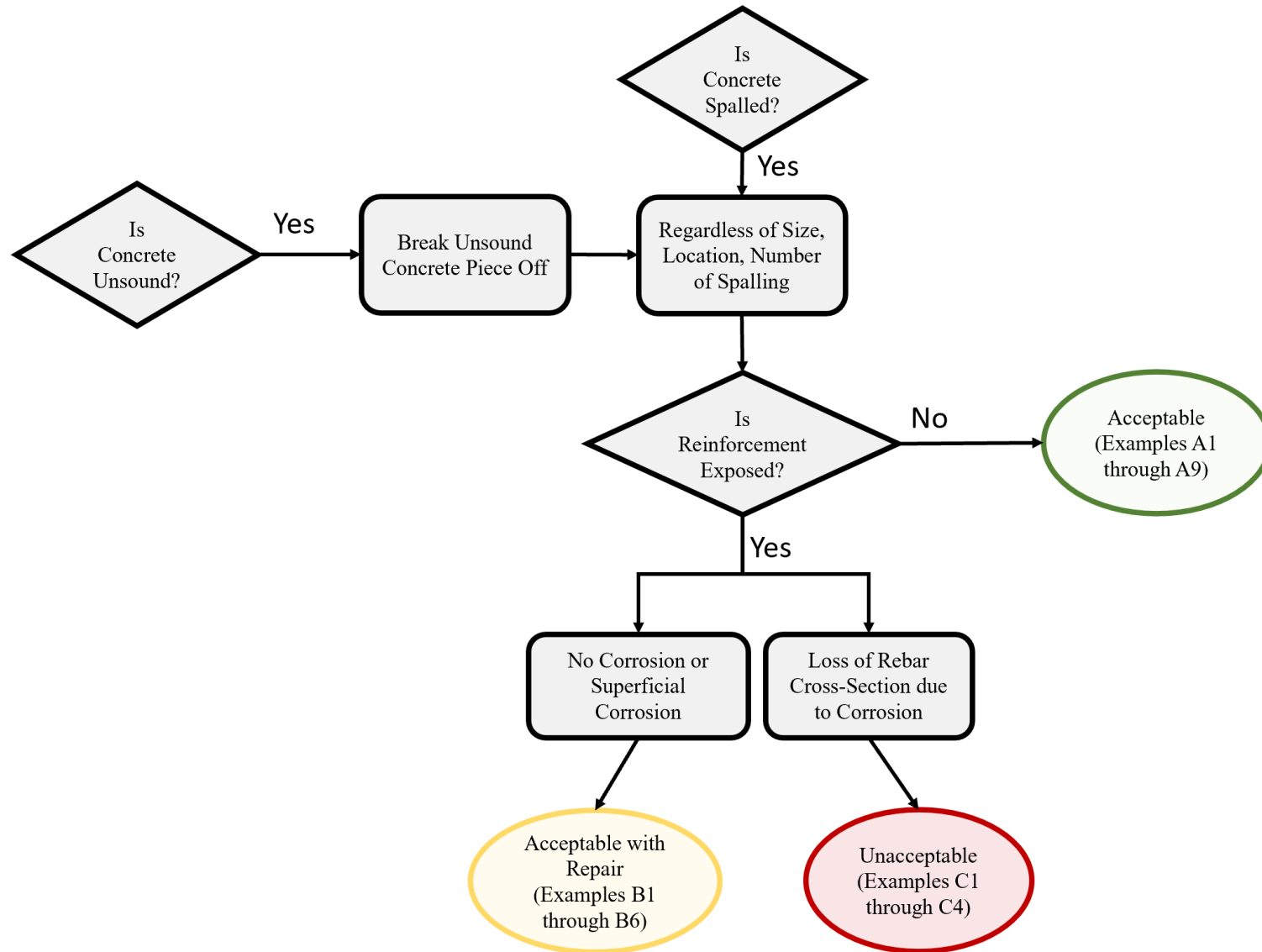
If a spall exposes rebar but the exposed rebar has no corrosion present or the corrosion is superficial, the PCB segment is considered acceptable for repair. Repair includes cleaning any superficially corroded rebar and patching the spalled concrete that exposed the reinforcement using new concrete with a bonding agent applied to the exposed surface.

If there is a section of concrete that is damaged but still attached to the barrier, the soundness of the concrete should be assessed. Unsound concrete is defined as a partial hanging of a concrete portion that is susceptible to break off if further impacted. Unsound concrete can be caused by various factors, such as visible cracks, micro-cracks, spalling, and delamination on the surface of the barrier. The following methods exist to determine whether a damaged section of concrete is unsound:

- Tap the damaged area under consideration with a hammer. If the hammer bounces back, the concrete is sound and has the required compressive strength. However, if the hammer lands with a thud with little or no rebound or a portion of the concrete pulverizes and falls off, then the concrete is considered unsound.
- Drag a screwdriver on the damaged surface under consideration. If the scratching results in a white line or streak, then the concrete is sound. If the scratching results in formation of powder, then the concrete is unsound.

Any detected unsound concrete should be removed. After removal, the underlying section can be further evaluated for acceptability based on concrete spalling criteria.



Table 9.1 through Table 9.3 provide a visual guideline of examples for acceptable, acceptable with repair, and unacceptable PCB systems based on the failure mode of spalling.


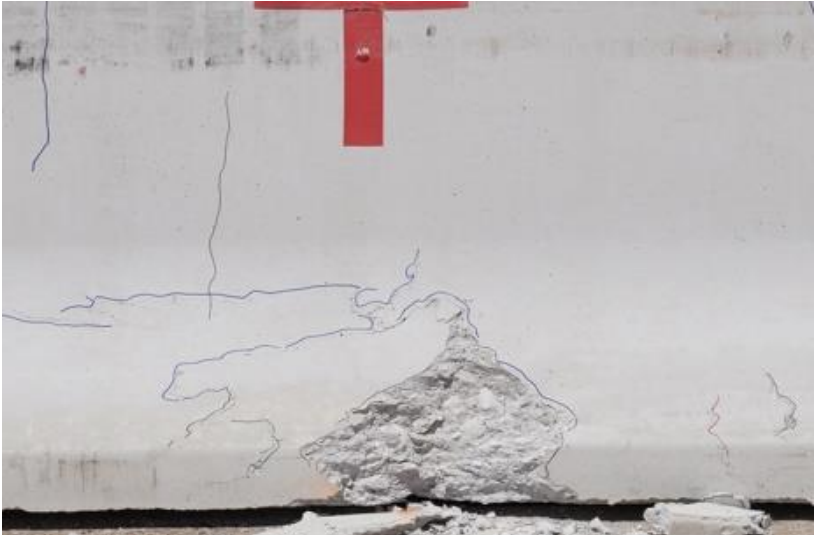




**Figure 9.1. Spalling—Evaluation Criteria Flowchart.**






**Table 9.1. Spalling—Acceptable Barriers.**

| <b>Example</b> | <b>Image and Description</b>  |
|----------------|---|
| A-1            |  <p data-bbox="639 831 1325 898">Spall at drainage scupper. No exposed reinforcement.<br/>Barrier is acceptable.</p>                |
| A-2            |  <p data-bbox="570 1541 1395 1608">Spall at bottom corner at barrier end. No exposed reinforcement.<br/>Barrier is acceptable.</p> |


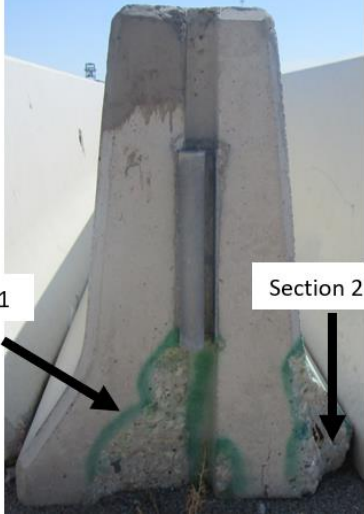
| Example | Image and Description  |
|---------|--|
| A-3     |  <p data-bbox="578 919 1390 993">Spall at upper corner at barrier end. No exposed reinforcement.<br/>Barrier is acceptable.</p>  |
| A-4     |  <p data-bbox="578 1556 1390 1633">Spall at middle of barrier at toe. No exposed reinforcement.<br/>Barrier is acceptable.</p> |

| Example | Image and Description  |
|---------|--|
| A-5     |  <p data-bbox="678 869 1289 940">Spall at lifting pipe. No exposed reinforcement.<br/>Barrier is acceptable.</p>             |
| A-6     |  <p data-bbox="607 1562 1360 1631">Multiple spalls in same barrier. No exposed reinforcement.<br/>Barrier is acceptable</p> |



| Example | Image and Description  |
|---------|--|
| A-7     |  <p data-bbox="605 932 1360 999">Multiple spalls in same barrier. No exposed reinforcement.<br/>Barrier is acceptable.</p>     |
| A-8     |  <p data-bbox="605 1572 1360 1640">Multiple spalls in same barrier. No exposed reinforcement.<br/>Barrier is acceptable.</p> |

| Example | Image and Description   |
|---------|---|
| A-9     |  <p data-bbox="548 951 1417 1020">Multiple spalls at top and bottom barrier, near segment connections. No exposed reinforcement. Barrier is acceptable.</p> |



**Table 9.2. Spalling—Acceptable Barriers with Repair.**

| Example    | Image and Description  |
|------------|--|
| <p>B-1</p> |  <p>Spall at barrier end exposing reinforcement. Corrosion is superficial. Barrier is acceptable with repair.</p>  |
| <p>B-2</p> |  <p>Multiple spalls present at barrier end. Spall 1 does not expose reinforcement and is acceptable. Spall 2 exposes rebar with superficial corrosion. Barrier acceptable if Spall 2 is repaired.</p> |






| Example | Image and Description  |
|---------|--|
| B-3     |  <p data-bbox="602 814 1365 884">Spall at barrier end exposing reinforcement with superficial corrosion. Barrier acceptable with repair.</p>                 |
| B-4     |  <p data-bbox="548 1455 1414 1524">Spall at barrier end exposing slightly bent reinforcement. Corrosion is superficial. Barrier acceptable with repair.</p> |




| Example                                  | Image and Description   |
|--|---|
| <p data-bbox="337 537 386 569">B-5</p>   |  <p data-bbox="558 804 1406 873">Spall at barrier top corner exposing reinforcement with superficial corrosion. Barrier acceptable with repair.</p> |
| <p data-bbox="337 1157 386 1188">B-6</p> |  <p data-bbox="602 1392 1365 1461">Spall at barrier end exposing reinforcement with superficial corrosion. Barrier acceptable with repair.</p>     |

**Table 9.3. Spalling—Unacceptable Barriers.**

| <b>Example</b> | <b>Image and Description</b>  |
|----------------|---|
| C-1            |  <p data-bbox="542 1087 1409 1157">Spalling exposing reinforcement. Evidence of significant corrosion. Barrier is unacceptable and should be removed from service.</p> |

| Example | Image and Description   |
|---------|---|
| C-2     |  <p data-bbox="548 1077 1403 1150">Significant corrosion of exposed rebar. Barrier is unacceptable and should be removed from service.</p>   |
| C-3     |  <p data-bbox="537 1686 1414 1793">Spall at barrier bottom exposing reinforcement. Evidence of significant corrosion. Barrier is unacceptable and should be removed from service.</p> |

| Example | Image and Description  |
|---------|--|
| C-4     |  <p data-bbox="565 758 1383 865">Multiple spalls exposing reinforcement. Evidence of significant corrosion at barrier bottom, with corrosion staining nearby area. Barrier is unacceptable and should be removed from service.</p> |

### 9.1.2 Cracks

This section discusses evaluation criteria for acceptability of concrete barriers based on the failure mode of cracking (Figure 9.2).

Multiple hairline cracks are acceptable regardless of the number and location. As per the American Concrete Institute's *Cement and Concrete Terminology* handbook, *hairline cracks* are defined as having a crack width of less than 0.003 inches (0.08 mm), which is barely perceptible to the naked eye (51). These cracks usually develop due to plastic shrinkage of the concrete. These cracks are shallow and unopened and offer very little room to repair, with a low viscosity liquid being the only possible method of repair. These cracks do not affect the structural integrity of the concrete barrier. Therefore, a concrete barrier exhibiting only multiple hairline cracks is acceptable for further use.

A PCB is acceptable with repair when it has:

1. One crack whose width dimensions do not exceed 0.25 inches.
2. Multiple cracks whose summed width dimensions do not exceed 0.25 inches within a 1-ft longitudinal barrier segment.

In situations where the crack width is deep enough to expose reinforcement, further inspection is required.

If superficial corrosion of the reinforcement is present, then the barrier is acceptable with repair, given that the sealing should be able to halt the corrosion process. Superficial corrosion is surface corrosion that is confined to the surface of the metal and exhibits no cracks within reinforcement. For repair criteria, please refer to Chapter 9.

However, if the corrosion has propagated further inside the surface and the reinforcement is either cracked or has undergone metal loss, then it is a case of the obvious loss of the cross-section, and the PCB segment is not considered suitable for repair. Instead, the barrier is deemed unacceptable for further use and needs to be discarded.

The durability of any repair method chosen to rectify cracks (in terms of number of years added to the present age of the barrier) is not standard and depends on several factors, such as the present age of the barrier, climatic conditions of the region where the barrier is installed, crack width, and more. The decision to repair or replace is influenced by cost, safety levels, and expected service life associated with repair or replacement.

The service lives associated with repair and replacement are different (the life of a new barrier is greater than the life of a repaired barrier). Therefore, the per-year cost of repair (which includes the costs of materials and labor) should be estimated based on the number of cracks present, average crack width, and length. This cost should be compared to the per-year cost (which includes the costs of materials, transportation, and installment) of a new barrier to arrive at a decision.

In some cases, instead of deciding immediately among structural repair and replacement, the barrier may be kept in service after closing the cracks with a surface sealant (to prevent the

infiltration of contaminants and water). The barrier condition may be monitored periodically (within 2 years) to check how the cracks progress. A suitable structural repair or decision to replace can be handled later depending on the findings of the assessment period. For example, where the transverse cracks are compressed, the barrier may be monitored for a certain time while keeping it in service to check if the cracks propagate further. Depending on the findings of the assessment period, further action can be taken.

A PCB is unacceptable for further use and needs to be discarded when it has:

1. One crack whose width dimensions exceed 0.25 inches.
2. Multiple cracks whose summed width dimensions exceed 0.25 inches within a 1-ft longitudinal barrier segment.

Table 9.4 through Table 9.6 provide a visual guideline of examples for acceptable, acceptable with repair, and unacceptable PCB systems based on the failure mode of cracking.

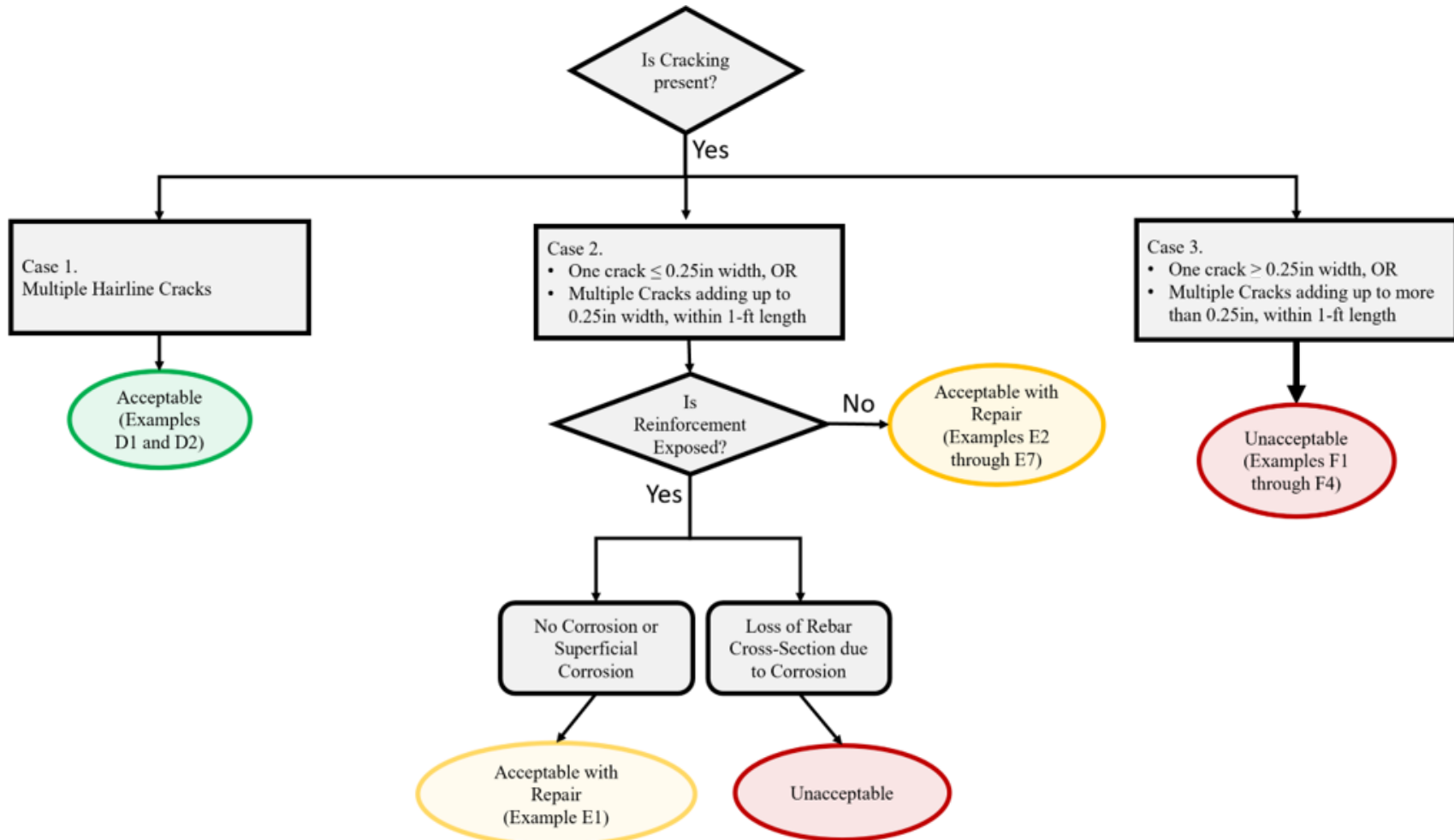
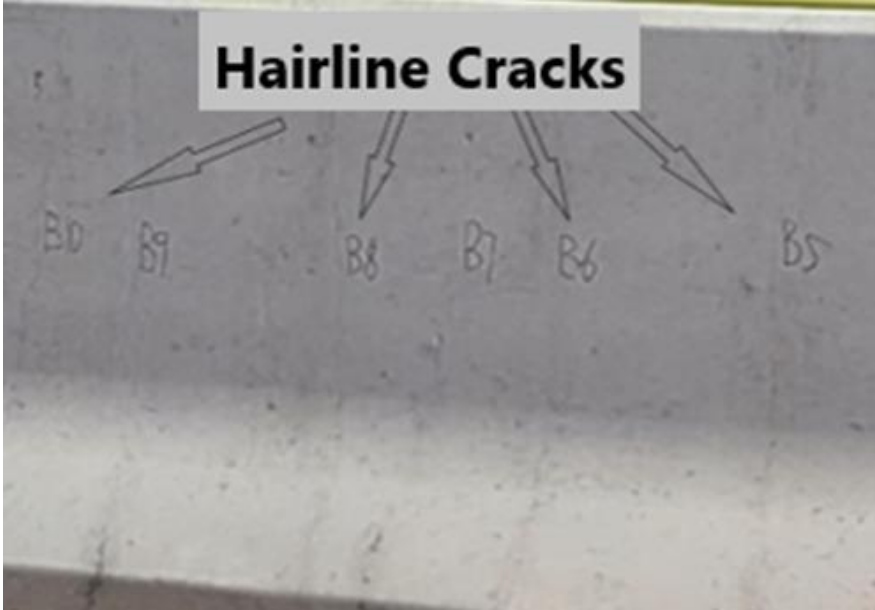
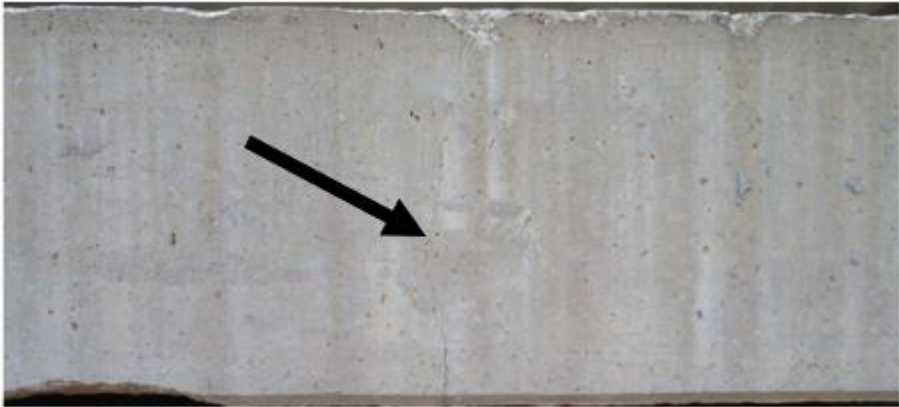




Figure 9.2. Cracking—Evaluation Criteria Flowchart.


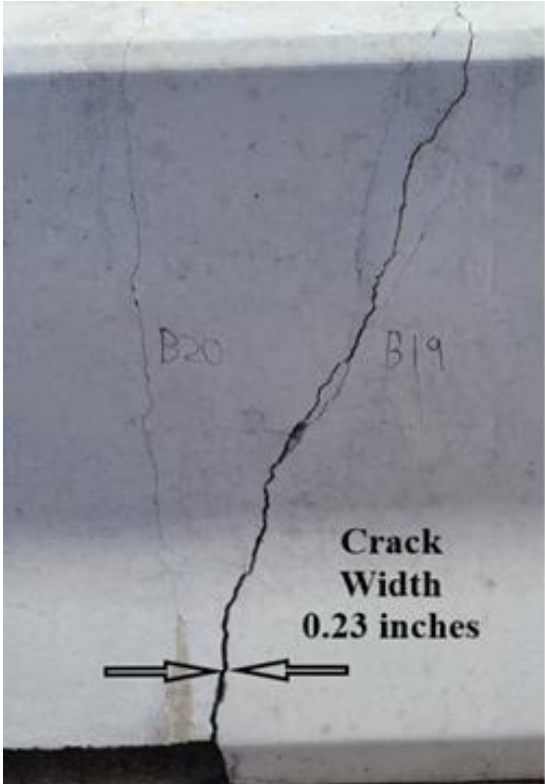




**Table 9.4. Cracking—Acceptable Barriers.**


| <b>Example</b> | <b>Image and Description</b>  |
|----------------|---|
| D-1            |  <p data-bbox="669 953 1263 989">Multiple hairline cracks. Barrier is acceptable.</p> |
| D-2            |  <p data-bbox="732 1451 1203 1486">Hairline crack. Barrier is acceptable.</p>       |

**Table 9.5. Cracking—Acceptable Barriers with Repair.**


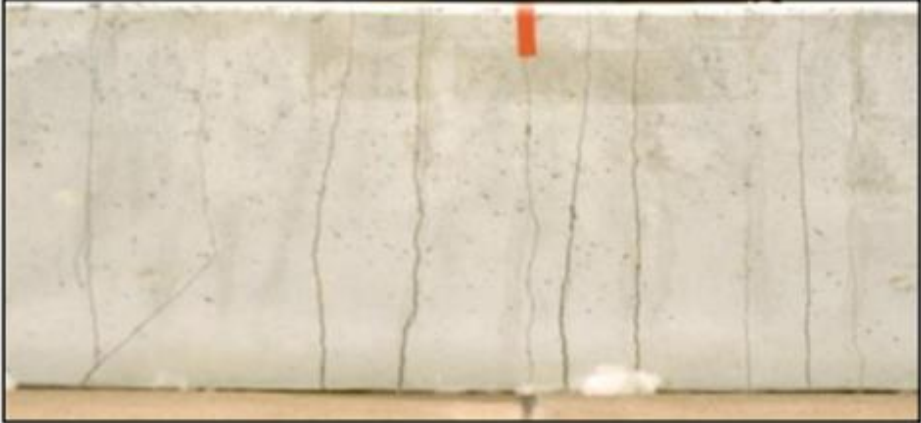
| Example | Image and Description   |
|---------|---|
| E-1     |  <p data-bbox="483 835 1409 940">Crack width measuring less than 0.25 inches. Although reinforcement is exposed due to the crack presence, there is no evidence of corrosion. Barrier acceptable with repair.</p>   |
| E-2     |  <p data-bbox="477 1348 1419 1453">Crack measuring less than 0.25 inches (lower half of the barrier) branching into two cracks whose widths are less than 0.1 inches each. No reinforcement exposure through cracks. Barrier acceptable with repair.</p> |



| Example | Image and Description  |
|---------|--|
| E-3     |  <p data-bbox="483 674 1409 779">Crack measuring less than 0.25 inches, branching into two cracks whose combined widths are less than 0.25 inches. No reinforcement exposure through cracks. Barrier acceptable with repair.</p> |
| E-4     |  <p data-bbox="477 1614 1416 1686">Crack width measuring less than 0.25 inches. No reinforcement exposure through crack. Barrier acceptable with repair.</p>  |

| Example | Image and Description  |
|---------|--|
| E-5     |  <p data-bbox="479 974 1414 1045">Crack width measuring less than 0.25 inches. No reinforcement exposure through crack. Barrier acceptable with repair.</p>    |
| E-6     |  <p data-bbox="479 1501 1414 1572">Crack width measuring less than 0.25 inches. No reinforcement exposure through crack. Barrier acceptable with repair.</p> |

| Example | Image and Description  |
|---------|--|
| E-7     |  <p data-bbox="479 850 1416 919">Crack width measuring less than 0.25 inches. No reinforcement exposure through crack. Barrier acceptable with repair.</p> |

**Table 9.6. Cracking—Unacceptable Barriers.**

| <b>Example</b> | <b>Image and Description</b>   |
|----------------|--|
| F-1            |  <p data-bbox="529 919 1365 989">One crack with measured width exceeding 0.25 inches. Barrier is unacceptable and needs to be discarded.</p>   |
| F-2            |  <p data-bbox="488 1465 1403 1566">Multiple cracks with measured summed widths greater than 0.25 inches within 1 ft of longitudinal barrier length. Barrier is unacceptable and needs to be discarded.</p> |

| Example                                  | Image and Description  |
|--|--|
| <p data-bbox="300 562 349 594">F-3</p>   |  <p data-bbox="488 850 1403 919">Multiple cracks with measured widths exceeding 0.25 inches. Barrier is unacceptable and needs to be discarded.</p>    |
| <p data-bbox="300 1199 349 1230">F-4</p> |  <p data-bbox="488 1430 1403 1499">Multiple cracks with measured widths exceeding 0.25 inches. Barrier is unacceptable and needs to be discarded.</p> |



### 9.1.3 Segment Connections

The following section discusses evaluation guidance of concrete barriers based on type of connection segment. There are four portable concrete barrier segment connection types currently in use by TxDOT: JJ hooks, quick bolts, connection bolts for portable low-profile barrier segments, and X-bolts.

#### 9.1.3.1 Segment Connection—JJ Hooks

A PCB segment is acceptable if, at both segment ends, the JJ hook connection:

1. Does not present signs of cracking or corrosion.
2. Presents a bent, rotated, or deformed hook within acceptable values.

When a JJ hook connection (or its plate) presents corrosion, a crack (of any width), or a combination of both, that connection is considered unacceptable, and the barrier segment needs to be discarded.

The maximum acceptable rotation of a JJ hook connection is 20 degrees. Any JJ hook connection rotated more than 20 degrees is considered unacceptable, and the barrier segment needs to be discarded.

Moreover, the maximum acceptable value of the hook opening of the connection is 0.1 inches. Therefore, if a connection presents a hook with a deformed opening of more than 0.1 inches, it is considered unacceptable, and the barrier segment needs to be discarded.

There are numerous ways to quantify the rotation of the hook. One method uses a ruler and protractor, as shown in Figure 9.3. Another method uses geometrical measurement, as shown in Figure 9.4, and for which the geometrical expressions are reported below:

$$d1 = \text{distance of undeformed JJ hook from arbitrary reference line} \quad (1)$$

$$d2 = \text{distance of deformed JJ hook from arbitrary reference line} \quad (2)$$

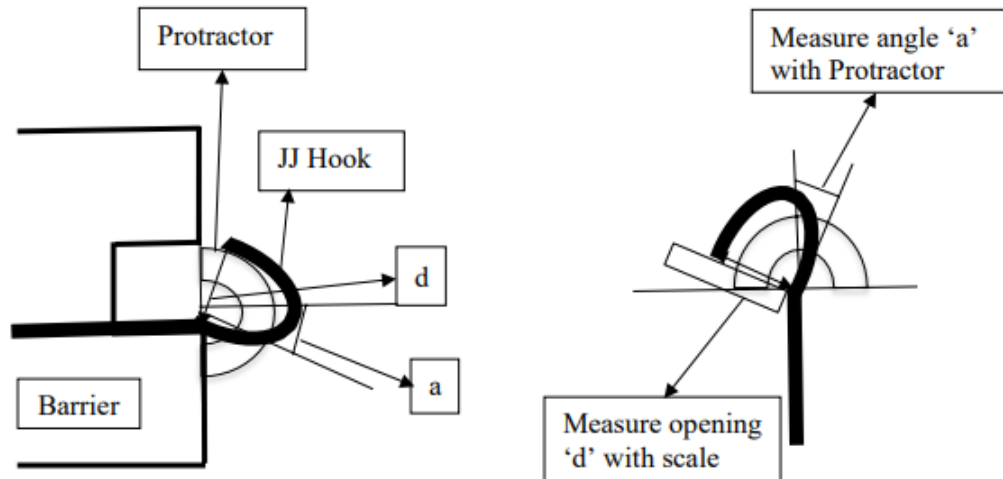
$$R = \text{radius of JJ hook} \quad (3)$$

$$\text{Theta} = \text{angular deformation of JJ hook} \quad (4)$$

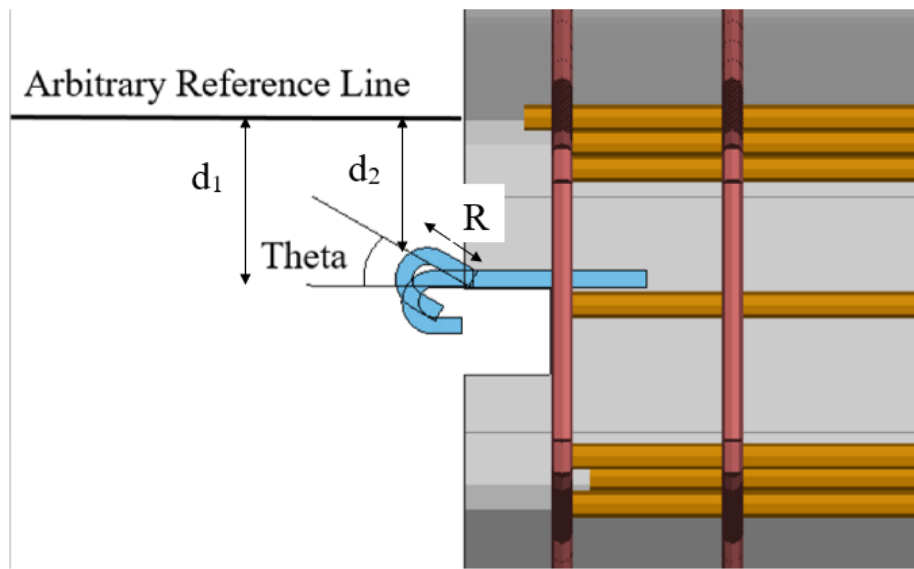
$$\text{Arc} = |d1 - d2| \quad (5)$$

$$\text{Theta} = \frac{\text{Arc}}{\text{Radius}} \quad (6)$$

The width of the JJ hook gap can be measured with a ruler. Bending/rotation in the hook can be gauged by measuring the angle “a” with a protractor.



**Figure 9.3. Quantification of the Rotation of the JJ Hook Using a Ruler and Protractor.**



**Figure 9.4. Measurement of JJ Hook Rotation Using Geometry.**

Figure 9.5 summarizes the proposed evaluation criteria for acceptability of portable barriers using JJ hook segment connections.

Table 9.7 and Table 9.8 provide a visual guideline of examples for acceptable and unacceptable PCB systems based on the failure mode status of the JJ hook segment connections.

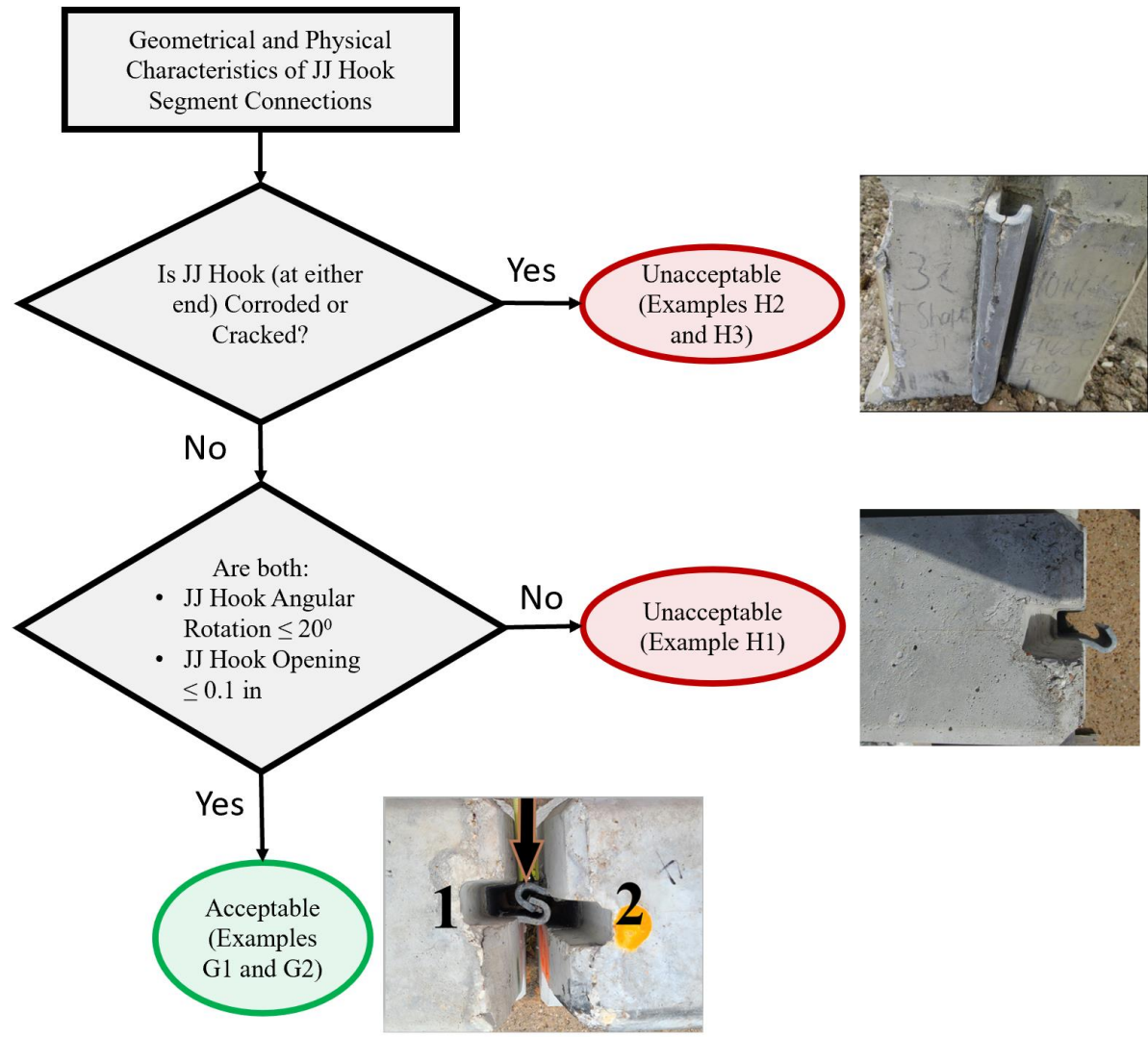


Figure 9.5. JJ Hook Connections—Evaluation Criteria Flowchart.

### **9.1.3.2 Segment Connection—Quick Bolts**

A PCB segment is acceptable if, at both segment ends, the quick bolt connection:

1. Does not present signs of cracking or corrosion in any component of the bolt.
2. Does not have any missing, twisted, or cracked bolts or nuts.

When a quick bolt connection presents corrosion, a crack (of any width), or a combination of both, that connection is considered unacceptable, and the barrier segment needs to be discarded.

### **9.1.3.3 Segment Connection—Connection Bolts (Low-Profile Barriers)**

A PCB segment is acceptable if, at both segment ends, the connection bolt:

1. Does not present signs of cracking or corrosion in any component of the bolt.
2. Does not have any missing, twisted, or cracked bolts or nuts.

When a connection bolt presents corrosion, a crack (of any width), or a combination of both, that connection is considered unacceptable, and the barrier segment needs to be discarded.

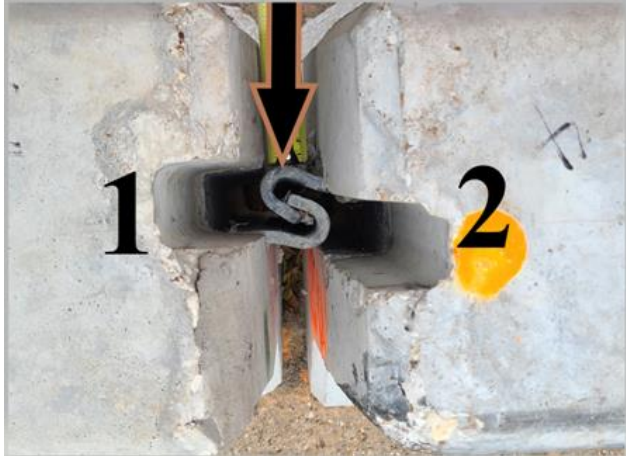

### **9.1.3.4 Segment Connection—X-Bolts**

A PCB segment is acceptable if, at both segment ends, the X-bolt connection:



1. Does not present signs of cracking or material loss due to corrosion in any component of the bolt.
2. Does not have any missing component that affects the performance or installation of the bolts.


When an X-bolt connection presents corrosion, a crack (of any width), or a combination of both, that connection is considered unacceptable, and the bolts must be replaced for the barrier.

**Table 9.7. JJ Hook Segment Connections—Acceptable Barriers.**

| Example    | Image and Description  |
|------------|--|
| <p>G-1</p> |  <p>JJ hooks are not corroded or cracked. Each JJ hook's angular rotation measures less than 20 degrees, and each opening measures less than 1 inch. Both barrier segments with these JJ hooks are acceptable.</p> |
| <p>G-2</p> |  <p>JJ hook is not corroded or cracked. JJ hook's angular rotation measures less than 20 degrees, and the opening measures less than 1 inch. JJ hook is acceptable.</p>   |

**Table 9.8. JJ Hook Segment Connections—Unacceptable Barriers.**

| Example | Image and Description   |
|---------|---|
| H-1     |  <p data-bbox="521 816 1373 884">JJ hook angular rotation measures more than 20 degrees. Barrier is unacceptable and needs to be discarded.</p> |
| H-2     |  <p data-bbox="524 1463 1370 1528">JJ hook presents cracking. Barrier is unacceptable and needs to be discarded.</p>                           |

| Example | Image and Description  |
|---------|--|
| H-3     |  <p data-bbox="505 909 1386 945">JJ hook is broken. Barrier is unacceptable and needs to be discarded.</p> |



## **9.2 REPAIR GUIDELINES**

The guidelines in this section have been drafted for repairing concrete-related defects, namely spalls and cracks.

### **9.2.1 Spall Repair**

#### **9.2.1.1 Repair Materials**

The contractor can use any prepackaged, fast-setting, DOT-approved concrete product to repair minor spalls. Manufacturers have different specifications and procedures for different variations of spalls or concrete erosion-related issues, namely missing corners, thin repair, aesthetic repair, and broken edges. The specific method statement with the exact ratios and quantities to be used should be that recommended by the selected manufacturer. However, the next section describes the general repair methodology.

#### **9.2.1.2 Repair Procedure**

The following is the general repair procedure for spalls:

1. Clean the surface of the damaged area that needs repair by removing any loose material such as dirt, oil, grease, and unsound or flaking concrete.
2. Scrub and clean the surface of the area to be repaired with a stiff bristle brush.
3. Thoroughly rinse the repair area after cleaning.
4. Select a TxDOT-approved manufacturer of fast-setting repair material. Follow the specific method statement issued by the manufacturer to prepare the mixture or use a premixed combination of repair material and a liquid base to apply on the damage area.
5. Achieve the desired consistency of this mixture according to the method statement issued by the manufacturer. Apply the mixture on the dampened damaged area according to the method statement.
6. Level and match the rectifying layer with the surrounding concrete.

### **9.2.2 Crack Repair**

According to Sections 5, 6, and 7 of the 2021 TxDOT *Concrete Repair Manual* (52), cracks can be repaired using a pressure-injected epoxy, gravity-fed sealant, and surface sealant. Although a pressure-injected epoxy and gravity-fed sealant can restore the capacity of the cracked section, a surface sealant only seals the cracks at the outer surface of the concrete to prevent the infiltration of water, chlorides, and other contaminants. Therefore, it is not advisable to use the surface sealing technique where a significant crack displacement is anticipated. However, a surface sealant can be used to close hairline cracks (nonstructural) to keep contaminants from reaching the reinforcement surface.

Injecting epoxy resin is the best technique for filling cracks on a vertical surface such as a barrier wall. Injection of epoxy resin can seal cracks as fine as 0.002 inches (0.05 mm) in width. Using an epoxy resin of low viscosity (less than 20 poise) enables the resin to penetrate the full depth of the crack at working pressure.

To inject epoxy, entry ports must be installed. For small jobs, to avoid the installation of fittings, short gaps can be left at regular intervals in the seal over the crack, and epoxy resin can be injected using a caulking gun. The spacing between the entry ports or gaps should be sufficient to ensure that liquid injected into one port flows through the full thickness of the member before flowing out of the next port or gap. In the process of sealing vertical cracks, the operator injects epoxy into the lowest port until it oozes out of the port above. The operator then seals off the lower port or gap, starts injection into the next port or gap, and continues until all cracks are filled. The fittings, if installed, are removed when the adhesive is cured.

The epoxy used should be able to develop 1400 psi strength in 14 days and be used at a temperature less than 40°F or between 40°F and 60°F. Epoxy has a grease-like, non-sagging consistency and bonds even with moist concrete. When the adhesive used to bond the entry ports and seal the crack has hardened, epoxy grout is mixed and injected (53).

### 9.2.2.1 Repair Materials

According to Section 5 of the 2021 TxDOT *Concrete Repair Manual* (52), crack repair materials are specified according to their designated purposes, as follows:

- **Structural repair:** Material selected for repair shall meet the requirements given in DMS 6110—Quality Monitoring Program for Epoxies and Adhesives. The Material Producer List (MPL) provides names of prequalified producers of epoxies and adhesives (Type II–X) that can be used for repairing cracks. Repairs and materials to be used are as follows:
  - **Injecting cracks:** TxDOT Type IX low-viscosity epoxy resin (ASTM C 881 Type IV, Grade 1), which typically consists of two liquid components that are combined automatically during the pressure injection process.
  - **Sealing the surface of cracks:** TxDOT Type V or VII concrete epoxy adhesive.
- **Nonstructural repair:** Repairs and materials to be used are as follows:
  - **Routing and sealing cracks:** Preapproved Class 4 low-modulus silicone that meets the requirements of DMS 6310 (Joints Sealants and Fillers) or Type V adhesive that meets the requirements of DMS 6100 (Epoxies and Adhesives) as specified in the plans (52).
  - **Sealing the surface of cracks:** Preapproved Type VIII or Type X epoxy that meets the requirements of DMS 6100 (Epoxies and Adhesives) (52).

### 9.2.2.2 Repair Procedure

#### 9.2.2.2.1 Epoxy Injection for Structural Cracks

The following is the procedure to inject epoxy into structural cracks:

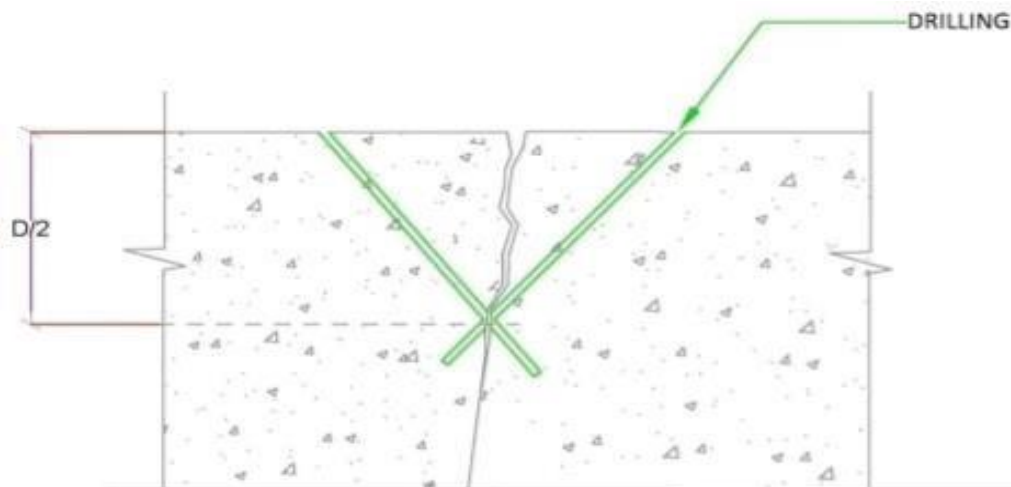
1. Depending on the size of the job and the manufacturer's specifications, drill holes at appropriate intervals to permit installation of the injection ports (Figure 9.6) or mount the ports on the surface.
2. Clean the interior of the vertical cracks from bottom to top and remove all the loose materials entrapped in the cracks.

- a. If compressed air is used to remove the loose materials from the cracks, ensure that the debris is not forced deeper into the crack.
- b. Consult the engineer if it appears that debris in the crack hinders proper injection of the epoxy resin.



**Figure 9.6. Drilling Holes in the Concrete Member (54).**

- c. If debris is only near the surface, drill holes for the injection ports away from the exposed portion of the crack. The holes are to be drilled at an angle such that the injection ports intersect the crack beneath the surface away from the dust and debris (Figure 9.7).



**Figure 9.7. Section Showing Holes Drilled at an Angle (54).**

3. After drilling, remove contaminants such as laitance, oil, dust, debris, and other foreign particles where the surface seal will be applied.
4. Unless the manufacturer or engineer mentions it, do not grind the concrete around the crack to remove contaminants or provide a V-shaped groove along the crack.
  - a. Grinding can force dust into the crack and consequently hinder proper flow of the epoxy resin.
  - b. If a V-shaped groove is cut along the crack, carefully remove the dust using compressed air and/or high-pressure water blasting. Do not commence with surface sealer application or injection work until the crack and concrete surface have dried.
5. As directed in the method statement issued by the manufacturer, mix the epoxy surface sealer. Use portable injection equipment capable of automatically mixing the liquid components at the proper proportion during the pressure injection operation.
6. Depending on the size of the job and the manufacturer's instructions given in the method statement, either install the injection ports (Figure 9.8) or leave short gaps at appropriate intervals. If installing ports:
  - a. Place the ports directly on the crack or in drilled holes that intersect the crack.
  - b. Install the injection ports at appropriate intervals along the crack.
    - i. The port spacing should not exceed the depth of the crack. If the depth of the crack is not known, space the ports as recommended by the resin manufacturer.
    - ii. If the crack projects through the entire concrete section, the intervals between ports should not exceed the section depth.
  - c. Ensure that the ports are placed in locations where the crack is not too narrow or clogged with debris to permit adequate flow of epoxy resin.



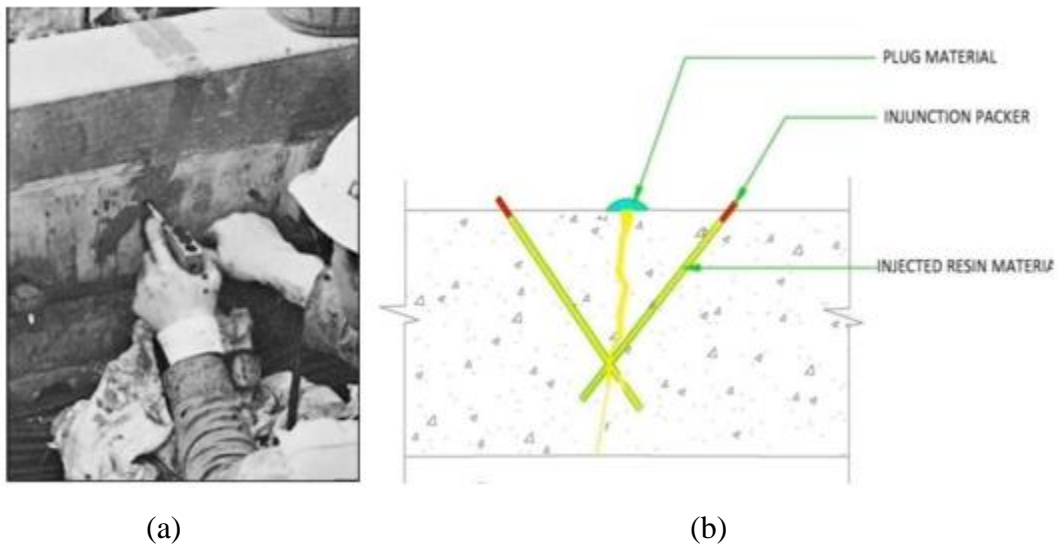
**Figure 9.8. Installing Injection Ports (54).**

- d. Anchor the injection ports, if used, and seal the surface of the crack between ports or gaps using a sealer as required by the resin manufacturer.
- e. Allow sufficient time for the sealer to cure before commencing the resin injection. The sealer must have adequate strength to hold the injection ports in place and withstand the pressure along the crack during the injection operations.

- f. Apply sealer over the crack surface on the back side if the crack extends completely through the concrete section.
- g. Begin pressure-injecting the epoxy resin into the crack through the ports (Figure 9.9).
- h. Use a positive displacement pump, air- or hand-actuated caulking gun, or paint pressure pot as recommended by the epoxy resin manufacturer and approved by the engineer. For small jobs where fittings are not installed, use the caulking gun to inject the epoxy resin into the cracks (Figure 9.10a).
- i. On a vertical surface, start injecting at the lowest port and work upward.

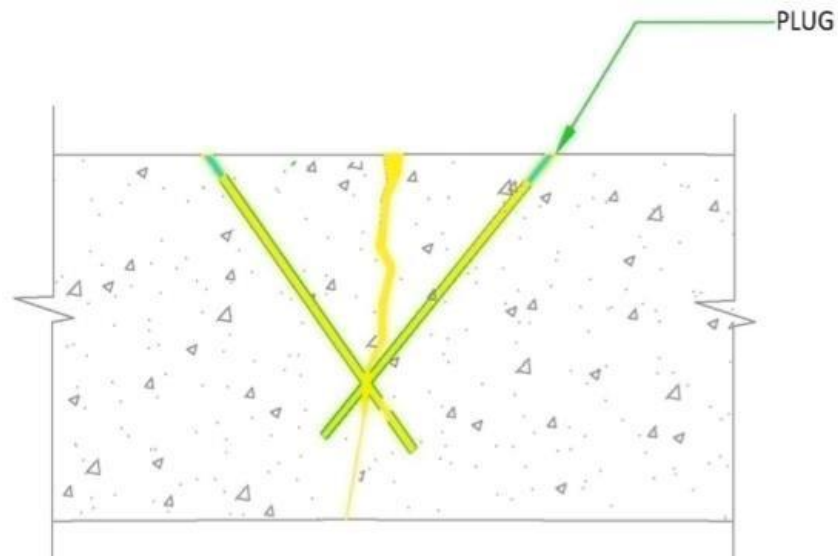


**Figure 9.9. Injection of Epoxy Resin into the Holes (54).**



**Figure 9.10. Injection of Epoxy: (a) Using a Gun That Does Not Require Fittings to Be Bonded to the Concrete Surface; (b) Section Showing Drilled Holes and a Crack Filled with Repair Material (54).**

- j. Maintain adequate pressure until resin emerges from the adjacent port.
  - i. If resin does not emerge from the adjacent port, stop the work and reevaluate the crack.
  - ii. Ports may need to be placed more closely together or debris cleared from under the existing ports.
  - iii. Ports should be installed at an angle so they intersect the crack at a deeper point if debris is clogging the crack near the concrete surface. Inadequate flow of the epoxy resin may be a sign that the crack is either too shallow or too narrow for pressure injection to serve its purpose.
- k. If the epoxy begins to flow out of a nonadjacent port or gap, temporarily plug that port or gap until the epoxy begins to flow out of the adjacent port or gap. Figure 9.10b shows a cracked section filled with the resin material injected through the ports.
- l. Once the resin appears in an adjacent port, remove the injection nozzle and seal the port.
- m. Move the equipment to the next adjacent port and proceed with the epoxy resin pressure injection.
- n. Remove the injection ports and surface sealer after the epoxy resin has been given adequate time to cure (Figure 9.11). Resin material should not flow from the crack after the surface sealer is removed.



**Figure 9.11. Removal of Surface Sealer and Installation Ports after the Resin Cures (54).**

- 7. Grind away any epoxy resin or surface sealer residue that is left on the concrete surface after the injected material has had sufficient time to cure.

#### **9.2.2.2.2 Routing and Sealing Cracks and Surface Sealing for Nonstructural Cracks**

Routing and sealing can be used where a small amount of movement is anticipated due to service loads, thermal effects, or other causes.

The following is the procedure to route and seal nonstructural cracks:

1. Route the crack using a grinder to create a V-shaped groove, with the crack centered in the groove. Grooves are typically about  $\frac{3}{8}$  inches deep.
2. Ensure that the substrates are clean and sound by removing contaminants, including laitance, oil, dust, debris, and other foreign particles.
3. Fill the groove using a preapproved Class 4 low-modulus silicone that meets the requirements of DMS 6310 (Joints Sealants and Fillers) or Type V adhesive that meets the requirements of DMS 6100 (Epoxies and Adhesives) as specified in the plans (52).

The following is the procedure to seal the surface:

1. Apply an adhesive directly over the crack to prevent the infiltration of contaminants. Use a preapproved Type VIII or Type X epoxy that meets the requirements of DMS 6100 (Epoxies and Adhesives).
2. Work the epoxy into the crack.
3. Remove any excess epoxy from the surface before it sets (52).



## 10. SUMMARY AND CONCLUSIONS

Portable concrete barriers are roadway safety hardware designed to protect workers in construction zones from traffic. A PCB assembly contains and redirects vehicles during accidents and prevents vehicles from entering a construction zone while also protecting drivers. PCBs are made of precast shaped sections (e.g., F-shape, single slope, and low profile) joined together with appropriate connections to form a continuous longitudinal barrier.

Defining the service life of PCBs is important to reduce the risk of inferior, unsafe barriers being used on Texas roadways. The *MASH* implementation agreement allows state transportation agencies to continue the use of PCBs manufactured on or before December 31, 2019, and successfully tested to standards in NCHRP Report 350 or the 2009 edition of *MASH* throughout their normal service life. Damage to the precast barriers can occur in transit, in storage, or due to vehicular impact. When damage to the connections occurs, cracks, broken corners, and many other forms of damage can be sustained by the barrier. No federal guidance, however, has been developed to determine life expectancy for PCBs. Thus, a need exists to develop guidelines addressing the type and extent of barrier damage that constitute replacement of the segment. Continuing to use severely damaged barriers and not replacing them in a timely manner can pose a safety risk, while replacing them too early underestimates their design life and creates an economic burden on state DOTs.

To help meet this need, the research team documented best practices with respect to repairing or replacing PCB segments and utilized a combination of engineering evaluation, dynamic component testing, and full-scale crash testing to develop guidelines to assist in designing a process to determine useful service life.

State DOTs and TxDOT districts were asked to share information regarding their agency's inspection, evaluation, and repair guidance regarding acceptability of PCB segments.

The researchers then constructed test installations for PCBs and conducted bogie tests on these installations to assess the baseline strength/deflection capacities of new barrier segments as well as the corresponding residual capacities of damaged barrier segments. The dynamic component testing helped researchers understand and relate the quantitative and qualitative characteristics of post-impact damages seen in barriers (e.g., cracks, spalls, exposure of rebar, deformation of connections, etc.), as well as the resulting values of barrier deflections.

Computer simulations were conducted to study the crashworthiness behavior of identified full-scale barrier systems (specifically with induced failure modes) under *MASH* TL-3 impact conditions through an engineering analysis. Simulations indicated that the maximum spall of 13 inches (height) by 4 inches (width) by 2 inches (depth) did not alter the crashworthiness of the single-slope and F-shape barriers when impacted under *MASH* TL-3 conditions. Simulations that were conducted with the various deformation levels in the F-shape barrier indicated that the maximum JJ hook deformation considered by the researchers did not have a detrimental effect on the crashworthiness of the barrier system.

The researchers recommended conducting full-scale crash testing to verify the results recorded in the FEA simulations and provide useful information to draft PCB segment acceptability due to

various failure modes. The full-scale crash tests assessed the performance of TxDOT's damaged portable concrete barriers according to the safety-performance evaluation guidelines included in *MASH* (47). The full-scale crash test results indicated that the tested barrier installations exhibited crashworthy behavior, even considering the pre-damaged segments and connections utilized in the system. Therefore, those barrier and connection damages were deemed to be acceptable per *MASH* Test 3-11 testing and evaluation criteria. Since the F-shape segment evaluation was deemed more critical than the single-slope PCB segment for reasons discussed in Chapter 8, it was also concluded that 42-inch single-slope barrier segments would be deemed crashworthy per *MASH* Test 3-11 when considering the same type and level of barrier (spall and cracking) and segment connection damages.

Guidelines were then proposed for the use and repair of portable concrete barriers. They were developed using the results from previous project tasks involving the literature review, surveys, computer analysis, and component and full-scale testing. The guidance discusses the different criteria to classify PCBs into three categories:

- Acceptable.
- Acceptable with repair.
- Unacceptable.

Examples of acceptable, acceptable with repair, and unacceptable barriers are illustrated in the guidance to assist the engineer in charge with categorizing PCBs. A PCB can be classified as unacceptable if it meets at least one of the proposed unacceptable conditions. These guidelines aim to help the engineer in charge determine if the PCB is appropriate to use at several work stages, such as upon delivery to the project site, during initial setup, during phase changes, and periodically throughout the duration of the project. The guidelines require the engineer to thoroughly assess the condition of the concrete surface and need for reinforcement; match the findings with the expectations of acceptability, repairability, and unacceptability illustrated in the guidance; and accordingly classify the PCB as acceptable, acceptable with repair, or unacceptable.

## 11. IMPLEMENTATION

Guidelines were proposed for the use and repair of portable concrete barriers. These guidelines were developed using the results from previous project tasks involving the literature review, surveys, computer analysis, and component and full-scale testing. The guidance discusses the different criteria to classify PCBs into three categories:

- Acceptable.
- Acceptable with repair.
- Unacceptable.

Examples of acceptable, acceptable with repair, and unacceptable barriers are illustrated in the guidance to assist the engineer in charge with categorizing PCBs. A PCB can be classified as unacceptable if it meets at least one of the proposed unacceptable conditions. These guidelines aim to help the engineer in charge determine if the PCB is appropriate to use at several work stages, such as upon delivery to the project site, during initial setup, during phase changes, and periodically throughout the duration of the project. The guidelines require the engineer to thoroughly assess the condition of the concrete surface and reinforcement; match the findings with the expectations of acceptability, repairability, and unacceptability illustrated in the guidance; and accordingly classify the PCB as acceptable, acceptable with repair, or unacceptable.

The researchers conducted full-scale crash testing to verify the results recorded in the FEA simulations and to provide useful information to determine PCB segment acceptability due to various failure modes. The full-scale crash tests assessed the performance of TxDOT's damaged portable concrete barriers according to the safety-performance evaluation guidelines included in *MASH (47)*. For both tests, the barrier segments were specifically selected based on their existing damage modes, which included concrete spalling, concrete cracks, and segment connection deformations.

Each installation consisted of seven 30-ft long, 32-inch tall F-shape barriers connected end to end with JJ hook connections, for a total length of 210 ft 6 inches. For both tests, the barrier segments were specifically selected based on their existing damage modes, which included concrete spalling, concrete cracks, and segment connection deformations. Specifically, test installation for Test No. 440592-1 included a barrier segment (segment 3) that presented a crack originating from the barrier scupper corner, measuring 6 mm (0.24 inches) at its maximum width. In addition, barrier segment 3 presented deformed JJ hook connections at the joint with barrier segment 4. As for the test installation for Test No. 440592-2, the JJ hook connections of barrier segment 3 at the joint with barrier segment 4 were deformed. Moreover, there was concrete spalling measuring 3¾ inches wide by 13 inches high by 2 inches deep at both barrier segment toes at the joint between segments 3 and 4.

The full-scale crash test results indicated that the tested barrier installations exhibited crashworthy behavior, even when considering the pre-damaged segments and connections utilized in the system. Therefore, those barrier and connection damages were deemed to be acceptable per *MASH* Test 3-11 testing and evaluation criteria. Since the F-shape segment evaluation was deemed more critical than the single-slope PCB segment, it was also concluded

that the 42-inch single-slope barrier segments would be deemed crashworthy per *MASH* Test 3-11 when considering the same type and level of barrier (spall and cracking) and segment connection damages.

Inspection of PCBs should be done at several stages during a project: upon delivery to the site, during the initial setup, during phase changes, and periodically throughout the duration of the project. Inspection should involve checking for any damage in the form of concrete spalls, erosion, cracks, rebar exposure, or connection deformation. If unacceptable damages are observed, the inspector should direct the staff to remove the damaged barrier from service. Depending on the severity of the damage observed, the inspector should request either repair to the barrier before moving it back into service or replacement with a new barrier. The decision to repair or replace depends on various factors, such as cost, durability of repair, extension of service life with respect to each of the alternatives, and more.

In accordance with the scope of TxDOT Project 0-7059, Develop Guidelines for Inspection, Repair, and Use of Portable Concrete Barriers, the research team has prepared an estimate for the value of research (VoR) associated with the research products delivered for this project. The benefit areas deemed relevant and identified in the project agreement for the purpose of establishing the VoR encompass both qualitative and economic areas. Information regarding the VoR is contained in Appendix B of this report.

## REFERENCES

1. Dobrovolsky, Chiara Silvestri, Shi, Shengyi, Brennan, Andrew, Bligh, Roger, Sheikh, Nauman, *Synthesis of the Performance of Portable Concrete Barrier Systems*, National Cooperative Highway Research Program, Transportation Research Board of The National Academies of Sciences, Engineering, and Medicine, March 2019.  
<http://onlinepubs.trb.org/onlinepubs/nchrp/docs/NCHRP22-36DraftReport-2019-03-08.pdf>
2. Concrete Spalling—Expert Article, Robson Forensic, August 17, 2018, Accessed May 28, 2021. <https://www.robsonforensic.com/articles/concrete-spalling-expert-article?msclkid=1e10f675d07e11ec80bce81eed59142f>
3. Finishing Air-Entrained Concrete, PCA, Accessed May 28, 2021.  
<https://www.cement.org/learn/concrete-technology/concrete-construction/finishing-air-entrained-concrete?msclkid=5e3008fbd07e11eca11c2c1edc86feb9>
4. What Happens If Concrete Is Not Cured Properly, Civil Site Visit, Accessed May 28, 2021.  
<https://civilsitevisit.com/what-happens-if-concrete-is-not-cured-properly/>
5. Scaling Concrete Surfaces—What, Why & How, Nevada Ready Mix, Accessed May 28, 2021. <https://www.nevadareadymix.com/concrete-tips/scaling-concrete-surfaces/?msclkid=7fac07c4d07e11ec9f8a74e599cc2dda>
6. Khoury, Gabriel, Effect of Fire on Concrete and Concrete Structures, *Progress in Structural Engineering and Materials*, Vol. 2, 2000, pp. 429–447.
7. Concrete Surface Prep Part 1: Unsound Concrete, Graco Contractor, Accessed May 28, 2021.  
<https://www.graco.com/us/en/contractor/solutions/articles/concrete-surface-prep-part-1-unsound-concrete.html?msclkid=044d2348d07f11ec97037c9c43c0bfde>
8. Temporary Barrier Guidelines—Cracked Sections, New York State Department of Transportation, Accessed May 28, 2021.  
[https://www.dot.ny.gov/divisions/engineering/design/dqab/tcbacceptability/cracked\\_sections](https://www.dot.ny.gov/divisions/engineering/design/dqab/tcbacceptability/cracked_sections)
9. Cracking in Concrete, American Concrete Institute, Accessed May 28, 2021.  
<https://www.concrete.org/topicsinconcrete/topicdetail/Cracking%20in%20Concrete?search%20h=Cracking%20in%20Concrete&search=Cracking%20in%20Concrete>
10. Temporary Barrier Guidelines—Longitudinal Cracks, New York State Department of Transportation, Accessed May 28, 2021.  
[https://www.dot.ny.gov/divisions/engineering/design/dqab/tcbacceptability/longitudinal\\_cracks](https://www.dot.ny.gov/divisions/engineering/design/dqab/tcbacceptability/longitudinal_cracks)
11. Evaluating Cracking in Concrete: Procedures, Giatec Scientific Inc., Accessed May 28, 2021.  
<https://www.giatecscientific.com/education/cracking-in-concrete-procedures/>
12. Jersey Interlocking Concrete Safety/Security Barriers, External Works, Accessed May 28, 2021. <https://www.externalworksindex.co.uk/entry/115169/Elite-Precast-Concrete/Jersey-interlocking-concrete-safety-security-barriers/>
13. Kenco Barrier Lift, Kenco, Accessed May 28, 2021. <https://kenco.com/products/barrier-lift/>
14. Concrete Barrier Save Lives, Eagle West Cranes, Accessed May 28, 2021.  
<https://www.eaglewestcranes.com/concrete-barriers-save-lives/>

15. Kenco Double Barrier Lifter, DTS, Accessed July 12, 2022.  
<https://www.diamondtoolstore.com/products/kenco-double-barrier-lifter>
16. Nmai, Charles, Bury, Mark, Daczko, Joseph, Shrinkage of Concrete: Minimizing/Eliminating the Potential for Cracking, Tilt-Up Today, Accessed May 28, 2021. <https://tilt-up.org/tilt-up-today/2018/01/27/shrinkage-of-concrete-minimizing-eliminating-the-potential-for-cracking/?msclkid=9f17b595d07f11ec965a4d481ae70bcf>
17. Drying Shrinkage Cracks, Concrete @ Your Fingertips, Accessed May 28, 2021.  
<https://www.concrete.org.uk/fingertips-nuggets.asp?cmd=display&id=512>
18. What Is Shrinkage Cracks in Concrete? Types and Causes of Shrinkage Cracks, The Constructor Building Ideas, Accessed May 28, 2021.  
<https://theconstructor.org/concrete/shrinkage-cracks-in-concrete-types-causes/9016/>
19. Defects in Concrete Structures—With Focus on Identifying Concrete Cracks & How to Fix Them, Waterstop Solutions, Accessed May 28, 2021. <https://i0ofe3upsk2sa8dc3agqgsnewpengine.netdna-ssl.com/wp-content/uploads/2019/06/7-types-of-cracks-why-they-occur-their-impact-how-to-fix-them-Waterstop-Solutions.pdf?msclkid=df7cfefad07f11eca64bfacdf4f3667e>
20. Desai, Mahadev, 8 Basic Causes of Cracks in House, Accessed June 28, 2022.  
<https://gharpedia.com/blog/causes-of-cracks-in-house/>
21. Boullenois, Eric, Why Does Concrete Crack? Part 2—The Impact of Cracks, Master Builders Solutions, Accessed May 28, 2021. <https://blog.master-builders-solutions.com/en/the-impact-of-cracks?msclkid=2788b81bd08011ecb98a3e3b292d4c33>
22. Cracks Due to Reinforcement Corrosion, Concrete @ Your Fingertips, Accessed May 28, 2021. <http://www.concrete.org.uk/fingertips-nuggets.asp?cmd=display&id=192>
23. Wight, James K., MacGregor, James G., *Reinforced Concrete—Mechanics and Design*, Fifth Edition, 2008.
24. Temporary Barrier Guidelines—Deflection Concerns, New York State Department of Transportation, Accessed May 28, 2021.  
[https://www.dot.ny.gov/divisions/engineering/design/dqab/tcbacceptability/deflection\\_concerns](https://www.dot.ny.gov/divisions/engineering/design/dqab/tcbacceptability/deflection_concerns)
25. Sideris, Petros, Lecture Part 4: Inelastic Material Response, Lecture notes from Advanced Mechanics of Materials, CVEN 633, Texas A&M University, Delivered Oct. 14, 2020.
26. Why JJ Hook Barrier, Concrete Safety Systems—JJ Hooks Concrete Barrier Rental, Accessed May 28, 2021. <https://concretesafetysystems.com/why-j-j-hooks-barrier/>
27. NYSDOT, Acceptance Criteria for Damaged Temporary Concrete Barrier (TCB), Accessed Feb. 20, 2020. <https://www.dot.ny.gov/divisions/engineering/design/dqab/tcbacceptability>
28. Illinois Tollway, Quality Standard for Temporary Concrete Barrier, The Illinois State Toll Highway Authority, Downers Grove, Illinois, 2014.
29. ATSSA, *Quality Guidelines for Temporary Traffic Control Devices and Features*, American Traffic Safety Services Association, Washington, DC, 2017.

30. NZTA, *Specification for Road Safety Hardware Systems* (Appendix C: Temporary Road Safety Barrier Systems), New Zealand Transport Agency, Wellington, New Zealand, 2017.
31. FDOT, *FDOT Evaluation Guide—Temporary Concrete Barrier*, Florida Department of Transportation, Tallahassee, Florida, 2019.
32. KDOT, *Guidelines for Temporary Pre-cast Concrete Safety Barrier Condition Inspection*, Kansas Department of Transportation, Topeka, Kansas, 2017.
33. ALDOT, *State of Alabama Department of Transportation Traffic Control Through Construction Work Zones*, Alabama Department of Transportation, Montgomery, Alabama, 2014.
34. IDOT, *Traffic Control Field Manual—Quality Standard for Temporary Concrete Barrier*, Illinois Department of Transportation, Springfield, Illinois, 2016.
35. INDOT, *Standard Specifications*, Indiana Department of Transportation, Indianapolis, Indiana, 2020.
36. NJDOT, *Standard Specifications for Road and Bridge Construction*, New Jersey Department of Transportation, Ewing Township, New Jersey, 2019.
37. ODOT, *Construction and Materials Specifications*, Ohio Department of Transportation, Columbus, Ohio, 2019.
38. ODOT, *Quality Standards for Temporary Traffic Control Devices and Acceptable Delineation Methods for Vehicles*, Ohio Department of Transportation, Columbus, Ohio, 2020.
39. ORDOT, *Oregon Standard Specifications for Construction*, Oregon Department of Transportation, Salem, Oregon, 2018.
40. SCDOT, *Standard Specifications for Highway Construction*, South Carolina Department of Transportation, Columbia, South Carolina, 2007.
41. VDOT, *Road and Bridge Specifications*, Virginia Department of Transportation, Richmond, Virginia, 2016.
42. WSDOT, *Standard Specifications for Road, Bridge, and Municipal Construction*, Washington State Department of Transportation, Olympia, Washington State, 2020.
43. WisDOT, *Construction and Materials Manual*, Wisconsin Department of Transportation, Madison, Wisconsin, 2019.
44. IADOT, *Standard Specifications for Highway and Bridge Construction*, Iowa Department of Transportation, Ames, Iowa, 2020.
45. TxDOT, *Standard Specifications for Construction and Maintenance of Highways, Streets, and Bridges*, Texas Department of Transportation, Austin, Texas, 2014.
46. TxDOT, *Concrete Repair Manual*, Texas Department of Transportation, Austin, Texas, 2019.
47. AASHTO, *Manual for Assessing Roadside Safety Hardware*, Second Edition, American Association of State Highway and Transportation Officials, Washington, DC, 2016.



48. U.S. Department of Transportation Federal Highway Administration, *User's Manual for LS-DYNA Concrete Material Model 159*, Publication No. FHWA-HRT-05-062, May 2007.
49. Vehicle Modeling, Center for Collision Safety and Analysis, Accessed May 28, 2021. <https://www.ccsa.gmu.edu/models>
50. Silvestri-Dobrovloni, Chiara, Schroeder, William J. L., and Kuhn, Darrell L., *Development of Guidelines for Inspection, Repair and Use of Portable Concrete Barriers—Volume 2: Crash Report*, Texas A&M Transportation Institute, College Station, Texas, 2022.
51. American Concrete Institute, *Cement and Concrete Terminology*, 2000. Accessed May 28, 2021. [http://dl.mycivil.ir/dozanani/ACI/ACI%20116R-00%20Cement%20and%20Concrete%20Terminology\\_MyCivil.ir.pdf](http://dl.mycivil.ir/dozanani/ACI/ACI%20116R-00%20Cement%20and%20Concrete%20Terminology_MyCivil.ir.pdf)
52. TxDOT, *Concrete Repair Manual*, Texas Department of Transportation, Austin, Texas, 2021.
53. Kuenning, William H., How to Repair Cracks by Grouting with Epoxy Resin, Concrete Construction, May 1, 1972. Accessed May 28, 2021. [https://www.concreteconstruction.net/how-to/materials/howto-repair-cracks-by-grouting-with-epoxy-resin\\_o](https://www.concreteconstruction.net/how-to/materials/howto-repair-cracks-by-grouting-with-epoxy-resin_o)
54. Design Consulting Services, *Concrete Repairing by Epoxy Injection*, YouTube, Oct. 8, 2020, Accessed May 28, 2021. <https://www.youtube.com/watch?v=tAYKBVW08d0>





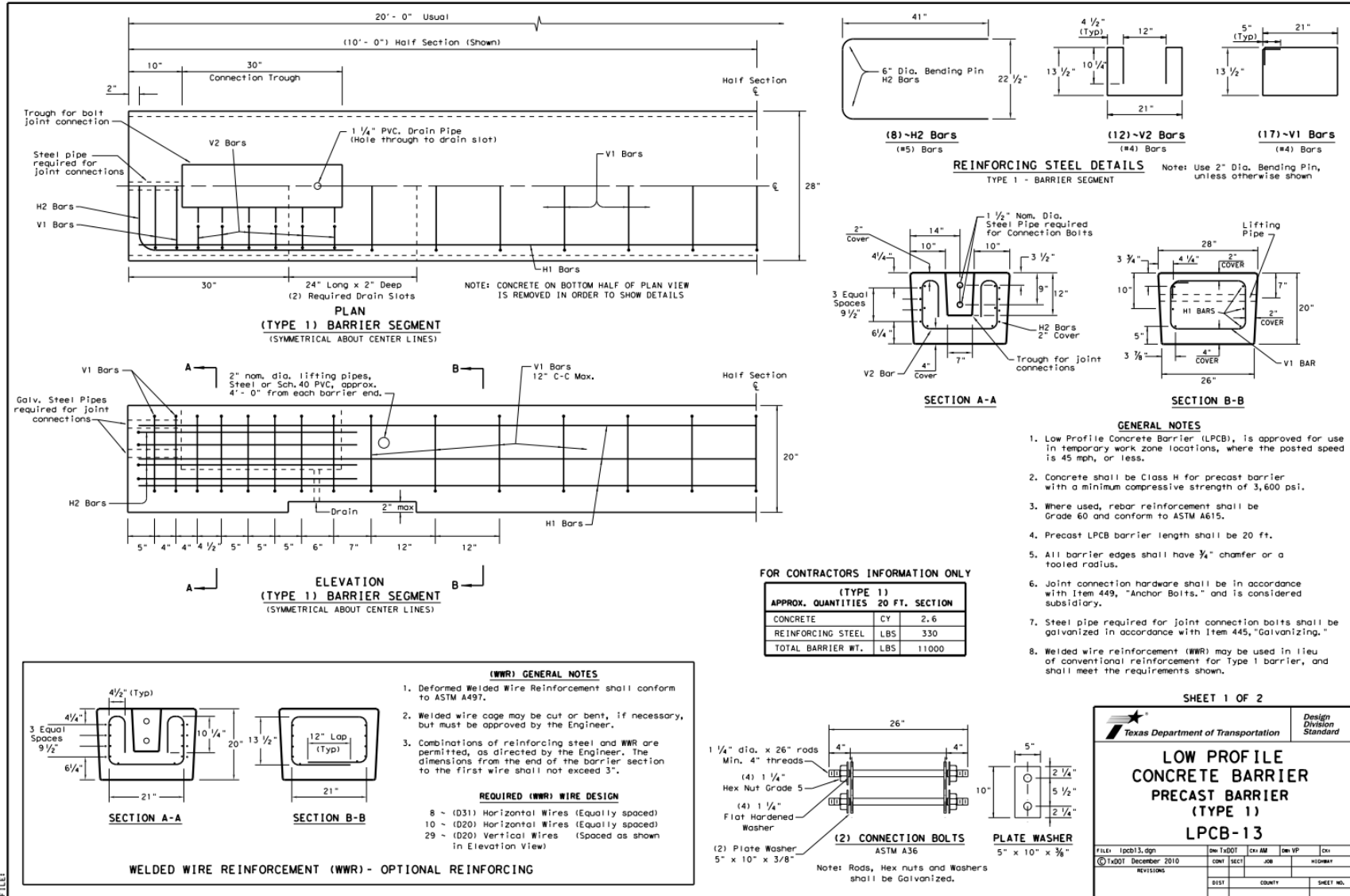


Figure A.3. Low-Profile Concrete Barrier.



## APPENDIX B. VALUE OF RESEARCH

### B.1 Introduction

In accordance with the scope of TxDOT Project 0-7059, Develop Guidelines for the Inspection, Use, and Repair of Portable Concrete Barriers, the TTI researchers prepared an estimate for the VoR associated with the research products delivered for this project.

The benefit areas deemed relevant and identified in the project agreement for the purpose of establishing the VoR encompassed both qualitative and economic areas. The benefit areas identified for this project are summarized in Table B.1.

**Table B.1. Selected Benefit Areas for Project 0-7059.**

| Selected | Benefit Area                   | Qual | Econ | Both | TxDOT | State | Both |
|----------|--------------------------------|------|------|------|-------|-------|------|
| X        | System Reliability             |      | X    |      | X     |       |      |
| X        | Increased Service Life         |      | X    |      | X     |       |      |
| X        | Infrastructure Condition       |      | X    |      |       |       | X    |
| X        | Engineering Design Improvement |      |      | X    |       |       | X    |
| X        | Safety                         |      |      | X    |       |       | X    |

### B.2 Qualitative Benefit Areas

#### B.2.1 Engineering Design Improvement

As of now, Texas does not have standardized guidelines to classify portable concrete barriers on a jobsite as acceptable and unacceptable. One of the primary outcomes of Project 0-7059 was to provide a visual guidebook to help the inspector on site assess the condition of the given portable concrete barrier. The guidebook proposes objective guidance with the help of examples that show acceptable barriers, barriers that are acceptable with repair, and unacceptable barriers. The user of the guidebook checks the condition of the concrete surface, segment connection components, and reinforcement by looking into the specific damage modes, such as spalling, cracking, corrosion of reinforcement, segment connection components, etc. The inspector then compares the level of the specific damage with the threshold given in the visual guidebook, and depending on whether the given damage level falls below or above the threshold, the inspector classifies the barrier as acceptable, acceptable with repair, or unacceptable.

#### B.2.2 Safety

Severely damaged portable concrete barriers have unknown service life. So far, there are no studies that suggest methods to estimate the remaining service life of a damaged portable concrete barrier. In the 0-7059 study, the researchers performed computer simulations and full-scale crash testing to estimate the crashworthiness of damaged portable concrete barriers and used this information to complement the existing knowledge to come up with guidance in the form of the visual guidebook. This research effort helps eliminate damaged portable concrete barriers that are no longer crashworthy and suggests repair in case of minor damages in line with the *Concrete Repair Manual* of 2021. If unacceptable barrier segments are identified and

consequently removed from service, and if minor barrier damages are repaired, chances of accidents will be reduced. Reduced rate of accidents will lead to enhanced safety of the road user and construction workers in work zones barricaded by these barriers.

### **B.3 Economic Benefits**

The VoR for this project is defined in terms of economic benefits. The economic benefit is safety related and expressed in terms of lives saved and associated societal cost averted by maintaining portable concrete barriers in a condition that meets the requirements of *MASH*. *MASH* is the current guideline for impact performance evaluation of roadside safety hardware.

The Centers for Disease Control and Prevention (CDC) estimates that the total societal cost of highway crashes in Texas is over \$5.7 billion per year. There were 12,107 serious injury crashes in Texas in 2020, with 14,656 people sustaining a serious injury. More specific to this project, single-vehicle, run-off-the-road crashes resulted in 1,354 deaths in 2020. This represents 34.75 percent of all motor vehicle traffic deaths in Texas in 2020 (1).

Roadside safety devices are implemented to mitigate the severity of roadway departure crashes. Barrier systems shield motorists from roadside hazards, thereby reducing injuries and fatalities associated with roadway departure crashes. Precast concrete barriers, which are the subject of this research, are deployed as both temporary and permanent barriers. Precast concrete barriers implemented as permanent barriers are commonly used as median barriers to separate opposing lanes of traffic and prevent head-on crashes. Less commonly, these barriers may be used along the edge of the traveled way to shield motorists from roadside hazards that include various fixed objects or non-traversable terrain.

Temporary precast concrete barriers are commonly used as a means of positive protection in work zone applications. Such work zone barriers serve the dual purpose of shielding motorists from hazards such as opposing traffic, drop offs, or work zone equipment, as well as protecting personnel in the work zone from errant vehicles. The portable nature of precast concrete barriers enables them to be readily transported, moved, and deployed as work zone operations change.

The precast concrete barrier guidelines developed under this project will affect the more severe barrier crashes that occur at or near the *MASH* design impact conditions. If a barrier has too much damage, such impacts can result in loss of vehicle containment due to barrier separation or vehicle overturn. Less severe impacts are more likely to result in vehicle containment and redirection, depending on the remaining capacity of the barrier. Thus, the focus of the economic analysis will be fatal and severe injury crashes with PCBs that can be mitigated by maintaining *MASH* compliance through adherence to the proposed guidelines.

Of particular concern is impacts with large, heavy vehicles such as pickup trucks and large sport utility vehicles (SUVs) that will impart more energy into a barrier during an impact due to their higher mass. These light truck vehicles also tend to be less stable than some other categories of vehicles. According to iSeeCars.com, Texas leads the nation in pickup truck sales volume (2). Edmunds.com reports that one in five trucks sold in the United States are sold in Texas (3). The *MASH* 2270P pickup truck is representative of the large class of light trucks, including the majority of pickup trucks and SUVs on Texas roadways.



In support of the economic safety analysis of this research, 5 years of crash data from CRIS (4) were analyzed, from 2017 through 2021. A total of 25,760 crashes were coded as “Hit Concrete Traffic Barrier.” Of these, 176 were fatal crashes and another 857 were suspected serious injury crashes. This equates to an average of 35 fatal and 171 serious injury crashes per year.

Unfortunately, the crash data are not sufficiently detailed to permit separation of the concrete barrier impacts into precast and cast-in-place barriers. However, the concrete barrier crashes were further filtered for occurrence in a construction zone. During the same 5-year time period, there were 3,946 such crashes with a concrete barrier that were flagged as occurring in a construction zone, with 19 involving a fatality and 121 resulting in a serious injury. Thus, on average, there are 4 fatal and 24 serious injury crashes with concrete barriers in work zones. It is a reasonable assumption that most if not all of these crashes were associated with a precast concrete barrier due to its predominant use as positive protection in work zones. Because a precast concrete barrier is also commonly used as a permanent barrier, these construction zone crash frequencies are considered a lower threshold for PCBs. For the purposes of this analysis, it is assumed that the number of fatal and serious injury crashes associated with impacts into a precast concrete barrier is 7 and 34 per year, respectively. These numbers represent approximately 20 percent of all concrete barrier crashes.

The Statewide Primary Procurement Unit (PPU) spreadsheet was used to provide an estimate of precast concrete barrier usage. The PPU spreadsheet indicates that over 1.5 million linear feet of precast concrete barriers was deployed as part of construction projects during the last 12-month period. Once again, this represents the lower threshold of PCB use in Texas. Additional PCBs are continually in service throughout the state as permanent barriers, primarily in urban metropolitan areas.

Much of the benefit derived from the use of barriers comes from a reduction in crash severity as opposed to crash frequency. Although a crash may still occur, it is likely to have a safer outcome than an impact with the hazard behind the barrier. Similarly, helping to ensure that a precast concrete barrier system remains *MASH* compliant through application of the proposed PCB guidelines will not reduce the number of crashes but will reduce the severity of certain crashes.

During its use, it is understood that a precast concrete barrier will sustain damage from vehicle impacts as well as handling and placement. As described in this report, that damage may be in the form of spalls, cracks, and damaged steel connection components. The guidelines developed under this research are intended to limit use of a barrier that is damaged to an extent that *MASH* impact performance and/or long-term durability may be compromised. If left in service, such damage can lead to more severe crashes than would otherwise occur if the barrier were undamaged.

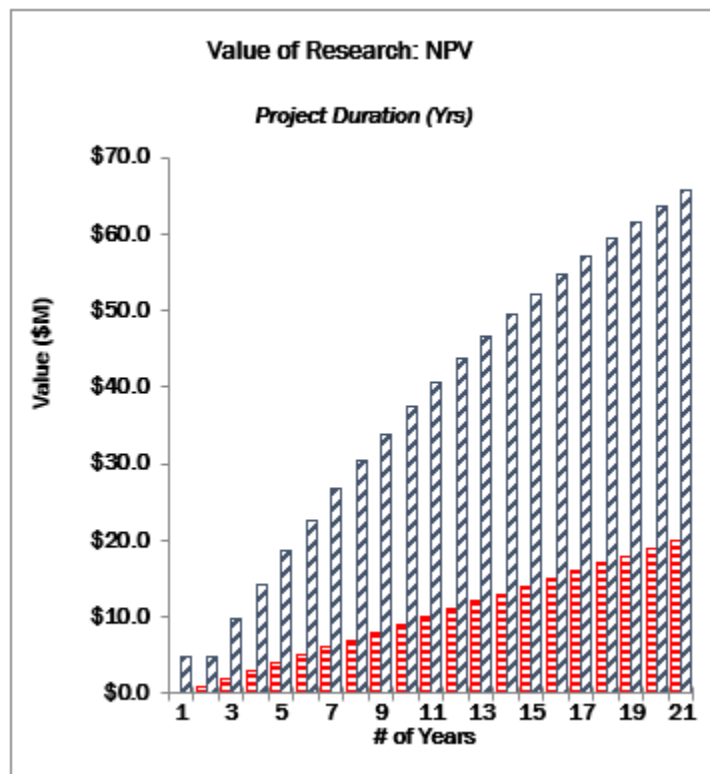
All barrier systems have finite capacity and performance capabilities. The performance limits of a barrier above and beyond the prescribed design impact conditions of *MASH* is typically not known. Impacts that exceed the *MASH* test severity can exceed the barrier capacity and/or lead to vehicle instability. Such circumstances might result from very high speeds, high impact angles, and/or larger vehicles. Therefore, some serious injury or fatal crashes can still occasionally occur even with undamaged precast concrete barrier systems. Therefore, it is conservatively estimated that adoption of the recommended PCB guidelines will improve the outcome of 20 percent of the

serious and fatal crashes associated with precast concrete barriers. Based on the crash data assumptions described above, this relates to 1.4 fatal and 6.8 serious injury crashes per year.

A 2015 report published by the National Highway Traffic Safety Administration entitled *The Economic and Societal Impact of Motor Vehicle Crashes* (5) indicates that the economic cost to society of each fatality in a fatal crash is \$1.4 million. The economic cost of a serious injury crash (average cost of MAIS 3-5) is approximately \$526,000. Thus, application of the PCB guidelines can be estimated to have an economic safety benefit of ***1.4 fatalities/year × \$1.4 million/fatality + 6.8 serious injuries/year × \$526,000/serious injury = \$5.54 million/year.***

Figure B.1 presents a summary of the VoR calculations for this project.

- Project Budget: \$403,450
- Project Duration: 2.6 years
- Expected Value per year: \$5,540,000
- Expected Value Duration: 20 years
- Total Savings: \$49,456,550
- Net Present Value (NPV): \$40,608,353
- Payback Period: 0.072825
- Cost Benefit Ratio (CBR, \$1: \$): \$101



**Figure B.1. Summary of VOR Calculations for Project 0-7059.**

Another benefit of the implementation of the proposed PCB guidelines that is even more difficult to quantify is worker safety in a construction zone. As mentioned, one of the primary uses of a

precast concrete barrier is positive protection in work zones. When a PCB is deployed in a work zone, a buffer area is typically provided between the barrier and the work activity. The lateral extent of this buffer area is commonly related to the deflection characteristics of the PCB among other risk factors. Barrier deflection characteristics are defined through full-scale crash testing. Damage to the barrier ends can result in increased barrier deflection during an impact. If the increased deflection results in the barrier moving beyond its provided buffer zone, the safety of personnel working behind the barriers can be compromised.

More severe damage to a precast concrete barrier can potentially result in vehicle penetration of the barrier if the remaining capacity is exceeded in an impact. Such an outcome can have severe consequences if workers are present in the area.

While such benefits are difficult to quantify, they are nonetheless extremely important and should be considered within the context of the value of this research along with the other economic safety benefits to motorists previously described.

#### **B.4 References**

1. CDC, Texas Motor Vehicle Traffic Crash Facts, 2020, Accessed June 21, 2022. [https://ftp.txdot.gov/pub/txdot-info/trf/crash\\_statistics/2020/01.pdf](https://ftp.txdot.gov/pub/txdot-info/trf/crash_statistics/2020/01.pdf)
2. Blackley, Julie, Which States Drive the Most Pickup Trucks? iSeeCars.com, June 1, 2022. Accessed June 21, 2022. <https://www.iseecars.com/which-states-drive-the-most-pickup-trucks-study>
3. Edmunds.com, Most Popular Cars in America, Accessed June 21, 2022. <https://www.edmunds.com/most-popular-cars/>
4. TxDOT, Welcome to the TxDOT Crash Query Tool, Accessed June 21, 2022. <https://cris.dot.state.tx.us/public/Query/app/home>
5. Blincoe, L. J., T. R. Miller, E. Zaloshnja, and B. A. Lawrence, *The Economic and Societal Impact of Motor Vehicle Crashes*, 2010, Revised, Report No. DOT HS 812 013, National Highway Traffic Safety Administration, 2015.

