

The Process of
Anaesthetic Preoperative Assessment

David Gatt

Thesis submitted to the University of Nottingham
for the degree of Doctor of Philosophy
May 2021

Abstract

Preoperative assessment is an essential prerequisite to the safe conduct of anaesthesia. The work presented examines several aspects of the process of preoperative assessment and investigates some strategies to improve reliability.

The conduct of preoperative assessment, and the information which needs to be acquired in the process has been studied by several authors, and is the subject of guidelines and advisories published by various prominent associations and learned bodies. This literature is reviewed to establish the desired goals of the preoperative assessment,

The degree to which local practice is congruent with the various recommendations was investigated by means of a survey amongst local anaesthesia practitioners. To further understand anaesthetists expectations of the preoperative assessment, a series of semi-structured interviews were conducted and subjected to thematic analysis.

A healthcare failure modes and effects analysis (HFMEA) of the workings of a preoperative assessment clinic was carried out to predict likely points of failure. The actual functioning of the clinic in practice was further studied from two aspects. A survey of patient experience with the clinic was carried out, which revealed good overall performance, but with some issues regarding excessive waiting times and inadequate provision of information to the patients. An evaluation of the technical quality of the preoperative assessment was also conducted by soliciting feedback from attending anaesthetists. Issues reported included the failure to identify significant problems and failure to effectively communicate with the perioperative team. These issues were anticipated in the earlier HFMEA.

It was hypothesised that a cognitive aid to facilitate a structured approach to decision making and communication would improve the preoperative assessment process. With the input from a focus group, two body-systems based aids was constructed. These were assessed using a tabletop simulation of preoperative assessment. Improvement in reliability was observed. The effect of the aids on attending anaesthetist situation awareness, through better communication and memory formation, was also investigated using a tabletop simulation. Under these conditions no improvement could be identified.

Subjectively, anaesthetists found the aids useful for both preoperative patient assessment and perioperative case management. Junior doctors with no anaesthetic training, however, found the aids confusing.

Acknowledgements

I would like to thank:

My supervisors, Prof. Ravi Mahajan, Prof. Victor Grech and Prof. Jonathan Hardman for their invaluable support and advice during the course of my PhD studies.

Dr. Glenn Paul Abela, Ms. Jessie Bonnici, Dr. Paul Calleja, Dr. Georgette Marie Camilleri, Ms. Colette Crisp, Dr. Daniel Farrugia, Dr. Pippa Trapani Galea Feriol and Dr. Carl Tua for their participation in the prospective hazards analysis.

Dr. Noel Borg, Dr. Michael Buttigieg, Dr. Tanya Esposito, Dr. Marique Sciberras and Dr. Stephen Sciberras for their participation in the focus group to assess the cognitive aid.

On a personal level I would like to express my deepest gratitude:

To my parents Maurice and Nellie, for always encouraging me to achieve my goals.

To my wife Christine, and my son Thomas for their unwavering support, patience and understanding.

To my dog Sammy, for countless hours spent lying under my desk keeping me company.

Declaration

The work presented in this thesis was carried out in the Department of Anaesthesia, Intensive Care Medicine and Pain Management at Mater Dei Hospital, Malta, under the auspices of the School of Medicine, Faculty of Medicine and Health Sciences at the University of Nottingham.

The thesis was composed by myself and, except where referenced or acknowledged within the text, represents my own work.

This work has not been submitted for any other degree or professional qualification.



David Gatt

Publications

None of the work presented here has been published previously.

Contents

1	Objectives	1
1.1	Introduction	1
1.2	Aim	2
1.3	Research Settings	2
1.3.1	The Department of Anaesthesia	2
1.3.2	Surgical Practice	3
1.3.3	Patient Autonomy	4
1.4	Outline of Research	4
2	Preoperative Guidelines and Datasets	5
2.1	Introduction	5
2.2	Aims	5
2.3	Literature Search	5
2.4	Components of Preoperative Assessment	6
2.4.1	Clinical Assessment	7
2.4.1.1	History and Examination	7
2.4.1.2	General Health Status	8
	ASA Physical Status.	8
	Functional Capacity	8
2.4.1.3	Airway Assessment	9
2.4.1.4	Surgical Stress	10
2.4.2	Special Investigations	10
2.4.2.1	ECG	11
2.4.2.2	Echocardiogram	12
	Assessment of Ventricular Function	12
	Assessment of Heart Murmurs	12
	Impact on Management and Outcome	13
2.4.2.3	Non-Invasive Cardiac Stress Testing	13
2.4.2.4	Cardiopulmonary Exercise Testing	13
2.4.2.5	Angiography	15
2.4.2.6	Chest X-Ray	15
2.4.2.7	Spirometry	15
2.4.2.8	Haematology Investigations	16
2.4.2.9	Renal Profile	17
2.4.2.10	Coagulation Screen	18
2.4.2.11	Blood Glucose and HbA _{1C}	19

2.4.2.12	Cardiac Biomarkers	19
2.4.2.13	Arterial Blood Gases	20
2.4.2.14	Serum Albumin	20
2.4.2.15	Urinalysis	20
2.4.2.16	Pregnancy Test	20
2.4.3	Concurrent Medications	21
2.4.3.1	Psychotropic Medications	21
2.4.3.2	β -Blockers	21
2.4.3.3	Angiotensin Converting Enzyme Inhibitors and Angiotensin Receptor Blockers	22
2.4.3.4	Statins	22
2.4.3.5	Diuretics	22
2.4.3.6	Aspirin	23
2.4.3.7	Calcium Channel Blockers	23
2.4.4	Timing of the pre-anaesthesia evaluation	24
2.5	Risk Stratification Tools	24
2.5.1	ASA-PS	25
2.5.2	Surgical Risk Scale	26
2.5.3	Surgical Mortality Probability Model	26
2.5.4	Surgical Risk Score	26
2.5.5	POSPOM	27
2.5.6	Charlson Indices	27
2.5.7	ACS NSQIP Universal Surgical Risk Calculator	28
2.5.8	Surgical Outcome Risk Tool	28
2.6	Discussion	29
3	Preoperative Dataset Survey	31
3.1	Introduction	31
3.2	Aim	31
3.3	Construction of the Questionnaire	32
3.3.1	Respondent Characteristics	32
3.3.2	Patient History and Physical Examination	32
3.3.3	Airway Assessment	32
3.3.4	Preoperative Investigations	33
3.3.4.1	Comorbidities	33
3.3.4.2	Functional Capacity	33
3.3.4.3	Nature of Surgery	34
3.3.4.4	Proposed Investigations	34
3.3.5	Concurrent Medications	34
3.3.6	Timing	35
3.4	Method	35
3.5	Results and Relevant Discussion	35
3.5.1	Respondent Characteristics	35
3.5.2	Patient History	36
3.5.2.1	Presenting Complaint	36
3.5.2.2	Medical History	37

3.5.2.3	Medication History	37
3.5.2.4	Anaesthesia & Surgical History	37
3.5.2.5	Social History	37
3.5.2.6	Systemic Enquiry	37
3.5.3	Physical Examination	40
3.5.4	Airway Assessment	40
3.5.5	Functional Capacity	42
3.5.6	Special Investigations	46
3.5.7	Concurrent Medications	59
3.5.8	Timing of Assessment	60
3.6	Discussion	62
3.6.1	Clinical Assessment	62
3.6.2	Airway Assessment	63
3.6.3	Special Investigations	63
3.6.4	Concurrent Medications	64
3.6.5	Conclusions	64
4	Interview Study	65
4.1	Introduction	65
4.2	Aims	65
4.3	Clinic Overview	66
4.4	Qualitative Methodologies	66
4.5	Method	67
4.5.1	Interview Topics	67
4.5.2	Thematic Coding	68
4.6	Analysis and Interpretation	69
4.6.1	Aims of the Preoperative Assessment	69
4.6.1.1	Identification of Comorbidities	69
4.6.1.2	Assessment of Body Systems	70
4.6.1.3	Assessment of Functional Capacity	70
4.6.1.4	Investigations	70
4.6.1.5	Optimisation	71
4.6.1.6	Anaesthetic Plan	71
4.6.1.7	Patient Rapport	71
4.6.2	Process	71
4.6.2.1	Process Overview	71
4.6.2.2	Roles and Practice	73
	Nurse	73
	Anaesthetist	73
	Foundation Doctor	74
4.6.2.3	Appropriateness of roles	74
	Nurses	74
	Anaesthetist	75
	Foundation Doctors	76
4.6.3	Communication	76
4.6.3.1	Information Flow	76

4.6.3.2	Communication Modalities	78
4.6.4	System Failures	79
4.7	Discussion	80
5	Prospective Hazards Analysis	83
5.1	Introduction	83
5.2	Aims	83
5.3	Clinic Reorganization	84
5.4	Prospective Hazard Analysis Techniques	85
5.5	Method	86
5.5.1	Topic for Analysis	86
5.5.2	Assembling the Team	86
5.5.3	Graphical Description	86
5.5.4	Hazard Analysis	87
5.5.4.1	Task Analysis	87
5.5.4.2	Hazard Identification	87
5.5.4.3	Hazard Evaluation	87
5.5.4.4	Methods Summary	88
5.6	Results	88
5.6.1	Preliminary Activities	90
5.6.2	Nursing	91
5.6.3	ECG and Other Reviews	92
5.6.4	Foundation Doctor	92
5.6.5	Clinic Anaesthetist	93
5.6.6	Attending Anaesthetist	94
5.6.7	Investigations	94
5.6.8	Instructions to Patient	95
5.6.9	Final Preparation	95
5.7	Discussion	95
5.7.1	Team Composition	96
5.7.2	Delphi Analysis	96
5.7.3	Communication Network	97
5.8	Conclusion	97
5.9	Diagrams and Tables	97
6	Patient Experience	157
6.1	Introduction	157
6.2	Aims	157
6.3	Assessing Patient Satisfaction	157
6.3.1	Literature Search	158
6.3.2	Tools to Assess Patient Satisfaction	158
6.3.3	Determinants of Patient Satisfaction	159
6.3.4	Construction of Questionnaire	161
6.4	Method	162
6.5	Results and Analysis	162
6.5.1	Equivalence of Maltese and English Questionnaires	163
6.5.2	Item Response Rates	165

6.5.3	Reliability and Validity	169
6.5.4	Clinic Performance	173
6.5.5	Waiting Times	175
6.5.6	Performance of Clinical Staff	178
6.5.7	Information Given	180
6.5.8	General Assessment of Clinic	182
6.6	Patients' Comments	182
6.6.1	Positive Comments	182
6.6.2	Negative Comments	183
6.6.3	Suggestions	183
6.6.4	Other Comments	183
6.7	Discussion	183
6.7.1	Reliability & Validity	184
6.7.2	Clinic Performance	185
6.7.2.1	Waiting Times	185
6.7.2.2	Clinical Staff	186
6.7.2.3	Information Given	186
6.7.2.4	Likert Satisfaction Scores	187
6.8	Conclusion	187
7	Technical Evaluation	189
7.1	Introduction	189
7.2	Aims	189
7.3	Evaluation of Preoperative Assessment	190
7.3.1	Literature Search	190
7.3.2	Approaches to Evaluation	190
7.3.2.1	Completeness of Dataset	190
7.3.2.2	Accuracy of Evaluation	191
7.3.2.3	Clinical Outcomes and Logistics	191
7.3.2.4	Staff Satisfaction	193
7.4	Development of Evaluation Tool	193
7.4.1	Evaluator	193
7.4.2	Items of Evaluation	193
7.4.3	Questionnaire Domains	194
7.5	Construction of Questionnaire	194
7.6	Method	195
7.7	Results	195
7.7.1	Case Details	195
7.7.2	General	197
7.7.3	Medical History and Comorbidities	199
7.7.4	Preoperative Investigations	203
7.7.5	Drug History and Management	205
7.7.6	Sequelae and Untoward Events	207
7.8	Discussion	207
7.8.1	Case Details	208
7.8.2	General	208

7.8.3	Medical History and Comorbidities	209
7.8.4	Preoperative Investigations	209
7.8.5	Drug History and Management	210
7.8.6	Outcomes	210
7.9	Conclusion	210
8	Cognitive Aid	213
8.1	Introduction	213
8.2	Aims	214
8.3	Method	214
8.4	Handover Failures and Mitigation	215
8.5	Aid Features	216
8.5.1	Standardisation	216
8.5.2	Effective Communication	217
8.6	Aid Format	218
8.6.1	Visual Representation	218
8.6.2	Alert Levels	219
8.6.3	Indicating the Alert Level	220
8.6.4	Multiple Domain Layout	222
8.7	Discussion	226
9	Consistency	227
9.1	Introduction	227
9.2	Aims	227
9.3	Reliability of Perioperative Risk Assessment	227
9.3.1	Literature Search	227
9.3.2	Literature Review	228
9.3.2.1	Reliability of Clinical Assessment	228
9.3.2.2	Reliability of Preoperative Risk Stratification Tools	228
9.4	Method	230
9.5	Results and Analysis	231
9.5.1	Ordinal Linear Regression Model	231
9.5.2	System Functional Scores	233
9.5.3	Test-retest Stability	234
9.5.4	Interrater Reliability	234
9.6	Discussion	235
10	Efficacy	237
10.1	Introduction	237
10.2	Aims	237
10.3	Preoperative Handover as a Component of Situational Awareness	238
10.4	Measuring Situational Awareness	238
10.4.1	Indirect Measures of Situational Awareness	239
10.4.2	Direct Measures of Situational Awareness	240
10.5	Method	241

10.6 Results and Analysis	242
10.6.1 Initial Chart Review Time	242
10.6.2 Accuracy	243
10.6.3 Response Time	243
10.6.4 Chart Reviews	244
10.7 Discussion	245
11 User Satisfaction	247
11.1 Introduction	247
11.2 Aim	247
11.3 Measuring User Satisfaction	247
11.4 Method	248
11.5 Results and Analysis	249
11.5.1 Preoperative Assessors	249
11.5.2 Attending Anaesthetists	256
11.6 Discussion	263
11.6.1 Survey Tool	263
11.6.2 Sources of Bias	263
11.6.3 User Satisfaction with Aids	263
12 Recapitulation & Recommendations	265
12.1 Goals of the Preoperative Assessment	265
12.2 Analysis of the Process	266
12.3 Performance	266
12.3.1 Patients' Perspective	267
12.3.2 Technical Quality of the Preoperative Assessment	267
12.4 Cognitive Aids	268
12.4.1 Utility for Assessors	269
12.4.2 Utility for Attending Anaesthetist	269
12.4.3 User Satisfaction	270
12.5 Further Developments	270
12.5.1 Cognitive Aids	270
12.6 Quality Control and Feedback	271
12.7 Concluding Remarks	271
Glossary	275
References	278
A Preoperative Assessment Questionnaire	311
B Patient Satisfaction Questionnaire	333
B.1 English Version	334
B.2 Maltese Version	340
C Technical Evaluation Questionnaire	345
D Cognitive Aids	353

E	Situational Awareness Scenarios	359
F	User Satisfaction Questionnaires	383
F.1	Preoperative User	383
F.2	Attending Anaesthetist	386

Chapter 1

Objectives

1.1 Introduction

There is broad consensus among anaesthesia professional associations and learned bodies that preoperative assessment of patients is an important element of good practice. Statements to this effect have been published by the American Society of Anesthesiologists (ASA) [1, 2], the Australian and New Zealand College of Anaesthetists (ANZCA) [3], the Royal College of Anaesthetists (RCoA) [4], the Association of Anaesthetists of Great Britain and Ireland (AAGBI) [5] and the European Society of Anaesthesiologists (ESA)

The purpose of the preoperative assessment is to identify patients who are at increased risk in the perioperative period [2, 5, 6]. and to allow the opportunity for patient optimisation [2, 3, 5]. It should permit better planning for utilisation of perioperative resources to improve patient safety [2, 6] while reducing the incidence of last-minute cancellations [5]. If such optimisation cannot be achieved within the available timeframe, then it is possible to reschedule surgery, and make the theatre resources available to other patients.

The assessment and preparation of patients for anaesthesia has become an increasingly complex process. In the interests of improved efficiency, various tasks are often divided between several healthcare professionals from various disciplines and grades of seniority. In addition, the details of the process and the responsibility for various tasks may vary depending on the surgical speciality, and whether the case urgency is classified as immediate, urgent, expedited or elective.

In particular, it is common practice for institutions to establish dedicated clinics for the purpose of undertaking preoperative assessment of patients undergoing elective surgery.

The aim of the work being presented is to investigate various aspects of the processes involved in the workings of such a clinic, understand their limitations and propose solutions for improvements.

1.2 Aim

The remainder of this chapter gives a description of the institution in which the work presented was carried out, a background of relevant clinical practice and a broad outline of the research undertaken.

1.3 Research Settings

The investigations presented were undertaken at Mater Dei Hospital, Malta. This is the main National Health Service hospital offering acute care for the Maltese archipelago. It is a 1000-bed hospital serving a population of approximately 500,000. The hospital offers a broad range of medical specialities. Surgical specialities include general surgery, urology, vascular, ENT, maxillofacial, dental, cardiothoracic, neurosurgery, ophthalmology, obstetrics and gynaecology as well as interventional radiology and cardiology procedures. Over 50,000 interventional procedures are undertaken every year [7].

Mater Dei is a teaching hospital affiliated with the University of Malta for students of Medicine, Nursing and various allied healthcare professions. It also offers training opportunities for a two-year Foundation programme for newly qualified doctors that is affiliated with the United Kingdom Foundation programme [8].

Various medical specialities offer postgraduate training programmes leading to specialist recognition. The Department of Anaesthesia at the hospital runs a five-year training programme leading to specialist registration [9]. The first two years of training are at Basic Specialist Trainee (BST) level, followed by three years at Higher Specialist Trainee (HST) level. Doctors who have achieved specialist recognition may be employed in the role of Resident Specialist (RSp). After gaining some years of experience at this level, specialists may be promoted to consultant, when they will take on greater governance responsibilities.

1.3.1 The Department of Anaesthesia

At the time of these studies, the Department of Anaesthesia had a clinical workforce of around 30 consultants, 40 resident specialists and 20 trainees. As the major acute care facility in Malta, the anaesthesia faculty also represents a large majority of practising anaesthetists in the country.

Provision of anaesthesia care is undertaken entirely by physician anaesthetists. Clinical services provided include cover for all surgical procedures requiring general anaesthesia, major regional anaesthesia, monitored anaesthesia care, medical cover for the 20-bed Intensive Care Unit, epidural analgesia services for the labour ward and chronic pain management clinics. The Department also organises a PreOperative Assessment Clinic (POAC), which is the main focus of the work presented here. The initial operation

of the clinic and its later development are described in detail in Chapter 4, Section 4.3 and Chapter 5, Section 5.3.

Anaesthetic practice in Malta is strongly influenced by British systems. Many Maltese specialists, particularly senior consultants, have undertaken some, or all of their postgraduate training in the UK. Furthermore, as English is the main language of medical instruction, the English language medical literature is easily accessible. As a result, guidelines from the RCoA, the AAGBI and other major UK institutions such as National Institute for Health and Care Excellence (NICE), have an important influence on local practice.

In more recent years, following Malta's accession to the European Union, and the increasing prominence of EU-wide specialist associations, EU standards and practices are gaining in importance. The local training programme for anaesthetic specialisation is strongly influenced by the Royal College curriculum [9], and trainees are encouraged to spend up to a year working in the UK. However, as part of their qualification, trainees are required to obtain the European Diploma in Anaesthesiology and Intensive Care and this is also taken into account in the training curriculum.

The department also has a large contingent of expatriate anaesthesia specialists, largely from Eastern Europe and the former Yugoslavia, who have a different training background.

As a result of the diverse background on the department faculty it is unlikely that any given external guideline, such as NICE will be universally accepted as authoritative. This issue is investigated in greater detail later on in this work.

1.3.2 Surgical Practice

The organisation of surgical services is also based on the UK model, with the basic unit being a consultant-led firm. The consultant is supported by a number of other medical staff, which may include resident specialists, surgical trainees, Foundation Years Programme (FY) doctors and specialist nurses. The consultant surgeon has main clinical responsibility for patients admitted under the care of the firm. Responsibility is shared with the anaesthetist for the perioperative period, and with the Intensive Care consultants if the patient requires postoperative intensive care.

Once a decision has been taken to proceed with surgery, this is not usually revisited during the preoperative assessment. However, if the patient is found to have serious comorbidities, the findings will be reviewed by the attending anaesthetist. If the risk-benefit balance needs to be reconsidered, there will usually be discussion between the surgical and anaesthetic consultant, and the risks discussed again with the patient before a decision is taken whether to proceed with surgery or not.

1.3.3 Patient Autonomy

In common with many other countries, medical practice in Malta historically followed a paternalistic model. These attitudes are slowly changing. Greater emphasis is now placed on patient participation in decision-making. However, change comes slowly, and many patients still defer decision-making to the doctor or surgeon of their confidence. The surgeon will usually discuss treatment options with the patient as appropriate as well as the advantages and disadvantages of surgery, taking into account the extent to which the patient wishes to engage in such a discussion.

1.4 Outline of Research

In the first instance, it was desired to determine what is required of an anaesthetic preoperative assessment. The constituents of an effective anaesthetic preoperative dataset in various clinical situations has been the subject of a considerable body of research and several guidelines from professional associations. This is the subject of a review presented in Chapter 2.

In order to determine what adaptations may be required to apply these guidelines in the local context, a survey was carried out amongst the members of the Anaesthetic Department. This is discussed in Chapter 3.

To further understand the perceptions and expectations of anaesthetists as to the processes and goals of a preoperative assessment, semi-structured interviews were conducted with a purposive subset of anaesthetists and FY doctors, as detailed in Chapter 4.

Having identified the requirements of the preoperative assessment, the process of achieving these goals was investigated. The clinic processes were mapped out in detail and subjected to a prospective hazards analysis as described in Chapter 5. In addition to the theoretical consideration of the clinic failure modes, an assessment of the technical quality of inadequate preoperative assessments was undertaken, as detailed in Chapter 7.

It was also desired to determine that the clinic was fulfilling the expectations of the patients referred for assessment. A survey to determine patient experiences of the clinic was conducted and is reported in Chapter 6.

With an understanding of the preoperative assessment processes and their likely failure modes, strategies to improve the process were considered. Chapter 8 describes the development of a cognitive aid to address some of the identified issues. Aspects of the effectiveness of the aids are investigated under experimental conditions as described in Chapters 9 and 10. User satisfaction with the aids is reported in Chapter 11.

In the final chapter, proposals for further development of the aids, and other process improvement strategies are considered.

Chapter 2

Preoperative Guidelines and Datasets: A Literature Review

2.1 Introduction

The conduct and contents of the preoperative assessment have been the focus of numerous guidelines, advisories and recommendations which aim to determine which elements of the preoperative evaluation are important and cost-effective [1, 2, 6, 10–17]. It is acknowledged, however, that the evidence is often incomplete or inconclusive, and that many recommendations rely heavily on expert opinion and their clinical utility have not all been established by controlled trials [2, 6, 11, 12, 17, 18].

One of the principle functions of the preoperative evaluation is to gather an adequate dataset to allow the planning and management of anaesthesia in the perioperative period. In order to investigate the process of preoperative assessment, a logical starting point is to determine the constituents of such a dataset. To this end, a literature review of preoperative assessment guidelines and recommendations was undertaken.

2.2 Aims

The aim of this literature review was to determine the recommendations for the constituents of an adequate preoperative dataset made by major national and international authorities, highlighting areas of agreement and disagreement. For elements of the preoperative assessment for which there is no such guidance, or it is limited, recommendations were identified from other studies reported in the literature.

2.3 Literature Search

An initial literature search of the Pubmed database was conducted using the search terms ‘“preoperative assessment” AND (guidelines OR advisory) AND (anaesthes* OR anesthes*)’. The results were combined with a further

search (excluding duplicates) using the search terms ‘(preoperative assessment) AND guidelines[MeSH Major Topic]’. The search strategy developed by Ahmadian *et al.* in constructing a minimal preoperative dataset [19] was also used. This was only run on the Pubmed database, and articles published in 2007 and after were extracted. The review by Ahmadian had examined papers published between 1997-2007. The search terms used are shown in Table 2.1.

The returned titles and abstracts were reviewed to identify articles of relevance. Articles dealing with a narrow range of disease states or surgical procedures, unless these were particularly common conditions, were excluded. Papers dealing exclusively with paediatric cases were also excluded. Only articles with full English text were reviewed. The reference lists of reviews and guidelines were also examined for further articles of interest.

The reviewed papers were synthesised into a narrative account of recommendations for the preoperative assessment, investigation and optimisation of patients, indicating areas of concordance or disagreement between various authorities

Table 2.1: Search terms after Ahmadian [19]. Items within Sets combined with ‘OR’, between Sets combined with ‘AND’

<p>Set 1</p> <p>Pre()operati* Pre an(a)esthe* Prean(a)esthe* Pre()surg* “preoperative care”[MH] “Outpatient Clinics, Hospital”[MH] AND (anesthe* OR anaesthe*)</p>	<p>Set 2</p> <p>evaluation preparation assessment “Outcome Assessment”[MH] “Risk Assessment”[MH] “Nursing Assessment”[MH]</p>
<p>Set 3</p> <p>“Medical History Taking”[MH] “Diagnostic Tests, Routine”[MH] “Physical Examination”[MH] Questionnaires[MH] patient interview Patient(medical) history</p>	<p>Set 4</p> <p>Anesthe*[TI] Anaesthe[TI] Preopera* Pre opera* Preanesthe* Preanaesthe*</p>

2.4 Components of Preoperative Assessment

Inadequate preoperative assessment may lead to perioperative adverse events. In a review of case reports from the Australian Incident Monitoring Study [20], 29% of 197 anaesthesia related incidents were attributed to poor airway assessment, 21% to inadequate assessment and a further 7% to lack of

anaesthetic review. Of the cases due to inadequate evaluation, 38% were related to the respiratory system and 26% to the cardiovascular system. The preoperative assessment should thus attempt to identify the presence of known comorbidities or other factors known to impact prognosis, such as those underlying the Revised Cardiac Risk Index (RCRI) [21], the Physiological and Operative Severity Score for the enUmeration of Mortality and morbidity (POSSUM) score [22] or the National Veterans Affairs Surgical Risk Study [23, 24].

Recommendations for the components of the pre-anaesthetic evaluation include

- Evaluation of available medical records [2, 3, 6, 17]
- Patient interview [2, 6, 17] or completion of a health status questionnaire [6, 17]
- Directed pre-anaesthesia examination [2–4], including at least examination of:
 - Cardiovascular system
 - Respiratory system
 - Airway (for ventilation and intubation difficulty)
- Indicated special investigations [2–4]

The specific contents of each of these items will be considered below.

2.4.1 Clinical Assessment

2.4.1.1 History and Examination

It is expected that the preoperative evaluation will commence with a determination of the patient's medical history and symptomatology, supplemented by physical examination to help assess the degree of impairment and the severity of any comorbidities. Cardiovascular and respiratory complications are amongst the major causes of postoperative morbidity and mortality [20–24]. At a minimum, evaluation of these systems seems reasonable [2, 6, 17]. Attempts have been made to correlate abnormal preoperative finding with perioperative adverse events [25]. Significant predictors from the clinical findings were age, history of renal disease or anaemia. As this study was based on 1363 cases scheduled for mixed, elective surgery, it is possible that less common conditions were represented in too small numbers to be statistically significant. Also, the authors do not report on any attempts to optimise the patients' physical status.

Several tools and questionnaires have been proposed for screening patients. Some have been developed on the basis of local expert opinion [26]. Others are constructed to identify patients requiring further clinical evaluation or investigation [27, 28]. Some of these tools have been shown to have

adequate efficacy for practical use [27] or have demonstrated content and criterion validity [29].

There is considerable disagreement regarding the extent of data which needs to be collected for adequate preoperative assessment [30], and a survey amongst European anaesthetists also found considerable variation in practice [31]. Ahmadian *et al.* undertook a literature review covering the years 1997 to 2007 to identify data items routinely collected in preoperative assessment [19]. They identified 540 data items, but noted there was considerable heterogeneity in the items advocated in the papers they reviewed. Using this literature review as a starting point expert panels were convened to identify appropriate subcategories of the dataset and to determine a minimal required dataset in each category [32]. The proposed dataset does not appear to have been assessed for face validity amongst practising anaesthetists.

2.4.1.2 General Health Status

ASA Physical Status. It is useful to summarise the overall health status of the patient by a simple index. A widely used classification for quantifying patient health status in the perioperative setting is the American Society of Anesthesiologists Physical Status (ASA-PS) [33]. Although originally intended as a tool to allow comparison of outcomes in diverse patient populations, it is now used as an indicator of risk in individual patients. Patients with higher ASA-PS score are considered to be at increased risk from perioperative complications and warrant more extensive investigation [11,12]. However, this classification has been criticised as lacking precise definitions for the different categories [11,12,34]. This has led to concerns that ASA-PS determination may be too dependent on subjective assessment. Using ten hypothetical case scenarios, Owens *et al.* [34] found significant interrater discordance. These findings were confirmed in a much more recent study [35] using the same methodology and case scenarios. Other investigators using a different set of case scenarios [36,37] obtained similar results. On the other hand, using a sample of 14349 actual clinical cases, a computerised algorithm was able to achieve a very high degree of concordance with an anaesthetist's assessment of ASA-PS [38]. Mismatches were only found in 1.1% of cases.

The ASA now includes representative cases in the ASA-PS classification to aid users of the system in assigning a score [39].

Functional Capacity Another indicator of overall health is the patient's exercise tolerance or functional capacity, often expressed in terms of Metabolic Equivalents (METs) [6,13,14,17], where one MET represents metabolic rate at rest. Patients with peak METs < 4 are considered to warrant more intensive preoperative work up.

The Duke Activity Status Index (DASI) [40] uses a questionnaire based on various levels of everyday activities which is intended to estimate the

corresponding peak METs. In a multicentre, international prospective cohort study [41], Wijeyesundera *et al.* demonstrated that the DASI score was an independent predictor of postoperative myocardial infarction and death. They also showed that subjective assessment of functional capacity had only 19% sensitivity in predicting an objectively measured $\dot{V}O_{2peak} < 14 \text{ ml.kg}^{-1}.\text{min}^{-1}$, equivalent to < 4 METs. This group further went on to show that, in patients with increased cardiac risk, a DASI score of 34 or less was associated with an increased risk of death, myocardial infarction or other morbidity. This DASI score corresponds to a $\dot{V}O_{2peak} < 18 \text{ ml.kg}^{-1}.\text{min}^{-1}$ or 5 METs. Somewhat higher than the conventional cutoff discussed above, but concordant with the findings of West *et al.* [42]

In recent years, there has been increasing interest in objective measures of exercise tolerance. These are discussed in Section 2.4.2.4.

2.4.1.3 Airway Assessment

Difficulty in maintaining the airway is an important cause of major anaesthetic morbidity [43–46]. Assessment for anticipated airway difficulty is therefore widely recommended [2, 6, 17]. However, in a survey of European and UK anaesthetists [47] a wide variety of assessment techniques were employed. It was, however, also found that airway assessment was often omitted. Although in this study the Mallampati score was considered one of the most useful tests, there is some evidence that the Upper Lip Bite Test (ULBT), or mandible subluxation [48] is superior, as is measurement of the thyromental distance in relation to patient height [49]. Surprisingly, the use of a battery of airway assessment tests was found to be inferior to routine practice [50]. The authors hypothesised that filling in the rather extensive assessment form distracted the anaesthetist from actually assessing the patient accurately.

In reviewing the literature on assessing the difficult airway and difficult intubation, the ESA concluded that there was no single physical test to predict difficult mask ventilation and difficult intubation [6, 17]. Difficult mask ventilation may be anticipated in the presence of two or more of the following factors:

- BMI $> 30 \text{ kg.m}^{-2}$
- Limited jaw protrusion
- History of snoring
- Presence of a beard
- Mallampati grade 3 or 4
- Age over 57 years.

Furthermore, the presence of three of the following factors may indicate a patient who is impossible to mask ventilate:

- Radiation changes to the neck
- Male sex
- Obstructive sleep apnoea
- Mallampati grade of 3 or 4
- Presence of a beard

To predict difficult intubation, the ESA [6, 17] recommends a multifactorial assessment, which should include the Mallampati grade, thyromental distance, mouth opening and ULBT.

2.4.1.4 Surgical Stress

The physiological impact of the proposed surgery is another factor which contributes to the occurrence of perioperative complications. It may also influence the decision to request more extensive preoperative investigation [2, 6, 11, 17]. This consideration is hampered by the difficulty in classifying the degree of surgical stress as there is no universally accepted catalogue of degree of physiological derangement caused by a given surgical procedure [11, 12].

2.4.2 Special Investigations

In spite of the variability in recommendations for clinical preoperative assessment noted above (Section 2.4.1), there appears to be consensus that an adequate clinical assessment is sufficient to identify those patients requiring further laboratory investigations or diagnostic procedures [2, 6, 11, 12, 17, 51, 52]. The utility of a wide range of preoperative investigations has been considered in various guidelines and recommendations [2, 6, 11, 12, 17]. There appears to be little evidence to support the use of routine preoperative investigations in otherwise healthy patients undergoing minor or intermediate surgery. Some researchers question the utility of investigations even when relevant to pre-existing comorbidities if the surgery is relatively non-invasive. For example, for cataract surgery in developed countries, routine preoperative testing does not decrease the incidence of perioperative complications, in spite of this population being relatively elderly with multiple comorbidities [53–55]. A pilot randomised controlled trial in patients undergoing ambulatory surgery also found no benefit in routine preoperative investigation [56], although the patient exclusion criteria utilised would have likely excluded most patients with any significant systemic disease.

The value of investigations may increase in patients with worsening health status, in the presence of various co-morbidities, or in patients undergoing more stressful surgery [2, 6, 11, 12, 17]. Part of the utility of the clinical evaluation of the patient discussed above is to guide the ordering of further investigations.

Indications for specific special investigations as recommended by various sources are outlined below.

2.4.2.1 ECG

Most authorities recommend that a preoperative ECG is not required as a routine preoperative investigation, but should be considered in various clinical situations.

The American College of Cardiologists and American Heart Association (ACC/AHA) guidelines [13, 57] consider an ECG reasonable for patients with known cardiac or vascular disease or those undergoing moderate or high-risk surgery. It is not recommended for low-risk patients having low-risk surgery.

The European Society of Cardiologists (ESC) [14] similarly recommends an ECG for patients with cardiovascular risk factors undergoing intermediate or high-risk surgery. It should be considered for patients with risk factors undergoing low-risk surgery and for all patients undergoing intermediate or high-risk surgery. It is not recommended for patients with no risk factors undergoing low-risk surgery. The ESA [6, 17] follows the recommendations made by the European Society of Cardiology (ESC) [14], with the addition of recommending an ECG for obese patients.

The ASA [2] recommends a resting 12-lead electrocardiogram (ECG) for patients with cardiovascular risk factors as identified by the RCRI [21] (Table 2.3, pg. 14), respiratory disease or undergoing high-risk surgery.

NICE [12] recommend performing an ECG for ASA-PS 2, 3 and 4 patients having major or complex major surgery, and ASA-PS 3 and 4 patients having intermediate surgery. They recommend considering an ECG for ASA-PS 1 patients over 65 having major or complex major surgery, ASA-PS 2 patients with cardiovascular comorbidities or risk factors undergoing intermediate surgery, and ASA-PS 3 and 4 patients even if only undergoing minor surgery. It is not recommended for ASA-PS 1 patients having minor or intermediate surgery, or ASA-PS 2 patients having minor surgery.

Contradicting the above recommendations however, in a study of 1363 patients undergoing elective surgery and who underwent routine investigations, including an ECG, Fritsch *et al.* [25] identified an abnormal ECG as one of the independent predictors of perioperative adverse events. This would suggest that an ECG is warranted in all cases. However, their definition of abnormality included several types of arrhythmia which would have been noted clinically. At the other extreme, in a randomised controlled trial of 1026 patients Chung *et al.* [56] reported no benefit from various preoperative investigations (including ECG) in patients undergoing ambulatory surgery. The patient exclusion criteria however, would have excluded a number of patients where ECG testing would have been indicated in view of the medical history. In a retrospective analysis of a cohort of 105,593 patients in the Netherlands who underwent surgery between 1991 and 2000 [58], 23,036 had an ECG as indicated by local guidelines. It was found that an abnormal ECG was an independent predictor of cardiac-related death.

This association was weak except in patients undergoing intermediate- to high-risk surgery.

2.4.2.2 Echocardiogram

A resting echocardiogram may be of use in assessing left ventricular function and elucidating anatomical cardiac defects.

Assessment of Ventricular Function The ACC/AHA [13, 57] recommendations suggest assessment of left ventricular function for patients with dyspnoea of unknown aetiology, and for patients with a known history of heart failure who have worsening symptomatology (unless performed within the last 12 months). One of the suggested modalities for this assessment is the use of echocardiography. There is no evidence to recommend testing patients with stable cardiac symptoms, and echocardiography for asymptomatic patients is not recommended.

The recommendations of the ESC [14] are that rest echocardiography should be considered in patients undergoing high-risk surgery but is otherwise not indicated for asymptomatic patients.

NICE recommends that echocardiography may be considered in patients with signs or symptoms of heart failure [12].

The Canadian Cardiovascular Society (CCS) do not recommend preoperative echocardiography, as they consider that the RCRI and measuring NT-proBNP is of greater prognostic value [59].

Assessment of Heart Murmurs Cardiac auscultation by anaesthetists for the identification of valvular heart disease has a positive predictive value of 70% compared to echocardiography [60]. The authors of this study suggest that full evaluation of a patient with an identified murmur should include echocardiography, particularly in those over 40 years old.

The ACC/AHA guidelines on management of patients with valvular heart disease [61] list several indications for echocardiography, which include all patients with diastolic, holosystolic and late systolic murmurs, murmurs associated with a click or which radiate to the back or neck. It is also recommended for patients with associated signs of heart disease and for midsystolic murmurs of grade 3/6 or louder. It is not recommended for softer mid-systolic murmurs. These recommendations are also endorsed in the ACC/AHA preoperative guidelines [13].

The ESC [14] recommend that echocardiography should form part of the evaluation of patients with severe valvular heart disease. The guidelines go on to suggest that echocardiography should be performed in patients with known or suspected valvular disease to assess its severity.

NICE recommends considering echocardiography to assess patients with a heart murmur and any cardiac symptoms [12].

Impact on Management and Outcome In an audit of 97 patients who underwent transthoracic (TTE) or transoesophageal echocardiography (TOE) according to clinical indications [62], it was found that the information obtained led to significant changes in planned management in about half of the patients. The proportion was even higher in emergency cases. Observational studies indicate that echocardiography may influence peri-operative management in elective surgery [63], emergency surgery [64] and orthopaedic trauma surgery [65]. In the latter case it is also associated with improved mortality rates.

2.4.2.3 Non-Invasive Cardiac Stress Testing

Non-invasive stress testing may include modalities such as exercise ECG, myocardial perfusion imaging or echocardiogram with pharmacologically induced stress.

For all patients with active cardiac conditions (Table 2.2, pg. 13), the ACC and AHA recommend [13, 57] stress testing and management as indicated for their condition. Stress testing should also be considered for patients with three or more cardiovascular risk factors (Table 2.3, page 14) [21] and exercise tolerance of less than 4 METs having vascular surgery or intermediate surgery. It is not considered useful for patients without risk factors having intermediate surgery or patients having low-risk surgery.

The ESC guidelines [14] recommend stress testing for patients with three or more risk factors having high-risk surgery. It should be considered for high-risk surgery with two or less risk factors. It may be considered for intermediate risk surgery. It is not recommended for low-risk surgery.

The CCS recommend against stress testing [59].

Table 2.2: Active Cardiac Conditions

Unstable Coronary Syndrome
- Unstable Angina
- Recent Myocardial Infarction
Decompensated Heart Failure
Significant Arrhythmia
Severe Valvular Heart Disease

2.4.2.4 Cardiopulmonary Exercise Testing

Cardiopulmonary Exercise Testing (CPET) is a non-invasive investigation which assesses the overall function of the respiratory, cardiovascular and musculoskeletal system by assessing oxygen utilisation and carbon dioxide production under various degrees of exercise workload [14]. Over the last several years, there has been growing interest in the use of this modality in

Table 2.3: Revised Cardiac Risk Index Factors [21]

History of Ischaemic Heart Disease or Myocardial Infarction
History of Congestive Heart Failure
History of Stroke or Transient Ischaemic Episode
Renal Dysfunction (serum creatinine $> 170\mu\text{mol.L}^{-1}$)
History of Diabetes Mellitus requiring insulin
High-risk (vascular) surgery

preoperative assessment to assess perioperative risk and to identify patients who will benefit from prehabilitation and preoperative optimisation [66].

The various parameters determined in a CPET, such as peak oxygen uptake ($\dot{V}O_{2peak}$), anaerobic threshold ($\dot{V}O_{2AT}$), Ventilatory Equivalent for Oxygen ($\dot{V}E/\dot{V}O_{2peak}$) and the Ventilatory Equivalent for Carbon Dioxide ($\dot{V}E/\dot{V}CO_{2peak}$), have, for example, been shown to be predictive of decreased survival after elective abdominal aortic aneurysm repair [67], to allow risk stratification for various types of intra-abdominal surgery [68], and to predict morbidity [42], and guide the level of postoperative care requirements after colorectal surgery [69]. West *et al.* [42] found cutoff values of $\dot{V}O_{2AT} < 11.1 \text{ ml.kg}^{-1}.\text{min}^{-1}$ and $\dot{V}O_{2peak} < 18.2 \text{ ml.kg}^{-1}.\text{min}^{-1}$ to be associated with increased odds of in-hospital morbidity after major colorectal surgery.

In spite of these promising results, concerns have been raised as to their generalisability because of lack of standardisation in test protocols and insufficient evidence as to which CPET parameters may be most relevant in specific disease states and types of surgery [66]. The interobserver reliability in quantifying the various values such as $\dot{V}O_{2peak}$ and $\dot{V}O_{2AT}$ has also been questioned [70].

In view of these concerns, CPET testing has not yet been endorsed by the ESC/ESA guideline group [71] or the NICE guidelines on perioperative testing [12]. The CCS guidelines on perioperative cardiac risk assessment [59] actually discourages the use of CPET in this context on the grounds that it adds little to risk assessment which cannot be achieved by the use of the DASI combined with serum levels of Brain Natriuretic Peptide (BNP) or NT-proBNP. A recent evaluation of the DASI [41, 72] appear to support this position. The ACC/AHA advise that it may be considered for patients with unknown functional capacity who are to undergo high-risk procedures [57].

In order to address some of the issues with CPET testing discussed above, the Perioperative Exercise Testing and Training Society (POETTS) [73] have published guidelines for CPET protocols and standards [74]. It is hoped that such standardisation will allow more reproducible results and

combination of datasets, which will help clarify the role of CPET in preoperative assessment.

2.4.2.5 Angiography

The ESC [14] recommends angiography for patients with acute ST-elevation or non-ST elevation myocardial infarction, or angina uncontrolled by medical therapy. Angiography may be considered in patients with known stable ischaemic heart disease who are to undergo high-risk or intermediate surgery. It is not recommended for low-risk surgery. The ACC/AHA only recommends angiography if this is indicated by the patient's symptomatology [57].

2.4.2.6 Chest X-Ray

The National Institute for Clinical Excellence (NICE) guidelines [11, 12] in reporting on the consensus opinions of their panellists found that there was agreement that chest x-ray was not required for low-risk surgery in healthy patients. However, there was a lack of consensus as to the requirements for chest x-ray in patients having more extensive surgery, in patients with cardiovascular, respiratory or renal comorbidities, or advanced age.

The ESA guidelines [6, 17] recommend that chest radiography should not be requested on a routine basis as they rarely lead to a change in management.

The ASA advisory [2] recommends that chest radiography is not indicated for routine screening, but may be considered in patients who smoke, have had a recent upper respiratory tract infection, have a history of COPD or cardiac disease, and at extremes of age. However, these are not absolute indications.

In spite of these recommendations, and a lack of evidence for clinical utility [25, 56], a small minority of surveyed European anaesthetists still request a chest radiograph for all patients [31].

2.4.2.7 Spirometry

In their review based guidelines on preoperative pulmonary risk stratification for non-cardiothoracic surgery, the American College of Physicians (ACP) [75, 76] found that spirometry does not allow accurate risk prediction in individual patients, and so it should not be used routinely in assessing patients with lung disease. It may be useful in assessing patients with undiagnosed lung conditions, and in those who are to undergo pulmonary resection or cardiac surgery.

The ESA guidelines [6, 17] also note that, while spirometry may be useful in diagnosing pulmonary disease, it does not seem useful to predict outcome in individual patients, and so is not recommended to predict postoperative outcome.

The ASA advisory [2] only notes that spirometry may be of use in evaluating pulmonary disease.

The guidelines note that the available evidence is sometimes contradictory as to the utility of spirometry, and few studies compare the value of formal spirometry to clinical assessment of pulmonary disease. In a more recent report looking specifically at patients undergoing endovascular aneurysm repair [77] the authors found that FEV₁ and FVC were important predictors of long-term mortality. They also note several of their patients either had undiagnosed COPD or the severity of their condition was underestimated. A direct comparison of clinical grading and spirometric assessment in 220 patients identified clinically to be at high risk for lung disease scheduled for elective cardiac surgery came to the same conclusion that clinical assessment often underestimated the incidence and severity of chronic pulmonary disease [78].

Considering patients undergoing open or laparoscopic bariatric surgery, Gonzalez [79] found that patients requiring postoperative ICU admission were more likely to have a low preoperative FEV₁. Similarly, in a prospective study of 485 patients undergoing laparoscopic bariatric procedures [80], spirometric evidence of obstructive airway disease or airway reversibility were found to predict an increased complication rate. In another retrospective study of 602 patients undergoing laparoscopic or open bariatric surgery [81], spirometric abnormalities were also found to correlate with increased complication rate, but only in those patients with obstructive sleep apnoea or other respiratory symptoms. In view of this, it may be that this particular subgroup of patients warrants preoperative spirometric assessment.

2.4.2.8 Haematology Investigations

The NICE guidelines [11,12] found no evidence that preoperative haemoglobin measurement improved outcome. The NICE panellists consensus that this test was not required for ASA-PS 1 or 2 patients having low-risk surgery except possibly in the elderly or very elderly. It was felt this was justified for patients undergoing more invasive types of surgery. Considering ASA-PS 2 and 3 patients, the expert panellists had mixed opinions as to whether this should be performed for low-risk surgery. There was agreement that it was indicated for more invasive procedures. For ASA-PS 4 patients a preoperative full blood count was considered justified.

While the ESA guidelines [6,17] consider the necessity and modalities for managing preoperative anaemia, they are silent on the circumstances in which preoperative haemoglobin should be measured.

The ASA advisory literature review [2] found that haemoglobin values were abnormal in only a small percentage of routine cases, and this rarely led to change in management. However, most surveyed practitioners felt haemoglobin should be measured preoperatively if there was a specific indication (such as surgery type, liver disease, extremes of age, or a history of anaemia, bleeding or haematological disorders).

A Health Technology Assessment [15] also found little evidence in the literature to demonstrate benefits from routine preoperative haemoglobin assessment. A survey of preoperative clinic practice carried out as part of this assessment found overall compliance with NICE guidelines, although response rate was poor. In an analysis of preoperative investigations taken at Leeds Teaching Hospital NHS Trust, the same authors found evidence that Complete Blood Counts (CBCs) were being ordered selectively, and not as a routine.

A clinical history of anaemia was found to increase the odds of perioperative complications in patients undergoing various types of elective surgery [25]. However, no similar association with abnormal blood count was found. A similar lack of utility for CBC was noted in patients undergoing ambulatory surgery [56].

An abnormal haemoglobin level has been shown to be an independent risk factor in patients undergoing open vascular [82] and endovascular [83] surgery. In an analysis of data from the VA National Surgical Quality Improvement Database, it was also found to be a predictor of adverse outcome in patients over 65 years of age undergoing major surgery [84]. These findings would be in keeping with guideline recommendations for its use in major surgery and at extremes of age.

2.4.2.9 Renal Profile

Perioperative Acute Kidney Injury (AKI) is associated with cardiovascular and cerebrovascular events [13, 14] and poor outcome [17]. The utility of laboratory assessment of preoperative renal function is predicated by a medical history of Chronic Kidney Disease (CKD) or the presence of risk factors predisposing to AKI. The various authorities [6, 11–14, 17, 71] agree that the degree of chronic renal impairment is best assessed by one of the published formulae [85, 86] for estimated Glomerular Filtration Rate (eGFR).

While largely similar, the risk factors for AKI recognised by NICE [87] and the ESA [6, 17] are not completely congruent. These are summarised in Table 2.4. The ESA risk factors are partly based on the factors of the Kheternal renal risk score [88]. This was constructed from data obtained from the American College of Surgeons (ACS) National Surgical Quality Improvement Program (NSQIP) dataset. The score was based on analysis of 75,952 cases from the database to derive a risk index, and a further 18,872 cases for validation. In order to make the index as generalisable as possible, surgery types known to be associated with postoperative renal injury, and patients with preoperative evidence of acute renal impairment were excluded.

In addition to the presence of the risk factors discussed above, NICE further recommends different levels of investigation depending on the extent of planned surgery and ASA-PS. For minor surgery, it is recommended that renal profiling should be considered for ASA-PS 3 and 4 patients. For intermediate surgery it is recommended for ASA-PS 3 and 4 patients and should also be considered for ASA-PS 2 cases. For major and complex major

surgery it should be considered even for ASA-PS 1 patients and performed in all other cases.

Table 2.4: Acute Kidney Injury Risk Factors

<i>Risk Factor</i>	NICE	ESA
<i>Male</i>		•
<i>Age (years)</i>	≥ 65	≥ 56
<i>Obesity</i>		•
<i>CKD</i>	•	•
<i>eGFR (ml/min/1.73m²)</i>	< 60	< 60
<i>Hypertension</i>		•
<i>CHF</i>	•	•
<i>Liver Disease</i>	•	
<i>Ascites</i>		•
<i>Alcohol Abuse</i>		•
<i>Smoking</i>		•
<i>Anaemia</i>		•
<i>Hypoalbuminaemia</i>		•
<i>Emergency Surgery</i>	•	•
<i>Intraperitoneal Surgery</i>	•	•
<i>Nephrotoxic Drugs</i>	•	•

The ASA advisory [2] only notes that likely perioperative therapies, endocrine conditions, risk of renal dysfunction and the use of certain medications should be considered in deciding if renal function profiling should be performed.

2.4.2.10 Coagulation Screen

The NICE guidelines [11, 12], the ESA guidelines [6, 17] and the ASA advisory [2] are all in agreement that tests for coagulation disorders are only indicated if there are specific comorbidities, if the patient is receiving anticoagulants or for specific types of surgery. Literature-based guidelines produced by the *Société Française d'Anesthésie et de Réanimation* [52] recommended assessing patients for coagulopathy by personal and family history, using a formal questionnaire. The routine use of Prothrombin Time (PT), Activated Partial Thromboplastin Time (aPTT) and platelet counts were not recommended. Similarly, the German Societies of Anaesthesiology and Intensive Care Medicine, Internal Medicine and Surgery [51] place most emphasis on clinical history to identify bleeding tendencies. This position is supported by a recent analysis of 11,804 neurosurgery patients taken from the ACS NSQIP dataset [89]. In this study, clinical risk factors for bleeding disorders were found to predict haemostasis-related complications as well or better than laboratory tests, although neither approach had high sensitivity or specificity.

2.4.2.11 Blood Glucose and HbA_{1C}

Diabetes mellitus and impaired glucose metabolism are associated with adverse postoperative outcomes. Patients undergoing vascular surgery with elevated preoperative glucose levels and Glycated Haemoglobin (HbA_{1C}) are at increased risk of peri- and postoperative cardiac events [90]. Systematic reviews and meta-analysis have shown an increased risk of surgical site infection in diabetics after multiple types of surgery [91] and specifically knee arthroplasty [92] and spinal surgery [93,94]. Tight glucose control may improve outcome in critically ill patients [95] and those undergoing cardiac surgery [96]. However, similar benefits have not been demonstrated in a general surgical population.

In spite of these findings, the 2003 NICE literature review [11] did not find enough evidence to recommend universal routine random blood glucose testing. The expert panellists considered it to be unnecessary for ASA-PS 1 and 2 patients, but may be useful in ASA-PS 3 and 4 patients undergoing moderate or high-risk surgery. Several panellists felt that fasting blood glucose assay would be more useful, but recognised the logistical problems of obtaining this assay. A review by Bock *et al.* [97] extended the NICE literature base. They also came to the conclusion that routine blood glucose and HbA_{1C} assays are not necessary for routine screening, but may be useful in specific situations. In the 2016 NICE guidelines [12], random blood glucose testing was removed from the guideline. Use of HbA_{1C} assays was recommended for known diabetics.

The ESA guidelines [6,17], while stating that routine random blood glucose assessment is not recommended, go on to recommend that there should be a formal assessment of the risk of impaired glucose homeostasis using clinical criteria. The authors recognise that the utility of using a preoperative assessment as an opportunity to carry out screening for impaired glucose homeostasis will depend on the incidence of diabetes in the population under consideration, as well as the efficacy of existing primary health surveillance programmes. This will determine the likelihood of detecting a previously undiagnosed diabetic patient on presentation for preoperative assessment, and therefore determine whether such testing is cost effective.

The ASA advisory [2] suggests that serum glucose assay should be considered in the presence of specific indications.

2.4.2.12 Cardiac Biomarkers

Interest has developed in the use of cardiac biomarkers such as BNP and NT-proBNP to help evaluate perioperative cardiac risk.

In reviewing the available evidence, the ACC/AHA considered that there was insufficient evidence to recommend their use [57]. The ESC/ESA guidelines had similar reservations [71]. In the more recent CCS guidelines, however, the authors recommend measuring these biomarkers in patients over the age of 65, in patients between 45-64 years with known significant cardiac disease, and patients with one or more RCRI risk factors [59]. A recent

large study [41] found that NT-proBNP improved prediction of postoperative myocardial injury and death.

2.4.2.13 Arterial Blood Gases

In a prospective cohort of 272 patients referred for medical evaluation prior to non-thoracic surgery [98], preoperative hypercapnia ($>45\text{mmHg}$) was correlated with increased risk of postoperative pulmonary complications. However, multiple regression analysis found that clinical preoperative findings would predict these complications, indicating that arterial blood gases would be unnecessary for routine screening. They may, at most, be indicated in selected, high-risk patients.

The NICE panellists [11, 12] were divided in their opinion on the utility of blood gas analysis, with some feeling that it could be of use in assessing patients with significant cardiovascular, respiratory or renal disease undergoing intermediate or major surgery.

The ESA guidelines [6, 17] do not have any recommendations in this regard.

The ASA advisory [2] suggests it may be useful in assessing patients with pulmonary disease.

2.4.2.14 Serum Albumin

In a large, validated model for predicting postoperative respiratory failure, hypoalbuminaemia ($< 30\text{g.L}^{-1}$) has been found to be a major predictor of perioperative pulmonary complications [99]. The ACP recommends [75, 76] that serum albumin levels should be determined in all patients who are clinically suspected of being hypoalbuminaemic.

2.4.2.15 Urinalysis

There is very little literature examining the value of urinalysis in preoperative screening. In one reported study, patients with a urinalysis suggestive of urinary tract bacterial colonisation, if confirmed by culture, were at increased risk of wound infection following orthopaedic surgery [100].

The ASA advisory [2] recommends that urinalysis is only indicated if there are specific symptoms or if prosthetic implants are planned.

2.4.2.16 Pregnancy Test

In a retrospective review of routine preoperative pregnancy testing, in a cohort of 2588 patients, 8 (0.31%) had a positive urine pregnancy test [101], of which four were shown to be true positives.

The NICE experts [11, 12] and the ASA advisory [2] suggest that pregnancy testing may be offered to female patients, after they have been informed of the risks of anaesthesia to the foetus in undetected early pregnancy.

2.4.3 Concurrent Medications

Many patients who present for surgery will be on long-term treatment for the management of various comorbidities. Some of these may influence the behaviour of the cardiovascular system, or the effect of various drugs used in anaesthesia. Recommendations have been made for some of the commonly used drugs as detailed below. Consideration is only given here to continuation of current medication for pre-existing comorbidities, and not to commencing new treatment to improve perioperative outcome.

2.4.3.1 Psychotropic Medications

The effect of tricyclic antidepressants on cardiac electrophysiology, and the increased sensitivity to sympathomimetics gives rise to concern for the continuation of these drugs in the perioperative period [102]. However, in a prospective randomised trial of 80 patients on long-term antidepressants undergoing surgery [103], it was found that stopping the antidepressants preoperatively resulted in more postoperative confusion and worsening depression, without conferring any improved cardiovascular stability. The discontinuation of antipsychotics in schizophrenic patients has also been linked to increased postoperative confusion [104].

Concerns have been raised about the possible interaction of Selective Serotonin Reuptake Inhibitors (SSRIs) with some anaesthetic drugs such as pethidine, leading to serotonergic syndrome. However, current recommendation is to continue these in the perioperative period [6, 17].

In view of theoretical concerns of lithium toxicity if the patient develops perioperative cardiovascular instability or renal impairment, and the possible potentiation of neuromuscular blockers, it is recommended that this drug be stopped 72 hours prior to elective surgery [6, 17, 102]

2.4.3.2 β -Blockers

In a retrospective study of patients undergoing vascular surgery [105] it was found that perioperative withdrawal of β -blockers was associated with increased risk of death or postoperative cardiac events. A prospective multicentre survey [106] also found an increased risk of 1-year mortality in vascular surgery patients who stopped β -blocker treatment. In a single-centre retrospective study covering the years 1996-2008 [107], 30-day and 1-year postoperative mortality was reduced in patients receiving β -blockers preoperatively and who were maintained on treatment. Similarly, an analysis of 8,431 patients from the Surgical Care and Outcomes Assessment Program (SCOAP) database [108] found continuation of β -blockers in patients undergoing colorectal or bariatric surgery was associated with a lower incidence of postoperative cardiac events and 90-day mortality. Using an even larger cohort of 37,805 propensity-matched patients from the Veterans Association Surgical Quality Improvement Program (VASQIP) database undergoing various types of non-cardiac surgery, London *et al.* [109] also found

that perioperative withdrawal of long-term β -blocker therapy increased risk of postoperative death or cardiac morbidity. On the other hand, the PeriOperative IScaemia Evaluation (POISE) trial [110] found that, although instituting metoprolol treatment in the perioperative period decreased the risk of myocardial events, there was an increase in overall deaths and morbidity due to stroke.

On reviewing the available evidence the ACC/AHA [57] recommend continuing β -blockers in patients already on long-term treatment. Their use may be considered in patients with cardiac risk factors who would benefit from this treatment, but they should not be started on the day of surgery. The ESC/ESA guidelines [71] are essentially the same. The CCS recommend continuing treatment in patients on long-term β -blocker therapy, but not to start treatment within 24 hours of surgery [59].

2.4.3.3 Angiotensin Converting Enzyme Inhibitors and Angiotensin Receptor Blockers

The 2014 ESC/ESA guidelines [71] report no literature to directly guide perioperative practice for angiotensin converting enzyme inhibitors and angiotensin receptor blockers. However, noting the risk of severe perioperative hypotension with these drugs it is recommended that, if they are being used to treat hypertension, withdrawal 24 hours before surgery may be considered. On the other hand, if they are being used to manage left ventricular systolic dysfunction, the benefits of maintaining treatment may outweigh the risks.

The ACC/AHA advise that continuation of these drugs is reasonable in the perioperative period, and if withheld, they should be restarted as early as feasible in the postoperative period [57].

The CCS recommend withholding these drugs in the 24 hours before surgery due to the risk of hypotension [59].

2.4.3.4 Statins

An observational study of patients undergoing infrarenal aortic surgery [111] found continuation of statin therapy during the perioperative period was associated with fewer perioperative cardiac events. The ESC/ESA [71] guidelines thus recommend continuation of statin therapy in the perioperative period, preferably with a long-acting or extended-release formulation.

The ACC/AHA [57] and CCS guidelines [59] also recommend continuation of long-term statins. The ACC/AHA further suggest that treatment should be considered in patients undergoing vascular surgery, or with other incidental indications for statin therapy.

2.4.3.5 Diuretics

The ESC/ESA guidelines [71] recommend continuation of oral diuretics until the day of surgery both for treatment of hypertension and for congestive

heart failure, provided care is taken to assess volume status and electrolyte balance. However, these assertions are largely based on expert opinion, and there does not appear to be much empirical evidence reported in the literature to support or refute this.

2.4.3.6 Aspirin

Aspirin is commonly used for prophylaxis in patients with ischaemic heart disease or cerebrovascular disease. However, in the perioperative period there is concern over its continuation due to the risk of increased bleeding. A meta-analysis of 41 studies including 49,590 patients [112] concluded that continuation of aspirin led to a 1.5-fold increase in the risk of bleeding, but did not increase the severity of bleeding complications except, possibly, for intracranial surgery or prostatectomy. However, discontinuation of aspirin was associated with an increase in major adverse cardiovascular events.

The more recent PeriOperative IScaemia Evaluation-2 (POISE-2) trial [113], studied 10,010 patients undergoing non-cardiac surgery. Patients were randomised in a 2x2 factorial design to receive either aspirin or placebo (low-dose clonidine was the other factor being investigated in this trial). Patients were either known to suffer from ischaemic heart disease or were at risk. Patients with a recently implanted coronary stent were excluded. They were stratified depending on whether they were previously already on aspirin therapy. The study confirmed that aspirin is associated with an increased risk of postoperative bleeding, but did not demonstrate any improvement in mortality, cardiac events or stroke.

On the other hand, a prospective observational study of 1200 patients with known cardiovascular disease undergoing major non-cardiac surgery [114] no association between continuation or cessation of aspirin therapy and increased risk of bleeding. Similarly, there was no effect on the incidence of adverse cardiac events.

The ESC/ESA [71], ACC/AHA [57] and CCS [59] guidelines all recommend that aspirin should be continued in patients who have had placement of coronary stents. For other indications the ESC/ESA and ACC/AHA guidelines advise that these should be continued only after individualised risk/benefit consideration. The CCS recommend against the initiation or continuation of aspirin therapy for unstented patients.

2.4.3.7 Calcium Channel Blockers

In a meta-analysis investigating the use of calcium channel blockers in the perioperative period [115], 11 trials with a total of 1007 patients were analysed. This showed a decrease in the composite outcome of death or myocardial infarction, and decreased incidence of supraventricular tachycardia episodes. Subgroup analysis showed the major determinant of the result was diltiazem. Dihydropyridines only feature in 2 of the analysed trials, totalling 113 patients. On the other hand, an observational study of 1000 patients undergoing elective or emergency aortic aneurysm surgery [116],

found an increased incidence of perioperative mortality associated with dihydropyridine use.

There do not seem to be any reports directly investigating the consequences of withdrawing calcium channel blockers in the perioperative period. However, the ESC/ESA guidelines [71] recommend their continuation in patients with vasospastic angina. The CCS [59] advise against initiation of therapy in the preoperative period. The ACC/AHA guidelines [57] consider that there is insufficient evidence to make specific recommendations about this class of drugs.

2.4.4 Timing of the pre-anaesthesia evaluation

The optimum timing of the evaluation is not well defined. The ASA advisory [2] only specifies that the evaluation be performed ‘on or before the day of surgery’. The ESA guidelines [6, 17] suggest lead times of between four and eight weeks to allow optimisation with regards to smoking cessation and alcohol abstinence. However, one must consider that allowing too long a lead time may increase the possibility of significant changes in the patient’s status occurring after the evaluation has taken place.

2.5 Risk Stratification Tools

One of the aims of preoperative assessment is to identify factors which are likely to increase the risk of morbidity and mortality in the perioperative period. While it is useful to make such predictions in a qualitative manner, efforts have gone into developing Risk Stratification Tools (RSTs) which can make quantitative predictions of the risk of adverse outcomes. A wide array of tools have developed for a variety of purposes. Some are intended to facilitate comparisons between different surgical units or institutions, while others are intended to provide personalised estimates of likely outcome. Distinctions have been made between risk scores, which place patients into risk categories, and risk prediction tools, which determine a patient-specific measure of risk [117]. The former are generally easier to determine in clinical practice. The latter tend to use more complex models but their predictions tailored to individual patients. For the purpose of this review, both types are included under the generic term of “risk stratification tool”.

Many such tools have been proposed, as noted in reviews by Barnett and Moonesinghe [118] and Moonesinghe *et al.* [117]. For the purpose of taking clinical decisions regarding surgery, and discussing risk-benefits with patients, a RST must be based completely on data available preoperatively. Tools such as POSSUM [22] and its derivatives, which are based partly on perioperative variables, or the Surgical Apgar Score [119] which depends completely on surgical events, are not suitable for this role.

Of the RSTs based on preoperative predictors, some are restricted to a single body system, such as the RCRI [21], or are intended to be used in specific patient cohorts, such as the EuroSCORE II for cardiac surgery [120] or

the Nottingham Hip Fracture Score (NHFS) for hip fracture fixation [121]. The more targeted RSTs may have better predictive value [122], but are clearly restricted to their intended use case. This review will be restricted to RSTs which are based on multifactorial preoperative predictors, which are applicable to a broad range of surgery types, and have been validated beyond their initial development.

2.5.1 ASA-PS

One of the most widely used scores is the American Society of Anaesthesiologists Physiological Score (ASA-PS) [39]. Originally proposed by Saklad [33] and later modified by Dripps [123, 124] it was initially intended to allow correction for comorbidities in different patient populations in retrospective statistical analyses. It came to be used, however, to express perceived impairment in individual patients. Later studies have provided some justification for this, as the ASA-PS is moderately sensitive in predicting post-operative morbidity, mortality and length of hospital stay [125–128]. In its present form, patients are assigned to one of six classes, indicating perceived degree of impairment as detailed in Table 2.5. In the most recent published description, examples of each category are given to aid the assignment of the score [39].

As discussed in Chapter 9 Section 9.3.2.2, the ASA-PS is a subjective score assigned by the assessor, and is prone to interrater variability.

Table 2.5: American Society of Anaesthesiologists Physiological Status [39]

ASA-PS Class	Definition
I	A normal healthy patient
II	A patient with mild systemic disease
III	A patient with severe systemic disease
IV	A patient with severe systemic disease that is a constant threat to life
V	A moribund patient who is not expected to survive without the operation
VI	A declared brain-dead patient whose organs are being removed for donor purposes

2.5.2 Surgical Risk Scale

The Surgical Risk Scale (SRS) [129] utilises predictors based on National Confidential Enquiry into Peri-Operative Deaths (NCEPOD) urgency, British United Provident Association (BUPA) severity of surgery and ASA-PS to derive a score which was shown to predict inpatient mortality with reasonable accuracy without overpredicting death in low-risk procedures. The scale was later validated in a cohort of higher-risk surgical patients [130].

However, in a study comparing various scores based on POSSUM and SRS in a cohort of patients with complicated diverticular disease [131], and also in an cohort of elderly patients [132], SRS was found to overpredict mortality in young patients and patients with generalised peritonitis. A recent large study validating several RSTs was undertaken using a cohort of 22,631 patients from 274 hospitals in the UK, Australia and New Zealand [133]. This study also found SRS overpredicts risk. On the other hand, two smaller studies [134, 135] report accurate predictions from the SRS.

The simplicity of the SRS makes it an attractive tool to use in clinical practice, taking account of some propensity to overestimate risk. It should be considered that the original dataset on which it is based is now over 20 years old, and in view of changing clinical practice it may be necessary to recalibrate it.

2.5.3 Surgical Mortality Probability Model

The Surgical Mortality Probability Model (SMPM) [136] is very similar to the SRS, being based on the same predictors, although the surgical severity is only scored on 3 categories and urgency on a binary emergency/non-emergency classification. The tool was designed to predict 30-day mortality. The model was based on a random sample of half of a cohort of 322,389 non-cardiac cases obtained from the ACS NSQIP database and validated against the other half. The SMPM gives a nine-point score which corresponds to various levels of predicted mortality. The authors report reasonable accuracy of the score. The tool's validity was further supported by single-centre study with 38,555 patients [137].

2.5.4 Surgical Risk Score

Surgical Risk Score [138] is very similar to the SRS in that it is based on case urgency, severity of surgery and ASA-PS score, but also includes age as a predictor. The tool predicts inpatient mortality. The model has the advantage of using simpler three-category classifications for surgical severity and urgency. It was constructed on data from a mixed cohort of 1,936 surgical patients in two Italian hospitals and validated against a further 1,849. The authors found their score to give predictive accuracy equivalent to POSSUM and P-POSSUM. Although later validated in a study including 4,925 patients across 43 hospitals in Japan [139], this score does not appear to have had any further attention in the literature.

2.5.5 POSPOM

The Preoperative Score to Predict Postoperative Mortality (POSPOM) [140] is a score based on a set of preoperative predictors including age, specific pre-existing comorbidities and the planned surgery type. The tool was developed on a sample of 2,717,902 patients from the French National Hospital Discharge Database and validated against a separate cohort of 2,789,932 patients. The tool was found to accurately predict in-hospital mortality.

In validation studies, POSPOM was found to underestimate mortality in emergency abdominal surgery [141], was reasonably accurate in intermediate and high-risk vascular surgery [142, 143] and overestimated mortality for radical cystectomy [144]. A German adaptation of the POSPOM was successfully validated against a cohort of 199,780 mixed surgical cases [145].

2.5.6 Charlson Indices

The Charlson Comorbidity Index (CCI) [146] was developed to be able estimate increased long-term risk of mortality due to the burden of the number and severity of comorbidities in cohorts of medical patients. In later development, age was added to the index to form the Charlson Age Comorbidity Index (CACI), which proved able to predict early and late mortality in a cohort of surgical patients [147].

The CACI was compared to the ASA-PS score as a predictor of long-term survival after radical prostatectomy in a cohort of 444 patients [148]. Both measures were found useful to identify high-risk patients, although the ASA-PS was superior in identifying the low-risk categories. A validation in a cohort of 279 patients undergoing surgery for colorectal cancer [149] also confirmed the ability of CACI to predict perioperative and long-term mortality, as did a study on a cohort of 497 patients undergoing attempted curative resection for pancreatic cancer [150]. Another study on 257 patients undergoing general surgical procedures [151] also confirmed the accuracy of the tool.

The predictive value of the CACI was examined in a cohort of 195 patients undergoing surgery for hip fractures [152]. It was found to accurately predict mortality at 30 days, 6 months and 1 year and to be equivalent to the NHFS in this context. Using data from New South Wales databases, a cohort of 47,698 elderly patients who suffered hip fracture, Toson *et al.* [153] also found the CCI effective in predicting 30-day and 1-year mortality.

The factors underlying the CCI and CACI were re-examined using data from the California State Inpatient Database [154]. This study developed outcome-specific predictive tools using a derivation cohort of 177,280 patients and a validation cohort of 179,145 patients. Adding age, sex, ethnicity, urgency of surgery and high-risk surgery to the CCI predictors, the tools developed were able to predict inpatient mortality, cardiac morbidity and renal morbidity. Although not directly equivalent to the original CCI, this does support the utility of the underlying factors as predictors of morbidity

and mortality.

2.5.7 ACS NSQIP Universal Surgical Risk Calculator

The ACS NSQIP Universal Surgical Risk Calculator was originally derived from a cohort of 1,414,006 patients from ACS NSQIP database generated from 393 participating hospitals and encompassing 1,557 CPT codes [155]. It is based on 21 preoperative predictors including patient demographics, comorbidities, functional status and surgical procedure and may be modified by a subjective estimate of risk. In addition to the risk of death, the original calculator provided risk estimates for morbidity and 6 specific complications. The calculator is available online*. Since its launch, the calculator has been subject to ongoing refinement as more data became available. It is now based on a patient cohort of over 5 million patients reported from 855 participating hospitals. The calculator predicts the risk of death, the probability of major or any complications, the expected length of hospital stay, the risk of eight specific complications, and likelihood of the need for rehabilitation. While the ongoing refinement assures that the most recent data is used in making clinical predictions, it would complicate comparisons with historical studies based on this tool.

The specific details of the underlying algorithms and weightings of the predictors have not been published in the literature. Furthermore, the underlying dataset is based entirely on US healthcare institutions. The value of this calculator in patients managed in different healthcare systems is unclear.

2.5.8 Surgical Outcome Risk Tool

The Surgical Outcome Risk Tool (SORT) [156] was designed to predict the risk of 30-day mortality in a heterogeneous surgical population. It was derived from data collected in the “Knowing the Risk” study [157] carried out in the UK NHS under the auspices on the National Confidential Enquiry into Peri-Operative Deaths (NCEPOD). The derivation was performed on a cohort of 16,788 patients and validated on a cohort of 5,569 patients. The tool was found to have good predictive value and was well-calibrated. Identified predictors included:

- ASA-PS category
- Urgency of surgery
- Surgical speciality (Gastrointestinal, thoracic and vascular identified as high-risk)
- Severity of surgery
- Cancer

*ACS NSQIP Universal Surgical Risk Calculator: <https://riskcalculator.facs.org>

- Age

A validation on a 2-year cohort of 360140 patients from the New Zealand National Minimum Dataset for patients having surgery [158] found SORT to show good discrimination but poor calibration. These authors derived a similar tool (NZRISK) which added ethnicity and sex as predictors to achieve improved performance. SORT was also validated in a cohort of patients undergoing abdominal surgery in independent UK hospitals [159]. Although its discriminant power was confirmed, it was reported to underestimate mortality in high-risk patients. Similarly, a validation study in a Greek cohort of 526 patients undergoing colorectal procedures [160] found the tool performed well but underestimated mortality. These findings may indicate that the SORT may need specific calibration in different health care systems.

A recent large study validating several RSTs was undertaken [133] using a cohort of 22,631 patients from 274 hospitals in the UK, Australia and New Zealand. This study found that combining subjective risk assessment with objective risk models improved their performance. This led to the development of second version of SORT. A calculator for the SORT v.2 is available online[†]

2.6 Discussion

Although there is extensive literature looking at many aspects of the dataset required to be able to conduct anaesthesia safely and efficiently, there remains significant areas where optimal practice is not clearly supported by a strong evidence base. There is broad consensus that clinical assessment is adequate to assess patients undergoing low-risk surgery. However, the specific data items that are required to make such a judgement are not universally agreed. Furthermore, there are differences in opinion as to what findings in the clinical assessment should instigate more extensive investigation. Similarly, there is variation in recommendations on the extent of investigation warranted in moderate and high-risk surgery. There may thus be scope for divergence of opinion as to best practice in a given situation.

In view of this, it may be of value to investigate the acceptability of the various recommendations in a given cohort of anaesthetists. This would guide efforts to increase the acceptance of guidelines with a strong evidence base. It may also identify those recommendations with a weak evidence base that it may be acceptable to modify to local practice.

[†]Surgical Outcome Risk Tool (SORT) v.2: <http://www.sortsurgery.com>

Chapter 3

Anaesthesia Preoperative Dataset Survey

3.1 Introduction

The review of preoperative assessment guidelines in Chapter 2 shows that, while there is much in common between the various recommendations, there is not complete concordance. Also the strength of the evidence on which these guidelines are based is quite variable. This may lead to some divergence between the guidelines and actual practice.

In fact, published guidelines are not always followed closely in practice [31, 161–164]. A review of barriers to guideline acceptance [165] found that these could be broadly classified into factors related to knowledge, attitude and behaviour. Factors related to knowledge included a lack of awareness of the guidelines or lack of familiarity with them. Factors related to attitude may include a disagreement with the utility of guidelines in general, or concern regarding the validity of a specific set of guidelines. This may be a particular issue with recommendations based heavily on expert opinion, or which are vague or contradictory. In an analysis of preoperative dataset guidelines [166], several of the published recommendations were criticised as being somewhat vague. Consequently, these may not be very compelling to practitioners, particularly if they are working in a clinical environment which is significantly different to that of the guideline developers. Behavioural factors may also be operative when the work environment is not conducive to the implementation of recommendations. This may result in considerable variability in the preoperative datasets considered necessary by different practitioners [19].

3.2 Aim

In view of the above considerations, it would be a useful exercise to determine the opinions of practising anaesthetists in a given institution as to what constitutes adequate preoperative assessment in various circumstances and compare it to the published recommendations.

To this end, a survey was undertaken to determine the importance placed by local practitioners on several aspects of the preoperative assessment.

3.3 Construction of the Questionnaire

Based on the recommendations of the guideline literature reviewed in Chapter 2, a questionnaire was developed to investigate the opinions of anaesthetists on various aspects of the preoperative assessment. The details of this questionnaire are described below. The questionnaire was typeset using the L^AT_EX typesetting package with the Scripts for Data Acquisition with Paper-based Surveys (SDAPS) package extension [167] to allow electronic data capture. It was piloted with two participants. After obtaining feedback, some minor typesetting changes were made and some questions were restructured to facilitate comprehension. The complete questionnaire is shown in Appendix A.

3.3.1 Respondent Characteristics

As the questionnaire was anonymous, no personal identifying information was collected. However, the effect of experience on the responses was of interest, and so grade of respondent and years of experience in the speciality were collected. In order to prevent breaking of anonymity, only broad categories of years of experience were specified.

3.3.2 Patient History and Physical Examination

As discussed in Section 2.4.1.1, the necessary elements of the history and physical examination have been the subject of much debate, culminating in the dataset proposed by Ahmadian *et al.* [32]. There appears to be no published literature assessing the validity of this dataset as assessed by a cohort of practising anaesthetists. In the present study, the clinical items from the patient history and physical examination of the Ahmadian core dataset [32] were presented, and respondents were asked to indicate whether they routinely enquire about each factor in preoperative assessment. They were also asked to assess how useful this information is considered to be on a five-point ordinal scale anchored by the descriptors “useless, little, somewhat, very, extremely”. This scale was used by McPherson *et al.* [47] in a study of airway assessment techniques.

3.3.3 Airway Assessment

Techniques for airway assessment are reviewed in Section 2.4.1.3. The airway tests assessed in the present study were those described in the ESA guidelines on airway evaluation [6] and the clinical items studied in a survey of airway assessment practice carried out by McPherson *et al.* [47]. The

respondents were asked to indicate if they used each test routinely, and to rate the utility of each on the same 5-point scale described in Section 3.3.2.

3.3.4 Preoperative Investigations

Various advisories and recommendations [2, 6, 11, 13, 14, 71] identify the following parameters which may influence the choice of preoperative special investigations.

- Patient Comorbidities
- Functional Capacity
- Nature of Surgery
- Proposed Investigation

An exhaustive questionnaire would require a number of questions equal to the product of the number of items in each set of parameters, even if one were to exclude combinations of comorbidities. In order to retain the questionnaire to a reasonable length, the number of items in each parameter was restricted as detailed below.

This section of the questionnaire was structured as series of case scenarios, representing different patient comorbidities and grade of surgical risk. Respondents were questioned as to the special investigations which would be requested. The format selected has the advantage that it mimics the situations in which a practising anaesthetist would typically make such decisions.

3.3.4.1 Comorbidities

Major comorbidities listed in the ESA [6] and ASA [2] guidelines were considered. A subset consisting of the more common conditions was selected. Uncommon conditions were omitted.

3.3.4.2 Functional Capacity

The ASA-PS is a very widely used measure of overall patient health status. However, as discussed in Sections 2.4.1.2, 2.5.1 and 9.3.2.2, there are frequently significant inconsistencies between anaesthetists in assigning an ASA-PS grade [35, 36]. For this reason a simple “mild”, “moderate” or “severe” functional impairment scale was selected for the purpose of this study. This is scaled against the Duke Activity Status Index (DASI) [40] in the questionnaire. The ASA-PS is also scaled against the DASI.

3.3.4.3 Nature of Surgery

To try and maximise the generalisability of the findings of this study, specific surgical procedures are not considered, but only the anticipated overall impact on the patient. As there is no standard evaluation of procedures the impact of surgery is only identified as low-, intermediate- or high-risk, using the same nomenclature given in various guidelines [6, 13, 14].

3.3.4.4 Proposed Investigations

The utility of various investigations taken preoperatively has been reviewed in Section 2.4.2. Investigations commonly performed at our institution are included in the questionnaire. In order to reduce the total number of questions, some common investigations are bundled together as is standard practice in the local institution. For example, “complete blood count” includes haemoglobin, white blood count, platelet count and various haematological indices. Details of these bundled investigations are given in Table 3.1.

Table 3.1: Laboratory Investigation Bundles

Bundle	Components
<i>Complete Blood Count</i>	Haemoglobin, Red Cell Indices, White Cell Count, Platelet Count
<i>Renal Profile</i>	Urea, Creatinine, eGFR, Na ⁺ , K ⁺ , Cl ⁻
<i>Coagulation Screen</i>	aPTT, INR
<i>Liver Profile</i>	Bilirubin, Alkaline Phosphatase, γ -GT, ALT
<i>Urinalysis</i>	pH, Erythrocytes, WBCs, Nitrites, Glucose, Proteins

For each combination of case scenario and grade of surgery, respondents were asked to grade a selection of investigations as follows:

Unnecessary (U): A test you would not normally request in this scenario
— Leave the row blank

Normally Required (N): A test you would normally request. However, you would still proceed with the case even if the result was not available.

Essential (E): You would postpone the case if the test result is not available.

3.3.5 Concurrent Medications

Many patients presenting for surgery will be receiving treatment for pre-existing comorbidities. Guidelines have been published with recommendations for perioperative management of several common drug classes [6, 71].

The rationale and underlying literature for these recommendations has been reviewed in Section 2.4.3.

3.3.6 Timing

The preoperative assessment may be carried out some days or weeks before the proposed surgery. Furthermore, patients with known comorbidities may have had various special investigations carried out even before the preoperative assessment. Respondents were asked to indicate the length of time these results would be accepted as still valid, assuming the patient has not had any major change in clinical status.

3.4 Method

The questionnaire was distributed to all anaesthetic staff in the Department of Anaesthesia at Mater Dei Hospital, Malta (see Section 1.3). Approximately 3 weeks later an email reminder was sent to encourage further returns. The returned forms were scanned electronically and processed using the SDAPS [167] optical mark reader. The scanned forms were examined visually to verify correct scanning. Free text entries were transcribed for further analysis. The data were then exported to the R (version 3.0.2) statistics package [168] for analysis.

The categorical data were summarised as frequency tables. Assessment of functional capacity was investigated by determining median values and displayed as box-plots.

The survey protocol was approved by the University of Malta Research Ethics Committee and the study authorised by the relevant hospital authorities.

3.5 Results and Relevant Discussion

A total of 87 questionnaires were distributed and 25 were returned, corresponding to a return rate of 29%. Results are shown in the following tables. Some respondents did not respond to all questions. Hence, in some tables, the sum of responses may be less than the number of survey forms returned.

3.5.1 Respondent Characteristics

The number of respondents in each grade is shown in Table 3.2, and their experience is shown in Table 3.3. The large majority of respondents had more than 5 years of experience in the speciality. Due to the small numbers of respondents in each subgroup, subgroup analysis was not performed.

Table 3.2: Grade of Respondent

<i>Grade</i>	n
<i>Trainee</i>	6
<i>Resident Specialist</i>	11
<i>Consultant</i>	8
<i>Unspecified</i>	0

Table 3.3: Experience in Anaesthesia

<i>Years of Experience</i>	n
<i><5</i>	4
<i>5-10</i>	6
<i>>10</i>	13
<i>Unspecified</i>	2

3.5.2 Patient History

The perceived utility of various aspects of the patient history and physical examination are presented below. For brevity, in the relevant tables, the ordinal scale descriptors “useless, little, somewhat, very, extremely” are abbreviated to “U”, “L”, “S”, “V” and “E” respectively.

3.5.2.1 Presenting Complaint

The responses for questions pertaining to the presenting complaint are shown in Table 3.4. Most respondents indicated that they asked these questions routinely and considered them of importance. Of least significance was the question related to acceptance of blood products. Such objections are uncommon in the local context, and this information would almost certainly be volunteered spontaneously.

Table 3.4: Presenting Complaint

	Routine (% n=25)	U	L	S	V	E	n
		(%)					
<i>Current surgical diagnoses</i>	96	0	5	14	41	41	22
<i>Planned procedure</i>	96	0	5	5	43	48	21
<i>Blood loss risk</i>	84	0	0	18	32	50	22
<i>Limitation to accepting blood products</i>	68	0	5	29	24	43	21

Key: **U**-Useless **L**-Little **S**-Somewhat **V**-Very **E**-Extremely

3.5.2.2 Medical History

The responses for questions pertaining to the past medical history are shown in Table 3.5. While most of the conditions found to be of core relevance by Ahmadian *et al.* [32] were rated as ‘very’ or ‘extremely’ important by the respondents, there were some exceptions. For example, a history of Parkinson’s disease, psychiatric conditions and impaired glucose tolerance were rated as only ‘somewhat important’ or even lower priority by a majority of respondents. Additionally, several conditions were not included in a routine enquiry, even if considered important. One may speculate that the practitioner may have expected the patient to volunteer the information in relation to another, more generic question. For example, while not asking specifically about diabetic complications, it may be expected the patient would volunteer this while being asked about the presence of diabetes.

3.5.2.3 Medication History

The responses for questions pertaining to the past medication history are shown in Table 3.6. This information was considered of great importance by most respondents. A history of allergy was considered extremely important by most respondents and was, in fact, the only element of the patient history enquired about by all respondents.

3.5.2.4 Anaesthesia & Surgical History

The responses for questions pertaining to the anaesthetic and surgical history are shown in Table 3.7. Most respondents routinely asked about previous surgery, anaesthetic complications including Post-Operative Nausea and Vomiting (PONV), and a family history of complications. A history of anaesthetic complications was rated as extremely important by most respondents, while surgical history, family history and history of PONV were given somewhat less weight.

3.5.2.5 Social History

The responses for questions pertaining to the social history are shown in Table 3.8. It was common to enquire about alcohol consumption and smoking history. It was somewhat less common to enquire about drug abuse, possibly due to related social stigma and legal implications.

3.5.2.6 Systemic Enquiry

The responses for questions pertaining to the systemic enquiry are shown in Table 3.9. Most questions for specific systems were asked by the majority of respondents and were considered to be “very” or “extremely” important. Questions related to bleeding tendency were considered to be of intermediate importance. Questions related to lumbar symptoms were only asked by a minority of respondents and were not considered to be of much importance.

Table 3.5: Comorbidities

	Routine (% n=25)	U	L	S	V	E	n
				(%)			
<i>Ischaemic heart disease</i>	96	0	0	5	25	70	20
<i>Arrythmia</i>	80	0	0	6	44	50	18
<i>Myocardial infarction</i>	84	0	0	5	16	79	19
<i>Coronary artery bypass graft</i>	68	0	0	21	26	53	19
<i>Heart valve replacement</i>	64	0	0	25	30	45	20
<i>Heart transplantation</i>	24	0	16	16	32	37	19
<i>Other heart disease</i>	56	0	6	25	38	31	16
<i>Percutaneous coronary intervention</i>	64	0	0	24	35	41	17
<i>Congestive heart failure</i>	84	0	0	6	44	50	18
<i>Congenital heart disease</i>	40	0	5	40	30	25	20
<i>Presence of pacemaker</i>	76	0	0	11	28	61	18
<i>Presence of implanted defibrillator</i>	64	0	0	12	24	65	17
<i>Diagnosed hypertension</i>	92	0	0	21	42	37	19
<i>Cerebrovascular diseases</i>	84	0	0	21	32	47	19
<i>Peripheral vascular disorders</i>	44	0	16	32	37	16	19
<i>Great vessel (aortic) disorders</i>	36	0	16	26	32	26	19
<i>Malignancy(active)</i>	36	0	10	38	43	10	21
<i>Chronic obstructive pulmonary disease</i>	88	0	0	5	50	45	20
<i>Obstructive sleep apnoea</i>	68	0	0	5	53	42	19
<i>Asthma</i>	84	0	0	15	45	40	20
<i>Renal failure</i>	80	0	0	17	50	33	18
<i>Hepatitis</i>	52	0	14	29	29	29	21
<i>Liver cirrhosis</i>	40	0	5	26	42	26	19
<i>Coagulation disorders</i>	68	0	0	21	42	37	19
<i>Anaemia</i>	52	0	11	16	47	26	19
<i>Diabetes mellitus</i>	96	0	0	20	35	45	20
<i>Complications of diabetes mellitus</i>	48	0	16	26	26	32	19
<i>Glucose intolerance</i>	8	11	22	33	22	11	18
<i>Thyroid disorder</i>	68	0	5	25	45	25	20
<i>Musculoskeletal diseases</i>	32	0	10	29	43	19	21
<i>Rheumatoid diseases</i>	36	0	16	26	37	21	19
<i>Spinal surgery or injury</i>	56	0	16	26	32	26	19
<i>Parkinson's disease</i>	28	0	15	55	20	10	20
<i>Cerebral aneurysm</i>	28	0	10	35	20	35	20
<i>Epilepsy</i>	60	0	10	20	40	30	20
<i>Neuromuscular disease</i>	68	0	5	16	47	32	19
<i>Psychiatric disorders</i>	48	6	28	39	17	11	18

Key: **U**-Useless **L**-Little **S**-Somewhat **V**-Very **E**-Extremely

Table 3.6: Medication History

	Routine (% n=25)	U	L	S	V	E	n
		(%)					
<i>Current medications</i>	96	0	0	5	43	52	21
<i>Medication side effects</i>	64	5	5	38	19	33	21
<i>Allergies</i>	100	0	0	0	10	90	21

Key: **U**-Useless **L**-Little **S**-Somewhat **V**-Very **E**-Extremely

Table 3.7: Anaesthetic and Surgical History

	Routine (% n=25)	U	L	S	V	E	n
		(%)					
<i>Previous surgeries</i>	92	5	0	20	50	25	20
<i>Previous anaesthesia complications</i>	96	0	0	0	10	90	20
<i>Family history of anaesthesia complications</i>	88	0	5	5	41	50	22
<i>History of post-operative nausea and vomiting</i>	88	0	0	25	35	40	20

Key: **U**-Useless **L**-Little **S**-Somewhat **V**-Very **E**-Extremely

Table 3.8: Social History

	Routine (% n=25)	U	L	S	V	E	n
		(%)					
<i>Smoking history</i>	96	0	0	24	62	14	21
<i>Alcohol consumption</i>	88	0	5	33	57	5	21
<i>Drug abuse</i>	72	0	0	33	48	19	21

Key: **U**-Useless **L**-Little **S**-Somewhat **V**-Very **E**-Extremely

Table 3.9: Systemic Enquiry

	Routine (% n=25)	U	L	S	V	E	n
		(%)					
<i>Exercise tolerance</i>	92	0	0	9	23	68	22
<i>Chest pain</i>	92	0	0	5	38	57	21
<i>Palpitations</i>	76	0	5	10	55	30	20
<i>Dyspnoea</i>	88	0	0	5	52	43	21
<i>Bleeding tendency</i>	56	0	5	30	40	25	20
<i>Heartburn/Reflux</i>	96	0	0	18	50	32	22
<i>Cervical pain or stiffness</i>	84	0	0	24	38	38	21
<i>Lumbar pain or stiffness</i>	24	0	20	40	25	15	20

Key: **U**-Useless **L**-Little **S**-Somewhat **V**-Very **E**-Extremely

3.5.3 Physical Examination

The responses for questions pertaining to the physical examination are shown in Table 3.10. Agitation and Glasgow Coma Score (GCS) were least used and considered to be of little importance. This may be due to respondents considering their responses in the context of scheduled or elective surgery.

Table 3.10: Physical Examination

	Routine (% n=25)	U	L	S	V	E	n
		(%)					
<i>Weight</i>	92	0	5	14	59	23	22
<i>Height</i>	64	5	5	41	36	14	22
<i>Pulse rate</i>	92	0	5	14	52	29	21
<i>Blood pressure</i>	100	0	0	10	55	35	20
<i>Heart auscultation</i>	84	0	5	27	45	23	22
<i>Lung auscultation</i>	92	0	10	10	57	24	21
<i>Difficulty in communication</i>	68	0	9	36	50	5	22
<i>Richmond Agitation Seda- tion Scale</i>	4	14	29	48	10	0	21
<i>Glasgow Coma Scale</i>	28	17	22	30	26	4	23

Key: **U**-Useless **L**-Little **S**-Somewhat **V**-Very **E**-Extremely

3.5.4 Airway Assessment

The responses for questions pertaining to airway assessment are shown in Table 3.11. In keeping with recommendations mandating airway assessment [2, 6, 17, 169], virtually all respondents reported using at least one airway assessment method routinely. Of the methods investigated, the most commonly used by the study cohort were mouth opening, Mallampati grade, neck mobility and an assessment of dental status. The Mallampati grade and mouth opening were also the most commonly used tests in the cohorts of UK and EU anaesthetists studied by McPherson *et al.* [47].

Table 3.11: Airway Assessment

	Routine (% n=25)	U	L	S	V	E	n
		(%)					
<i>History of snoring</i>	76	0	5	45	41	9	22
<i>Age</i>	72	0	15	35	45	5	20
<i>Body Mass Index</i>	76	0	0	10	75	15	20
<i>Presence of beard</i>	60	0	21	26	37	16	19
<i>Craniofacial abnormalities</i>	84	0	0	5	55	41	22
<i>Neck length (qualitative)</i>	56	0	17	28	44	11	18
<i>Neck circumference (qualitative)</i>	44	5	11	26	47	11	19
<i>Thyromental distance</i>	76	0	16	11	58	16	19
<i>Sternomental distance</i>	20	0	32	42	16	11	19
<i>Jaw protrusion</i>	56	0	9	41	41	9	22
<i>Mouth opening</i>	96	0	0	5	52	43	21
<i>Mallampati grade</i>	96	0	0	15	55	30	20
<i>Dental Status</i>	92	0	0	32	32	37	19
<i>Prominent Incisors</i>	64	0	15	20	55	10	20
<i>Retrognathism</i>	56	5	10	25	45	15	20
<i>Upper lip bite test</i>	28	7	21	50	14	7	14
<i>Oropharyngeal abnormalities</i>	56	0	5	20	50	25	20
<i>Shape of hard palate</i>	16	6	11	56	22	6	18
<i>Compliance of mandibular space</i>	8	6	18	65	6	6	17
<i>Neck range of movement</i>	80	0	5	18	55	23	22
<i>Nodding donkey test</i>	4	0	45	45	9	0	11
<i>Dalalkin warning sign</i>	4	0	50	40	10	0	10
<i>Prayer sign or Palm print test</i>	8	13	20	60	7	0	15
<i>Indirect (mirror) laryngoscopy</i>	4	0	47	27	27	0	15
<i>Flexible nasendoscopy</i>	4	0	33	27	40	0	15
<i>Wilson score</i>	20	0	38	25	25	12	16
<i>El-Ganzouri score</i>	8	0	55	45	0	0	11

Key: **U**-Useless **L**-Little **S**-Somewhat **V**-Very **E**-Extremely

3.5.5 Functional Capacity

The degree of impairment associated with the various items of the DASI [40] are shown in Table 3.12. A box-and-whiskers plot for the score weightings, in METs, determined by Hlatky *et al.* [40] against the impairment severity determined in this study is shown in Figure 3.1. For mild impairment, the corresponding median Duke weighting was 5.5, related to the activity “Can climb a flight of stairs or walk up a hill”. For moderate impairment the median Duke weighting was 2.75, corresponding to “Can walk one or two blocks on level ground”. These two statements could be a useful basis to distinguish mild and moderate/severe impairment in a preoperative questionnaire. This corresponds to the use of 4 METs as a discriminator in identifying patients at increased perioperative risk [14], but is somewhat less than the cutoff identified by Wijesundera *et al.* [72] (see Section 2.4.1.2).

A similar assessment was made for the Duke Activity items by ASA-PS grade. These are shown in Table 3.13. The corresponding box-and-whiskers plot is shown in Figure 3.2. The most relevant distinction was between ASA 2, with a median Duke Score weighting of 4.5, and ASA 3 with a score of 2.75.

Figure 3.1: Duke’s Activity Score by Estimated Impairment

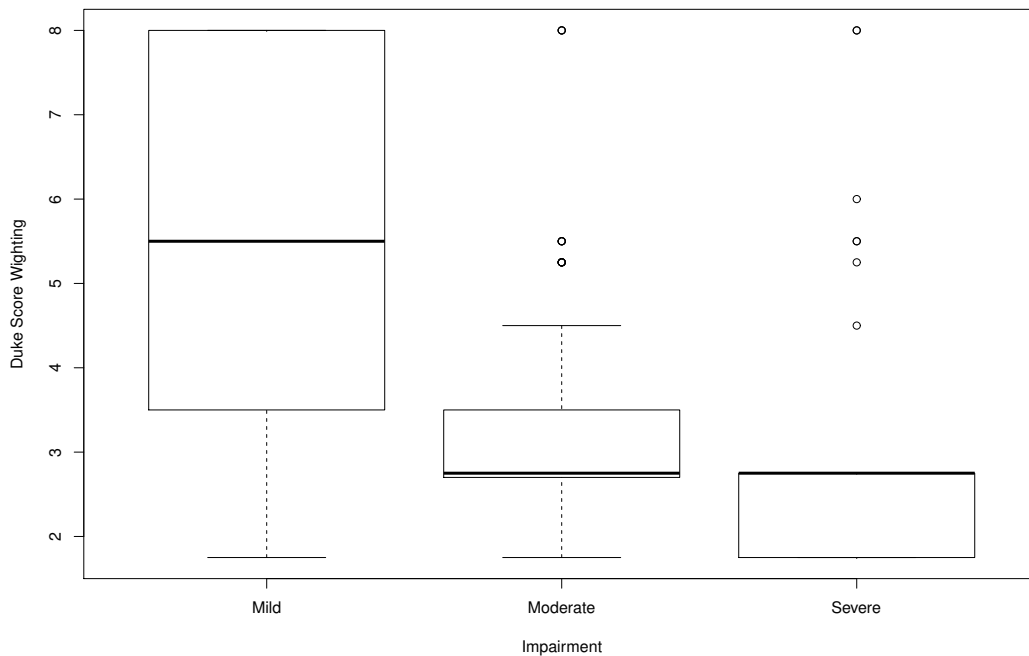

Table 3.12: Frequency Distribution of Functional Capacity Assessment

	Level of Impairment (%)			n
	Mild	Moderate	Severe	
<i>Can perform activities of daily living like eating, dressing, bathing or using the toilet</i>	18	27	55	22
<i>Can walk around indoors</i>	4	52	43	23
<i>Can walk one or two blocks on level ground</i>	48	43	9	23
<i>Can climb a flight of stairs or walk up a hill</i>	70	20	10	20
<i>Can run a short distance</i>	80	15	5	20
<i>Can do light housework like dusting or washing dishes</i>	18	68	14	22
<i>Can do moderate housework like vacuuming, sweeping floors or carrying groceries</i>	59	41	0	22
<i>Can do heavy housework like scrubbing floors, lifting or moving heavy furniture</i>	94	0	6	18
<i>Can do yardwork like raking weeds or pushing a power mower</i>	79	16	5	19
<i>Can have sexual relations</i>	61	33	6	18
<i>Can participate in moderate recreational activities like golf, bowling, dancing, doubles tennis or throwing a baseball or football</i>	94	0	6	18

Table 3.13: Frequency Distribution of ASA-PS Functional Capacity Assessment

	ASA-PS (%)				n
	1	2	3	4	
<i>Can perform activities of daily living like eating, dressing, bathing or using the toilet</i>	4	22	61	13	23
<i>Can walk around indoors</i>	0	27	50	23	22
<i>Can walk one or two blocks on level ground</i>	4	50	46	0	24
<i>Can climb a flight of stairs or walk up a hill</i>	36	59	5	0	22
<i>Can run a short distance</i>	61	39	0	0	23
<i>Can do light housework like dusting or washing dishes</i>	4	57	35	4	23
<i>Can do moderate housework like vacuuming, sweeping floors or carrying groceries</i>	35	52	13	0	23
<i>Can do heavy housework like scrubbing floors, lifting or moving heavy furniture</i>	64	36	0	0	22
<i>Can do yardwork like raking weeds or pushing a power mower</i>	61	30	9	0	23
<i>Can have sexual relations</i>	36	41	23	0	22
<i>Can participate in moderate recreational activities like golf, bowling, dancing, doubles tennis or throwing a baseball or football</i>	62	33	4	0	24

Figure 3.2: Duke's Activity Score by ASA-PS

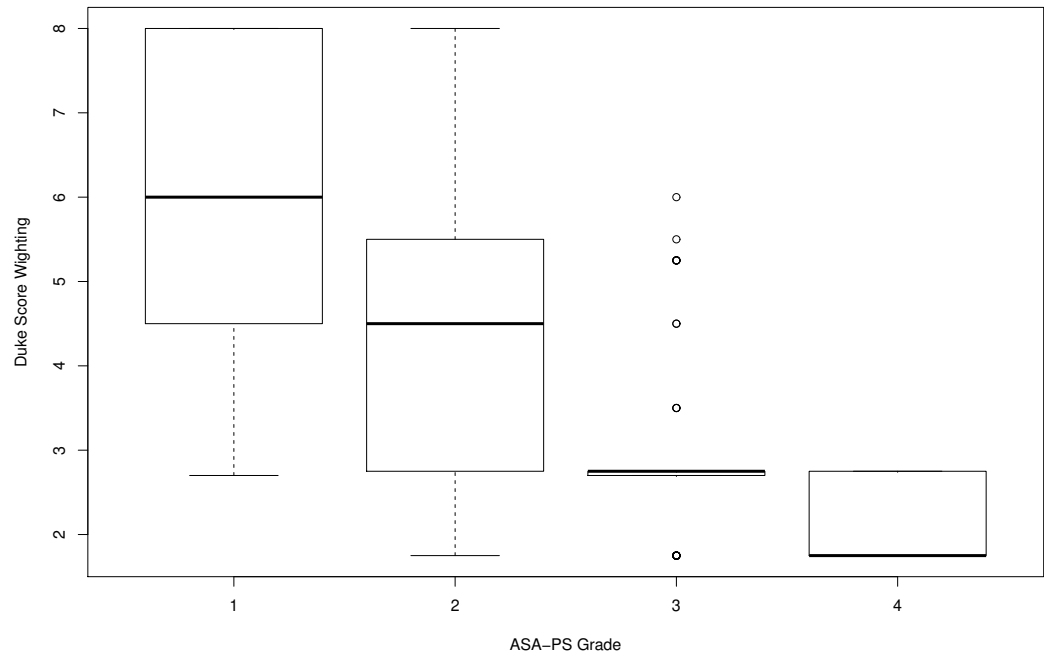

3.5.6 Special Investigations

The responses for preoperative investigations required in various clinical scenarios are shown in Tables 3.14 to 3.37 (page 3.14). Due to the design of the questionnaire it was not possible to determine if a respondent intended to indicate that an investigation was unnecessary, or simply omitted to make a response to the question.

In common with similar studies [31, 164], the participants in this survey had a tendency to over-investigate preoperative patients, compared to guideline recommendations discussed in Section 2.4.2. Even when considering a young, healthy patient undergoing low-risk surgery (Table 3.14), a significant number of anaesthetists indicated that various investigations were desirable, although few considered these essential. The guidelines indicate that laboratory and other special investigations add little to the clinical assessment of preoperative patients with normal clinical findings and no known comorbidities. Increasing patient age, the presence of comorbidities and increasing surgical risk were all associated with a tendency to request more investigations and for these to be considered of greater importance.

The tests most frequently requested and considered most valuable were Electrocardiogram (ECG), CBC, renal profile and coagulation screen. The presence of comorbidities increased the frequency of ordering special investigations relevant to the specific medical conditions. This tendency increased with worsening patient functional impairment and increased surgical risk. Thus, echocardiography, cardiac stress testing and angiography are more commonly requested for patients with limiting cardiovascular disease. Blood gases, spirometry and pulse oximetry were recommended for patients with respiratory conditions.

Further investigation into the reasons for the reported divergence of the respondents' practice from the various guidelines may be a useful area of research.

Table 3.14: Assessment of investigation importance for a 35 year old with **no known medical problems** undergoing this grade of surgery:

	Surgical Risk								
	Low			Intermed.			High		
	U	N	E	U	N	E	U	N	E
<i>ECG</i>	16	7	2	5	14	6	1	7	17
<i>CXR</i>	22	3	0	20	4	1	8	10	7
<i>CBC</i>	14	10	1	4	15	6	0	5	20
<i>Renal</i>	18	6	1	9	12	4	2	6	17
<i>Coag</i>	20	5	0	13	10	2	6	7	12
<i>RBG</i>	21	2	2	17	6	2	8	11	6
<i>LFT</i>	23	1	1	22	3	0	13	8	4
<i>Se. Albumin</i>	23	1	1	23	2	0	19	5	1
<i>Urinalysis</i>	22	1	2	19	5	1	16	5	4

Key: **U**-Unnecessary **N**-Necessary **E**-EssentialTable 3.15: Assessment of investigation importance for a 75 year old with **no known medical problems** undergoing this grade of surgery:

	Surgical Risk								
	Low			Intermed.			High		
	U	N	E	U	N	E	U	N	E
<i>ECG</i>	0	10	14	1	4	20	0	1	24
<i>CXR</i>	12	11	2	8	11	6	5	4	16
<i>CBC</i>	1	12	12	0	8	17	0	2	23
<i>Renal</i>	2	14	9	1	9	15	0	2	23
<i>Coag</i>	17	5	3	11	4	10	4	3	18
<i>RBG</i>	9	11	5	4	10	11	2	6	17
<i>LFT</i>	22	3	0	18	5	2	10	9	6
<i>Se. Albumin</i>	23	2	0	21	3	1	17	5	3
<i>Urinalysis</i>	19	1	5	17	3	5	18	2	5

Key: **U**-Unnecessary **N**-Necessary **E**-Essential

Table 3.16: Assessment of investigation importance for an **obese patient** (BMI > 35kg.m⁻²) undergoing this grade of surgery:

	Surgical Risk								
	Low			Intermed.			High		
	U	N	E	U	N	E	U	N	E
<i>ECG</i>	1	13	11	1	6	18	1	1	23
<i>CXR</i>	14	9	2	12	9	4	7	6	12
<i>CBC</i>	5	13	7	2	11	12	2	2	21
<i>Renal</i>	7	10	8	3	9	13	2	2	21
<i>Coag</i>	17	7	1	11	6	8	6	3	16
<i>RBG</i>	6	12	7	3	9	13	2	3	20
<i>LFT</i>	17	6	2	13	9	3	11	4	10
<i>Se. Albumin</i>	22	3	0	21	4	0	18	5	2
<i>Urinalysis</i>	20	2	2	20	3	2	19	2	4

Key: **U**-Unnecessary **N**-Necessary **E**-Essential

Table 3.17: Assessment of investigation importance for a **heavy smoker** undergoing this grade of surgery:

	Surgical Risk								
	Low			Intermed.			High		
	U	N	E	U	N	E	U	N	E
<i>ECG</i>	1	11	13	2	4	19	1	1	23
<i>CXR</i>	8	12	5	4	8	13	4	2	19
<i>CBC</i>	4	17	4	1	8	16	0	2	23
<i>Renal</i>	9	13	3	5	8	12	1	3	21
<i>Coag</i>	19	6	0	12	9	4	5	6	14
<i>RBG</i>	16	8	1	11	9	5	4	9	12
<i>LFT</i>	22	3	0	21	4	0	16	4	5
<i>Se. Albumin</i>	24	1	0	22	3	0	19	4	2
<i>Urinalysis</i>	23	0	2	21	1	3	19	1	5
<i>Spirometry</i>	10	13	2	3	8	14	1	8	16
<i>ABG</i>	22	3	0	16	7	2	6	6	13
<i>VBG</i>	24	1	0	21	3	1	18	4	3
<i>SpO₂</i>	4	8	13	3	3	19	3	1	21

Key: **U**-Unnecessary **N**-Necessary **E**-Essential

Table 3.18: Assessment of investigation importance for a patient with **well-controlled hypertension** undergoing this grade of surgery:

	Surgical Risk								
	Low			Intermed.			High		
	U	N	E	U	N	E	U	N	E
<i>ECG</i>	0	12	13	0	5	20	0	1	24
<i>CXR</i>	18	6	1	12	11	2	8	7	10
<i>CBC</i>	9	13	3	4	12	9	0	3	22
<i>Renal</i>	6	13	6	0	11	14	0	3	22
<i>Coag</i>	20	5	0	15	7	3	9	4	12
<i>RBG</i>	15	8	2	10	11	4	4	9	12
<i>LFT</i>	24	1	0	21	3	1	15	7	3
<i>Se. Albumin</i>	24	1	0	23	2	0	20	2	3
<i>Urinalysis</i>	19	3	3	17	4	4	14	3	8

Key: **U**-Unnecessary **N**-Necessary **E**-EssentialTable 3.19: Assessment of investigation importance for a patient suffering from **stable ischaemic heart disease** with **minor functional impairment** undergoing this grade of surgery:

	Surgical Risk								
	Low			Intermed.			High		
	U	N	E	U	N	E	U	N	E
<i>ECG</i>	1	5	19	1	3	21	2	1	22
<i>CXR</i>	15	6	4	10	10	5	5	6	14
<i>CBC</i>	4	11	10	2	7	16	1	2	22
<i>Renal</i>	7	10	8	6	4	15	1	2	22
<i>Coag</i>	16	7	2	13	5	7	10	2	13
<i>RBG</i>	8	14	3	6	11	8	3	7	15
<i>LFT</i>	20	4	1	19	4	2	15	6	4
<i>Se. Albumin</i>	22	3	0	22	2	1	19	4	2
<i>Urinalysis</i>	22	0	3	21	1	3	18	2	5
<i>Stress Test</i>	18	6	1	15	8	2	8	10	7
<i>Echocardiogram</i>	20	5	0	14	10	1	5	11	9
<i>Angiogram</i>	22	3	0	22	3	0	18	5	2

Key: **U**-Unnecessary **N**-Necessary **E**-Essential

Table 3.20: Assessment of investigation importance for a patient suffering from **stable ischaemic heart disease** with **moderate functional impairment** undergoing this grade of surgery:

	Surgical Risk								
	Low			Intermed.			High		
	U	N	E	U	N	E	U	N	E
<i>ECG</i>	2	3	20	1	3	21	2	2	21
<i>CXR</i>	9	11	5	8	7	10	5	2	18
<i>CBC</i>	2	9	14	1	4	20	1	2	22
<i>Renal</i>	6	6	13	3	5	17	1	2	22
<i>Coag</i>	12	7	6	9	9	7	6	3	16
<i>RBG</i>	6	14	5	5	13	7	3	8	14
<i>LFT</i>	20	3	2	18	3	4	13	6	6
<i>Se. Albumin</i>	22	2	1	21	3	1	18	6	1
<i>Urinalysis</i>	20	2	3	19	2	4	19	1	5
<i>Stress Test</i>	16	6	3	9	13	3	7	7	11
<i>Echocardiogram</i>	13	10	2	6	14	5	2	3	20
<i>Angiogram</i>	20	5	0	18	5	2	15	4	6

Key: **U**-Unnecessary **N**-Necessary **E**-Essential

Table 3.21: Assessment of investigation importance for a patient suffering from **stable ischaemic heart disease** with **major functional impairment** undergoing this grade of surgery:

	Surgical Risk								
	Low			Intermed.			High		
	U	N	E	U	N	E	U	N	E
<i>ECG</i>	1	3	21	1	3	21	1	1	23
<i>CXR</i>	5	9	11	4	7	14	2	5	18
<i>CBC</i>	2	5	17	3	3	19	2	2	21
<i>Renal</i>	5	3	16	2	4	19	1	3	21
<i>Coag</i>	10	8	7	10	4	11	8	2	15
<i>RBG</i>	5	11	9	4	9	12	3	8	14
<i>LFT</i>	18	3	4	18	2	5	10	5	10
<i>Se. Albumin</i>	21	2	2	20	3	2	17	2	6
<i>Urinalysis</i>	20	1	4	19	1	5	17	3	5
<i>Stress Test</i>	9	11	5	7	8	10	9	6	10
<i>Echocardiogram</i>	5	9	11	4	5	16	5	3	17
<i>Angiogram</i>	16	7	2	14	7	4	8	6	11

Key: **U**-Unnecessary **N**-Necessary **E**-Essential

Table 3.22: Assessment of investigation importance for a patient suffering from **congestive heart failure** with **minor functional impairment** undergoing this grade of surgery:

	Surgical Risk								
	Low			Intermed.			High		
	U	N	E	U	N	E	U	N	E
<i>ECG</i>	2	7	16	2	5	18	2	2	21
<i>CXR</i>	5	12	8	3	9	13	2	5	18
<i>CBC</i>	2	9	14	2	6	17	2	2	21
<i>Renal</i>	2	11	12	2	7	16	2	3	20
<i>Coag</i>	9	12	4	8	10	7	7	3	15
<i>RBG</i>	10	10	5	4	13	8	3	9	13
<i>LFT</i>	17	6	2	13	7	5	11	5	9
<i>Se. Albumin</i>	21	3	1	20	2	3	19	3	3
<i>Urinalysis</i>	20	2	3	19	2	4	18	2	5
<i>Stress Test</i>	19	5	1	18	6	1	12	8	5
<i>Echocardiogram</i>	10	13	2	6	11	8	4	5	16
<i>Angiogram</i>	21	4	0	21	3	1	18	3	4

Key: **U**-Unnecessary **N**-Necessary **E**-Essential

Table 3.23: Assessment of investigation importance for a patient suffering from **congestive heart failure** with **moderate functional impairment** undergoing this grade of surgery:

	Surgical Risk								
	Low			Intermed.			High		
	U	N	E	U	N	E	U	N	E
<i>ECG</i>	3	6	16	4	4	17	5	1	19
<i>CXR</i>	5	8	12	4	8	13	4	3	18
<i>CBC</i>	3	6	16	5	4	16	5	1	19
<i>Renal</i>	3	6	16	5	5	15	5	2	18
<i>Coag</i>	13	7	5	10	9	6	9	3	13
<i>RBG</i>	8	11	6	7	10	8	8	4	13
<i>LFT</i>	16	6	3	12	7	6	12	3	10
<i>Se. Albumin</i>	20	4	1	18	4	3	17	4	4
<i>Urinalysis</i>	19	2	4	19	1	5	18	2	5
<i>Stress Test</i>	17	7	1	16	7	2	13	6	6
<i>Echocardiogram</i>	10	8	7	5	7	13	4	3	18
<i>Angiogram</i>	21	3	1	20	4	1	17	4	4

Key: **U**-Unnecessary **N**-Necessary **E**-Essential

Table 3.24: Assessment of investigation importance for a patient suffering from **congestive heart failure** with **major functional impairment** undergoing this grade of surgery:

	Surgical Risk								
	Low			Intermed.			High		
	U	N	E	U	N	E	U	N	E
<i>ECG</i>	3	2	20	4	2	19	3	1	21
<i>CXR</i>	4	6	15	3	3	19	3	2	20
<i>CBC</i>	3	4	18	3	3	19	3	2	20
<i>Renal</i>	4	4	17	3	3	19	3	2	20
<i>Coag</i>	7	8	10	7	7	11	6	3	16
<i>RBG</i>	5	12	8	4	10	11	5	6	14
<i>LFT</i>	11	9	5	7	9	9	6	5	14
<i>Se. Albumin</i>	16	6	3	14	6	5	14	4	7
<i>Urinalysis</i>	18	1	6	17	2	6	16	3	6
<i>Stress Test</i>	16	6	3	14	6	5	14	5	6
<i>Echocardiogram</i>	5	9	11	5	5	15	4	3	18
<i>Angiogram</i>	19	4	2	19	2	4	14	4	7

Key: U-Unnecessary N-Necessary E-Essential

Table 3.25: Assessment of investigation importance for a patient suffering from **Chronic Obstructive Pulmonary Disease** with **minor functional impairment** undergoing this grade of surgery:

	Surgical Risk								
	Low			Intermed.			High		
	U	N	E	U	N	E	U	N	E
<i>ECG</i>	4	9	12	3	6	16	3	3	19
<i>CXR</i>	10	9	6	7	4	14	6	1	18
<i>CBC</i>	7	10	8	4	8	13	3	2	19
<i>Renal</i>	11	9	5	4	12	9	4	2	18
<i>Coag</i>	18	5	2	14	6	5	10	5	10
<i>RBG</i>	14	8	3	12	8	5	9	6	10
<i>LFT</i>	23	1	1	20	3	2	18	3	4
<i>Se. Albumin</i>	23	1	1	21	2	2	20	2	3
<i>Urinalysis</i>	21	1	3	19	2	4	17	3	5
<i>Spirometry</i>	11	11	2	7	8	10	3	8	14
<i>ABG</i>	22	2	0	14	10	1	7	6	12
<i>VBG</i>	24	1	0	24	1	0	20	3	2
<i>SpO₂</i>	6	10	9	6	4	15	3	2	20

Key: U-Unnecessary N-Necessary E-Essential

Table 3.26: Assessment of investigation importance for a patient suffering from **Chronic Obstructive Pulmonary Disease** with **moderate functional impairment** undergoing this grade of surgery:

	Surgical Risk								
	Low			Intermed.			High		
	U	N	E	U	N	E	U	N	E
<i>ECG</i>	4	8	13	5	5	15	3	2	20
<i>CXR</i>	7	6	12	6	2	17	5	1	19
<i>CBC</i>	5	9	11	4	3	18	4	1	20
<i>Renal</i>	8	10	7	5	7	13	3	3	19
<i>Coag</i>	16	4	5	13	6	6	9	4	12
<i>RBG</i>	14	6	5	10	9	6	9	5	11
<i>LFT</i>	22	2	1	19	3	3	16	2	6
<i>Se. Albumin</i>	22	2	1	20	3	2	19	3	3
<i>Urinalysis</i>	20	2	3	20	1	4	20	1	4
<i>Spirometry</i>	5	15	5	4	6	15	3	4	18
<i>ABG</i>	20	3	2	6	9	10	6	5	14
<i>VBG</i>	23	1	1	24	1	0	20	4	1
<i>SpO₂</i>	5	8	12	5	2	18	4	1	20

Key: **U**-Unnecessary **N**-Necessary **E**-Essential

Table 3.27: Assessment of investigation importance for a patient suffering from **Chronic Obstructive Pulmonary Disease** with **major functional impairment** undergoing this grade of surgery:

	Surgical Risk								
	Low			Intermed.			High		
	U	N	E	U	N	E	U	N	E
<i>ECG</i>	4	5	16	4	5	16	4	2	19
<i>CXR</i>	7	4	14	4	3	18	4	2	19
<i>CBC</i>	5	3	17	4	3	18	4	2	19
<i>Renal</i>	6	5	14	4	5	16	5	2	18
<i>Coag</i>	13	5	7	11	4	10	8	3	14
<i>RBG</i>	12	7	6	10	8	7	10	4	11
<i>LFT</i>	19	3	3	15	7	3	15	3	7
<i>Se. Albumin</i>	21	2	2	19	3	3	19	2	4
<i>Urinalysis</i>	19	3	3	18	4	3	18	2	5
<i>Spirometry</i>	5	8	12	5	5	15	5	2	18
<i>ABG</i>	11	5	9	5	10	10	4	3	18
<i>VBG</i>	24	1	0	23	1	1	19	3	3
<i>SpO₂</i>	6	4	15	7	3	15	5	1	19

Key: **U**-Unnecessary **N**-Necessary **E**-Essential

Table 3.28: Assessment of investigation importance for a patient suffering from **well controlled asthma** undergoing this grade of surgery:

	Surgical Risk								
	Low			Intermed.			High		
	U	N	E	U	N	E	U	N	E
<i>ECCG</i>	12	7	6	9	7	9	6	4	15
<i>CXR</i>	17	5	3	11	8	6	6	7	12
<i>CBC</i>	11	8	6	6	7	12	4	4	17
<i>Renal</i>	16	6	3	10	8	7	5	4	16
<i>Coag</i>	21	3	1	16	6	3	12	3	10
<i>RBG</i>	20	3	2	14	7	4	10	9	6
<i>LFT</i>	24	1	0	23	2	0	20	3	2
<i>Se. Albumin</i>	24	1	0	23	2	0	20	2	3
<i>Urinalysis</i>	21	1	3	19	3	3	17	2	6
<i>Spirometry</i>	17	6	2	8	12	5	6	6	13
<i>ABG</i>	23	2	0	21	2	2	17	2	6
<i>VBG</i>	24	1	0	22	3	0	22	1	2
<i>SpO₂</i>	7	10	8	5	9	11	5	4	16

Key: **U**-Unnecessary **N**-Necessary **E**-EssentialTable 3.29: Assessment of investigation importance for a patient suffering from **poorly controlled asthma** undergoing this grade of surgery:

	Surgical Risk								
	Low			Intermed.			High		
	U	N	E	U	N	E	U	N	E
<i>ECCG</i>	5	7	13	4	4	17	3	1	21
<i>CXR</i>	7	7	11	7	3	15	3	3	19
<i>CBC</i>	6	6	13	2	4	19	2	4	19
<i>Renal</i>	11	6	8	6	3	16	3	4	18
<i>Coag</i>	17	6	2	13	6	6	11	3	11
<i>RBG</i>	14	7	4	10	10	5	8	9	8
<i>LFT</i>	21	2	2	19	4	2	16	4	5
<i>Se. Albumin</i>	21	3	1	20	2	3	19	2	4
<i>Urinalysis</i>	20	2	3	18	2	5	16	3	6
<i>Spirometry</i>	5	5	15	5	2	18	4	2	19
<i>ABG</i>	13	6	6	8	7	10	5	4	16
<i>VBG</i>	22	3	0	21	2	2	19	3	3
<i>SpO₂</i>	4	4	17	2	4	19	3	2	20

Key: **U**-Unnecessary **N**-Necessary **E**-Essential

Table 3.30: Assessment of investigation importance for a patient suffering from **mild obstructive sleep apnoea** undergoing this grade of surgery:

	Surgical Risk								
	Low			Intermed.			High		
	U	N	E	U	N	E	U	N	E
<i>ECG</i>	4	7	14	2	7	16	3	3	19
<i>CXR</i>	13	7	5	8	9	8	6	3	16
<i>CBC</i>	5	11	9	2	10	13	2	4	19
<i>Renal</i>	11	8	6	5	9	11	3	5	17
<i>Coag</i>	18	3	4	13	9	3	11	4	10
<i>RBG</i>	15	7	3	9	9	7	7	9	9
<i>LFT</i>	21	3	1	18	4	3	14	4	7
<i>Se. Albumin</i>	23	2	0	20	4	1	19	3	3
<i>Urinalysis</i>	20	3	2	19	1	5	17	2	6
<i>Spirometry</i>	16	7	2	12	6	7	10	4	11
<i>ABG</i>	17	6	2	15	6	4	9	8	8
<i>VBG</i>	24	1	0	24	1	0	19	4	2
<i>SpO₂</i>	3	13	9	3	7	15	3	1	21

Key: **U**-Unnecessary **N**-Necessary **E**-EssentialTable 3.31: Assessment of investigation importance for a patient suffering from **severe obstructive sleep apnoea** undergoing this grade of surgery:

	Surgical Risk								
	Low			Intermed.			High		
	U	N	E	U	N	E	U	N	E
<i>ECG</i>	2	7	16	2	4	19	2	3	20
<i>CXR</i>	10	6	9	5	7	12	4	2	18
<i>CBC</i>	3	7	15	2	3	20	3	1	21
<i>Renal</i>	6	9	10	3	6	16	3	3	19
<i>Coag</i>	14	4	7	11	6	8	8	3	14
<i>RBG</i>	13	6	6	8	9	8	6	9	10
<i>LFT</i>	21	3	1	16	6	3	14	4	7
<i>Se. Albumin</i>	22	2	1	20	3	2	18	2	5
<i>Urinalysis</i>	18	3	4	18	2	5	16	3	6
<i>Spirometry</i>	8	9	7	7	4	14	6	3	16
<i>ABG</i>	11	5	9	8	7	10	4	3	18
<i>VBG</i>	23	2	0	23	1	1	20	3	2
<i>SpO₂</i>	4	3	18	5	1	19	4	1	20

Key: **U**-Unnecessary **N**-Necessary **E**-Essential

Table 3.32: Assessment of investigation importance for a patient suffering from **diet-controlled diabetes mellitus** undergoing this grade of surgery:

	Surgical Risk								
	Low			Intermed.			High		
	U	N	E	U	N	E	U	N	E
<i>ECG</i>	3	11	11	2	7	16	3	4	18
<i>CXR</i>	20	4	1	16	6	3	12	4	9
<i>CBC</i>	8	11	6	4	8	13	4	3	18
<i>Renal</i>	10	10	5	2	8	15	4	3	18
<i>Coag</i>	18	6	1	12	10	3	10	3	12
<i>RBG</i>	5	8	12	3	7	15	5	3	17
<i>LFT</i>	23	2	0	20	4	1	16	3	6
<i>Se. Albumin</i>	24	1	0	21	4	0	19	2	4
<i>Urinalysis</i>	15	5	5	15	4	6	13	2	10
<i>FBG</i>	13	9	3	11	10	4	10	5	10
<i>HBA_{1C}</i>	10	12	3	8	8	9	6	6	13

Key: **U**-Unnecessary **N**-Necessary **E**-Essential

Table 3.33: Assessment of investigation importance for a patient suffering from **diabetes mellitus treated with oral hypoglycaemic agents** undergoing this grade of surgery:

	Surgical Risk								
	Low			Intermed.			High		
	U	N	E	U	N	E	U	N	E
<i>ECG</i>	4	7	14	2	6	17	3	4	18
<i>CXR</i>	16	8	1	15	8	2	10	6	9
<i>CBC</i>	7	10	8	4	7	14	3	4	18
<i>Renal</i>	5	12	8	3	8	14	3	3	19
<i>Coag</i>	18	5	2	12	7	6	10	5	10
<i>RBG</i>	6	10	9	5	6	14	7	1	17
<i>LFT</i>	20	4	1	16	5	4	12	6	7
<i>Se. Albumin</i>	21	4	0	19	4	2	18	3	4
<i>Urinalysis</i>	15	6	4	14	3	8	14	2	9
<i>FBG</i>	13	10	2	12	7	6	10	4	11
<i>HBA_{1C}</i>	9	10	6	8	7	10	7	5	13

Key: **U**-Unnecessary **N**-Necessary **E**-Essential

Table 3.34: Assessment of investigation importance for a patient suffering from **diabetes mellitus treated with insulin** undergoing this grade of surgery:

	Surgical Risk								
	Low			Intermed.			High		
	U	N	E	U	N	E	U	N	E
<i>ECG</i>	3	7	15	2	5	18	2	2	21
<i>CXR</i>	18	5	2	16	5	4	12	3	10
<i>CBC</i>	6	8	11	4	5	16	2	4	19
<i>Renal</i>	3	11	11	3	5	17	3	2	20
<i>Coag</i>	14	6	5	10	7	8	6	4	15
<i>RBG</i>	6	7	12	4	6	15	5	2	18
<i>LFT</i>	17	4	4	14	6	5	13	4	8
<i>Se. Albumin</i>	20	2	3	19	3	3	17	3	5
<i>Urinalysis</i>	16	4	5	14	3	8	12	3	10
<i>FBG</i>	12	10	3	11	5	9	9	3	12
<i>HBA_{1C}</i>	7	12	6	6	8	11	4	4	17

Key: **U**-Unnecessary **N**-Necessary **E**-Essential

Table 3.35: Assessment of investigation importance for a patient suffering from **chronic renal failure** who is **treated conservatively** undergoing this grade of surgery:

	Surgical Risk								
	Low			Intermed.			High		
	U	N	E	U	N	E	U	N	E
<i>ECG</i>	2	9	14	2	5	18	2	2	20
<i>CXR</i>	11	12	2	10	8	7	6	3	16
<i>CBC</i>	3	9	13	2	6	17	2	2	21
<i>Renal</i>	2	6	17	2	2	21	2	1	22
<i>Coag</i>	11	8	6	9	5	11	6	3	16
<i>RBG</i>	11	10	4	7	10	8	7	6	12
<i>LFT</i>	19	4	2	17	5	2	12	4	9
<i>Se. Albumin</i>	19	5	1	17	4	4	15	3	7
<i>Urinalysis</i>	12	5	8	10	6	9	10	4	11

Key: **U**-Unnecessary **N**-Necessary **E**-Essential

Table 3.36: Assessment of investigation importance for a patient suffering from **chronic renal failure** who **requires dialysis** undergoing this grade of surgery:

	Surgical Risk								
	Low			Intermed.			High		
	U	N	E	U	N	E	U	N	E
<i>ECG</i>	2	5	18	2	3	20	2	2	21
<i>CXR</i>	12	5	8	8	6	11	5	3	17
<i>CBC</i>	2	5	18	2	2	21	2	2	21
<i>Renal</i>	2	5	18	2	1	22	3	1	21
<i>Coag</i>	7	4	14	7	2	16	6	2	17
<i>RBG</i>	7	9	9	6	8	11	5	6	14
<i>LFT</i>	14	6	5	11	7	7	11	4	10
<i>Se. Albumin</i>	14	7	4	13	7	5	13	2	10
<i>Urinalysis</i>	14	6	4	14	7	4	14	5	6

Key: **U**-Unnecessary **N**-Necessary **E**-Essential

Table 3.37: Assessment of investigation importance for a patient with a history of a **cerebrovascular accident** undergoing this grade of surgery:

	Surgical Risk								
	Low			Intermed.			High		
	U	N	E	U	N	E	U	N	E
<i>ECG</i>	2	8	15	2	5	18	2	3	20
<i>CXR</i>	14	11	0	12	9	4	8	4	13
<i>CBC</i>	4	12	9	3	7	15	2	2	21
<i>Renal</i>	8	11	6	4	9	12	3	1	21
<i>Coag</i>	8	8	9	7	5	13	3	4	18
<i>RBG</i>	9	12	4	8	10	7	4	7	14
<i>LFT</i>	21	3	1	18	5	2	14	5	6
<i>Se. Albumin</i>	22	2	1	20	3	2	18	4	3
<i>Urinalysis</i>	19	3	2	19	2	4	17	3	5

Key: **U**-Unnecessary **N**-Necessary **E**-Essential

3.5.7 Concurrent Medications

Opinions regarding the management of concurrent medications are shown in Table 3.38. The prevailing practice was to continue most classes of drugs.

There was a significant minority who would have discontinued tricyclics and SSRIs, in spite of the issues discussed in Section 2.4.3.1. Also, the number of respondents who recommended continuing lithium therapy, contrary to recommendations [6], may be of some concern.

A large majority, in keeping with current recommendations, would have maintained long-term β -blocker therapy (Section 2.4.3.2).

Most respondents would have maintained treatment with ACE inhibitors both for congestive heart failure and hypertension. A majority would also have continued ARBs, but a sizeable proportion would withhold treatment. Given the conflicting recommendations for these drugs discussed in Section 2.4.3.3 this variation in practice is understandable.

Statins, which should be continued [57, 59, 71] would have been stopped by about 20% of respondents.

Regarding diuretics, when used to treat congestive heart failure, most opted to continue treatment, whereas if used for hypertension 36% they would have withheld them.

There was also a lack of consensus regarding the perioperative use of aspirin. Most agreed with the continuation of this drug in patients having undergone coronary stenting. For patients with ischaemic heart disease, however, 32% would have withheld treatment. These results are, perhaps, understandable in view of the mixed findings discussed in Section 2.4.3.6, and the ESC/ESA and ACC/AHA recommendations [57, 71] that perioperative aspirin use requires an individualised risk/benefit analysis.

Table 3.38: Management of Medications

	NR	Withhold	Continue
<i>Tricyclic Antidepressants</i>	2	7	16
<i>SSRIs</i>	2	5	18
<i>Benzodiazepines</i>	2	1	22
<i>Lithium</i>	2	5	18
<i>β-Blockers for IHD</i>	2	0	23
<i>β-Blockers for Hypertension</i>	2	1	22
<i>β-Blockers for Arrhythmia</i>	2	0	23
<i>ACEI for Hypertension</i>	2	5	18
<i>ACEI for Congestive Heart Failure</i>	2	2	21
<i>ARBs (Sartans)</i>	2	9	14
<i>Statins</i>	1	5	19
<i>Diuretic for Hypertension</i>	1	9	15
<i>Diuretic for Congestive Heart Failure</i>	2	0	23
<i>Aspirin for IHD</i>	1	8	16
<i>Aspirin for coronary stent</i>	2	2	21
<i>Calcium Channel Blocker</i>	2	4	19

Key: **NR:** No Response

3.5.8 Timing of Assessment

Time intervals considered acceptable between an indicated assessment or investigation and the proposed date of surgery are given in Table 3.39. A large majority of respondents required that most of the preoperative assessment and investigations should be performed within six weeks of the planned procedure. In the case of more invasive or expensive investigations, however, such as echocardiography, chest x-ray, cardiac stress testing and angiography, longer periods of validity were considered acceptable.

Table 3.39: Timing of Preoperative Assessment

	NR	48 hrs	7 dys	3 wks	6 wks	6 mths	1 yrs	2 yrs
<i>Health Status Questionnaire</i>	2	1	2	6	10	2	1	1
<i>Physical Examination</i>	1	3	4	7	6	2	1	1
<i>ECG</i>	1	2	4	3	10	5	0	0
<i>CXR</i>	1	0	3	3	4	5	6	3
<i>CBC</i>	1	2	2	6	9	2	2	0
<i>Renal Profile</i>	3	3	2	6	8	1	2	0
<i>Coagulation Screen</i>	2	4	1	7	8	1	2	0
<i>RBG</i>	2	5	1	5	9	1	2	0
<i>Liver Profile</i>	3	0	3	4	9	4	1	1
<i>Se. Albumin</i>	3	0	3	5	8	3	2	1
<i>Urinalysis</i>	3	6	1	3	6	3	2	1
<i>Non-invasive Stress Testing</i>	2	0	2	1	4	6	3	7
<i>Echocardiogram</i>	1	0	2	2	2	7	4	6
<i>Angiography</i>	2	0	1	1	2	2	7	10
<i>Spirometry</i>	3	1	3	1	5	6	4	1
<i>Arterial Blood Gases</i>	3	9	2	2	5	1	2	1
<i>Venous Blood Gases</i>	5	7	2	2	3	3	3	0
<i>Pulse Oximetry</i>	1	12	3	1	6	1	1	0

Key: **NR:** No Response

3.6 Discussion

This survey is a first attempt at determining the opinions of anaesthetists at the research institution as to the requirements for preoperative assessment for anaesthesia. This study allows a determination of how closely international guidelines such as those of the ASA [2], ESA and ESC [6,71], NICE [11,12] ACC/AHA [13,57] and CCS [59] are adhered to. Identifying areas where guidelines are not being followed and determining the reason for this [165] will guide improvements in practice.

The survey questionnaire was constructed from the preoperative assessment elements recommended by a number of international guidelines and other studies as detailed in Chapter 2 and Section 3.3. As such, it is likely that this tool could be usefully employed to determine the opinions on preoperative assessment requirements of anaesthetists with varying training backgrounds or practising in different institutions or countries.

The results of this survey have to be interpreted with some caution. One should also bear in mind that surveys reveal what respondents state they would do, not necessarily what they actually do in practice. Furthermore, survey respondents may try to provide answers which are considered acceptable to the investigator. As the investigator was a senior member of the Department, with an interest in preoperative standards and recommendations, this possibility of bias was of particular concern. The anonymous nature of this questionnaire was intended to reduce such social desirability bias.

The response rate of 29% was low both in absolute terms and as a fraction of the target population. On the other hand, although conducted at a single institution, the anaesthetic faculty also represents a large majority of practising anaesthetists in Malta ((Section 1.3.1)).

The low response rate may also give some concern as to whether, due to selection bias, the findings are generalisable to the whole faculty. Members of staff who returned the questionnaire may have been more aware of published recommendations and so felt more comfortable in participating. Those not fluent in English may have been dissuaded from completing the questionnaire.

3.6.1 Clinical Assessment

As discussed in Section 2.4.1.1, the clinical history and physical examination elements of the preoperative assessment investigated were based on the dataset proposed by Ahmadian *et al.* [32]. This dataset was constructed from a literature review and expert panel opinion. This study appears to be the first validation of Ahmadian dataset by a cohort of practising anaesthetists. All the elements were considered “somewhat”, “very” or “extremely” important by the large majority of respondents. However, as discussed in Sections 3.5.2 and 3.5.3 not all respondents would enquire directly about all these elements. Some anaesthetists may consider that if a

specific finding in the preoperative patient population is low, or the consequences if undetected not severe enough, it does not warrant routine enquiry. Also, there may be the expectation that the patient is likely to be aware of their pre-existing comorbidities and would spontaneously volunteer the information, perhaps in response to an open ended question. This may not be warranted. Patients may not volunteer certain information as they consider it irrelevant. Alternatively, the issue may have already been discussed with another team member who was not responsible to document it. The patient may later refrain from repeating the information. This possible loss of information could be addressed by using a health status questionnaire to ensure that all relevant questions are asked and documented. However, the professional collecting the data must be able to interpret what the patient says, and not simply conduct a check-box exercise. There should also be flexibility to include information on unusual issues not envisaged in the data collection form.

3.6.2 Airway Assessment

Airway assessment, particularly ease of mask ventilation and intubation is of particular concern to anaesthetists. The cohort studied indicated that most perform airway assessment routinely. The most popular methods, Mallampati grade and mouth opening, are similar to those reported in use by UK and EU anaesthetists (see Section 3.5.4). In light of the ESA recommendations [6,17] (see Section 2.4.1.3), it may be desirable to also encourage the use of thyromental distance and ULBT.

3.6.3 Special Investigations

As noted in Section 3.5.6, and in common with other studies [31,164], there was a tendency for this cohort of anaesthetists to recommend investigations which the various guidelines deem unnecessary. For example, this survey found that coagulation screening is requested too frequently. There is little evidence that this test is useful in patients who have no history of bleeding tendencies or who are on treatment with anticoagulants. If this translates into actual practice, this may be wasteful of resources. However, this may be given less weight by clinicians than the possibility of missing some unexpected finding. Of more consequence may be the assessment by some respondents that these investigations are essential. If this really translates into clinical practice, this may lead to the unnecessary postponement or cancellation of procedures.

Of greater concern is that more onerous investigations, both in terms of resources and patient inconvenience are also being recommended unnecessarily. For example, a concerning number of anaesthetists indicated that they would request a chest X-ray in situations where it is not warranted. Similarly, spirometry was recommended in case scenarios where the patient had an established diagnosis and stable disease. Again, there is no evidence

to support this practice

A few survey respondents even opted to request invasive investigations such as angiography. If acted on in clinical practice, this would directly expose patients to the risk of iatrogenic complications and place unnecessary demands on the cardiology services for no clear benefit.

While some variation in practice may be acceptable and have little practical impact if suboptimal, there is a clear need to address the more egregious misconceptions which may directly expose patients to inconvenience or harm. This may require the development of robust departmental guidelines, educational efforts to promote the awareness and underlying rationale, and reassurance regarding the possibility of professional or medicolegal liability.

3.6.4 Concurrent Medications

The reported practices regarding the maintenance or withholding of various medications outlined in Section 3.5.7 may be considered in two categories. In some instances, for example, the management of ACE inhibitors and Angiotensin Receptor Blockers (ARBs), there does not appear to be concordance between different guidelines. Various bodies have given different weightings to the risks and benefits of the alternatives. Individual variation in local practice is thus understandable. Perhaps of more concern is the failure some respondents to follow recommendations even when these appear uncontroversial. This may reflect a lack of awareness of the recommendations which could be addressed by education efforts.

3.6.5 Conclusions

The results of the survey presented here reveal areas where efforts could usefully be made to disseminate the practices being advocated by the various guideline bodies. Perhaps as important as aligning local practice with international guidelines, however, is the determination of what is considered an adequate preoperative dataset by the local practitioners. Adaptability can work in both directions. Employing the end-users' input in developing future guidelines may improve future compliance [170]. Ultimately, the process of preoperative assessment must deliver the information required by the target practitioners if the process is to be considered satisfactory.

Chapter 4

An Interview Study of the Process of Preoperative Assessment

4.1 Introduction

In the interest of improved utilisation of resources, it has become common practice for preoperative anaesthesia assessment of patients to be undertaken at clinics specifically set up for the purpose. Guidelines and advisories dealing with the anaesthetic preoperative assessment and preparation of patients [1–6, 11, 12, 17, 171] are, for the most part, concerned with what needs to be done in terms of clinical assessment, investigation and patient optimisation. They give little guidance on the actual clinic organisation. Several models for the organisation of such clinics are described elsewhere in the literature. These clinics may be nurse-led, doctor-based, anaesthetist-based, or various hybrids [27, 29, 172–178]. The tasks involved in carrying out the assessment may be divided between various combinations of these practitioners from different clinical and training backgrounds. A common feature of these organisational models is that the attending anaesthetist, who would be responsible for the perioperative care of the patient, is usually not directly involved in the process.

Most of the published literature focusses on the equivalence of different clinic models [27, 29, 172–178]. Others have investigated the impact of information technology on the anaesthetic preoperative assessment process [179]. Little work has been published on the processes needed to achieve these ends as a whole.

4.2 Aims

The aims of this study were to develop an understanding of the functioning of the preoperative assessment clinic and to investigate the perceptions and opinions of the clinical staff working in the clinic, or utilising its services.

Of interest were the perceived goals of the clinic and expectations of the deliverables. Opinions relating to the strengths and weaknesses of the clinic were also sought.

4.3 Clinic Overview

The study was undertaken at Mater Dei Hospital, Malta (see Section 1.3). At the time, the POAC catered for approximately 12 patients per day, which was only a small fraction of patients undergoing surgery at the hospital. As will emerge in the study, clinic nurses filled in a detailed health status questionnaire by medical record review and patient interview. This was complemented by a physical examination undertaken by an anaesthetic trainee. Patients were also seen by a FY doctor from the surgical firm. They were then referred for any necessary investigations.

4.4 Qualitative Methodologies

As a preliminary investigation of the issues outlined above, a qualitative approach was appropriate. Several approaches to qualitative investigation of a system may be considered. Foremost amongst these are observational methods, in-depth interviews and group interviews.

Observational methods [180] require the investigator to directly examine the events and activities associated with the process under study. While often considered a gold standard, the technique is often very labour intensive and time consuming. The presence of the observer, unless using a covert methodology, may influence the behaviours being observed. Furthermore, unless supplemented by interviews, the objectives and motivations of the participants will not be elicited.

In-depth Interviews [181] allow the exploration of the issues under consideration. The interview is often semi-structured, with the general topics to be discussed set by the researcher, but questions being set in an open-ended fashion allowing the interviewee adequate time to expand on the themes and issues which are considered most important. It is inevitable that the data obtained are an account of the phenomena under consideration. Also, opinions may be expressed which the interviewee believes to be socially acceptable. This may be particularly problematic if the interviewer and interviewee are known to each other and the interviewer is in a position of power or considered an expert in the field being discussed. This may be partly mitigated by the possibility of conducting the interviews in a private setting and guaranteeing anonymity.

Group Interviews [182] may be held with naturally occurring groups (naturalistic) or with groups specifically convened for the purpose of

the study (focus groups). These methods have the advantage of generating substantial quantities of data relatively quickly. In the case of naturalistic groups it may also be useful to observe the interaction between the group members. These advantages may be offset by the difficulty in convening the group for interview. Furthermore, if group members have different hierarchical status, a junior participant may be reluctant to express opinions in contradiction to a senior participant, or publicly express a controversial opinion. On the other hand, using small groups of interviewees of similar hierarchical status may encourage them to voice opinions a single participant may not wish to disclose in a one-to-one interview.

4.5 Method

In view of the above considerations, and the investigator’s status as a senior member of the Department where the study was to be carried out, it seemed most advantageous to carry out in-depth semi-structured, one-to-one interviews. Participants were invited from amongst the preoperative clinic nurses, FY doctors and anaesthetic trainees and specialists. Purposive sampling was used to select participants covering all the healthcare disciplines participating in the clinic. In all, twelve members of staff were interviewed between August and October, 2015. Interviews were carried out in a private office in the Department of Anaesthesia and lasted approximately 30 minutes. Participants agreed for the interviews to be audio recorded on condition of anonymity. The recordings were transcribed using the VOICE [183] schema and typeset in L^AT_EX with the *ulqda* package [184] to facilitate framework analysis [185] for thematic content. For anonymity, in the transcriptions and quotes, subjects were identified by a unique code followed by an indicator of grade (see Table 4.1).

The study protocol was approved by the University of Malta Research Ethics Committee and authorised by the relevant hospital authorities.

Table 4.1: Interviewee Grades and abbreviations

<i>Consultant</i>	Cons
<i>Higher Specialist Trainee</i>	HST
<i>Basic Specialist Trainee</i>	BST
<i>Foundation Doctor</i>	FY
<i>Nurse</i>	Nurse

4.5.1 Interview Topics

The themes addressed in the interviews were based on the “5 Ps” approach to analysing healthcare microsystems [186, 187].

- Purpose
- Patients
- Professionals
- Process
- Patterns

Specific topics addressed followed the schema used by Bouamrane [179]:

- Participant's background and experience
- Overview and key steps of the preoperative process
- Patient history, examination, investigation and optimisation
- Roles and responsibilities of different professionals
- Information required and how obtained
- Information transmitted to other professionals and how this is communicated

4.5.2 Thematic Coding

Major theme codes and a number of subtopics were established *a priori* to reflect the main topics of interest. These were:

Demographics Respondent's profession, grade and experience

Aims The aims of the preoperative assessment

Process Details of the functioning of the preoperative assessment clinic

- Roles of clinic personnel
- Appraisal of process effectiveness
- Proposed alternatives
- Appropriateness of timeframes

Communication Related to communication or information exchange during the preoperative assessment

- Modes of communication
- Preference of communication modes
- Effectiveness of different modes

Failures How the process can fail

- Examples

- Root Causes
- Consequences

Misc New issues emerging from open questions

The transcripts were reviewed by the author, and statements classified into the main themes and subthemes described above. New theme subtopic codes were added as these emerged during the analysis of the transcripts and were used to further classify the respondents' statements.

4.6 Analysis and Interpretation

The interviewees included several anaesthesia consultants, a number of who also had clinical sessions in the POAC, anaesthesia trainees at various stages of training, FY doctors and one of the two POAC nurses.

4.6.1 Aims of the Preoperative Assessment

Respondents were asked what they regarded as the aims of the preoperative consultation. The main themes that emerged were the need to identify patient comorbidities, assess the various body systems, assess functional capacity, organise or review special investigations, optimisation of the health status of the patient, development of an anaesthetic plan and development of rapport with the patient.

4.6.1.1 Identification of Comorbidities

Most of the respondents considered the identification of known comorbidities, which could have a bearing on the forthcoming surgery and anaesthesia, as being one of the important functions of the preoperative assessment. Cardiovascular and respiratory conditions were the most frequently mentioned as being of particular concern, and attempts would be made to gauge the severity of the condition.

S1-Cons: “ *I want to know whether the patient has any medical problems which could affect the anaesthetic management. ”*

S9-FY: “ *I think the biggest issue mainly is cardiovascular or respiratory pathology ”*

These would be identified through review of the patient's surgical, medical and drug history through examination of the patient's medical record and by interview. A history of any previous perioperative difficulties or complications would also be elicited.

S7-HST: “ *So, I go through the file, I see the old notes. I see the nursing checklist of the day. I see the parameters. I see the ECG, and then I get the patient in. I run through the important points for myself. . . ”*

4.6.1.2 Assessment of Body Systems

The assessment was then continued by a more systematic review of body systems, again focussing particularly on the cardiovascular and respiratory systems and an assessment of the airway.

S9-FY: “ *I like to go through a systemic enquiry related to the most important areas. So, cardiovascular, chest...* ”

In the setup of the preoperative clinic at the time, this was conducted by one of the preoperative clinic nurses following a set template of questions.

S12-Nurse: “ *...to fill in the questionnaire... they ask certain specific questions that are related to cardiac, respiratory and some other ADLs* ”

The systematic review was then complemented by a physical examination of the patient performed by an anaesthesia trainee. This particularly targeted the cardiovascular and respiratory systems.

S7-HST: “ *...I listen to their heart and lungs. Heart sounds mainly to see if there are any new or undocumented murmurs... and chest sounds to make sure the chest is clear...* ”

4.6.1.3 Assessment of Functional Capacity

An assessment of the patient’s physiological reserve was also reported as one of the aims of the assessment by several of the respondents.

S6-Cons: “ *I would want to look at the physiological reserve of the patient, by way of asking for exercise tolerance* ”

S10-BST: “ *Many times we are just given a list of the comorbidities that the patient may have, but I go again over each one and I try to assess how severe that is...* ”

S11-FY: “ *...if he or she is able to go up two flights of stairs without any chest pain or shortness of breath...* ”

4.6.1.4 Investigations

A few of the respondents mentioned the need to order any relevant special investigations and imaging studies. One interviewee commented on the need to follow up the results.

S8-BST: “ *I want to make sure that any loose ends are tied up.* ”

4.6.1.5 Optimisation

Optimisation of the patient was also regarded as one of the goals of the preoperative consultation by most of the participating anaesthetists.

S3-Cons: “ *I want important factors, that can be improved or lead to postponement or cancellation of surgery, picked up early enough for these things to happen. . .* ”

S8-BST: “ *I want to make sure the patient is as fit as he could possible be for the surgery, that is, anything that can be improved is improved.* ”

Sometimes, the coordination of all the services needed to achieve this optimisation was found to be challenging

S5-BST: “ *I sometimes feel that I’m doing the job of four or five specialities, trying to liaise all this to come together, for a patient to be fit and safe for him to undergo surgery.* ”

4.6.1.6 Anaesthetic Plan

The preoperative consultation was viewed as an opportunity to formulate a plan for the conduct of anaesthesia.

S6-Cons: “ *By the end of the process I would have an anaesthetic plan which I would tend to implement on the day of surgery.* ”

4.6.1.7 Patient Rapport

Finally, the preoperative assessment was seen as an opportunity to begin the development of a rapport with the patient.

S7-HST: “ *Then I go over, with the patient, what they’re thinking of their anaesthetic, if they have any questions and I give them the plan. . .* ”

4.6.2 Process

4.6.2.1 Process Overview

At the time of this study, the patient pathway through the preoperative clinic was as shown in Figure 4.1. The patients would be seen in order by the Preoperative Clinic Nurse, then be sent for an ECG, return to the clinic to be seen by the anaesthetist, and then by the Foundation doctor. If the doctor had a backlog of patients waiting, the patient would be directed to phlebotomy services first, otherwise he would go to phlebotomy after the Foundation doctor consultation.

Figure 4.1: Patient pathway through clinic

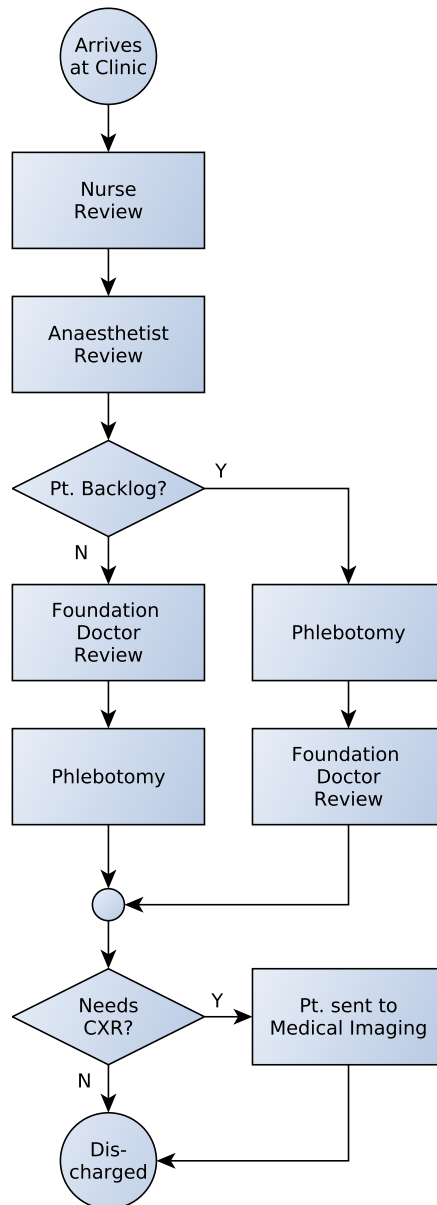

4.6.2.2 Roles and Practice

The three major clinical participants in the clinic were the nurses, anaesthetists and Foundation doctors. The nurses were specifically assigned to the clinic. The anaesthetists ranged from consultants to trainees of various grades, who would undertake sessions in the clinic as rostered. The Foundation doctors (preregistration doctors) were assigned to the surgical firms, and would attend the clinic on given days when the firm's patients were brought to clinic for preoperative assessment.

The roles of the clinic staff was succinctly described by one of the anaesthesia trainees working in the clinic:

S10-BST: “ *First of all the patient is seen by a nurse, and they do the [health status] questionnaire together.*

Many times I am the first medical contact and I do whatever needs to be done, from the medical point of view. The history-taking, physical examination, seeing the investigations myself.

And then the house officer just signs off the consent form. ”

Nurse The role of the nurse was to review the patient medical records and note any comorbidities, medical and surgical history and relevant special investigations.

S12-Nurse: “ *...nurses prepare files for those patients that are coming...the next day. The nurses role in that area would be to actually go through the file...they identify any comorbid difficulties or investigations that have been done previously... ”*

As noted above, during the clinic consultation, the nurses also complete a health status questionnaire with the patient.

Anaesthetist The anaesthetists main task was to carry out a physical examination and assess the needs for further workup. However, many also carried out review of the file and systemic enquiry, thus replicating much the work undertaken by the nurses.

S7-HST: “ *...for the main, important questions that I would want to know, I go over again. Just to be sure. ”*

S8-BST: “ *I go through the questionnaire again with the patient. I don't ask the full questionnaire, I just ask them the bits that are relevant and the abnormal bits from the questionnaire to clarify those ”*

The anaesthetists were also required to review laboratory results and other special investigations when these were available. These would usually be sent to the clinic several days after the patient assessment.

S2-HST: “ *any echo or imaging investigation and any result which is marked high or low. If it is within normal range we don’t see it. But the nurses get the result. File it in the file and they leave it for you to see. . .* ”

Foundation Doctor As noted above, the main duty of the Foundation doctor was to obtain informed consent, organise any further investigations required, and arrange the logistics of the admission for surgery.

S9-FY: “ *My experience was essentially just going through the procedure and the consent procedure. Answering any questions that somehow might have been . . . unanswered, . . . and usually organising any extra investigations that might be needed. And sorting out logistics, telling the patient when to come and where to come . . .* ”

4.6.2.3 Appropriateness of roles

Mixed opinions were expressed regarding the appropriateness of the roles of the various clinicians in the preoperative clinic.

Nurses Some of the Consultants felt that completing the health status questionnaire was within the competence of the clinic nurses, provided they had adequate training:

S3-Cons: “ *I think preliminary screening can be done. . . by trained, TRAINED anaesthesia nurses. So, nurses who have had years of experience in operating theatres, who are then further trained to ask the appropriate questions to understand answers and even to perform an airway assessment as well. ”*

On the other hand, concerns were raised that in the local setting, the nurses did not have the necessary background or training to accurately assess symptoms reported by the patients:

S4-Cons: “ *The questionnaire would be filled by a Foundation doctor because they wouldn’t get lost on many details, like the nurses do ”*

S11-FY: “ *. . . nurses might miss something, sometimes. Because they’re not exposed to certain situations and, you know, they don’t think what might happen, sometimes. So they don’t really delve into certain things. ”*

The nurse interviewed also felt that the questionnaire may be more appropriately handled by one of the medical staff, while the nurses could be better employed with areas more closely aligned with their professional training.

S12-Nurse: “ *I think they don’t need to go necessarily into the medical aspect of it, asking the same questions that the house officer might ask anyway. Or the anaesthetist might ask again anyway. . .* ”

And education [of] the patient, because education is part of healing. If you get the education right, the patient knows. . . what he’s going through and what he will be expecting. It would be less traumatising for the patient throughout his journey ”

Anaesthetist There was common consensus that anaesthetists had the competency and training to carry out all aspects of the preoperative assessment

S2-HST: “ *I assume the anaesthetist is in the best position to carry out the assessment, both because he has had training in airway assessment as well as perioperative medicine ”*

Some anaesthetist respondents considered that input from an anaesthetist was essential in all cases.

S2-HST: “ *But I feel that we should be involved with every patient which is receiving general anaesthesia. Sedation? That’s another matter. But GA, I believe, yes. We should be always involved in the assessment of the patient. ”*

S4-Cons: “ *But I would really love to meet the patient face to face. I find that gives me SUCH a good overall picture. ”*

The majority, however, felt that this would be unfeasible with available manpower if the clinic were to be scaled to increase throughput.

S1-Cons: “ *The problem with is is we are adopting the same approach for all the patients. . . That might be sort of justified in someone who has medical problems but maybe a bit too laborious and time consuming for someone who is healthy and young and well. ”*

S3-Cons: “ *What really gets me is that when I have all the ASA ones and twos who have been seen by a specialist, or soon to be specialist, and I know it’s taken them ten, fifteen minutes of their time and I just feel that maybe that wasn’t necessary. ”*

There was also some concern expressed about having to interpret the significance of blood investigations without having seen the patient, even if all the preoperative documentation was available.

S10-BST: “ *I think that’s one of the biggest problems. I end up seeing a bunch of blood results, and investigations [of patients] . . . that other people saw. I don’t have the patient in front of me. I only have the history, and I have to, kind of, you know, come up with something what to do ”*

Foundation Doctors There was again widespread consensus that the Foundation Doctors were not being used to their full potential, and that preoperative assessment, at least of uncomplicated cases, would be within their competence.

S1-Cons: “ *[Foundation Doctors] should be more involved in assessment of patients and knowing their medical problems because, after all they will be caring for the patients postoperatively and it’s not good that they don’t know much about them.* ”

S5-BST: “ *[when] I was a house officer, we used to do all this ourselves, to varying degrees of success, I admit that. But we used to get patients safely with liaising with anaesthetists, cardiologists ourselves and getting them through. So I don’t understand why the ASA 1s and 2s can’t actually be seen by a house officer* ”

S10-BST: “ *And also some of these patients are ASA 1 patients. The hernias, the D and Cs. They can all be seen by the Foundation. And then maybe we can focus on the more complex cases.* ”

4.6.3 Communication

Respondents were questioned about which other members of the team they communicated with, the modalities of communication they utilised and any difficulties they encountered.

4.6.3.1 Information Flow

An outline of the main channels of communication is shown in Figure 4.2. In this setup, the main interactions of the patient were with the nurse and the clinic anaesthetist. The nurse would also communicate with the clinic anaesthetist if there were issues of particular concern. Interaction of the patient with the Foundation doctor was usually limited to obtaining procedure informed consent. The clinic anaesthetist usually only communicated with the Foundation doctor to request the organisation of special investigations. The clinic would also contact other services directly for advice or to organise special investigations, or if some particular concern had to be raised with the surgical firm. Communication with the attending anaesthetist was usually initiated by the clinic anaesthetist, particularly if there were special concerns.

Figure 4.2: Information Exchange Map

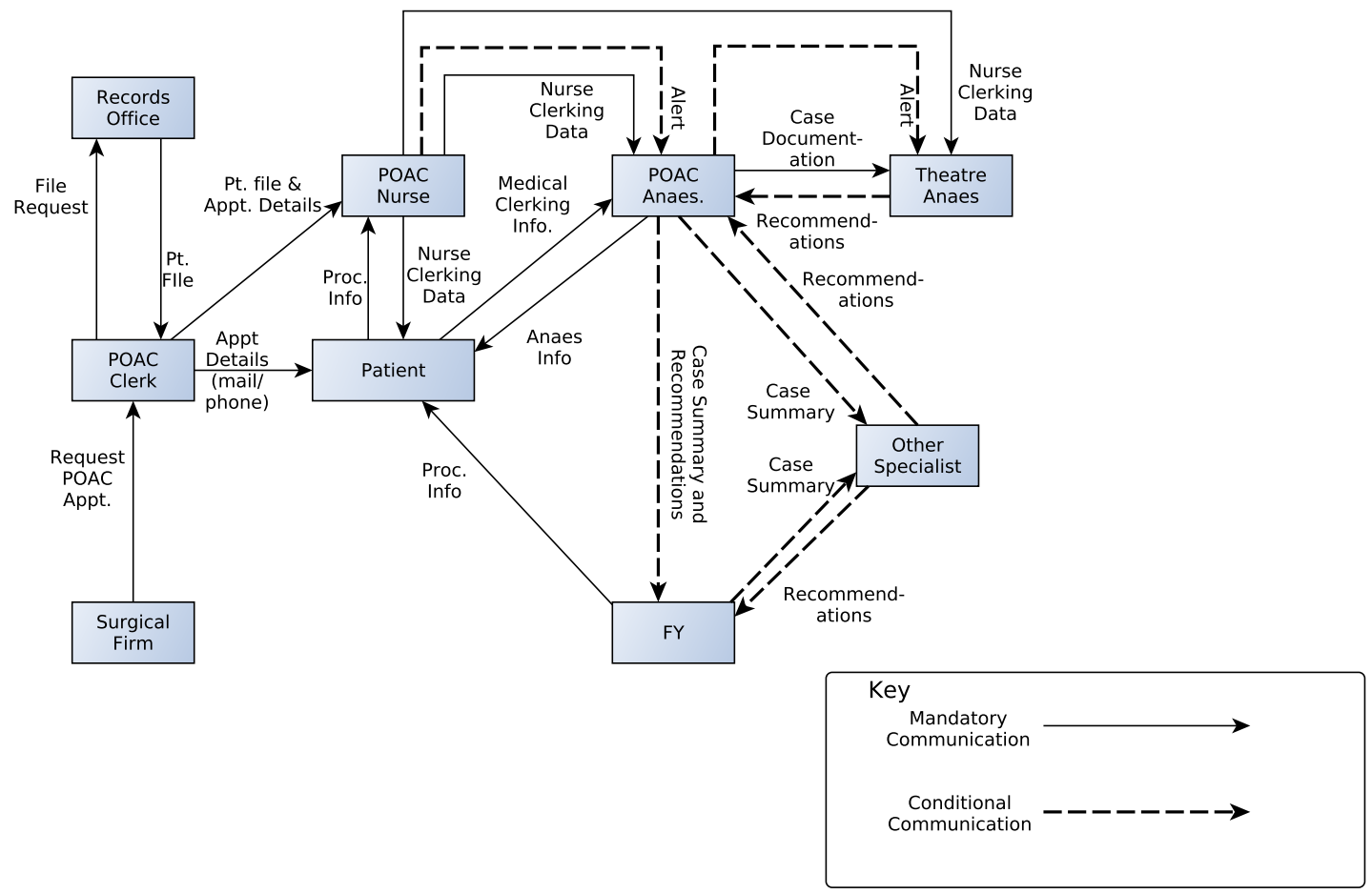

4.6.3.2 Communication Modalities

Four methods of communication were in common use:

- Face-to-face verbal communication
- Telephone calls
- Emails
- Written documentation

Face to face or telephone conversations were preferred for communicating problems, and when immediate decisions were required. Emails were usually used for followup, or when the recipient was not otherwise contactable. Written documentation was used mostly for routine cases and formal documentation.

S10-BST: “ *when they [nurses] come in with the file, they will tell you . . . verbally.* ”

. . . with the house officers it’s usually us who speak to them. . . verbally. ”

S8-BST: “ *Between the houseman and [clinic] anaesthetist. . . it needs to be done face to face ”*

S3-Cons: “ *So I think we can’t shy away from the fact that the phone call, speaking, is probably the best way. But no, a phone call doesn’t allow you to remember some things. I occasionally ask for them [to] send me a short email to remind me about this case as well, after the phone call is finished. ”*

S6-Cons: “ *I would prefer a telephone call and a follow-up email. . . the telephone call would serve as two-way communication where I can directly impart advice and discuss the case with who is seeing the patient at the time. . .*

the email would serve as an aidé-memoire and as a form of documentation flagging of issues on that particular patient. . . ”

In particular, the *pro forma* health status questionnaire (which included sections to be filled by the nurses, anaesthetists and Foundation doctors) was considered to be a useful tool to communicate findings between the different participants in the preoperative clinic, although it was dependent on the individual clinical staff filling it accurately.

S2-HST: “ *I find it a good tool, provided it’s done properly ”*

S5-BST: “ *I think it should be adequate. But it’s very user dependent. So, it’s as valuable as the person who’s filling it in. ”*

It was also noted that the large amount of information conveyed on the form made it difficult to quickly pick out the important clinical findings

S10-BST: “ *I think it’s kind of very busy. There are lots of questions, but you have to fish out for the salient points* ”

S12-Nurse: “ *I think at the moment, it’s a bit busy. It’s too busy. It’s not easy. It’s not friendly. You don’t get a glimpse out of it and say “I have a problem here”. No, you’ve got to look for the problem at the moment. I think the forms need to be more explanatory. It needs to be more shouting at you . . .* ”

4.6.4 System Failures

Respondents were asked about situations where the preoperative process had failed to adequately prepare the patient for anaesthesia. Below are some of the failure modes identified.

- Comorbidities not identified

S10-BST: “ *Many times some medical conditions are just plain skipped* ”

- Symptoms or physical findings missed or significance overlooked

S9-FY: “ *I think more that it’s not acted [on], that you think. . . there’s no need for any further, you know, to push it any further* ”

- Failure to communicate with theatre anaesthetist

S1-Cons: “ *they didn’t communicate with anyone more senior, or the anaesthetic side* ”

S8-BST: “ *But an email might not be received, even though everyone is meant to have a functioning email* ”

S9-FY: “ *not knowing who is on everyone’s list, I usually end up asking around a lot* ”

- Failure to perform indicated investigations

S10-BST: “ *I reasoned out that there was no need for another stress test* ”

- Failure to follow up requested investigations

S3-Cons: “ *Our junior colleagues, rightly, contacted the surgical firm and asked them to contact the endocrinologist firm, and in one case that didn’t happen* ”

- Failure to act on abnormal investigations

S9-FY: “...we left a note that, if HbA_{1C} was above 8, 7 or 8, she should be admitted the day before [surgery]. And the patient wasn't brought in the day before, and she came to theatre with HGTs, I think, close to 18 or something like that...”

4.7 Discussion

The findings given above represent the aims and workings of a preoperative assessment clinic as seen from the perspectives of the clinical staff who work in the clinic, and the anaesthetists who interact with it.

The cohort of participants encompassed all disciplines and grades of staff working in the clinic and so provides a reasonable cross-section of the points of view.

A distinct power relationship between the author and the more junior grades participating may have presented a barrier to frank disclosure of some opinions [188], but this was mitigated, as far as possible, by the assurance of anonymity and conducting the interviews in a private environment.

The use of semi-structured interviews may have limited the opportunity for major new themes to be introduced by the interviewees, once the overall structure of the interview was dictated by the pre-selected topics. Although an open-ended question regarding ‘other issues’ was asked towards the end of the session, no new major topics were raised. The structuring of the foregoing interview may have conditioned against introduction of such new themes

Another limitation of this study was that the author was the sole coder for emergent subtopics. Hence, there was no opportunity to cross-check the classification of these elements with another investigator.

Considering the specific findings of this study, assessment of the cardiovascular and respiratory systems, together with estimation of the patient's functional capacity were identified by the participants as an important function of the clinic. This is in keeping with the American Society of Anaesthesiologists advisory on preoperative assessment [1,2] and the guidelines of the European Society of Anaesthesiologists [6,17]. The approach to eliciting the required information through review of records, structured patient interview and physical examination is also in keeping with recommended medical practice as discussed in Section 2.4. It was also recognised as the responsibility of the clinic to initiate attempts to optimise the patient, both physically, by addressing medical issues, and psychologically by patient education and establishing rapport. All of these goals are well aligned with the guidance of the Royal College of Anaesthetists on preoperative services [171].

The clinic at the time used a hybrid nurse/anaesthetist based model, with the nurses taking the patient history and conducting a health status enquiry directed by a proforma questionnaire, while the anaesthetist under-

took the physical examination and initiated further investigations, consultations with other specialities and optimisation as necessary. The preoperative clinic anaesthetists, particularly the trainees, often found themselves stretched to cope with the workload.

The nursing role was relatively novel for our institution. Although nurse based clinics have been successfully implemented [172–174, 176, 177], many of the anaesthetists interviewed had some concerns about this, and even the nurse who participated felt that this role was not within the normal competencies of nurses trained in the local context. At the very least, significant further training would be required. It was suggested that the nurses may be better employed in tasks more closely aligned to their core competencies.

There was agreement that, while the anaesthetists had all the necessary skills for patient assessment, the basic task of structured patient interview and physical examination were within the competence of the Foundation doctors. Giving them this role would relieve the clinic anaesthetists from this routine work and they would then be available to oversee the clinic process and advise the Foundation doctors on the further management of the more complex cases. It would also improve perioperative care of the patient as the same Foundation doctor would likely be involved in the patient care. This could be facilitated by the development of decision support tools and cognitive aids to alert the junior doctors when to seek advice. These could be based on care pathways for common comorbidities, as suggested in the Royal College of Anaesthetist guidelines [171], the ESA [6, 17] guidelines, or the NICE [11, 12] guidelines for selecting preoperative tests.

Communication within the clinic was largely by direct, face-to-face conversation. Communication outside the clinic was usually by phone, especially where immediate replies were required. For delayed or asynchronous communication, email was most often used.

The proforma questionnaire used was appreciated as quite comprehensive, and serving as a guide for the patient assessment. The main concern raised was that it was not easy for the eventual user, the attending anaesthetist, to rapidly extract all the important concerns from the completed form. It was also recognised that the information transmitted was very dependent on the competence of the clinician completing the form.

Failures of the system were commented on. Several of these were related to miscommunication, a common cause of anaesthetic mishaps [20]. Lack of skill or knowledge, and errors of omission were also noted as potential problem areas.

It was the intention to expand the clinic to cater for the large majority of preoperative patients requiring anaesthetic care. In the light of the findings outlined above, and other considerations which came to light in discussion with various stakeholders, it was considered unlikely that this could be achieved with the existing clinic structure. Significant restructuring of the Preoperative Clinic was therefore undertaken. This was done with the intention of allowing the clinic to cope with a much larger patient throughput,

while addressing the concerns raised in this interview study. The functioning of the redesigned clinic is described in Chapter 5 Section 5.3.

It was the intention to include patient representatives amongst the interviewees. However, it became clear during the conduct of the study that the clinic would need to undergo significant reorganisation. In view of this, obtaining patient feedback was deferred until the restructured clinic was operating, and is presented in Chapter 6.

Chapter 5

A Prospective Hazards Analysis of the Preoperative Clinic Process

5.1 Introduction

Complex systems are prone to unexpected behaviour, and may fail in ways which are not immediately predictable, particularly when these involve multiple exchanges of information between team members [189, 190]. This is likely to be compounded when team members are from different professional backgrounds as they may not share the same objectives, priorities and goals.

It is common practice in high reliability industries, to subject new or modified processes to some form of prospective hazard analysis in order to anticipate and mitigate undesirable events. Many techniques have been described [191], and a number of these have been adapted for use in a healthcare environment [191, 192].

The complexity of the preoperative assessment process and the need for exchange of information between the different members of the preoperative assessment team raise concerns about the possibility of failure of the process. The available literature investigating the perioperative patient journeys and associated information exchange and handovers places most emphasis on surgical aspects of the process [193, 194] or on postoperative handover [194–196].

5.2 Aims

The aims of this investigation were to develop a detailed description of the POAC processes and undertake a prospective hazards analysis to identify potential failure modes, in particular those that will require mitigation to improve the clinic performance.

5.3 Clinic Reorganization

As noted in Chapter 4, it was desired to expand the capacity of the preoperative assessment clinic at our institution. In the light of the interview findings reported in previously, and following discussions with the various stakeholders, the clinic underwent significant reorganization. This included a relocation of the clinic to new premises, with facilities for several doctors and nurses to review patients simultaneously. The clinic nurses took on the task of reviewing the patients' available medical records, and eliciting past medical, social and medication histories from the patients. Responsibility for conducting a systemic enquiry and performing a physical examination was assumed by the Foundation doctors, while an anaesthetist was available in the clinic to give advice regarding further workup and optimisation as required.

A number of factors were taken into consideration in assigning these clinic roles. The main issue was which team member should have the main responsibility for the patient systemic enquiry and physical examination. The option selected was for this to be taken on by the FY. As noted above, it was considered that, with support and guidance, their training in medical semiotics would be adequate for the task. Also, as they were embedded in the surgical firm, they would be in a position to act as a point of reference for the patients when admitted for surgery, and also to be a bridge between the POAC team and the perioperative team. In order for patient clerking to be done by the POAC nurses, it would have been necessary to recruit several extra staff to cope with the workload. It would also have been necessary to develop a training programme for this novel nursing role. This would have been required both for the initial nurse cohort, and also to cater for eventual staff turnover. While the role could also have been taken on by anaesthetists, the personnel requirements were considered to be beyond the capacity of the Department.

To guide the nurses and Foundation doctors, and facilitate collection and sharing of information, one of the hospital's existing software platforms was adapted to provide a proforma questionnaire to be filled in during the patient assessment. The data set captured was based on an adaptation of an existing preoperative health status questionnaire in use at the institution, modified in light of international guidelines and other recommendations from the literature reviewed in Chapter 2, and the results of a locally conducted survey (Chapter 3). Institutional consensus guidelines for selection of appropriate routine investigations were also established, based on the NICE guidelines [11, 12] and the local survey.

The reorganised clinic was broadly similar to several other preoperative clinics described in the literature [173–175, 177, 178, 197–200]. In particular, the assessment is a joint undertaking by the preoperative team, requiring exchange of information between the patient, nurse, FY doctor and clinic anaesthetist before there is finally a handover between the clinic team and the attending anaesthetist. These multiple exchanges of informa-

tion and handovers increase the complexity of the process. The attending anaesthetist, who will have perioperative responsibility for the anaesthetic management of the patient, does not personally undertake the preoperative assessment.

It was considered desirable to conduct a formal prospective hazard analysis of the newly established clinic. In the first instance, in recognition of the fact that the actual clinic process was likely to differ in some details from the process ‘as designed’. Secondly, not all the steps in the new clinic process had been explicitly considered, and some practices were simply inherited from the old clinic or introduced *ad hoc* as the new clinic evolved. Such a formal prospective hazard analysis of a preoperative clinic does not appear to have been previously reported in the literature. After allowing the clinic to settle into its new operation for some months, a prospective hazard analysis was undertaken as described below.

5.4 Prospective Hazard Analysis Techniques

Prospective Hazards Analysis (PHA) techniques have been developed in industry to analyse complex procedures and identify the steps which are prone to failure or which hamper the efficiency of the process as a whole. Several of these have been specifically adapted for use in healthcare settings [201–205]. Fundamental to all of these is an understanding of the process being investigated. It is thus necessary to develop a model of the process. Qualitative research methods [206, 207] have proven useful in developing approaches to process mapping [208]. Several of these are amenable for use in characterising patient-related processes [209].

Different PHA techniques have their respective advantages and disadvantages. While there are no definitive guidelines on selecting the most appropriate method for a given scenario, advice in this regard has been offered by Lyons [191] and Ward *et al.* [192]. Factors to be taken into consideration include the available personnel (such as experts in the process under consideration, and experts in analysis techniques), available time, available or obtainable information on the physical, cognitive and structural aspects of the process, the need for special equipment or software, and the outputs required from the analysis. It was desirable for the selected technique to be capable of identifying hazards, and give estimates of likelihood and consequences, allowing for prioritisation of hazards to be addressed.

Taking the above into consideration, the Healthcare Failure Modes and Effects Analysis (HFMEA) [202] was selected. Although personnel with knowledge of the clinic process and subject matter experts were available, there was no access to a Hazards Analysis practitioner. Thus, HFMEA was an attractive choice, as this technique requires little experience [192], and is easier to apply in healthcare scenarios [202] than the Failure Modes and Effects Analysis (FMEA) [201] of which it is a modification. FMEA and HFMEA are amongst the most widely used prospective hazard analysis techniques used in healthcare. Although relatively time consuming and

laborious [192,210], it was considered achievable within the available time-frame, and no special equipment or computer software was required for the analysis. It would also generate the outputs required in terms of hazard identification and prioritisation.

5.5 Method

The HFMEA process consists of the following steps [202]:

- Define the topic
- Assemble the team
- Graphically describe the process
- Conduct the hazard analysis
- Identify Actions and outcomes

5.5.1 Topic for Analysis

As stated above, this HFMEA was intended to assess the processes in operation at the Preoperative Assessment Clinic to assess and optimise patients undergoing elective or scheduled surgery at the institution.

5.5.2 Assembling the Team

A team was assembled to carry out an HFMEA of the POAC process. The initial team consisted of eight participants, and was coordinated by the author. The team members included two clinic nurses, a Foundation doctor and five anaesthetists of various grades of seniority, all of whom had clinical duties in the POAC. The team members collectively had a good working knowledge of the clinic processes. They also had insight into the underlying objectives of the preoperative assessment in optimising the patient for surgery and anaesthesia.

At the first meeting, the author explained the purpose of the analysis, and the overall methodology. This was followed by a group discussion where participants reflected on the tasks of the various clinic personnel during the normal patient trajectory through the clinic. They were also encouraged to consider what information they required, and who they would communicate with throughout the process.

5.5.3 Graphical Description

From the notes taken during the first meeting, a process flow diagram was constructed, to represent the clinic workflow. This format was selected as it was an adequate visual depiction of the process and is familiar to healthcare workers [192,209]. While other diagram formats were considered,

such as swimlane diagrams [192, 208], it was unlikely that these would add much to the analysis and did not warrant introduction of an unfamiliar depiction. A complementary communication diagram was also constructed. Both diagrams were distributed to members of the team, who had time to review it before the second meeting.

At the second meeting, the process flow diagram and information flow diagram were reviewed by the group. Some corrections or clarifications were made. The final process flow chart is shown in Figures 5.1 to 5.6 (pg. 98 *et seq.*). The communication diagram is shown in Figure 5.7 (pg. 104).

5.5.4 Hazard Analysis

5.5.4.1 Task Analysis

From the constructed diagrams, the author extracted all the process steps identified by the team. These were organised by staff member with responsibility for carrying out these steps. A list of communications occurring during the clinic process was also developed, showing originator and recipient of the communication, the nature of the communication, and the modality. These were subdivided into mandatory communications (which are always expected to occur), and conditional communications (which would only occur at the discretion of the originator).

The task and communication lists generated were circulated to the team members by email, and again discussed at a meeting to ensure that all relevant items had been listed, and any clarifications and corrections made.

5.5.4.2 Hazard Identification

Before the subsequent meetings, the finalised process task list and communications lists were circulated to the team members by email. The participants were encouraged to review each step in the flow process and communication process and to try and suggest ways that the step could fail to accomplish its intended purpose. Team members were asked to consider their own experiences, anecdotes from colleagues or any literature, guidelines or advisories that they may have been familiar with. These directions are recommended in the HFMEA technique [202] to facilitate the hazards identification brainstorming sessions.

The suggested failure modes were aggregated by the author, and reviewed by the team at two further meetings. Some of the trigger phrases suggested in the healthcare adaptation of the Structured What-if Technique (SWIFT) [203] were also used to stimulate hazard identification during these sessions.

5.5.4.3 Hazard Evaluation

The HFMEA analysis [202] requires that each failure mode identified should be scored on a four point ordinal scale for severity (mild, moderate, severe,

catastrophic) and frequency of occurrence (frequent, occasional, uncommon, remote). It should also be determined if this is a single-point weakness, if there are effective controls in place, and if a failure would be detectable before leading to process failure.

In a classic failure modes analysis, the determination of the above would be carried out during team meetings. This process is time consuming [210, 211]. There is also a risk of the evaluation being dominated by the more senior members of the team [201]. In order to minimise the number of team meetings, and also to mitigate undue bias in the hazard assessment, scoring was carried out using a modified two-round Delphi technique [212, 213]. Each participant undertook the evaluation independently.

In the first round of the Delphi evaluation, the scoring for all the identified failure modes was used to carry out a hazard assessment according to the HFMEA algorithm for each respondent. This gave a recommendation that either the hazard be accepted or that mitigation was required. The responses of all the HFMEA team members were then aggregated. If there was better than 75% agreement on the evaluation (accept or mitigate), this was taken as the final recommendation. When there was no such consensus, this was submitted for a second round of evaluation.

In the second round, each team member was given the mean scores for severity and probability of a failure mode, as determined in the first round, and also the ratio of “yes/no” responses for the binary parameters (single point weakness, effective control, and detectability). Each participant was also provided with the responses they gave in the first round, and invited to reconsider their evaluation in the light of the aggregate responses. The HFMEA algorithm was again used to determine an accept or mitigate decision for each participant. In this Delphi round, a simple majority was then used to make a final determination as to whether or not the failure mode warranted intervention.

5.5.4.4 Methods Summary

In summary, the HFMEA team developed a detailed description of the processes involved in the POAC. These are presented as a process flow-diagram and a detailed inventory of process steps. A similar description of exchanges of information between clinic participants was developed and also displayed as a communications diagram and an inventory of communications. Both inventories were subjected to the HFMEA algorithm to determine those hazards which would warrant mitigation.

5.6 Results

The process steps to assess each patient identified by the focus group are shown graphically in Figures 5.1 to 5.6 (pg. 98 *et seq*). The process can be divided into seven broad stages as shown in Table 5.1. A summary of the number of hazards identified in each stage of the process, and the

recommendation as to whether each hazard should be accepted or requires mitigation is also given. In all, 167 failure modes were identified in the preoperative assessment process. The first round of the Delphi analysis identified 83 of these as acceptable risks and 25 required mitigation. On the second round, the remaining 59 failures modes were resolved into 16 acceptable risks and 43 requiring mitigation. Together, 68 hazards were identified as requiring mitigation. The process task steps, associated failure modes and the two-round Delphi HFMEA are presented in Table 5.4 (pg. 105 *et seq*).

Table 5.1: Summary Process Failure Modes and Analysis

Process Stage	Accept	Mitigate	Total
<i>Preliminary</i>	47	15	62
<i>Nurse</i>	19	2	21
<i>ECG</i>	11	0	11
<i>FY</i>	4	11	15
<i>POAC Anaesthetist</i>	4	15	19
<i>Investigations</i>	7	16	23
<i>Finalization</i>	7	9	16
Totals	99	68	167

The exchange of information between the various participants in the preoperative process is shown diagrammatically in Figure 5.7. The number of communications initiated or received by each participant, categorised as ‘mandatory’ or ‘conditional’ is summarised in Table 5.2.

Table 5.2: Communications Network Summary

Participant	Communication Type			
	Mandatory		Conditional	
	Input	Output	Input	Output
<i>Records Officer</i>	1	1		
<i>POAC Clerk</i>	1	4		
<i>Firm</i>		1	1	
<i>POAC Nurse</i>	2	2		
<i>Patient</i>	3	2	1	1
<i>Foundation Dr.</i>	3	2	3	4
<i>POAC Anaes</i>			3	3
<i>Proc. Anaes.</i>	2		2	2
<i>Other Specialist</i>			1	1

Considering both types, and all modalities of communication, 114 failure modes of the information exchange processes were identified. Seventy-seven

of these were resolved in the first round of the Delphi analysis into 44 acceptable risks and 33 requiring mitigation. Of the remaining 37 hazards, 8 were judged acceptable in the second round, and 29 requiring mitigation, for a total of 52 acceptable risks and 62 requiring mitigation. The identified communication channels, failure modes and Delphi HFMEA are presented in Table 5.5 (page 135 *et seq*). A summary of the numbers of hazards identified for the originator of each communication, and the recommendation to accept or mitigate is given in Table 5.3.

Table 5.3: Communication HFMEA Summary

Mandatory Communications			
From	Accept	Mitigate	Total
<i>Clerk</i>	11	3	14
<i>Firm</i>	1	1	2
<i>Records</i>	1	0	1
<i>Nurse</i>	9	8	17
<i>Foundation Doctor</i>	7	5	12
<i>Patient</i>	7	9	16
<i>POAC Anaesthetist</i>	-	-	-
<i>Other Specialist</i>	-	-	-
<i>Theatre Anaesthetist</i>	-	-	-
Mandatory Total	36	26	62
Conditional Communications			
From	Accept	Mitigate	Total
<i>Clerk</i>	-	-	-
<i>Firm</i>	-	-	-
<i>Records</i>	-	-	-
<i>Nurse</i>	3	0	3
<i>Foundation Doctor</i>	4	17	21
<i>Patient</i>	4	5	9
<i>POAC Anaesthetist</i>	5	8	13
<i>Other Specialist</i>	0	3	3
<i>Theatre Anaesthetist</i>	0	3	3
Conditional Total	16	36	52

5.6.1 Preliminary Activities

The *preliminary activities* are those operations carried out prior to the patient attending clinic. These consist mainly of the logistical operations needed to organise the clinic appointment, and ensuring the old case notes are made available. The procedure steps identified as significant hazards requiring preventive action include

- Ensuring that the POAC is effectively informed of the need for appointment
- Ensuring that the patient is notified of the appointment
- Locating the patient's previous medical records
- Alerting the referring firm if the patient fails to attend POAC

Specifically, the referring firm must effectively communicate the correct patient details to the POAC clerks when requesting an appointment. As appointments are sent by traditional mail there are a number of possible failures, for example, the mail may be sent to the wrong address, may be delayed or lost in the post. There is also the risk of the patient forgetting the appointment.

Review of available medical documentation is recommended practice [1, 171], so available medical records need to be retrieved. The lack of availability of case notes, particularly relating to non-NHS clinical events was noted as a significant issue. In the local context, the hospital records are still mainly in hard copy format. These need to be obtained from the Records Department or from other clinics. It is not uncommon for the notes not to be located. This eventuality should trigger remedial action, and be brought to the attention of the referring firm.

Failure of the patient to attend the POAC appointment must also be flagged to the firm, who can then take corrective action.

Regarding clinical matters, failure of the nurse to accurately extract relevant information from the old case notes was also flagged as an issue.

5.6.2 Nursing

The actionable points identified in the technical nursing tasks of the assessment were the inaccurate measurement of blood pressure, the possibility of mislabelling of MRSA screening samples, and the risk that the collected information is entered into the wrong Electronic Health Record.

There was also concern regarding various aspects of the nurse/patient interaction. These included:

- Nurse clerking (freeform) documentation may be unclear or incomplete
- Irrelevant or unclear clerking questions asked, particularly for unscripted, follow-up questions.
- The patient misunderstands the question.
- The nurse misunderstands the answer
- The nurse does not appreciate the significance of the information disclosed.

- The patient may not discuss issues perceived as minor comorbidities or symptoms
- The nurse gives the patient incorrect verbal information or instructions regarding forthcoming procedure.
- The patient misunderstands information or instructions given.

5.6.3 ECG and Other Reviews

No failures requiring intervention according to the HFMEA criteria were identified in this section.

5.6.4 Foundation Doctor

An examination of the communications network summary (Table 5.2, pg. 89) and the communications diagram (Figure 5.7, pg. 104) shows that the Foundation Doctor plays a central role in the flow of information through the preoperative process. All the information gathered from the patient, from the nurse, and the patient's documentation is aggregated through him or her.

A number of potential issues were identified in the Foundation Doctor contribution to the preoperative assessment process. These included logistical issues, such as the need to check the patient ID against the case notes and the software documentation being generated. Failure to cross-check a verbal history obtained from the patient against the old case notes and nurse clerking was also considered a risk. If the clinical findings are not entered immediately into the EHR, these may be entered incorrectly due to memory lapse.

Hazards analogous to those noted in the Nurse/patient interaction were also noted for the Foundation Doctor/Patient interaction. To recapitulate:

- Irrelevant or unclear clerking questions asked, particularly for unscripted, follow-up questions.
- The patient misunderstands the question.
- The doctor misunderstands the answer
- The doctor does not appreciate the significance of the information disclosed.
- The patient may not disclose issues perceived as minor

Also flagged was the risk of the inexperienced Foundation doctors missing important findings on clinical examination of the patient or review of ECG, or failing to appreciate the significance of the findings.

A number of actions of the Foundation doctor are discretionary. These will only be undertaken if the Foundation doctor, based on the information available, decides that they are necessary. This leads to even more possibilities of error requiring mitigation. Identified hazards include:

- Foundation doctor forgets to inform firm about problematic case.
- Foundation doctor does not request POAC anaesthetist review of problematic case
- Foundation doctor fails to request other specialist opinion
- Foundation doctor fails to review specialist opinion or investigation results ordered at POAC
- Foundation doctor fails to discuss problematic case with attending anaesthetist

The failures noted above may originate from a number of roots.

- Foundation Doctor may not recognise need for senior clinician (anaesthetist or other specialist) review
- Foundation Doctor cannot identify or is unable to contact senior clinician
- Foundation Doctor may forget to contact senior clinician
- Foundation doctor may give incorrect, incomplete or irrelevant information, or discusses the wrong patient.

In cases where outcomes of consultations, laboratory results or special investigations need to be reviewed, this may be forgotten. Similarly, when junior doctors change firm the outgoing Foundation doctor may fail to hand over the tasks of organising investigations or patient followup to the incoming doctor.

5.6.5 Clinic Anaesthetist

The lack of routine review of the Foundation doctor clerking by POAC anaesthetist, unless specifically requested, was identified as a significant point of failure in the POAC process.

Even once the POAC anaesthetist is engaged in the patient review, a number of hazards requiring mitigation were identified. These included misunderstandings between the Foundation doctor and anaesthetist when discussing a problem. This is compounded by a failure of the POAC anaesthetist to personally review the patient, accepting the, possibly erroneous, clinical findings of the Foundation doctor. In turn, the Foundation doctor may misunderstand advice from the anaesthetist, or document it incorrectly. The clinic anaesthetist may, in turn, fail to effectively inform the attending anaesthetist of problematic cases for a variety of reasons as listed below:

- POAC anaesthetist decides it is unnecessary to inform attending anaesthetist
- POAC anaesthetist cannot identify or contact attending anaesthetist
- POAC anaesthetist forgets to inform attending anaesthetist of problematic case
- POAC anaesthetist gives incorrect or incomplete information to attending anaesthetist
- POAC anaesthetist discusses wrong patient with attending anaesthetist

5.6.6 Attending Anaesthetist

The attending anaesthetist is the anaesthetist who will have ultimate responsibility for the anaesthetic management of the patient in the perioperative period. Although not formally part of the POAC, he or she may interact with clinic personnel, and is the ultimate recipient of the information gathered through the clinic. As such, their interaction with the rest of the clinic is important, but also has the potential of process failure. Notable hazards requiring mitigation included:

- Attending anaesthetist fails to review POAC documentation
- Attending anaesthetist reviews the wrong entry from EHR
- Attending anaesthetist misses important findings in the Nurse or Foundation doctor clerking
- Attending anaesthetist gives incomplete information or instructions to Foundation doctor or POAC anaesthetist for further workup
- Foundation doctor misunderstands instructions given by attending anaesthetist

5.6.7 Investigations

Tasks assigned to the Foundation doctor by the POAC or attending anaesthetist, such as organising further investigations or other specialist opinions may not be carried out due to omission, misunderstanding or for logistical reasons. When seeking specialist opinion, there is also the risk of poor communication, where the clinical issue is not clearly understood by the Foundation doctor, or not clearly explained to the specialist being consulted.

When a case is postponed for further investigation or optimisation, there is a risk of the patient being lost to followup. Also, the surgical firm may not

be notified of the postponement, leading to failure to book an alternative case and so loss of the theatre slot.

Failures may also occur in the operations of the phlebotomy service and laboratory. However, as these are not organisationally part of the POAC they were outside the scope of this HFMEA, and were not considered further.

5.6.8 Instructions to Patient

Multiple failures may occur at this point. The patient may be given incorrect or incomplete instructions regarding the procedure, admission date, time and place, fasting instructions, bowel preparation and management of medications.

5.6.9 Final Preparation

The results of pending investigations should be reviewed. This task is normally assigned to the Foundation doctor. This may be omitted, or abnormal results not brought to the attention of senior members of the firm or the attending anaesthetist. Investigation results requiring further intervention before surgery may not be acted upon. If the patient is postponed there is the risk of the patient being lost to followup.

5.7 Discussion

The FMEA and HFMEA techniques undertake a detailed review of low-level tasks in the process being analysed. These methods have been criticised as being very labour-intensive, cumbersome to use and inefficient [210, 214]. A suggested alternative approach is to perform a preliminary analysis with a high-level PHA such as the Prospective Risk Review (PRR) [192] or SWIFT [203]. Once the main areas of concern are identified, these may be studied in detail with the low-level task analysis.

The final steps of the HFMEA are to propose risk control actions and outcome measures, and to re-assess the process to ensure that no new hazards have been introduced. The tool, however, does not provide formal support for these steps [192, 214]. For this reason, the HFMEA process detailed in this work was terminated after the identification and effects analysis. Proposals to mitigate some of the actionable hazards identified are discussed later in this work.

The processes investigated and the failure modes identified in this analysis are clearly specific to the particular clinic at our institution. However, as noted in Section 5.3 the overall structure of the clinic is similar to several others described in the literature. Thus, some of the high-level process hazards identified may reasonably be expected to have analogues in similar clinics.

On an even more general level, the clinic investigated is an example of a healthcare microsystem comprising a network of carers necessitating information exchange between the participants and multiple handovers of responsibility for the patient. As such, it may provide some insights into potential pitfalls of such systems.

5.7.1 Team Composition

The HFMEA team initially consisted of 8 participants, which was within recommended limits [211] and similar to a number of FMEA studies reviewed by Habraken *et al.* [214]. The team included representatives from the main healthcare professionals involved in the clinic function, and collectively they had a good understanding of the workings of the preoperative clinic. Unfortunately, over the course of the process, three members were unable to continue, and the final group consisted entirely of anaesthetists of various grades.

The Foundation doctor withdrew during the stage of outlining the clinic processes, and the nurses withdrew after the identification of failure modes, thus the actual failure modes analysis was conducted exclusively by anaesthetists. The team, however, did not change further over the Delphi analysis. In view of this, it is likely that the process steps, and the failure modes identified accurately represent the clinic processes. However, the team composition for the hazard analysis may have led to an over-emphasis of the medical and clinical failure modes, and de-emphasis of problems in the nursing and logistical aspects of the process. This is, in fact, reflected in the process hazards summary shown in Table 5.1, where the proportion of hazards identified as requiring mitigation is much higher for the medical sections of the process as compared to the other sections.

5.7.2 Delphi Analysis

The use of a Delphi analysis to achieve consensus for the Hazard analysis is an unusual modification of the HFMEA technique. However, it helps address the difficulty of convening several team meetings, and also avoids the problem of domination by senior team members [211]. This could have been particularly problematic given the team included consultant anaesthetists.

The use of the arithmetic mean as the measure of central tendency of the frequency and severity scores for feedback in the Delphi process could be criticised. These are clearly ordinal data. In the case of Likert-type scores, however, it has been argued that use of parametric statistics is not unreasonable [215]. Furthermore, the values were only intended as a measure of central tendency to guide the re-evaluation. The possible loss of statistical rigour in these conditions was balanced by the simplification of the analysis.

Delphi procedures usually involve between 2—4 rounds [216, 217]. In the study, because of the risk of participant dropout due to ‘respondent fatigue’ [218], the process was terminated after two rounds.

A number of different criteria have been applied to determining achievement of consensus in Delphi procedures [217]. Agreement by 75% of participants is a common approach [217], and this threshold was used in the first round of the present study. In the second round, the threshold was lowered to 50%. Although it is usual practice to keep the same thresholds for all rounds in a standard Delphi procedure [217], this variation is justified as it allowed an adjudication of each failure mode on the second round. It also erred on the side of caution, tending to flag more error modes requiring mitigation than maintaining the 75% threshold would have.

5.7.3 Communication Network

The Communications HFMEA Summary (Table 5.2, page 89) shows the exchange of information between the clinic team members involved in assessing each patient. Several patients are usually seen in parallel at the clinic, and so each team member may participate in more than one team. The analysis only displays the information in any one team acting at a given time. It emerges that the Foundation doctor plays a central role in the flow of information through the clinic. Furthermore, this doctor, based on the aggregated information, needs to take a number of decisions regarding further patient management. In particular, this doctor, one of the least experienced clinic members, must recognise situations which will require advice from the POAC or attending anaesthetist. This decision may significantly influence the ultimate quality and adequacy of the preoperative assessment.

5.8 Conclusion

In the POAC investigated, the FY doctor has emerged as fulfilling a pivotal role. This doctor is responsible for the interpretation of the collected clinical information. The system is then reliant on his or her judgement to identify any problems and whether these should be flagged to more senior staff. It is likely that aids for this decision making, and to facilitate communication with other members of staff would improve the reliability of the process. The design and preliminary characterisation of such an aid is described elsewhere in this work.

5.9 Diagrams and Tables

Flowcharts for the POAC pathway and a diagram depicting communication between different participants are given below in Figures 5.1—5.6. A diagram of the clinic information exchange processes is shown in Figure 5.7. Details of the clinic process HFMEA are given in Table 5.4 and of the information exchange HFMEA in Table 5.5. These figures and tables extend

over several pages and are presented here to avoid interruption of the main chapter text.

Figure 5.1: Preoperative Clinic Process Flow Diagram

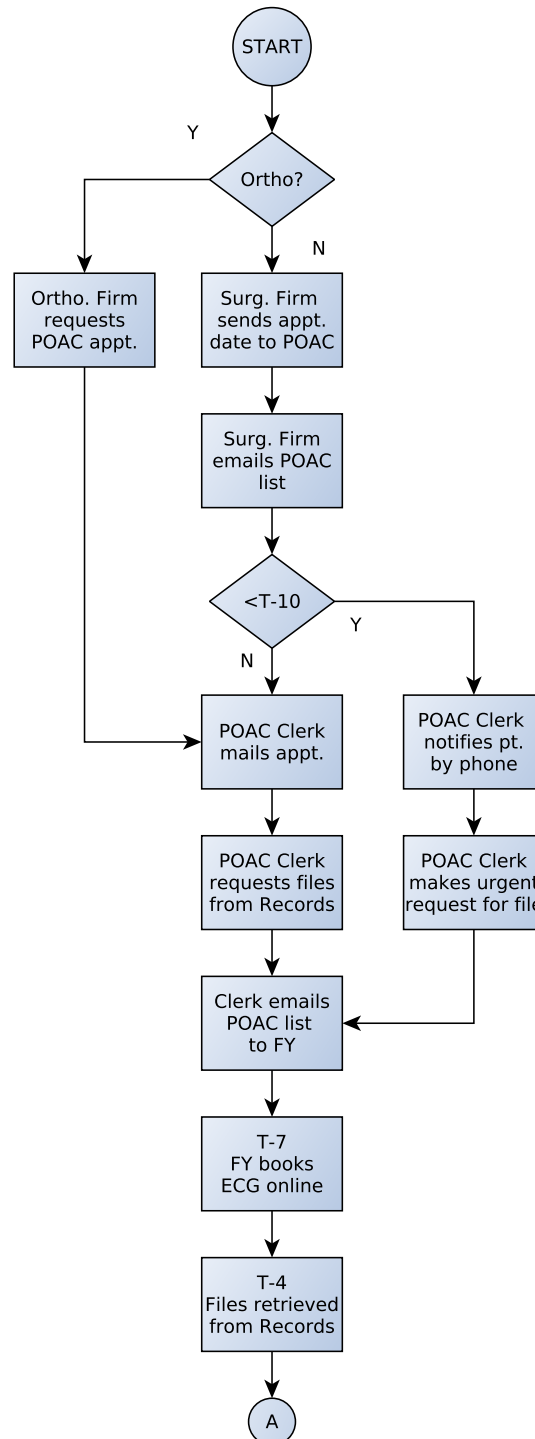

Figure 5.2: Preoperative Clinic Process Flow Diagram

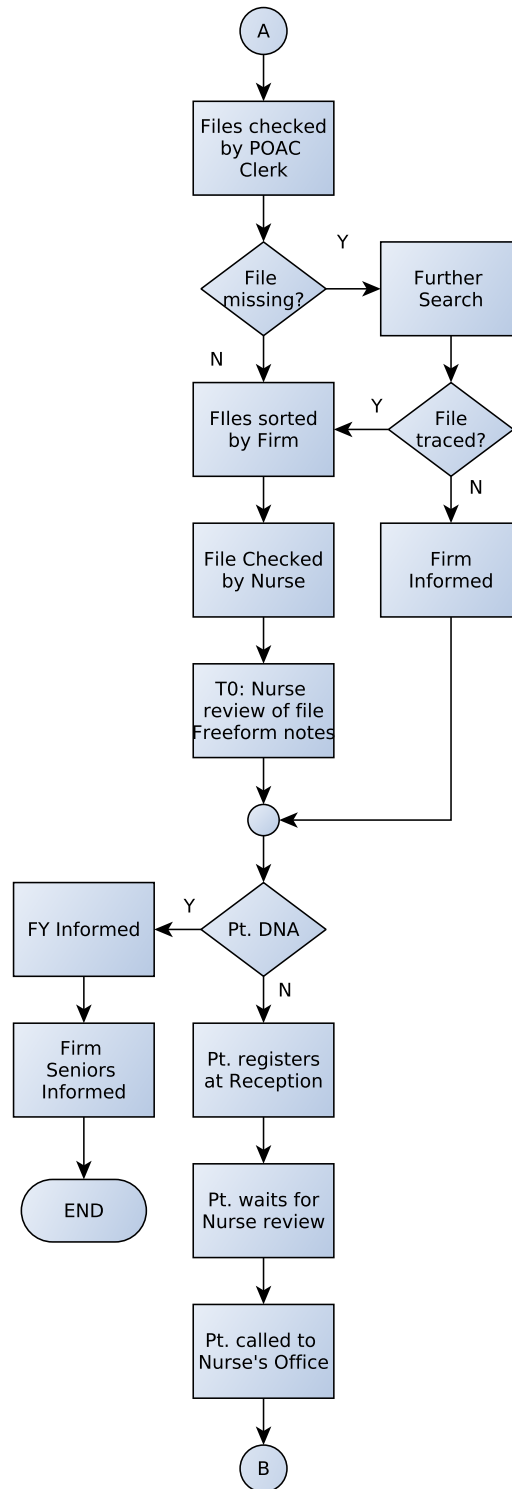

Figure 5.3: Preoperative Clinic Process Flow Diagram

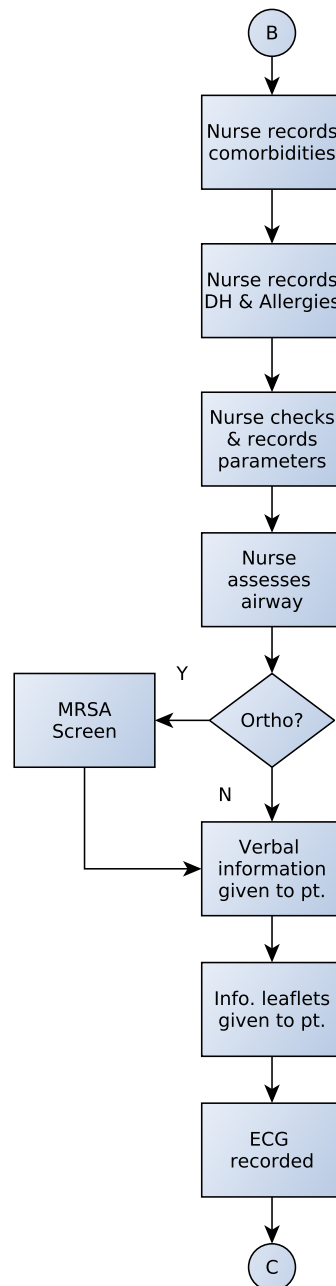

Figure 5.4: Preoperative Clinic Process Flow Diagram

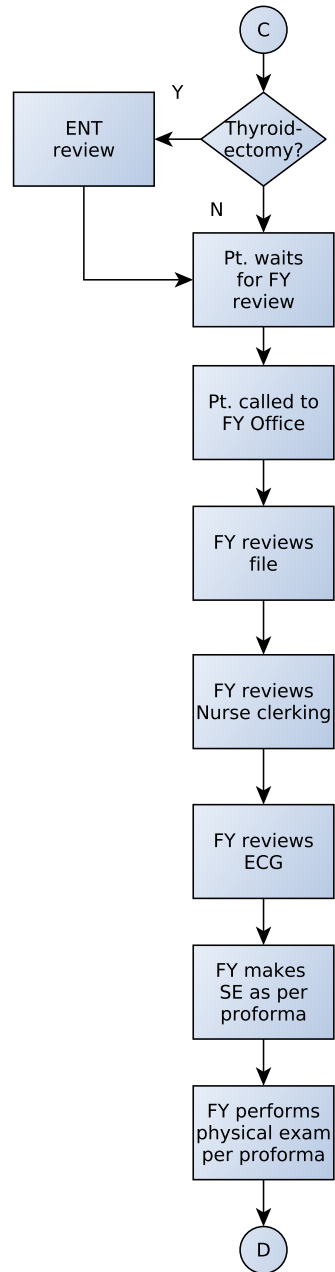

Figure 5.5: Preoperative Clinic Process Flow Diagram

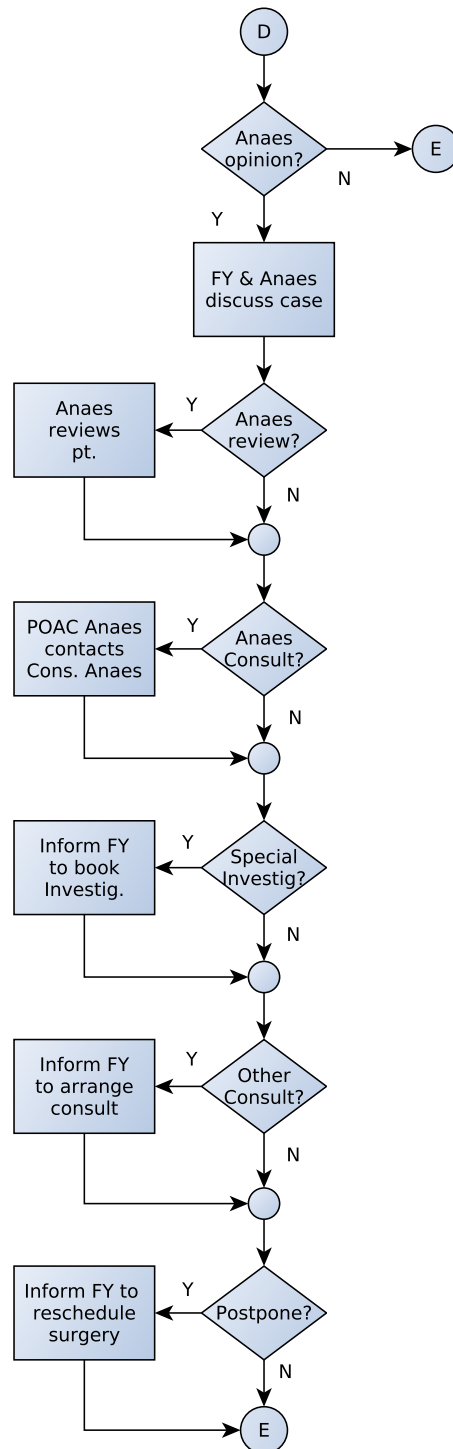

Figure 5.6: Preoperative Clinic Process Flow Diagram

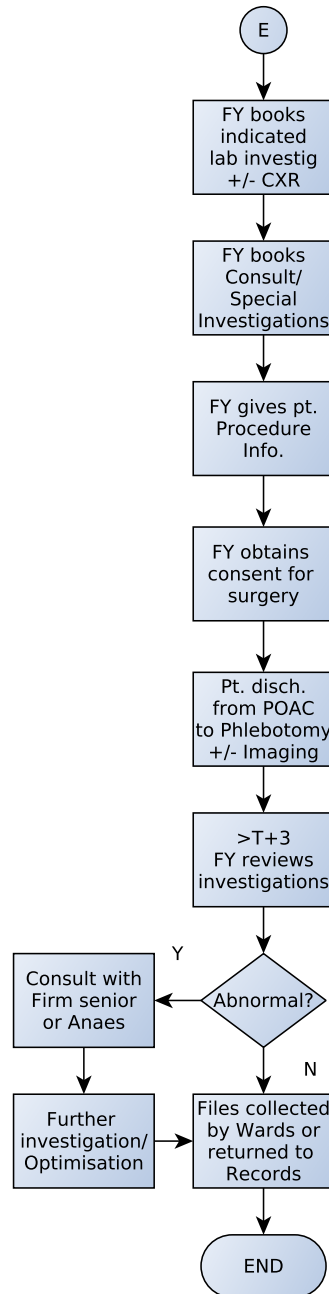

Table 5.4: Process HFMEA

Code	Process Step	Analysis								
Preliminary										
1A	Surgical Firm sends appt. date to POAC	Round 1				Round 2				Recommendation
Failure Mode		n	total	%	Analysis #1	n	total	%	Analysis #2	
1A1	Incorrect details	2	5	40	→R2	1	5	20	Accept	Accept
1A2	Late booking	0	5	0	Accept					Accept
1A3	Booking not sent	3	5	60	→R2	5	5	100	ACTION	ACTION
1A4	POAC list not sent	3	5	60	→R2	4	5	80	ACTION	ACTION
1A5	Rescheduling	1	5	20	Accept					Accept
1A6	No op. date	1	5	20	Accept					Accept
1A7	Pt. for local only ? No preop required	0	5	0	Accept					Accept
1B	Surgical Firm emails POAC list	Round 1				Round 2				Recommendation
Failure Mode		n	total	%	Analysis #1	n	total	%	Analysis #2	
1B1	Incorrect details	3	5	60	→R2	4	5	80	ACTION	ACTION
1B2	Late booking	0	4	0	Accept					Accept

cntd. next page

Code	Process Step	Analysis								
<i>cntd. from previous page</i>										
1B3	Booking not sent	2	4	50	→R2	2	5	40	Accept	Accept
1B4	POAC list not sent	2	4	50	→R2	1	5	20	Accept	Accept
1B5	Rescheduling	0	4	0	Accept					Accept
1B6	No op. date	0	4	0	Accept					Accept
1B7	Pt. for local only ? No preop required	0	4	0	Accept					Accept
1C	If Ortho case, Firm requests POAC appt.	Round 1				Round 2				Recommendation
Failure Mode	n	total	%	Analysis #1	n	total	%	Analysis #2		
1C1	Incorrect details	3	4	75	ACTION					ACTION
1C2	Late booking	0	4	0	Accept					Accept
1C3	Booking not sent	2	4	50	→R2	4	5	80	ACTION	ACTION
1C4	POAC list not sent	2	4	50	→R2	3	5	60	ACTION	ACTION
1C5	Rescheduling	0	4	0	Accept					Accept
1C6	No op. date	0	4	0	Accept					Accept
1C7	Pt. for local only ? No preop required	0	4	0	Accept					Accept
1D	POAC Clerk mails appointment	Round 1				Round 2				Recommendation
<i>cntd. next page</i>										

Code	Process Step	Analysis									
<i>cntd. from previous page</i>											
Failure Mode	n	total	%	Analysis #1	n	total	%	Analysis #2			
1D1	Late post	2	5	40	→R2	2	5	40	Accept	Accept	
1D2	Delayed post (inter- nal/external)	2	5	40	→R2	2	5	40	Accept	Accept	
1D3	?phone as backup	0	3	0	Accept					Accept	
1D4	Pt may not have time to get occ. Therapy documentation	0	3	0	Accept					Accept	
1D5	Wrong address	4	5	80	ACTION					ACTION	
1E	POAC Clerk re- quests files	Round 1			Round 2			Recommendation			
Failure Mode	n	total	%	Analysis #1	n	total	%	Analysis #2			
1E1	File already in use in other dept.	0	5	0	Accept					Accept	
1E2	File misplaced	0	5	0	Accept					Accept	
1E3	File lost	0	5	0	Accept					Accept	
1E4	Gozitan files (by phone)	0	5	0	Accept					Accept	
1E5	Special clinic records (Gynae, ENT) not found	0	5	0	Accept					Accept	
<i>cntd. next page</i>											

Code		Process Step		Analysis									
<i>cntd. from previous page</i>													
1F	If T<10, POAC Clerk notifies pt. by phone			Round 1				Round 2				Recommendation	
Failure Mode	n	total	%	Analysis #1				n	total	%	Analysis #2		
1F1	Wrong ID/wrong number	2	5	40	→R2				2	5	40	Accept	Accept
1F2	Cannot contact pt (not at given no)	1	5	20	Accept								Accept
1F3	Relatives unaware of procedure	0	5	0	Accept								Accept
1F4	(if cannot be contacted ? Firm informed)	0	5	0	Accept								Accept
1F5	Misunderstanding date	3	5	60	→R2				3	5	60	ACTION	ACTION
1F6	Misunderstanding clinic	1	5	20	Accept								Accept
1G	If T<10, POAC Clerk makes urgent request for file			Round 1				Round 2				Recommendation	
<i>cntd. next page</i>													

Code	Process Step	Analysis									
<i>cntd. from previous page</i>											
Failure Mode		n	total	%	Analysis #1	n	total	%	Analysis #2		
1G1	By email (to 3 email addresses)	1	4	25	Accept					Accept	
1G2	Wrong details sent	4	5	80	ACTION					ACTION	
1G3	Details misread	3	5	60	→R2	4	5	80	ACTION	ACTION	
1H	Clerk emails POAC list to FY	Round 1				Round 2				Recommendation	
Failure Mode		n	total	%	Analysis #1	n	total	%	Analysis #2		
1H1	Not received	1	5	20	Accept					Accept	
1H2	Not acted on	1	5	20	Accept					Accept	
1H3	ECG Booked too late	1	5	20	Accept					Accept	
1I	FY books ECG on-line	Round 1				Round 2				Recommendation	
Failure Mode		n	total	%	Analysis #1	n	total	%	Analysis #2		
1I1	Request not found on line	0	5	0	Accept					Accept	
1I2	Wrong pt booked	0	5	0	Accept					Accept	
1J	Files retrieved from records	Round 1				Round 2				Recommendation	
<i>cntd. next page</i>											

Code Process Step		Analysis							
<i>cntd. from previous page</i>									
Failure Mode		n	total	%	Analysis #1	n	total	%	Analysis #2
1J1	Wrong file sent from records	0	5	0	Accept				Accept
1J2	Not all volumes sent	0	5	0	Accept				Accept
1J3	Files delayed from Gozo	1	5	20	Accept				Accept
1K	Files checked by POAC clerk	Round 1			Round 2			Recommendation	
Failure Mode		n	total	%	Analysis #1	n	total	%	Analysis #2
1K1	Clerks not available on Sat/Sun	0	4	0	Accept				Accept
1L	Files sorted according to Firm	Round 1			Round 2			Recommendation	
Failure Mode		n	total	%	Analysis #1	n	total	%	Analysis #2
1L1	Come batched by firm from records	0	4	0	Accept				Accept
1M	File checked by Nurse	Round 1			Round 2			Recommendation	
Failure Mode		n	total	%	Analysis #1	n	total	%	Analysis #2
<i>cntd. next page</i>									

Code	Process Step	Analysis									
<i>cntd. from previous page</i>											
1M1	Sometimes no time	0	5	0	Accept						Accept
1M2	Files arrive late (delay between file prep room clinic)	0	5	0	Accept						Accept
1N	If file missing, further search for file	Round 1				Round 2				Recommendation	
Failure Mode		n	total	%	Analysis #1	n	total	%	Analysis #2		
1N1	Still untraced	0	5	0	Accept						Accept
1O	if file not traced, Firm informed	Round 1				Round 2				Recommendation	
Failure Mode		n	total	%	Analysis #1	n	total	%	Analysis #2		
1O1	No action taken	3	5	60	→R2	3	5	60	ACTION	ACTION	
1P	T0: Nurse reviews file, taking freeform notes	Round 1				Round 2				Recommendation	
Failure Mode		n	total	%	Analysis #1	n	total	%	Analysis #2		
1P1	Important entries missed	2	5	40	→R2	3	5	60	ACTION	ACTION	
1P2	Notes misplaced	3	5	60	→R2	5	5	100	ACTION	ACTION	
<i>cntd. next page</i>											

Code Process Step		Analysis								
<i>cntd. from previous page</i>										
1Q	If pt. Does not attend, FY informed	Round 1				Round 2				Recommendation
Failure Mode		n	total	%	Analysis #1	n	total	%	Analysis #2	
1Q1	No failures identified	0	1	0	Accept					Accept
1R	If pt. Does not attend, FY informs Firm seniors	Round 1				Round 2				Recommendation
Failure Mode		n	total	%	Analysis #1	n	total	%	Analysis #2	
1R1	Forgets to inform seniors	2	5	40	→R2	4	5	80	ACTION	ACTION
1R2	Email to firm secretary not sent	2	4	50	→R2	4	5	80	ACTION	ACTION
1R3	Not documented in file	0	4	0	Accept					Accept
1S	Pt. registers at reception	Round 1				Round 2				Recommendation
Failure Mode		n	total	%	Analysis #1	n	total	%	Analysis #2	
1S1	Clerk enters wrong contact information	1	4	25	Accept					Accept
<i>cntd. next page</i>										

Code	Process Step	Analysis								Recommendation
<i>cntd. from previous page</i>										
1T	Pt. waits in foyer for nurse review	Round 1				Round 2				Recommendation
Failure Mode		n	total	%	Analysis #1	n	total	%	Analysis #2	
1T1	Patient leaves before being called	1	5	20	Accept					Accept
Nurse										
2A	Pt. called to Nurse's Office	Round 1				Round 2				Recommendation
Failure Mode		n	total	%	Analysis #1	n	total	%	Analysis #2	
2A1	Wrong patient walks in. Likely if two patients with same name and surname.	0	5	0	Accept					Accept
2A2	Patients sometimes need more time than others	0	5	0	Accept					Accept
2B	Nurse records co-morbidities	Round 1				Round 2				Recommendation
<i>cntd. next page</i>										

Code		Process Step			Analysis							
<i>cntd. from previous page</i>												
Failure Mode		n	total	%	Analysis #1			Analysis #2				
2B2	Not done properly, especially if patient is not fully aware of medical diagnoses.	0	5	0	Accept						Accept	
2B3	File contains documents from another patient (eg ECG, Echo)	2	5	40	→R2			2	5	40	Accept	Accept
2B4	Unclear diagnoses	0	5	0	Accept						Accept	
2C Nurse records Drug History and Allergies		Round 1			Round 2			Recommendation				
Failure Mode		n	total	%	Analysis #1			Analysis #2				
2C1	Drug history sometimes problematic, patients although instructed never get their treatment	1	5	20	Accept						Accept	
<i>cntd. next page</i>												

Code	Process Step	Analysis									
<i>cntd. from previous page</i>											
2C2	Drug doses not recorded/recorded as 'tablets'	0	5	0	Accept						Accept
2C3	Dose frequency not recorded	0	5	0	Accept						Accept
2C4	Use of trade names	0	5	0	Accept						Accept
2D	Nurse measures and records parameters	Round 1				Round 2				Recommendation	
Failure Mode		n	total	%	Analysis #1	n	total	%	Analysis #2		
2D1	Not done properly: inappropriately sized BP cuffs,	2	5	40	→R2	3	5	60	ACTION	ACTION	
2D2	not enough time allowed for pulse oximeter to give accurate reading	1	5	20	Accept					Accept	
2D3	Nurses prefer battery operated B/P machines to manual.not always accurate.	0	5	0	Accept					Accept	

cntd. next page

Code	Process Step	Analysis								
<i>cntd. from previous page</i>										
2D4	Parameters not always recorded completely.	0	5	0	Accept	Accept				
2D5	Weight unable to be obtained in patients who cannot stand up and mobilise.	0	5	0	Accept	Accept				
2D6	No bariatric scale	1	5	20	Accept	Accept				
2E	Nurse assesses airway	Round 1			Round 2		Recommendation			
Failure Mode		n	total	%	Analysis #1	n	total	%	Analysis #2	
2E1	Overestimation of Mallampati score.	0	5	0	Accept					Accept
2E2	underestimation of the Mallampati score	0	5	0	Accept					Accept
2F	If Arthroplasty case, Nurse takes MRSA screen	Round 1			Round 2		Recommendation			
<i>cntd. next page</i>										

Code Process Step		Analysis								
<i>cntd. from previous page</i>										
Failure Mode		n	total	%	Analysis #1	n	total	%	Analysis #2	
2F1	Wrong labelling	2	5	40	→R2	3	5	60	ACTION	ACTION
2F2	Hand written sample labels.	2	4	50	→R2	2	5	40	Accept	Accept
2G	Nurse gives verbal info to pt.	Round 1				Round 2			Recommendation	
Failure Mode		n	total	%	Analysis #1	n	total	%	Analysis #2	
2G1	nurses lack necessary information and resources	0	5	0	Accept					Accept
2H	Nurse gives pt. Information leaflets	Round 1				Round 2			Recommendation	
Failure Mode		n	total	%	Analysis #1	n	total	%	Analysis #2	
2H1	Planned procedure might not be exactly as described in info leaflet	1	5	20	Accept					Accept

cntd. next page

Code	Process Step	Analysis								
<i>cntd. from previous page</i>										
ECG etc										
3A	Pt. sent for ECG	Round 1				Round 2				Recommendation
Failure Mode		n	total	%	Analysis #1	n	total	%	Analysis #2	
3A1	ECG not booked	0	5	0	Accept					Accept
3A2	New guidelines will alter patient flow	0	4	0	Accept					Accept
3A3	Patient sent to foyer to pick Number for ECG	0	3	0	Accept					Accept
3A4	Pt. thinks POAC consult is complete and leaves clinic	0	5	0	Accept					Accept
3B	If thyroidectomy, pt. sent for ENT review	Round 1				Round 2				Recommendation
Failure Mode		n	total	%	Analysis #1	n	total	%	Analysis #2	
3B1	Long wait at ENT OP. as a result might miss POAC time-slot.	0	5	0	Accept					Accept
<i>cntd. next page</i>										

Code	Process Step	Analysis								
<i>cntd. from previous page</i>										
3B2	Patient leaves hospital, thinking s/he's done for the day	0	5	0	Accept				Accept	
3B3	Findings recorded separately. ENT documentation not given to patient or misplaced	0	5	0	Accept				Accept	
3C	Pt. sent to Foyer to wait for FY review	Round 1				Round 2				Recommendation
Failure Mode		n	total	%	Analysis #1	n	total	%	Analysis #2	
3C1	Pt thinks POAC visit is complete and leaves	0	4	0	Accept					Accept
3D	Pt. called to FY Office	Round 1				Round 2				Recommendation
Failure Mode		n	total	%	Analysis #1	n	total	%	Analysis #2	
3D1	Wrong patient walks in.	0	5	0	Accept					Accept
<i>cntd. next page</i>										

Code	Process Step	Analysis								
<i>cntd. from previous page</i>										
3D2	Patients sometimes wander around	0	5	0	Accept				Accept	
3D3	FY does not call patients to be seen in the specified order, according to established appointment and time-slot	1	5	20	Accept				Accept	
Foundation Doctor										
4A	FY reviews pt. File	Round 1				Round 2				Recommendation
Failure Mode		n	total	%	Analysis #1	n	total	%	Analysis #2	
4A1	Pt. ID not checked	2	5	40	→R2	3	5	60	ACTION	ACTION
4A2	Inadequate review of patient file, missing important findings	3	5	60	→R2	4	5	80	ACTION	ACTION
4B	FY reviews Nurse clerking	Round 1				Round 2				Recommendation
Failure Mode		n	total	%	Analysis #1	n	total	%	Analysis #2	
4B1	FY misses comments documented by nurse	1	5	20	Accept					Accept
<i>cntd. next page</i>										

Code		Process Step				Analysis				
<i>cntd. from previous page</i>										
4C	FY reviews ECG	Round 1				Round 2				Recommendation
	Failure Mode	n	total	%	Analysis #1	n	total	%	Analysis #2	
4C1	Pt ID not checked	2	5	40	→R2	1	5	20	Accept	Accept
4C2	Some important findings may be missed, especially if inexperienced.	2	5	40	→R2	5	5	100	ACTION	ACTION
4D	FY makes systemic enquiry as per proforma	Round 1				Round 2				Recommendation
	Failure Mode	n	total	%	Analysis #1	n	total	%	Analysis #2	
4D1	Not fully completed, missing some symptoms.	1	5	20	Accept					Accept
4D2	FY relying only on patient history during appointment without cross-checking records	4	5	80	ACTION					ACTION
<i>cntd. next page</i>										

Code	Process Step	Analysis									
<i>cntd. from previous page</i>											
4D3	Problems not on pro-forma	4	5	80	ACTION						ACTION
4D4	Previous episodes/condtions not recorded in hospital notes (non-NHS treatment)	3	5	60	→R2	4	5	80	ACTION		ACTION
4D5	FY logs onto wrong pt ICM file	3	5	60	→R2	4	5	80	ACTION		ACTION
4E	FY performs physical exam	Round 1				Round 2				Recommendation	
Failure Mode		n	total	%	Analysis #1	n	total	%	Analysis #2		
4E1	Not done appropriately, missing some clinical signs	4	5	80	ACTION						ACTION
4E2	Inadequate due to time pressure	5	5	100	ACTION						ACTION
4E3	FY fails to elicit important signs during physical examination e.g. cardiac murmur etc.	5	5	100	ACTION						ACTION
<i>cntd. next page</i>											

Code	Process Step	Analysis									
<i>cntd. from previous page</i>											
4E4	fails to act upon significant clinical signs	5	5	100	ACTION						ACTION
4E5	Proforma too restrictive	2	4	50	→R2	1	5	20	Accept		Accept
POAC Anaesthetist											
5A	If FY requests anaes opinion, FY and Anaes discuss case	Round 1				Round 2				Recommendation	
Failure Mode		n	total	%	Analysis #1	n	total	%	Analysis #2		
5A1	If relevant information is not picked up, the anaesthetist is given the wrong impression	4	4	100	ACTION					ACTION	
5A2	FY does not inform or involve anaesthetist when faced with comorbidities which are erroneously assumed to be of a lesser importance e.g. significant obesity, OSA, intellectual disability, syndromic patients, etc.	4	4	100	ACTION					ACTION	

cntd. next page

Code	Process Step	Analysis									
<i>cntd. from previous page</i>											
5A3	POAC session over-running beyond 14:30h and as a result FY doctor reviewing the patient will be unable to consult the POAC anaesthetist who would already have left the clinic	3	4	75	ACTION			ACTION			
5B	If pt. review, reviews pt	Needs Anaes	Round 1			Round 2		Recommendation			
Failure Mode			n	total	%	Analysis #1	n	total	%	Analysis #2	
5B1	Anaesthetist might fail to examine or review the patient and give a limited or superficial opinion		5	5	100	ACTION					ACTION
								<i>cntd. next page</i>			

Code	Process Step	Analysis									
<i>cntd. from previous page</i>											
5B2	Pt already discharged from clinic or sent for other workup	1	5	20	Accept						Accept
5C	If POAC Anaes needs Anaes Consult, Cons. Anaes contacted				Round 1				Round 2		Recommendation
	Failure Mode	n	total	%	Analysis #1	n	total	%	Analysis #2		
5C1	POAC consultant anaesthetist not available. List consultant anaesthetist on leave/unreachable on that day.	2	5	40	→R2	1	5	20	Accept		Accept
5C2	Failure of POAC anaesthetist to liaise with Consultant anaesthetist responsible for anaesthetising patient on the day.	3	5	60	→R2	4	5	80	ACTION		ACTION
<i>cntd. next page</i>											

Code	Process Step	Analysis									
<i>cntd. from previous page</i>											
5C3	Failure of clear management plan, maybe partly because POAC anaesthetist is unable to document suggestions but relies on documentation by FY doctor (open to misinterpretation).	5	5	100	ACTION						ACTION
5C4	Cannot be identified (alternating lists, am/pm lists)	2	5	40	→R2	2	5	40	Accept		Accept
5C5	Communication misunderstood	5	5	100	ACTION						ACTION
5D	If special investigations required, FY informed	Round 1			Round 2				Recommendation		
Failure Mode		n	total	%	Analysis #1	n	total	%	Analysis #2		
5D1	Investigations not ordered	3	5	60	→R2	5	5	100	ACTION	ACTION	
<i>cntd. next page</i>											

Code	Process Step	Analysis									
<i>cntd. from previous page</i>											
5D2	Incorrect investigations ordered	3	5	60	→R2	5	5	100	ACTION	ACTION	
5D3	Ordered for wrong patient on iSoft	3	5	60	→R2	4	5	80	ACTION	ACTION	
5E	If other specialist consult required, FY informed	Round 1				Round 2				Recommendation	
Failure Mode		n	total	%	Analysis #1	n	total	%	Analysis #2		
5E1	Consult not requested	4	5	80	ACTION					ACTION	
5E2	Requested too late	3	5	60	→R2	4	5	80	ACTION	ACTION	
5E3	No clear pathway for early referrals	4	5	80	ACTION					ACTION	
5F	If case postponed, FY informed	Round 1				Round 2				Recommendation	
Failure Mode		n	total	%	Analysis #1	n	total	%	Analysis #2		
5F1	FY does not inform firm seniors, inadvertently keeping patient on the list.	2	5	40	→R2	2	5	40	Accept	Accept	
											<i>cntd. next page</i>

Code	Process Step	Analysis								
<i>cntd. from previous page</i>										
5F2	FY gap in informing all stakeholders	2	5	40	→R2	4	5	80	ACTION	ACTION
5F3	Postponed pt. Not recalled	3	5	60	→R2	4	5	80	ACTION	ACTION
Investigations										
6A	FY books investigations	Round 1				Round 2				Recommendation
Failure Mode		n	total	%	Analysis #1	n	total	%	Analysis #2	
6A1	Not booked.	3	5	60	→R2	4	5	80	ACTION	ACTION
6A2	If a paper request is done, it may be lost.	3	5	60	→R2	3	5	60	ACTION	ACTION
6A3	Sometimes too early	0	5	0	Accept					Accept
6A4	Log onto wrong pt	2	5	40	→R2	4	5	80	ACTION	ACTION
6A5	Inappropriate requests (eg CXR, coag)	0	5	0	Accept					Accept
6B	FY requests consultations	Round 1				Round 2				Recommendation
Failure Mode		n	total	%	Analysis #1	n	total	%	Analysis #2	
										<i>cntd. next page</i>

Code	Process Step	Analysis								
<i>cntd. from previous page</i>										
6B1	Not requested.	4	5	80	ACTION					ACTION
6B2	If a paper request is done, it may be lost.	3	5	60	→R2	4	5	80	ACTION	ACTION
6B3	After hours is a problem to consult	2	5	40	→R2	3	5	60	ACTION	ACTION
6B4	advice over the phone accepted as a more convenient but less reliable compromise.	2	5	40	→R2	3	5	60	ACTION	ACTION
6B5	Inadequate consult/advice on phone only	3	5	60	→R2	4	5	80	ACTION	ACTION
6C	FY books special investigations	Round 1				Round 2				Recommendation
Failure Mode		n	total	%	Analysis #1	n	total	%	Analysis #2	
6C1	Not booked.	5	5	100	ACTION					ACTION
6C2	If a paper request is done, it may be lost.	3	4	75	ACTION					ACTION
6C3	After hours is a problem to book	1	4	25	Accept					Accept
<i>cntd. next page</i>										

Code	Process Step	Analysis									
<i>cntd. from previous page</i>											
6D	FY gives verbal info to pt. Re procedure	Round 1				Round 2				Recommendation	
Failure Mode	n	total	%	Analysis #1	n	total	%	Analysis #2			
6D1	Wrong sort of consent/some important details missed.	2	5	40	→R2	4	5	80	ACTION	ACTION	
6D2	Depending on procedure	1	2	50	→R2	1	2	50	ACTION	ACTION	
6D3	Details of admission date/time/department misunderstood by patient	2	5	40	→R2	5	5	100	ACTION	ACTION	
6D4	Fasting details incorrect or misunderstood (written by FY)	2	5	40	→R2	4	5	80	ACTION	ACTION	
6D5	Bowel prep instruction incorrect or misunderstood	3	5	60	→R2	4	5	80	ACTION	ACTION	
6E	Pt discharged from POAC to phlebotomy +/- Imaging	Round 1				Round 2				Recommendation	
<i>cntd. next page</i>											

Code	Process Step	Analysis									
<i>cntd. from previous page</i>											
Failure Mode		n	total	%	Analysis #1	n	total	%	Analysis #2		
6E1	Patient gets lost	0	5	0	Accept					Accept	
6E2	Pts asked to follow markings on floor might not get the order right/	0	5	0	Accept					Accept	
6E3	Patient leaves before these are done or in between.	0	5	0	Accept					Accept	
6E4	Wrong labelling of blood bottles.	3	5	60	→R2	3	5	60	ACTION	ACTION	
6E5	sometimes FY miss to book on time	0	5	0	Accept					Accept	
Finalization											
7A	≥T+3:- FY reviews investigations and specialist opinions	Round 1			Round 2			Recommendation			
Failure Mode		n	total	%	Analysis #1	n	total	%	Analysis #2		
7A1	Not done	4	5	80	ACTION					ACTION	
7A2	not followed up	5	5	100	ACTION					ACTION	
<i>cntd. next page</i>											

Code	Process Step	Analysis									
<i>cntd. from previous page</i>											
7A3	Not printed and included in POAC folder	1	5	20	Accept						Accept
7B	If abnormal, FY informs Firm seniors or Cons. Anaes	Round 1				Round 2				Recommendation	
Failure Mode		n	total	%	Analysis #1	n	total	%	Analysis #2		
7B1	Consultant anaesthetist not informed/on leave/unreachable./cannot identify	1	5	20	Accept					Accept	
7B2	Failure to act when faced by abnormal results of investigations	5	5	100	ACTION					ACTION	
7B3	Caring consultant not informed despite postponement.	2	5	40	→R2	3	5	60	ACTION	ACTION	
7B4	Patient does not understand the outcome and turns up for surgery anyway	2	5	40	→R2	2	5	40	Accept	Accept	
											<i>cntd. next page</i>

Code Process Step		Analysis								
<i>cntd. from previous page</i>										
7C	If abnormal, further investigations, optimisation or postponement	Round 1				Round 2				Recommendation
		Failure Mode	n	total	%	Analysis #1	n	total	%	
7C1	No optimization organized.	5	5	100	ACTION					ACTION
7C2	MOP appt is in several months' time.	2	5	40	→R2	1	5	20	Accept	Accept
7C3	Pathology for which patient is undergoing surgery advances further.	4	5	80	ACTION					ACTION
7C4	Space of time between investigations and optimising treatment can be a long wait	2	5	40	→R2	2	4	50	ACTION	ACTION
7C5	Failure to recall and reschedule surgery if postponed, optimised and now deemed fit	3	5	60	→R2	5	5	100	ACTION	ACTION

cntd. next page

Table 5.5: Information Exchange HFMEA

Information Exchange		Analysis								
Mandatory										
M1										
From:	Clerk									
To:	FY									
Message:	POAC List									
Modality:	email									
Failure Mode		Round 1				Round 2				Recommendation
		n	total	%	Analysis #1	n	total	%	Analysis #2	
M1.1	Not received	0	5	0	Accept					Accept
M1.2	Not read	1	5	20	Accept					Accept
M1.3	Not acted on	1	5	20	Accept					Accept
M2										
From:	Clerk									
To:	Nurse									
Message:	Appt. Details									
Modality:	Hard copy/Online									
Failure Mode		Round 1				Round 2				Recommendation
		n	total	%	Analysis #1	n	total	%	Analysis #2	
<i>cntd. next page</i>										

Information Exchange		Analysis								
<i>cntd. from previous page</i>										
M2.1	No Failure Identified	0	2	0	Accept				Accept	
M3										
From:	Clerk									
To:	Nurse									
Message:	Pt. File									
Modality:	physical									
Failure Mode		Round 1				Round 2				Recommendation
		n	total	%	Analysis #1	n	total	%	Analysis #2	
M3.1	Not traced	1	5	20	Accept					Accept
M4										
From:	Clerk									
To:	Patient									
Message:	Appt. details									
Modality:	mail									
Failure Mode		Round 1				Round 2				Recommendation
		n	total	%	Analysis #1	n	total	%	Analysis #2	
M4.1	Wrong address	3	5	60	→R2	4	5	80	ACTION	ACTION
M4.2	Late/lost mail	2	5	40	→R2	3	5	60	ACTION	ACTION
M4.3	Forgotten	3	5	60	→R2	3	5	60	ACTION	ACTION
<i>cntd. next page</i>										

Information Exchange		Analysis								
<i>cntd. from previous page</i>										
M5										
From:	Clerk									
To:	Patient									
Message:	Appt. details									
Modality:	Phone									
Failure Mode		Round 1				Round 2				Recommendation
		n	total	%	Analysis #1	n	total	%	Analysis #2	
M5.1	Wrong phone number	2	5	40	→R2	0	5	0	Accept	Accept
M5.2	No answer	1	5	20	Accept					Accept
M6										
From:	Clerk									
To:	Records									
Message:	File request									
Modality:	hard copy									
Failure Mode		Round 1				Round 2				Recommendation
		n	total	%	Analysis #1	n	total	%	Analysis #2	
M6.1	no failure identified	0	1	0	Accept					Accept
M7										
From:	Clerk									

cntd. next page

Information Exchange		Analysis								
<i>cntd. from previous page</i>										
To: Theatre Anaes.										
Message: Pt. File										
Modality: physical										
Failure Mode		Round 1				Round 2				Recommendation
		n	total	%	Analysis #1	n	total	%	Analysis #2	
M7.1	File not found	0	5	0	Accept					Accept
M7.2	Files not retrieved by admitting ward	1	5	20	Accept					Accept
M7.3	File misplaced on ward	1	5	20	Accept					Accept
<hr/>										
M8										
From: Firm										
To: Clerk										
Message: POAC appt. request										
Modality: email										
Failure Mode		Round 1				Round 2				Recommendation
		n	total	%	Analysis #1	n	total	%	Analysis #2	
M8.1	no failure identified	0	1	0	Accept					Accept
<hr/>										
M9										
From: Firm										
										<i>cntd. next page</i>

Information Exchange		Analysis								
<i>cntd. from previous page</i>										
To:	Clerk									
Message:	POAC list									
Modality:	email									
Failure Mode		Round 1				Round 2				Recommendation
		n	total	%	Analysis #1	n	total	%	Analysis #2	
M9.1	Wrong details	3	5	60	→R2	4	5	80	ACTION	ACTION
<hr/>										
M10										
From:	FY									
To:	Patient									
Message:	Clerking questions									
Modality:	Face-to-face/proforma									
Failure Mode		Round 1				Round 2				Recommendation
		n	total	%	Analysis #1	n	total	%	Analysis #2	
M10.1	Wrong patient	0	4	0	Accept					Accept
M10.2	IT System crashes	0	4	0	Accept					Accept
M10.3	Proforma questions skipped	1	4	25	Accept					Accept
M10.4	Language barrier	2	4	50	→R2	2	5	40	Accept	Accept
M10.5	Use of excessive technical language	1	4	25	Accept					Accept
M10.6	IT system logged to wrong patient	2	4	50	→R2	4	5	80	ACTION	ACTION
										<i>cntd. next page</i>

Information Exchange		Analysis								
<i>cntd. from previous page</i>										
M10.7	Incorrect replies entered (data entry after clerking instead of contemporaneous)	3	4	75	ACTION					ACTION
<hr/>										
M11										
From:	FY									
To:	Theatre Anaes.									
Message:	FY Clerking									
Modality:	online									
Failure Mode		Round 1				Round 2				Recommendation
		n	total	%	Analysis #1	n	total	%	Analysis #2	
M11.1	Wrong patient	2	4	50	→R2	3	5	60	ACTION	ACTION
M11.2	Hard copy lost	0	4	0	Accept					Accept
M11.3	Proforma not read	2	4	50	→R2	2	5	40	Accept	Accept
M11.4	Important findings overlooked	4	4	100	ACTION					ACTION
<hr/>										
M12										
From:	FY									
To:	Theatre Anaes.									
Message:	FY Clerking									
<i>cntd. next page</i>										

Information Exchange		Analysis								
<i>cntd. from previous page</i>										
Modality: online										
Failure Mode		Round 1				Round 2				Recommendation
		n	total	%	Analysis #1	n	total	%	Analysis #2	
M12.1	Th. anaes does not re-view clerking	4	4	100	ACTION					ACTION
<hr/>										
M13										
From: Nurse										
To: FY										
Message: Pt. File										
Modality: physical										
Failure Mode		Round 1				Round 2				Recommendation
		n	total	%	Analysis #1	n	total	%	Analysis #2	
M13.1	Wrong file	1	4	25	Accept					Accept
<hr/>										
M14										
From: Nurse										
To: FY										
Message: Nurse Clerking										
Modality: online										
Failure Mode		Round 1				Round 2				Recommendation
		n	total	%	Analysis #1	n	total	%	Analysis #2	

cntd. next page

Information Exchange		Analysis								
<i>cntd. from previous page</i>										
M14.1	Wrong patient	1	4	25	Accept					Accept
M14.2	Hard copy lost	0	4	0	Accept					Accept
M14.3	Proforma not read	1	4	25	Accept					Accept
M14.4	Important findings overlooked	3	4	75	ACTION					ACTION
<hr/>										
M15										
From: Nurse										
To: Patient										
Message: Clerking questions										
Modality: Face-to-face/proforma										
Failure Mode		Round 1				Round 2				Recommendation
		n	total	%	Analysis #1	n	total	%	Analysis #2	
M15.1	IT system logged to wrong patient	2	4	50	→R2	3	5	60	ACTION	ACTION
M15.2	Patient misunderstands question	2	4	50	→R2	3	5	60	ACTION	ACTION
M15.3	Nurse misunderstands answer	2	4	50	→R2	3	5	60	ACTION	ACTION
<hr/>										
M16										
From: Nurse										
										<i>cntd. next page</i>

Information Exchange		Analysis								
<i>cntd. from previous page</i>										
To: Patient										
Message: Info. re. Admission										
Modality: Face-to-face										
Failure Mode		Round 1				Round 2				Recommendation
		n	total	%	Analysis #1	n	total	%	Analysis #2	
M16.1	Incorrect/outdated information	2	4	50	→R2	3	5	60	ACTION	ACTION
M16.2	patient forgets	3	4	75	ACTION					ACTION
<hr/>										
M17										
From: Nurse										
To: Patient										
Message: Info. re. Admission										
Modality: leaflet										
Failure Mode		Round 1				Round 2				Recommendation
		n	total	%	Analysis #1	n	total	%	Analysis #2	
M17.1	Outdated information	0	5	0	Accept					Accept
M17.2	information misunderstood	2	5	40	→R2	1	5	20	Accept	Accept
M17.3	leaflet lost	0	5	0	Accept					Accept
<hr/>										
M18										
										<i>cntd. next page</i>

Information Exchange		Analysis								
<i>cntd. from previous page</i>										
From: Nurse										
To: Theatre Anaes.										
Message: Nurse Clerking										
Modality: online										
Failure Mode		Round 1				Round 2				Recommendation
		n	total	%	Analysis #1	n	total	%	Analysis #2	
M18.1	wrong patient	0	5	0	Accept					Accept
M18.2	Proforma not read	1	5	20	Accept					Accept
M18.3	Important findings overlooked	3	5	60	→R2	3	5	60	ACTION	ACTION
M18.4	Findings unclear or incomplete	3	5	60	→R2	4	5	80	ACTION	ACTION
<hr/>										
M19										
From: Patient										
To: FY										
Message: Clerking response										
Modality: Face-to-face										
Failure Mode		Round 1				Round 2				Recommendation
		n	total	%	Analysis #1	n	total	%	Analysis #2	
M19.1	wrong patient	1	5	20	Accept					Accept
M19.2	IT system logged to wrong patient	1	5	20	Accept					Accept
<hr/>										
<i>cntd. next page</i>										

Information Exchange				Analysis							
<i>cntd. from previous page</i>											
M19.3	Patient misunderstands question	3	5	60	→R2	5	5	100	ACTION	ACTION	
M19.4	Language barrier	1	5	20	Accept					Accept	
M19.5	technical language	1	5	20	Accept					Accept	
M19.6	wrong questions asked	3	5	60	→R2	4	5	80	ACTION	ACTION	
M19.7	Focus on only one comorbidity, missing others	4	5	80	ACTION					ACTION	
M19.8	Missed signs/symptoms	5	5	100	ACTION					ACTION	

M20											
From:		Patient									
To:		Nurse									
Message:		Clerking response									
Modality:		Face-to-face									
Failure Mode		Round 1				Round 2				Recommendation	
		n	total	%	Analysis #1	n	total	%	Analysis #2		
M20.1	wrong patient	1	5	20	Accept					Accept	
M20.2	IT system logged to wrong patient	1	5	20	Accept					Accept	
M20.3	Patient misunderstands question	2	5	40	→R2	3	5	60	ACTION	ACTION	

cntd. next page

Information Exchange				Analysis						
<i>cntd. from previous page</i>										
M20.4	Language barrier	1	5	20	Accept					Accept
M20.5	technical language	2	5	40	→R2	3	5	60	ACTION	ACTION
M20.6	wrong questions asked	3	5	60	→R2	3	5	60	ACTION	ACTION
M20.7	Focus on only one comorbidity, missing others	2	5	40	→R2	3	4	75	ACTION	ACTION
M20.8	Missed signs/symptoms	3	5	60	→R2	4	5	80	ACTION	ACTION
M21										
From:	Records									
To:	Clerk									
Message:	Pt. File									
Modality:	physical									
Failure Mode		Round 1				Round 2				Recommendation
		n	total	%	Analysis #1	n	total	%	Analysis #2	
M21	File not located	1	5	20	Accept					Accept
Conditional										
C1										
From:	FY									
										<i>cntd. next page</i>

Information Exchange				Analysis							
<i>cntd. from previous page</i>											
To: Firm											
Message: Case Summary											
Modality: phone/face-to-face											
Failure Mode	Round 1				Round 2				Recommendation		
	n	total	%	Analysis #1	n	total	%	Analysis #2			
C1.1	Communication initiated	not	1	4	25	Accept				Accept	
C1.2	Forget if not contemporaneous		2	4	50	→R2	3	5	60	ACTION	ACTION
C1.3	cannot find member of Firm	senior	1	4	25	Accept				Accept	
C1.4	Wrong information given		3	4	75	ACTION				ACTION	
C1.5	wrong patient discussed	dis-	2	4	50	→R2	3	5	60	ACTION	ACTION
<hr/>											
C2											
From: FY											
To: Other Specialist											
Message: Case Summary											
Modality: phone/hard copy											
Failure Mode	Round 1				Round 2				Recommendation		
	n	total	%	Analysis #1	n	total	%	Analysis #2			
<i>cntd. next page</i>											

Information Exchange				Analysis								
<i>cntd. from previous page</i>												
				<u>n</u>	<u>total</u>	<u>%</u>	<u>Analysis #1</u>	<u>n</u>	<u>total</u>	<u>%</u>	<u>Analysis #2</u>	
C2.1	Communication	not initiated		4	5	80	ACTION					ACTION
C2.2	Forget if not	contem- poraneous		3	5	60	→R2	5	5	100	ACTION	ACTION
C2.3	cannot find	specialist		3	5	60	→R2	4	5	80	ACTION	ACTION
C2.4	Wrong	information		5	5	100	ACTION					ACTION
	given											
C2.5	wrong	patient dis- cussed		4	5	80	ACTION					ACTION
<hr/>												
C3												
From: FY												
To: POAC Anaes												
Message: FY Clerking												
Modality: online												
Failure Mode												
				<u>Round 1</u>				<u>Round 2</u>				<u>Recommendation</u>
				<u>n</u>	<u>total</u>	<u>%</u>	<u>Analysis #1</u>	<u>n</u>	<u>total</u>	<u>%</u>	<u>Analysis #2</u>	
C3.1	No	review unless		4	5	80	ACTION					ACTION
		specifically	requested									
<hr/>												
C4												
											<i>cntd. next page</i>	

Information Exchange			Analysis								
<i>cntd. from previous page</i>											
From: FY											
To: POAC Anaes											
Message: Special Alerts/queries											
Modality: Face-to-face											
Failure Mode			Round 1				Round 2				Recommendation
			n	total	%	Analysis #1	n	total	%	Analysis #2	
C4.1	Communication	not initiated	5	5	100	ACTION					ACTION
C4.2	Wrong information given		2	5	40	→R2	2	5	40	Accept	Accept
C4.3	Information incomplete		2	5	40	→R2	2	4	50	ACTION	ACTION
C4.4	not all issues discussed		2	5	40	→R2	2	5	40	Accept	Accept
<hr/>											
C5											
From: FY											
To: Theatre Anaes.											
Message: Case Summary											
Modality: Phone/email											
Failure Mode			Round 1				Round 2				Recommendation
			n	total	%	Analysis #1	n	total	%	Analysis #2	
C5.1	Communication	not initiated	4	5	80	ACTION					ACTION
<hr/>											
<i>cntd. next page</i>											

Information Exchange			Analysis									
<i>cntd. from previous page</i>												
C5.2	Forget if not contemporaneous		3	4	75	ACTION						ACTION
C5.3	cannot locate/identify theatre anaesthetist		5	5	100	ACTION						ACTION
C5.4	Wrong information given		4	5	80	ACTION						ACTION
C5.5	wrong patient discussed		3	5	60	→R2	4	5	80	ACTION		ACTION
C5.6	Forgets to review results after POAC		4	5	80	ACTION						ACTION
<hr/>												
C6												
From:		Nurse										
To:		FY										
Message:		Special Alerts										
Modality:		Face-to-face										
Failure Mode		Round 1				Round 2				Recommendation		
		n	total	%	Analysis #1	n	total	%	Analysis #2			
C6.1	Communication not initiated	0	5	0	Accept					Accept		
C6.2	Incomplete information given	0	5	0	Accept					Accept		
												<i>cntd. next page</i>

Information Exchange			Analysis								
<i>cntd. from previous page</i>											
C6.3	Information misunderstood	misun-	0	5	0	Accept	Accept				
C7											
From:	Other Specialist										
To:	FY										
Message:	Recommendations										
Modality:	Phone										
Failure Mode			Round 1		Round 2		Recommendation				
			n	total	%	Analysis #1	n	total	%	Analysis #2	
C7.1	FY forgets to follow up consultation/investigations		5	5	100	ACTION					ACTION
C7.2	Patient does not attend specialist consult		4	5	80	ACTION					ACTION
C7.3	Failure to hand over when housemen change		5	5	100	ACTION					ACTION
C8											
From:	Patient										
To:	POAC Anaes										

cntd. next page

Information Exchange		Analysis								
<i>cntd. from previous page</i>										
Message: Clerking response										
Modality: Face-to-face										
Failure Mode	Round 1				Round 2				Recommendation	
	n	total	%	Analysis #1	n	total	%	Analysis #2		
C8.1	Consult not triggered by FY	4	5	80	ACTION					ACTION
C8.2	wrong patient	2	5	40	→R2	3	5	60	ACTION	ACTION
C8.3	IT system logged to wrong patient	2	5	40	→R2	3	5	60	ACTION	ACTION
C8.4	Patient misunderstands question	3	5	60	→R2	2	5	40	Accept	Accept
C8.5	Language barrier	1	5	20	Accept					Accept
C8.6	technical language	1	5	20	Accept					Accept
C8.7	wrong questions asked	1	5	20	Accept					Accept
C8.8	Focus on only one comorbidity, missing others	4	5	80	ACTION					ACTION
C8.9	Missed signs/symptoms	4	5	80	ACTION					ACTION
<hr/>										
C9										
From: POAC Anaes										
<i>cntd. next page</i>										

Information Exchange		Analysis								
<i>cntd. from previous page</i>										
To: FY										
Message: Recommendations										
Modality: Face-to-face										
Failure Mode		Round 1				Round 2				Recommendation
		n	total	%	Analysis #1	n	total	%	Analysis #2	
C9.1	Recommendations misunderstood by FY	5	5	100	ACTION					ACTION
C9.2	Recorded incorrectly on IT system	1	5	20	Accept					Accept
<hr/>										
C10										
From: POAC Anaes										
To: Patient										
Message: Clerking questions										
Modality: Face-to-face										
Failure Mode		Round 1				Round 2				Recommendation
		n	total	%	Analysis #1	n	total	%	Analysis #2	
C10.1	Wrong patient	2	5	40	→R2	1	5	20	Accept	Accept
C10.2	IT System crashes	0	4	0	Accept					Accept
C10.3	Language barrier	1	5	20	Accept					Accept
C10.4	Use of excessive technical language	1	5	20	Accept					Accept
										<i>cntd. next page</i>

Information Exchange				Analysis							
<i>cntd. from previous page</i>											
C10.5	IT system logged to wrong patient	2	4	50	→R2	3	5	60	ACTION	ACTION	
C10.6	Incorrect replies entered (data entry after clerking instead of contemporaneous)	3	4	75	ACTION					ACTION	
<hr/>											
C11											
From: POAC Anaes											
To: Theatre Anaes.											
Message: Case Summary											
Modality: Phone/email/face to face											
Failure Mode		Round 1				Round 2				Recommendation	
		n	total	%	Analysis #1	n	total	%	Analysis #2		
C11.1	Communication not initiated	4	5	80	ACTION					ACTION	
C11.2	Forget if not contemporaneous	5	5	100	ACTION					ACTION	
C11.3	cannot locate/identify theatre anaesthetist	3	5	60	→R2	3	5	60	ACTION	ACTION	
										<i>cntd. next page</i>	

Information Exchange				Analysis							
<i>cntd. from previous page</i>											
C11.4	Wrong information given	5	5	100	ACTION		ACTION				
C11.5	wrong patient discussed	4	5	80	ACTION		ACTION				
C12											
From:	Theatre Anaes										
To:	FY										
Message:	Recommendations										
Modality:	Phone/email										
Failure Mode			Round 1		Round 2		Recommendation				
			n	total	%	Analysis #1	n	total	%	Analysis #2	
C12.1	Incomplete information given	5	5	100	ACTION						ACTION
C12.2	Information misunderstood	5	5	100	ACTION						ACTION
C13											
From:	Theatre Anaes										
To:	POAC Anaes										
Message:	Recommendations										
Modality:	Phone/email										
											<i>cntd. next page</i>

Chapter 6

Patient Experience of a Preoperative Assessment Clinic

6.1 Introduction

It is clearly desirable that patients should be satisfied with their experience of a medical facility. While there is no universally recognised definition of patient satisfaction, it is suggested that this is dependent on the patient's cognitive evaluation and emotional response to the care received [219]. Congruence between the patient's expectations and perception of care received improve satisfaction [220, 221].

Patient satisfaction is recognised as an important indicator of quality of care [222–225], particularly in relation to patient-centred healthcare [226]. Although patients may be unable to accurately assess the technical quality of the care they receive, they are able to report on, and make a judgement of, many aspects of the care process. For this reason, measures of patient satisfaction have been advocated to assess quality of anaesthesia care [221, 227, 228].

6.2 Aims

The aims of this study were to investigate the patient experience of the POAC and to identify those elements contributing to satisfaction and any deficiencies detracting from it.

6.3 Assessing Patient Satisfaction

As the medical profession has become concerned with patient satisfaction, interest has grown in the specific area of satisfaction with various aspects of anaesthetic care. It was desired to determine if the attendees at the POAC were satisfied with the service. To this end, a tool to investigate

patient satisfaction was developed, and used to obtain feedback from clinic attendees. The study protocol was reviewed and approved by the institution ethics committee.

6.3.1 Literature Search

In order to guide development of the study questionnaire, a search of the Pubmed database was carried out using the search terms:

```
((satisfaction, patient[MeSH Terms])  
OR ‘patient experience’)  
AND (outpatient OR clinic)  
AND preop*  
AND (Anesthe* OR Anaesthe*).
```

Titles and abstracts were reviewed and articles which dealt primarily with the evaluation of patient satisfaction with outpatient preoperative assessment services, or which included such an assessment as part of a wider study of satisfaction with anaesthesia services were retrieved for review. Reference lists were examined for further articles of interest. The review was limited to English-language articles and which dealt with adult patients.

6.3.2 Tools to Assess Patient Satisfaction

Tools assessing patient satisfaction with a service fall into two broad categories: rating-type tools and report-type tools. Rating-type tools assess quality of care by soliciting a rating of various aspects of the service on an ordinal scale. These tools tend to return very high satisfaction scores with a very skewed distribution [221, 227–230] and so are insensitive to the effects of service improvement initiatives. Furthermore, they do not reveal the underlying factors contributing to patient satisfaction and so cannot guide process change.

In report-type tools, it is assumed that patient satisfaction is determined by the experience of care. In these tools, respondents report on various items of care they received. Approaches to the construction of psychometrically robust tools for this purpose have been described [221, 227, 231–233]. The steps involved in their construction are summarised in Table 6.1.

Table 6.1: Development of a Psychometric Questionnaire.

<i>Generating Items</i>	Drawn from patients and clinical staff through interviews, focus groups, literature review
<i>Generating domains</i>	Conceptual themes identified during item generation
<i>Pilot Questionnaire</i>	To determine comprehensibility, skew and variability. Eliminate poorly performing items
<i>Pilot testing</i>	Use pilot questionnaire in larger sample
<i>Revise pilot questionnaire</i>	After statistical analysis, eliminate poorly performing items (missing responses, poor skew, poor variability. Optimise reliability and construct validity
<i>Retest final questionnaire</i>	Confirm that questionnaire continues to exhibit desirable psychometric characteristics.

6.3.3 Determinants of Patient Satisfaction

The selection of items for inclusion in a patient satisfaction tool should ideally be generated from the typical patient population of interest. One approach being to use qualitative studies of patients' values and expectations, and then validate these through a pilot study and analysis of the performance of the questionnaire in a patient population [227,233].

Fung *et al.* [234] used this approach to develop a tool assessing patient satisfaction with various aspects of anaesthetic care. Using information from an earlier interview study of patients, they developed a questionnaire of items of anaesthesia care likely to be valued by patients. A mail-in questionnaire was sent to 45 patients following surgery and looked at all aspects of pre, intra and postoperative care. Patients were then asked to evaluate the importance of a variety of elements. It was found that in the preoperative phase, the elements that patients valued most were adequate information and effective communication. Interpersonal interaction with clinicians was considered somewhat less important while elements related to organisation and physical aspects of the clinic were rated least important. As the questionnaire was administered about one month after surgery, assessment of the preoperative phase may have suffered from memory bias and influence by the intra and postoperative experiences.

Hepner *et al.* [235] developed a questionnaire intended specifically for assessing a preoperative clinic. It was based on questionnaires developed within their institution to assess various outpatient services. The question base was similar to that developed by the Picker Institute [236–239] to assess outpatient services. Respondents rated satisfaction with each item on a five-point scale. Collecting data from 857 patients, they demonstrated a

significant correlation between information given and overall satisfaction. Furthermore, satisfaction with clinical staff (doctors, nurses, anaesthetists) was higher than with non-clinical aspects such as interaction with receptionists and physical aspects of the clinic. Unlike the Picker questionnaire, which uses report-style responses, items in the Hepner tool were rated of a five-point verbal rating scale of increasing satisfaction.

Edward *et al.* [240] explicitly adapted the established Outpatient Satisfaction tool, developed by the Picker Institute Europe [241] and used by NHS(UK), to construct their Patient Experience with Preoperative Assessment Clinic (PEPAC) questionnaire. This questionnaire was adapted for the specific setup of their preoperative assessment clinic and was translated into Dutch for use in their institution. In particular, five domains were investigated, namely “reception”, “waiting time”, “the nurse”, “the anaesthetist” and “other”. Specific items included giving of information, interpersonal interaction and waiting times. In contrast to the Hepner tool, they maintained the Picker style of report answers, rather than Likert scales. They did, however, introduce an overall satisfaction scale to allow construct validation. Content validity was assessed by expert opinion and interview with a small cohort of patients. Analysis of the questionnaires returned by 519 patients allowed them to demonstrate internal consistency and construct validity. In a further analysis of their data [242], the authors identified those items of service which were of most importance to patients by calculating regression coefficients for overall satisfaction scores. The “other” experiences appeared to contribute most to overall satisfaction. Surprisingly, although respondents rated waiting as the worst component of their experience, this had little impact on overall satisfaction.

Fraczyk and Godfrey [243] developed their own patient satisfaction questionnaire to investigate the performance of various routes of preoperative assessment available at their institution. They queried respondents on satisfaction with various aspects of the clinic using Likert-type responses. Unusually, they also included open-ended questions, and subjected the textual responses to thematic analysis. They collected 275 responses from 703 questionnaires, which were completed and returned up to one week after surgery. Topics which emerged from the thematic analysis included the desirability of being given information, both on the medical aspects of the procedure and aftercare, and also on the logistical aspects of their hospital stay. A supportive attitude from staff was also valued, with patients appreciating staff support to allay feelings of anxiety and fear.

In an initiative to improve clinic performance, Harnett *et al.* [244] investigated the effect of limiting the number of clinicians the patient interacts with (nurse practitioner only or Nurse/nurse practitioner, physician and anaesthetist). They collected information from 872 of 1100 patients in a before-and-after study, using an adaptation of the Hepner [235] questionnaire to assess satisfaction. They reported that interacting with fewer members of staff improved satisfaction; at least partially by decreasing waiting times.

Gupta and Gupta [245] presented data from a small study of patient satisfaction with the preoperative clinic in their hospital. They reported a number of issues related to various structural and logistical elements of the clinic, but they did not attempt domain analysis of their results, or try to establish which specific elements of care contributed to overall satisfaction.

In an editorial entitled “What Patients Want” Bensing *et al.* [246], commenting on studies of patient expectations in a wide range of clinical scenarios, note the emphasis placed on “information giving” and “fostering the relationship”. However they remark that the former is often the dominant theme in quantitative studies, while the latter gains prominence in qualitative investigations. The specific nature of the outpatient services analysed, however, may have biased these findings. For example, patients in Oncology clinics may show a greater need for developing a supportive relationship with the clinical staff. On the other hand, in a review of qualitative studies of patients’ experiences with preoperative communication [247], “getting information” and “attitudes of healthcare professionals” were recurrent themes [248,249]. The value of giving information was further demonstrated in a study of 200 patients undergoing arthroplasty [250]. Those given an anaesthesia information leaflet reported greater satisfaction. Similarly, giving verbal information regarding anaesthesia at a preoperative clinic was associated with higher patient satisfaction [251].

In summary, investigations indicate that the main drivers of patient satisfaction at preoperative clinics include adequate communication, receiving information, and having satisfactory interpersonal interaction with staff, particularly clinical personnel and the receptionists. Extended waiting times, while a common cause of complaint, together with other organisational, structural and physical aspects of the clinic appear to have a lesser negative impact.

6.3.4 Construction of Questionnaire

The questionnaire developed for this survey was based on the questionnaire designed by Hepner [235] and the PEPAC described by Edward [240] reviewed above (Section 6.3.3). The latter is itself based on the Picker Institute Europe Outpatients Satisfaction Question Bank [241]. The main modifications were adapting the questionnaire to reflect the normal patient pathway through the local POAC as detailed in Chapter 5. In order to keep the questionnaire to a reasonable length, questions relating to non-clinical factors were omitted (e.g. ease of finding the clinic, cleanliness, etc.). Also, aspects of patient interaction with some ancillary staff were condensed to a single question. Most of the questionnaire items were structured on the reporting model used in the NHS Outpatients Survey [241] and the PEPAC questionnaire [240] reporting model. Five-point Likert-scale assessments of overall satisfaction of each section of the POAC process, and overall satisfaction were included to allow criterion validation [240].

As a significant proportion of the patients in the target population were

not fluent in English, a Maltese-language version of the questionnaire was developed. The English-language version was translated into Maltese by the author. The translation was reviewed by two independent assessors, who were fluent in both languages. One of the assessors was an anaesthetist involved in the POAC operations. The other assessor had no formal medical background. After assessment of the translation, this was compared to the English original. A small number of disagreements over the accuracy of translation were discussed and resolved by consensus.

The questionnaires were typeset using the \LaTeX typesetting package with the SDAPS package extension [167] to allow electronic data capture. The questionnaires are reproduced in Appendices B.1 and B.2.

6.4 Method

In order to investigate the functioning of the local POAC from the patients' perspective, a survey was organised amongst attendees of the clinic. All patients attending the preoperative clinic were invited to fill in a questionnaire by reception staff and return the filled form by depositing it in a box kept for this purpose at the reception desk before they left the clinic. Patients were free to choose their preferred language (English or Maltese). No personal identifying information was collected. Questionnaires collected between October, 2016 and June, 2017 were analysed. The forms were scanned and processed with the SDAPS optical mark reader software [167]. The scanned images were examined visually to verify scan quality and to manually correct ambiguous markings. The data collected was imported into the R statistical software package (version 3.1.2) [168] for analysis.

The equivalence of the English and Maltese questionnaires was assessed by comparing the scores of equivalent questions using the Mann-Whitney U-test. Item response rates were calculated as percentages. The reliability of the item set underlying each major domain was assessed using Cronbach's α . The contribution of individual items and domains to overall satisfaction was assessed by Pearson's correlation coefficient. Scores for individual questionnaire items were summarised using means and standard deviation. Clinical staff performance scores were compared using Kruskal-Wallis Analysis of Variance (ANOVA). The sources and type of information given to patients was summarised as counts and percentages. The Likert scores for overall satisfaction were displayed as frequency tables.

Freeform text comments were transcribed and subjected to thematic analysis based on the major domains of the questionnaire.

6.5 Results and Analysis

In all, 873 questionnaires with usable data were returned. Of these 754 were Maltese versions and 119 were English versions of the questionnaire. In the relevant timeframe, clinic attendance was estimated at 10,000 cases,

giving an average response rate of approximately 9%. Figure 6.1 shows the proportion of questionnaires returned every week. There was a marked drop in response rates over the duration of the study, overlaid by some fluctuation which may be due to efforts made at intervals to promote questionnaire returns.

Figure 6.1: Questionnaire Returns

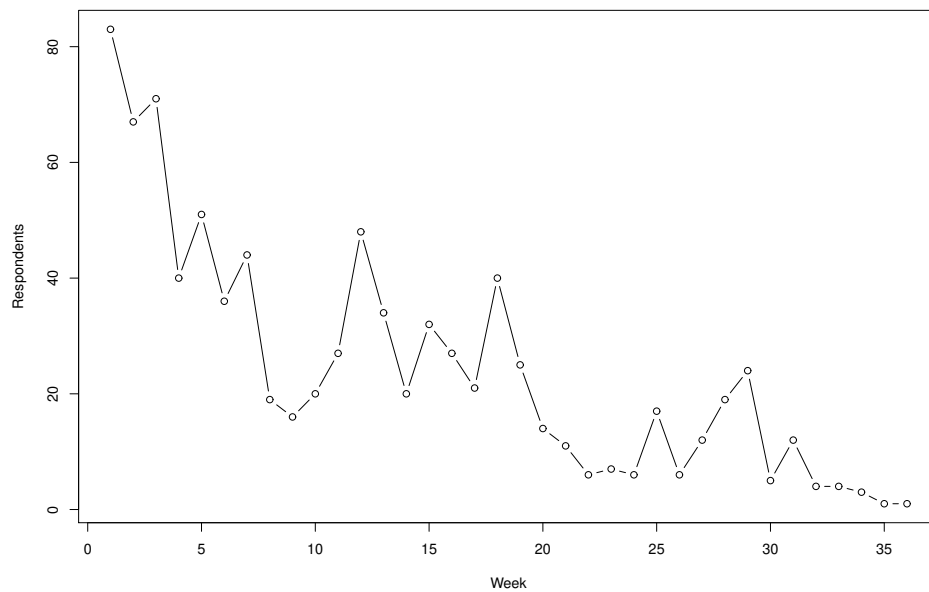

6.5.1 Equivalence of Maltese and English Questionnaires

In order to confirm the equivalence of the Maltese and English versions of the questionnaire, the scores for each question from the two language options were compared using the Mann-Whitney U-test. As this involves multiple tests of significance, the Bonferroni correction was applied to determine the appropriate individual significance threshold. For an overall threshold of 0.05 and 39 items, the Bonferroni threshold for individual items is 0.00128. The p-values for each question are shown in Table 6.2. No question p-value is below the threshold and the large majority had a p-value greater than 0.05. The two questionnaires may be considered equivalent. For further analysis, the data from the two language questionnaires were combined.

Table 6.2: Maltese/English Questionnaire Equivalence

	P
<i>Please rate the service you got at Reception:</i>	0.02
<i>How long did you have to wait to see the nurse?</i>	0.63
<i>Did the nurse seem to know about your medical history?</i>	0.56
<i>Were you able to discuss the things you wanted to with the nurse?</i>	0.14
<i>Did the nurse listen to what you had to say?</i>	0.88
<i>If you asked the nurse questions, did you get answers you could understand?</i>	0.41
<i>Did you have confidence and trust in the nurse?</i>	0.28
<i>Please rate your visit with the nurse:</i>	0.59
<i>How long did you have to wait for your ECG?</i>	0.56
<i>Please rate the service you got at the ECG Room:</i>	0.49
<i>How long did you have to wait to see the doctor?</i>	0.76
<i>Did the doctor seem to know about your medical history?</i>	0.30
<i>Were you able to discuss the things you wanted to with the doctor?</i>	0.49
<i>Did the doctor listen to what you had to say?</i>	0.80
<i>If you had asked the doctor questions, did you get answers you could understand?</i>	0.31
<i>Did you have confidence and trust in the doctor?</i>	0.93
<i>Please rate your visit with the doctor:</i>	0.20
<i>Did you see the anaesthetist?</i>	0.31
<i>How long did you have to wait to see the anaesthetist?</i>	0.57
<i>Did the anaesthetist seem to know about your medical history?</i>	0.43
<i>Were you able to discuss the things you wanted to with the anaesthetist?</i>	0.12
<i>Did the anaesthetist listen to what you had to say?</i>	0.16
<i>If you asked the anaesthetist questions, did you get answers you could understand?</i>	0.21
<i>Did you have confidence and trust in the anaesthetist?</i>	0.27
<i>Please rate your visit with the anaesthetist:</i>	0.91
<i>Before your appointment, did you know why you had to go to the POAC?</i>	0.23
<i>Before your appointment, did you know what would happen during your visit to the POAC?</i>	0.34
<i>What anaesthesia involves</i>	0.07
<i>What your options for anaesthesia are</i>	0.51
<i>What to bring with you to for the operation</i>	0.59
<i>What happens when you arrive in the operating room</i>	0.35
<i>What the possible side-effects of anaesthesia are</i>	0.85
<i>How the pain will be controlled after the operation</i>	0.94

Continued on next page

Table 6.2

<i>Continued from previous page</i>	
	p
<i>Which medicines you should take prior to surgery</i>	0.01
<i>Which medicines you should discontinue prior to surgery</i>	0.04
<i>When you can last eat and drink prior to surgery</i>	0.39
<i>How would you rate the organization of the POAC?</i>	0.61
<i>Do you feel you were treated with respect and dignity while at the POAC?</i>	0.57
<i>Overall, how would you rate the care you received at the POAC?</i>	0.43

6.5.2 Item Response Rates

Table 6.3 shows the proportion of the single-response report-style questions (excluding anaesthetist-related items) given a valid response. The response rates range between 81.2 to 97.0%, with the exception of the response to the question “*Did you see the anaesthetist*” (55.4%). Some patients who did not have an anaesthetic review may have completely omitted the whole section, including this item, explaining the low response. Response rates for items related to the anaesthetist are given in Table 6.4.

Figure 6.2 (pg. 166) shows the number of responses plotted against the sequence location of the question within the questionnaire. Questions related to the ECG technicians and anaesthesia consultation are excluded, as not all participants were required to use these services. There is a decrease in response rate with progression through the questionnaire, as highlighted by the linear regression line.

The questionnaire had one section of questions, related to sources of information given to the patient, which could be given multiple responses. The completion rates for this bank of questions is given in Table 6.5. The completion rates for this set of questions was considerably less than for the single-response style, ranging between 55.9—70.1%.

Completion rates for Likert response questions are shown in Table 6.6. These range between 61.7—86.8%.

Figure 6.2: Questionnaire Fatigue

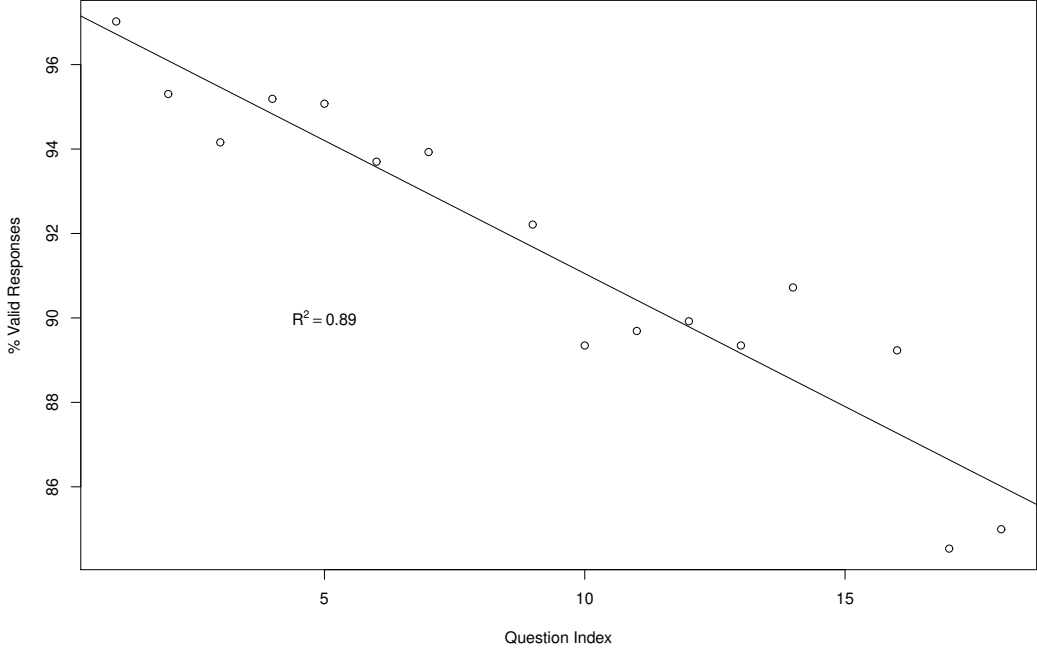

Table 6.3: Single Response Questions Completion Rate (Excluding Anaesthetist-related Items)

	n	%
<i>What was the scheduled time of your appointment?</i>	847	97.02
<i>How long did you have to wait to see the nurse?</i>	832	95.30
<i>Did the nurse seem to know about your medical history?</i>	822	94.16
<i>Were you able to discuss the things you wanted to with the nurse?</i>	831	95.19
<i>Did the nurse listen to what you had to say?</i>	830	95.07
<i>If you asked the nurse questions, did you get answers you could understand?</i>	818	93.70
<i>Did you have confidence and trust in the nurse?</i>	820	93.93
<i>How long did you have to wait for your ECG?</i>	709	81.21
<i>How long did you have to wait to see the doctor?</i>	805	92.21
<i>Did the doctor seem to know about your medical history?</i>	780	89.35
<i>Were you able to discuss the things you wanted to with the doctor?</i>	783	89.69
<i>Did the doctor listen to what you had to say?</i>	785	89.92
<i>If you had asked the doctor questions, did you get answers you could understand?</i>	780	89.35
<i>Did you have confidence and trust in the doctor?</i>	792	90.72
<i>Did you see the anaesthetist?</i>	484	55.44
<i>Before your appointment, did you know why you had to go to the POAC?</i>	779	89.23
<i>Before your appointment, did you know what would happen during your visit to the POAC?</i>	738	84.54
<i>Do you feel you were treated with respect and dignity while at the POAC?</i>	742	84.99

Table 6.4: Anaesthetist-Related Single Response Questions Completion Rate

	n	%[†]
<i>Did you see the anaesthetist?</i>	81	100.00
<i>How long did you have to wait to see the anaesthetist?</i>	74	91.36
<i>Did the anaesthetist seem to know about your medical history?</i>	73	90.12
<i>Were you able to discuss the things you wanted to with the anaesthetist?</i>	71	87.65
<i>Did the anaesthetist listen to what you had to say?</i>	71	87.65
<i>If you asked the anaesthetist questions, did you get answers you could understand?</i>	72	88.89
<i>Did you have confidence and trust in the anaesthetist?</i>	68	83.95

[†] As % of patients reviewed by anaesthetist

Table 6.5: Multiple Response Questions Completion Rate

	n	%
<i>What anaesthesia involves</i>	617	70.3
<i>What your options for anaesthesia are</i>	508	57.8
<i>What to bring with you to for the operation</i>	573	65.3
<i>What happens when you arrive in the operating room</i>	526	59.6
<i>What the possible side-effects of anaesthesia are</i>	527	60.3
<i>How the pain will be controlled after the operation</i>	533	60.8
<i>Which medicines you should take prior to surgery</i>	528	60.2
<i>Which medicines you should discontinue prior to surgery</i>	491	56.1
<i>When you can last eat and drink prior to surgery</i>	584	66.6

Table 6.6: Likert Scales Completion Rates

	Count	Percent
<i>Please rate the service you got at Reception:</i>	698	80.0
<i>Please rate your visit with the nurse:</i>	751	86.0
<i>Please rate the service you got at the ECG Room:</i>	644	73.8
<i>Please rate your visit with the doctor:</i>	678	77.7
<i>Please rate your visit with the anaesthetist:</i>	50	61.7
<i>How would you rate the organization of the POAC?</i>	758	86.8
<i>Overall, how would you rate the care you received at the POAC?</i>	749	85.8

6.5.3 Reliability and Validity

The tool developed for this survey was largely based on the Picker Institute (Europe) Outpatients Questionnaire Bank [241] as adapted by Edward *et al.* for a preoperative assessment clinic [240]. For the purposes of analysis, following the same methodology [240, 252], report-style questions were assigned a score between 0 and 100. The best response in a set was scored as 100 and the worst as 0. Any intermediate items were scored on divided intervals between the extrema. In the referenced studies, key domains for patient experience were proposed and found to have acceptable levels of reliability. The analogous major domains in the present tool are given in Table 6.7. The reliability of the item set used to generate each domain score was assessed by calculating Cronbach's α for each domain. As the domains for 'Reception' and 'ECG' are assessed by a single item, these do not have an α -value calculated.

Table 6.7: Reliability of Domain Scores

Domain	α
<i>Waiting</i>	0.570
<i>Reception</i>	-
<i>Nurse</i>	0.703
<i>ECG</i>	-
<i>Doctor</i>	0.709
<i>Anaesthetist</i>	0.695
<i>Information</i>	0.810
<i>General</i>	0.645

Candidate measures of overall satisfaction with the clinic performance were calculated in three ways:

Global: A direct five-point Likert-scale question “*Overall, how would you rate the care that you received at the POAC?*”.

Composite: The arithmetic mean of all the domain scores.

Mean: The arithmetic mean of the global and composite scores.

The Pearson correlation coefficients between the domain scores and the overall satisfaction scores were calculated and are shown in Table 6.8. The correlation coefficients for individual questionnaire items were calculated to identify specific issues which would impact satisfaction. These are given in Table 6.9.

Table 6.8: Domain Score Pearson Correlation Coefficients

	Global	Composite	Mean
<i>Waiting</i>	0.15	0.64	0.43
<i>Reception</i>	0.33	0.41	0.41
<i>Nurse</i>	0.25	0.42	0.41
<i>EKG</i>	0.30	0.43	0.42
<i>Doctor</i>	0.37	0.46	0.50
<i>Anaesthetist</i>	0.06	0.48	0.32
<i>Information</i>	0.13	0.63	0.42
<i>General</i>	0.83	0.50	0.80
<i>Global</i>	1.00	0.48	0.88
<i>Composite</i>	0.48	1.00	0.84
<i>Mean</i>	0.88	0.84	1.00

Table 6.9: Question Correlations with Overall Satisfaction Score

	Global	Composite	Mean
<i>Please rate the service you got at Reception:</i>	0.33	0.41	0.41
<i>How long did you have to wait to see the nurse?</i>	0.11	0.46	0.31
<i>Did the nurse seem to know about your medical history?</i>	0.15	0.29	0.28
<i>Were you able to discuss the things you wanted to with the nurse?</i>	0.15	0.21	0.22
<i>Did the nurse listen to what you had to say?</i>	0.10	0.27	0.22
<i>If you asked the nurse questions, did you get answers you could understand?</i>	0.15	0.30	0.26
<i>Did you have confidence and trust in the nurse?</i>	0.13	0.26	0.22
<i>Please rate your visit with the nurse:</i>	0.28	0.33	0.36
<i>How long did you have to wait for your ECG?</i>	0.06	0.42	0.26
<i>Please rate the service you got at the ECG Room:</i>	0.30	0.43	0.42
<i>How long did you have to wait to see the doctor?</i>	0.12	0.46	0.32
<i>Did the doctor seem to know about your medical history?</i>	0.23	0.37	0.35
<i>Were you able to discuss the things you wanted to with the doctor?</i>	0.21	0.24	0.27
<i>Did the doctor listen to what you had to say?</i>	0.24	0.19	0.26
<i>If you had asked the doctor questions, did you get answers you could understand?</i>	0.18	0.33	0.30
<i>Did you have confidence and trust in the doctor?</i>	0.22	0.24	0.28
<i>Please rate your visit with the doctor:</i>	0.51	0.39	0.53
<i>Did you see the anaesthetist?</i>	-0.02	0.26	0.14
<i>How long did you have to wait to see the anaesthetist?</i>	0.31	0.37	0.44

Continued on next page

Table 6.9

<i>Continued from previous page</i>	Global	Composite	Mean
<i>Did the anaesthetist seem to know about your medical history?</i>	0.09	0.35	0.26
<i>Were you able to discuss the things you wanted to with the anaesthetist?</i>	0.06	0.43	0.28
<i>Did the anaesthetist listen to what you had to say?</i>	-0.08	0.29	0.11
<i>If you asked the anaesthetist questions, did you get answers you could understand?</i>	-0.08	0.21	0.08
<i>Did you have confidence and trust in the anaesthetist?</i>	0.39	0.47	0.49
<i>Please rate your visit with the anaesthetist:</i>	0.61	0.52	0.65
<i>Before your appointment, did you know why you had to go to the POAC?</i>	0.05	0.22	0.13
<i>Before your appointment, did you know what would happen during your visit to the POAC?</i>	0.05	0.30	0.19
<i>What anaesthesia involves</i>	0.14	0.41	0.31
<i>What your options for anaesthesia are</i>	0.08	0.51	0.32
<i>What to bring with you to for the operation</i>	0.13	0.40	0.29
<i>What happens when you arrive in the operating room</i>	0.15	0.43	0.32
<i>What the possible side-effects of anaesthesia are</i>	0.08	0.43	0.27
<i>How the pain will be controlled after the operation</i>	0.06	0.39	0.24
<i>Which medicines you should take prior to surgery</i>	0.11	0.38	0.27
<i>Which medicines you should discontinue prior to surgery</i>	0.13	0.37	0.28
<i>When you can last eat and drink prior to surgery</i>	0.03	0.24	0.14
<i>How would you rate the organization of the POAC?</i>	0.68	0.52	0.70
<i>Do you feel you were treated with respect and dignity while at the POAC?</i>	0.26	0.22	0.27

6.5.4 Clinic Performance

The scores for each individual item in the questionnaire are given in Table 6.10, while the mean scores for each domain are reported in Table 6.11. The waiting experience had the worst score (54), followed by the assessment of the information given to the patient (79). All the other domains had scores of over 90.

Table 6.10: Item Scores

	n	mean	σ
<i>Please rate the service you got at Reception:</i>	698	97	9
<i>How long did you have to wait to see the nurse?</i>	828	57	30
<i>Did the nurse seem to know about your medical history?</i>	780	89	25
<i>Were you able to discuss the things you wanted to with the nurse?</i>	831	97	13
<i>Did the nurse listen to what you had to say?</i>	830	99	6
<i>If you asked the nurse questions, did you get answers you could understand?</i>	793	98	11
<i>Did you have confidence and trust in the nurse?</i>	820	98	12
<i>Please rate your visit with the nurse:</i>	751	98	10
<i>How long did you have to wait for your ECG?</i>	706	67	30
<i>Please rate the service you got at the ECG Room:</i>	644	97	12
<i>How long did you have to wait to see the doctor?</i>	786	41	36
<i>Did the doctor seem to know about your medical history?</i>	751	88	24
<i>Were you able to discuss the things you wanted to with the doctor?</i>	783	96	14
<i>Did the doctor listen to what you had to say?</i>	785	99	8
<i>If you had asked the doctor questions, did you get answers you could understand?</i>	771	96	14
<i>Did you have confidence and trust in the doctor?</i>	792	96	15
<i>Please rate your visit with the doctor:</i>	678	97	10
<i>Did you see the anaesthetist?</i>	97	84	37
<i>How long did you have to wait to see the anaesthetist?</i>	86	68	37
<i>Did the anaesthetist seem to know about your medical history?</i>	81	91	23
<i>Were you able to discuss the things you wanted to with the anaesthetist?</i>	86	90	27
<i>Did the anaesthetist listen to what you had to say?</i>	84	92	26
<i>If you asked the anaesthetist questions, did you get answers you could understand?</i>	79	94	20
<i>Did you have confidence and trust in the anaesthetist?</i>	86	97	13
<i>Please rate your visit with the anaesthetist:</i>	101	98	8
<i>Before your appointment, did you know why you had to go to the POAC?</i>	779	88	32
<i>Before your appointment, did you know what would happen during your visit to the POAC?</i>	738	59	49
<i>What anaesthesia involves</i>	598	83	38
<i>What your options for anaesthesia are</i>	454	54	50
<i>What to bring with you to for the operation</i>	555	86	35
<i>What happens when you arrive in the operating room</i>	497	75	43
<i>What the possible side-effects of anaesthesia are</i>	509	80	40
<i>How the pain will be controlled after the operation</i>	516	79	41

Continued on next page

Table 6.10

<i>Continued from previous page</i>			
	n	mean	σ
<i>Which medicines you should take prior to surgery</i>	511	83	38
<i>Which medicines you should discontinue prior to surgery</i>	470	83	38
<i>When you can last eat and drink prior to surgery</i>	573	95	22
<i>How would you rate the organization of the POAC?</i>	758	95	13
<i>Do you feel you were treated with respect and dignity while at the POAC?</i>	742	98	11
<i>Overall, how would you rate the care you received at the POAC?</i>	749	97	9

Table 6.11: Domain Scores

	n	mean	σ
<i>Waiting</i>	847	54	24
<i>Reception</i>	698	97	9
<i>Nurse</i>	852	96	8
<i>ECG</i>	644	97	12
<i>Doctor</i>	814	95	9
<i>Anaesthetist</i>	140	93	17
<i>Information</i>	795	79	26
<i>General</i>	777	97	9

6.5.5 Waiting Times

Waiting times for patients to see the nurse, have an ECG recorded, and to see the doctor and the anaesthetist are shown in Table 6.12 and Figure 6.3. Excluding the uncertain responses, χ^2 analysis comparing the waiting times for the various clinicians gives $p < 2.2 \times 10^{-16}$. This is highly significant. Waiting times were shortest for the Anaesthetist consultation, then the ECG technician, the nurse review, and longest for the Foundation doctor assessment.

The scores for waiting to see each member of staff are given in Table 6.13. A higher score corresponds to a shorter (more satisfactory) waiting time.

Table 6.12: Waiting Times

	Nurse		ECG		Doctor		Anaes.	
	n	%	n	%	n	%	n	%
<i>Immediately</i>	162	18.6	235	26.9	129	14.8	38	46.9
<i><5 minutes</i>	177	20.3	155	17.8	98	11.2	10	12.3
<i>5—15 minutes</i>	290	33.2	202	23.1	166	19	10	12.3
<i>16—30 minutes</i>	121	13.9	77	8.8	158	18.1	5	6.2
<i>>30 minutes</i>	78	8.9	37	4.2	235	26.9	9	11.1
<i>Don't Know</i>	4	0.5	3	0.3	19	2.2	2	2.5
<i>NA</i>	41	4.7	164	18.8	68	7.8	7	8.6

Table 6.13: Waiting Scores

	n	mean	σ
<i>Nurse</i>	828	56.76	30.08
<i>ECG</i>	706	66.78	29.80
<i>Doctor</i>	786	41.35	35.89
<i>Anaesthetist</i>	86	67.73	37.35

Figure 6.3: Patient Waiting Times

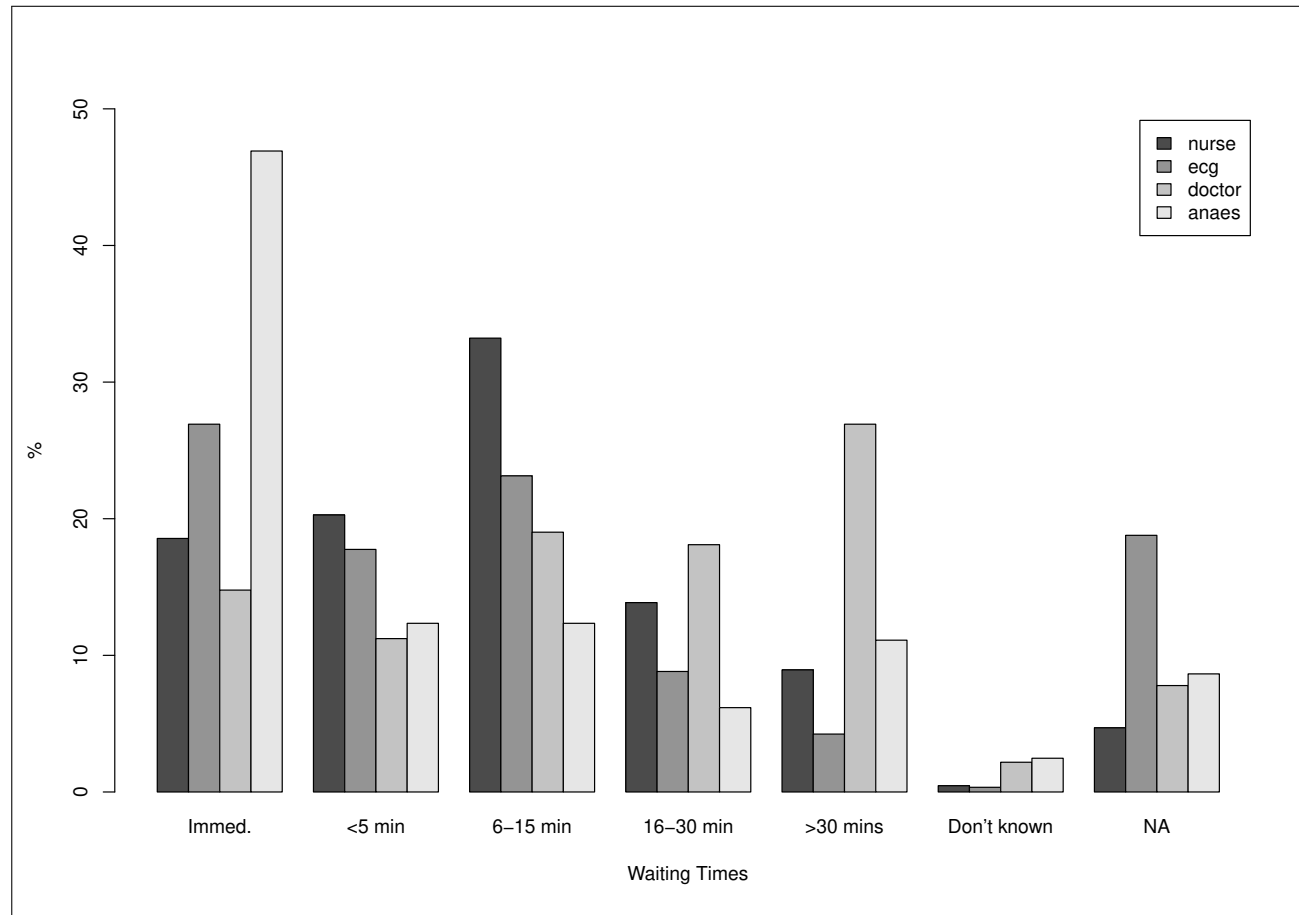

6.5.6 Performance of Clinical Staff

The clinical staff (nurses, doctors and anaesthetists) were assessed on these specific aspects of clinical care:

- Knowledge of patient history
- Allowing patient to discuss issues
- Listening to patients
- Ability to give understandable answers to questions
- Gaining patient confidence and trust
- Overall Rating (Likert Score)

The responses for each of these items are given in Table 6.14, except for the overall rating Likert scores, which are given in Table 6.19 (pg. 182). The scores for equivalent questions for the three clinical staff domains were compared by Kruskal-Wallis analysis of variance, as given in Table 6.15. The clinicians all score highly on the six assessment questions. The anaesthetists, however, perform somewhat worse as regards listening to, and discussing with, the patients.

Table 6.14: Staff Performance Scores

	Nurse		Doctor		Anaes	
	n	%	n	%	n	%
<i>Knowledge of Patient History</i>						
<i>Knew Enough</i>	631	72.3	589	67.5	55	67.9
<i>Not Enough</i>	122	14	142	16.3	11	13.6
<i>Little or Nothing</i>	27	3.1	20	2.3	2	2.5
<i>Don't Know</i>	42	4.8	29	3.3	5	6.2
<i>No Response</i>	51	5.8	93	10.7	8	9.9
<i>Discuss issues with patient</i>						
<i>Definitely</i>	785	89.9	731	83.7	62	76.5
<i>Some Extent</i>	41	4.7	48	5.5	5	6.2
<i>No</i>	5	0.6	4	0.5	4	4.9
<i>No Response</i>	42	4.8	90	10.3	10	12.3
<i>Listens to patient</i>						
<i>Definitely</i>	816	93.5	765	87.6	63	77.8
<i>Some Extent</i>	14	1.6	19	2.2	4	4.9
<i>No Response</i>	43	4.9	89	10.2	14	17.3
<i>Answers questions understandably</i>						
<i>Definitely</i>	758	86.8	721	82.6	59	72.8
<i>Some Extent</i>	34	3.9	45	5.2	4	4.9
<i>No</i>	0	0	3	0.3	0	0
<i>No Questions</i>	25	2.9	9	1	7	8.6
<i>No Opportunity</i>	1	0.1	2	0.2	2	2.5
<i>No Response</i>	55	6.3	93	10.7	9	11.1
<i>Gains patient confidence and trust</i>						
<i>Definitely</i>	789	90.4	743	85.1	64	79
<i>Some Extent</i>	25	2.9	41	4.7	4	4.9
<i>No</i>	6	0.7	8	0.9	0	0
<i>No Response</i>	53	6.1	81	9.3	13	16

Table 6.15: Clinical Staff Performance — Kruskal-Wallis ANOVA

	Nurse	Doctor	Anaes	p
<i>Knowledge of Patient History</i>	88.7	87.9	90.7	0.36
<i>Discuss issues with patient</i>	96.9	96.4	90.1	0.02
<i>Listens to patient</i>	99.2	98.7	91.7	0.00
<i>Answers questions understandably</i>	97.7	96.4	94.3	0.08
<i>Gains patient confidence and trust</i>	97.7	96.4	96.5	0.06
<i>Overall Likert Score</i>	97.7	96.9	97.8	0.07

6.5.7 Information Given

Table 6.16 shows the percentage of patients who knew why they needed to come to the preoperative clinic, and what this would involve.

Table 6.17 shows which clinicians gave the patient information regarding the perioperative process.

Table 6.16: Knowledge About Clinic

	Yes		No		NA	
	n	(%)	n	(%)	n	(%)
<i>Did you know why you had to attend the Preoperative Clinic?</i>	689	(78.9)	90	(10.3)	94	(10.8)
<i>Did you know what would happen at the Preoperative Clinic?</i>	433	(49.6)	305	(34.9)	135	(15.5)

Table 6.17: Sources of Information

	Any		Nurse		Doctor		Anaes		No Info.		Don't Know		No Response	
	n	%	n	%	n	%	n	%	n	%	n	%	n	%
<i>What anaesthesia involves</i>	500	57.3	204	23.4	392	44.9	33	3.8	103	11.8	14	1.6	261	29.9
<i>What your options for anaesthesia are</i>	251	28.8	67	7.7	206	23.6	22	2.5	209	23.9	48	5.5	371	42.5
<i>What to bring with you to for the operation</i>	480	55.0	306	35.1	230	26.3	5	0.6	80	9.2	13	1.5	305	34.9
<i>What happens when you arrive in the operating room</i>	382	43.8	134	15.3	291	33.3	12	1.4	124	14.2	20	2.3	356	40.8
<i>What the possible side-effects of anaesthesia are</i>	410	47.0	98	11.2	350	40.1	16	1.8	100	11.5	17	1.9	347	39.7
<i>How the pain will be controlled after the operation</i>	410	47.0	107	12.3	350	40.1	7	0.8	110	12.6	13	1.5	344	39.4
<i>Which medicines you should take prior to surgery</i>	426	48.8	89	10.2	383	43.9	9	1.0	89	10.2	13	1.5	349	40.0
<i>Which medicines you should discontinue prior to surgery</i>	391	44.8	83	9.5	348	39.9	6	0.7	82	9.4	18	2.1	385	44.1
<i>When you can last eat and drink prior to surgery</i>	549	62.9	275	31.5	422	48.3	14	1.6	28	3.2	7	0.8	293	33.6

6.5.8 General Assessment of Clinic

In assessing the overall performance of the clinic, respondents gave feedback on whether they felt treated with respect and dignity. This is reported in Table 6.18.

Assessment of the clinic organisation and overall performance were rated by two five-point Likert-score questions and are reported in Table 6.19. This table also reports the Likert-score satisfaction ratings of all the domains in the questionnaire.

Table 6.18: Respect and Dignity

<i>Were you treated with respect and dignity?</i>		
	n	%
<i>Definitely</i>	720	82.5
<i>Some Extent</i>	16	1.8
<i>No</i>	6	0.7
<i>No Response</i>	131	15.0

Table 6.19: Likert-Score Ratings of Service

	1		2		3		4		5		No Response	
	n	%	n	%	n	%	n	%	n	%	n	%
<i>Receptionist</i>	0	0	2	0.2	9	1.0	52	6.0	635	72.7	175	20.0
<i>Nurse</i>	3	0.3	1	0.1	10	1.1	35	4.0	702	80.4	122	14.0
<i>ECCG</i>	1	0.1	3	0.3	16	1.8	45	5.2	579	66.3	229	26.2
<i>Doctor</i>	0	0	2	0.2	14	1.6	51	5.8	611	70.0	195	22.3
<i>Anaesthetist</i>	0	0	0	0	1	1.2	5	6.2	44	54.3	31	38.3
<i>Organisation</i>	1	0.1	2	0.2	23	2.6	96	11.0	636	72.9	115	13.2
<i>Global</i>	0	0	2	0.2	8	0.9	63	7.2	676	77.4	124	14.2

6.6 Patients' Comments

Comments were made in the freeform section by 183 respondents. These were reviewed for thematic content.

6.6.1 Positive Comments

The majority of patient comments were positive. Many were generic expressions of satisfaction. However, some specifically appreciated the organisation of the clinic, the 'one-stop-shop' approach, and staff friendliness and helpfulness.

6.6.2 Negative Comments

The most frequent negative comment theme was related to long waiting times, particularly waiting to be seen by the Foundation doctor. There were also a few comments remarking on the problem of language barriers. A number of Foundation doctors are not Maltese nationals and do not speak Maltese. There were also a small number of comments that inadequate information was given regarding the purpose of the POAC visit and about the planned surgical procedure.

6.6.3 Suggestions

Some suggestions were made regarding improvements to the clinic environment, particularly the waiting area. These included requests for beverage stands and internet WiFi facilities. There were also some requests for an improved public address system in the waiting area. Some suggested having information about the clinic and planned procedure being mailed before the appointment to allow discussion during the consultation.

6.6.4 Other Comments

A few comments were made regarding services related to, but not administratively part of the POAC. A number of negative comments were registered about the organisation of the phlebotomy service, and requested a phlebotomist embedded in the POAC. Lack of adequate public parking space was also noted as an issue.

6.7 Discussion

The tool developed to assess the POAC patient experience is an adaptation of previously described and validated tools [235, 240–242, 252, 253]. The changes made to tailor the questionnaire to the POAC were expected to have had little impact on the validity of the tool, particularly as a similar successful adaptation has been reported in the literature [240]. As discussed in Section 6.7.1 below, the data collected indicates that internal validity was, in fact, maintained. This result supports the validity of the work of Edwards *et al.* [240] in using items from the Picker Institute question set [252, 253] to assess patient satisfaction in an anaesthetic preoperative assessment clinic.

As discussed above (Section 6.3.4), it was necessary to provide English and Maltese versions of the questionnaire. As preferred language may be an indicator of different social or cultural grouping, this raised the concern that the two datasets may not be equivalent. However, a comparison of the responses for each questionnaire item (Section 6.5.1) found no evidence of such a difference. The equivalence of the English and Maltese versions of the questionnaire would lend support to the use Maltese translations of the Picker question set to assess other Outpatient Clinics in Malta.

The questionnaire return rate in this study (estimated as 9%) was rather low when compared to some outpatient surveys [235, 240, 243, 244] reported in the literature. As the survey was anonymous, and completed during the clinic visit, there was no possibility of following up non-responders. In spite of this, due to the duration of the survey, the absolute number of returns compares well with other studies. The low response rates raise concern as to whether the assessment tool was practicable [228]. The response rates on individual items in the returned questionnaires, on the other hand, were satisfactory (Section 6.5.2). This indicates that the tool was found practicable by respondents, and so it is unlikely that this was a major contributor to the low return rates.

As noted, there was a clear but modest decrease in response rate to questions over the length of the questionnaire (Section 6.5.2). This indicates that, although there may have been some ‘fatigue effect’ evident, the length of the questionnaire was not unduly great. Given that it was intended that the questionnaire be completed *pari passu* as the patient proceeded through the clinic, the effect noted may have been due to patients experiencing ‘clinic fatigue’ and losing interest in completing the questionnaire.

The response rate to the multiple-response questions (related to information given) was lower than that of the single response questions. As the most complex part of the questionnaire, this may have deterred some respondents from completing it. This may have been compounded by presentation of this question set late in the questionnaire, due to the fatigue effect noted above. Also, it was one of the few question sets requiring reflection on the whole clinic experience, and so difficulty with recall may have reduced the response rate.

6.7.1 Reliability & Validity

All questions in the tool were attempted by at least some respondents. Completion rates varied between 84.5-97.0% for the single response questions, 55.9-70.1% for the multiple response questions and 61.7-86.0% for the Likert-scale responses. A high response rate on the questionnaire items indicates that the tool has satisfactory content validity. Furthermore, few issues were raised in the comments section which were not addressed by the structured questions. The few comments raising new issues related to the physical ambience of the hospital in general, or the clinic in particular. These domains were intentionally omitted in the interest of tool brevity.

Internal consistency within each domain was assessed with Cronbach’s α . The values reported in Table 6.7 vary between 0.57-0.81. Heidegger *et al.* [228] recommend an α value of >0.7 to demonstrate adequate reliability, such as those reported in the Picker Institute analysis [252]. The present findings are similar to values reported for the PEPAC questionnaire [240].

One would expect that the different elements contributing to a satisfactory patient experience in a given domain to vary with some degree of synchronicity, and hence lead to a high Cronbach’s α . On the other hand,

as each item may be considered as an independent variable influencing the overall experience construct, there need not be absolute concordance. A very high α -value in this context may indicate redundancy of some of the underlying variables.

The correlation coefficients between the domain scores and the overall measures of patient satisfaction given in Table 6.8 allowed an assessment of construct validity of the questionnaire. The ‘Global’ assessments are the only completely independent scores, as the ‘Composite’ and ‘Mean’ coefficients both mathematically include the domain scores in their calculation. Thus, correlations with the ‘Global’ score may give the most unbiased indication of the relative importance of the underlying domains. On the other hand, as is commonly found with Likert-scale assessments of satisfaction [221, 227–230], the responses obtained were very heavily skewed.

The interactions with the clinic staff have a moderate correlation with overall satisfaction, with the exception of interaction with the anaesthetist, which showed very little correlation. This is likely due to the fact that only a small fraction of patients were actually seen by an anaesthetist (around 9%), and so this effect is likely swamped by the other domains.

The ‘Waiting’ domain had a surprisingly low correlation with ‘Global Satisfaction’. Excessive waiting was one of the most frequent complaints in the free text comments. It would appear that in assessing their global satisfaction, respondents were guided more by their appraisal of individual staff, rather than the performance of the clinic as a whole.

The ‘Information’ domain also had a low correlation with the overall satisfaction scores. It may be that the population studied have low expectations for being given medical information, and so this factor did not have great weight in assessing overall satisfaction.

Overall, the correlations observed are somewhat lower than those reported for equivalent domains in other studies [240, 252]. Of particular note is the low score for the ‘Information’ domain. This is of particular interest, given the obligation to ensure that patients are given adequate information to make informed choices regarding their treatment [171] and should be addressed in further development of the clinic.

6.7.2 Clinic Performance

The POAC appears to be meeting the expectations of the clinic attendees. With the exception of excessive waiting times, all the other clinic domains were given a high score. Furthermore, the large majority of respondents gave high Likert scores for organisation, and agreed that they had been treated with dignity and respect.

6.7.2.1 Waiting Times

The scores for the waiting time for the respondents to be seen by the Foundation doctor were the worst of all the waiting times. This is evident from

the responses reported in Section 6.5.5 and corroborated by comments received, as well as informal discussions with clinic staff. This may be partly due to clinical inexperience on the part of the Foundation doctors, who are often newly qualified. Addressing the causes of this bottleneck in patient flow should be one of the areas for process improvement.

6.7.2.2 Clinical Staff

The results for the performance of clinical staff, reported in Section 6.5.6, demonstrate equivalent knowledge of the patient history amongst the clinical staff. The anaesthetists scored marginally lower on ability to listen to the patient and to discuss issues. This may be a reflection of the fact that normally, the anaesthetist would be consulted by the Foundation doctor and may not interact with the patient as much as is desirable. This may be an area requiring improvement in communication skills.

The clinical staff (Nurses, Foundation doctors and anaesthetists) scored highly, and equally well in familiarity with the clinical history, ability to answer questions and gaining patient trust. Overall assessment of the three groups was not significantly different.

6.7.2.3 Information Given

It is clear from the findings presented in Section 6.5.7 that many patients attend the preoperative clinic with little preparation of what will be done at the clinic. Better preparation may facilitate the clinic process, and ways to address this gap will have to be developed, perhaps through making available information leaflets at other referring departments, giving links to procedure-specific websites, or in liaison with the patient's primary health-care physician [171].

The development of language barriers between Maltese-speaking patients and junior doctors is a relatively new phenomenon. Previously, most junior doctors were native Maltese speakers. In recent years, a number of non-Maltese junior doctors have been appointed, leading to some communication difficulties. As this is becoming a common problem across the local health service, it is now policy that future appointees will be required to acquire basic Maltese language competency [254, 255].

Information given to the patient is also somewhat lacking in a number of areas. Providing necessary information is an important aspect of preoperative preparation, and is required to allow the patient to make informed decisions, as recommended by the Royal College of Anaesthetists [171]. This lack of information, or at least, the patients' lack of recollection of being given the information, could have a significant impact on the eventual perioperative care. Poor recall of verbally given information is a known problem [256]. This may have to be addressed by ensuring that these issues are discussed with the patient, and written or online material is made available for them to consult either before or after the clinic visit.

6.7.2.4 Likert Satisfaction Scores

It is gratifying that the large majority of respondents gave high overall satisfaction scores for all aspects of the clinic. This is similar to findings for other clinics reported in the literature [235, 242, 243]. However, this should be taken in the context of the known large skew effect often seen with Likert scales used in this situation [227] and should not give rise to complacency without assessing specific aspects of the patient experience [231, 252].

6.8 Conclusion

The results of the survey indicate that the majority of patients were satisfied with their experience of the POAC. The survey questionnaire developed appears to have maintained the reliability and validity of the tools it was based upon. Specific areas requiring improvement include making information available to patients (possibly in different formats) and improving waiting times and flow through the clinic.

Chapter 7

Technical Evaluation of Preoperative Assessment

7.1 Introduction

If the preoperative assessment is to achieve its intended purpose of identifying relevant clinical issues and optimising the patient for surgery and anaesthesia, it must be of adequate technical quality. Although various aspects of the clinic function may be assessed through the patients' appraisal of their experiences (see Chapter 6), patients may lack the necessary knowledge to judge the technical quality of the care they receive [219]. In order to have a more complete understanding of the process of preoperative assessment, an evaluation of the technical quality is desirable. In particular, investigation of instances of poor quality assessment would help understand the characteristics of the failure modes of the processes.

At the time of this investigation, based on internal operating theatre and clinic activity reports, an estimated 45% of elective and scheduled cases requiring anaesthesia care at the study hospital underwent preoperative assessment at the POAC. The organisation of this clinic is described in Chapter 5. The remainder of the elective cases, and all urgent and emergency cases, had their preoperative assessment carried out elsewhere, usually by Foundation Doctors on the wards or at other outpatient clinics, with less anaesthetic supervision.

This situation gives the opportunity to compare the technical quality of preoperative assessment from the different pathways.

7.2 Aims

This study was intended to identify the nature of inadequacies in preoperative assessment.

7.3 Evaluation of Preoperative Assessment

In order to guide development of a method to assess the technical quality of the preoperative process, a Pubmed search was carried out to identify literature regarding assessment of the quality of preoperative assessment.

7.3.1 Literature Search

A Pubmed search was carried out using the search terms shown below:

```
(preop* OR preanaes* or preanes*)  
AND (Qualit* or eval* or adeq*)  
AND (Anes* or anaes*)  
AND assessment
```

This search returned 700 articles. Article titles and abstracts were reviewed to identify articles which dealt with the technical quality of the preoperative assessment. Articles which considered only patients' assessment of quality or patient satisfaction were excluded. Only English-language articles were extracted in full.

7.3.2 Approaches to Evaluation

7.3.2.1 Completeness of Dataset

One approach to evaluating the technical quality of the preoperative assessment is to quantify the accuracy and completeness of the preoperative dataset.

This approach was used by Ausset *et al.* [26]. In a quality improvement initiative, their institute compiled a 'minimum acceptable dataset' which should be collected from preoperative patients, based on literature and the expert opinions of anaesthetists in their department. Completed questionnaires were then assessed retrospectively to determine the percentage of completed data items. This was used as a measure of preoperative quality. They did not, however, attempt to verify the accuracy of the data collected. Also, all the items were given equal weighting in calculating the quality index, irrespective of the clinical importance of the information.

A similar approach was used by Koris *et al.* [197] in assessing a re-designed preoperative screening tool, in that they assessed compliance in completing the tool, but did not investigate the accuracy of the data collected. The details of the tool were not presented, but assessment was only made for the areas of history, physical examination, additional investigations and fitness for surgery.

The approach used in these studies is relatively straightforward and objective. However, it does presuppose the establishment of a 'gold-standard' preoperative dataset. Also, it does not assess the accuracy of the data collected, nor does it address areas of the preoperative process such as patient optimisation.

7.3.2.2 Accuracy of Evaluation

Kinley *et al.* [199] conducted an equivalence study enrolling 1907 patients to demonstrate that appropriately trained nurses could carry out a preoperative assessment with the same reliability as a house officer. The assessment was then evaluated by an anaesthetic Specialist Registrar and, in case of disagreement, the case was reviewed by a consultant anaesthetist. The assessment was rated on history-taking, physical examination and ordering of investigations. The assessment was judged as correct, over-assessment, under-assessment which did not effect perioperative management, or under-assessment which could potentially have effected perioperative management. Studies using similar methodology, comparing nurse practitioners and senior house officers in assessing paediatric patients were conducted by Rushforth *et al.* [174, 175]. In these studies, judgement of the accuracy of the preoperative assessment was carried out by a paediatric anaesthetist.

A study evaluating nurse-conducted preoperative assessment was carried out by van Klei *et al.* [176]. In this study, 4540 patients were assessed sequentially by a nurse and an anaesthetist guided by an electronic health questionnaire. The practitioner made a final judgement of 'ready for surgery' or 'not ready, needs workup'. The performance of the nurses was assessed against the judgement of the anaesthetist, which was taken as the reference standard. The investigators reported the nurse assessment had a sensitivity of 83% and a specificity of 87%. However, the nurses took 1.85 as much time as the anaesthetists to conduct the assessment.

Hilditch *et al.* [29] assessed the accuracy of a patient-completed questionnaire, comparing this to the same questions being asked by an anaesthesia specialist registrar. Using κ -coefficients or percentage compliance as appropriate, they found very good correlation between the two approaches.

7.3.2.3 Clinical Outcomes and Logistics

A study reported by Varughese *et al.* [177] compared effectiveness of anaesthetist and nurse-practitioner preoperative assessment of 1509 children using a pretest-posttest design. Effectiveness was compared by assessing perioperative respiratory complication rates, preoperative preparation time and parental and staff satisfaction. The same approach was used by Wittkugel and Varughese [178] in assessing modifications in paediatric preoperative assessment at their institution. The use of actual impact on perioperative management, and the incidence of complications, rather than a proxy assessment by the attending anaesthetist is unusual. However, inadequacies in the preoperative assessment progressing to actual complications in the perioperative period would often be mitigated by the intervention of the attending anaesthetist. This may therefore be an insensitive measure of adequacy of the preoperative assessment.

Instances of poor preoperative assessment associated with adverse outcomes were reported in a review of 197 cases from the Australian Incident Monitoring Study [20]. These are summarised in Table 7.1.

Table 7.1: Preoperative deficiencies associated with poor outcome [20]

- Poor airway assessment
- Communication problems
 - Casenotes missing, unclear or confusing
 - Hospital Processes
 - Patient Factors
 - Language difficulties
- Inadequate evaluation
 - Respiratory system
 - Cardiovascular system
 - Emergency procedure
 - Diabetes mellitus
 - Dental history
 - Other
 - Alcohol history
 - Muscular dystrophy
 - Haematology
- Drug management error
- No anaesthetic review
- Inadequate preoperative resuscitation
- Inadequate blood cross matched
- Patient factors

7.3.2.4 Staff Satisfaction

In the studies by Varughese [177] and Wittkugel [178] discussed in Section 7.3.2.3, the investigators also used staff satisfaction (anaesthetists and day surgery clinic nurses), as assessed by a questionnaire, as a measure of adequacy of the preoperative assessment. However, they assessed overall satisfaction with the program, not satisfaction with the preparation of individual patients. Details of the questionnaire used were not presented.

In a large study of 21,454 patients undergoing non-cardiac surgery [257], the preanaesthesia evaluation record was assessed by the attending anaesthetist using a computerised form, which included pre-defined notes on the adequacy of the assessment, as well as free-text fields for entry. Of these, 96.5% had a valid preoperative assessment. Comments were made by the attending anaesthetist on 2.2% of the latter. Areas of inadequacy included comorbidities not being identified, or inadequately assessed, inadequate preoperative investigation and incorrect documentation or perioperative management of medications.

7.4 Development of Evaluation Tool

From the available literature, it appears that there is no standardised method to evaluate the effectiveness of the preoperative assessment process. Construction of such a tool was therefore undertaken. The various factors taken into consideration in the design of this tool are outlined below.

7.4.1 Evaluator

Studies which look exclusively at the completeness of a predetermined dataset as a measure of quality [26, 197] made use of an assessor with little specialist training. On the other hand, where an assessment of the accuracy or adequacy of the preoperative process was made, reliance was placed on the judgement of anaesthetists. These may have been specifically deployed as part of a research protocol [29, 174, 175, 199], or with the evaluation incorporated into normal clinical workflow [176–178].

The tool being developed would ideally provide a multi-domain evaluation of the preoperative assessment. The available evidence would support the practice of having this evaluation being undertaken by an anaesthetist, who would have the necessary specialist knowledge of the field.

7.4.2 Items of Evaluation

Items for possible inclusion in the evaluation tool were generated from the preoperative dataset items identified in the literature reviewed in Chapter 2. In order to keep the evaluation tool to a reasonable length, the relative importance attributed to the various dataset items in the local setting, as identified in the survey reported in Chapter 3 was taken into consideration.

The opinions expressed in interviews held with anaesthetists (see Chapter 4) were also taken into account in the final selection of the tool items. The impact of reported deficiencies on patient outcome was assessed using a schema based on the Clavien-Dindo classification [258, 259].

7.4.3 Questionnaire Domains

A consideration of standard clinical practice, as adapted to the workflow of the POAC (see Chapter 5) would suggest grouping the questionnaire items into the following domains.

- General/Logistics
- History & Comorbidities
- Systemic Enquiry
- Physical Examination
- Investigations
- Drug History & Perioperative Management of Medication
- Outcomes

7.5 Construction of Questionnaire

Based on the above considerations, a questionnaire to assess the quality of the preoperative assessment was constructed.

Questionnaires can be structured as evaluative-style or report-style. The advantages and disadvantages of each are discussed in Chapter 6 Section 6.3.2. The current tool was developed predominantly as a report-style questionnaire, as this structure is better able to identify specific deficiencies in the preoperative process. Likert-type scales were incorporated to allow evaluation of the impact of any reported deficiencies. Freeform text comments were also collected.

A pilot trial of the tool was organised to test the face validity and elicit feedback. A group of anaesthetists were asked to review the proposed tool. Respondents were asked to consider a recent case they anaesthetised where they considered the preoperative assessment was unsatisfactory, and attempt to fill in the form based on this case. Comments on usability of the form, and any omissions were solicited. The feedback obtained prompted addition of some items to the tool, and some modifications to the questionnaire layout.

The revised questionnaire is reproduced in Appendix C. The questionnaire was typeset using the L^AT_EX typesetting package with the SDAPS package extension [167] to allow electronic data capture.

7.6 Method

All specialist anaesthetists working in the Department were informed by email of the study, and were invited to submit completed evaluation forms for any preoperative assessment which they felt were inadequate in any respect. Copies of the questionnaire were made available within the department. The reports were all anonymous, and no identifying data of either the respondent submitting the questionnaire, the staff responsible for the preoperative assessment, or the patient were recorded. Reports were collected between October 2017 and January 2019. During this period, members of the Anaesthetic Department were reminded of the ongoing study, both verbally and by email on several occasions.

Returned forms were scanned and processed with the SDAPS optical mark reader software [167]. The scanned images were examined visually to verify scan quality and to manually correct ambiguous markings. The data collected was imported into the R statistical software package (version 3.1.2) [168] for analysis.

Categorical data and Likert scores were summarised as frequency tables. Frequencies of various identified inadequacies were displayed as contingency tables stratified by the assessment pathways (POAC or Other). The significance of differences between the POAC and the other assessment pathways was assessed using Fisher's exact test. The distribution of surgical complexity in the study data were compared to historical institution data using χ^2 test.

7.7 Results

Data were collected on 72 preoperative assessments which were judged to be inadequate by the reporting anaesthetist.

7.7.1 Case Details

Descriptive statistics for the distribution of cases by surgical speciality, patient ASA-PS and urgency of surgery are given in Tables 7.2, 7.3 and 7.4 respectively. The location where the clerking was performed (Preoperative Clinic, Ward or other location) is reported in Table 7.5.

The type of documentation used (POAC questionnaire, other proforma, or freeform documentation) stratified by location of assessment is given in Table 7.6. Due to low counts, the cells for ward and other locations were combined, as were the cells for proforma and freeform charts. Fisher's exact test showed a highly significant difference (Odds Ratio = 39.2 $p = 1.005e-9$). Outside the POAC, there were still a variety of non-standard preoperative documentation charts in use.

The distribution of surgical complexity, using an abbreviated form of the BUPA nomenclature, is given in Table 7.7. This was compared to the expected distribution for the hospital, based on published historical theatre

Table 7.2: Inadequate preop by Surgical Speciality

	n	%
<i>General</i>	33	46
<i>Urology</i>	8	11
<i>Vascular</i>	7	10
<i>Cardiac</i>	0	0
<i>Neuro</i>	2	3
<i>Plastics</i>	0	0
<i>Ophth</i>	0	0
<i>ENT</i>	4	6
<i>MaxFax</i>	0	0
<i>Dental</i>	1	1
<i>Ortho</i>	12	17
<i>Gynae</i>	4	6
<i>Other</i>	1	1

Table 7.3: ASA-PS Distribution.

	1	2	3	4	5
<i>n</i>	4	20	42	3	0
<i>%</i>	6	29	61	4	0

Table 7.4: Surgical Urgency Category.

	Scheduled	Urgent
<i>n</i>	68	4
<i>%</i>	94	6

Table 7.5: Location where preoperative assessment was carried out.

	POAC	Ward	Other
<i>n</i>	45	24	2
<i>%</i>	63	34	3

Table 7.6: Documentation Type by Clerking Location

	Documentation Type					
	POAC		Proforma		Freeform	
	n	%	n	%	n	%
<i>POAC</i>	41	91	4	9	0	0
<i>Ward</i>	5	21	10	42	9	38
<i>Other</i>	0	0	1	50	1	50
	POAC		Non-POAC			
<i>POAC</i>	41		4			
<i>Ward/Other</i>	5		21			

Fisher's Exact Test:
Odds Ratio = 39.2 $p = 1.005e-9$

activity statistics [7] using χ^2 test (see Table 7.8). The distributions were significantly different ($p = 0.019$), with a deficit of minor surgery cases and an excess of major variant[†] surgery in the cases with inadequate preoperative preparation.

Table 7.7: Grade of surgery.

	Minor	Intermediate	Major	Complex
<i>n</i>	12	33	24	3
<i>%</i>	17	46	33	4

Table 7.8: Surgical Complexity Compared to Expected[†] Distribution

	Observed	Expected [†]
<i>Minor</i>	12	23.0
<i>Intermediate</i>	33	28.4
<i>Major Variant[†]</i>	27	20.6
$\chi^2=7.97$ df=2 $p=0.019$		

[†] See Section 7.7.1

7.7.2 General

The completeness of clerking carried out at the POAC and in other locations (eg wards, other outpatient clinics) is given in Table 7.9. For the purposes of statistical analysis, 'incomplete' and 'absent' documentation are combined, and clerking at POAC is compared to all other locations combined. Clerking undertaken at POAC was found to be complete more frequently (Fisher's Exact Test, Odds Ratio= 11.7 $p = 8.0e-6$).

[†]Major Variant surgery comprises Major, Major Plus and Complex Major surgery

Table 7.9: Completeness of Casenotes by Clerking Location

	Complete		Incomplete		Absent	
	n	%	n	%	n	%
<i>POAC</i>	38	84	7	16	0	0
<i>Ward</i>	8	33	14	58	2	8
<i>Other</i>	0	0	2	100	0	0
Totals	46	64	23	32	3	4
	Complete		Incomplete/ Absent			
<i>POAC</i>	38		7			
<i>Ward/Other</i>	8		18			

Fisher's Exact Test:
Odds Ratio = 11.7 $p = 8.0e-6$

The availability of investigation results is shown in Table 7.10. The performance of the POAC is again compared to clerking in other locations by Fisher's exact test. Performance of the POAC was significantly better in this respect (Odds Ratio = 3.74 $p = 0.0146$).

Table 7.10: Completeness of Investigations by Clerking Location

	Complete		Incomplete		Absent	
	n	%	n	%	n	%
<i>POAC</i>	24	53	5	11	16	36
<i>Ward</i>	6	25	6	25	12	50
<i>Other</i>	0	0	0	0	2	100
Totals	31	42	11	15	31	43
	Complete		Incomplete/ Absent			
<i>POAC</i>	24		21			
<i>Ward/Other</i>	6		20			

Fisher's Exact Test:
Odds Ratio = 3.74 $p = 0.0146$

The timing of the preoperative assessment is reported in Table 7.11. For statistical analysis, assessments carried out either too early or too late are grouped as 'inappropriate'. Comparing the POAC and all other locations by Fisher's exact test, there was a significant excess of inappropriately timed assessments in the non-POAC cohort (Odds Ratio = 3.89 $p = 0.022$).

It is left to the discretion of the doctor performing the preoperative assessment as to whether they consult with the attending anaesthetist regarding any preoperative issues. The appropriateness of the decision as to whether undertake such a consultation is reported in Table 7.12. In this context, a 'necessary' consultation was where the attending anaesthetist considered the consultation to be appropriate, 'unnecessary' was where the clerking doctor *correctly* decided not to consult, and 'omitted' indicates that

Table 7.11: Timing of Assessment by Clerking Location

	Appropriate		Too Early		Too Late	
	n	%	n	%	n	%
<i>POAC</i>	38	84	2	4	5	11
<i>Ward</i>	14	58	1	4	9	38
<i>Other</i>	1	50	0	0	1	50
Totals	53	75	3	4	15	21
	Appropriate		Inappropriate			
<i>POAC</i>	38		7			
<i>Ward/Other</i>	15		11			

Fisher's Exact Test:
Odds Ratio = 3.89 $p = 0.022$

there was an *incorrect* decision not to consult. The performance of staff at POAC is compared to clerking pathways in other locations by Fisher's exact test. While there is a trend for POAC to perform worse than other locations, this fails to reach statistical significance (Odds Ratio = 0.37 $p = 0.07$).

Table 7.12: Anaesthetic Consultation by Clerking Location

	Consulted		Unnecessary		Omitted	
	n	%	n	%	n	%
<i>POAC</i>	3	7	9	20	33	73
<i>Ward</i>	1	4	10	42	13	54
<i>Other</i>	0	0	2	100	0	0
Totals	4	6	21	30	46	65
	Appropriate/ Unnecessary				Omitted	
<i>POAC</i>	12				33	
<i>Ward/Other</i>	13				13	

Fisher's Exact Test:
Odds Ratio = 0.37 $p = 0.07$

7.7.3 Medical History and Comorbidities

Assessment or management of the patient's pre-existing comorbidities was considered unsatisfactory in 83% of cases, (see Table 7.13). The POAC assessment was compared with other clerking pathways using Fisher's exact test, which showed no significant difference. In total there were 104 reported instances of inadequately assessed or managed comorbidities (see Table 7.14). It was not uncommon to find multiple comorbidities inadequately managed in the same patient (see Table 7.15). Common cardiovascular conditions collectively represent the largest group, accounting for 48%

of instances. Other common inadequacies were found in the assessment of the difficult airway, obstructive sleep apnoea and diabetes.

The specific issues found with the preoperative workup are detailed in Table 7.16. Failure to recognise the severity of the patient's impairment was the most frequent issue, closely followed by failure to seek an anaesthetic consultation, failure to investigate fully and failure to optimise the patient.

The importance of the omissions was rated on a five-point scale with anchors as 'Unimportant' (1) and 'Very Important' (5). The ratings are reported in Table 7.17. In 87% of cases, the issues raised were scored as '4' or '5' on the five-point scale.

Table 7.13: Assessment of Medical History and Comorbidities

	Yes		No	
	n	%	n	%
<i>POAC</i>	8	18	36	82
<i>Ward/Other</i>	4	15	22	85
<i>Total</i>	12	17	58	83

Fisher's Exact Test:
Odds Ratio= 1.22 $p = 1$

Table 7.14: Inadequately Managed Comorbidities

	n	%[†]
Cardiovascular		
<i>Hypertension</i>	9	9
<i>Ischaemic Heart Disease</i>	13	12
<i>Congestive Heart Failure</i>	10	10
<i>Arrhythmia</i>	7	7
<i>Valvular Heart Disease</i>	5	5
<i>Pacemaker</i>	2	2
<i>Implanted Defibrillator</i>	0	0
<i>Coronary Stents</i>	1	1
<i>Other CVS Condition</i>	3	3
Cardiovascular Total	50	48
Respiratory		
<i>Asthma</i>	1	1
<i>COPD</i>	3	3
<i>Obstructive Sleep Apnoea</i>	5	5
<i>Other Respiratory Disease</i>	3	3
Respiratory Total	12	12
Airway		
<i>Difficult Airway</i>	6	6
<i>Difficult Intubation</i>	2	2
<i>Poor Dentition</i>	2	2
Airway Total	10	10
Misc.		
<i>GI Reflux</i>	1	1
<i>Peptic Ulcer</i>	0	0
<i>Renal Disease</i>	3	3
<i>Hepatic Disease</i>	0	0
<i>Anaemia</i>	1	1
<i>Diabetes Mellitus</i>	5	5
<i>Thyroid Disease</i>	3	3
<i>Neurological Disease</i>	4	4
<i>Other</i>	15	14
Misc. Total	32	31
Total Comorbidities	104	100

[†] As % of inadequately managed *comorbidities*

Table 7.15: Inadequately managed comorbidities

No. of Patients	Number of Comorbidities				
	0	1	2	3	4
<i>n</i>	12	33	13	11	3
%	17	46	18	15	4

Table 7.16: Issues with management of comorbidites

	n	%[†]
<i>Known condition not documented</i>	16	10
<i>Inadequate Systemic Enquiry</i>	13	8
<i>Inadequate Physical Examination</i>	10	6
<i>Severity of condition underestimated</i>	29	18
<i>Condition Inadequately Investigated</i>	23	14
<i>POAC Anaesthetist not consulted</i>	27	17
<i>Other Specialist not consulted</i>	13	8
<i>Patient not optimised</i>	19	12
<i>Other issues</i>	11	7

[†] As % of all issues with management of comorbidities

Table 7.17: Importance of inadequate assessment of comorbidity

	Importance				
	1	2	3	4	5
<i>n</i>	0	1	7	16	37
%	0	2	11	26	61

7.7.4 Preoperative Investigations

Issues with preoperative investigations were noted in 46% of cases (see Table 7.18). Comparing POAC with other clerking pathways using Fisher's exact test, no significant difference was observed. The specific nature of these issues is outlined in Table 7.19. The most frequent issue related to echocardiography, where this was either inappropriately not requested, or not performed by the operation date.

The importance of the issues was rated on a five-point scale with anchors as 'Unimportant' (1) and 'Very Important' (5). The importance of the issues related to investigation is given in Table 7.20. In 94% of cases, the issues raised were scored as '4' or '5' on the five-point scale.

Table 7.18: Satisfactory Preoperative Investigation of Patient

	Yes		No	
	n	%	n	%
<i>POAC</i>	24	53	21	47
<i>Ward/Other</i>	14	56	11	44
<i>Total</i>	38	54	32	46

Fisher's Exact Test:
Odds Ratio= 0.90 $p = 1$

Table 7.19: Investigation Issues

	Not Requested		Not Performed		Not Available		No Follow-up		Any	
	n	% [†]	n	% [†]	n	% [†]	n	% [†]	n	% [†]
<i>CBC</i>	1	2	3	5	0	0	1	2	5	8
<i>Electrolytes</i>	1	2	3	5	0	0	3	5	7	11
<i>Renal Profile</i>	1	2	3	5	0	0	3	5	7	11
<i>Blood Glucose</i>	2	3	1	2	0	0	1	2	4	6
<i>HBA1C</i>	1	2	1	2	0	0	0	0	2	3
<i>Coag. Screen</i>	1	2	0	0	0	0	0	0	1	2
<i>Liver Profile</i>	2	3	1	2	0	0	0	0	3	5
<i>ABG</i>	1	2	2	3	0	0	0	0	3	5
<i>ECG</i>	2	3	0	0	0	0	2	3	4	6
<i>Stress ECG</i>	1	2	3	5	0	0	1	2	5	8
<i>Echocardiogram</i>	7	11	5	8	2	3	0	0	14	22
<i>CXR</i>	1	2	2	3	0	0	0	0	3	5
<i>Spirometry</i>	2	3	1	2	0	0	0	0	3	5
<i>Type and Screen</i>	2	3	1	2	0	0	1	2	4	6
Totals	25	38	26	40	2	3	12	18	65	100

[†] As percentage of all investigation issues

Table 7.20: Importance of inadequate investigation

	Importance				
	1	2	3	4	5
<i>n</i>	0	0	2	13	19
<i>%</i>	0	0	6	38	56

7.7.5 Drug History and Management

Inadequacies in the drug history and perioperative management of medications were found in 37% of cases (see Table 7.21). There was a significantly higher incidence of inadequate drug history in the non-POAC group (Fisher's exact test: Odds ratio= 4.52 $p = 0.005$). Issues with documentation of allergy status are reported in Table 7.22. Although this was correctly recorded in the large majority of cases, it is particularly concerning that in one case a known allergy was not documented, and in another case, a patient with a history of drug allergy was incorrectly documented as having no allergies.

Table 7.23 details issues with documentation of other medications, and whether these were inappropriately stopped or inappropriately continued in the perioperative period.

The importance of the noted inadequacies is given in Table 7.24. The issues raised were scored as '4' or '5' on the five-point scale in 75% of cases.

Table 7.21: Satisfactory Drug History and Perioperative Management by Clerking Location

	Yes		No	
	<i>n</i>	<i>%</i>	<i>n</i>	<i>%</i>
<i>POAC</i>	34	77	10	23
<i>Ward/Other</i>	11	42	15	58
Total	45	64	25	36

Fisher's Exact Test:
Odds Ratio = 4.52 $p = 0.005$

Table 7.22: Drug Allergies

	<i>n</i>	<i>%</i>
<i>No, correctly documented.</i>	19	79
<i>No, but documented as allergy</i>	0	0
<i>Yes, correctly documented</i>	1	4
<i>Yes, but not documented</i>	1	4
<i>Yes, but documented as no allergies</i>	1	4
<i>Allergy status not documented</i>	2	8

Table 7.23: Issues with perioperative management of medications

	ND		Stop		Cont		Any	
	n	%[†]	n	%[†]	n	%[†]	n	%[†]
<i>Psychotropics</i>	3	12	0	0	0	0	3	12
<i>β-Blockers</i>	1	4	2	8	0	0	3	12
<i>ACEI</i>	1	4	2	8	1	4	4	15
<i>Sartans</i>	0	0	1	4	0	0	1	4
<i>Statins</i>	1	4	1	4	0	0	2	8
<i>Diuretics</i>	1	4	1	4	2	8	4	15
<i>Ca⁺⁺ Blocker</i>	1	4	1	4	0	0	2	8
<i>Aspirin</i>	2	8	0	0	0	0	2	8
<i>Antiplatelets</i>	1	4	0	0	1	4	2	8
<i>Warfarin</i>	0	0	0	0	0	0	0	0
<i>OHAs</i>	0	0	0	0	0	0	0	0
<i>Insulin</i>	2	8	1	4	0	0	3	12
Totals	13	50	9	35	4	15	26	100

Key: **ND**: Not Documented.

Stop: Inappropriately stopped.

Cont: Inappropriately continued.

Any: Any Issue

[†] As percentage of all issues with medications

Table 7.24: Importance of inadequate perioperative management of medications

	Importance				
	1	2	3	4	5
<i>n</i>	0	3	2	5	10
<i>%</i>	0	15	10	25	50

7.7.6 Sequelae and Untoward Events

The respondents reported on a number of sequelae to inadequate preoperative assessment. As detailed in Table 7.25, 11% of cases were postponed to later on the same theatre list and 30% rescheduled, in order to address the issues. In spite of the concerns raised, surgery went ahead in 56% of cases, with the rest being postponed or rescheduled.

Perioperative incidents are reported in Table 7.26. Fortunately, only two cases were reported as having major (potentially life-threatening) events. These two reports of cases with major sequelae were examined. Further details were recorded in the report comments section. In one case, the patient had a history of severe ischaemic heart disease, not flagged up or discussed with an anaesthetist preoperatively. The patient had an angina episode immediately preoperatively. Surgery was postponed and the patient was referred for medical review and management. In a second case, antihypertensives were incorrectly stopped preoperatively. Details of the perioperative event were not submitted. The patient required prolonged Stage 1 recovery, but this was judged to be unrelated to the issues with preoperative preparation. Fortunately there were no long-term sequelae.

Table 7.25: Delays due to inadequate preoperative preparation

	n	%
<i>None</i>	37	56
<i>Postponed</i>	7	11
<i>Rescheduled</i>	20	30
<i>Other</i>	2	3

Table 7.26: Perioperative Sequelae

	n	%
<i>None</i>	34	72
<i>Minor</i>	11	23
<i>Major</i>	2	4

7.8 Discussion

The tool developed for this investigation allows a detailed, systematic evaluation of the technical quality of an anaesthetic preoperative assessment. In use, it allowed identification of the majority of logistical deficiencies. Inadequacies of medical comorbidity assessment were adequately characterised, and only 14 % of flagged comorbidities could not be classified into one of the predefined categories. Similarly, identification of issues with medical management appears satisfactory with 93% being classified into a predefined

category. The sections identifying preoperative investigation and perioperative management of medications also identified most of the issues raised in the present study.

The low return rates may give some concern that the tool was found to be too cumbersome for routine use. However, there was no formal or informal feedback to this effect.

The tool could be easily modified to suit specific workflows or patient populations, for example by adding medical conditions expected to be common in a given context.

In addition to its use for research, it could be incorporated into the routine workflow to be used as part of a quality assurance programme for a preoperative assessment facility. It could also be adapted to provide feedback to individual clinicians performing the assessment as part of ongoing training.

The study returned 72 reports of unsatisfactory preoperative assessment and management. During the timeframe of the study, based on published theatre activity [7] an estimated 46,000 people required perioperative anaesthetic care. This equates to a reported return of 0.15%. This return rate is quite low, in spite of frequent anecdotal complaints of inadequate preoperative preparation. This is likely to be due to the voluntary nature of the reporting. Using a more robust methodology for eliciting reports van Klei [257] obtained comments of inadequate preoperative assessment in 2% of cases.

7.8.1 Case Details

At the time of the study, many patients were still having preoperative clerking performed at locations other than the preoperative clinic. Whilst the cases seen at the preoperative clinic almost invariably used the standardised documentation, those seen at other locations often used non-standard proforma charts or free-form clerking. This may have contributed to some of the other issues encountered.

Compared to the usual distribution of case complexity, in the studied cohort there were less minor, and more major variant types of surgery. This may imply worse preparation of complex cases, or that anaesthetists may be less tolerant of inadequacies in the more challenging cases and therefore more likely to report these inadequacies.

7.8.2 General

Incomplete documentation was noted in 32% of cases, with a disproportionate number being from the patients clerked outside POAC. This may be partly due to some foundation doctors using the online POAC clerking questionnaire, but failing to also complete the part of the documentation usually completed by the nursing staff.

Similarly, investigations were more often missing from the non-POAC

clerked patients. This may be due to the more structured environment of the POAC, the availability of *aides-mémoire* for selecting appropriate investigations, and easy access to anaesthetic staff for consultation. Another factor may be the fact that patients not clerked through the POAC were often reviewed close to the date of surgery. There may then have been insufficient time to complete all required investigations. However, as the absolute numbers reported are low these findings must be interpreted with caution.

In the reported cohort, 21% of cases were deemed to have been assessed too late preoperatively. As noted above, the majority of these came from the non-POAC group. This is likely due to the practice of patients who are added to the list at short notice bypassing the POAC, as there may not be an available appointment in the available timeframe.

Failure to consult with the perioperative anaesthetist was noted in 65% of cases, making this one of the most prevalent issues raised. This issue was identified as one of the failure modes requiring mitigation in the HFMEA (see 5.6.4). While this was noted more frequently in the POAC-clerked patients, this fails to achieve statistical significance. A possible explanation is that, having consulted with the clinic anaesthetist, the FY doctor does not appreciate that communication with the attending anaesthetist is also required. Further investigation of this phenomenon would be warranted.

7.8.3 Medical History and Comorbidities

Failure to correctly assess or manage patient comorbidities was another major area of concern, with issues noted in 83% of reports. Cardiovascular workup was the most frequent issue, reported in 66% of cases, followed by respiratory and other systems. This may be a reflection of the perceived importance of cardiovascular pathology, or the frequent incidence of cardiovascular complaints in the population. Almost 90% of the issues were rated at 4 or 5 on a 5-point scale of importance. Most commonly noted were failure to recognise the severity of the condition, and this may have led to other failures such as failure to investigate, optimise and communicate with the caring anaesthetist. Most of these issues were anticipated in the HFMEA reported in Chapter 5 Section 5.6.4.

7.8.4 Preoperative Investigations

Issues were noted with preoperative investigations in 46% of reports. The most frequent issue was in obtaining an echocardiogram (22% of reported issues), which were mainly due to failure to request the investigation or failure to obtain the investigation within the available timeframe. The difficulty for this particular investigation may be due to lack of resources.

Considering issues with all types of investigation, failure to request the investigation, and failure to ensure that this is performed in a timely manner account for most of the failures encountered. The former may be due to the

foundation doctors not recognising the need for investigation. The latter may be due to the foundation doctors not being aware of their responsibility to follow up the investigations, or failure to communicate this effectively to the rest of the team. Again, many of these failures were predicted in the HFMEA reported in Chapter 5 Sections 5.6.4 and 5.6.7.

7.8.5 Drug History and Management

Unsatisfactory perioperative management of medications was reported in 37% of cases. The main error noted was failure to document medications correctly, followed by inappropriately stopping medication which should have been continued. The POAC pathway performed significantly better than the non-POAC pathway. In the POAC cohort, drug history is elicited by the clinic nurse, whereas in the other pathways, the FY doctor will be working without assistance. This may explain the difference in performance. The data sample obtained was, regrettably, too small to identify any differences between different drug classes.

Although uncommon, errors in documentation of allergies raised a particular concern. In one case, a known allergy was undocumented, and in a second case, an allergy was incorrectly documented as 'no allergies'. In view of the possible serious consequences, this documentation must be made more robust.

7.8.6 Outcomes

In the majority of cases (67%), surgery proceeded either immediately, or on the same operating list with no, or only minor, self-limiting sequelae. Only two patients were considered to have experienced a major event. However, in 11% of cases, extra efforts had to be made to correct the preoperative deficiencies of the preoperative assessment at short notice. Furthermore, in 30% of cases surgery had to be rescheduled, with inconvenience to the patient and waste of theatre resources.

7.9 Conclusion

In spite of the concerns and issues reported here, the evidence presented suggests that errors in the preoperative assessment rarely progress to a situation resulting in major harm to the patient. This should not, however, lead to complacency in the conduct of the preoperative assessment. The preoperative assessment is only one of the safeguards against the patient coming to harm in the perioperative period. Reason's Swiss-cheese model of defences [260] would predict that more errors at this stage will increase the likelihood of eventual patient harm.

The findings of this small survey of inadequacies in preoperative preparation support several of the findings of the HFMEA reported in Chapter 5.

Taken together, this strengthens the rationale for attempting to mitigate the failure modes identified.

Chapter 8

Construction of a Cognitive Aid

8.1 Introduction

In current hospital practice, responsibility for a patient is frequently passed between different teams of clinicians. Examples include the primary responsible firm handing over care to an on-call team of doctors, clinicians in Intensive Care Units handing over care at shift changes, and the transfer of patients between different services or clinical areas.

Handover, or handoff, has been defined as:

“The exchange between health care professionals of information about a patient accompanying either a transfer of control over, or responsibility for, the patient” [261]

The organisation of the preoperative clinic under consideration has been described in detail in Section 5.3 and is broadly similar to several other preoperative clinic strategies described in the literature [174, 175, 177, 178, 197–200, 262]. In particular, the assessment is carried out jointly by the preoperative team. The attending anaesthetist, who will have perioperative responsibility for the anaesthetic management of the patient, does not personally undertake the preoperative assessment.

Increased system complexity inevitably increases the risk of errors occurring, unless safeguards are specifically built in to detect, and allow correction of, errors. It is now widely recognised that there is a significant incidence of avoidable errors in hospital care [263]. Seeking to mitigate this problem, the medical profession has looked towards high reliability industries, such as aviation and the nuclear industry for methods of reducing avoidable errors. Specific tools adopted from industry which have been extensively used in healthcare include checklists and handover tools. These are specific examples of cognitive artefacts. Nemeth *et al.* describe cognitive artefacts as:

“Objects such as schedules, display boards, lists and worksheets that are used to hold and represent information that is related to states, conditions, dependencies and processes.” [264]

They allow coordination between members of a team to achieve common goals. These may be created *ad hoc* to support established working routines [264], or they may be specifically designed to improve and facilitate processes [265].

There are several examples of checklists being used to successfully improve safety in the perioperative period. For example, the WHO Safer Surgery checklist [266,267] and the Surgical Patient Safety System (SURPASS) [268] which are used in the late pre-operative, perioperative and early postoperative stages of care. Use of such checklists has been shown to improve the surgical process and outcomes on several indicators [269–273].

The purpose of clinical handover is to effectively communicate all significant aspects of a medical situation between individuals when one takes over responsibility from another. Formal handover tools have been adopted for use in a number of medical settings [274,275]. Specifically in the perioperative setting, tools have been described for handover between staff in the postoperative phase between anaesthesia providers and recovery room staff, intensive care staff and ward staff [196,276–278].

It would thus be reasonable to anticipate that strategies which have proven effective in improving handover in other high reliability situations may be adapted to improve communication and handovers noted in the process of preoperative assessment.

8.2 Aims

The work presented here reviews the desirable features of a cognitive aid to facilitate the work of the preoperative assessment team, and their underlying rationale. The construction of a tool which embodies these features is described.

8.3 Method

A number of potential design elements for the cognitive aid were constructed by the author, taking into consideration the required properties of the tool, and aid design principles as detailed in the work presented below. A focus group consisting of five senior anaesthetists was assembled to advise on various design decisions in constructing the aid. A preliminary meeting was held with the participants to outline what the project would entail. Options for the content, display and organisation of information of the cognitive aid, as detailed later, were then presented to each participant in printed format or by email as convenient. Responses were analysed by simple majority voting for binary decisions, or by a ‘single transferable vote’ methodology

for multiple options. The results of voting, and any comments were collated by the author and used, in an iterative fashion, to direct development of the aid to its final form.

8.4 Handover Failures and Mitigation

Handovers are prone to failure [193, 279–281]. Failure of communication during handover is one of the major root causes of these failures [20, 189, 280, 282–284], potentially exposing the patient to harm [285]. In situations involving the handover of medical care between healthcare professionals, a significant root cause of adverse incidents is the failure on the part of the healthcare professional assessing the patient to correctly identify, appreciate the significance of, and effectively communicate adverse patient factors [20, 189, 280, 282–284].

In order to mitigate this, the techniques developed in high reliability industries to minimise errors have been examined to provide guidance [286, 287]. Desirable features of a reliable handover include:

- Accurate, relevant information transmission. Efforts must be made to ensure accurate data collection and effective transmission of significant positive and negative findings
- Error Correction. There should be an opportunity to identify inconsistencies. For example, face-to-face, or at least synchronous communication which would allow readback checks.
- Learning opportunity
- Alignment of goals. Staff may be from different professions, disciplines or seniority. There must be a shared understanding of the goals of the process and how these are to be achieved. Effective communication must be ensured.

High reliability organisations have developed a number of strategies to improve handover quality. In recent years, there have been recommendations to adapt some of these to the medical field [286, 288, 289]

Riesenberg *et al.* [290] reviewed physician handoff literature published between 1987–2008. Although many of the reviewed papers were judged to be of low quality, a number of handover improvement strategies were identified. These included:

- Standardisation of process
- Communication Skills
- Training and Education
- Physical Environment

- Recognised Transfer of Responsibility
- Evaluation of the Process
- Technological Solutions

Robertson *et al.* [291] carried out a similar review of literature related to intrahospital handovers. In this case they analysed studies where an intervention intended to improve handover was investigated. Outcomes examined included efficacy of information transfer, staff and patient satisfaction, protocol compliance, handover duration and clinical outcomes. Interventions were categorised as:

- Person
 - Team training
 - Videoreflexive techniques
 - Medical supervision
- Information Systems
 - Standard Operating Procedures/Protocols
 - Minimum datasets, Checklists
 - Mnemonics
- Wider Systems
 - Information Technology
 - Continuous process improvement

8.5 Aid Features

Given the above considerations, a cognitive aid which facilitates some of these strategies may improve the reliability of the handover processes related to the POAC.

8.5.1 Standardisation

Effective communication can be facilitated by an agreed structure.

Several approaches to presenting clinical information are described in the literature. Commonly used tools include the Subjective-Objective-Assessment-Plan (SOAP) note [292], the Situation-Background-Assessment-Recommendation (SBAR) schema [293] and its derivatives, and several other mnemonic schemes [294]. These schemas, however, are rather generic and may not give adequate guidance to the relatively junior doctors and non-anaesthetists involved in the preoperative assessment. It is recommended

that handover protocols should be tailored to specific disciplines and situations [295]. As discussed earlier (Chapter 2), there is no universally agreed minimum preoperative dataset. However, a dataset acceptable to the local faculty could be identified (Chapter 3)

An approach to standardisation that would be intuitive to most clinicians would be to structure the information elicited by major body systems [296, 297]. This could be tailored to bring to prominence the systems which are of greatest importance in the perioperative period. This type of tool was found to improve handover in a Medical Intensive Care Unit [292], and in simulated crises [297].

The body systems considered to be of particular importance for anaesthesia in the perioperative setting are discussed in Chapter 3, and forms the basis of the structure for the tool being proposed.

8.5.2 Effective Communication

Effective communication requires that the significant positives and negatives in the acquired dataset be highlighted. Any pending unresolved issues should also be transmitted unambiguously, and with minimal extraneous data.

The approach proposed here is to assign each of the major body systems a simple ranking indicative of the degree of impairment determined during the assessment or the potential severity of any unresolved issues. A four level ranking would be adequate for this purpose. This would be analogous to the severity score of the original ASA-PS score, familiar to most anaesthetists.

Following the analogy of ASA-PS, the four level impairment score could be assigned the following significance:

I No impairment

II Mild impairment. Well controlled.

III Significant impairment of function.

IV Severe impairment that is a constant threat to life.

This system would require the clinician using the aid to summarise the information collected from the structured health questionnaire, highlighting possible problems. This process would fulfil the requirement for ‘accurate, relevant information transmission’ proposed by Cohen *et al.* [287] and as implemented, for example, in the Handover Intervention Tool (HAND-IT) proposed by Abraham *et al.* [292]. This would be expected to improve communication between clinicians and significant issues with any major body system would be easily identified.

The Foundation doctor would be directed to assess system functional impairment, or perioperative risk. This would help to align the goals of the Foundation doctor to those of the anaesthesia trained staff. The aid would also function as a decision support tool, by highlighting patients who would

benefit from senior review. For example, a protocol could be established that patients scoring I or II in all systems may proceed to surgery. Patients scoring III would require anaesthesia review and discussion with the clinic or attending anaesthetist. Patients scoring IV in any system would not proceed to surgery unless the issue is resolved, or the impairment explicitly accepted by the attending anaesthetist.

Thus, the tool would fulfil several objectives, acting as a cognitive aid to verify completion of the preoperative assessment, a decision tool to help identify patients needing anaesthesia review, and as a communication tool and *aide-mémoire* for the attending anaesthetist in the perioperative period.

8.6 Aid Format

The author's concept for the overall design of the aids was significantly influenced by two important sources. One was the "Launch Status Check" used in the Apollo space missions to assess readiness for launch, with each system being given a "Go/No Go" status by the flight controllers which is mirrored on the console of the Flight Director by a panel of coloured indicator lights [298]. The other was the augmented reality and Head-up displays which are gaining importance in providing information overlaid on a dynamic display in real time.

The question arises as to how best to design the proposed cognitive aid to achieve the requirements outlined above. The rationale for various options for such a tool are described below. Where there was no strong reason to choose between options, these were presented to the focus group to guide the final form of the tool being proposed.

8.6.1 Visual Representation

It is well established that presenting information in a visual format improves recall. Visual stimuli in the form of graphics have been shown to be superior to word stimuli in many different recognition and recall tasks [299–302]. This is known as the 'Picture Superiority Effect'. This phenomenon translated into improved recall of case details in simulated and clinical handover of oncology patients [303,304]. The use of graphical objects was also found useful in improving situational awareness in the context of multiparameter physiological monitoring [305,306]. The aid being developed will tap into this phenomenon to improve its effectiveness.

For logistical reasons, and for investigative purposes, the initial tool was intended to be paper-based, but constructed to be able to take advantage of digital technologies if eventually moved to a suitable software platform.

The basic structure of the aid is to represent each major body system by a visual element consisting of three components; a label for the body system, a representation of the alert level, and an area for an explanatory note. A basic example of such an element is illustrated in Figure 8.1.

Figure 8.1: Basic Body System Display Element

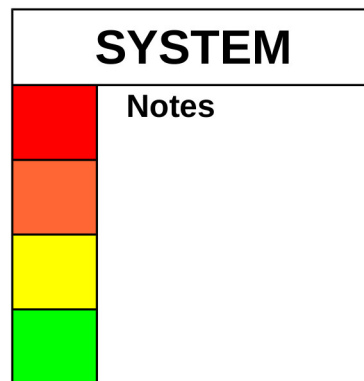

8.6.2 Alert Levels

The four-level ordinal alert classification proposed above (Section 8.5.2) could be represented by a colour-based ‘traffic-light’ system, for example green-yellow-orange-red. A three-level verbal ‘traffic-light’ alert system was studied by McDougall-Davis *et al.* in simulated anaesthesia emergency scenarios [307] and was found to be a superior communication strategy than the SBAR system.

Several possible variations of the basic system element are possible. The focus group was polled to determine which options were considered most acceptable. In the first instance, horizontal or vertical layouts for the ‘traffic-light’ system were considered, as shown in Figure 8.2. The group opted for the vertical layout by a 4:1 split.

Figure 8.2: Orientation of Alert Levels

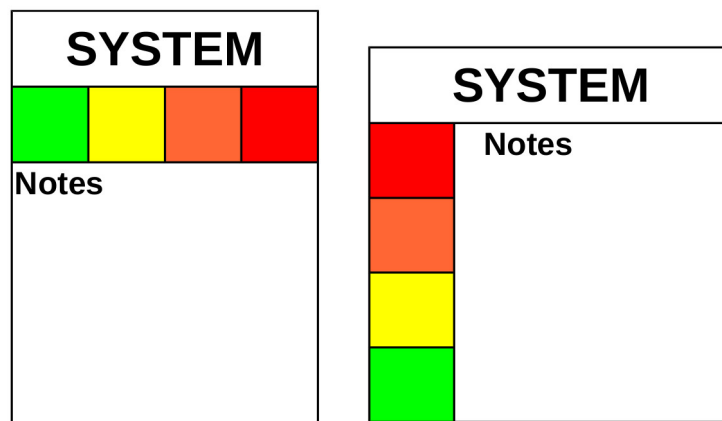

The group was then asked to choose between a ‘red on top’ or ‘green on top’ order for the colours as shown in Figure 8.3. In this case ‘Green on Top’ was preferred, but only by a 3:2 majority.

Figure 8.3: Vertical Display Element Colour Order

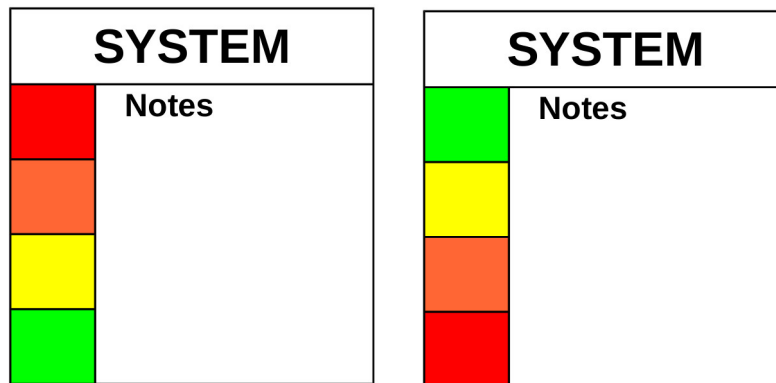

8.6.3 Indicating the Alert Level

Several options were considered to mark the relevant alert level. These are shown in Figure 8.4. Members of the focus group were asked to rank each method in order of preference. The rankings are reported in Table 8.1. Preferences were assessed using a ‘single transferable vote’ system. This process showed the simple marker to be the most popular, closely followed by the side indicator. The focus group was then asked to make a direct comparison between these two options, and again there was a marginal preference for the simple indicator by a 3:2 vote.

Comments made by the participants included that the simple mark and side indicator were the most intuitive to use. The side indicator was considered by one respondent to be easier to correct if the original alert level were to be changed. One respondent felt that, in the absence of written instructions, the centre box made it more clear that the alert-level should be marked.

Table 8.1: Order of Preference for Alert Level Indicator

<i>Marker Type</i>	Respondent				
	A	B	C	D	E
<i>Simple</i>	1	1	2	3	2
<i>CentreBox</i>	3	3	1	2	3
<i>CentreBar</i>	4	4	5	4	4
<i>SideBar</i>	5	5	3	5	5
<i>Side Indicator</i>	2	2	4	1	1

Figure 8.4: Alert Level Markers

Simple Mark

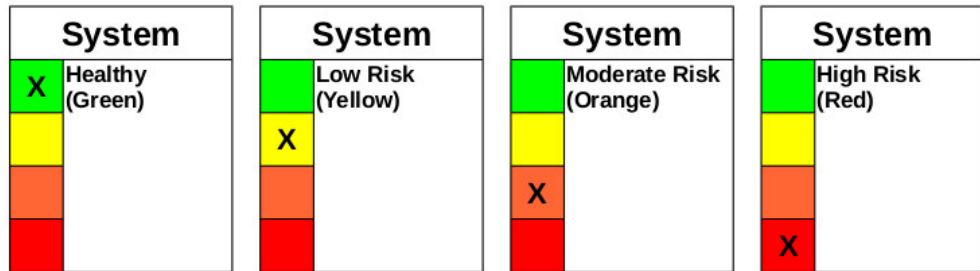

Centre Box

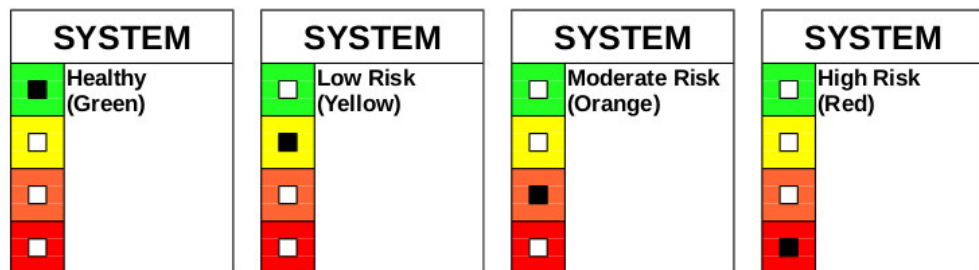

Centre Bar

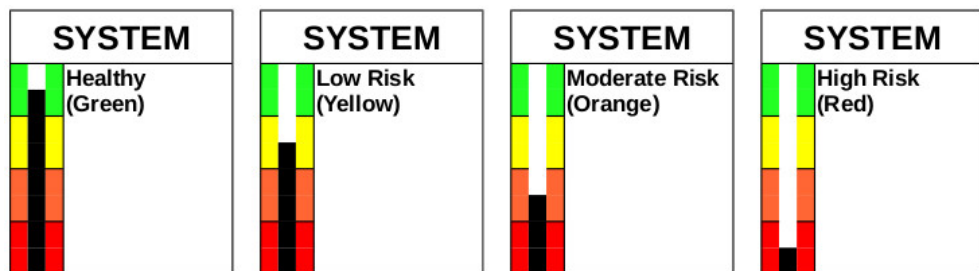

Side Bar

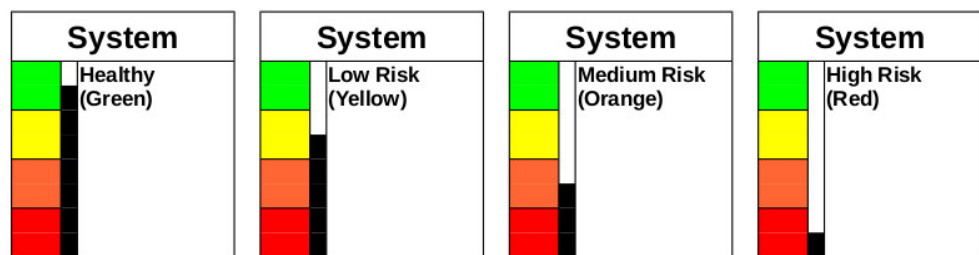

Side Indicator

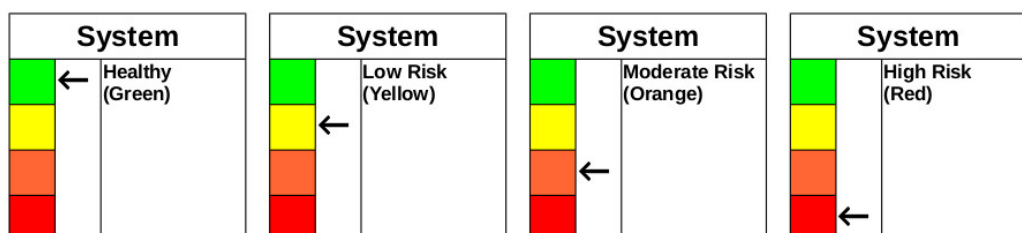

8.6.4 Multiple Domain Layout

The most important domains in the context of the preoperative assessment were discussed in the investigation reported in Chapter 3. The focus group was asked to confirm the importance of including these domains in the aid by rating them on a 5 point scale, with end anchors labelled ‘strongly disagree’ and ‘strongly agree’. The scoring is shown in Table 8.2. All the proposed domains had a median score of four or over. On the basis of this, all were included in the aid being developed.

Table 8.2: Focus Group Assessment of Importance of Domains

<i>Domains</i>	Respondents					Median
	A	B	C	D	E	
<i>Procedure</i>	5	5	5	5	-	5
<i>Alerts</i>	5	5	4	5	5	5
<i>Medications</i>	5	5	5	5	5	5
<i>General/ASA</i>	5	5	4	5	3	5
<i>Cardiovascular</i>	5	5	5	5	5	5
<i>Respiratory</i>	4	5	5	5	5	5
<i>Airway</i>	5	5	5	5	5	5
<i>Gastrointestinal</i>	4	5	3	4	5	4
<i>Renal</i>	4	5	4	5	5	5
<i>Hepatic</i>	4	4	2	4	5	4
<i>Endocrine</i>	5	4	4	-	5	4.5
<i>Metabolic</i>	5	4	3	4	5	4
<i>MusculoSkeletal</i>	4	4	3	4	5	4
<i>Neuro/Psychiatric</i>	4	5	2	4	5	4
<i>Investigations</i>	5	5	5	5	5	5
<i>Pending Issues</i>	4	5	5	5	5	5

A layout of these systems which would be intuitive to many clinicians would be to group the domains by body system, medication history, and special investigations. Several options could be considered to present all these domains visually.

One approach would be to lay out the display elements representing the domains in a simple grid, as shown in Figure 8.5. An alternative, more visually distinctive, layout would be to present the display elements in the form of an annotated body diagram, an example of which is shown in Figure 8.6.

Other options considered were the use of an Aberdeen polygon [305,308] or a display using multi-dimensional plots. However, the number of elements was too great for these to be practical.

Figure 8.5: Cognitive Aid Grid Layout

Name: _____ Age: _____ ID: _____		Date: _____											
Procedure	ALERTS	Rx	General/ASA										
CVS	Respiratory	Airway	GIT										
Hepatic	Renal	Endocrine	Metabolic										
Neuro/Psych	Musculoskel	Haematology											
		Investigations	PENDING										
<table border="1" style="width: 100%; border-collapse: collapse;"> <tr> <th colspan="2" style="text-align: center; padding: 5px;">KEY</th> </tr> <tr> <td style="width: 20px; text-align: center; padding: 5px;"></td> <td style="padding: 5px;">NAD</td> </tr> <tr> <td style="text-align: center; padding: 5px;"></td> <td style="padding: 5px;">Low Risk</td> </tr> <tr> <td style="text-align: center; padding: 5px;"></td> <td style="padding: 5px;">Medium Risk</td> </tr> <tr> <td style="text-align: center; padding: 5px;"></td> <td style="padding: 5px;">High Risk</td> </tr> </table>		KEY			NAD		Low Risk		Medium Risk		High Risk	Doctor: _____ Reg. No: _____ Signature: _____	
KEY													
	NAD												
	Low Risk												
	Medium Risk												
	High Risk												

Figure 8.6: Annotated Diagram Style Display

Name: _____ Age: _____ ID: _____		Date: _____												
Procedure	ALERTS	General/ASA	Rx	Investigations										
Musculoskel	Neuro/Psych			Airway										
		CVS	Respiratory	Haematology										
		Hepatic	GIT											
Metabolic	Renal	Endocrine	PENDING											
<table border="1" style="width: 100%; border-collapse: collapse;"> <tr><th colspan="2" style="text-align: center;">KEY</th></tr> <tr><td style="width: 20px; text-align: center;"></td><td>NAD</td></tr> <tr><td style="text-align: center;"></td><td>Low Risk</td></tr> <tr><td style="text-align: center;"></td><td>Medium Risk</td></tr> <tr><td style="text-align: center;"></td><td>High Risk</td></tr> </table>		KEY			NAD		Low Risk		Medium Risk		High Risk	Doctor: _____ Reg. No: _____ Signature: _____		
KEY														
	NAD													
	Low Risk													
	Medium Risk													
	High Risk													

The participants in the focus group were given an example of each aid type and asked to assess various characteristics of both layouts, related to ease of use and intuitiveness. This was done using a Likert-scale response, with extreme verbal anchors of ‘strongly disagree’ and ‘strongly agree’. Each layout was scored separately by each participants. The two layouts were also directly compared with each other, with the participants indicating their degree of preference on a 5-point scale with ‘Grid’ and ‘Annotated’ as the anchors. The results of this polling are shown in Table 8.3.

Table 8.3: Assessment of Proposed Layouts

<i>Grid Layout</i>	Respondents					Median
	A	B	C	D	E	
<i>The layout is aesthetically pleasing</i>	5	5	5	5	2	5
<i>Information is clearly conveyed</i>	5	5	4	5	3	5
<i>The layout is confusing</i>	1	2	1	2	4	2
<i>It is intuitive to use</i>	5	5	4	4	2	4
<i>It helps me identify issues quickly</i>	5	5	4	3	2	4
<i>It helps me remember important issues</i>	5	5	5	3	3	5
<i>Annotated Layout</i>	Respondents					Median
	A	B	C	D	E	
<i>The layout is aesthetically pleasing</i>	5	5	4	4	5	5
<i>Information is clearly conveyed</i>	4	5	4	4	5	4
<i>The layout is confusing</i>	4	1	2	3	1	2
<i>It is intuitive to use</i>	3	5	4	4	4	4
<i>It helps me identify issues quickly</i>	2	5	5	3	3	3
<i>It helps me remember important issues</i>	3	5	5	3	3	3
<i>Layouts Compared</i> [†]	Respondents					Median
	A	B	C	D	E	
<i>The layout is aesthetically pleasing</i>	4	4	2	2	4	4
<i>Information is clearly conveyed</i>	1	3	3	2	3	3
<i>The layout is confusing</i>	4	2	4	4	1	4
<i>It is intuitive to use</i>	4	4	3	3	5	4
<i>It helps me identify issues quickly</i>	1	3	4	3	4	3
<i>It helps me remember important issues</i>	3	3	3	3	3	3

[†] Lower score favours Grid Layout. Higher score favours Annotated Layout

The focus group members found both layouts to be aesthetically pleasing, but with a small preference for the annotated layout. The grid layout was considered to have some advantage in clarity of presenting the information and, conversely, the annotated layout was considered more likely to be confusing. Paradoxically, the annotated layout was judged to have some advantage in being intuitive to use and identifying issues quickly. The two

layouts were judged equally effective in helping to remember the identified issues.

After some modifications suggested by the focus group, the cognitive aid layouts were finalised. The layouts are reproduced in Appendix D, Figures D.1—D.4.

8.7 Discussion

The basic structure of the aids was determined by the author's design concept as discussed in Section 8.6. The focus group was constrained by the design options proposed by the author and had limited opportunity to present completely new concepts. The option of having a complete “blank page” start and developing the tool through a series of brainstorming sessions may be considered. Assembling and coordinating such a group and directing their efforts would have posed some formidable challenges.

Another criticism is that the decisions for the selection of the system domain elements was essentially subtractive. That is, the group was asked which, if any, domains from a pre-defined set need not be included in the tool. There was no formal route to propose new elements. It should be noted, however, that no informal suggestions for additions were made during the focus group meetings, or at an individual level. Furthermore, the elements proposed for inclusion were determined by a broad basis of literature as discussed in Chapter 2 and their utility was already assessed by a departmental survey as reported in Chapter 3. The focus group recommendations, in effect, confirmed the findings of the dataset survey reported in Chapter 3.

The feedback from the focus group also allowed the development of a display element for each data domain which was acceptable to all members of the group. When considering the cognitive aid as a whole, however, there was no clear preference between the two choices presented.

Before introducing the proposed aids in clinical practice, investigation of their basic properties would be needed. This would provide *prima facie* evidence of usability and efficacy. These issues are addressed in Chapters 9, 10 and 11.

Chapter 9

Cognitive Aid: Consistency of Assessment

9.1 Introduction

As will be elaborated below, the available literature indicates that there may be significant variability in the assessment of a patient's preoperative status. Lack of reliability may result in a healthcare professional failing to correctly identify, appreciate the significance of, and effectively communicate adverse patient factors [20, 189, 280, 282–284].

The cognitive aid proposed in Chapter 8 requires the separate consideration of each body system and other preoperative factors. It is hypothesised that encouraging a structured approach to assessing the relevant body systems and other relevant factors will improve agreement between assessors.

9.2 Aims

The aim of this study was to test the hypothesis that the proposed cognitive aids would improve interrater reliability in assessing the preoperative status of a patient.

9.3 Reliability of Perioperative Risk Assessment

A review of literature pertaining to the variability of estimation of the preoperative status of patients by different assessors was undertaken.

9.3.1 Literature Search

A Pubmed search was carried out using the search terms:

```
((preoperative assessment) AND (anaesthesia OR anesthesia))  
AND (agreement OR concordance OR consistency)
```

OR variability OR reliability)

Titles and abstracts were reviewed to identify articles dealing with the reliability of assessed preoperative risk. Reference lists of retrieved articles were examined for further articles of interest.

9.3.2 Literature Review

As pointed out above, different observers may give a different assessment of a patient's condition. In particular, this may be an issue in the preoperative assessment of patients.

9.3.2.1 Reliability of Clinical Assessment

In an assessment of a preoperative questionnaire Hilditch *et al.* [29] reported moderate to excellent agreement between the self-administered questionnaire as compared to the assessment by an anaesthetist. Similarly, house officers and trained nurses were considered to be equally effective in assessing preoperative patients [199], although the judgement of these practitioners was found to have been inadequate in 15 and 13 % of cases respectively as judged by an anaesthetist. In a similar study of paediatric patient day cases [175], nurses and senior house officers were found to be equally competent, but still failed to identify abnormalities in 28.9 and 32.4% of cases. A further study comparing nurses to anaesthetists [176] found a concordance of 87%.

There may even be considerable variability when considering single aspects of a patient's status. Comparisons of airway assessment by anaesthetists and nurse anaesthetists only found moderate inter-observer reliability [309,310]. A study to estimate cardiac output reserve in a number of clinical vignettes [311] found large variations in the values determined by anaesthetists.

9.3.2.2 Reliability of Preoperative Risk Stratification Tools

A number of preoperative Risk Stratification Tools (RSTs) are in use, and these have been reviewed in Chapter 2 Section 2.5. Several incorporate the ASA-PS as one of the predictors, while others utilise other subjective components. This raises concern regarding inter-observer variability when using these tools.

In order to assess the reliability of ASA-PS scoring, Owens *et al.* [34,312] mailed a series of 10 hypothetical case scenarios to 304 certified anaesthetists, with 235 returns. The authors compared the respondents' assigned ASA-PS to their own rating. They found significant variation in the assigned scores. Mak *et al.* [35] later conducted a similar study using the same scenarios in Hong Kong. They found only fair correlation within groups with similar training practising in similar environments (Cohen's κ between 0.33 and 0.37), and significant disagreement between groups with

different training backgrounds. A further study [313] using the same case scenarios assessed by 151 anaesthetists practising in Australia also found only fair agreement (Cohen's κ of 0.40). Correct identification of ASA-PS class was not associated with age, sex, level of training or training region of the participants.

The discrepancies in assigned ASA-PS were further studied by Haynes and Lawler [36]. Ten hypothetical scenarios were specifically constructed to investigate the differentiation between adjacent ASA-PS classes. These were graded by 97 anaesthetists (FRCA or equivalent) and trainees. This study found significant variation in assigned ASA-PS. It was also found that, in some cases, practitioners with less clinical experience may assign a lower ASA-PS. Another study carried out in Finland [314], using the Haynes and Lawler case scenarios also found wide variation in ASA-PS assigned by 108 of 249 surveyed anaesthetists who responded. In this case there was no distinction between specialists and trainees. Variability of ASA-PS scoring was also investigated by Aronson *et al.* [37] using 8 scenarios adapted from Haynes and Lawler [36] and 2 novel cases. The scenarios were assessed by 70 practitioners. The authors reported poor interrater reliability. They also found that the scores were not influenced by professional background (anaesthesiologist vs CRNA), military or non-military status or years of practice. De Cassai *et al.* [315] also investigated ASA-PS variability using a series of hypothetical cases, designed to be clearly in a particular ASA-PS class. The questionnaire was circulated online to a cohort of 4901 Italian anaesthetists. There were 601 usable returns. Responses were compared to the author-assigned 'correct' ASA-PS. They found that trainees and less experienced specialists had a higher number of 'correct' answers, possibly due to closer adherence to the formal ASA-PS definitions. Overall, there was fair interrater reliability within cohorts of anaesthetists with similar experience (Fleiss's κ between 0.36 and 0.41). In another study using 20 hypothetical cases [316], it was found that non-anaesthesia professionals tend to give a lower ASA-PS estimate than anaesthetists.

In contrast to these studies, Ihejirika *et al.* [317] investigating ASA-PS reliability in a series of case scenarios restricted to orthopaedic trauma found moderate interrater reliability for both specialist and trainee anaesthetists as measured by Fleiss' κ ($\kappa = 0.55$), and substantial agreement as compared to the reference assigned ASA-PS with both Fleiss' and Cohen's weighted κ . In a similar study [318] using 8 hypothetical polytrauma cases assessed by trauma surgeons and anaesthetists, there was moderate rater-reference reliability and fair interrater reliability. Shichino *et al.* [319] investigated ASA-PS assignment reliability using a set of scenarios restricted to hypothetical gastrointestinal emergencies, based on true case histories. They also found much better concordance than reported for unrestricted surgical cases. On the 50 responding anaesthetists, there was 66-90% agreement in ASA-PS, with a Fleiss' κ of 0.55 and an interclass correlation coefficient of 0.79.

The reliability of assigned ASA-PS was further studied in clinical prac-

tice. In a multicentre study carried out in France [320], the ASA-PS assigned by the patients' caring physician was compared to that assigned by another anaesthetist from a separate institute who reviewed the case history. In all, 1357 cases were reviewed. Moderate concordance was found (Cohen's weighted κ 0.53). Patients with obesity, allergy, sleep apnoea, obstructive pulmonary disease, renal insufficiency and hypertension were most likely to have discrepancies in assigned ASA-PS.

In another case series of 200 patients assessed by anaesthetists at a preoperative assessment clinic [321], 181 were referred to other specialities for further evaluation. Of these, 172 were assigned an ASA-PS by both specialists. Concordance as measured by κ test was 0.645.

Sankar *et al.* [322] studied the concordance between the ASA-PS assigned by anaesthetists at preoperative assessment with the score from the perioperative attending anaesthetist. Using a cohort of 10,864 adult patients, they reported moderate reliability ($\kappa = 0.61$). They further demonstrated moderate correlations between ASA-PS and patient age, Charlson's comorbidity index, revised cardiac risk index and hospital length of stay.

In a study of 101 elderly patients (≥ 65 years) undergoing total hip or total knee replacements [323], the ASA-PS assigned by an internal medicine specialist, the preoperative assessment clinic anaesthesia practitioner, and the perioperative attending anaesthesia practitioner were compared. There was poor agreement between the internal medicine specialist and both groups of anaesthesia practitioners (κ of 0.170 and 0.156), while there was very good agreement between the two anaesthesia practitioner groups ($\kappa = 0.863$).

As reviewed in Chapter 2 Section 2.5, several other RSTs have been described and validated. None of these scores appear to have been subjected to the level of scrutiny for interrater reliability as the ASA-PS. However, the Surgical Risk Scale, Surgical Risk Score and ACS NSQIP Universal Surgical Risk Calculator all include the ASA-PS as part of their construct. It would therefore seem likely that they would be subject to similar issues of interrater variability. Some elements of the Charlson Index, the Charlson Age Comorbidity Index (CACI), the Revised Cardiac Risk Index (RCRI), the Surgical Outcome Risk Tool (SORT) and the ACS NSQIP Universal Surgical Risk Calculator also depend on subjective assessor judgement, and so their interrater reliability may warrant further investigation.

9.4 Method

Participants were invited from a cohort of specialist anaesthetists, trainee anaesthetists and foundation programme doctors working in surgical specialities. Each participant was asked to review a series of ten clinical vignettes. These clinical scenarios were those published by Owens [34] (Section 9.3.2). For each case, the participants were asked to complete one of the two forms of the cognitive aids (Annotated or Grid) proposed in Chapter 8 and reproduced in Appendix D. The aid type used for a particular case scenario was assigned at random for each participant, but ensuring that an

equal number of grid and annotated formats were used by each participant. After an interval of 2 to 6 weeks, each participant re-assessed the same ten cases, but using the alternate tool for every vignette. That is, if in the first phase of the experiment, a respondent assessed a particular case using a 'Grid' layout, on the second cycle the 'Annotated' layout was used for that case, and vice versa.

The scores assigned for the functional status of each system of each case were determined from the returned forms. For analysis purposes, the level of impairment of each system was coded on a scale of 1 to 4, corresponding to the 'traffic-light' colours (green, yellow, orange, red) used in the cognitive aid. The collected data were analysed using the R statistical software package (version 3.1.2) [168] with the 'MASS' package [324] for Ordinal Linear Regression (OLR) modelling and the 'irr' package [325] to calculate interrater reliability.

The influence of anaesthetic training and aid type on preoperative status assessment was analysed by OLR modelling. Functional score distributions were displayed as frequency tables and graphically, and compared with χ^2 test. Test-retest stability for each participant was assessed using Cohen's weighted κ . Test-retest stability between anaesthetists and FY doctors was compared using Student's t . Interrater reliability was assessed using Light's procedure [326] with Cohen's weighted κ and ANOVA to assess the influence of training background.

After completing the ten cases, participants were asked to fill in a questionnaire to determine user satisfaction with the aids. This questionnaire and the findings are discussed in Chapter 11.

9.5 Results and Analysis

A total of 19 participants enrolled in the study; nine foundation programme doctors and ten anaesthetists or anaesthesia trainees. Two foundation doctors dropped out after completion of the first phase and failed to complete the second phase of the study.

9.5.1 Ordinal Linear Regression Model

In order to investigate the influence of an anaesthetic training background, or the type of aid used (annotated or grid), an OLR model was constructed, using these two parameters as predictors. The model coefficients are given in Table 9.1.

The influence of the aid type had no statistical significance, but anaesthesia training had a highly significant effect. This was explored further. Another OLR model was set up, using only anaesthesia training as a predictor. The coefficients are shown in Table 9.2. The predicted percentages for each functional class for each group of respondents using the latter model are shown in Table 9.3.

Table 9.1: Ordinal Linear Regression Model - Anaesthetic Training and Aid Format as Explanatory Variables

	Coef.	s.e.	t	p
Aid: Grid Annotated	-0.013	0.051	-0.260	0.7945
Training: Anaes FY	-0.406	0.051	-7.891	3.008e-15
1 2	-0.140	0.043	-3.262	0.001106
2 3	0.640	0.044	14.607	2.541e-48
3 4	1.805	0.052	34.763	8.875e-265

Table 9.2: Ordinal Linear Regression - Anaesthesia Training as Explanatory Variable

	Coef.	s.e.	t	p
Training: Anaes FY	-0.406	0.051	-7.891	2.996e-15
1 2	-0.133	0.035	-3.835	0.0001255
2 3	0.646	0.036	18.003	1.849e-72
3 4	1.811	0.045	39.821	0

Table 9.3: System Functional Scores Predicted Distribution (%)

	Functional Score			
	1	2	3	4
<i>Anaes</i>	46.7	18.9	20.3	14.0
<i>FY</i>	56.8	17.3	16.1	9.8

9.5.2 System Functional Scores

The coded system functional scores given by the two groups of assessors are shown in Table 9.4. The distributions are also shown graphically in Figure 9.1.

Table 9.4: Actual System Functional Scores Distribution

	Functional Scores							
	1		2		3		4	
	n	%	n	%	n	%	n	%
<i>Anaes</i>	1495	47.3	565	17.9	638	20.2	464	14.7
<i>FY</i>	1330	56.1	445	18.8	383	16.2	212	8.9
$\chi^2=69.56$ $df=3$ $p=5.30118e-15$								

Figure 9.1: System Functional Score Distribution

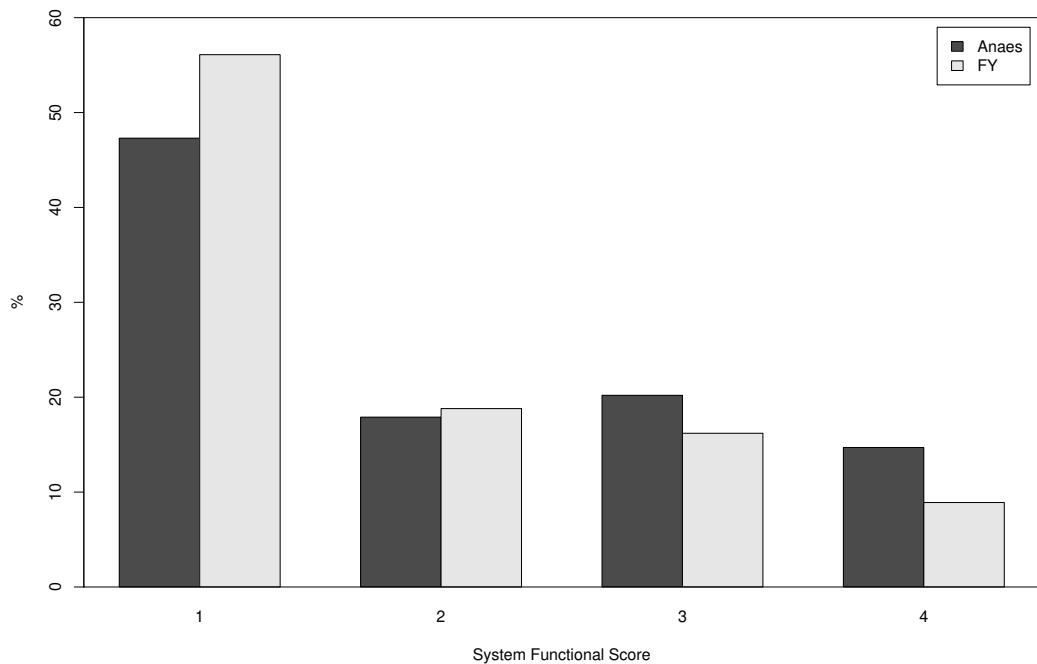

The distributions were compared with χ^2 -test and a statistically highly significant difference was found. Compared to the anaesthetists and anaesthetic trainees, FY doctors tend to report more systems in category 1 (normal function) and less in categories 3 and 4 (moderate to severe impairment).

9.5.3 Test-retest Stability

In order to examine test-retest stability, the functional status scores given by each participant in the first phase of the trial were compared to those given in the second phase using Cohen's weighted κ [327, 328] with uniform weighting. The κ values obtained are shown in Table 9.5. Values range from 0.442-0.763 indicating moderate to good test-retest stability [329]. Comparison of the FY and anaesthetists' κ scores showed no significant difference.

Table 9.5: Test-Retest Weighted Cohen's κ

Respondent	κ
<i>Foundation Doctor</i>	
1	0.763
9 [†]	-
11 [†]	-
13	0.540
15	0.490
16	0.651
17	0.636
22	0.691
23	0.473
<i>Anaesthetist</i>	
2	0.646
3	0.349
4	0.669
5	0.608
6	0.751
7	0.442
8	0.668
10	0.644
18	0.579
20	0.626
Student's t: FY vs Anaes. t=0.15 df=14 p=0.886	

[†] Did not complete second phases of trial

9.5.4 Interrater Reliability

It was desired to explore the concordance of the system functional scores assigned by the participants in this trial. This is a common requirement in investigating the validity of various assessment tools [330]. The classic Cohen's κ can only test concordance between two raters. Methods have been developed to cater for several ($n > 2$) raters [330, 331]. Fleiss [332] developed an extension of Cohen's κ to cater for three or more raters, but this method does not take into account the weighting of discrepancies between assessments. An alternative approach was suggested by Light [326], where

a κ statistic is calculated for all possible combinations of paired raters and then the means can be calculated and analysed using standard statistical methods. Weighted κ can be used in this approach. This technique was applied in the present analysis. For all pairs of raters Cohen's weighted κ was calculated. Mean κ values for Anaesthesia-Anaesthesia (AA), Foundation-Foundation (FF) and Anaesthesia-Foundation (AF) concordances were calculated. These are reported in Table 9.6. Analysis of Variance was performed (see Table 9.7). The ANOVA just failed to reach significance at the $p=0.05$ level.

Table 9.6: Interrater Reliability: Mean Cohen's Weighted κ

	n	$\bar{\kappa}$
Anaes Anaes	45	0.514
Anaes FY	90	0.490
FY FY	36	0.531

Table 9.7: ANOVA: Cohen's κ by Group-Group Comparison

	Df	Sum Sq	Mean Sq	F value	Pr(>F)
Group Group	2	0.0472	0.0236	2.8256	0.0621
Residuals	168	1.4040	0.0084		

9.6 Discussion

The study presented here consisted of a paper-based exercise in patient impairment classification using the cognitive aids under study. The case scenarios chosen for this study were those constructed by Owens [34] in his investigation of ASA-PS scoring. They have been used by other researchers in a number of similar studies [35, 313], and were selected in part to allow comparison with the results of these studies. However, the original study was performed over 40 years ago, and some of the case scenarios may not reflect current practice, particularly with respect to preoperative management and proposed surgery. This, however, should not have had an impact on the level of impairment assessment by the participants in the current study relative to each other. However, external validation of this study may warrant the construction of an updated set of case scenarios.

As the author is a senior member of the Anaesthetic Department, there was concern about a possible effect of the hierarchical status of the author with respect to participants from the Department. In order to mitigate this influence, arrangements were made for the questionnaires to be returned through a third party to maintain anonymity. While the relationship may have motivated these participants to complete the study, it seems unlikely that it would have impacted the phenomena under investigation. It is likely that there would have been even less effect on the FYs participating, as

these were not members of the Department. However, any influence would have similarly been mitigated by the collection arrangements for the questionnaires.

The study presented here identified a statistically significant difference in the estimates of body system impairment given by FY doctors as compared to respondents with training in anaesthesia. This finding is in keeping with various studies where the degree of impairment reported by non-anaesthetists was less than that reported by anaesthetists [175, 199]. Similarly, several studies specifically looking at assignment of ASA-PS in various circumstances [315, 316, 323] show a tendency for non-anaesthetists to report lower values. Although others have reported moderate concordance between anaesthetists and non-anaesthetists [320, 321], the presence of various comorbidities was found to increase the likelihood of discordant assessment [320]. This under-estimation of patient impairment may be one of the factors contributing to the failure to identify problems, which is a recurrent contributory issue in anaesthesia-related incidents [20].

In spite of the findings noted above, the κ values for interrater reliability obtained in this study (Section 9.5.4) were somewhat better than those reported by Owens *et al.* [34], Mak *et al.* [35] and Riley *et al.* [313] when assessing the ASA-PS for the same case scenarios. This finding supports the hypothesis that assessing a patient on a system-by-system basis will improve interrater reliability. By directing the structured, explicit assessment of the various body systems, and related perioperative factors, the proposed cognitive aid will help improve assessor reliability. It does not, however, address all the sources of interrater variability.

The insights provided by training in anaesthesia may make an assessor more sensitive to the implications of identified comorbidities in the perioperative period. Developing specific training for non-anaesthetists in the field of preoperative assessment and investigating the impact on the reliability of preoperative assessment may be a useful area for further investigation.

Chapter 10

Cognitive Aid: Effect on Situational Awareness

10.1 Introduction

Situational Awareness (SA) has been defined as:

The perception of the elements in the environment within a volume of space and time, the comprehension of their meaning and a projection of their status in the near future [333]

SA is considered an essential component of the non-technical skills required by anaesthetists to manage both routine events and critical incidents in the perioperative period [334–336]. A handover document may be considered to be a tool to assist the development of situational awareness, in that it is intended to provide a summary of the situation at the time that the recipient is taking over responsibility. The documentation produced at the preoperative assessment is, in effect, a handover tool. It provides the attending anaesthetist with details of the base state of the patient about to undergo anaesthesia. As discussed in Chapter 8, Section 8.4, it is desirable that a handover tool should highlight pertinent data and make it readily accessible and memorable to the recipient, thus enhancing the recipient's situational awareness of the ongoing scenario.

10.2 Aims

It is hypothesised that the cognitive aids proposed in Chapter 8 would improve the development of situational awareness of the attending anaesthetist in a clinical scenario.

The aim of the present study, was to measure the effect of the cognitive aids on situational awareness.

10.3 Preoperative Handover as a Component of Situational Awareness

Situational awareness is one of the cornerstones of safe practice in a high-risk environment [335, 336]. Familiarity with a patient's preoperative condition would clearly be a major component of an anaesthetist's grasp of the situation in theatre at any given moment, and would influence both the routine management of the case, and the ability to cope effectively with any untoward events.

Situational Awareness has been classified into 3 levels [333]:

Level 1 Perception of Elements in the Environment

Level 2 Comprehension of the Current Situation

Level 3 Projection of Future Status

To put it more succinctly, these represent perception, comprehension and projection [337]. Familiarity with the patient's relevant preoperative clinical findings would correspond to Level 1 Situation Awareness. This allows the development of a mental construct of the patient's basal condition and physiological status (Level 2 Situation Awareness) and the prediction of likely responses to the planned surgery and anaesthesia interventions (Level 3 Situation Awareness). It will also constitute the background against which any variation from the expected perioperative trajectory can be assessed and corrective action taken.

It follows that the information collected during the preoperative assessment must be effectively transmitted to the attending anaesthetist. However, as Endsley noted [337]:

“More data does not equal more information”

It is recognised that the methods used to present and highlight data can influence situational awareness [306, 308, 338–340]. In the interview study presented in Chapter 4, some interviewees commented that the preoperative assessment questionnaire was “too busy”, indicating that it is not easy to rapidly extract relevant information from it. One of the design intentions of the proposed cognitive aids (see Chapter 8 and Appendix D) is to improve communication between the preoperative assessment team and the attending anaesthetist. It would therefore be of value to determine whether they influence the situational awareness of the attending anaesthetist.

10.4 Measuring Situational Awareness

Several techniques have been developed to measure SA. Endsley and Jones [341] have classified them as outlined in Table 10.1. Some of these techniques have been adapted for use in various medical fields [334, 339, 340, 342, 343].

Table 10.1: Measures of Situational Awareness

-
- Indirect Measures
 - Process Measures (eg. Eye Tracking, Communications Analysis, Verbal Protocol, Psychophysiological Measures,)
 - Performance Measures (eg. Response Time, Errors)
 - Behavioural Assessment
 - Direct Measures
 - Subjective (eg. SART)
 - Objective (eg SAGAT, SPAM)
-

10.4.1 Indirect Measures of Situational Awareness

Indirect measures of SA are based on the assumption that a number of observable parameters are influenced by SA. These may be classified as process measures, performance measure and behavioural techniques.

Process measures assume that various observable parameters, such as psychophysiological variables (eg. EEG, ECG) and gaze direction are influenced by the internal state of SA. These techniques often involve cumbersome equipment to measure the required parameters. Analysis of real-time communication, or specific verbal “think-aloud” protocols, may give an insight to the state of SA. The validity of these measures has been questioned [341,344], as the measured parameters may be influenced by other factors apart from SA.

Performance measures may also provide an indirect measure of situational awareness [341,344]. The overall success in completing a task depends to some extent on the subject’s situational awareness. However, this is only one component of the factors contributing to successful task completion, and there may be many other confounding variables. Global performance, in particular, is a very crude tool, as it is difficult to identify specific factors which may have contributed to any errors. Monitoring of various sub-tasks, using measures such as time-on-task and error rates may be more informative in this regard [339].

An alternative approach is for an observer to rate the degree of situational awareness based on observed actions of the the subject which are assumed to correlate with SA, using domain-specific constructs. In medical settings, this approach has been successfully used, for example, in assessing the SA component of the Anaesthetists’ Non-technical Skills

(ANTS) [335,336] and Non-Technical Skills for Surgeons (NOTSS) [345,346] behavioural marker systems.

10.4.2 Direct Measures of Situational Awareness

Direct measures of situational awareness may be subjective or objective.

In subjective methods, the level of situational awareness may be self-rated or rated by an observer. An example of a self-rated measure is the Situation Awareness Rating Technique (SART) [347] (cited in [339]) [341,348]. With this tool, the subject rates SA on ten generic constructs. Self-rating is clearly susceptible to bias as the subject may not realise that he lacked situational awareness. It may be more of a measure of the subject's self-confidence [344]. An alternative approach is for an observer to rate the degree of situational awareness. The observer must use clues from the subject's actions to try and ascertain the subject's level of perception and comprehension of the situation, usually using domain-specific templates. Due to the difficulty of an external observer inducing the subject's internal state of SA, these methods may be more properly considered indirect methods and have been discussed above.

Objective measures directly query the subject on various elements of the scenario. These may be applied in real time while a scenario is ongoing, using a freeze technique during the scenario, or questions may be posed post-test. Post-test questionnaires are least intrusive, but may be biased by fading of short-term memory and the eventual outcome of the scenario.

The Situation Present Assessment Method (SPAM) [349] is an example of an assessment conducted in a running scenario. The subject is free to extract information from the scenario environment to answer queries, minimising the influence of short-term memory effects. The degree of SA is assessed on the response latency. However, questions posed in real time during a running scenario may impose a further cognitive load on the subject. They may also sensitize the subject to various elements of the scenario which would not have been otherwise noticed.

Situation Awareness Global Assessment Technique (SAGAT) [344,350] is an example of the freeze-technique. A running simulation is temporarily halted at random intervals and any display screens are blanked. The subject is asked probe questions related to the state of the scenario. SA is assessed by the accuracy of the replies. This addresses the cognitive impact of the real-time techniques, but concerns were raised that the technique leads to less realism in the scenario. In practice, however, the scenario freeze does not appear to impact outcomes [350]. In some variants, such as Situation Awareness Verification and Analysis Tool (SAVANT) [351] also use the elapse of time to answer in scoring SA

10.5 Method

It is common practice for the attending anaesthetist to review the preoperative clerking documentation to form a mental construct of the clinical status of the patient. During the conduct of anaesthesia, various decisions may be effected by the knowledge of the patient's preoperative condition. The anaesthetist would then utilise his SA from working memory, possibly supplemented by referring back to the case documents, to decide on the best course of action. For the purposes of this study, it was desired to simulate this work practice.

A website was constructed to perform the functions described below. It was written using the PHP scripting language [352] on an Apache web server [353] running on the Linux Operating System. All data were captured in a PostgreSQL database [354] for later analysis.

Three clinical cases were developed, with an associated set of twelve questions designed to assess various levels of SA. The case histories and questions are reproduced in Appendix E. All participants were presented with the same cases and questions. The three case histories were presented in a style closely matching the standard preoperative documentation in current use at the hospital preoperative clinic. In addition, one case selected at random for each participant was also presented with the 'annotated' cognitive aid, as the first page of the documentation. A second case was presented with the 'grid' cognitive aid. The aids are described in Chapter 8 and Appendix D. Once they had familiarised themselves with the each case, participants were then presented with questions regarding clinical findings, interpretation and management. While answering the questions, participants were allowed to refer back to the casenotes if so desired. For each participant, the time initially spent reviewing the case history, the time to respond to each question, the response given, the number of times they referred back to the case history and the duration of each such review were recorded in the database.

Once all three cases were completed, participants were asked to fill in an online questionnaire to assess the utility of the cognitive aids.

All the clinical members of the Department of Anaesthesia at Mater Dei Hospital, Malta, were sent an email explaining the nature and purpose of the study and inviting participation. Participants were directed by a hyperlink with a unique, anonymised key to the website described above. After reading an introduction further explaining the purpose of the trial, and indicating consent, each participant proceeded to review the case histories and answer the questions as described.

The data collected from the case reviews was analysed using the R statistical software package (version 3.1.2) [168]. Frequency data were presented in contingency tables and analysed with χ^2 or the Cochran-Mantel-Haenszel test as appropriate. Means for the various timing values are displayed in 2-way tables and analysed using ANOVA. Significant results at $p < 0.05$ were further analysed using Tukey's *post hoc* analysis.

The questionnaire regarding the utility of the aid and the findings are presented in Chapter 11.

The study was approved by the Institutional Ethics Review Board.

10.6 Results and Analysis

A total of 94 anaesthetists were invited to participate in the trial. After two sets of email reminders to encourage participation, 42 invitees visited the website and 32 completed all stages of the trial. Only these 32 returns were analysed further.

The number of returns for each patient and chart type are shown in Table 10.2.

χ^2 test indicates an unexpectedly uneven distribution, with relatively few examples Case 2 using the ‘grid’ representation. This may be a source of bias in interpreting later results.

Table 10.2: Frequency of Chart type by Case

<i>Chart</i>	Case		
	1	2	3
<i>Plain</i>	11	13	8
<i>Grid</i>	12	4	16
<i>Annotated</i>	9	15	8
$\chi^2=10.88$ df=4 p=0.028			

10.6.1 Initial Chart Review Time

The Initial Review Time was taken as the time that was spent reviewing the preoperative clerking charts prior to attempting the associated questions. The mean values for this initial review time, for each chart type and patient combination, are shown in Table 10.3. Analysis of Variance (Table 10.4) showed that neither of the cognitive aids, nor their absence, had an impact on the initial review time. There was also no significant difference between the three case histories.

Table 10.3: Mean Initial Review Time by Chart Type and Case

<i>Chart</i>	Case			mean
	1	2	3	
<i>Plain</i>	103.87	156.93	87.64	121.97
<i>Grid</i>	154.93	192.58	105.46	134.23
<i>Annotated</i>	134.15	166.59	148.00	152.52
<i>mean</i>	133.66	165.28	110.81	136.62

Table 10.4: ANOVA: Initial Review Time by Chart Type and Case

	Df	Sum Sq	Mean Sq	F value	Pr(>F)
<i>Case</i>	2	43386.54	21693.27	1.41	0.25
<i>Chart Type</i>	2	14811.60	7405.80	0.48	0.62
<i>Case:Chart Type</i>	4	14743.55	3685.89	0.24	0.91
<i>Residuals</i>	77	1182651.88	15359.12		

10.6.2 Accuracy

The number of correct and incorrect answers for each chart type for the questions at the three situational awareness levels are given in Table 10.5. Analysis using the Cochran-Mantel-Haenszel test showed that there was no significant difference in accuracy of responses between the chart types for any level of situational awareness.

Table 10.5: Correct Answers by Chart Type and SA Level

<i>Chart</i>	SA Level	Incorrect		Correct	
		n	%	n	%
<i>Plain</i>	1	15	10	133	90
	2	19	15	112	85
	3	17	16	88	84
<i>Grid</i>	1	12	8	148	93
	2	20	16	104	84
	3	17	17	83	83
<i>Annotated</i>	1	14	10	126	90
	2	16	12	113	88
	3	12	10	103	90

Cochran-Mantel-Haenszel test
 $M^2 = 1.2465, df = 2, p = 0.5362$

10.6.3 Response Time

The mean times taken to answer the questions of varying situational awareness levels are given in Table 10.6. The response time was taken to include any time spent returning to the patient clerking documentation. Analysis of Variance (see Table 10.7) demonstrated that response time was significantly influenced by situational awareness level, but not by chart type. Tukey's test for *post hoc* analysis shows a significant difference at $p=0.05$ level between level 1 and level 2 and level 1 and level 3, but not between level 2 and level 3. Level 1 questions were answered more rapidly than level 2 and level 3 questions.

Table 10.6: Mean Response Time by Chart Type and SA Level

<i>Chart</i>	SA Level			mean
	1	2	3	
<i>Plain</i>	11.65	13.23	17.40	13.77
<i>Grid</i>	10.66	17.37	11.59	13.03
<i>Annotated</i>	13.59	16.57	18.04	15.92
<i>mean</i>	11.91	15.69	15.84	14.25

Table 10.7: ANOVA: Response Time by Chart Type and SA Level

	Df	Sum Sq	Mean Sq	F value	Pr(>F)
<i>Chart Type</i>	2	1718.20	859.10	2.07	0.13
<i>SA Level</i>	2	3806.06	1903.03	4.58	0.01
<i>Chart Type:SA Level</i>	4	2944.21	736.05	1.77	0.13
<i>Residuals</i>	1129	469221.13	415.61		

10.6.4 Chart Reviews

The number of times the clerking notes were reviewed while answering questions was analysed. As there were only a few occasions where the chart was reviewed more than once, analysis was only performed on whether or not any chart reviews were undertaken. The occurrence of chart reviews stratified by chart type and SA level are shown in Table 10.8. Cochran-Mantel-Haenszel analysis showed no significant differences in chart review frequency, indicating that the aids do not reduce the need to refer back to the charts. The number of correct and incorrect responses stratified by chart type and occurrence of chart reviews are given in Table 10.9. Cochran-Mantel-Haenszel analysis showed no significant difference.

Table 10.8: Chart Reviews by Chart Type and SA Level

<i>Chart</i>	SA Level	No Review		Reviewed	
		n	%	n	%
<i>Plain</i>	1	100	68	48	32
	2	96	73	35	27
	3	83	79	22	21
<i>Grid</i>	1	104	65	56	35
	2	82	66	42	34
	3	85	85	15	15
<i>Annotated</i>	1	103	74	37	26
	2	90	70	39	30
	3	83	72	32	28

Cochran-Mantel-Haenszel test

$M^2 = 0.355, df = 2, p = 0.8373$

The mean time taken to review the charts in those cases where a review was necessary was analysed. The mean review times stratified by chart type

Table 10.9: Number of Correct Responses by Chart Type and Chart Review

<i>Chart</i>	Review	Incorrect		Correct	
		n	%	n	%
<i>Plain</i>	No	37	13	242	87
	Yes	14	13	91	87
<i>Grid</i>	No	37	14	234	86
	Yes	12	11	101	89
<i>Annotated</i>	No	27	10	249	90
	Yes	15	14	93	86

Cochran-Mantel-Haenszel test
 $M^2 = 0.419, df = 2, p = 0.811$

and SA level are given in Table 10.10. Analysis of variance (Table 10.11) demonstrated no significant influence of chart type or SA level.

Table 10.10: Mean Review Time by Chart Type and SA Level

<i>Chart</i>	SA Level			mean
	1	2	3	
<i>Plain</i>	29.95	24.20	35.22	29.14
<i>Grid</i>	11.05	40.40	27.44	24.13
<i>Annotated</i>	22.97	34.44	22.31	26.91
<i>mean</i>	20.61	33.51	27.54	26.67

Table 10.11: ANOVA: Review Time by Chart Type and SA Level

	Df	Sum Sq	Mean Sq	F value	Pr(>F)
<i>Chart Type</i>	2	1371.96	685.98	0.26	0.77
<i>SA Level</i>	2	10657.52	5328.76	2.02	0.13
<i>Chart Type:SA Level</i>	4	15372.25	3843.06	1.45	0.22
<i>Residuals</i>	317	838190.95	2644.14		

10.7 Discussion

The web-based application developed to assess the influence of the cognitive aids on SA was based on principles used in established SA measurement tools such as SPAM, using both response latency and accuracy of responses as objective measures. Thus, although the tool was developed for this specific study, it is based on tools which have been shown to be effective in other contexts.

Using a web-based application to determine response times raised some concern as to whether there may be inaccuracy due to network latency effects. Informal tests indicated that any such errors were unlikely to be

greater than a few hundred milliseconds, and so would only add a small, random, error to the times being assessed. On the other hand, allowing participants to undertake the test at a time and place of their choosing was a major logistical advantage.

The failure to detect an effect of the cognitive aids raises concern as to whether the tool was effective in measuring SA. It is noted, however, that the influence of SA level was detectable. This gives some confidence that it was able to measure SA.

Under the conditions of this study, the use of the cognitive aid did not confer any advantage when compared with the unaugmented case histories. Although the aids did not confer any advantage as regards accuracy of response, spontaneous recall or response time, neither did they lead to a significant increase in time spent reviewing the case notes.

These findings are in contrast to the advantages which have been demonstrated in the use of graphical or pictorial displays of clinical information in various settings, as was discussed in Chapter 8, Sections 8.5 and 8.6. This may be due to the fact that the participants would have been very familiar with the unaided clerking format, as this mimicked the standard preoperative clinic clerking document in current use. Thus, the aids would have given little advantage over the plain document. The time interval between reviewing the documentation and answering the probe questions was short, limiting any impact the aids would have on memory retention. Also, there were no competing cognitive tasks, as would likely be the case in a real theatre scenario or crisis management situation.

Determining if the aids would offer any objective improvement in performance in a real or simulated theatre scenario or crisis situation may be an interesting area for future investigation.

Chapter 11

Cognitive Aid: User Satisfaction

11.1 Introduction

The usability of a tool may be assessed in terms of effectiveness, efficiency and user satisfaction [355]. Methods for measuring these parameters in the context of a general user interface have been discussed in several reviews [356–358]. Approaches to the specific case of handover tools were surveyed by Abraham *et al.* [359].

Investigation of aspects of effectiveness and efficacy of the cognitive aids under consideration (see Chapter 8 and Appendix D) are described in Chapters 9 and 10.

Consideration of user satisfaction with the aids would also be of value. In the first instance, subjective assessment of various properties of the tool may allow access to parameters which may be difficult to measure objectively. Furthermore, a tool which is found to be acceptable to its users would be more likely to be integrated into clinical practice [165]. This would be a consideration in the eventual deployment of the aid.

11.2 Aim

The aim of this survey was to determine subjective user satisfaction with the cognitive aids under investigation in terms of usability, efficacy and efficiency.

11.3 Measuring User Satisfaction

User satisfaction has been defined as the:

extent to which the user's physical, cognitive and emotional responses that result from the use of a system, product or service meet the user's needs and expectations. [355]

Abraham *et al.* [359] undertook a systematic literature review on the evaluation of handoff tools. In 19 of the 36 articles reviewed, some facet of user satisfaction was assessed. These included assessments of quality of care, tool efficiency, completeness of information, accuracy, patient safety and overall staff satisfaction.

For the purpose of investigating user satisfaction with the proposed aids, it was desired to assess subjective perceptions of usability, efficacy and efficiency. To this end, the following bank of statements was developed:

1. The layout is aesthetically pleasing
2. Information is clearly conveyed
3. The layout is confusing
4. It is user friendly
5. It helps me identify issues quickly
6. It helps me remember important issues

Items 1 and 4 were included as general indicators of usability. Items 2, 3 and 6 would act as measures of effectiveness in conveying information. Item 5 would be a measure of efficiency.

11.4 Method

Questionnaires were developed using the basic statement list given in Section 11.3. They were completed by the participants in the investigations described in Chapter 9 Section 9.4 and Chapter 10 Section 10.5.

For each aid type, the respondent indicated level of agreement with each statement using a 5-point horizontal Likert scale. The scales were anchored by the descriptors “Strongly Disagree” and “Strongly Agree” at the left and right extremes respectively. Respondents were also asked to indicate their preference between pairs of aids using the same statements. A 5-point horizontal scale was used anchored with the names of the aids being compared. In the “Consistency” study (Chapter 9), participants were asked to evaluate the “Grid” and “Annotated” aids individually, and then to mark their preference for the direct comparison of the two aids. Participants filled in the questionnaire twice, with an interval of 2 to 6 weeks between each phase of the study. In the “Situational Awareness” study (Chapter 10), the participants evaluated the plain chart and the two aids individually, and then indicated their preference for each possible pair of charts. They were also asked to indicate their overall preference for one particular chart type.

The questionnaires are shown in Appendix F.

The returned forms from the “Consistency” trial were scanned and processed with the SDAPS optical mark reader software [167]. The scanned

images were examined visually to verify scan quality and to manually correct ambiguous markings.

The data from the “Situational Awareness” online questionnaire was automatically entered into a database. Both data sets were imported into the R statistical software package (version 3.1.2) [168] for analysis.

Likert scores are presented as frequency tables and graphically. The influence of factors of interest on the scores was investigated using ANOVA and significant differences at $p < 0.05$ were further analysed using Tukey *post hoc* test. Preferences for chart types in the direct comparison sections were analysed using Student’s *t*-test against an expected mean of the central value. The use of parametric tests in the analysis of Likert-type scores is discussed in Section 11.5.

11.5 Results and Analysis

The response distributions and basic statistics are given below. Although the returns from responses to Likert scales are ordinal, in a detailed review of analysis methodology [215], it was determined that the use of parametric statistics was acceptable in this context, and have been used in the following analysis.

With the exception of statement 3 “The layout is confusing”, a higher score corresponds to a more favourable evaluation of the parameter. To facilitate comparisons, the scores for this statement were reversed so that greater values would thus correspond to a better evaluation, in conformity with all the other statements.

11.5.1 Preoperative Assessors

The 19 participants enrolled in the “Consistency” study (see Chapter 9 Section 9.5) consisted of nine foundation programme doctors and ten specialist anaesthetists or anaesthesia trainees. Two foundation doctors dropped out and failed to participate in the second phase of the study. With the exception of these two, each participant completed the satisfaction questionnaire twice (once for each phase of the trial).

The Likert score distributions and basic statistics are given in Table 11.1, and the distributions are shown graphically in Figure 11.1.

ANOVA was carried out, using ‘Anaesthesia Training’ (Anaes), ‘Chart Type’ and ‘Phase of Study’ (Phase) as explanatory variables. The ANOVA is shown in Table 11.2. Significant results ($p < 0.05$) were further analysed using Tukey *post hoc* analysis (Table 11.3). The following effects were found:

- **Aesthetically pleasing:** The “Annotated Layout” was the preferred layout for both anaesthetists and FY doctors
- **User Friendly** The aids were preferred by anaesthetists as compared to FY doctors. Acceptability was higher in the second phase of the study as compared to the first phase.

Furthermore there was a trend for FY doctors to consider the aids confusing, as compared to anaesthetists, but this just failed to reach significance at the $p = 0.05$ level.

The distributions of scores for the direct comparison between the two aids are shown in Figure 11.2. Student's t-test was used to compare the observed means against an assumed mean of 3 (no preference). The analysis is given in Table 11.4. Statistical significance ($p < 0.05$) is achieved for 'aesthetically pleasing', showing a preference for the 'annotated' aid. This corroborates the findings of the ANOVA.

Table 11.1: Preoperative Assessor Scoring of Cognitive Aid Acceptability

Statement	Score					n	mean	σ
	1	2	3	4	5			
Grid								
<i>The layout is aesthetically pleasing</i>	1	7	8	16	4	36	3.417	1.025
<i>Information is clearly conveyed</i>	0	8	6	17	4	35	3.486	0.981
<i>The layout is confusing</i>	2	3	10	16	4	35	3.486	1.011
<i>It is user friendly</i>	1	7	10	13	4	35	3.343	1.027
<i>It helps me identify issues quickly</i>	0	4	10	18	4	36	3.611	0.838
<i>It helps me remember important issues</i>	1	0	7	23	5	36	3.861	0.762
Annotated								
<i>The layout is aesthetically pleasing</i>	0	4	5	14	12	35	3.971	0.985
<i>Information is clearly conveyed</i>	0	5	11	14	5	35	3.543	0.919
<i>The layout is confusing</i>	1	5	12	11	6	35	3.457	1.039
<i>It is user friendly</i>	1	3	15	12	4	35	3.429	0.917
<i>It helps me identify issues quickly</i>	0	5	8	17	5	35	3.629	0.910
<i>It helps me remember important issues</i>	0	5	5	17	7	34	3.765	0.955
Grid vs. Annotated								
<i>The layout is aesthetically pleasing</i>	5	5	4	6	15	35	3.600	1.519
<i>Information is clearly conveyed</i>	7	7	6	9	6	35	3.000	1.414
<i>The layout is confusing</i>	3	6	9	7	8	33	3.333	1.291
<i>It is user friendly</i>	5	5	10	7	8	35	3.229	1.352
<i>It helps me identify issues quickly</i>	5	8	6	11	3	33	2.970	1.262
<i>It helps me remember important issues</i>	5	7	7	12	3	34	3.029	1.243

Table 11.2: ANOVA - Preoperative Assessors Cognitive Aid Scores

	Df	Sum Sq	Mean Sq	F value	Pr(>F)
<i>The layout is aesthetically pleasing</i>					
<i>Chart Type</i>	1	5.46	5.46	5.26	0.03
<i>Anaes</i>	1	0.18	0.18	0.17	0.68
<i>Phase</i>	1	1.16	1.16	1.12	0.29
<i>Chart Type:Anaes</i>	1	2.64	2.64	2.54	0.12
<i>Chart Type:Phase</i>	1	0.21	0.21	0.20	0.66
<i>Anaes:Phase</i>	1	0.06	0.06	0.06	0.81
<i>Chart Type:Anaes:Phase</i>	1	0.00	0.00	0.00	0.96
<i>Residuals</i>	63	65.47	1.04		
<i>Information is clearly conveyed</i>					
<i>Chart Type</i>	1	0.06	0.06	0.06	0.81
<i>Anaes</i>	1	0.02	0.02	0.02	0.89
<i>Phase</i>	1	0.02	0.02	0.02	0.88
<i>Chart Type:Anaes</i>	1	1.38	1.38	1.45	0.23
<i>Chart Type:Phase</i>	1	0.33	0.33	0.35	0.56
<i>Anaes:Phase</i>	1	0.65	0.65	0.68	0.41
<i>Chart Type:Anaes:Phase</i>	1	0.04	0.04	0.04	0.84
<i>Residuals</i>	62	58.99	0.95		
<i>The layout is confusing</i>					
<i>Chart Type</i>	1	0.01	0.01	0.01	0.91
<i>Anaes</i>	1	3.87	3.87	3.79	0.06
<i>Phase</i>	1	2.73	2.73	2.68	0.11
<i>Chart Type:Anaes</i>	1	0.11	0.11	0.10	0.75
<i>Chart Type:Phase</i>	1	0.01	0.01	0.01	0.93
<i>Anaes:Phase</i>	1	1.41	1.41	1.38	0.24
<i>Chart Type:Anaes:Phase</i>	1	0.11	0.11	0.11	0.74
<i>Residuals</i>	62	63.19	1.02		

Continued on next page

Table 11.2

<i>Continued from previous page</i>					
	Df	Sum Sq	Mean Sq	F value	Pr(>F)
<i>It is user friendly</i>					
<i>Chart Type</i>	1	0.13	0.13	0.15	0.70
<i>Anaes</i>	1	4.29	4.29	5.06	0.03
<i>Phase</i>	1	5.47	5.47	6.45	0.01
<i>Chart Type:Anaes</i>	1	0.00	0.00	0.00	0.99
<i>Chart Type:Phase</i>	1	1.05	1.05	1.23	0.27
<i>Anaes:Phase</i>	1	0.60	0.60	0.71	0.40
<i>Chart Type:Anaes:Phase</i>	1	0.49	0.49	0.58	0.45
<i>Residuals</i>	62	52.56	0.85		
<i>It helps me identify issues quickly</i>					
<i>Chart Type</i>	1	0.01	0.01	0.01	0.93
<i>Anaes</i>	1	0.04	0.04	0.05	0.83
<i>Phase</i>	1	0.32	0.32	0.42	0.52
<i>Chart Type:Anaes</i>	1	0.78	0.78	1.02	0.32
<i>Chart Type:Phase</i>	1	0.91	0.91	1.20	0.28
<i>Anaes:Phase</i>	1	1.52	1.52	2.00	0.16
<i>Chart Type:Anaes:Phase</i>	1	1.14	1.14	1.50	0.23
<i>Residuals</i>	63	48.01	0.76		
<i>It helps me remember important issues</i>					
<i>Chart Type</i>	1	0.16	0.16	0.21	0.65
<i>Anaes</i>	1	0.37	0.37	0.47	0.49
<i>Phase</i>	1	0.00	0.00	0.00	0.97
<i>Chart Type:Anaes</i>	1	0.86	0.86	1.09	0.30
<i>Chart Type:Phase</i>	1	0.57	0.57	0.73	0.40
<i>Anaes:Phase</i>	1	0.00	0.00	0.00	0.96
<i>Chart Type:Anaes:Phase</i>	1	0.01	0.01	0.01	0.93
<i>Residuals</i>	62	48.61	0.78		

Table 11.3: Tukey *post hoc* Analysis of Preoperative Assessor Cognitive Aid Acceptability

	Δ	Lower CI [†]	Upper CI [†]	p
<i>Aesthetically Pleasing</i>				
<i>Annotated–Grid</i>	0.556	0.073	1.040	0.025
<i>Confusing</i>				
<i>Anaes–FY</i>	0.475	-0.012	0.962	0.056
<i>User-friendly</i>				
<i>Anaes–FY</i>	0.500	0.055	0.945	0.028
<i>Phase 2–Phase 1</i>	0.560	0.118	0.999	0.014

[†] 95% confidence intervals

Table 11.4: Preoperative Assessor Direct Comparison of Cognitive Aids[†]

<i>Statement</i>	mean	σ	t	df	p
<i>The layout is aesthetically pleasing</i>	3.600	1.519	2.338	34	0.025
<i>Information is clearly conveyed</i>	3.000	1.414	0.000	34	1.000
<i>The layout is confusing</i>	3.333	1.291	1.483	32	0.148
<i>It is user friendly</i>	3.229	1.352	1.000	34	0.324
<i>It helps me identify issues quickly</i>	2.970	1.262	0.138	32	0.891
<i>It helps me remember important issues</i>	3.029	1.243	0.138	33	0.891

[†] Low Score favours “Grid”. High Score favours “Annotated”

Figure 11.1: Preoperative Assessor Cognitive Aid Scores

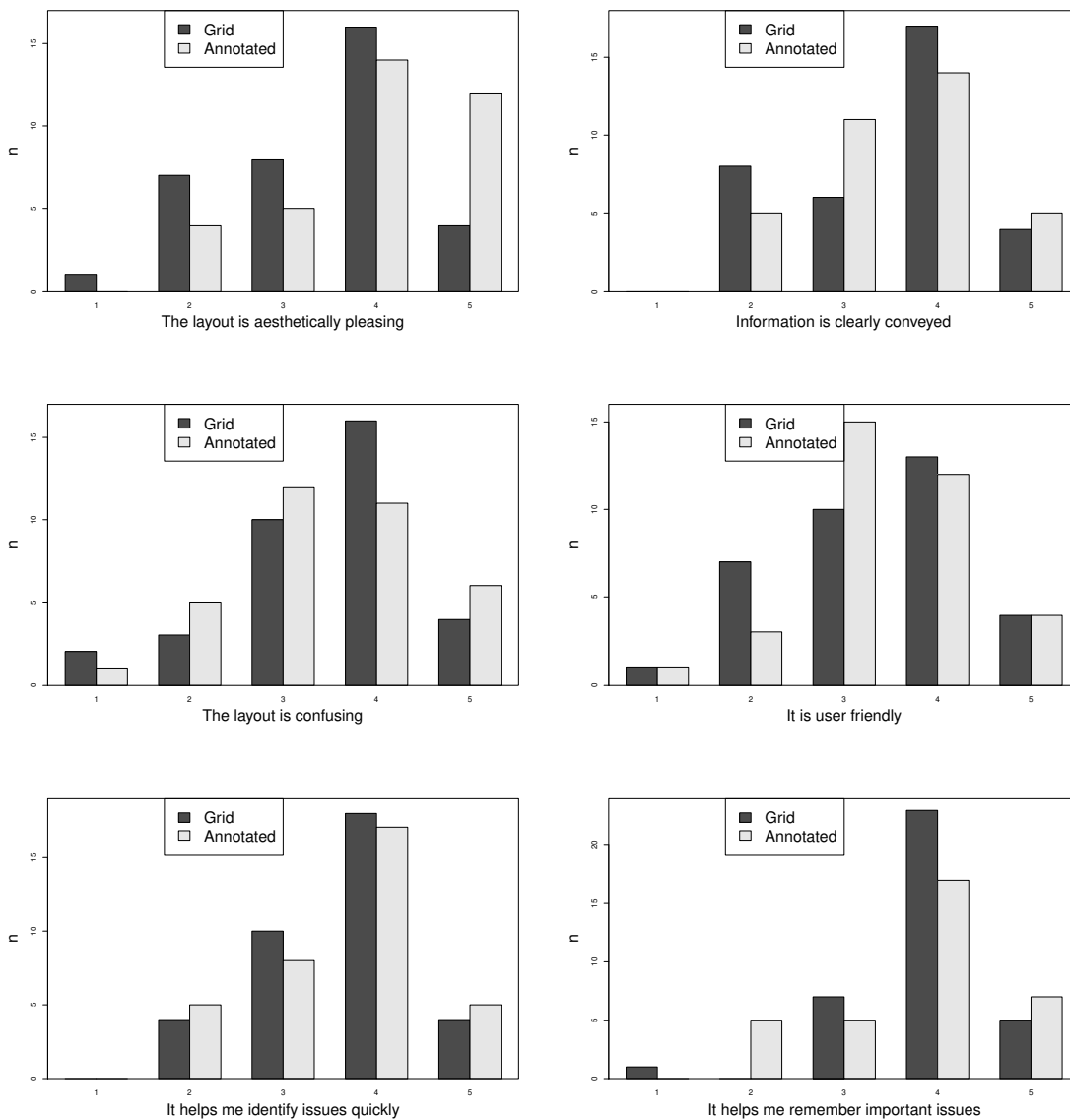
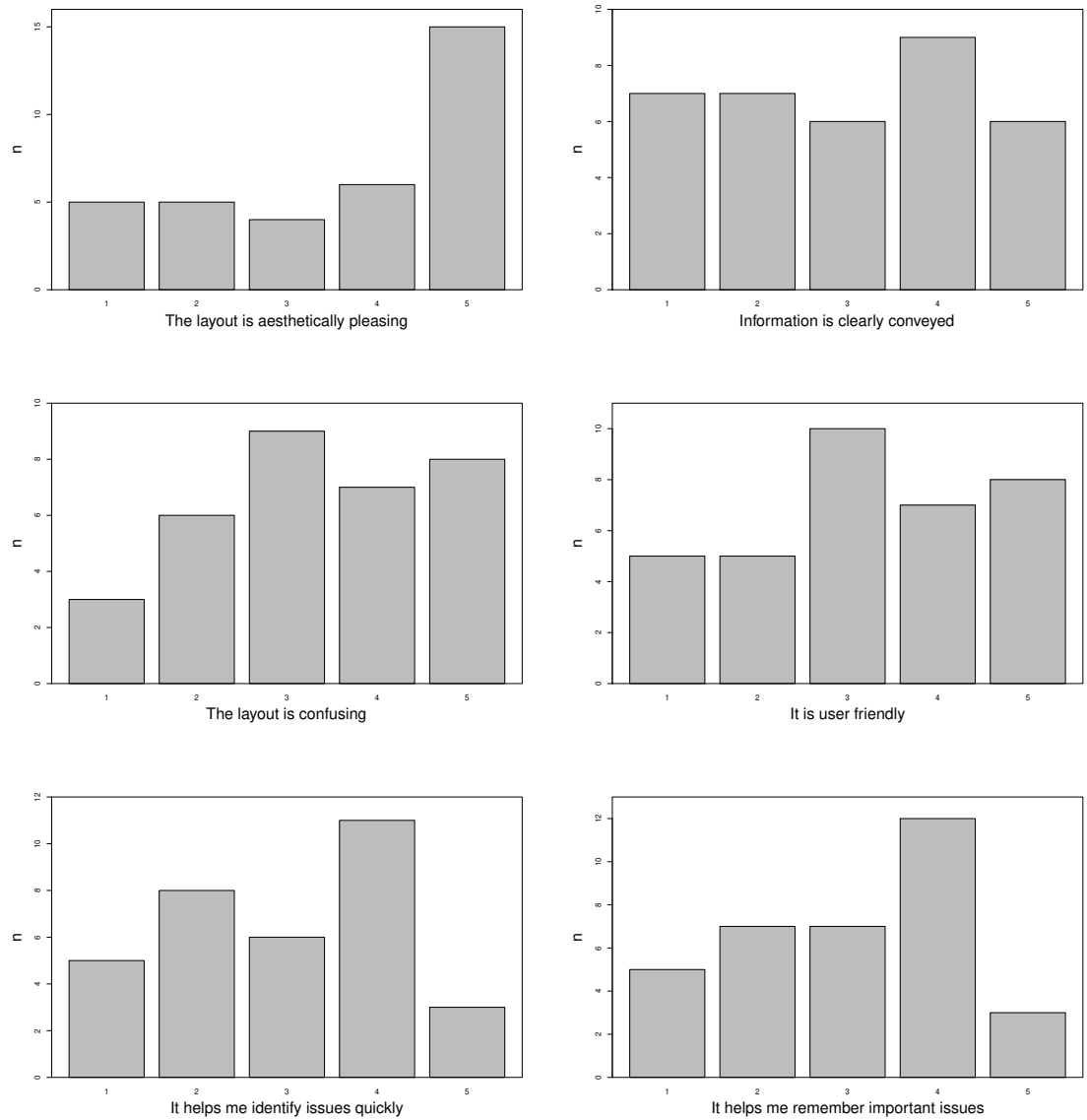

Figure 11.2: Preoperative Assessor Direct Comparison of Cognitive Aids[†]



[†] Low Score favours “Grid”. High Score favours “Annotated”

11.5.2 Attending Anaesthetists

The ‘‘Situational Awareness’’ study (see Chapter 10) was completed by 32 respondents, all of whom were Anaesthesia specialists or trainees. In this study, they were acting in the role of the attending anaesthetist, responsible for the perioperative care of the patient. Experience of the participants in the speciality is shown in Table 11.5. Due to the low numbers in some of the experience groups, the effects of experience were not investigated.

Table 11.5: Responder Years of Experience

<2	3-5	6-10	>10
3	4	6	18

The distribution of scores for the three chart types (‘Plain’: plain chart, ‘Grid’: chart with grid, ‘Annotated’: chart with annotated diagram) are shown in Figure 11.3 and basic statistics are given in Table 11.6. ANOVA of statement scores using chart type as an explanatory variable is shown in Table 11.7. Significant differences ($p < 0.05$) were observed for all properties except ‘confusing’. Turkey *post hoc* analysis was performed to identify the source of the differences (Table 11.8). In all cases, the charts augmented with the cognitive aids were significantly better than the ‘plain’ charts. Conversely, there was no difference between the two augmented charts.

Statistics for direct comparisons of the different chart pairs (Plain vs. Grid, Plain vs. Annotated, Grid vs. Annotated) are given in Table 11.9. Likert score distributions are shown in Figure 11.4. Student’s t-test was used to compare the observed means against an assumed mean of 3 (no preference). The analysis is also given in Table 11.9.

The grid layout was preferred to the plain layout on all of the assessed statements ($p < 0.05$) except for ‘Information is clearly conveyed’, which just failed to reach statistical significance. The annotated layout was also preferred to the plain layout on all statements ($p < 0.05$) except for ‘The layout is confusing’, which just failed to reach statistical significance. Comparing the grid and annotated layouts, there was no significant difference on any of the statements. There was, however, a trend for the annotated layout to be considered more aesthetically pleasing, although this just failed to achieve statistical significance.

These findings support the ANOVA analysis of the individual chart scores. The augmented charts are preferred to the plain chart on most parameters, while there is no clear preference between the grid and annotated chart.

A direct vote for the overall preference for one of the charts is shown in Table 11.10. The aid-augmented charts achieved a greater number of votes than the plain chart. The two augmented charts were equally popular, with each one scoring more than twice the votes as the plain chart. Although the available sample size was too small to achieve statistical significance, it shows the same trend as observed in the direct comparisons of the charts.

Table 11.6: Attending Anaesthetist Cognitive Aid Scores

Statement	Score					n	mean	σ
	1	2	3	4	5			
Plain								
<i>The layout is aesthetically pleasing</i>	7	10	8	6	1	32	2.500	1.136
<i>Information is clearly conveyed</i>	6	9	8	7	2	32	2.688	1.203
<i>The layout is confusing</i>	4	8	10	4	6	32	3.000	1.295
<i>It is user friendly</i>	7	4	11	7	3	32	2.844	1.273
<i>It helps me identify issues quickly</i>	7	10	8	4	3	32	2.562	1.243
<i>It helps me remember important issues</i>	9	7	9	5	2	32	2.500	1.244
Grid								
<i>The layout is aesthetically pleasing</i>	2	1	3	18	8	32	3.906	1.027
<i>Information is clearly conveyed</i>	1	2	8	16	5	32	3.688	0.931
<i>The layout is confusing</i>	2	6	5	11	8	32	3.531	1.244
<i>It is user friendly</i>	1	3	7	17	4	32	3.625	0.942
<i>It helps me identify issues quickly</i>	0	4	7	14	7	32	3.750	0.950
<i>It helps me remember important issues</i>	1	4	9	12	6	32	3.562	1.045
Annotated								
<i>The layout is aesthetically pleasing</i>	0	1	5	19	7	32	4.000	0.718
<i>Information is clearly conveyed</i>	0	3	7	17	5	32	3.750	0.842
<i>The layout is confusing</i>	1	7	6	10	8	32	3.531	1.191
<i>It is user friendly</i>	0	2	12	12	6	32	3.688	0.859
<i>It helps me identify issues quickly</i>	0	2	9	13	8	32	3.844	0.884
<i>It helps me remember important issues</i>	0	2	6	19	5	32	3.844	0.767

Table 11.7: ANOVA - Attending Anaesthetist Cognitive Aid Scores

	Df	Sum Sq	Mean Sq	F value	Pr(>F)
<i>The layout is aesthetically pleasing</i>					
<i>Chart Type</i>	2	45.19	22.59	23.68	<0.001
<i>Residuals</i>	93	88.72	0.95		
<i>Information is clearly conveyed</i>					
<i>Chart Type</i>	2	22.75	11.37	11.28	<0.001
<i>Residuals</i>	93	93.75	1.01		
<i>The layout is confusing</i>					
<i>Chart Type</i>	2	6.02	3.01	1.95	0.15
<i>Residuals</i>	93	143.94	1.55		
<i>It is user friendly</i>					
<i>Chart Type</i>	2	14.15	7.07	6.54	<0.001
<i>Residuals</i>	93	100.59	1.08		
<i>It helps me identify issues quickly</i>					
<i>Chart Type</i>	2	32.65	16.32	15.17	<0.001
<i>Residuals</i>	93	100.09	1.08		
<i>It helps me remember important issues</i>					
<i>Chart Type</i>	2	32.15	16.07	14.93	<0.001
<i>Residuals</i>	93	100.09	1.08		

Table 11.8: Tukey *Post hoc* Analysis of Attending Anaesthetist Cognitive Aid Scores

	Δ	Lower CI [†]	Upper CI [†]	p
<i>The layout is aesthetically pleasing</i>				
<i>Grid–Plain</i>	1.406	0.825	1.988	0.0000003
<i>Annotated–Plain</i>	1.500	0.918	2.082	0.0000001
<i>Annotated–Grid</i>	0.094	-0.488	0.675	0.9220320
<i>Information is clearly conveyed</i>				
<i>Grid–Plain</i>	1.000	0.402	1.598	0.0003927
<i>Annotated–Plain</i>	1.063	0.465	1.660	0.0001589
<i>Annotated–Grid</i>	0.063	-0.535	0.660	0.9664118
<i>It is user friendly</i>				
<i>Grid–Plain</i>	0.781	0.162	1.401	0.0094839
<i>Annotated–Plain</i>	0.844	0.224	1.463	0.0046098
<i>Annotated–Grid</i>	0.063	-0.557	0.682	0.9686596
<i>It helps me identify issues quickly</i>				
<i>Grid–Plain</i>	1.188	0.570	1.805	0.0000428
<i>Annotated–Plain</i>	1.281	0.664	1.899	0.0000102
<i>Annotated–Grid</i>	0.094	-0.524	0.711	0.9305681
<i>It helps me remember important issues</i>				
<i>Grid–Plain</i>	1.063	0.445	1.680	0.0002619
<i>Annotated–Plain</i>	1.344	0.726	1.961	0.0000038
<i>Annotated–Grid</i>	0.281	-0.336	0.899	0.5260975

[†] 95% confidence intervals

Figure 11.3: Attending Anaesthetist Cognitive Aid Scores

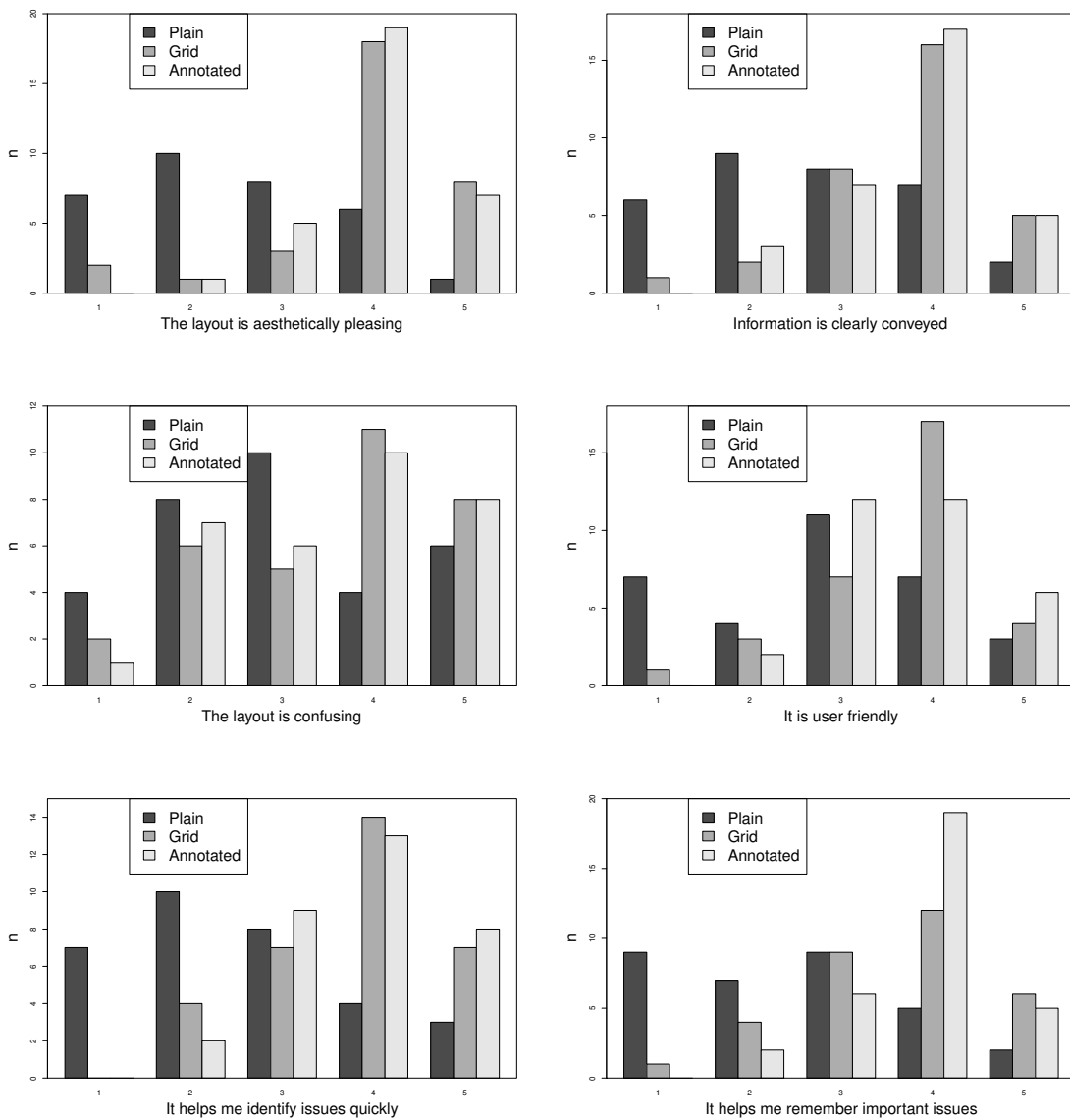
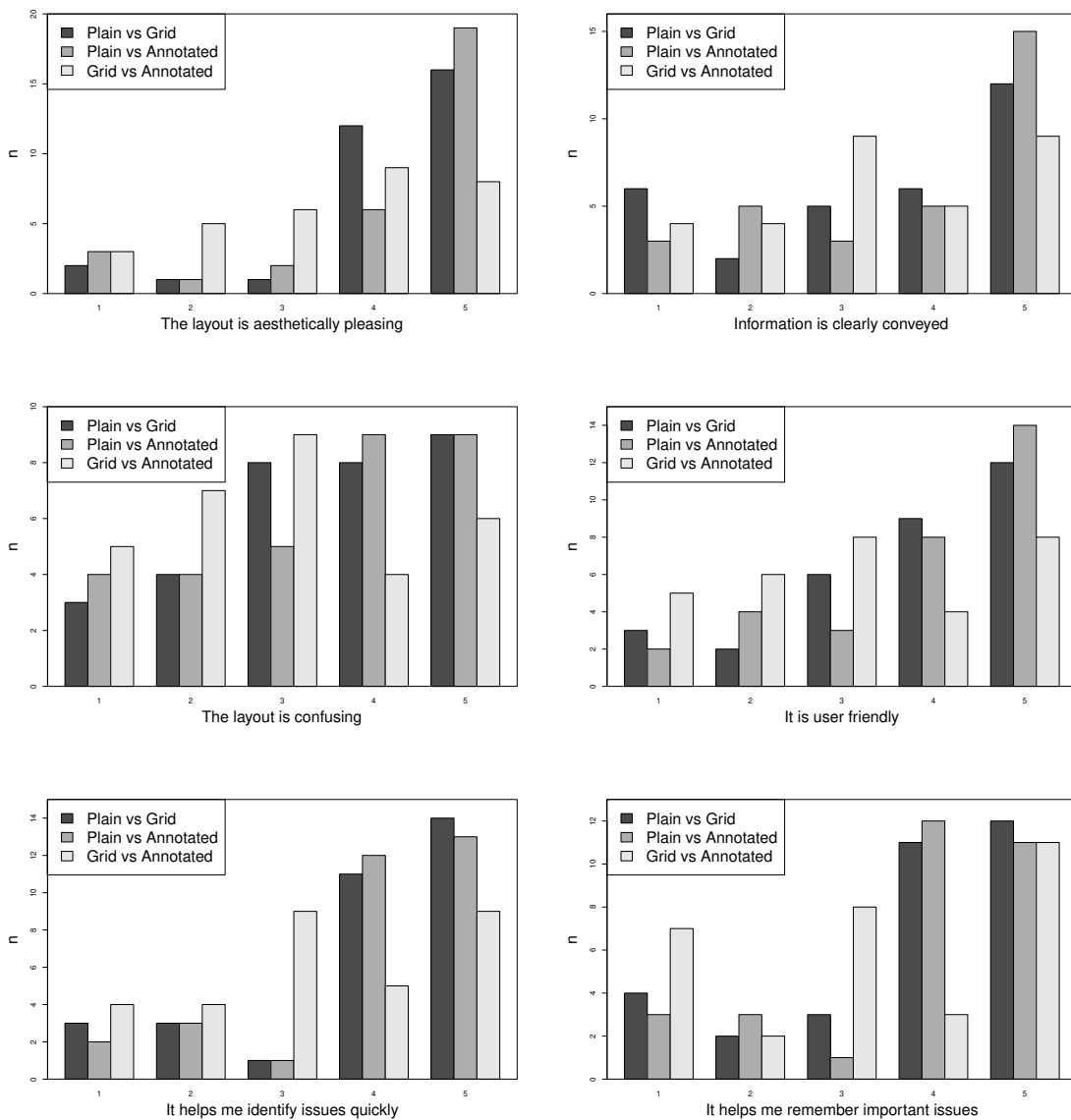

Table 11.9: Attending Anaesthetist Direct Comparison of Cognitive Aids[†]

Statement	Score					n	mean	σ	t	p
	1	2	3	4	5					
<i>Plain vs Grid</i>										
<i>The layout is aesthetically pleasing</i>	2	1	1	12	16	32	4.219	1.099	6.271	0.000
<i>Information is clearly conveyed</i>	6	2	5	6	12	31	3.516	1.546	1.858	0.073
<i>The layout is confusing</i>	3	4	8	8	9	32	3.500	1.295	2.184	0.037
<i>It is user friendly</i>	3	2	6	9	12	32	3.781	1.289	3.430	0.002
<i>It helps me identify issues quickly</i>	3	3	1	11	14	32	3.938	1.318	4.023	0.000
<i>It helps me remember important issues</i>	4	2	3	11	12	32	3.781	1.362	3.246	0.003
<i>Plain vs Annotated</i>										
<i>The layout is aesthetically pleasing</i>	3	1	2	6	19	31	4.194	1.302	5.105	0.000
<i>Information is clearly conveyed</i>	3	5	3	5	15	31	3.774	1.454	2.965	0.006
<i>The layout is confusing</i>	4	4	5	9	9	31	3.484	1.387	1.942	0.062
<i>It is user friendly</i>	2	4	3	8	14	31	3.903	1.300	3.868	0.001
<i>It helps me identify issues quickly</i>	2	3	1	12	13	31	4.000	1.211	4.597	0.000
<i>It helps me remember important issues</i>	3	3	1	12	11	30	3.833	1.315	3.470	0.002
<i>Grid vs Annotated</i>										
<i>The layout is aesthetically pleasing</i>	3	5	6	9	8	31	3.452	1.312	1.916	0.065
<i>Information is clearly conveyed</i>	4	4	9	5	9	31	3.355	1.380	1.432	0.162
<i>The layout is confusing</i>	5	7	9	4	6	31	2.968	1.354	-0.133	0.895
<i>It is user friendly</i>	5	6	8	4	8	31	3.129	1.432	0.502	0.619
<i>It helps me identify issues quickly</i>	4	4	9	5	9	31	3.355	1.380	1.432	0.162
<i>It helps me remember important issues</i>	7	2	8	3	11	31	3.290	1.575	1.027	0.313

[†] Low Score favours 1st form, high score favours 2nd form

Figure 11.4: Attending Anaesthetist Direct Comparison of Cognitive Aids[†]



[†] Low Score favours 1st form, high score favours 2nd form

Table 11.10: Overall Preference

Plain	Grid	Annotated
6	13	13
$\chi^2=3.06$ df=2 p=0.216		

11.6 Discussion

11.6.1 Survey Tool

The studies presented here investigate the respondents' subjective satisfaction with various aspects of the cognitive aids under investigation. User satisfaction is frequently assessed on the dimensions of effectiveness, efficiency and usability [356–358]. Details of questionnaires used, however, are rarely published, and widely-accepted, well-validated tools for this purpose are not yet available [358]. For this reason, the survey tool used in this study, while based on the dimensions detailed above, used specific questions developed *ad hoc*. Development and validation of a generic tool to assess handover aids may be a useful field of future research.

11.6.2 Sources of Bias

The researcher is a senior member of the Anaesthesia Department and so known to the study participants. Some respondents were also aware of the efforts being made to design the cognitive aids under study. This may have caused some bias in judging the properties of the aids. It is expected that anonymising the responses would have mitigated this effect. In the case of the FY participants, the researcher was largely unknown to them and, again, the responses were anonymised, so there should have been minimal bias in this case.

11.6.3 User Satisfaction with Aids

When assessed as part of a preoperative assessment task, both aids were found to be more user friendly by anaesthetists than by foundation doctors. In fact, there was an indication that foundation doctors found the aids confusing, although this failed to reach statistical significance. It may be that the anaesthetists appreciate the underlying rationale for the structure of the aids, which the FY doctors, without the anaesthetic background knowledge, would fail to appreciate. The score for user friendliness also improved in the second phase of the study, suggesting that familiarity may improve user satisfaction.

The annotated diagram was considered to be aesthetically pleasing by both anaesthetists and FY doctors.

When assessed by anaesthetist specialists or trainees in a simulated scenario of assessing patient documentation before starting a surgical case, both aids were found to be preferable to a plain health questionnaire report. The two aids were found to be equally useful, although there was a trend for the annotated diagram style to be considered more aesthetically pleasing. These findings were confirmed by the comparison between the chart pairs.

In conclusion, the two aids are considered equally useful by anaesthetists, and an improvement over the plain charts. While the annotated diagram aid

is somewhat more aesthetically pleasing, there is no clear preference between the two aids, and this seems to be very much a matter of individual taste.

Chapter 12

Recapitulation and Recommendations

The preoperative assessment and optimisation of patients prior to undergoing surgery is a prerequisite to the safe conduct of anaesthesia. Failures in preoperative assessment are frequently identified as significant factors contributing to perioperative adverse events [20].

The work presented here investigated several aspects of a process to achieve the goals of preoperative assessment and describes the development of tools to facilitate these objectives.

12.1 Goals of the Preoperative Assessment

The goals of the preoperative assessment have been outlined in the various guidelines and recommendations on preoperative evaluation reviewed in Chapter 2 and the common recommendations identified. If the Preoperative Assessment Clinic assessments are to be acceptable to the anaesthetists it serves, there must be a broad agreement with the objectives of the guidelines adopted. Guidelines may be rejected if there is inadequate dissemination, if they are considered to have an inadequate evidence base, if they are considered inapplicable to the local context, or if the local work environment is not conducive to their implementation [165].

In order to determine the acceptability of preoperative recommendations and guidelines, a survey was carried out amongst the local anaesthesia faculty as discussed in Chapter 3. This helped identify where local opinion and practice diverges from international recommendations. Educational efforts may then be directed to support those guidelines with a strong evidence base, or adapt the guidelines where the justification is weak or not transferable to the local context. Alignment of the preoperative clinic goals and the expectations of the attending anaesthetists will improve the acceptability of the preoperative preparation.

The dataset survey presented in Chapter 3 is based on the broad set of guidelines from a number of different countries and institutions discussed above. It should therefore be of relevance even in an international context.

It may be a useful tool to use at an institutional or even national level to inform development of localised guidelines where these do not already exist, effectively using local expert opinion to validate the recommendations. It may also be useful to help identify elements of existing guidelines which are not being implemented to direct efforts to improve compliance.

In order to further understand the goals and expectations of personnel involved in the preoperative assessment, a series of semi-structured interviews was conducted, as described in Chapter 4. This helped gain further insight into the expectations of the anaesthetists of the functions of the POAC. This also gave information regarding the tasks undertaken in the clinic, the appropriateness of the various roles, and the channels of communication employed. Difficulties encountered were identified, including the need to develop care pathways and clinical decision aids and to improve documentation and communication.

12.2 Analysis of the Process

The clinic was reorganised and expanded as detailed in Chapter 5 Section 5.3, in part guided by the findings outlined above. Although the work presented focuses on this specific clinic, it shares many elements with other preoperative evaluation clinics described in the literature [174, 175, 177, 178, 197–200, 262]. The analysis may be indicative of common problems found in this type of clinic.

The HFMEA reported in Chapter 5 developed a detailed process map for the clinic, and the possible failure modes. In broad outline, these consisted of:

- Logistical failures
- Failure to identify patient issues
- Failure to adequately manage patient issues
- Failure to communicate effectively

From the identified communication network of the clinic, it emerged that the FY has a central role. Due to the relatively junior status and inexperience of these doctors, in order to perform effectively, it is essential that they receive the necessary training and support in terms of decision aids, facilitation of communication and easy access to senior advice.

12.3 Performance

The performance of the clinic was investigated from the perspectives of the patients attending the clinic, and the attending anaesthetists who would eventually act on the received preoperative evaluation.

12.3.1 Patients' Perspective

A survey was carried out to determine the patients' experiences of the clinic as described in Chapter 6. The survey tool was based on the well-validated Picker Institute (Europe) Outpatients' Satisfaction tool [241] as adapted for a preoperative assessment clinic [240]. The analysis presented indicated that the tool used had satisfactory content and construct validity. This supports the adaptation of the Picker question bank to assess preoperative clinics. In common with the Dutch PEPAC tool [240], it also provides evidence that the Picker question bank can be successfully translated into other languages. The successful translation into Maltese also indicates that the Picker questionnaire may be utilised in Maltese translation as a survey tool for other local outpatient clinics.

The data collected also showed that the attendees had a very favourable experience with most aspects of the clinic. The most significant deficit identified was inadequate provision of information, both regarding the clinic itself, as well as the forthcoming procedure and anaesthesia. These issues could be ameliorated by providing written material, or providing links to appropriate websites. These may be most effective if provided before the clinic appointment to allow further discussion during the clinic consultation.

Specific instructions for preparation and admission should also be provided at the clinic in verbal and written format after the POAC appointment [256]. Development and assessment of these facilities would be a useful project for further improvement of the clinic.

The main issue reported with clinic logistics was excessive waiting time, particularly at the FY doctor station. The causes for the bottleneck identified in the present study were not investigated further in the present work. Patient flow through clinics has been investigated by a number of workers, and various strategies to improve efficiency suggested [360,361]. The application and study of such measures in the POAC would be a useful field for further investigation.

12.3.2 Technical Quality of the Preoperative Assessment

Chapter 7 presents a novel tool allowing a multifactorial investigation of the technical quality of a preoperative assessment, based on the international guidelines reviewed in Chapter 2. It was capable of recording the majority of the encountered inadequacies. The tool may find applicability in a wider research context. Given larger datasets, it should also be possible to refine it further to capture even more issues.

Regrettably, difficulty was found in obtaining the feedback desired, and it is possible that the tool would not be readily accepted in routine local practice. It is unclear if this an issue with the usability of the tool, if it is too time-consuming to use as a routine monitor of quality, or if there is a local reluctance to provide feedback.

It would be interesting to undertake a similar trial with the tool in other institutions to gain greater understanding of the tool's characteristics and determine if it has potential for research or routine quality assurance.

The results reported were limited due to a rather low return rate. However, the data available support the utility of the clinic structure in improving the technical quality of the preoperative assessment compared to FY doctors working without the clinic support.

In broad, the inadequacies noted included:

- Missing clerking documents or investigation results
- Failure to identify clinical issues
- Underestimating severity of comorbidities
- Failure to investigate adequately
- Failure to optimise
- Failure to communicate with attending anaesthetist

Several of the issues identified in this study were also predicted in the HFMEA reported in Chapter 5. This increases the confidence in the HFMEA validity and justifies steps to mitigate other predicted failure modes which may be too infrequent to have been detected in this survey.

12.4 Cognitive Aids

The findings presented identify a number of potential failure points in the process of preoperative assessment. In particular, a need was shown to:

- Guide the preoperative team in performing a complete patient assessment.
- Assist the FY doctor in identifying and correctly grading the severity of clinical issues.
- Improve effective communication of the findings to the operating theatre team

To this end, a focus group was convened to develop a cognitive aid to address these issues as detailed in Chapter 8. The completed tools are presented in Appendix D. For logistical and investigation purposes, a paper-based tool was constructed, but with the potential to adapt it to electronic format if as a later stage.

Before possible wider deployment in clinical practice, it was desired to determine if FY doctors would be able to use the tool reliably, if it would improve handover to the attending anaesthetists, and if it would be found acceptable by the users.

12.4.1 Utility for Assessors

Considerable variability has been reported in the literature, reviewed in Section 9.3, between clinicians carrying out preoperative risk assessment. This is a matter of some concern. If the assessment is unreliable, the entire system of preoperative assessment may be untrustworthy.

The findings reported in Chapter 9 showed that, compared to anaesthetists, FY doctors have a tendency to underestimate severity of impairment, even when considering individual body systems using the aids under study. This is analogous to the effect reported in the literature, where non-anaesthetists tended to underestimate the degree of patient impairment [175, 199] and the ASA-PS score [315, 316, 323]. On the other hand, the cognitive aids studied were associated with some improvement in reliability, although they did not eliminate variability entirely.

As reported in Section 11.5.1, there was a trend for the FY doctors to consider the aids to be less user friendly and more confusing than the anaesthetists did. Specific training on their use would be necessary if these aids are to be deployed in clinical practice.

Given the promising results noted, further investigation of the cognitive aids seems warranted. This could take the form of a more extended trial with more assessors and a wider selection of simulated cases, or cases developed from actual clinical data. The trial could also be extended to determine what decisions the assessor would make with regards to further investigation and optimisation. If the aids are introduced into clinical practice, it would be possible to undertake a longitudinal before-and-after study to demonstrate improvement in assessment quality using the “Technical Evaluation” tool discussed earlier.

As the tool is based on the very general paradigm of body systems, it should be possible to use these cognitive aids in health systems using different models for preoperative assessment. It would then be possible to conduct further investigations at multiple sites and in different health care environments.

12.4.2 Utility for Attending Anaesthetist

In its function as a communication tool, the cognitive aids are acting as a handover tool and, as such, were intended to improve the situational awareness of the attending anaesthetist. The investigation reported in Chapter 10 failed to show any objective evidence of improved SA under the experimental conditions used. Possible reasons for this lack of effect are discussed in Section 10.7.

Further investigation of the tools under conditions of increased cognitive workload and time pressure would be of interest. One approach would be to repeat the study described in Chapter 10, but incorporating some extra cognitive tasks to increase the cognitive workload. As a web-based experiment, this could be extended to several cooperating institutions.

Another possible approach would be to use the aids as an adjunct to the

briefing in high-fidelity simulations, particularly enacting high-workload, time-constrained scenarios. Any influence of the aids on performance under these conditions could then be assessed.

12.4.3 User Satisfaction

As discussed in Section 11.5.2, when compared to the control, the aids were considered to be user-friendly, helped in communicating information, and in helping to remember important issues. There was no clear preference for one aid type over the other. This study could be readily replicated if the aids were to be trialled in other institutions as an adjunct to the standard documentation.

12.5 Further Developments

12.5.1 Cognitive Aids

The cognitive aids developed were intended to serve both as a cognitive aid to assist evaluation of patients, and also to act as a communication tool between different members of the preoperative and perioperative teams. Being based on a very generic body system paradigm, it should be easily adapted to present clinical data collected through alternative preoperative health status assessment processes. It could also accommodate the inclusion of formally calculated risk indices such as those discussed in Chapter 2 Section 2.5, Extra elements could easily be added to cater for special patient populations as necessary. For example, a specific frailty assessment risk score could be used for geriatric populations [362]. or for specific procedures, such as the EuroSCORE II [120] for cardiac surgery, or the Nottingham Hip Fracture Score [121] for hip fracture surgery.

It would also be relatively straightforward to adapt the aid for other perioperative handovers, such as theatre to Post-Anaesthesia Care Unit (PACU), PACU to the Intensive Care Unit (ICU) or ward, and ICU to ward. In fact, with regular updates, the tool may be useful as an ongoing summary of the patient's condition throughout their hospital admission.

As stated earlier, the cognitive aids were designed with a view to the possibility of conversion to an electronic format. This would open the possibility of further enhancements. It would be possible for the system elements of each aid to be populated automatically from the responses flagged as abnormal in the computerised electronic health record. This may facilitate the manual assessment of the degree of impairment which could be supplemented by calculation of generic or organ-specific risk indices. By collecting the clinical findings and assessed impairment data into a training dataset, it may be used to train a machine-learning algorithm to prompt degree of impairment automatically. This approach has already shown promise compared to traditional RSTs [363].

A display based on this tool could also be used to give a quick, dynamic overview of the patient's condition in real time, with changes in patient status being readily discernible.

Once computerised, further improvements to the user interface become possible. For example, the alert colour could be applied to the system element titles to make it even more distinctive. An example for the grid-style aid is given in Figure 12.1 (pg. 272). For the annotated-style aid, unremarkable system elements could be hidden from view and the organ shading colour changed to reflect the alert level, as shown in Figure 12.2 (pg. 273). Hyperlinks from the flagged systems could bring up the full details from the patient's electronic health questionnaire record.

Both the grid and the colourised annotated aids could be used in very compact forms, to highlight issues, for example, on an operating list, as demonstrated in Figure 12.3 (pg. 274). The indicator icon could also be linked electronically to cross-reference the full patient record.

12.6 Quality Control and Feedback

The outcome of processes can be improved by including ongoing quality control in the workflow. While this practice was not investigated in the work presented here, it would be feasible, given the actual clinic process, to select a sample of cases, either at random or when flagged by triggers from the health questionnaire, to be reviewed by the clinic anaesthetist. This would serve as a cross-check of the FY and clinic nurse clerking. Any discrepancies could be used as points for discussion and instruction.

Similarly, if the attending anaesthetist finds errors in the preoperative assessment, these could be indicated on one of the cognitive aid charts and brought to the attention of the preoperative team.

12.7 Concluding Remarks

A broad view has been presented of the process of preoperative assessment. The insights gained allow the application of techniques derived from high-reliability organisations to address the identified weaknesses. These have the potential of improving the performance, as is warranted by such an important determinant of safe anaesthetic practice.

Figure 12.1: Alternative Grid-style Cognitive Aid

Name: <u>NNNN NNNN (Female)</u> Age: <u>58 yrs</u> ID: <u>987654N</u>		Date: <u>Assume Recent Date</u>	
Procedure	Alerts	ASA/Gen.	Rx
Left Mastectomy	Allergic to Penicillin	ASA 3 BMI 40	Perindopril Aspirin
CVS	Respiratory	Airway	GIT
Hypertensive MI 3 years ago Stent - LAD	Smokes 20/dy	H/O Difficult Intubation	
Hepatic	Renal	Endocrine	Metabolic
Neur/Psych	MSK	Haematol.	Gynae
NOTE 1	NOTE 2	Investig.	Pending
		ECG: Old MI ECHO: Lat wall hypokinesia EF 40 %	

KEY	
	NAD
	Low Risk
	Medium Risk
	High Risk

Doctor:	Dr. ZZZZ ZZZZ
Reg. No:	9999
Signature:	<i>Signed</i>

Figure 12.2: Shaded Annotated-Style Cognitive Aid

Name: <u>MMMM MMMM</u> Age: <u>65 yrs</u> ID: <u>123321M</u>	Date: <u>Recent Date</u>
---	---------------------------------

Procedure	General/ASA	Rx
Right Inguinal Hernia Repair	ASA: 3 BMI: 24 SOB: 1 ft of stairs	Perindopril NKDA

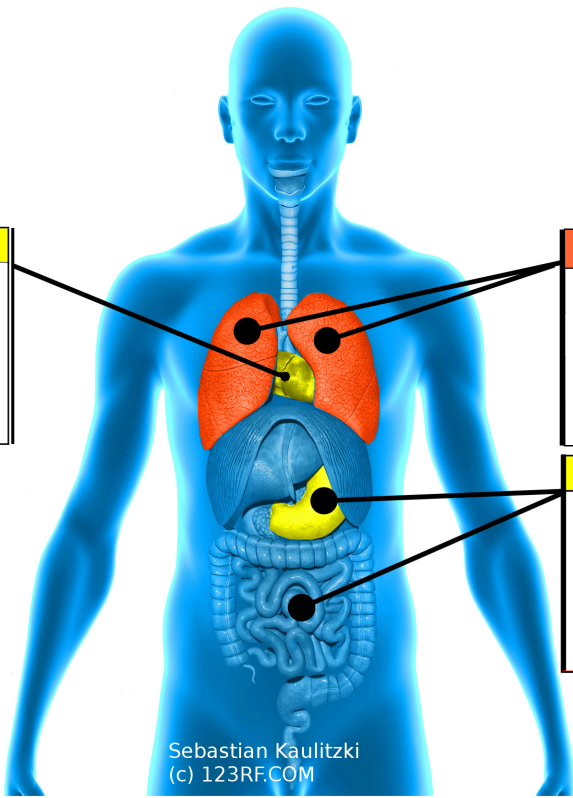

Sebastian Kaulitzki
(c) 123RF.COM

CVS

Controlled Hypertensive

Respiratory

Smokes 40/day

Scattered Rhonci

GIT

Heartburn Reflux

<table border="1" style="width: 100%; border-collapse: collapse;"> <tr> <th colspan="2" style="text-align: center;">KEY</th> </tr> <tr> <td style="width: 15px; background-color: #00ff00;"></td> <td>NAD</td> </tr> <tr> <td style="background-color: #ffff00;"></td> <td>Low Risk</td> </tr> <tr> <td style="background-color: #ffcc99;"></td> <td>Medium Risk</td> </tr> <tr> <td style="background-color: #ff0000;"></td> <td>High Risk</td> </tr> </table>	KEY			NAD		Low Risk		Medium Risk		High Risk	Doctor: <u>Dr. ZZZZ ZZZZ</u> Reg. No: <u>9999</u> Signature: <u></u>
KEY											
	NAD										
	Low Risk										
	Medium Risk										
	High Risk										

Figure 12.3: Example Operating List

Patient Details	Procedure	Preop. Status			
NNNN NNNN 58yrs 987654N	Left Mastectomy	Prc	!	GEN	Rx
		CVS	RS	AW	GIT
		Hep	Rnl	Endo	Met
		Nr/ψ	MSk	Hmt	Gyn
		Nt1	Nt2	Inv	Pnd
MMMM MMMM 65yrs 123321M	Right Inguinal Hernia Repair	Prc	!	GEN	Rx
		CVS	RS	AW	GIT
		Hep	Rnl	Endo	Met
		Nr/ψ	MSk	Hmt	
		Nt1	Nt2	Inv	Pnd

Glossary

AAGBI Association of Anaesthetists of Great Britain and Ireland.

ACC/AHA American College of Cardiologists and American Heart Association.

ACS American College of Surgeons.

AKI Acute Kidney Injury.

ANOVA Analysis of Variance.

ANTS Anaesthetists' Non-technical Skills.

ANZCA Australian and New Zealand College of Anaesthetists.

aPTT Activated Partial Thromboplastin Time.

ARB Angiotensin Receptor Blocker.

ASA American Society of Anesthesiologists.

ASA-PS American Society of Anesthesiologists Physical Status.

BNP Brain Natriuretic Peptide.

BST Basic Specialist Trainee.

BUPA British United Provident Association.

CACI Charlson Age Comorbidity Index.

CBC Complete Blood Count.

CCI Charlson Comorbidity Index.

CCS Canadian Cardiovascular Society.

CKD Chronic Kidney Disease.

CPET Cardiopulmonary Exercise Testing.

DASI Duke Activity Status Index.

ECG Electrocardiogram.

eGFR estimated Glomerular Filtration Rate.

ESA European Society of Anaesthesiologists.

ESC European Society of Cardiology.

FMEA Failure Modes and Effects Analysis.

FY Foundation Years Programme.

GCS Glasgow Coma Score.

HBA_{1C} Glycated Haemoglobin.

HFMEA Healthcare Failure Modes and Effects Analysis.

HST Higher Specialist Trainee.

ICU Intensive Care Unit.

MET Metabolic Equivalent.

NCEPOD National Confidential Enquiry into Peri-Operative Deaths.

NCEPOD National Confidential Enquiry into Peri-Operative Deaths.

NHFS Nottingham Hip Fracture Score.

NICE National Institute for Health and Care Excellence.

NOTSS Non-Technical Skills for Surgeons.

NSQIP National Surgical Quality Improvement Program.

OLR Ordinal Linear Regression.

PACU Post-Anaesthesia Care Unit.

PEPAC Patient Experience with Preoperative Assessment Clinic.

PHA Prospective Hazards Analysis.

POAC PreOperative Assessment Clinic.

POETTS Perioperative Exercise Testing and Training Society.

POISE PeriOperative IScaemia Evaluation.

POISE-2 PeriOperative IScaemia Evaluation-2.

- PONV** Post-Operative Nausea and Vomiting.
- POSPOM** Preoperative Score to Predict Postoperative Mortality.
- POSSUM** Physiological and Operative Severity Score for the enUmeration of Mortality and morbidity.
- PRR** Prospective Risk Review.
- PT** Prothrombin Time.
- RCoA** Royal College of Anaesthetists.
- RCRI** Revised Cardiac Risk Index.
- RSp** Resident Specialist.
- RST** Risk Stratification Tool.
- SA** Situational Awareness.
- SAGAT** Situation Awareness Global Assessment Technique.
- SART** Situation Awareness Rating Technique.
- SAVANT** Situation Awareness Verification and Analysis Tool.
- SBAR** Situation-Background-Assessment-Recommendation.
- SCOAP** Surgical Care and Outcomes Assessment Program.
- SDAPS** Scripts for Data Acquisition with Paper-based Surveys.
- SMPM** Surgical Mortality Probability Model.
- SOAP** Subjective-Objective-Assessment-Plan.
- SORT** Surgical Outcome Risk Tool.
- SPAM** Situation Present Assessment Method.
- SRS** Surgical Risk Scale.
- SSRI** Selective Serotonin Reuptake Inhibitor.
- SURPASS** Surgical Patient Safety System.
- SWIFT** Structured What-if Technique.
- ULBT** Upper Lip Bite Test.
- VASQIP** Veterans Association Surgical Quality Improvement Program.

References

- [1] American Society of Anesthesiologists Task Force on Preanesthesia Evaluation. Practice advisory for preanesthesia evaluation: a report by the American Society of Anesthesiologists Task Force on Preanesthesia Evaluation. *Anesthesiology*. 2002;96(2):485–496.
- [2] American Society of Anesthesiologists Committee on Standards and Practice Parameters. Practice advisory for preanesthesia evaluation: an updated report by the American Society of Anesthesiologists Task Force on Preanesthesia Evaluation. *Anesthesiology*. 2012;116(3):522–538.
- [3] Australian and New Zealand College of Anaesthetists. Recommendations for the Pre-Anaesthesia Consultation; 2008.
- [4] The Royal College of Anaesthetists. Guidelines for the Provision of Anaesthetic Services. London; 2009.
- [5] Association of Anaesthetists of Great Britain and Ireland. Pre-operative Assessment and Patient Preparation - The Role of the Anaesthetist. London; 2010.
- [6] De Hert S, Imberger G, Carlisle J, Diemunsch P, Fritsch G, Moppett I, et al. Preoperative evaluation of the adult patient undergoing non-cardiac surgery: guidelines from the European Society of Anaesthesiology. *Eur J Anaesthesiol*. 2011;28(10):684–722.
- [7] Janulova L. Surgical Operations at MDH Theatres (2018). Mater Dei Hospital, Malta; 2019.
- [8] Foundation Programme — Malta. The Malta Foundation Programme;. <https://fpmalta.com> (Last accessed: 4th May, 2020).
- [9] Association of Anaesthesiologists of Malta. The Training Programme in Anaesthesiology, Pain and Intensive Care Medicine; 2015. https://health.gov.mt/en/regcounc/msac/documents/anaesthesiology_training_programme_in_malta_2015_jan.pdf (Accessed 4th May, 2020).
- [10] Munro J, Booth A, Nicholl J. Routine preoperative testing: a systematic review of the evidence. *Health Technol Assess*. 1997;1(12):i–iv; 1–62.

- [11] National Institute for Clinical Excellence. Preoperative Tests: The use of routine preoperative tests for elective surgery. CG3. London: National Institute for Clinical Excellence; 2003.
- [12] National Institute for Clinical Excellence. Preoperative Tests (update): Routine preoperative tests for elective surgery. London: National Institute for Clinical Excellence; 2016.
- [13] Fleisher LA, Beckman JA, Brown KA, Calkins H, Chaikof EL, Chaikof E, et al. ACC/AHA 2007 guidelines on perioperative cardiovascular evaluation and care for noncardiac surgery: a report of the American College of Cardiology/American Heart Association Task Force on Practice Guidelines (Writing Committee to Revise the 2002 Guidelines on Perioperative Cardiovascular Evaluation for Noncardiac Surgery) developed in collaboration with the American Society of Echocardiography, American Society of Nuclear Cardiology, Heart Rhythm Society, Society of Cardiovascular Anesthesiologists, Society for Cardiovascular Angiography and Interventions, Society for Vascular Medicine and Biology, and Society for Vascular Surgery. *J Am Coll Cardiol.* 2007;50(17):e159–e241.
- [14] Authors/Task Force Members, Poldermans D, Bax JJ, Boersma E, De Hert S, Eeckhout E, et al. Guidelines for pre-operative cardiac risk assessment and perioperative cardiac management in non-cardiac surgery: The Task Force for Preoperative Cardiac Risk Assessment and Perioperative Cardiac Management in Non-cardiac Surgery of the European Society of Cardiology (ESC) and endorsed by the European Society of Anaesthesiology (ESA),. *Eur Heart J.* 2009;30(22):2769–2812.
- [15] Czoski-Murray C, Lloyd Jones M, McCabe C, Claxton K, Oluboyede Y, Roberts J, et al. What is the value of routinely testing full blood count, electrolytes and urea, and pulmonary function tests before elective surgery in patients with no apparent clinical indication and in subgroups of patients with common comorbidities: a systematic review of the clinical and cost-effective literature. *Health Technol Assess.* 2012;16(50):i–xvi, 1–159.
- [16] Johansson T, Fritsch G, Flamm M, Hansbauer B, Bachofner N, Mann E, et al. Effectiveness of non-cardiac preoperative testing in non-cardiac elective surgery: a systematic review. *Br J Anaesth.* 2013;110:926–939.
- [17] De Hert S, Staender S, Fritsch G, Hinkelbein J, Afshari A, Bettelli G, et al. Pre-operative evaluation of adults undergoing elective noncardiac surgery: Updated guideline from the European Society of Anaesthesiology. *Eur J Anaesthesiol.* 2018;35:407–465.

- [18] Reynolds TM. National Institute for Health and Clinical Excellence guidelines on preoperative tests: the use of routine preoperative tests for elective surgery. *Ann Clin Biochem.* 2006;43(Pt 1):13–16.
- [19] Ahmadian L, Cornet R, van Klei WA, de Keizer NF. Diversity in preoperative-assessment data collection, a literature review. *Stud Health Technol Inform.* 2008;136:127–132.
- [20] Kluger MT, Tham EJ, Coleman NA, Runciman WB, Bullock MF. Inadequate pre-operative evaluation and preparation: a review of 197 reports from the Australian incident monitoring study. *Anaesthesia.* 2000;55(12):1173–1178.
- [21] Lee TH, Marcantonio ER, Mangione CM, Thomas EJ, Polanczyk CA, Cook EF, et al. Derivation and prospective validation of a simple index for prediction of cardiac risk of major noncardiac surgery. *Circulation.* 1999;100(10):1043–1049.
- [22] Copeland GP, Jones D, Walters M. POSSUM: a scoring system for surgical audit. *Br J Surg.* 1991;78(3):355–360.
- [23] Khuri SF, Daley J, Henderson W, Hur K, Gibbs JO, Barbour G, et al. Risk adjustment of the postoperative mortality rate for the comparative assessment of the quality of surgical care: results of the National Veterans Affairs Surgical Risk Study. *J Am Coll Surg.* 1997;185(4):315–327.
- [24] Daley J, Khuri SF, Henderson W, Hur K, Gibbs JO, Barbour G, et al. Risk adjustment of the postoperative morbidity rate for the comparative assessment of the quality of surgical care: results of the National Veterans Affairs Surgical Risk Study. *J Am Coll Surg.* 1997;185(4):328–340.
- [25] Fritsch G, Flamm M, Hepner DL, Panisch S, Seer J, Soennichsen A. Abnormal pre-operative tests, pathologic findings of medical history, and their predictive value for perioperative complications. *Acta Anaesthesiol Scand.* 2012;56(3):339–350.
- [26] Ausset S, Bouaziz H, Brosseau M, Kinirons B, Benhamou D. Improvement of information gained from the pre-anaesthetic visit through a quality-assurance programme. *Br J Anaesth.* 2002;88(2):280–283.
- [27] Badner NH, Craen RA, Paul TL, Doyle JA. Anaesthesia preadmission assessment: a new approach through use of a screening questionnaire. *Can J Anaesth.* 1998;45(1):87–92.
- [28] Hilditch WG, Asbury AJ, Crawford JM. Pre-operative screening: criteria for referring to anaesthetists. *Anaesthesia.* 2003;58(2):117–124.

- [29] Hilditch WG, Asbury AJ, Jack E, McGrane S. Validation of a pre-anaesthetic screening questionnaire. *Anaesthesia*. 2003;58(9):874–877.
- [30] van Klei WA, Grobbee DE, Rutten CL, Hennis PJ, Knape JT, Kalkman CJ, et al. Role of history and physical examination in preoperative evaluation. *Eur J Anaesthesiol*. 2003;20(8):612–618.
- [31] van Gelder FE, de Graaff JC, van Wolfswinkel L, van Klei WA. Preoperative testing in noncardiac surgery patients: a survey amongst European anaesthesiologists. *Eur J Anaesthesiol*. 2012;29(10):465–470.
- [32] Ahmadian L, Cornet R, Kalkman C, de Keizer NF, N V A Working Group ‘Minimal Dataset for Preoperative Assessment’. Development of a national core dataset for preoperative assessment. *Methods Inf Med*. 2009;48(2):155–161.
- [33] Saklad M. Grading of patients for surgical procedures. *Anesthesiology*. 1941;2:281–284.
- [34] Owens WD, Felts JA, Spitznagel E Jr. ASA physical status classifications: a study of consistency of ratings. *Anesthesiology*. 1978;49(4):239–243. Available from: <https://doi.org/10.1097/00000542-197810000-00003>.
- [35] Mak PHK, Campbell RCH, Irwin MG, of Anesthesiologists AS. The ASA Physical Status Classification: inter-observer consistency. *American Society of Anesthesiologists. Anaesth Intensive Care*. 2002;30:633–640.
- [36] Haynes SR, Lawler PG. An assessment of the consistency of ASA physical status classification allocation. *Anaesthesia*. 1995;50(3):195–199.
- [37] Aronson WL, McAuliffe MS, Miller K. Variability in the American Society of Anesthesiologists Physical Status Classification Scale. *AANA journal*. 2003;71:265–274.
- [38] Zuidema X, Tromp Meesters RC, Siccama I, Houweling PL. Computerized model for preoperative risk assessment. *British journal of anaesthesia*. 2011 Aug;107:180–185.
- [39] American Society of Anaesthesiologists. ASA Physical Status Classification System; 2020. <https://www.asahq.org/standards-and-guidelines/asa-physical-status-classification-system> (Accessed 28th September, 2019). Available from: <https://www.asahq.org/standards-and-guidelines/asa-physical-status-classification-system>.

- [40] Hlatky MA, Boineau RE, Higginbotham MB, Lee KL, Mark DB, Califf RM, et al. A brief self-administered questionnaire to determine functional capacity (the Duke Activity Status Index). *Am J Cardiol.* 1989;64(10):651–654.
- [41] Wijeyesundera DN, Pearse RM, Shulman MA, Abbott TEF, Torres E, Ambosta A, et al. Assessment of functional capacity before major non-cardiac surgery: an international, prospective cohort study. *Lancet.* 2018;391:2631–2640.
- [42] West MA, Asher R, Browning M, Minto G, Swart M, Richardson K, et al. Validation of preoperative cardiopulmonary exercise testing-derived variables to predict in-hospital morbidity after major colorectal surgery. *Br J Surg.* 2016;103:744–752.
- [43] Lienhart A, Auroy Y, Péquignot F, Benhamou D, Warszawski J, Bovet M, et al. Survey of anesthesia-related mortality in France. *Anesthesiology.* 2006;105(6):1087–1097.
- [44] Cheney FW, Posner KL, Lee LA, Caplan RA, Domino KB. Trends in anesthesia-related death and brain damage: A closed claims analysis. *Anesthesiology.* 2006;105(6):1081–1086.
- [45] Auroy Y, Benhamou D, Péquignot F, Bovet M, Jouglu E, Lienhart A. Mortality related to anaesthesia in France: analysis of deaths related to airway complications. *Anaesthesia.* 2009;64(4):366–370.
- [46] Li G, Warner M, Lang BH, Huang L, Sun LS. Epidemiology of anesthesia-related mortality in the United States, 1999-2005. *Anesthesiology.* 2009;110(4):759–765.
- [47] McPherson D, Vaughan RS, Wilkes AR, Mapleson WW, Hodzovic I. A survey of anaesthetic practice in predicting difficult intubation in UK and Europe. *Eur J Anaesthesiol.* 2012;29(5):218–222.
- [48] Hester CE, Dietrich SA, White SW, Secrest JA, Lindgren KR, Smith T. A comparison of preoperative airway assessment techniques: the modified Mallampati and the upper lip bite test. *AANA J.* 2007;75(3):177–182.
- [49] Safavi M, Honarmand A, Amoushahi M. Prediction of difficult laryngoscopy: Extended mallampati score versus the MMT, ULBT and RHTMD. *Adv Biomed Res.* 2014;3:133.
- [50] Cattano D, Killoran PV, Iannucci D, Maddukuri V, Altamirano AV, Sridhar S, et al. Anticipation of the difficult airway: preoperative airway assessment, an educational and quality improvement tool. *Br J Anaesth.* 2013;111(2):276–285.

- [51] Böhmer AB, Wappler F, Zwissler B. Preoperative risk assessment—from routine tests to individualized investigation. *Dtsch Arztebl Int.* 2014;111(25):437–446.
- [52] Bonhomme F, Ajzenberg N, Schved JF, Molliex S, Samama CM, FA, et al. Pre-interventional haemostatic assessment: Guidelines from the French Society of Anaesthesia and Intensive Care. *Eur J Anaesthesiol.* 2013;30(4):142–162.
- [53] Schein OD, Katz J, Bass EB, Tielsch JM, Lubomski LH, Feldman MA, et al. The value of routine preoperative medical testing before cataract surgery. Study of Medical Testing for Cataract Surgery. *N Engl J Med.* 2000;342(3):168–175.
- [54] Keay L, Lindsley K, Tielsch J, Katz J, Schein O. Routine preoperative medical testing for cataract surgery. *Cochrane Database Syst Rev.* 2009;(2):CD007293.
- [55] Keay L, Lindsley K, Tielsch J, Katz J, Schein O. Routine preoperative medical testing for cataract surgery. *Cochrane Database Syst Rev.* 2012;3:CD007293.
- [56] Chung F, Yuan H, Yin L, Vairavanathan S, Wong DT. Elimination of preoperative testing in ambulatory surgery. *Anesth Analg.* 2009;108(2):467–475.
- [57] Fleisher LA, Fleischmann KE, Auerbach AD, Barnason SA, Beckman JA, Bozkurt B, et al. 2014 ACC/AHA guideline on perioperative cardiovascular evaluation and management of patients undergoing noncardiac surgery: a report of the American College of Cardiology/American Heart Association Task Force on practice guidelines. *J Am Coll Cardiol.* 2014;64:e77–137.
- [58] Noordzij PG, Boersma E, Bax JJ, Feringa HHH, Schreiner F, Schouten O, et al. Prognostic value of routine preoperative electrocardiography in patients undergoing noncardiac surgery. *Am J Cardiol.* 2006;97(7):1103–1106.
- [59] Duceppe E, Parlow J, MacDonald P, Lyons K, McMullen M, Srinathan S, et al. Canadian Cardiovascular Society Guidelines on Perioperative Cardiac Risk Assessment and Management for Patients Who Undergo Noncardiac Surgery. *Can J Cardiol.* 2017;33:17–32.
- [60] van Klei WA, Kalkman CJ, Tolsma M, Rutten CL, Moons KG. Preoperative detection of valvular heart disease by anaesthetists. *Anaesthesia.* 2006;61(2):127–132.
- [61] Bonow RO, Carabello BA, Chatterjee K, de Leon JAC, Faxon DP, Freed MD, et al. 2008 focused update incorporated into the ACC/AHA 2006 guidelines for the management of patients with

- valvular heart disease: a report of the American College of Cardiology/American Heart Association Task Force on Practice Guidelines (Writing Committee to revise the 1998 guidelines for the management of patients with valvular heart disease). Endorsed by the Society of Cardiovascular Anesthesiologists, Society for Cardiovascular Angiography and Interventions, and Society of Thoracic Surgeons. *J Am Coll Cardiol.* 2008;52(13):e1–142.
- [62] Canty DJ, Royse CF. Audit of anaesthetist-performed echocardiography on perioperative management decisions for non-cardiac surgery. *Br J Anaesth.* 2009;103(3):352–358.
- [63] Canty DJ, Royse CF, Kilpatrick D, Bowman L, Royse AG. The impact of focused transthoracic echocardiography in the pre-operative clinic. *Anaesthesia.* 2012;67(6):618–625.
- [64] Canty DJ, Royse CF, Kilpatrick D, Williams DL, Royse AG. The impact of pre-operative focused transthoracic echocardiography in emergency non-cardiac surgery patients with known or risk of cardiac disease. *Anaesthesia.* 2012;67(7):714–720.
- [65] Canty DJ, Royse CF, Kilpatrick D, Bowyer A, Royse AG. The impact on cardiac diagnosis and mortality of focused transthoracic echocardiography in hip fracture surgery patients with increased risk of cardiac disease: a retrospective cohort study. *Anaesthesia.* 2012;67(11):1202–1209.
- [66] Biccard BM. Improving the evidence-base for preoperative cardiopulmonary exercise testing. *Br J Anaesth.* 2018;120:419–421.
- [67] Grant SW, Hickey GL, Wisely NA, Carlson ED, Hartley RA, Pichel AC, et al. Cardiopulmonary exercise testing and survival after elective abdominal aortic aneurysm repair. *Br J Anaesth.* 2015;114:430–436.
- [68] Moran J, Wilson F, Guinan E, McCormick P, Hussey J, Moriarty J. Role of cardiopulmonary exercise testing as a risk-assessment method in patients undergoing intra-abdominal surgery: a systematic review. *Br J Anaesth.* 2016;116:177–191.
- [69] Swart M, Carlisle JB, Goddard J. Using predicted 30 day mortality to plan postoperative colorectal surgery care: a cohort study. *Br J Anaesth.* 2017;118:100–104.
- [70] Bramley P, Brown J. Cause for scepticism regarding preoperative cardiopulmonary exercise testing. *Br J Anaesth.* 2018;121:496–497.
- [71] Kristensen SD, Knuuti J, Saraste A, Anker S, Bøtker HE, De Hert S, et al. 2014 ESC/ESA Guidelines on non-cardiac surgery: cardiovascular assessment and management: The Joint Task Force on non-cardiac surgery: cardiovascular assessment and management of the European

- Society of Cardiology (ESC) and the European Society of Anaesthesiology (ESA). *Eur J Anaesthesiol.* 2014;.
- [72] Wijeyesundera DN, Beattie WS, Hillis GS, Abbott TEF, Shulman MA, Ackland GL, et al. Integration of the Duke Activity Status Index into preoperative risk evaluation: a multicentre prospective cohort study. *Br J Anaesth.* 2020;124:261–270.
- [73] Perioperative Exercise Testing and Training Society. Perioperative Exercise Testing and Training Society; 2020. <https://www.poetts.co.uk> (Accessed 8th August, 2020).
- [74] Levett DZH, Jack S, Swart M, Carlisle J, Wilson J, Snowden C, et al. Perioperative cardiopulmonary exercise testing (CPET): consensus clinical guidelines on indications, organization, conduct, and physiological interpretation. *Br J Anaesth.* 2018;120:484–500.
- [75] Qaseem A, Snow V, Fitterman N, Hornbake ER, Lawrence VA, Smetana GW, et al. Risk assessment for and strategies to reduce perioperative pulmonary complications for patients undergoing noncardiothoracic surgery: a guideline from the American College of Physicians. *Ann Intern Med.* 2006;144(8):575–580.
- [76] Smetana GW, Lawrence VA, Cornell JE, ACoP. Preoperative pulmonary risk stratification for noncardiothoracic surgery: systematic review for the American College of Physicians. *Ann Intern Med.* 2006;144(8):581–595.
- [77] Ohrlander T, Dencker M, Acosta S. Preoperative spirometry results as a determinant for long-term mortality after EVAR for AAA. *Eur J Vasc Endovasc Surg.* 2012;43(1):43–47.
- [78] Ad N, Henry L, Halpin L, Hunt S, Barnett S, Crippen P, et al. The use of spirometry testing prior to cardiac surgery may impact the Society of Thoracic Surgeons risk prediction score: a prospective study in a cohort of patients at high risk for chronic lung disease. *J Thorac Cardiovasc Surg.* 2010;139(3):686–691.
- [79] Gonzalez R, Bowers SP, Venkatesh KR, Lin E, Smith CD. Preoperative factors predictive of complicated postoperative management after Roux-en-Y gastric bypass for morbid obesity. *Surg Endosc.* 2003;17(12):1900–1904.
- [80] van Huisstede A, Biter LU, Luitwieler R, Castro Cabezas M, Mannaerts G, Birnie E, et al. Pulmonary function testing and complications of laparoscopic bariatric surgery. *Obes Surg.* 2013;23(10):1596–1603.

- [81] Clavellina-Gaytán D, Velázquez-Fernández D, Del-Villar E, Domínguez-Cherit G, Sánchez H, Mosti M, et al. Evaluation of Spirometric Testing as a Routine Preoperative Assessment in Patients Undergoing Bariatric Surgery. *Obes Surg*. 2014;.
- [82] Dunkelgrun M, Hoeks SE, Welten GMJM, Vidakovic R, Winkel TA, Schouten O, et al. Anemia as an independent predictor of perioperative and long-term cardiovascular outcome in patients scheduled for elective vascular surgery. *Am J Cardiol*. 2008;101(8):1196–1200.
- [83] Diehm N, Benenati JF, Becker GJ, Quesada R, Tsoukas AI, Katzen BT, et al. Anemia is associated with abdominal aortic aneurysm (AAA) size and decreased long-term survival after endovascular AAA repair. *J Vasc Surg*. 2007;46(4):676–681.
- [84] Wu WC, Schiffner TL, Henderson WG, Eaton CB, Poses RM, Utley G, et al. Preoperative hematocrit levels and postoperative outcomes in older patients undergoing noncardiac surgery. *JAMA*. 2007;297(22):2481–2488.
- [85] Cockcroft DW, Gault MH. Prediction of creatinine clearance from serum creatinine. *Nephron*. 1976;16(1):31–41.
- [86] Levey AS, Bosch JP, Lewis JB, Greene T, Rogers N, Roth D. A more accurate method to estimate glomerular filtration rate from serum creatinine: a new prediction equation. Modification of Diet in Renal Disease Study Group. *Ann Intern Med*. 1999;130(6):461–470.
- [87] National Institute for Clinical Excellence. Acute kidney injury: prevention, detection and management. London: National Institute for Clinical Excellence; 2019.
- [88] Kheterpal S, Tremper KK, Heung M, Rosenberg AL, Englesbe M, Shanks AM, et al. Development and validation of an acute kidney injury risk index for patients undergoing general surgery: results from a national data set. *Anesthesiology*. 2009;110(3):505–515.
- [89] Seicean A, Schiltz NK, Seicean S, Alan N, Neuhauser D, Weil RJ. Use and utility of preoperative hemostatic screening and patient history in adult neurosurgical patients. *J Neurosurg*. 2012;116(5):1097–1105.
- [90] Feringa HHH, Vidakovic R, Karagiannis SE, Dunkelgrun M, Elhendy A, Boersma E, et al. Impaired glucose regulation, elevated glycated haemoglobin and cardiac ischaemic events in vascular surgery patients. *Diabet Med*. 2008;25(3):314–319.
- [91] Martin ET, Kaye KS, Knott C, Nguyen H, Santarossa M, Evans R, et al. Diabetes and Risk of Surgical Site Infection: A Systematic Review and Meta-analysis. *Infect Control Hosp Epidemiol*. 2016;37:88–99.

- [92] Jämsen E, Nevalainen P, Kalliovalkama J, Moilanen T. Preoperative hyperglycemia predicts infected total knee replacement. *Eur J Intern Med.* 2010;21(3):196–201.
- [93] Fei Q, Li J, Lin J, Li D, Wang B, Meng H, et al. Risk Factors for Surgical Site Infection After Spinal Surgery: A Meta-Analysis. *World Neurosurg.* 2016;95:507–515.
- [94] Peng XQ, Sun CG, Fei ZG, Zhou QJ. Risk Factors for Surgical Site Infection After Spinal Surgery: A Systematic Review and Meta-Analysis Based on Twenty-Seven Studies. *World Neurosurg.* 2019;123:e318–e329.
- [95] van den Berghe G, Wouters P, Weekers F, Verwaest C, Bruyninckx F, Schetz M, et al. Intensive insulin therapy in critically ill patients. *N Engl J Med.* 2001;345(19):1359–1367.
- [96] Gandhi GY, Nuttall GA, Abel MD, Mullany CJ, Schaff HV, O'Brien PC, et al. Intensive intraoperative insulin therapy versus conventional glucose management during cardiac surgery: a randomized trial. *Ann Intern Med.* 2007;146(4):233–243.
- [97] Bock M, Johansson T, Fritsch G, Flamm M, Hansbauer B, Mann E, et al. The impact of preoperative testing for blood glucose concentration and haemoglobin A1c on mortality, changes in management and complications in noncardiac elective surgery: A systematic review. *Eur J Anaesthesiol.* 2014;.
- [98] McAlister FA, Khan NA, Straus SE, Papaioakim M, Fisher BW, Majumdar SR, et al. Accuracy of the preoperative assessment in predicting pulmonary risk after nonthoracic surgery. *Am J Respir Crit Care Med.* 2003;167(5):741–744.
- [99] Arozullah AM, Daley J, Henderson WG, Khuri SF. Multifactorial risk index for predicting postoperative respiratory failure in men after major noncardiac surgery. The National Veterans Administration Surgical Quality Improvement Program. *Ann Surg.* 2000;232(2):242–253.
- [100] Ollivere BJ, Ellahee N, Logan K, Miller-Jones JCA, Allen PW. Asymptomatic urinary tract colonisation predisposes to superficial wound infection in elective orthopaedic surgery. *Int Orthop.* 2009;33(3):847–850.
- [101] Kahn RL, Stanton MA, Tong-Ngork S, Liguori GA, Edmonds CR, Levine DS. One-year experience with day-of-surgery pregnancy testing before elective orthopedic procedures. *Anesth Analg.* 2008;106(4):1127–31, table of contents.

- [102] Huyse FJ, Touw DJ, van Schijndel RS, de Lange JJ, Slaets JPJ. Psychotropic drugs and the perioperative period: a proposal for a guideline in elective surgery. *Psychosomatics*. 2006;47(1):8–22.
- [103] Kudoh A, Katagai H, Takazawa T. Antidepressant treatment for chronic depressed patients should not be discontinued prior to anesthesia. *Can J Anaesth*. 2002;49(2):132–136.
- [104] Kudoh A, Katagai H, Takase H, Takazawa T. Effect of preoperative discontinuation of antipsychotics in schizophrenic patients on outcome during and after anaesthesia. *Eur J Anaesthesiol*. 2004;21(5):414–416.
- [105] Shammash JB, Trost JC, Gold JM, Berlin JA, Golden MA, Kimmel SE. Perioperative beta-blocker withdrawal and mortality in vascular surgical patients. *Am Heart J*. 2001;141(1):148–153.
- [106] Hoeks SE, Scholte Op Reimer WJM, van Urk H, Jörning PJG, Boersma E, Simoons ML, et al. Increase of 1-year mortality after perioperative beta-blocker withdrawal in endovascular and vascular surgery patients. *Eur J Vasc Endovasc Surg*. 2007;33(1):13–19.
- [107] Wallace AW, Au S, Cason BA. Association of the pattern of use of perioperative β -blockade and postoperative mortality. *Anesthesiology*. 2010;113(4):794–805.
- [108] Kwon S, Thompson R, Florence M, Maier R, McIntyre L, Rogers T, et al. β -blocker continuation after noncardiac surgery: a report from the surgical care and outcomes assessment program. *Arch Surg*. 2012;147(5):467–473.
- [109] London MJ, Hur K, Schwartz GG, Henderson WG. Association of perioperative β -blockade with mortality and cardiovascular morbidity following major noncardiac surgery. *JAMA*. 2013;309(16):1704–1713.
- [110] Devereaux PJ, Yang H, Yusuf S, Guyatt G, Leslie K, Villar JC, et al. Effects of extended-release metoprolol succinate in patients undergoing non-cardiac surgery (POISE trial): a randomised controlled trial. *Lancet*. 2008;371:1839–1847.
- [111] Le Manach Y, Godet G, Coriat P, Martinon C, Bertrand M, Fléron MH, et al. The impact of postoperative discontinuation or continuation of chronic statin therapy on cardiac outcome after major vascular surgery. *Anesth Analg*. 2007;104(6):1326–33, table of contents.
- [112] Burger W, Chemnitz JM, Kneissl GD, Rücker G. Low-dose aspirin for secondary cardiovascular prevention - cardiovascular risks after its perioperative withdrawal versus bleeding risks with its continuation - review and meta-analysis. *J Intern Med*. 2005;257(5):399–414.

- [113] Devereaux PJ, Mrkobrada M, Sessler DI, Leslie K, Alonso-Coello P, Kurz A, et al. Aspirin in patients undergoing noncardiac surgery. *N Engl J Med*. 2014;370(16):1494–1503.
- [114] Widimský P, Mořovská Z, Havlůj L, Ondráková M, Bartoška R, Bittner L, et al. Perioperative cardiovascular complications versus perioperative bleeding in consecutive patients with known cardiac disease undergoing non-cardiac surgery. Focus on antithrombotic medication. The PRAGUE-14 registry. *Neth Heart J*. 2014;22(9):372–379.
- [115] Wijeyesundera DN, Beattie WS. Calcium channel blockers for reducing cardiac morbidity after noncardiac surgery: a meta-analysis. *Anesth Analg*. 2003;97(3):634–641.
- [116] Kertai MD, Westerhout CM, Varga KS, Acsady G, Gal J. Dihydropyridine calcium-channel blockers and perioperative mortality in aortic aneurysm surgery. *Br J Anaesth*. 2008;101(4):458–465.
- [117] Moonesinghe SR, Mythen MG, Das P, Rowan KM, Grocott MPW. Risk stratification tools for predicting morbidity and mortality in adult patients undergoing major surgery: qualitative systematic review. *Anesthesiology*. 2013;119:959–981.
- [118] Barnett S, Moonesinghe SR. Clinical risk scores to guide perioperative management. *Postgrad Med J*. 2011;87(1030):535–541.
- [119] Gawande AA, Kwaan MR, Regenbogen SE, Lipsitz SA, Zinner MJ. An Apgar score for surgery. *Journal of the American College of Surgeons*. 2007 Feb;204:201–208.
- [120] Nashef SAM, Roques F, Sharples LD, Nilsson J, Smith C, Goldstone AR, et al. EuroSCORE II. *European journal of cardio-thoracic surgery : official journal of the European Association for Cardio-thoracic Surgery*. 2012 Apr;41:734–44; discussion 744–5.
- [121] Maxwell MJ, Moran CG, Moppett IK. Development and validation of a preoperative scoring system to predict 30 day mortality in patients undergoing hip fracture surgery. *British journal of anaesthesia*. 2008 Oct;101:511–517.
- [122] Kwok AC, Lipsitz SR, Bader AM, Gawande AA. Are targeted preoperative risk prediction tools more powerful? A test of models for emergency colon surgery in the very elderly. *Journal of the American College of Surgeons*. 2011 Aug;213:220–225.
- [123] DRIPPS RD, LAMONT A, ECKENHOFF JE. The role of anesthesia in surgical mortality. *JAMA*. 1961;178:261–266.
- [124] Dripps RD. New classification of physical status. *Anesthesiology*. 1963;24:111.

- [125] Wolters U, Wolf T, Stützer H, Schröder T. ASA classification and perioperative variables as predictors of postoperative outcome. *Br J Anaesth.* 1996;77:217–222.
- [126] Cullen DJ, Apolone G, Greenfield S, Guadagnoli E, Cleary P. ASA Physical Status and age predict morbidity after three surgical procedures. *Ann Surg.* 1994;220:3–9.
- [127] Davenport DL, Bowe EA, Henderson WG, Khuri SF, Mentzer RM. National Surgical Quality Improvement Program (NSQIP) risk factors can be used to validate American Society of Anesthesiologists Physical Status Classification (ASA PS) levels. *Ann Surg.* 2006;243:636–41; discussion 641–4.
- [128] Fodor R, Cioc A, Grigorescu B, Lăzescu B, Copotoiu SM. Evaluation of O-POSSUM vs ASA and APACHE II scores in patients undergoing oesophageal surgery. *Rom J Anaesth Intensive Care.* 2015;22:7–12.
- [129] Sutton R, Bann S, Brooks M, Sarin S. The Surgical Risk Scale as an improved tool for risk-adjusted analysis in comparative surgical audit. *Br J Surg.* 2002;89:763–768.
- [130] Brooks MJ, Sutton R, Sarin S. Comparison of Surgical Risk Score, POSSUM and p-POSSUM in higher-risk surgical patients. *The British journal of surgery.* 2005 Oct;92:1288–1292.
- [131] Constantinides VA, Tekkis PP, Senapati A, of Coloproctology of Great Britain A, Ireland. Comparison of POSSUM scoring systems and the surgical risk scale in patients undergoing surgery for complicated diverticular disease. *Diseases of the colon and rectum.* 2006 Sep;49:1322–1331.
- [132] Stornes T, Wibe A, Endreseth BH. Complications and risk prediction in treatment of elderly patients with rectal cancer. *International journal of colorectal disease.* 2016 Jan;31:87–93.
- [133] Wong DJN, Harris S, Sahni A, Bedford JR, Cortes L, Shawyer R, et al. Developing and validating subjective and objective risk-assessment measures for predicting mortality after major surgery: An international prospective cohort study. *PLoS medicine.* 2020 Oct;17:e1003253.
- [134] González-Martínez S, Martín-Baranera M, Martí-Saurí I, Borrell-Grau N, Pueyo-Zurdo JM. Comparison of the risk prediction systems POSSUM and P-POSSUM with the Surgical Risk Scale: A prospective cohort study of 721 patients. *International journal of surgery (London, England).* 2016 May;29:19–24.

- [135] Ngulube A, Muguti GI, Muguti EG. Validation of POSSUM, P-POSSUM and the surgical risk scale in major general surgical operations in Harare: A prospective observational study. *Annals of medicine and surgery* (2012). 2019 May;41:33–39.
- [136] Glance LG, Lustik SJ, Hannan EL, Osler TM, Mukamel DB, Qian F, et al. The Surgical Mortality Probability Model: derivation and validation of a simple risk prediction rule for noncardiac surgery. *Annals of surgery*. 2012 Apr;255:696–702.
- [137] Kazimierczak S, Rybicka A, Strauss J, Schram M, Kazimierczak A, Grochans E. External Validation Of The Surgical Mortality Probability Model (S-MPM) In Patients Undergoing Non-Cardiac Surgery. *Therapeutics and clinical risk management*. 2019;15:1173–1182.
- [138] Donati A, Ruzzi M, Adrario E, Pelaia P, Coluzzi F, Gabbanelli V, et al. A new and feasible model for predicting operative risk. *Br J Anaesth*. 2004;93:393–399.
- [139] Haga Y, Ikejiri K, Wada Y, Takahashi T, Ikenaga M, Akiyama N, et al. A multicenter prospective study of surgical audit systems. *Annals of surgery*. 2011 Jan;253:194–201.
- [140] Le Manach Y, Collins G, Rodseth R, Le Bihan-Benjamin C, Biccard B, Riou B, et al. Preoperative Score to Predict Postoperative Mortality (POSPOM): Derivation and Validation. *Anesthesiology*. 2016;124:570–579.
- [141] Juul S, Kokotovic D, Degett TH, Oreskov JO, Ekeloef S, Gögenur I, et al. Validation of the preoperative score to predict postoperative mortality (POSPOM) in patients undergoing major emergency abdominal surgery. *European journal of trauma and emergency surgery : official publication of the European Trauma Society*. 2019 Jun;.
- [142] Reis P, Lopes AI, Leite D, Moreira J, Mendes L, Ferraz S, et al. Predicting mortality in patients admitted to the intensive care unit after open vascular surgery. *Surgery today*. 2019 Oct;49:836–842.
- [143] Reis P, Lopes AI, Leite D, Moreira J, Mendes L, Ferraz S, et al. Incidence, predictors and validation of risk scores to predict postoperative mortality after noncardiac vascular surgery, a prospective cohort study. *International journal of surgery (London, England)*. 2020 Jan;73:89–93.
- [144] Froehner M, Koch R, Hübler M, Heberling U, Novotny V, Zastrow S, et al. Validation of the Preoperative Score to Predict Postoperative Mortality in Patients Undergoing Radical Cystectomy. *European urology focus*. 2019 Mar;5:197–200.

- [145] Layer YC, Menzenbach J, Layer YL, Mayr A, Hilbert T, Velten M, et al. Validation of the Preoperative Score to Predict Postoperative Mortality (POSPOM) in Germany. *PloS one*. 2021;16:e0245841.
- [146] Charlson ME, Pompei P, Ales KL, MacKenzie CR. A new method of classifying prognostic comorbidity in longitudinal studies: development and validation. *J Chronic Dis*. 1987;40:373–383.
- [147] Charlson M, Szatrowski TP, Peterson J, Gold J. Validation of a combined comorbidity index. *J Clin Epidemiol*. 1994;47:1245–1251.
- [148] Froehner M, Koch R, Litz R, Heller A, Oehlschlaeger S, Wirth MP. Comparison of the American Society of Anesthesiologists Physical Status classification with the Charlson score as predictors of survival after radical prostatectomy. *Urology*. 2003 Oct;62:698–701.
- [149] Ouellette JR, Small DG, Termuhlen PM. Evaluation of Charlson-Age Comorbidity Index as predictor of morbidity and mortality in patients with colorectal carcinoma. *Journal of gastrointestinal surgery : official journal of the Society for Surgery of the Alimentary Tract*. 2004 Dec;8:1061–1067.
- [150] Dias-Santos D, Ferrone CR, Zheng H, Lillemoe KD, Fernández-Del Castillo C. The Charlson age comorbidity index predicts early mortality after surgery for pancreatic cancer. *Surgery*. 2015 May;157:881–887.
- [151] St-Louis E, Iqbal S, Feldman LS, Sudarshan M, Deckelbaum DL, Razek TS, et al. Using the age-adjusted Charlson comorbidity index to predict outcomes in emergency general surgery. *The journal of trauma and acute care surgery*. 2015 Feb;78:318–323.
- [152] Nelson MJ, Scott J, Sivalingam P. Evaluation of Nottingham Hip Fracture Score, Age-Adjusted Charlson Comorbidity Index and the Physiological and Operative Severity Score for the enumeration of Mortality and morbidity as predictors of mortality in elderly neck of femur fracture patients. *SAGE open medicine*. 2020;8:2050312120918268.
- [153] Toson B, Harvey LA, Close JCT. The ICD-10 Charlson Comorbidity Index predicted mortality but not resource utilization following hip fracture. *Journal of clinical epidemiology*. 2015 Jan;68:44–51.
- [154] Moodley Y. Outcome-specific Charlson Comorbidity Indices for Predicting Poor Inpatient Outcomes Following Noncardiac Surgery Using Hospital Administrative Data. *Medical care*. 2016 Dec;54:1082–1088.
- [155] Bilimoria KY, Liu Y, Paruch JL, Zhou L, Kmiecik TE, Ko CY, et al. Development and evaluation of the universal ACS NSQIP surgical risk

- calculator: a decision aid and informed consent tool for patients and surgeons. *J Am Coll Surg*. 2013;217:833–42.e1–3.
- [156] Protopapa KL, Simpson JC, Smith NCE, Moonesinghe SR. Development and validation of the Surgical Outcome Risk Tool (SORT). *The British journal of surgery*. 2014 Dec;101:1774–1783.
- [157] Findlay G, Goodwin A, Protopapa K, Smith N, Mason M. *Knowing the Risk. A Review of the Perioperative Care of Surgical Patients*, 2011. National Confidential Enquiry into Patient Outcome and Death: London. 2017;.
- [158] Campbell D, Boyle L, Soakell-Ho M, Hider P, Wilson L, Koea J, et al. National risk prediction model for perioperative mortality in non-cardiac surgery. *The British journal of surgery*. 2019 Oct;106:1549–1557.
- [159] Oakland K, Cosentino D, Cross T, Bucknall C, Dorudi S, Walker D. External validation of the Surgical Outcome Risk Tool (SORT) in 3305 abdominal surgery patients in the independent sector in the UK. *Perioperative medicine (London, England)*. 2021 Jan;10:4.
- [160] Magouliotis DE, Walker D, Baloyiannis I, Fergadi MP, Mamaloudis I, Chasiotis G, et al. Validation of the Surgical Outcome Risk Tool (SORT) for Predicting Postoperative Mortality in Colorectal Cancer Patients Undergoing Surgery and Subgroup Analysis. *World journal of surgery*. 2021 Feb;.
- [161] Hoeks SE, Scholte op Reimer WJM, Lenzen MJ, van Urk H, Jörning PJG, Boersma E, et al. Guidelines for cardiac management in non-cardiac surgery are poorly implemented in clinical practice: results from a peripheral vascular survey in the Netherlands. *Anesthesiology*. 2007;107(4):537–544.
- [162] Vigoda MM, Sweitzer B, Miljkovic N, Arheart KL, Messinger S, Candiotti K, et al. 2007 American College of Cardiology/American Heart Association (ACC/AHA) Guidelines on perioperative cardiac evaluation are usually incorrectly applied by anesthesiology residents evaluating simulated patients. *Anesth Analg*. 2011;112(4):940–949.
- [163] Putnis S, Nanuck J, Heath D. An audit of preoperative blood tests. *J Perioper Pract*. 2008;18(2):56–59.
- [164] Pastides P, Tokarczyk S, Ismail L, Ahearne D, Sarraf KM, Sarraf K. Preoperative blood tests: an expensive tick box exercise. *J Perioper Pract*. 2011;21(12):421–424.
- [165] Cabana MD, Rand CS, Powe NR, Wu AW, Wilson MH, Abboud PA, et al. Why don't physicians follow clinical practice guidelines? A framework for improvement. *JAMA*. 1999;282(15):1458–1465.

- [166] Ahmadian L, Cornet R, de Keizer NF. Facilitating pre-operative assessment guidelines representation using SNOMED CT. *J Biomed Inform.* 2010;43(6):883–890.
- [167] Berg B. SDAPS: Scripts for Data Acquisition with Paper-based Surveys; 2014. <http://sdaps.org/> (Accessed: 8 July 2014).
- [168] Bates D, Chambers J, Dalgaard P, Falcon S, Gentleman R, Hornik K, et al.. The R Project for Statistical Computing; 2014. <http://www.r-project.org/> (Last Accessed: 8 July 2014).
- [169] Cook T, Woodall N, Frerk C. Major complications of airway management in the United Kingdom. In: 4th National Audit Project of the Royal College of Anaesthetists and Difficult Airway Society. Royal College of Anaesthetists; 2011. p. 135–142.
- [170] Barazzoni F, Grilli R, Amicosante AMV, Brescianini S, Marca MA, Baggi M, et al. Impact of end user involvement in implementing guidelines on routine pre-operative tests. *Int J Qual Health Care.* 2002;14(4):321–327.
- [171] The Royal College of Anaesthetists. Guidance on the Provision of Anaesthesia Services for Pre-operative Assessment and Preparation 2016. In: Guidelines for the Provision of Anaesthetic Services. London: Royal College of Anaesthetists; 2016. .
- [172] Kinley H, Czoski-Murray C, George S, McCabe C, Primrose J, Reilly C, et al. Effectiveness of appropriately trained nurses in preoperative assessment: randomised controlled equivalence/non-inferiority trial. *BMJ.* 2002;325(7376):1323.
- [173] Nicholson A, Coldwell CH, Lewis SR, Smith AF. Nurse-led versus doctor-led preoperative assessment for elective surgical patients requiring regional or general anaesthesia. *Cochrane Database Syst Rev.* 2013;11:CD010160.
- [174] Rushforth H, Bliss A, Burge D, Glasper EA. A pilot randomised controlled trial of medical versus nurse clerking for minor surgery. *Arch Dis Child.* 2000;83(3):223–226.
- [175] Rushforth H, Burge D, Mullee M, Jones S, McDonald H, Glasper EA. Nurse-led paediatric pre operative assessment: an equivalence study. *Paediatr Nurs.* 2006;18(3):23–29.
- [176] van Klei WA, Hennis PJ, Moen J, Kalkman CJ, Moons KGM. The accuracy of trained nurses in pre-operative health assessment: results of the OPEN study. *Anaesthesia.* 2004;59(10):971–978.
- [177] Varughese AM, Byczkowski TL, Wittkugel EP, Kotagal U, Dean Kurth C. Impact of a nurse practitioner-assisted preoperative assessment program on quality. *Paediatr Anaesth.* 2006;16(7):723–733.

- [178] Wittkugel E, Varughese A. Development of a nurse-assisted preanesthesia evaluation program for pediatric outpatient anesthesia. *Paediatr Anaesth*. 2015;25(7):719–726.
- [179] Bouamrane MM, Mair FS. A study of clinical and information management processes in the surgical pre-assessment clinic - The Experience of the Dumfries & Galloway Royal Infirmary Preoperative Clinic. *BMC Med Inform Decis Mak*. 2014;14(1):22. HC.
- [180] Green J, Thorogood N. Observational Methods. In: *Qualitative Methods for Health Research (Introducing Qualitative Methods series)*. SAGE Publications Ltd; 2004. p. 131–154.
- [181] Green J, Thorogood N. In-depth Interviews. In: *Qualitative Methods for Health Research (Introducing Qualitative Methods series)*. SAGE Publications Ltd; 2004. p. 79–106.
- [182] Green J, Thorogood N. Group Interviews. In: *Qualitative Methods for Health Research (Introducing Qualitative Methods series)*. SAGE Publications Ltd; 2004. p. 107–129.
- [183] VOICE Project. 2007. “Mark-up conventions”. Vienna-Oxford International Corpus of English (VOICE) Transcription Conventions [2.1];. http://www.univie.ac.at/voice/documents/VOICE_mark-up_conventions.v2.1.pdf (Last accessed: 20th November, 2016).
- [184] Using LaTeX for Qualitative Data Analysis;. <https://tug.org/pracjourn/2010-1/griffin/griffin.pdf> (Last Accessed 8th December, 2016).
- [185] Gale NK, Heath G, Cameron E, Rashid S, Redwood S. Using the framework method for the analysis of qualitative data in multi-disciplinary health research. *BMC Med Res Methodol*. 2013;13:117.
- [186] Godfrey MM, Nelson EC, Wasson JH, Mohr JJ, Batalden PB. Microsystems in health care: Part 3. Planning patient-centered services. *Jt Comm J Qual Saf*. 2003;29(4):159–170.
- [187] Barach P, Johnson JK. Understanding the complexity of redesigning care around the clinical microsystem. *Qual Saf Health Care*. 2006;15 Suppl 1:i10–i16. HC.
- [188] Kuper A, Lingard L, Levinson W. Critically appraising qualitative research. *BMJ*. 2008;337:a1035. HC.
- [189] Greenberg CC, Regenbogen SE, Studdert DM, Lipsitz SR, Rogers SO, Zinner MJ, et al. Patterns of communication breakdowns resulting in injury to surgical patients. *J Am Coll Surg*. 2007;204(4):533–540.

- [190] Nagpal K, Vats A, Ahmed K, Smith AB, Sevdalis N, Jonannsson H, et al. A systematic quantitative assessment of risks associated with poor communication in surgical care. *Arch Surg.* 2010;145(6):582–588.
- [191] Lyons M. Towards a framework to select techniques for error prediction: supporting novice users in the healthcare sector. *Appl Ergon.* 2009;40(3):379–395.
- [192] Ward J, Clarkson P, Buckle P, Berman J, Lim R, Jun G. Prospective hazard analysis: tailoring prospective methods to a healthcare context; 2010.
- [193] Nagpal K, Vats A, Lamb B, Ashrafiyan H, Sevdalis N, Vincent C, et al. Information transfer and communication in surgery: a systematic review. *Ann Surg.* 2010;252(2):225–239.
- [194] Nagpal K, Arora S, Abboudi M, Vats A, Wong HW, Manchanda C, et al. Postoperative handover: problems, pitfalls, and prevention of error. *Ann Surg.* 2010;252(1):171–176.
- [195] Catchpole KR, de Leval MR, McEwan A, Pigott N, Elliott MJ, McQuillan A, et al. Patient handover from surgery to intensive care: using Formula 1 pit-stop and aviation models to improve safety and quality. *Paediatr Anaesth.* 2007;17(5):470–478.
- [196] Smith AF, Pope C, Goodwin D, Mort M. Interprofessional handover and patient safety in anaesthesia: observational study of handovers in the recovery room. *Br J Anaesth.* 2008;101(3):332–337.
- [197] Koris J, Hopkins C. Improving the quality of the surgical preoperative assessment in a district general hospital. *BMJ Qual Improv Rep.* 2015;4(1).
- [198] Dhesi JK, Swart M. Specialist pre-operative assessment clinics. *Anaesthesia.* 2016;71 Suppl 1:3–8.
- [199] Kinley H, Czoski-Murray C, George S, McCabe C, Primrose J, Reilly C, et al. Effectiveness of appropriately trained nurses in preoperative assessment: randomised controlled equivalence/non-inferiority trial. *BMJ.* 2002;325(7376):1323.
- [200] Edward GM, Biervliet JD, Hollmann MW, Schlack WS, Preckel B. Comparing the organisational structure of the preoperative assessment clinic at eight university hospitals. *Acta Anaesthesiol Belg.* 2008;59(1):33–37.
- [201] Mikulak RJ, McDermott R, Beauregard M. *The Basics of FMEA*, 2nd Edition. Productivity Press; 2008.

- [202] DeRosier J, Stalhandske E, Bagian JP, Nudell T. Using health care Failure Mode and Effect Analysis: the VA National Center for Patient Safety's prospective risk analysis system. *Jt Comm J Qual Improv.* 2002;28(5):248–67, 209.
- [203] Card AJ, Ward JR, Clarkson PJ. Beyond FMEA: the structured what-if technique (SWIFT). *J Healthc Risk Manag.* 2012;31(4):23–29.
- [204] Marx DA, Slonim AD. Assessing patient safety risk before the injury occurs: an introduction to sociotechnical probabilistic risk modelling in health care. *Qual Saf Health Care.* 2003;12 Suppl 2:ii33–ii38.
- [205] Latino RJ. *Patient Safety: The PROACT Root Cause Analysis Approach.* CRC Press; 2008.
- [206] Green J, Thorogood N. *Qualitative Methods for Health Research (Introducing Qualitative Methods series).* SAGE Publications Ltd; 2004.
- [207] Shelton CL, Smith AF, Mort M. Opening up the black box: an introduction to qualitative research methods in anaesthesia. *Anaesthesia.* 2014;69(3):270–280.
- [208] Damelio R. *The Basics of Process Mapping, 2nd Edition.* Productivity Press; 2011.
- [209] Trebble TM, Hansi N, Hydes T, Smith MA, Baker M. Process mapping the patient journey: an introduction. *BMJ.* 2010;341:c4078. HC.
- [210] Dean Franklin B, Shebl NA, Barber N. Failure mode and effects analysis: too little for too much? *BMJ Qual Saf.* 2012;21(7):607–611.
- [211] Ashley L, Armitage G, Neary M, Hollingsworth G. A practical guide to failure mode and effects analysis in health care: making the most of the team and its meetings. *Jt Comm J Qual Patient Saf.* 2010;36(8):351–358.
- [212] Polit D, Hungler B. *Nursing research principles and methods.* Philadelphia: Lippincott Williams & Wilkins; 1995.
- [213] Hasson F, Keeney S, McKenna H. Research guidelines for the Delphi survey technique. *J Adv Nurs.* 2000;32:1008–1015.
- [214] Habraken MMP, Van der Schaaf TW, Leistikow IP, Reijnders-Thijssen PMJ. Prospective risk analysis of health care processes: a systematic evaluation of the use of HFMEA in Dutch health care. *Ergonomics.* 2009;52(7):809–819.
- [215] Norman G. Likert scales, levels of measurement and the “laws” of statistics. *Adv Health Sci Educ Theory Pract.* 2010;15:625–632.

- [216] Keeney S, Hasson F, McKenna HP. A critical review of the Delphi technique as a research methodology for nursing. *Int J Nurs Stud*. 2001;38:195–200.
- [217] Boulkedid R, Abdoul H, Loustau M, Sibony O, Alberti C. Using and reporting the Delphi method for selecting healthcare quality indicators: a systematic review. *PLoS One*. 2011;6:e20476.
- [218] Keeney S, Hasson F, McKenna H. Consulting the oracle: ten lessons from using the Delphi technique in nursing research. *J Adv Nurs*. 2006;53:205–212.
- [219] Pascoe GC. Patient satisfaction in primary health care: a literature review and analysis. *Eval Program Plann*. 1983;6(3-4):185–210.
- [220] Baker R. Pragmatic model of patient satisfaction in general practice: progress towards a theory. *Qual Health Care*. 1997;6:201–204.
- [221] Heidegger T, Saal D, Nübling M. Patient satisfaction with anaesthesia - Part 1: satisfaction as part of outcome - and what satisfies patients. *Anaesthesia*. 2013;68(11):1165–1172.
- [222] Donabedian A. The quality of care. How can it be assessed? *JAMA*. 1988;260(12):1743–1748.
- [223] Cleary PD, McNeil BJ. Patient satisfaction as an indicator of quality care. *Inquiry*. 1988;25(1):25–36.
- [224] Eagle CJ, Davies JM. Current models of “quality” — an introduction for anaesthetists. *Can J Anaesth*. 1993;40(9):851–862.
- [225] Duncan P. Quality: a job well done! *Can J Anaesth*. 1993;40(9):813–815.
- [226] Reuben DB, Tinetti ME. Goal-Oriented Patient Care — An Alternative Health Outcomes Paradigm. *N Engl J Med*. 2012;366(9):777–779. PMID: 22375966.
- [227] Fung D, Cohen MM. Measuring patient satisfaction with anesthesia care: a review of current methodology. *Anesth Analg*. 1998;87(5):1089–1098.
- [228] Heidegger T, Saal D, Nuebling M. Patient satisfaction with anaesthesia care: what is patient satisfaction, how should it be measured, and what is the evidence for assuring high patient satisfaction? *Best Pract Res Clin Anaesthesiol*. 2006;20(2):331–346.
- [229] Fitzpatrick R, Hopkins A. Problems in the conceptual framework of patient satisfaction research: an empirical exploration. *Sociol Health Illn*. 1983;5:297–311.

- [230] Jenkinson C, Coulter A, Bruster S. The Picker Patient Experience Questionnaire: development and validation using data from in-patient surveys in five countries. *Int J Qual Health Care*. 2002;14:353–358.
- [231] Nübling M, Saal D, Heidegger T. Patient satisfaction with anaesthesia - Part 2: construction and quality assessment of questionnaires. *Anaesthesia*. 2013;68(11):1173–1178.
- [232] DeVon HA, Block ME, Moyle-Wright P, Ernst DM, Hayden SJ, Lazara DJ, et al. A psychometric toolbox for testing validity and reliability. *J Nurs Scholarsh*. 2007;39:155–164.
- [233] Streiner DL, Norman GR, Cairney J. Health measurement scales: a practical guide to their development and use. Oxford University Press, USA; 2015.
- [234] Fung D, Cohen M. What do outpatients value most in their anesthesia care? *Can J Anaesth*. 2001;48(1):12–19.
- [235] Hepner DL, Bader AM, Hurwitz S, Gustafson M, Tsen LC. Patient satisfaction with preoperative assessment in a preoperative assessment testing clinic. *Anesth Analg*. 2004;98(4):1099–1105.
- [236] Cleary PD, Edgman-Levitan S, Roberts M, Moloney TW, McMullen W, Walker JD, et al. Patients evaluate their hospital care: a national survey. *Health Aff (Millwood)*. 1991;10:254–267.
- [237] Cleary PD, Edgman-Levitan S, Walker JD, Gerteis M, Delbanco TL. Using patient reports to improve medical care: a preliminary report from 10 hospitals. *Quality management in health care*. 1993;2:31–38.
- [238] Laine C, Davidoff F, Lewis CE, Nelson EC, Nelson E, Kessler RC, et al. Important elements of outpatient care: a comparison of patients' and physicians' opinions. *Ann Intern Med*. 1996;125:640–645.
- [239] Delbanco TL. Enriching the doctor-patient relationship by inviting the patient's perspective. *Ann Intern Med*. 1992;116:414–418. KIE BoB Subject Heading: professional patient relationship, Full author name: Delbanco, Thomas L.
- [240] Edward GM, Lemaire LC, Preckel B, Oort FJ, Bucx MJL, Hollmann MW, et al. Patient Experiences with the Preoperative Assessment Clinic (PEPAC): validation of an instrument to measure patient experiences. *Br J Anaesth*. 2007;99(5):666–672.
- [241] Picker Institute Europe. Outpatients Department Survey Question Bank.; 2011. http://www.nhssurveys.org/Filestore//documents/Outpatient_allquestions.pdf.

- [242] Edward GM, de Haes JCJM, Oort FJ, Lemaire LC, Hollmann MW, Preckel B. Setting priorities for improving the preoperative assessment clinic: the patients' and the professionals' perspective. *Br J Anaesth.* 2008;100(3):322–326.
- [243] Fraczyk L, Godfrey H. Perceived levels of satisfaction with the preoperative assessment service experienced by patients undergoing general anaesthesia in a day surgery setting. *J Clin Nurs.* 2010;19(19-20):2849–2859.
- [244] Harnett MJP, Correll DJ, Hurwitz S, Bader AM, Hepner DL. Improving efficiency and patient satisfaction in a tertiary teaching hospital preoperative clinic. *Anesthesiology.* 2010;112(1):66–72.
- [245] Gupta A, Gupta N. Patient's experiences and satisfaction with pre-anaesthesia services: A prospective audit. *J Anaesthesiol Clin Pharmacol.* 2011;27(4):511–515.
- [246] Bensing J, Rimondini M, Visser A. What patients want. *Patient Educ Couns.* 2013;90:287–290.
- [247] Chan Z, Kan C, Lee P, Chan I, Lam J. A systematic review of qualitative studies: patients' experiences of preoperative communication. *J Clin Nurs.* 2012;21(5-6):812–824.
- [248] Aquilina R, Baldacchino D. An exploratory study of Maltese patients' perceptions of their preparation for total joint replacement at the pre-admission clinic. *J Orthop Nurs.* 2007;11(3):194–203.
- [249] Gillespie B, Spalding NJ. A phenomenological study of patients' experiences of an orthopaedic preadmission clinic. *Int J Ther Rehabil.* 2007;14(1).
- [250] Straessle R, Gilliard N, Frascarolo P, Rossat J, Albrecht E. Is a pre-anaesthetic information form really useful? *Acta Anaesthesiol Scand.* 2011;55(5):517–523.
- [251] Puro H, Pakarinen P, Korttila K, Tallgren M. Verbal information about anesthesia before scheduled surgery - contents and patient satisfaction. *Patient Educ Couns.* 2013;90(3):367–371.
- [252] Sizmur S, Redding D. Key Domains of the Experience of Hospital Outpatients. Picker Institute Europe; 2010.
- [253] Sizmur S, Redding D. Core domains for measuring inpatients' experience of care. Picker Institute Europe; 2009.
- [254] University of Malta. Medical Maltese Proficiency Certificate;. https://www.um.edu.mt/ms/medical_maltese (Last accessed: 17th December, 2016).

- [255] Malta Foundation Programme. Call for Applications Foundation Programme 2017;. <http://fpmalta.com/news/view/44> (Last accessed: 17th December, 2016).
- [256] Sandberg EH, Sharma R, Sandberg WS. Deficits in retention for verbally presented medical information. *Anesthesiology*. 2012;117:772–779.
- [257] van Klei WA, Peelen LM, Kruijswijk JE, van Wolfswinkel L. Feedback system to estimate the quality of outpatient preoperative evaluation records: an analysis of end-user satisfaction. *Br J Anaesth*. 2010;105(5):620–626.
- [258] Clavien PA, Sanabria JR, Strasberg SM. Proposed classification of complications of surgery with examples of utility in cholecystectomy. *Surgery*. 1992;111:518–526.
- [259] Clavien PA, Barkun J, de Oliveira ML, Vauthey JN, Dindo D, Schulick RD, et al. The Clavien-Dindo classification of surgical complications: five-year experience. *Ann Surg*. 2009;250:187–196.
- [260] Reason J. Hazards, Defences and Losses. In: *Managing the Risks of Organizational Accidents*. 1st ed. Ashgate; 1997. p. 1–20.
- [261] Cohen MD, Hilligoss PB. The published literature on handoffs in hospitals: deficiencies identified in an extensive review. *Qual Saf Health Care*. 2010;19(6):493–497.
- [262] Nicholson A, Coldwell CH, Lewis SR, Smith AF. Nurse-led versus doctor-led preoperative assessment for elective surgical patients requiring regional or general anaesthesia. *Cochrane Database Syst Rev*. 2013;p. CD010160.
- [263] Kohn LT, Corrigan JM, Donaldson MS, Committee on Quality of Health Care in America, Institute of Medicine, editors. *To Err Is Human: Building a Safer Health System*. The National Academies Press; 2000.
- [264] Nemeth C, O’Conner M, Klock PA, Cook R. Cognitive Artifacts’ Implications for Health Care Information Technology: Revealing How Practitioners Create and Share Their Understanding of Daily Work. In: Henriksen K, Battles JB, Marks ES, Lewin DI, editors. *Advances in Patient Safety: From Research to Implementation*. vol. Volume 2: Concepts and Methodology. Rockville (MD):: Agency for Healthcare Research and Quality (US); 2005. p. 279–292.
- [265] Jenkins DP, Salmon PM, Stanton NA, Walker GH. A new approach for designing cognitive artefacts to support disaster management. *Ergonomics*. 2010;53(5):617–635.

- [266] Humphreys G. Checklists save lives. *Bull World Health Organ.* 2008;86(7):501–502.
- [267] WHO's patient-safety checklist for surgery. *Lancet.* 2008;372(9632):1.
- [268] de Vries EN, Hollmann MW, Smorenburg SM, Gouma DJ, Boermeester MA. Development and validation of the SURgical PATient Safety System (SURPASS) checklist. *Qual Saf Health Care.* 2009;18(2):121–126.
- [269] Haynes AB, Weiser TG, Berry WR, Lipsitz SR, Breizat AHS, Dellinger EP, et al. A surgical safety checklist to reduce morbidity and mortality in a global population. *N Engl J Med.* 2009;360(5):491–499.
- [270] de Vries EN, Dijkstra L, Smorenburg SM, Meijer RP, Boermeester MA. The SURgical PATient Safety System (SURPASS) checklist optimizes timing of antibiotic prophylaxis. *Patient Saf Surg.* 2010;4(1):6.
- [271] de Vries EN, Prins HA, Crolla RMPH, den Outer AJ, van Anandel G, van Helden SH, et al. Effect of a comprehensive surgical safety system on patient outcomes. *N Engl J Med.* 2010;363(20):1928–1937.
- [272] de Vries EN, Eikens-Jansen MP, Hamersma AM, Smorenburg SM, Gouma DJ, Boermeester MA. Prevention of surgical malpractice claims by use of a surgical safety checklist. *Ann Surg.* 2011;253(3):624–628.
- [273] de Vries EN, Prins HA, Bennink MC, Neijenhuis P, van Stijn I, van Helden SH, et al. Nature and timing of incidents intercepted by the SURPASS checklist in surgical patients. *BMJ Qual Saf.* 2012;21(6):503–508.
- [274] Kalkman CJ. Handover in the perioperative care process. *Curr Opin Anaesthesiol.* 2010;23(6):749–753.
- [275] Raduma-Tomàs MA, Flin R, Yule S, Williams D. Doctors' handovers in hospitals: a literature review. *BMJ Qual Saf.* 2011;20(2):128–133.
- [276] Horn J, Bell MDD, Moss E. Handover of responsibility for the anaesthetised patient - opinion and practice. *Anaesthesia.* 2004;59(7):658–663.
- [277] Agarwal HS, Saville BR, Slayton JM, Donahue BS, Daves S, Christian KG, et al. Standardized postoperative handover process improves outcomes in the intensive care unit: a model for operational sustainability and improved team performance*. *Crit Care Med.* 2012;40(7):2109–2115.
- [278] Siddiqui N, Arzola C, Iqbal M, Sritharan K, Guerina L, Chung F, et al. Deficits in information transfer between anaesthesiologist and

- postanaesthesia care unit staff: an analysis of patient handover. *Eur J Anaesthesiol.* 2012;29(9):438–445.
- [279] Lingard L, Espin S, Whyte S, Regehr G, Baker GR, Reznick R, et al. Communication failures in the operating room: an observational classification of recurrent types and effects. *Qual Saf Health Care.* 2004;13(5):330–334.
- [280] Rogers SO, Gawande AA, Kwaan M, Puopolo AL, Yoon C, Brennan TA, et al. Analysis of surgical errors in closed malpractice claims at 4 liability insurers. *Surgery.* 2006;140:25–33.
- [281] Nagpal K, Vats A, Ahmed K, Vincent C, Moorthy K. An evaluation of information transfer through the continuum of surgical care: a feasibility study. *Ann Surg.* 2010;252(2):402–407.
- [282] Sutcliffe KM, Lewton E, Rosenthal MM. Communication failures: an insidious contributor to medical mishaps. *Acad Med.* 2004;79(2):186–194.
- [283] Arora V, Johnson J, Lovinger D, Humphrey HJ, Meltzer DO. Communication failures in patient sign-out and suggestions for improvement: a critical incident analysis. *Qual Saf Health Care.* 2005;14(6):401–407.
- [284] Horwitz LI, Meredith T, Schuur JD, Shah NR, Kulkarni RG, Jenq GY. Dropping the baton: a qualitative analysis of failures during the transition from emergency department to inpatient care. *Ann Emerg Med.* 2009;53:701–10.e4.
- [285] Horwitz LI, Moin T, Krumholz HM, Wang L, Bradley EH. Consequences of inadequate sign-out for patient care. *Arch Intern Med.* 2008;168:1755–1760.
- [286] Patterson ES, Roth EM, Woods DD, Chow R, Gomes JO. Handoff strategies in settings with high consequences for failure: lessons for health care operations. *Int J Qual Health Care.* 2004;16:125–132.
- [287] Cohen MD, Hilligoss PB. Handoffs in Hospitals: A review of the literature on information exchange while transferring patient responsibility or control. School of Information, University of Michigan, Ann Arbor, Michigan 48109-1107, USA. mdc@umich.edu; 2009.
- [288] Sullivan JL, Rivard PE, Shin MH, Rosen AK. Applying the High Reliability Health Care Maturity Model to Assess Hospital Performance: A VA Case Study. *Jt Comm J Qual Patient Saf.* 2016;42:389–411.
- [289] Gaw M, Rosinia F, Diller T. Quality and the Health System: Becoming a High Reliability Organization. *Anesthesiol Clin.* 2018;36:217–226.

- [290] Riesenbergr LA, Leitzsch J, Massucci JL, Jaeger J, Rosenfeld JC, Patow C, et al. Residents' and attending physicians' handoffs: a systematic review of the literature. *Acad Med*. 2009;84:1775–1787.
- [291] Robertson ER, Morgan L, Bird S, Catchpole K, McCulloch P. Interventions employed to improve intrahospital handover: a systematic review. *BMJ Qual Saf*. 2014;23:600–607.
- [292] Abraham J, Kannampallil T, Patel B, Almoosa K, Patel VL. Ensuring patient safety in care transitions: an empirical evaluation of a Handoff Intervention Tool. *AMIA Annual Symposium proceedings AMIA Symposium*. 2012;2012:17–26.
- [293] Leonard M, Graham S, Bonacum D. The human factor: the critical importance of effective teamwork and communication in providing safe care. *Qual Saf Health Care*. 2004;13 Suppl 1:i85–i90.
- [294] Riesenbergr LA, Leitzsch J, Little BW. Systematic review of handoff mnemonics literature. *American J Med Qual*. 2009;24:196–204.
- [295] Arora V, Johnson J. A model for building a standardized hand-off protocol. *Jt Comm J Qual Patient Saf*. 2006;32:646–655.
- [296] Abraham J, Nguyen V, Almoosa KF, Patel B, Patel VL. Falling through the cracks: information breakdowns in critical care handoff communication. *AMIA Annual Symposium proceedings AMIA Symposium*. 2011;2011:28–37.
- [297] Bauer B, Rebel A, Dilorenzo A, Schell RM, Dority JS, Lukens F, et al. Cognitive aid use improves transition of care by graduating medical students during a simulated crisis. *Med Educ Online*. 2016;21:32118.
- [298] Hutchinson L. Apollo Flight Controller 101: Every console explained;. <https://arstechnica.com/science/2019/12/apollo-flight-controller-101-every-console-explained/> (Accessed: 24th April 2021).
- [299] Shepard RN. Recognition memory for words, sentences, and pictures. *J Verbal Learning Verbal Behav*. 1967;6(1):156–163.
- [300] Nelson DL, Reed VS, Walling JR. Pictorial superiority effect. *J Exp Psychol Hum Learn*. 1976;2:523–528.
- [301] McBride DM, Anne Doshier B. A comparison of conscious and automatic memory processes for picture and word stimuli: a process dissociation analysis. *Conscious Cogn*. 2002;11:423–460.
- [302] Hockley WE. The picture superiority effect in associative recognition. *Mem Cognit*. 2008;36:1351–1359.

- [303] Walker P, Nordell C, Cace, Neumann CM, Bruera E. Impact of the Edmonton Labeled Visual Information System on physician recall of metastatic cancer patient histories. a randomized controlled trial. *J Pain Symptom Manage.* 2001;21:4–11.
- [304] Wolch G, Ghosh S, Boyington C, Watanabe SM, Fainsinger R, Macleod SB, et al. Impact of Adding a Pictorial Display to Enhance Recall of Cancer Patient Histories: A Randomized Trial. *J Pain Symptom Manage.* 2016;.
- [305] Green CA, Logie RH, Gilhooly KJ, Ross DG, Ronald A. Aberdeen polygons: computer displays of physiological profiles for intensive care. *Ergonomics.* 1996;39:412–428.
- [306] Drews FA, Westenskow DR. The right picture is worth a thousand numbers: data displays in anesthesia. *Hum Factors.* 2006;48:59–71.
- [307] MacDougall-Davis SR, Kettley L, Cook TM. The 'go-between' study: a simulation study comparing the 'Traffic Lights' and 'SBAR' tools as a means of communication between anaesthetic staff. *Anaesthesia.* 2016;71:764–772.
- [308] Gurushanthaiah K, Weinger MB, Englund CE. Visual display format affects the ability of anesthesiologists to detect acute physiologic changes. A laboratory study employing a clinical display simulator. *Anesthesiology.* 1995;83:1184–1193.
- [309] Karkouti K, Rose DK, Ferris LE, Wigglesworth DF, Meisami-Fard T, Lee H. Inter-observer reliability of ten tests used for predicting difficult tracheal intubation. *Can J Anaesth.* 1996;43:554–559.
- [310] Hilditch WG, Kopka A, Crawford JM, Asbury AJ. Interobserver reliability between a nurse and anaesthetist of tests used for predicting difficult tracheal intubation. *Anaesthesia.* 2004;59:881–884.
- [311] Harrison MJ. Variation in preoperative assessment of cardiac output reserve and likelihood of transfusion among anaesthetists: a pilot study. *Anaesth Intensive Care.* 2006;34:453–456.
- [312] Owens WD, Felts JA, Spitznagel EL. Tally of ASA classification responses. *Anesthesiology.* 1979;51:181.
- [313] Riley R, Holman C, Fletcher D. Inter-rater reliability of the ASA physical status classification in a sample of anaesthetists in Western Australia. *Anaesth Intensive Care.* 2014;42(5):614–618.
- [314] Ranta S, Hynynen M, Tammisto T. A survey of the ASA physical status classification: significant variation in allocation among Finnish anesthesiologists. *Acta anaesthesiologica Scandinavica.* 1997;41:629–632.

- [315] De Cassai A, Boscolo A, Tonetti T, Ban I, Ori C. Assignment of ASA-physical status relates to anesthesiologists' experience: a survey-based national-study. *Korean J Anesthesiol.* 2019;72:53–59.
- [316] Curatolo C, Goldberg A, Maerz D, Lin HM, Shah H, Trinh M. ASA physical status assignment by non-anesthesia providers: Do surgeons consistently downgrade the ASA score preoperatively? *J Clin Anesth.* 2017;38:123–128.
- [317] Ihejirika RC, Thakore RV, Sathiyakumar V, Ehrenfeld JM, Obremsky WT, Sethi MK. An assessment of the inter-rater reliability of the ASA physical status score in the orthopaedic trauma population. *Injury.* 2014;.
- [318] Kuza CM, Hatzakis G, Nahmias JT. The Assignment of American Society of Anesthesiologists Physical Status Classification for Adult Polytrauma Patients: Results From a Survey and Future Considerations. *Anesth Analg.* 2017;125:1960–1966.
- [319] Shichino T, Hirao M, Haga Y. Inter-rater reliability of the American Society of Anesthesiologists physical status rating for emergency gastrointestinal surgery. *Acute Med Surg.* 2017;4:161–165.
- [320] Cuvillon P, Nouvellon E, Marret E, Albaladejo P, Fortier LP, Fabbro-Perray P, et al. American Society of Anesthesiologists' physical status system: a multicentre Francophone study to analyse reasons for classification disagreement. *Eur J Anaesthesiol.* 2011;28(10):742–747.
- [321] Issa MRN, Isoni NFC, Soares AM, Fernandes ML. Preanesthesia evaluation and reduction of preoperative care costs. *Rev Bras Anesthesiol.* 2011;61(1):60–71.
- [322] Sankar A, Johnson SR, Beattie WS, Tait G, Wijeyesundera DN. Reliability of the American Society of Anesthesiologists physical status scale in clinical practice. *Br J Anaesth.* 2014;113:424–432.
- [323] Knuf KM, Maani CV, Cummings AK. Clinical agreement in the American Society of Anesthesiologists physical status classification. *Perioperative medicine (London, England).* 2018;7:14.
- [324] Ripley B, Venables B, Bates DM, Hornik K, Gebhardt A, Firth D. Package 'MASS';. <https://cran.r-project.org/web/packages/MASS/MASS.pdf> (Last Accessed: 18 October 2019).
- [325] Gamer M, Lemon J, Fellows I, Singh P. Package 'irr';. <https://cran.r-project.org/web/packages/irr/irr.pdf> (Last Accessed: 18 October 2019).

- [326] Light RJ. Measures of response agreement for qualitative data: some generalizations and alternatives. *Psychol Bull.* 1971;76(5):365–.
- [327] Cohen J. A coefficient of agreement for nominal scales. *Educ Psychol Meas.* 1960;20(1):37–46.
- [328] Cohen J. Weighted kappa: nominal scale agreement provision for scaled disagreement or partial credit. *Psychol Bull.* 1968;70(4):213.
- [329] Landis JR, Koch GG. The measurement of observer agreement for categorical data. *Biometrics.* 1977;33:159–174.
- [330] Hallgren KA. Computing Inter-Rater Reliability for Observational Data: An Overview and Tutorial. *Tutor Quant Methods Psychol.* 2012;8:23–34.
- [331] Nelson KP, Edwards D. Measures of agreement between many raters for ordinal classifications. *Stat Med.* 2015;34:3116–3132.
- [332] Fleiss JL. Measuring nominal scale agreement among many raters. *Psychol Bull.* 1971;76(5):378.
- [333] Endsley M. Toward a Theory of Situation Awareness in Dynamic Systems. *Hum Factors.* 1995;37:32–64.
- [334] Gaba DM, Howard SK, Small SD. Situation awareness in anesthesiology. *Hum Factors.* 1995;37:20–31.
- [335] Fletcher G, Flin R, McGeorge P, Glavin R, Maran N, Patey R. Anaesthetists' Non-Technical Skills (ANTS): evaluation of a behavioural marker system. *Br J Anaesth.* 2003;90:580–588.
- [336] Flin R, Patey R, Glavin R, Maran N. Anaesthetists' non-technical skills. *Br J Anaesth.* 2010;105:38–44.
- [337] Endsley MR. Theoretical Underpinnings of Situation Awareness: A Critical Review. In: *Situation Awareness Analysis and Measurement.* CRC Press; 2000. Editors: Mica R. Endsley and Daniel J. Garland.
- [338] Coury BG, Boulette MD. Time stress and the processing of visual displays. *Hum Factors.* 1992;34:707–725.
- [339] Wright MC, Taekman JM, Endsley MR. Objective measures of situation awareness in a simulated medical environment. *Qual Saf Health Care.* 2004;13 Suppl 1:i65–i71.
- [340] Schulz CM, Endsley MR, Kochs EF, Gelb AW, Wagner KJ. Situation awareness in anesthesia: concept and research. *Anesthesiology.* 2013;118:729–42.

- [341] Endsley M, Jones D. Evaluating design concepts for SA. In: Designing for situation awareness : an approach to user-centered design. Boca Raton, FL: CRC Press; 2012. p. 259–284.
- [342] Cooper S, Porter J, Peach L. Measuring situation awareness in emergency settings: a systematic review of tools and outcomes. *Open Access Emerg MedOAEM*. 2014;6:1–7.
- [343] Orique SB, Despins L. Evaluating Situation Awareness: An Integrative Review. *West J Nurs Res*. 2018;40:388–424.
- [344] Endsley MR. Measurement of Situation Awareness in Dynamic Systems. *Hum Factors*. 1995;37(1):65–84.
- [345] Yule S, Flin R, Paterson-Brown S, Maran N, Rowley D. Development of a rating system for surgeons' non-technical skills. *Med Educ*. 2006;40:1098–1104.
- [346] Yule S, Paterson-Brown S. Surgeons' non-technical skills. *Surg Clin North Am*. 2012;92:37–50.
- [347] Taylor R. Situation Awareness Rating Technique: the development of a tool for aircrew system design. In: AGARD conference proceedings. vol. 478; 1990. .
- [348] Jones D. Subjective Measures of Situation Awareness. In: Endsley M, Garland D, editors. Situation awareness : analysis and measurement. Mahwah, N.J: L. Erlbaum Associates; 2000. p. 1.
- [349] Durso FT, Hackworth CA, Truitt TR, Crutchfield J, Nikolic D, Manning CA. Situation Awareness as a Predictor of Performance for En Route Air Traffic Controllers. *Air Traffic Control Quarterly*. 1998;6(1):1–20.
- [350] Endsley MR. Direct Measurement of Situation Awareness: Validity and Use of SAGAT. In: Situation Awareness Analysis and Measurement. CRC Press; 2000. Editors: Mica R. Endsley and Daniel J. Garland.
- [351] Endsley MR. A Systematic Review and Meta-Analysis of Direct Objective Measures of Situation Awareness: A Comparison of SAGAT and SPAM. *Hum Factors*. 2019;p. 18720819875376.
- [352] PHP Team. PHP: Hypertext preprocessor; 2019. <https://www.php.net> (Accessed: 14 November 2019).
- [353] The APACHE Software Foundation. The Apache HTTP Server Project; 2019. <https://httpd.apache.org/> (Accessed: 14 November 2019).

- [354] The PostgreSQL Global Development Group. PostgreSQL; 2014. <https://www.postgresql.org> (Accessed: 8 July 2014).
- [355] PH/9. BS EN ISO 9241-210:2010 - Ergonomics of human-system interaction. Human-centred design for interactive systems. BSI; 2019.
- [356] Bevan N. Measuring usability as quality of use. *Software Qual J.* 1995;4(2):115–130.
- [357] Frøkjær E, Hertzum M, Hornbæk K. Measuring usability: are effectiveness, efficiency, and satisfaction really correlated? In: *Proceedings of the SIGCHI conference on Human Factors in Computing Systems.* ACM; 2000. p. 345–352.
- [358] Hornbæk K. Current practice in measuring usability: Challenges to usability studies and research. *Int J Hum Comput Stud.* 2006;64(2):79–102.
- [359] Abraham J, Kannampallil T, Patel VL. A systematic review of the literature on the evaluation of handoff tools: implications for research and practice. *J Am Med Inform Assoc.* 2014;21:154–62.
- [360] Clague JE, Reed PG, Barlow J, Rada R, Clarke M, Edwards RH. Improving outpatient clinic efficiency using computer simulation. *Int J Qual Health Care.* 1997;10:197–201.
- [361] Zonderland ME, Boer F, Boucherie RJ, de Roode A, van Kleef JW. Redesign of a university hospital preanesthesia evaluation clinic using a queuing theory approach. *Anesth Analg.* 2009;109:1612–1621.
- [362] Amrock LG, Deiner S. The implication of frailty on preoperative risk assessment. *Curr Opin Anaesthesiol.* 2014 Jun;27(3):330–335. Available from: <http://dx.doi.org/10.1097/ACO.000000000000065>.
- [363] Chiew CJ, Liu N, Wong TH, Sim YE, Abdullah HR. Utilizing Machine Learning Methods for Preoperative Prediction of Postsurgical Mortality and Intensive Care Unit Admission. *Annals of surgery.* 2020 Dec;272:1133–1139.

Appendix A

Questionnaire on Preoperative Anaesthetic Assessment Practice

The questionnaire used for the preoperative dataset questionnaire is reproduced below. The questionnaire was typeset using Scripts for Data Acquisition with Paper-based Surveys (SDAPS) software [167].

Preoperative Assessment Practice Questionnaire

This questionnaire will be scanned by a computer programme.

Please mark the boxes as shown below.

To check box:

Uncheck to correct:

Please use a black or blue ballpoint pen.

1 Introduction

There is broad consensus among anaesthesia professional associations and learned bodies that preoperative assessment of patients is an important element of good practice. Although several guidelines and advisories have been published regarding which elements of the preoperative evaluation are important and cost effective, it is acknowledged that the available evidence for these recommendations is often incomplete or inconclusive.

Changes in work practice in recent years have also resulted in the situation where patients are often not assessed by the anaesthetist who will perform the case, but by a different team of professionals. This may result in situations where the anaesthetist managing the case may consider that the patient has not been adequately prepared for anaesthesia.

The aim of this questionnaire is to determine the opinions of the anaesthetists practising in our hospital regarding the desired content of a preoperative assessment in a variety of situations.

2 Professional Information

2.1 What is your current grade?

Trainee

Resident Specialist

Consultant

2.2 How long ago did you start working in anaesthesia?

<5 years

5-10 years

>10 years

3 Patient History

Please mark which of the following elements of the patient's medical history you believe should be **routinely enquired about, in all patients**, during preoperative assessment. **Also** mark how useful you consider each item in planning the anaesthetic management of the case.

3.1 *Presenting Complaint*

	Ask Routinely	useless	little	somewhat	very	extremely
Current surgical diagnoses	<input type="checkbox"/>	<input type="checkbox"/>	<input type="checkbox"/>	<input type="checkbox"/>	<input type="checkbox"/>	<input type="checkbox"/>
Planned procedure	<input type="checkbox"/>	<input type="checkbox"/>	<input type="checkbox"/>	<input type="checkbox"/>	<input type="checkbox"/>	<input type="checkbox"/>
Blood loss risk	<input type="checkbox"/>	<input type="checkbox"/>	<input type="checkbox"/>	<input type="checkbox"/>	<input type="checkbox"/>	<input type="checkbox"/>
Limitation to accepting blood products	<input type="checkbox"/>	<input type="checkbox"/>	<input type="checkbox"/>	<input type="checkbox"/>	<input type="checkbox"/>	<input type="checkbox"/>

Comments:



1051833853 0001

Preoperative Assessment Practice Questionnaire

3.2 Past Medical History

	Ask Routinely	useless	little	somewhat	very	extremely
Ischaemic heart disease	<input type="checkbox"/>	<input type="checkbox"/>	<input type="checkbox"/>	<input type="checkbox"/>	<input type="checkbox"/>	<input type="checkbox"/>
Arrythmia	<input type="checkbox"/>	<input type="checkbox"/>	<input type="checkbox"/>	<input type="checkbox"/>	<input type="checkbox"/>	<input type="checkbox"/>
Myocardial infarction	<input type="checkbox"/>	<input type="checkbox"/>	<input type="checkbox"/>	<input type="checkbox"/>	<input type="checkbox"/>	<input type="checkbox"/>
Coronary artery bypass graft	<input type="checkbox"/>	<input type="checkbox"/>	<input type="checkbox"/>	<input type="checkbox"/>	<input type="checkbox"/>	<input type="checkbox"/>
Heart valve replacement	<input type="checkbox"/>	<input type="checkbox"/>	<input type="checkbox"/>	<input type="checkbox"/>	<input type="checkbox"/>	<input type="checkbox"/>
Heart transplantation	<input type="checkbox"/>	<input type="checkbox"/>	<input type="checkbox"/>	<input type="checkbox"/>	<input type="checkbox"/>	<input type="checkbox"/>
Other heart disease	<input type="checkbox"/>	<input type="checkbox"/>	<input type="checkbox"/>	<input type="checkbox"/>	<input type="checkbox"/>	<input type="checkbox"/>
Percutaneous coronary intervention	<input type="checkbox"/>	<input type="checkbox"/>	<input type="checkbox"/>	<input type="checkbox"/>	<input type="checkbox"/>	<input type="checkbox"/>
Congestive heart failure	<input type="checkbox"/>	<input type="checkbox"/>	<input type="checkbox"/>	<input type="checkbox"/>	<input type="checkbox"/>	<input type="checkbox"/>
Congenital heart disease	<input type="checkbox"/>	<input type="checkbox"/>	<input type="checkbox"/>	<input type="checkbox"/>	<input type="checkbox"/>	<input type="checkbox"/>
Presence of pacemaker	<input type="checkbox"/>	<input type="checkbox"/>	<input type="checkbox"/>	<input type="checkbox"/>	<input type="checkbox"/>	<input type="checkbox"/>
Presence of implanted defibrillator	<input type="checkbox"/>	<input type="checkbox"/>	<input type="checkbox"/>	<input type="checkbox"/>	<input type="checkbox"/>	<input type="checkbox"/>
Diagnosed hypertension	<input type="checkbox"/>	<input type="checkbox"/>	<input type="checkbox"/>	<input type="checkbox"/>	<input type="checkbox"/>	<input type="checkbox"/>
Cerebrovascular diseases	<input type="checkbox"/>	<input type="checkbox"/>	<input type="checkbox"/>	<input type="checkbox"/>	<input type="checkbox"/>	<input type="checkbox"/>
Peripheral vascular disorders	<input type="checkbox"/>	<input type="checkbox"/>	<input type="checkbox"/>	<input type="checkbox"/>	<input type="checkbox"/>	<input type="checkbox"/>
Great vessel (aortic) disorders	<input type="checkbox"/>	<input type="checkbox"/>	<input type="checkbox"/>	<input type="checkbox"/>	<input type="checkbox"/>	<input type="checkbox"/>
Malignancy(active)	<input type="checkbox"/>	<input type="checkbox"/>	<input type="checkbox"/>	<input type="checkbox"/>	<input type="checkbox"/>	<input type="checkbox"/>
Chronic obstructive pulmonary disease	<input type="checkbox"/>	<input type="checkbox"/>	<input type="checkbox"/>	<input type="checkbox"/>	<input type="checkbox"/>	<input type="checkbox"/>
Obstructive sleep apnoea	<input type="checkbox"/>	<input type="checkbox"/>	<input type="checkbox"/>	<input type="checkbox"/>	<input type="checkbox"/>	<input type="checkbox"/>
Asthma	<input type="checkbox"/>	<input type="checkbox"/>	<input type="checkbox"/>	<input type="checkbox"/>	<input type="checkbox"/>	<input type="checkbox"/>
Renal failure	<input type="checkbox"/>	<input type="checkbox"/>	<input type="checkbox"/>	<input type="checkbox"/>	<input type="checkbox"/>	<input type="checkbox"/>
Hepatitis	<input type="checkbox"/>	<input type="checkbox"/>	<input type="checkbox"/>	<input type="checkbox"/>	<input type="checkbox"/>	<input type="checkbox"/>
Liver cirrhosis	<input type="checkbox"/>	<input type="checkbox"/>	<input type="checkbox"/>	<input type="checkbox"/>	<input type="checkbox"/>	<input type="checkbox"/>
Coagulation disorders	<input type="checkbox"/>	<input type="checkbox"/>	<input type="checkbox"/>	<input type="checkbox"/>	<input type="checkbox"/>	<input type="checkbox"/>
Anaemia	<input type="checkbox"/>	<input type="checkbox"/>	<input type="checkbox"/>	<input type="checkbox"/>	<input type="checkbox"/>	<input type="checkbox"/>
Diabetes mellitus	<input type="checkbox"/>	<input type="checkbox"/>	<input type="checkbox"/>	<input type="checkbox"/>	<input type="checkbox"/>	<input type="checkbox"/>
Complications of diabetes mellitus	<input type="checkbox"/>	<input type="checkbox"/>	<input type="checkbox"/>	<input type="checkbox"/>	<input type="checkbox"/>	<input type="checkbox"/>
Glucose intolerance	<input type="checkbox"/>	<input type="checkbox"/>	<input type="checkbox"/>	<input type="checkbox"/>	<input type="checkbox"/>	<input type="checkbox"/>
Thyroid disorder	<input type="checkbox"/>	<input type="checkbox"/>	<input type="checkbox"/>	<input type="checkbox"/>	<input type="checkbox"/>	<input type="checkbox"/>
Musculoskeletal diseases	<input type="checkbox"/>	<input type="checkbox"/>	<input type="checkbox"/>	<input type="checkbox"/>	<input type="checkbox"/>	<input type="checkbox"/>
Rheumatoid diseases	<input type="checkbox"/>	<input type="checkbox"/>	<input type="checkbox"/>	<input type="checkbox"/>	<input type="checkbox"/>	<input type="checkbox"/>
Spinal surgery or injury	<input type="checkbox"/>	<input type="checkbox"/>	<input type="checkbox"/>	<input type="checkbox"/>	<input type="checkbox"/>	<input type="checkbox"/>
Parkinson's disease	<input type="checkbox"/>	<input type="checkbox"/>	<input type="checkbox"/>	<input type="checkbox"/>	<input type="checkbox"/>	<input type="checkbox"/>
Cerebral aneurysm	<input type="checkbox"/>	<input type="checkbox"/>	<input type="checkbox"/>	<input type="checkbox"/>	<input type="checkbox"/>	<input type="checkbox"/>
Epilepsy	<input type="checkbox"/>	<input type="checkbox"/>	<input type="checkbox"/>	<input type="checkbox"/>	<input type="checkbox"/>	<input type="checkbox"/>
Neuromuscular disease	<input type="checkbox"/>	<input type="checkbox"/>	<input type="checkbox"/>	<input type="checkbox"/>	<input type="checkbox"/>	<input type="checkbox"/>
Psychiatric disorders	<input type="checkbox"/>	<input type="checkbox"/>	<input type="checkbox"/>	<input type="checkbox"/>	<input type="checkbox"/>	<input type="checkbox"/>

Comments:



1051833853 0002

Preoperative Assessment Practice Questionnaire

3.3 Medication History

	Ask Routinely	useless	little	somewhat	very	extremely
Current medications	<input type="checkbox"/>	<input type="checkbox"/>	<input type="checkbox"/>	<input type="checkbox"/>	<input type="checkbox"/>	<input type="checkbox"/>
Medication side effects	<input type="checkbox"/>	<input type="checkbox"/>	<input type="checkbox"/>	<input type="checkbox"/>	<input type="checkbox"/>	<input type="checkbox"/>
Allergies	<input type="checkbox"/>	<input type="checkbox"/>	<input type="checkbox"/>	<input type="checkbox"/>	<input type="checkbox"/>	<input type="checkbox"/>

Comments:

3.4 Anaesthesia and Surgical History

	Ask Routinely	useless	little	somewhat	very	extremely
Previous surgeries	<input type="checkbox"/>	<input type="checkbox"/>	<input type="checkbox"/>	<input type="checkbox"/>	<input type="checkbox"/>	<input type="checkbox"/>
Previous anaesthesia complications	<input type="checkbox"/>	<input type="checkbox"/>	<input type="checkbox"/>	<input type="checkbox"/>	<input type="checkbox"/>	<input type="checkbox"/>
Family history of anaesthesia complications	<input type="checkbox"/>	<input type="checkbox"/>	<input type="checkbox"/>	<input type="checkbox"/>	<input type="checkbox"/>	<input type="checkbox"/>
History of post-operative nausea and vomiting	<input type="checkbox"/>	<input type="checkbox"/>	<input type="checkbox"/>	<input type="checkbox"/>	<input type="checkbox"/>	<input type="checkbox"/>

Comments:

3.5 Social History

	Ask Routinely	useless	little	somewhat	very	extremely
Smoking history	<input type="checkbox"/>	<input type="checkbox"/>	<input type="checkbox"/>	<input type="checkbox"/>	<input type="checkbox"/>	<input type="checkbox"/>
Alcohol consumption	<input type="checkbox"/>	<input type="checkbox"/>	<input type="checkbox"/>	<input type="checkbox"/>	<input type="checkbox"/>	<input type="checkbox"/>
Drug abuse	<input type="checkbox"/>	<input type="checkbox"/>	<input type="checkbox"/>	<input type="checkbox"/>	<input type="checkbox"/>	<input type="checkbox"/>

Comments:

3.6 Systemic Enquiry

	Ask Routinely	useless	little	somewhat	very	extremely
Exercise tolerance	<input type="checkbox"/>	<input type="checkbox"/>	<input type="checkbox"/>	<input type="checkbox"/>	<input type="checkbox"/>	<input type="checkbox"/>
Chest pain	<input type="checkbox"/>	<input type="checkbox"/>	<input type="checkbox"/>	<input type="checkbox"/>	<input type="checkbox"/>	<input type="checkbox"/>
Palpitations	<input type="checkbox"/>	<input type="checkbox"/>	<input type="checkbox"/>	<input type="checkbox"/>	<input type="checkbox"/>	<input type="checkbox"/>
Dyspnoea	<input type="checkbox"/>	<input type="checkbox"/>	<input type="checkbox"/>	<input type="checkbox"/>	<input type="checkbox"/>	<input type="checkbox"/>
Bleeding tendency	<input type="checkbox"/>	<input type="checkbox"/>	<input type="checkbox"/>	<input type="checkbox"/>	<input type="checkbox"/>	<input type="checkbox"/>
Heartburn/Reflux	<input type="checkbox"/>	<input type="checkbox"/>	<input type="checkbox"/>	<input type="checkbox"/>	<input type="checkbox"/>	<input type="checkbox"/>
Cervical pain or stiffness	<input type="checkbox"/>	<input type="checkbox"/>	<input type="checkbox"/>	<input type="checkbox"/>	<input type="checkbox"/>	<input type="checkbox"/>
Lumbar pain or stiffness	<input type="checkbox"/>	<input type="checkbox"/>	<input type="checkbox"/>	<input type="checkbox"/>	<input type="checkbox"/>	<input type="checkbox"/>

Comments:



Preoperative Assessment Practice Questionnaire

4 Physical Examination

4.1 Please mark which of the following elements of the physical examination you believe should be performed **routinely**, **in all patients**, during preoperative assessment. **Also** mark how useful you consider each item in planning the anaesthetic management of the case.

	Perform Routinely	useless	little	somewhat	very	extremely
Weight	<input type="checkbox"/>	<input type="checkbox"/>	<input type="checkbox"/>	<input type="checkbox"/>	<input type="checkbox"/>	<input type="checkbox"/>
Height	<input type="checkbox"/>	<input type="checkbox"/>	<input type="checkbox"/>	<input type="checkbox"/>	<input type="checkbox"/>	<input type="checkbox"/>
Pulse rate	<input type="checkbox"/>	<input type="checkbox"/>	<input type="checkbox"/>	<input type="checkbox"/>	<input type="checkbox"/>	<input type="checkbox"/>
Blood pressure	<input type="checkbox"/>	<input type="checkbox"/>	<input type="checkbox"/>	<input type="checkbox"/>	<input type="checkbox"/>	<input type="checkbox"/>
Heart auscultation	<input type="checkbox"/>	<input type="checkbox"/>	<input type="checkbox"/>	<input type="checkbox"/>	<input type="checkbox"/>	<input type="checkbox"/>
Lung auscultation	<input type="checkbox"/>	<input type="checkbox"/>	<input type="checkbox"/>	<input type="checkbox"/>	<input type="checkbox"/>	<input type="checkbox"/>
Difficulty in communication	<input type="checkbox"/>	<input type="checkbox"/>	<input type="checkbox"/>	<input type="checkbox"/>	<input type="checkbox"/>	<input type="checkbox"/>
Richmond Agitation Sedation Scale	<input type="checkbox"/>	<input type="checkbox"/>	<input type="checkbox"/>	<input type="checkbox"/>	<input type="checkbox"/>	<input type="checkbox"/>
Glasgow Coma Scale	<input type="checkbox"/>	<input type="checkbox"/>	<input type="checkbox"/>	<input type="checkbox"/>	<input type="checkbox"/>	<input type="checkbox"/>

Comments:



1051833853 0004

Preoperative Assessment Practice Questionnaire

5 Airway Assessment

5.1 Please mark which of the following do you believe should be assessed **routinely in all patients** to assess for difficult mask ventilation or difficult intubation. **Also** mark how useful you consider each item in planning the anaesthetic management of the case.

	Perform Routinely	useless	little	somewhat	very	extremely
History of snoring	<input type="checkbox"/>	<input type="checkbox"/>	<input type="checkbox"/>	<input type="checkbox"/>	<input type="checkbox"/>	<input type="checkbox"/>
Age	<input type="checkbox"/>	<input type="checkbox"/>	<input type="checkbox"/>	<input type="checkbox"/>	<input type="checkbox"/>	<input type="checkbox"/>
Body Mass Index	<input type="checkbox"/>	<input type="checkbox"/>	<input type="checkbox"/>	<input type="checkbox"/>	<input type="checkbox"/>	<input type="checkbox"/>
Presence of beard	<input type="checkbox"/>	<input type="checkbox"/>	<input type="checkbox"/>	<input type="checkbox"/>	<input type="checkbox"/>	<input type="checkbox"/>
Craniofacial abnormalities	<input type="checkbox"/>	<input type="checkbox"/>	<input type="checkbox"/>	<input type="checkbox"/>	<input type="checkbox"/>	<input type="checkbox"/>
Neck length (qualitative)	<input type="checkbox"/>	<input type="checkbox"/>	<input type="checkbox"/>	<input type="checkbox"/>	<input type="checkbox"/>	<input type="checkbox"/>
Neck circumference (qualitative)	<input type="checkbox"/>	<input type="checkbox"/>	<input type="checkbox"/>	<input type="checkbox"/>	<input type="checkbox"/>	<input type="checkbox"/>
Thyromental distance	<input type="checkbox"/>	<input type="checkbox"/>	<input type="checkbox"/>	<input type="checkbox"/>	<input type="checkbox"/>	<input type="checkbox"/>
Sternomental distance	<input type="checkbox"/>	<input type="checkbox"/>	<input type="checkbox"/>	<input type="checkbox"/>	<input type="checkbox"/>	<input type="checkbox"/>
Jaw protrusion	<input type="checkbox"/>	<input type="checkbox"/>	<input type="checkbox"/>	<input type="checkbox"/>	<input type="checkbox"/>	<input type="checkbox"/>
Mouth opening	<input type="checkbox"/>	<input type="checkbox"/>	<input type="checkbox"/>	<input type="checkbox"/>	<input type="checkbox"/>	<input type="checkbox"/>
Mallampati grade	<input type="checkbox"/>	<input type="checkbox"/>	<input type="checkbox"/>	<input type="checkbox"/>	<input type="checkbox"/>	<input type="checkbox"/>
Dental Status	<input type="checkbox"/>	<input type="checkbox"/>	<input type="checkbox"/>	<input type="checkbox"/>	<input type="checkbox"/>	<input type="checkbox"/>
Prominent Incisors	<input type="checkbox"/>	<input type="checkbox"/>	<input type="checkbox"/>	<input type="checkbox"/>	<input type="checkbox"/>	<input type="checkbox"/>
Retrognathism	<input type="checkbox"/>	<input type="checkbox"/>	<input type="checkbox"/>	<input type="checkbox"/>	<input type="checkbox"/>	<input type="checkbox"/>
Upper lip bite test	<input type="checkbox"/>	<input type="checkbox"/>	<input type="checkbox"/>	<input type="checkbox"/>	<input type="checkbox"/>	<input type="checkbox"/>
Oropharyngeal abnormalities	<input type="checkbox"/>	<input type="checkbox"/>	<input type="checkbox"/>	<input type="checkbox"/>	<input type="checkbox"/>	<input type="checkbox"/>
Shape of hard palate	<input type="checkbox"/>	<input type="checkbox"/>	<input type="checkbox"/>	<input type="checkbox"/>	<input type="checkbox"/>	<input type="checkbox"/>
Compliance of mandibular space	<input type="checkbox"/>	<input type="checkbox"/>	<input type="checkbox"/>	<input type="checkbox"/>	<input type="checkbox"/>	<input type="checkbox"/>
Neck range of movement	<input type="checkbox"/>	<input type="checkbox"/>	<input type="checkbox"/>	<input type="checkbox"/>	<input type="checkbox"/>	<input type="checkbox"/>
Nodding donkey test	<input type="checkbox"/>	<input type="checkbox"/>	<input type="checkbox"/>	<input type="checkbox"/>	<input type="checkbox"/>	<input type="checkbox"/>
Dalalkin warning sign	<input type="checkbox"/>	<input type="checkbox"/>	<input type="checkbox"/>	<input type="checkbox"/>	<input type="checkbox"/>	<input type="checkbox"/>
Prayer sign or Palm print test	<input type="checkbox"/>	<input type="checkbox"/>	<input type="checkbox"/>	<input type="checkbox"/>	<input type="checkbox"/>	<input type="checkbox"/>
Indirect (mirror) laryngoscopy	<input type="checkbox"/>	<input type="checkbox"/>	<input type="checkbox"/>	<input type="checkbox"/>	<input type="checkbox"/>	<input type="checkbox"/>
Flexible nasendoscopy	<input type="checkbox"/>	<input type="checkbox"/>	<input type="checkbox"/>	<input type="checkbox"/>	<input type="checkbox"/>	<input type="checkbox"/>
Wilson score	<input type="checkbox"/>	<input type="checkbox"/>	<input type="checkbox"/>	<input type="checkbox"/>	<input type="checkbox"/>	<input type="checkbox"/>
El-Ganzouri score	<input type="checkbox"/>	<input type="checkbox"/>	<input type="checkbox"/>	<input type="checkbox"/>	<input type="checkbox"/>	<input type="checkbox"/>

Comments:



Preoperative Assessment Practice Questionnaire

6 Functional Capacity

Below are a number of descriptions of functional capacity¹.

6.1 Mark **one** box in each column indicating the maximal functional capacity you would associate with mild, moderate or severe impairment

	Mild	Moderate	Severe
Can perform activities of daily living like eating, dressing, bathing or using the toilet	<input type="checkbox"/>	<input type="checkbox"/>	<input type="checkbox"/>
Can walk around indoors	<input type="checkbox"/>	<input type="checkbox"/>	<input type="checkbox"/>
Can walk one or two blocks on level ground	<input type="checkbox"/>	<input type="checkbox"/>	<input type="checkbox"/>
Can climb a flight of stairs or walk up a hill	<input type="checkbox"/>	<input type="checkbox"/>	<input type="checkbox"/>
Can run a short distance	<input type="checkbox"/>	<input type="checkbox"/>	<input type="checkbox"/>
Can do light housework like dusting or washing dishes	<input type="checkbox"/>	<input type="checkbox"/>	<input type="checkbox"/>
Can do moderate housework like vacuuming, sweeping floors or carrying groceries	<input type="checkbox"/>	<input type="checkbox"/>	<input type="checkbox"/>
Can do heavy housework like scrubbing floors, lifting or moving heavy furniture	<input type="checkbox"/>	<input type="checkbox"/>	<input type="checkbox"/>
Can do yardwork like raking weeds or pushing a power mower	<input type="checkbox"/>	<input type="checkbox"/>	<input type="checkbox"/>
Can have sexual relations	<input type="checkbox"/>	<input type="checkbox"/>	<input type="checkbox"/>
Can participate in moderate recreational activities like golf, bowling, dancing, doubles tennis or throwing a baseball or football	<input type="checkbox"/>	<input type="checkbox"/>	<input type="checkbox"/>

6.2 Estimate the ASA grade of a patient with this degree of maximal functional capacity.

	ASA 1	ASA 2	ASA 3	ASA 4
Can perform activities of daily living like eating, dressing, bathing or using the toilet	<input type="checkbox"/>	<input type="checkbox"/>	<input type="checkbox"/>	<input type="checkbox"/>
Can walk around indoors	<input type="checkbox"/>	<input type="checkbox"/>	<input type="checkbox"/>	<input type="checkbox"/>
Can walk one or two blocks on level ground	<input type="checkbox"/>	<input type="checkbox"/>	<input type="checkbox"/>	<input type="checkbox"/>
Can climb a flight of stairs or walk up a hill	<input type="checkbox"/>	<input type="checkbox"/>	<input type="checkbox"/>	<input type="checkbox"/>
Can run a short distance	<input type="checkbox"/>	<input type="checkbox"/>	<input type="checkbox"/>	<input type="checkbox"/>
Can do light housework like dusting or washing dishes	<input type="checkbox"/>	<input type="checkbox"/>	<input type="checkbox"/>	<input type="checkbox"/>
Can do moderate housework like vacuuming, sweeping floors or carrying groceries	<input type="checkbox"/>	<input type="checkbox"/>	<input type="checkbox"/>	<input type="checkbox"/>
Can do heavy housework like scrubbing floors, lifting or moving heavy furniture	<input type="checkbox"/>	<input type="checkbox"/>	<input type="checkbox"/>	<input type="checkbox"/>
Can do yardwork like raking weeds or pushing a power mower	<input type="checkbox"/>	<input type="checkbox"/>	<input type="checkbox"/>	<input type="checkbox"/>
Can have sexual relations	<input type="checkbox"/>	<input type="checkbox"/>	<input type="checkbox"/>	<input type="checkbox"/>
Can participate in moderate recreational activities like golf, bowling, dancing, doubles tennis or throwing a baseball or football	<input type="checkbox"/>	<input type="checkbox"/>	<input type="checkbox"/>	<input type="checkbox"/>

6.3 Comments:

¹Based on Duke Activity Status Index



Preoperative Assessment Practice Questionnaire

7 Special Investigations

Below are a number of clinical scenarios. Please indicate which investigations you would request in each case. Use the following scale to rate your answer:

Unnecessary: A test you would not normally request in this scenario — Leave the row blank

Normally Required (N): A test you would normally request. However, you would still proceed with the case even if the result was not available.

Essential (E): You would postpone the case if the test result is not available.

A 35 year old with **no known medical problems** undergoing this grade of surgery:

7.1 Low-risk

	N	E
ECG	<input type="checkbox"/>	<input type="checkbox"/>
CXR	<input type="checkbox"/>	<input type="checkbox"/>
CBC	<input type="checkbox"/>	<input type="checkbox"/>
Renal Profile	<input type="checkbox"/>	<input type="checkbox"/>
Coagulation Screen	<input type="checkbox"/>	<input type="checkbox"/>
RBG	<input type="checkbox"/>	<input type="checkbox"/>
Liver Profile	<input type="checkbox"/>	<input type="checkbox"/>
Se. Albumin	<input type="checkbox"/>	<input type="checkbox"/>
Urinalysis	<input type="checkbox"/>	<input type="checkbox"/>

7.2 Intermediate-risk

	N	E
ECG	<input type="checkbox"/>	<input type="checkbox"/>
CXR	<input type="checkbox"/>	<input type="checkbox"/>
CBC	<input type="checkbox"/>	<input type="checkbox"/>
Renal Profile	<input type="checkbox"/>	<input type="checkbox"/>
Coagulation Screen	<input type="checkbox"/>	<input type="checkbox"/>
RBG	<input type="checkbox"/>	<input type="checkbox"/>
Liver Profile	<input type="checkbox"/>	<input type="checkbox"/>
Se. Albumin	<input type="checkbox"/>	<input type="checkbox"/>
Urinalysis	<input type="checkbox"/>	<input type="checkbox"/>

7.3 High-risk

	N	E
ECG	<input type="checkbox"/>	<input type="checkbox"/>
CXR	<input type="checkbox"/>	<input type="checkbox"/>
CBC	<input type="checkbox"/>	<input type="checkbox"/>
Renal Profile	<input type="checkbox"/>	<input type="checkbox"/>
Coagulation Screen	<input type="checkbox"/>	<input type="checkbox"/>
RBG	<input type="checkbox"/>	<input type="checkbox"/>
Liver Profile	<input type="checkbox"/>	<input type="checkbox"/>
Se. Albumin	<input type="checkbox"/>	<input type="checkbox"/>
Urinalysis	<input type="checkbox"/>	<input type="checkbox"/>

7.4 Comments:



Preoperative Assessment Practice Questionnaire

A 75 year old with **no known medical problems** undergoing this grade of surgery:

7.5 Low-risk

	N	E
ECG	<input type="checkbox"/>	<input type="checkbox"/>
CXR	<input type="checkbox"/>	<input type="checkbox"/>
CBC	<input type="checkbox"/>	<input type="checkbox"/>
Renal Profile	<input type="checkbox"/>	<input type="checkbox"/>
Coagulation Screen	<input type="checkbox"/>	<input type="checkbox"/>
RBG	<input type="checkbox"/>	<input type="checkbox"/>
Liver Profile	<input type="checkbox"/>	<input type="checkbox"/>
Se. Albumin	<input type="checkbox"/>	<input type="checkbox"/>
Urinalysis	<input type="checkbox"/>	<input type="checkbox"/>

7.6 Intermediate-risk

	N	E
ECG	<input type="checkbox"/>	<input type="checkbox"/>
CXR	<input type="checkbox"/>	<input type="checkbox"/>
CBC	<input type="checkbox"/>	<input type="checkbox"/>
Renal Profile	<input type="checkbox"/>	<input type="checkbox"/>
Coagulation Screen	<input type="checkbox"/>	<input type="checkbox"/>
RBG	<input type="checkbox"/>	<input type="checkbox"/>
Liver Profile	<input type="checkbox"/>	<input type="checkbox"/>
Se. Albumin	<input type="checkbox"/>	<input type="checkbox"/>
Urinalysis	<input type="checkbox"/>	<input type="checkbox"/>

7.7 High-risk

	N	E
ECG	<input type="checkbox"/>	<input type="checkbox"/>
CXR	<input type="checkbox"/>	<input type="checkbox"/>
CBC	<input type="checkbox"/>	<input type="checkbox"/>
Renal Profile	<input type="checkbox"/>	<input type="checkbox"/>
Coagulation Screen	<input type="checkbox"/>	<input type="checkbox"/>
RBG	<input type="checkbox"/>	<input type="checkbox"/>
Liver Profile	<input type="checkbox"/>	<input type="checkbox"/>
Se. Albumin	<input type="checkbox"/>	<input type="checkbox"/>
Urinalysis	<input type="checkbox"/>	<input type="checkbox"/>

7.8 Comments:

An **obese patient** ($BMI > 35 \text{ kg.m}^{-2}$) undergoing this grade of surgery:

7.9 Low-risk

	N	E
ECG	<input type="checkbox"/>	<input type="checkbox"/>
CXR	<input type="checkbox"/>	<input type="checkbox"/>
CBC	<input type="checkbox"/>	<input type="checkbox"/>
Renal Profile	<input type="checkbox"/>	<input type="checkbox"/>
Coagulation Screen	<input type="checkbox"/>	<input type="checkbox"/>
RBG	<input type="checkbox"/>	<input type="checkbox"/>
Liver Profile	<input type="checkbox"/>	<input type="checkbox"/>
Se. Albumin	<input type="checkbox"/>	<input type="checkbox"/>
Urinalysis	<input type="checkbox"/>	<input type="checkbox"/>

7.10 Intermediate-risk

	N	E
ECG	<input type="checkbox"/>	<input type="checkbox"/>
CXR	<input type="checkbox"/>	<input type="checkbox"/>
CBC	<input type="checkbox"/>	<input type="checkbox"/>
Renal Profile	<input type="checkbox"/>	<input type="checkbox"/>
Coagulation Screen	<input type="checkbox"/>	<input type="checkbox"/>
RBG	<input type="checkbox"/>	<input type="checkbox"/>
Liver Profile	<input type="checkbox"/>	<input type="checkbox"/>
Se. Albumin	<input type="checkbox"/>	<input type="checkbox"/>
Urinalysis	<input type="checkbox"/>	<input type="checkbox"/>

7.11 High-risk

	N	E
ECG	<input type="checkbox"/>	<input type="checkbox"/>
CXR	<input type="checkbox"/>	<input type="checkbox"/>
CBC	<input type="checkbox"/>	<input type="checkbox"/>
Renal Profile	<input type="checkbox"/>	<input type="checkbox"/>
Coagulation Screen	<input type="checkbox"/>	<input type="checkbox"/>
RBG	<input type="checkbox"/>	<input type="checkbox"/>
Liver Profile	<input type="checkbox"/>	<input type="checkbox"/>
Se. Albumin	<input type="checkbox"/>	<input type="checkbox"/>
Urinalysis	<input type="checkbox"/>	<input type="checkbox"/>

7.12 Comments:



Preoperative Assessment Practice Questionnaire

A heavy smoker undergoing this grade of surgery:

7.13 *Low-risk*

	N	E
ECG	<input type="checkbox"/>	<input type="checkbox"/>
CXR	<input type="checkbox"/>	<input type="checkbox"/>
CBC	<input type="checkbox"/>	<input type="checkbox"/>
Renal Profile	<input type="checkbox"/>	<input type="checkbox"/>
Coagulation Screen	<input type="checkbox"/>	<input type="checkbox"/>
RBG	<input type="checkbox"/>	<input type="checkbox"/>
Liver Profile	<input type="checkbox"/>	<input type="checkbox"/>
Se. Albumin	<input type="checkbox"/>	<input type="checkbox"/>
Urinalysis	<input type="checkbox"/>	<input type="checkbox"/>
Spirometry	<input type="checkbox"/>	<input type="checkbox"/>
Arterial Blood Gases	<input type="checkbox"/>	<input type="checkbox"/>
Venous Blood Gases	<input type="checkbox"/>	<input type="checkbox"/>
Pulse Oximetry	<input type="checkbox"/>	<input type="checkbox"/>

7.14 *Intermediate-risk*

	N	E
ECG	<input type="checkbox"/>	<input type="checkbox"/>
CXR	<input type="checkbox"/>	<input type="checkbox"/>
CBC	<input type="checkbox"/>	<input type="checkbox"/>
Renal Profile	<input type="checkbox"/>	<input type="checkbox"/>
Coagulation Screen	<input type="checkbox"/>	<input type="checkbox"/>
RBG	<input type="checkbox"/>	<input type="checkbox"/>
Liver Profile	<input type="checkbox"/>	<input type="checkbox"/>
Se. Albumin	<input type="checkbox"/>	<input type="checkbox"/>
Urinalysis	<input type="checkbox"/>	<input type="checkbox"/>
Spirometry	<input type="checkbox"/>	<input type="checkbox"/>
Arterial Blood Gases	<input type="checkbox"/>	<input type="checkbox"/>
Venous Blood Gases	<input type="checkbox"/>	<input type="checkbox"/>
Pulse Oximetry	<input type="checkbox"/>	<input type="checkbox"/>

7.15 *High-risk*

	N	E
ECG	<input type="checkbox"/>	<input type="checkbox"/>
CXR	<input type="checkbox"/>	<input type="checkbox"/>
CBC	<input type="checkbox"/>	<input type="checkbox"/>
Renal Profile	<input type="checkbox"/>	<input type="checkbox"/>
Coagulation Screen	<input type="checkbox"/>	<input type="checkbox"/>
RBG	<input type="checkbox"/>	<input type="checkbox"/>
Liver Profile	<input type="checkbox"/>	<input type="checkbox"/>
Se. Albumin	<input type="checkbox"/>	<input type="checkbox"/>
Urinalysis	<input type="checkbox"/>	<input type="checkbox"/>
Spirometry	<input type="checkbox"/>	<input type="checkbox"/>
Arterial Blood Gases	<input type="checkbox"/>	<input type="checkbox"/>
Venous Blood Gases	<input type="checkbox"/>	<input type="checkbox"/>
Pulse Oximetry	<input type="checkbox"/>	<input type="checkbox"/>

7.16 Comments:

A patient with well-controlled hypertension undergoing this grade of surgery:

7.17 *Low-risk*

	N	E
ECG	<input type="checkbox"/>	<input type="checkbox"/>
CXR	<input type="checkbox"/>	<input type="checkbox"/>
CBC	<input type="checkbox"/>	<input type="checkbox"/>
Renal Profile	<input type="checkbox"/>	<input type="checkbox"/>
Coagulation Screen	<input type="checkbox"/>	<input type="checkbox"/>
RBG	<input type="checkbox"/>	<input type="checkbox"/>
Liver Profile	<input type="checkbox"/>	<input type="checkbox"/>
Se. Albumin	<input type="checkbox"/>	<input type="checkbox"/>
Urinalysis	<input type="checkbox"/>	<input type="checkbox"/>

7.18 *Intermediate-risk*

	N	E
ECG	<input type="checkbox"/>	<input type="checkbox"/>
CXR	<input type="checkbox"/>	<input type="checkbox"/>
CBC	<input type="checkbox"/>	<input type="checkbox"/>
Renal Profile	<input type="checkbox"/>	<input type="checkbox"/>
Coagulation Screen	<input type="checkbox"/>	<input type="checkbox"/>
RBG	<input type="checkbox"/>	<input type="checkbox"/>
Liver Profile	<input type="checkbox"/>	<input type="checkbox"/>
Se. Albumin	<input type="checkbox"/>	<input type="checkbox"/>
Urinalysis	<input type="checkbox"/>	<input type="checkbox"/>

7.19 *High-risk*

	N	E
ECG	<input type="checkbox"/>	<input type="checkbox"/>
CXR	<input type="checkbox"/>	<input type="checkbox"/>
CBC	<input type="checkbox"/>	<input type="checkbox"/>
Renal Profile	<input type="checkbox"/>	<input type="checkbox"/>
Coagulation Screen	<input type="checkbox"/>	<input type="checkbox"/>
RBG	<input type="checkbox"/>	<input type="checkbox"/>
Liver Profile	<input type="checkbox"/>	<input type="checkbox"/>
Se. Albumin	<input type="checkbox"/>	<input type="checkbox"/>
Urinalysis	<input type="checkbox"/>	<input type="checkbox"/>

7.20 Comments:



Preoperative Assessment Practice Questionnaire

A patient suffering from **stable ischaemic heart disease with minor functional impairment** undergoing this grade of surgery:

7.21 Low-risk

	N	E
ECG	<input type="checkbox"/>	<input type="checkbox"/>
CXR	<input type="checkbox"/>	<input type="checkbox"/>
CBC	<input type="checkbox"/>	<input type="checkbox"/>
Renal Profile	<input type="checkbox"/>	<input type="checkbox"/>
Coagulation Screen	<input type="checkbox"/>	<input type="checkbox"/>
RBG	<input type="checkbox"/>	<input type="checkbox"/>
Liver Profile	<input type="checkbox"/>	<input type="checkbox"/>
Se. Albumin	<input type="checkbox"/>	<input type="checkbox"/>
Urinalysis	<input type="checkbox"/>	<input type="checkbox"/>
Non-invasive Stress Testing	<input type="checkbox"/>	<input type="checkbox"/>
Echocardiogram	<input type="checkbox"/>	<input type="checkbox"/>
Angiography	<input type="checkbox"/>	<input type="checkbox"/>

7.22 Intermediate-risk

	N	E
ECG	<input type="checkbox"/>	<input type="checkbox"/>
CXR	<input type="checkbox"/>	<input type="checkbox"/>
CBC	<input type="checkbox"/>	<input type="checkbox"/>
Renal Profile	<input type="checkbox"/>	<input type="checkbox"/>
Coagulation Screen	<input type="checkbox"/>	<input type="checkbox"/>
RBG	<input type="checkbox"/>	<input type="checkbox"/>
Liver Profile	<input type="checkbox"/>	<input type="checkbox"/>
Se. Albumin	<input type="checkbox"/>	<input type="checkbox"/>
Urinalysis	<input type="checkbox"/>	<input type="checkbox"/>
Non-invasive Stress Testing	<input type="checkbox"/>	<input type="checkbox"/>
Echocardiogram	<input type="checkbox"/>	<input type="checkbox"/>
Angiography	<input type="checkbox"/>	<input type="checkbox"/>

7.23 High-risk

	N	E
ECG	<input type="checkbox"/>	<input type="checkbox"/>
CXR	<input type="checkbox"/>	<input type="checkbox"/>
CBC	<input type="checkbox"/>	<input type="checkbox"/>
Renal Profile	<input type="checkbox"/>	<input type="checkbox"/>
Coagulation Screen	<input type="checkbox"/>	<input type="checkbox"/>
RBG	<input type="checkbox"/>	<input type="checkbox"/>
Liver Profile	<input type="checkbox"/>	<input type="checkbox"/>
Se. Albumin	<input type="checkbox"/>	<input type="checkbox"/>
Urinalysis	<input type="checkbox"/>	<input type="checkbox"/>
Non-invasive Stress Testing	<input type="checkbox"/>	<input type="checkbox"/>
Echocardiogram	<input type="checkbox"/>	<input type="checkbox"/>
Angiography	<input type="checkbox"/>	<input type="checkbox"/>

7.24 Comments:

A patient suffering from **stable ischaemic heart disease with moderate functional impairment** undergoing this grade of surgery:

7.25 Low-risk

	N	E
ECG	<input type="checkbox"/>	<input type="checkbox"/>
CXR	<input type="checkbox"/>	<input type="checkbox"/>
CBC	<input type="checkbox"/>	<input type="checkbox"/>
Renal Profile	<input type="checkbox"/>	<input type="checkbox"/>
Coagulation Screen	<input type="checkbox"/>	<input type="checkbox"/>
RBG	<input type="checkbox"/>	<input type="checkbox"/>
Liver Profile	<input type="checkbox"/>	<input type="checkbox"/>
Se. Albumin	<input type="checkbox"/>	<input type="checkbox"/>
Urinalysis	<input type="checkbox"/>	<input type="checkbox"/>
Non-invasive Stress Testing	<input type="checkbox"/>	<input type="checkbox"/>
Echocardiogram	<input type="checkbox"/>	<input type="checkbox"/>
Angiography	<input type="checkbox"/>	<input type="checkbox"/>

7.26 Intermediate-risk

	N	E
ECG	<input type="checkbox"/>	<input type="checkbox"/>
CXR	<input type="checkbox"/>	<input type="checkbox"/>
CBC	<input type="checkbox"/>	<input type="checkbox"/>
Renal Profile	<input type="checkbox"/>	<input type="checkbox"/>
Coagulation Screen	<input type="checkbox"/>	<input type="checkbox"/>
RBG	<input type="checkbox"/>	<input type="checkbox"/>
Liver Profile	<input type="checkbox"/>	<input type="checkbox"/>
Se. Albumin	<input type="checkbox"/>	<input type="checkbox"/>
Urinalysis	<input type="checkbox"/>	<input type="checkbox"/>
Non-invasive Stress Testing	<input type="checkbox"/>	<input type="checkbox"/>
Echocardiogram	<input type="checkbox"/>	<input type="checkbox"/>
Angiography	<input type="checkbox"/>	<input type="checkbox"/>

7.27 High-risk

	N	E
ECG	<input type="checkbox"/>	<input type="checkbox"/>
CXR	<input type="checkbox"/>	<input type="checkbox"/>
CBC	<input type="checkbox"/>	<input type="checkbox"/>
Renal Profile	<input type="checkbox"/>	<input type="checkbox"/>
Coagulation Screen	<input type="checkbox"/>	<input type="checkbox"/>
RBG	<input type="checkbox"/>	<input type="checkbox"/>
Liver Profile	<input type="checkbox"/>	<input type="checkbox"/>
Se. Albumin	<input type="checkbox"/>	<input type="checkbox"/>
Urinalysis	<input type="checkbox"/>	<input type="checkbox"/>
Non-invasive Stress Testing	<input type="checkbox"/>	<input type="checkbox"/>
Echocardiogram	<input type="checkbox"/>	<input type="checkbox"/>
Angiography	<input type="checkbox"/>	<input type="checkbox"/>

7.28 Comments:



1051833853 0010

Preoperative Assessment Practice Questionnaire

A patient suffering from stable ischaemic heart disease with major functional impairment undergoing this grade of surgery:

7.29 Low-risk

	N	E
ECG	<input type="checkbox"/>	<input type="checkbox"/>
CXR	<input type="checkbox"/>	<input type="checkbox"/>
CBC	<input type="checkbox"/>	<input type="checkbox"/>
Renal Profile	<input type="checkbox"/>	<input type="checkbox"/>
Coagulation Screen	<input type="checkbox"/>	<input type="checkbox"/>
RBG	<input type="checkbox"/>	<input type="checkbox"/>
Liver Profile	<input type="checkbox"/>	<input type="checkbox"/>
Se. Albumin	<input type="checkbox"/>	<input type="checkbox"/>
Urinalysis	<input type="checkbox"/>	<input type="checkbox"/>
Non-invasive Stress Testing	<input type="checkbox"/>	<input type="checkbox"/>
Echocardiogram	<input type="checkbox"/>	<input type="checkbox"/>
Angiography	<input type="checkbox"/>	<input type="checkbox"/>

7.30 Intermediate-risk

	N	E
ECG	<input type="checkbox"/>	<input type="checkbox"/>
CXR	<input type="checkbox"/>	<input type="checkbox"/>
CBC	<input type="checkbox"/>	<input type="checkbox"/>
Renal Profile	<input type="checkbox"/>	<input type="checkbox"/>
Coagulation Screen	<input type="checkbox"/>	<input type="checkbox"/>
RBG	<input type="checkbox"/>	<input type="checkbox"/>
Liver Profile	<input type="checkbox"/>	<input type="checkbox"/>
Se. Albumin	<input type="checkbox"/>	<input type="checkbox"/>
Urinalysis	<input type="checkbox"/>	<input type="checkbox"/>
Non-invasive Stress Testing	<input type="checkbox"/>	<input type="checkbox"/>
Echocardiogram	<input type="checkbox"/>	<input type="checkbox"/>
Angiography	<input type="checkbox"/>	<input type="checkbox"/>

7.31 High-risk

	N	E
ECG	<input type="checkbox"/>	<input type="checkbox"/>
CXR	<input type="checkbox"/>	<input type="checkbox"/>
CBC	<input type="checkbox"/>	<input type="checkbox"/>
Renal Profile	<input type="checkbox"/>	<input type="checkbox"/>
Coagulation Screen	<input type="checkbox"/>	<input type="checkbox"/>
RBG	<input type="checkbox"/>	<input type="checkbox"/>
Liver Profile	<input type="checkbox"/>	<input type="checkbox"/>
Se. Albumin	<input type="checkbox"/>	<input type="checkbox"/>
Urinalysis	<input type="checkbox"/>	<input type="checkbox"/>
Non-invasive Stress Testing	<input type="checkbox"/>	<input type="checkbox"/>
Echocardiogram	<input type="checkbox"/>	<input type="checkbox"/>
Angiography	<input type="checkbox"/>	<input type="checkbox"/>

7.32 Comments:

A patient suffering from congestive heart failure with minor functional impairment undergoing this grade of surgery:

7.33 Low-risk

	N	E
ECG	<input type="checkbox"/>	<input type="checkbox"/>
CXR	<input type="checkbox"/>	<input type="checkbox"/>
CBC	<input type="checkbox"/>	<input type="checkbox"/>
Renal Profile	<input type="checkbox"/>	<input type="checkbox"/>
Coagulation Screen	<input type="checkbox"/>	<input type="checkbox"/>
RBG	<input type="checkbox"/>	<input type="checkbox"/>
Liver Profile	<input type="checkbox"/>	<input type="checkbox"/>
Se. Albumin	<input type="checkbox"/>	<input type="checkbox"/>
Urinalysis	<input type="checkbox"/>	<input type="checkbox"/>
Non-invasive Stress Testing	<input type="checkbox"/>	<input type="checkbox"/>
Echocardiogram	<input type="checkbox"/>	<input type="checkbox"/>
Angiography	<input type="checkbox"/>	<input type="checkbox"/>

7.34 Intermediate-risk

	N	E
ECG	<input type="checkbox"/>	<input type="checkbox"/>
CXR	<input type="checkbox"/>	<input type="checkbox"/>
CBC	<input type="checkbox"/>	<input type="checkbox"/>
Renal Profile	<input type="checkbox"/>	<input type="checkbox"/>
Coagulation Screen	<input type="checkbox"/>	<input type="checkbox"/>
RBG	<input type="checkbox"/>	<input type="checkbox"/>
Liver Profile	<input type="checkbox"/>	<input type="checkbox"/>
Se. Albumin	<input type="checkbox"/>	<input type="checkbox"/>
Urinalysis	<input type="checkbox"/>	<input type="checkbox"/>
Non-invasive Stress Testing	<input type="checkbox"/>	<input type="checkbox"/>
Echocardiogram	<input type="checkbox"/>	<input type="checkbox"/>
Angiography	<input type="checkbox"/>	<input type="checkbox"/>

7.35 High-risk

	N	E
ECG	<input type="checkbox"/>	<input type="checkbox"/>
CXR	<input type="checkbox"/>	<input type="checkbox"/>
CBC	<input type="checkbox"/>	<input type="checkbox"/>
Renal Profile	<input type="checkbox"/>	<input type="checkbox"/>
Coagulation Screen	<input type="checkbox"/>	<input type="checkbox"/>
RBG	<input type="checkbox"/>	<input type="checkbox"/>
Liver Profile	<input type="checkbox"/>	<input type="checkbox"/>
Se. Albumin	<input type="checkbox"/>	<input type="checkbox"/>
Urinalysis	<input type="checkbox"/>	<input type="checkbox"/>
Non-invasive Stress Testing	<input type="checkbox"/>	<input type="checkbox"/>
Echocardiogram	<input type="checkbox"/>	<input type="checkbox"/>
Angiography	<input type="checkbox"/>	<input type="checkbox"/>

7.36 Comments:



1051833853 0011

Preoperative Assessment Practice Questionnaire

A patient suffering from **congestive heart failure with intermediate functional impairment** undergoing this grade of surgery:

7.37 Low-risk

	N	E
ECG	<input type="checkbox"/>	<input type="checkbox"/>
CXR	<input type="checkbox"/>	<input type="checkbox"/>
CBC	<input type="checkbox"/>	<input type="checkbox"/>
Renal Profile	<input type="checkbox"/>	<input type="checkbox"/>
Coagulation Screen	<input type="checkbox"/>	<input type="checkbox"/>
RBG	<input type="checkbox"/>	<input type="checkbox"/>
Liver Profile	<input type="checkbox"/>	<input type="checkbox"/>
Se. Albumin	<input type="checkbox"/>	<input type="checkbox"/>
Urinalysis	<input type="checkbox"/>	<input type="checkbox"/>
Non-invasive Stress Testing	<input type="checkbox"/>	<input type="checkbox"/>
Echocardiogram	<input type="checkbox"/>	<input type="checkbox"/>
Angiography	<input type="checkbox"/>	<input type="checkbox"/>

7.38 Intermediate-risk

	N	E
ECG	<input type="checkbox"/>	<input type="checkbox"/>
CXR	<input type="checkbox"/>	<input type="checkbox"/>
CBC	<input type="checkbox"/>	<input type="checkbox"/>
Renal Profile	<input type="checkbox"/>	<input type="checkbox"/>
Coagulation Screen	<input type="checkbox"/>	<input type="checkbox"/>
RBG	<input type="checkbox"/>	<input type="checkbox"/>
Liver Profile	<input type="checkbox"/>	<input type="checkbox"/>
Se. Albumin	<input type="checkbox"/>	<input type="checkbox"/>
Urinalysis	<input type="checkbox"/>	<input type="checkbox"/>
Non-invasive Stress Testing	<input type="checkbox"/>	<input type="checkbox"/>
Echocardiogram	<input type="checkbox"/>	<input type="checkbox"/>
Angiography	<input type="checkbox"/>	<input type="checkbox"/>

7.39 High-risk

	N	E
ECG	<input type="checkbox"/>	<input type="checkbox"/>
CXR	<input type="checkbox"/>	<input type="checkbox"/>
CBC	<input type="checkbox"/>	<input type="checkbox"/>
Renal Profile	<input type="checkbox"/>	<input type="checkbox"/>
Coagulation Screen	<input type="checkbox"/>	<input type="checkbox"/>
RBG	<input type="checkbox"/>	<input type="checkbox"/>
Liver Profile	<input type="checkbox"/>	<input type="checkbox"/>
Se. Albumin	<input type="checkbox"/>	<input type="checkbox"/>
Urinalysis	<input type="checkbox"/>	<input type="checkbox"/>
Non-invasive Stress Testing	<input type="checkbox"/>	<input type="checkbox"/>
Echocardiogram	<input type="checkbox"/>	<input type="checkbox"/>
Angiography	<input type="checkbox"/>	<input type="checkbox"/>

7.40 Comments:

A patient suffering from **congestive heart failure with major functional impairment** undergoing this grade of surgery:

7.41 Low-risk

	N	E
ECG	<input type="checkbox"/>	<input type="checkbox"/>
CXR	<input type="checkbox"/>	<input type="checkbox"/>
CBC	<input type="checkbox"/>	<input type="checkbox"/>
Renal Profile	<input type="checkbox"/>	<input type="checkbox"/>
Coagulation Screen	<input type="checkbox"/>	<input type="checkbox"/>
RBG	<input type="checkbox"/>	<input type="checkbox"/>
Liver Profile	<input type="checkbox"/>	<input type="checkbox"/>
Se. Albumin	<input type="checkbox"/>	<input type="checkbox"/>
Urinalysis	<input type="checkbox"/>	<input type="checkbox"/>
Non-invasive Stress Testing	<input type="checkbox"/>	<input type="checkbox"/>
Echocardiogram	<input type="checkbox"/>	<input type="checkbox"/>
Angiography	<input type="checkbox"/>	<input type="checkbox"/>

7.42 Intermediate-risk

	N	E
ECG	<input type="checkbox"/>	<input type="checkbox"/>
CXR	<input type="checkbox"/>	<input type="checkbox"/>
CBC	<input type="checkbox"/>	<input type="checkbox"/>
Renal Profile	<input type="checkbox"/>	<input type="checkbox"/>
Coagulation Screen	<input type="checkbox"/>	<input type="checkbox"/>
RBG	<input type="checkbox"/>	<input type="checkbox"/>
Liver Profile	<input type="checkbox"/>	<input type="checkbox"/>
Se. Albumin	<input type="checkbox"/>	<input type="checkbox"/>
Urinalysis	<input type="checkbox"/>	<input type="checkbox"/>
Non-invasive Stress Testing	<input type="checkbox"/>	<input type="checkbox"/>
Echocardiogram	<input type="checkbox"/>	<input type="checkbox"/>
Angiography	<input type="checkbox"/>	<input type="checkbox"/>

7.43 High-risk

	N	E
ECG	<input type="checkbox"/>	<input type="checkbox"/>
CXR	<input type="checkbox"/>	<input type="checkbox"/>
CBC	<input type="checkbox"/>	<input type="checkbox"/>
Renal Profile	<input type="checkbox"/>	<input type="checkbox"/>
Coagulation Screen	<input type="checkbox"/>	<input type="checkbox"/>
RBG	<input type="checkbox"/>	<input type="checkbox"/>
Liver Profile	<input type="checkbox"/>	<input type="checkbox"/>
Se. Albumin	<input type="checkbox"/>	<input type="checkbox"/>
Urinalysis	<input type="checkbox"/>	<input type="checkbox"/>
Non-invasive Stress Testing	<input type="checkbox"/>	<input type="checkbox"/>
Echocardiogram	<input type="checkbox"/>	<input type="checkbox"/>
Angiography	<input type="checkbox"/>	<input type="checkbox"/>

7.44 Comments:



1051833853 0012

Preoperative Assessment Practice Questionnaire

A patient suffering from Chronic Obstructive Pulmonary Disease with minor functional impairment undergoing this grade of surgery:

7.45 Low-risk

	N	E
ECG	<input type="checkbox"/>	<input type="checkbox"/>
CXR	<input type="checkbox"/>	<input type="checkbox"/>
CBC	<input type="checkbox"/>	<input type="checkbox"/>
Renal Profile	<input type="checkbox"/>	<input type="checkbox"/>
Coagulation Screen	<input type="checkbox"/>	<input type="checkbox"/>
RBG	<input type="checkbox"/>	<input type="checkbox"/>
Liver Profile	<input type="checkbox"/>	<input type="checkbox"/>
Se. Albumin	<input type="checkbox"/>	<input type="checkbox"/>
Urinalysis	<input type="checkbox"/>	<input type="checkbox"/>
Spirometry	<input type="checkbox"/>	<input type="checkbox"/>
Arterial Blood Gases	<input type="checkbox"/>	<input type="checkbox"/>
Venous Blood Gases	<input type="checkbox"/>	<input type="checkbox"/>
Pulse Oximetry	<input type="checkbox"/>	<input type="checkbox"/>

7.46 Intermediate-risk

	N	E
ECG	<input type="checkbox"/>	<input type="checkbox"/>
CXR	<input type="checkbox"/>	<input type="checkbox"/>
CBC	<input type="checkbox"/>	<input type="checkbox"/>
Renal Profile	<input type="checkbox"/>	<input type="checkbox"/>
Coagulation Screen	<input type="checkbox"/>	<input type="checkbox"/>
RBG	<input type="checkbox"/>	<input type="checkbox"/>
Liver Profile	<input type="checkbox"/>	<input type="checkbox"/>
Se. Albumin	<input type="checkbox"/>	<input type="checkbox"/>
Urinalysis	<input type="checkbox"/>	<input type="checkbox"/>
Spirometry	<input type="checkbox"/>	<input type="checkbox"/>
Arterial Blood Gases	<input type="checkbox"/>	<input type="checkbox"/>
Venous Blood Gases	<input type="checkbox"/>	<input type="checkbox"/>
Pulse Oximetry	<input type="checkbox"/>	<input type="checkbox"/>

7.47 High-risk

	N	E
ECG	<input type="checkbox"/>	<input type="checkbox"/>
CXR	<input type="checkbox"/>	<input type="checkbox"/>
CBC	<input type="checkbox"/>	<input type="checkbox"/>
Renal Profile	<input type="checkbox"/>	<input type="checkbox"/>
Coagulation Screen	<input type="checkbox"/>	<input type="checkbox"/>
RBG	<input type="checkbox"/>	<input type="checkbox"/>
Liver Profile	<input type="checkbox"/>	<input type="checkbox"/>
Se. Albumin	<input type="checkbox"/>	<input type="checkbox"/>
Urinalysis	<input type="checkbox"/>	<input type="checkbox"/>
Spirometry	<input type="checkbox"/>	<input type="checkbox"/>
Arterial Blood Gases	<input type="checkbox"/>	<input type="checkbox"/>
Venous Blood Gases	<input type="checkbox"/>	<input type="checkbox"/>
Pulse Oximetry	<input type="checkbox"/>	<input type="checkbox"/>

7.48 Comments:

A patient suffering from Chronic Obstructive Pulmonary Disease with moderate functional impairment undergoing this grade of surgery:

7.49 Low-risk

	N	E
ECG	<input type="checkbox"/>	<input type="checkbox"/>
CXR	<input type="checkbox"/>	<input type="checkbox"/>
CBC	<input type="checkbox"/>	<input type="checkbox"/>
Renal Profile	<input type="checkbox"/>	<input type="checkbox"/>
Coagulation Screen	<input type="checkbox"/>	<input type="checkbox"/>
RBG	<input type="checkbox"/>	<input type="checkbox"/>
Liver Profile	<input type="checkbox"/>	<input type="checkbox"/>
Se. Albumin	<input type="checkbox"/>	<input type="checkbox"/>
Urinalysis	<input type="checkbox"/>	<input type="checkbox"/>
Spirometry	<input type="checkbox"/>	<input type="checkbox"/>
Arterial Blood Gases	<input type="checkbox"/>	<input type="checkbox"/>
Venous Blood Gases	<input type="checkbox"/>	<input type="checkbox"/>
Pulse Oximetry	<input type="checkbox"/>	<input type="checkbox"/>

7.50 Intermediate-risk

	N	E
ECG	<input type="checkbox"/>	<input type="checkbox"/>
CXR	<input type="checkbox"/>	<input type="checkbox"/>
CBC	<input type="checkbox"/>	<input type="checkbox"/>
Renal Profile	<input type="checkbox"/>	<input type="checkbox"/>
Coagulation Screen	<input type="checkbox"/>	<input type="checkbox"/>
RBG	<input type="checkbox"/>	<input type="checkbox"/>
Liver Profile	<input type="checkbox"/>	<input type="checkbox"/>
Se. Albumin	<input type="checkbox"/>	<input type="checkbox"/>
Urinalysis	<input type="checkbox"/>	<input type="checkbox"/>
Spirometry	<input type="checkbox"/>	<input type="checkbox"/>
Arterial Blood Gases	<input type="checkbox"/>	<input type="checkbox"/>
Venous Blood Gases	<input type="checkbox"/>	<input type="checkbox"/>
Pulse Oximetry	<input type="checkbox"/>	<input type="checkbox"/>

7.51 High-risk

	N	E
ECG	<input type="checkbox"/>	<input type="checkbox"/>
CXR	<input type="checkbox"/>	<input type="checkbox"/>
CBC	<input type="checkbox"/>	<input type="checkbox"/>
Renal Profile	<input type="checkbox"/>	<input type="checkbox"/>
Coagulation Screen	<input type="checkbox"/>	<input type="checkbox"/>
RBG	<input type="checkbox"/>	<input type="checkbox"/>
Liver Profile	<input type="checkbox"/>	<input type="checkbox"/>
Se. Albumin	<input type="checkbox"/>	<input type="checkbox"/>
Urinalysis	<input type="checkbox"/>	<input type="checkbox"/>
Spirometry	<input type="checkbox"/>	<input type="checkbox"/>
Arterial Blood Gases	<input type="checkbox"/>	<input type="checkbox"/>
Venous Blood Gases	<input type="checkbox"/>	<input type="checkbox"/>
Pulse Oximetry	<input type="checkbox"/>	<input type="checkbox"/>

7.52 Comments:



1051833853 0013

Preoperative Assessment Practice Questionnaire

*A patient suffering from **Chronic Obstructive Pulmonary Disease** with major functional impairment undergoing this grade of surgery:*

7.53 *Low-risk*

	N	E
ECG	<input type="checkbox"/>	<input type="checkbox"/>
CXR	<input type="checkbox"/>	<input type="checkbox"/>
CBC	<input type="checkbox"/>	<input type="checkbox"/>
Renal Profile	<input type="checkbox"/>	<input type="checkbox"/>
Coagulation Screen	<input type="checkbox"/>	<input type="checkbox"/>
RBG	<input type="checkbox"/>	<input type="checkbox"/>
Liver Profile	<input type="checkbox"/>	<input type="checkbox"/>
Se. Albumin	<input type="checkbox"/>	<input type="checkbox"/>
Urinalysis	<input type="checkbox"/>	<input type="checkbox"/>
Spirometry	<input type="checkbox"/>	<input type="checkbox"/>
Arterial Blood Gases	<input type="checkbox"/>	<input type="checkbox"/>
Venous Blood Gases	<input type="checkbox"/>	<input type="checkbox"/>
Pulse Oximetry	<input type="checkbox"/>	<input type="checkbox"/>

7.54 *Intermediate-risk*

	N	E
ECG	<input type="checkbox"/>	<input type="checkbox"/>
CXR	<input type="checkbox"/>	<input type="checkbox"/>
CBC	<input type="checkbox"/>	<input type="checkbox"/>
Renal Profile	<input type="checkbox"/>	<input type="checkbox"/>
Coagulation Screen	<input type="checkbox"/>	<input type="checkbox"/>
RBG	<input type="checkbox"/>	<input type="checkbox"/>
Liver Profile	<input type="checkbox"/>	<input type="checkbox"/>
Se. Albumin	<input type="checkbox"/>	<input type="checkbox"/>
Urinalysis	<input type="checkbox"/>	<input type="checkbox"/>
Spirometry	<input type="checkbox"/>	<input type="checkbox"/>
Arterial Blood Gases	<input type="checkbox"/>	<input type="checkbox"/>
Venous Blood Gases	<input type="checkbox"/>	<input type="checkbox"/>
Pulse Oximetry	<input type="checkbox"/>	<input type="checkbox"/>

7.55 *High-risk*

	N	E
ECG	<input type="checkbox"/>	<input type="checkbox"/>
CXR	<input type="checkbox"/>	<input type="checkbox"/>
CBC	<input type="checkbox"/>	<input type="checkbox"/>
Renal Profile	<input type="checkbox"/>	<input type="checkbox"/>
Coagulation Screen	<input type="checkbox"/>	<input type="checkbox"/>
RBG	<input type="checkbox"/>	<input type="checkbox"/>
Liver Profile	<input type="checkbox"/>	<input type="checkbox"/>
Se. Albumin	<input type="checkbox"/>	<input type="checkbox"/>
Urinalysis	<input type="checkbox"/>	<input type="checkbox"/>
Spirometry	<input type="checkbox"/>	<input type="checkbox"/>
Arterial Blood Gases	<input type="checkbox"/>	<input type="checkbox"/>
Venous Blood Gases	<input type="checkbox"/>	<input type="checkbox"/>
Pulse Oximetry	<input type="checkbox"/>	<input type="checkbox"/>

7.56 Comments:

*A patient suffering from **well controlled asthma** undergoing this grade of surgery:*

7.57 *Low-risk*

	N	E
ECG	<input type="checkbox"/>	<input type="checkbox"/>
CXR	<input type="checkbox"/>	<input type="checkbox"/>
CBC	<input type="checkbox"/>	<input type="checkbox"/>
Renal Profile	<input type="checkbox"/>	<input type="checkbox"/>
Coagulation Screen	<input type="checkbox"/>	<input type="checkbox"/>
RBG	<input type="checkbox"/>	<input type="checkbox"/>
Liver Profile	<input type="checkbox"/>	<input type="checkbox"/>
Se. Albumin	<input type="checkbox"/>	<input type="checkbox"/>
Urinalysis	<input type="checkbox"/>	<input type="checkbox"/>
Spirometry	<input type="checkbox"/>	<input type="checkbox"/>
Arterial Blood Gases	<input type="checkbox"/>	<input type="checkbox"/>
Venous Blood Gases	<input type="checkbox"/>	<input type="checkbox"/>
Pulse Oximetry	<input type="checkbox"/>	<input type="checkbox"/>

7.58 *Intermediate-risk*

	N	E
ECG	<input type="checkbox"/>	<input type="checkbox"/>
CXR	<input type="checkbox"/>	<input type="checkbox"/>
CBC	<input type="checkbox"/>	<input type="checkbox"/>
Renal Profile	<input type="checkbox"/>	<input type="checkbox"/>
Coagulation Screen	<input type="checkbox"/>	<input type="checkbox"/>
RBG	<input type="checkbox"/>	<input type="checkbox"/>
Liver Profile	<input type="checkbox"/>	<input type="checkbox"/>
Se. Albumin	<input type="checkbox"/>	<input type="checkbox"/>
Urinalysis	<input type="checkbox"/>	<input type="checkbox"/>
Spirometry	<input type="checkbox"/>	<input type="checkbox"/>
Arterial Blood Gases	<input type="checkbox"/>	<input type="checkbox"/>
Venous Blood Gases	<input type="checkbox"/>	<input type="checkbox"/>
Pulse Oximetry	<input type="checkbox"/>	<input type="checkbox"/>

7.59 *High-risk*

	N	E
ECG	<input type="checkbox"/>	<input type="checkbox"/>
CXR	<input type="checkbox"/>	<input type="checkbox"/>
CBC	<input type="checkbox"/>	<input type="checkbox"/>
Renal Profile	<input type="checkbox"/>	<input type="checkbox"/>
Coagulation Screen	<input type="checkbox"/>	<input type="checkbox"/>
RBG	<input type="checkbox"/>	<input type="checkbox"/>
Liver Profile	<input type="checkbox"/>	<input type="checkbox"/>
Se. Albumin	<input type="checkbox"/>	<input type="checkbox"/>
Urinalysis	<input type="checkbox"/>	<input type="checkbox"/>
Spirometry	<input type="checkbox"/>	<input type="checkbox"/>
Arterial Blood Gases	<input type="checkbox"/>	<input type="checkbox"/>
Venous Blood Gases	<input type="checkbox"/>	<input type="checkbox"/>
Pulse Oximetry	<input type="checkbox"/>	<input type="checkbox"/>

7.60 Comments:



Preoperative Assessment Practice Questionnaire

A patient suffering from poorly controlled asthma undergoing this grade of surgery:

7.61 *Low-risk*

	N	E
ECG	<input type="checkbox"/>	<input type="checkbox"/>
CXR	<input type="checkbox"/>	<input type="checkbox"/>
CBC	<input type="checkbox"/>	<input type="checkbox"/>
Renal Profile	<input type="checkbox"/>	<input type="checkbox"/>
Coagulation Screen	<input type="checkbox"/>	<input type="checkbox"/>
RBG	<input type="checkbox"/>	<input type="checkbox"/>
Liver Profile	<input type="checkbox"/>	<input type="checkbox"/>
Se. Albumin	<input type="checkbox"/>	<input type="checkbox"/>
Urinalysis	<input type="checkbox"/>	<input type="checkbox"/>
Spirometry	<input type="checkbox"/>	<input type="checkbox"/>
Arterial Blood Gases	<input type="checkbox"/>	<input type="checkbox"/>
Venous Blood Gases	<input type="checkbox"/>	<input type="checkbox"/>
Pulse Oximetry	<input type="checkbox"/>	<input type="checkbox"/>

7.62 *Intermediate-risk*

	N	E
ECG	<input type="checkbox"/>	<input type="checkbox"/>
CXR	<input type="checkbox"/>	<input type="checkbox"/>
CBC	<input type="checkbox"/>	<input type="checkbox"/>
Renal Profile	<input type="checkbox"/>	<input type="checkbox"/>
Coagulation Screen	<input type="checkbox"/>	<input type="checkbox"/>
RBG	<input type="checkbox"/>	<input type="checkbox"/>
Liver Profile	<input type="checkbox"/>	<input type="checkbox"/>
Se. Albumin	<input type="checkbox"/>	<input type="checkbox"/>
Urinalysis	<input type="checkbox"/>	<input type="checkbox"/>
Spirometry	<input type="checkbox"/>	<input type="checkbox"/>
Arterial Blood Gases	<input type="checkbox"/>	<input type="checkbox"/>
Venous Blood Gases	<input type="checkbox"/>	<input type="checkbox"/>
Pulse Oximetry	<input type="checkbox"/>	<input type="checkbox"/>

7.63 *High-risk*

	N	E
ECG	<input type="checkbox"/>	<input type="checkbox"/>
CXR	<input type="checkbox"/>	<input type="checkbox"/>
CBC	<input type="checkbox"/>	<input type="checkbox"/>
Renal Profile	<input type="checkbox"/>	<input type="checkbox"/>
Coagulation Screen	<input type="checkbox"/>	<input type="checkbox"/>
RBG	<input type="checkbox"/>	<input type="checkbox"/>
Liver Profile	<input type="checkbox"/>	<input type="checkbox"/>
Se. Albumin	<input type="checkbox"/>	<input type="checkbox"/>
Urinalysis	<input type="checkbox"/>	<input type="checkbox"/>
Spirometry	<input type="checkbox"/>	<input type="checkbox"/>
Arterial Blood Gases	<input type="checkbox"/>	<input type="checkbox"/>
Venous Blood Gases	<input type="checkbox"/>	<input type="checkbox"/>
Pulse Oximetry	<input type="checkbox"/>	<input type="checkbox"/>

7.64 Comments:

A patient suffering from mild obstructive sleep apnoea undergoing this grade of surgery:

7.65 *Low-risk*

	N	E
ECG	<input type="checkbox"/>	<input type="checkbox"/>
CXR	<input type="checkbox"/>	<input type="checkbox"/>
CBC	<input type="checkbox"/>	<input type="checkbox"/>
Renal Profile	<input type="checkbox"/>	<input type="checkbox"/>
Coagulation Screen	<input type="checkbox"/>	<input type="checkbox"/>
RBG	<input type="checkbox"/>	<input type="checkbox"/>
Liver Profile	<input type="checkbox"/>	<input type="checkbox"/>
Se. Albumin	<input type="checkbox"/>	<input type="checkbox"/>
Urinalysis	<input type="checkbox"/>	<input type="checkbox"/>
Spirometry	<input type="checkbox"/>	<input type="checkbox"/>
Arterial Blood Gases	<input type="checkbox"/>	<input type="checkbox"/>
Venous Blood Gases	<input type="checkbox"/>	<input type="checkbox"/>
Pulse Oximetry	<input type="checkbox"/>	<input type="checkbox"/>

7.66 *Intermediate-risk*

	N	E
ECG	<input type="checkbox"/>	<input type="checkbox"/>
CXR	<input type="checkbox"/>	<input type="checkbox"/>
CBC	<input type="checkbox"/>	<input type="checkbox"/>
Renal Profile	<input type="checkbox"/>	<input type="checkbox"/>
Coagulation Screen	<input type="checkbox"/>	<input type="checkbox"/>
RBG	<input type="checkbox"/>	<input type="checkbox"/>
Liver Profile	<input type="checkbox"/>	<input type="checkbox"/>
Se. Albumin	<input type="checkbox"/>	<input type="checkbox"/>
Urinalysis	<input type="checkbox"/>	<input type="checkbox"/>
Spirometry	<input type="checkbox"/>	<input type="checkbox"/>
Arterial Blood Gases	<input type="checkbox"/>	<input type="checkbox"/>
Venous Blood Gases	<input type="checkbox"/>	<input type="checkbox"/>
Pulse Oximetry	<input type="checkbox"/>	<input type="checkbox"/>

7.67 *High-risk*

	N	E
ECG	<input type="checkbox"/>	<input type="checkbox"/>
CXR	<input type="checkbox"/>	<input type="checkbox"/>
CBC	<input type="checkbox"/>	<input type="checkbox"/>
Renal Profile	<input type="checkbox"/>	<input type="checkbox"/>
Coagulation Screen	<input type="checkbox"/>	<input type="checkbox"/>
RBG	<input type="checkbox"/>	<input type="checkbox"/>
Liver Profile	<input type="checkbox"/>	<input type="checkbox"/>
Se. Albumin	<input type="checkbox"/>	<input type="checkbox"/>
Urinalysis	<input type="checkbox"/>	<input type="checkbox"/>
Spirometry	<input type="checkbox"/>	<input type="checkbox"/>
Arterial Blood Gases	<input type="checkbox"/>	<input type="checkbox"/>
Venous Blood Gases	<input type="checkbox"/>	<input type="checkbox"/>
Pulse Oximetry	<input type="checkbox"/>	<input type="checkbox"/>

7.68 Comments:



1051833853 0015

Preoperative Assessment Practice Questionnaire

A patient suffering from severe obstructive sleep apnoea undergoing this grade of surgery:

7.69 *Low-risk*

	N	E
ECG	<input type="checkbox"/>	<input type="checkbox"/>
CXR	<input type="checkbox"/>	<input type="checkbox"/>
CBC	<input type="checkbox"/>	<input type="checkbox"/>
Renal Profile	<input type="checkbox"/>	<input type="checkbox"/>
Coagulation Screen	<input type="checkbox"/>	<input type="checkbox"/>
RBG	<input type="checkbox"/>	<input type="checkbox"/>
Liver Profile	<input type="checkbox"/>	<input type="checkbox"/>
Se. Albumin	<input type="checkbox"/>	<input type="checkbox"/>
Urinalysis	<input type="checkbox"/>	<input type="checkbox"/>
Spirometry	<input type="checkbox"/>	<input type="checkbox"/>
Arterial Blood Gases	<input type="checkbox"/>	<input type="checkbox"/>
Venous Blood Gases	<input type="checkbox"/>	<input type="checkbox"/>
Pulse Oximetry	<input type="checkbox"/>	<input type="checkbox"/>

7.70 *Intermediate-risk*

	N	E
ECG	<input type="checkbox"/>	<input type="checkbox"/>
CXR	<input type="checkbox"/>	<input type="checkbox"/>
CBC	<input type="checkbox"/>	<input type="checkbox"/>
Renal Profile	<input type="checkbox"/>	<input type="checkbox"/>
Coagulation Screen	<input type="checkbox"/>	<input type="checkbox"/>
RBG	<input type="checkbox"/>	<input type="checkbox"/>
Liver Profile	<input type="checkbox"/>	<input type="checkbox"/>
Se. Albumin	<input type="checkbox"/>	<input type="checkbox"/>
Urinalysis	<input type="checkbox"/>	<input type="checkbox"/>
Spirometry	<input type="checkbox"/>	<input type="checkbox"/>
Arterial Blood Gases	<input type="checkbox"/>	<input type="checkbox"/>
Venous Blood Gases	<input type="checkbox"/>	<input type="checkbox"/>
Pulse Oximetry	<input type="checkbox"/>	<input type="checkbox"/>

7.71 *High-risk*

	N	E
ECG	<input type="checkbox"/>	<input type="checkbox"/>
CXR	<input type="checkbox"/>	<input type="checkbox"/>
CBC	<input type="checkbox"/>	<input type="checkbox"/>
Renal Profile	<input type="checkbox"/>	<input type="checkbox"/>
Coagulation Screen	<input type="checkbox"/>	<input type="checkbox"/>
RBG	<input type="checkbox"/>	<input type="checkbox"/>
Liver Profile	<input type="checkbox"/>	<input type="checkbox"/>
Se. Albumin	<input type="checkbox"/>	<input type="checkbox"/>
Urinalysis	<input type="checkbox"/>	<input type="checkbox"/>
Spirometry	<input type="checkbox"/>	<input type="checkbox"/>
Arterial Blood Gases	<input type="checkbox"/>	<input type="checkbox"/>
Venous Blood Gases	<input type="checkbox"/>	<input type="checkbox"/>
Pulse Oximetry	<input type="checkbox"/>	<input type="checkbox"/>

7.72 Comments:

A patient suffering from diet-controlled diabetes mellitus undergoing this grade of surgery:

7.73 *Low-risk*

	N	E
ECG	<input type="checkbox"/>	<input type="checkbox"/>
CXR	<input type="checkbox"/>	<input type="checkbox"/>
CBC	<input type="checkbox"/>	<input type="checkbox"/>
Renal Profile	<input type="checkbox"/>	<input type="checkbox"/>
Coagulation Screen	<input type="checkbox"/>	<input type="checkbox"/>
RBG	<input type="checkbox"/>	<input type="checkbox"/>
Liver Profile	<input type="checkbox"/>	<input type="checkbox"/>
Se. Albumin	<input type="checkbox"/>	<input type="checkbox"/>
Urinalysis	<input type="checkbox"/>	<input type="checkbox"/>
FBG	<input type="checkbox"/>	<input type="checkbox"/>
HBA ₁ C	<input type="checkbox"/>	<input type="checkbox"/>

7.74 *Intermediate-risk*

	N	E
ECG	<input type="checkbox"/>	<input type="checkbox"/>
CXR	<input type="checkbox"/>	<input type="checkbox"/>
CBC	<input type="checkbox"/>	<input type="checkbox"/>
Renal Profile	<input type="checkbox"/>	<input type="checkbox"/>
Coagulation Screen	<input type="checkbox"/>	<input type="checkbox"/>
RBG	<input type="checkbox"/>	<input type="checkbox"/>
Liver Profile	<input type="checkbox"/>	<input type="checkbox"/>
Se. Albumin	<input type="checkbox"/>	<input type="checkbox"/>
Urinalysis	<input type="checkbox"/>	<input type="checkbox"/>
FBG	<input type="checkbox"/>	<input type="checkbox"/>
HBA ₁ C	<input type="checkbox"/>	<input type="checkbox"/>

7.75 *High-risk*

	N	E
ECG	<input type="checkbox"/>	<input type="checkbox"/>
CXR	<input type="checkbox"/>	<input type="checkbox"/>
CBC	<input type="checkbox"/>	<input type="checkbox"/>
Renal Profile	<input type="checkbox"/>	<input type="checkbox"/>
Coagulation Screen	<input type="checkbox"/>	<input type="checkbox"/>
RBG	<input type="checkbox"/>	<input type="checkbox"/>
Liver Profile	<input type="checkbox"/>	<input type="checkbox"/>
Se. Albumin	<input type="checkbox"/>	<input type="checkbox"/>
Urinalysis	<input type="checkbox"/>	<input type="checkbox"/>
FBG	<input type="checkbox"/>	<input type="checkbox"/>
HBA ₁ C	<input type="checkbox"/>	<input type="checkbox"/>

7.76 Comments:



Preoperative Assessment Practice Questionnaire

A patient suffering from diabetes mellitus treated with oral hypoglycaemic agents undergoing this grade of surgery:

7.77 *Low-risk*

	N	E
ECG	<input type="checkbox"/>	<input type="checkbox"/>
CXR	<input type="checkbox"/>	<input type="checkbox"/>
CBC	<input type="checkbox"/>	<input type="checkbox"/>
Renal Profile	<input type="checkbox"/>	<input type="checkbox"/>
Coagulation Screen	<input type="checkbox"/>	<input type="checkbox"/>
RBG	<input type="checkbox"/>	<input type="checkbox"/>
Liver Profile	<input type="checkbox"/>	<input type="checkbox"/>
Se. Albumin	<input type="checkbox"/>	<input type="checkbox"/>
Urinalysis	<input type="checkbox"/>	<input type="checkbox"/>
FBG	<input type="checkbox"/>	<input type="checkbox"/>
HBA ₁ C	<input type="checkbox"/>	<input type="checkbox"/>

7.78 *Intermediate-risk*

	N	E
ECG	<input type="checkbox"/>	<input type="checkbox"/>
CXR	<input type="checkbox"/>	<input type="checkbox"/>
CBC	<input type="checkbox"/>	<input type="checkbox"/>
Renal Profile	<input type="checkbox"/>	<input type="checkbox"/>
Coagulation Screen	<input type="checkbox"/>	<input type="checkbox"/>
RBG	<input type="checkbox"/>	<input type="checkbox"/>
Liver Profile	<input type="checkbox"/>	<input type="checkbox"/>
Se. Albumin	<input type="checkbox"/>	<input type="checkbox"/>
Urinalysis	<input type="checkbox"/>	<input type="checkbox"/>
FBG	<input type="checkbox"/>	<input type="checkbox"/>
HBA ₁ C	<input type="checkbox"/>	<input type="checkbox"/>

7.79 *High-risk*

	N	E
ECG	<input type="checkbox"/>	<input type="checkbox"/>
CXR	<input type="checkbox"/>	<input type="checkbox"/>
CBC	<input type="checkbox"/>	<input type="checkbox"/>
Renal Profile	<input type="checkbox"/>	<input type="checkbox"/>
Coagulation Screen	<input type="checkbox"/>	<input type="checkbox"/>
RBG	<input type="checkbox"/>	<input type="checkbox"/>
Liver Profile	<input type="checkbox"/>	<input type="checkbox"/>
Se. Albumin	<input type="checkbox"/>	<input type="checkbox"/>
Urinalysis	<input type="checkbox"/>	<input type="checkbox"/>
FBG	<input type="checkbox"/>	<input type="checkbox"/>
HBA ₁ C	<input type="checkbox"/>	<input type="checkbox"/>

7.80 Comments:

A patient suffering from diabetes mellitus treated with insulin undergoing this grade of surgery:

7.81 *Low-risk*

	N	E
ECG	<input type="checkbox"/>	<input type="checkbox"/>
CXR	<input type="checkbox"/>	<input type="checkbox"/>
CBC	<input type="checkbox"/>	<input type="checkbox"/>
Renal Profile	<input type="checkbox"/>	<input type="checkbox"/>
Coagulation Screen	<input type="checkbox"/>	<input type="checkbox"/>
RBG	<input type="checkbox"/>	<input type="checkbox"/>
Liver Profile	<input type="checkbox"/>	<input type="checkbox"/>
Se. Albumin	<input type="checkbox"/>	<input type="checkbox"/>
Urinalysis	<input type="checkbox"/>	<input type="checkbox"/>
FBG	<input type="checkbox"/>	<input type="checkbox"/>
HBA ₁ C	<input type="checkbox"/>	<input type="checkbox"/>

7.82 *Intermediate-risk*

	N	E
ECG	<input type="checkbox"/>	<input type="checkbox"/>
CXR	<input type="checkbox"/>	<input type="checkbox"/>
CBC	<input type="checkbox"/>	<input type="checkbox"/>
Renal Profile	<input type="checkbox"/>	<input type="checkbox"/>
Coagulation Screen	<input type="checkbox"/>	<input type="checkbox"/>
RBG	<input type="checkbox"/>	<input type="checkbox"/>
Liver Profile	<input type="checkbox"/>	<input type="checkbox"/>
Se. Albumin	<input type="checkbox"/>	<input type="checkbox"/>
Urinalysis	<input type="checkbox"/>	<input type="checkbox"/>
FBG	<input type="checkbox"/>	<input type="checkbox"/>
HBA ₁ C	<input type="checkbox"/>	<input type="checkbox"/>

7.83 *High-risk*

	N	E
ECG	<input type="checkbox"/>	<input type="checkbox"/>
CXR	<input type="checkbox"/>	<input type="checkbox"/>
CBC	<input type="checkbox"/>	<input type="checkbox"/>
Renal Profile	<input type="checkbox"/>	<input type="checkbox"/>
Coagulation Screen	<input type="checkbox"/>	<input type="checkbox"/>
RBG	<input type="checkbox"/>	<input type="checkbox"/>
Liver Profile	<input type="checkbox"/>	<input type="checkbox"/>
Se. Albumin	<input type="checkbox"/>	<input type="checkbox"/>
Urinalysis	<input type="checkbox"/>	<input type="checkbox"/>
FBG	<input type="checkbox"/>	<input type="checkbox"/>
HBA ₁ C	<input type="checkbox"/>	<input type="checkbox"/>

7.84 Comments:



Preoperative Assessment Practice Questionnaire

A patient suffering from **chronic renal failure** who is **treated conservatively** undergoing this grade of surgery:

7.85 *Low-risk*

	N	E
ECG	<input type="checkbox"/>	<input type="checkbox"/>
CXR	<input type="checkbox"/>	<input type="checkbox"/>
CBC	<input type="checkbox"/>	<input type="checkbox"/>
Renal Profile	<input type="checkbox"/>	<input type="checkbox"/>
Coagulation Screen	<input type="checkbox"/>	<input type="checkbox"/>
RBG	<input type="checkbox"/>	<input type="checkbox"/>
Liver Profile	<input type="checkbox"/>	<input type="checkbox"/>
Se. Albumin	<input type="checkbox"/>	<input type="checkbox"/>
Urinalysis	<input type="checkbox"/>	<input type="checkbox"/>

7.86 *Intermediate-risk*

	N	E
ECG	<input type="checkbox"/>	<input type="checkbox"/>
CXR	<input type="checkbox"/>	<input type="checkbox"/>
CBC	<input type="checkbox"/>	<input type="checkbox"/>
Renal Profile	<input type="checkbox"/>	<input type="checkbox"/>
Coagulation Screen	<input type="checkbox"/>	<input type="checkbox"/>
RBG	<input type="checkbox"/>	<input type="checkbox"/>
Liver Profile	<input type="checkbox"/>	<input type="checkbox"/>
Se. Albumin	<input type="checkbox"/>	<input type="checkbox"/>
Urinalysis	<input type="checkbox"/>	<input type="checkbox"/>

7.87 *High-risk*

	N	E
ECG	<input type="checkbox"/>	<input type="checkbox"/>
CXR	<input type="checkbox"/>	<input type="checkbox"/>
CBC	<input type="checkbox"/>	<input type="checkbox"/>
Renal Profile	<input type="checkbox"/>	<input type="checkbox"/>
Coagulation Screen	<input type="checkbox"/>	<input type="checkbox"/>
RBG	<input type="checkbox"/>	<input type="checkbox"/>
Liver Profile	<input type="checkbox"/>	<input type="checkbox"/>
Se. Albumin	<input type="checkbox"/>	<input type="checkbox"/>
Urinalysis	<input type="checkbox"/>	<input type="checkbox"/>

7.88 Comments:

A patient suffering from **chronic renal failure** who **requires dialysis** undergoing this grade of surgery:

7.89 *Low-risk*

	N	E
ECG	<input type="checkbox"/>	<input type="checkbox"/>
CXR	<input type="checkbox"/>	<input type="checkbox"/>
CBC	<input type="checkbox"/>	<input type="checkbox"/>
Renal Profile	<input type="checkbox"/>	<input type="checkbox"/>
Coagulation Screen	<input type="checkbox"/>	<input type="checkbox"/>
RBG	<input type="checkbox"/>	<input type="checkbox"/>
Liver Profile	<input type="checkbox"/>	<input type="checkbox"/>
Se. Albumin	<input type="checkbox"/>	<input type="checkbox"/>
Urinalysis	<input type="checkbox"/>	<input type="checkbox"/>

7.90 *Intermediate-risk*

	N	E
ECG	<input type="checkbox"/>	<input type="checkbox"/>
CXR	<input type="checkbox"/>	<input type="checkbox"/>
CBC	<input type="checkbox"/>	<input type="checkbox"/>
Renal Profile	<input type="checkbox"/>	<input type="checkbox"/>
Coagulation Screen	<input type="checkbox"/>	<input type="checkbox"/>
RBG	<input type="checkbox"/>	<input type="checkbox"/>
Liver Profile	<input type="checkbox"/>	<input type="checkbox"/>
Se. Albumin	<input type="checkbox"/>	<input type="checkbox"/>
Urinalysis	<input type="checkbox"/>	<input type="checkbox"/>

7.91 *High-risk*

	N	E
ECG	<input type="checkbox"/>	<input type="checkbox"/>
CXR	<input type="checkbox"/>	<input type="checkbox"/>
CBC	<input type="checkbox"/>	<input type="checkbox"/>
Renal Profile	<input type="checkbox"/>	<input type="checkbox"/>
Coagulation Screen	<input type="checkbox"/>	<input type="checkbox"/>
RBG	<input type="checkbox"/>	<input type="checkbox"/>
Liver Profile	<input type="checkbox"/>	<input type="checkbox"/>
Se. Albumin	<input type="checkbox"/>	<input type="checkbox"/>
Urinalysis	<input type="checkbox"/>	<input type="checkbox"/>

7.92 Comments:



Preoperative Assessment Practice Questionnaire

A patient with a history of a **cerebrovascular accident** undergoing this grade of surgery:

7.93 Low-risk

	N	E
ECG	<input type="checkbox"/>	<input type="checkbox"/>
CXR	<input type="checkbox"/>	<input type="checkbox"/>
CBC	<input type="checkbox"/>	<input type="checkbox"/>
Renal Profile	<input type="checkbox"/>	<input type="checkbox"/>
Coagulation Screen	<input type="checkbox"/>	<input type="checkbox"/>
RBG	<input type="checkbox"/>	<input type="checkbox"/>
Liver Profile	<input type="checkbox"/>	<input type="checkbox"/>
Se. Albumin	<input type="checkbox"/>	<input type="checkbox"/>
Urinalysis	<input type="checkbox"/>	<input type="checkbox"/>

7.94 Intermediate-risk

	N	E
ECG	<input type="checkbox"/>	<input type="checkbox"/>
CXR	<input type="checkbox"/>	<input type="checkbox"/>
CBC	<input type="checkbox"/>	<input type="checkbox"/>
Renal Profile	<input type="checkbox"/>	<input type="checkbox"/>
Coagulation Screen	<input type="checkbox"/>	<input type="checkbox"/>
RBG	<input type="checkbox"/>	<input type="checkbox"/>
Liver Profile	<input type="checkbox"/>	<input type="checkbox"/>
Se. Albumin	<input type="checkbox"/>	<input type="checkbox"/>
Urinalysis	<input type="checkbox"/>	<input type="checkbox"/>

7.95 High-risk

	N	E
ECG	<input type="checkbox"/>	<input type="checkbox"/>
CXR	<input type="checkbox"/>	<input type="checkbox"/>
CBC	<input type="checkbox"/>	<input type="checkbox"/>
Renal Profile	<input type="checkbox"/>	<input type="checkbox"/>
Coagulation Screen	<input type="checkbox"/>	<input type="checkbox"/>
RBG	<input type="checkbox"/>	<input type="checkbox"/>
Liver Profile	<input type="checkbox"/>	<input type="checkbox"/>
Se. Albumin	<input type="checkbox"/>	<input type="checkbox"/>
Urinalysis	<input type="checkbox"/>	<input type="checkbox"/>

7.96 Comments:

8 Medication

8.1 If a patient usually takes the following medications, indicate how you would **normally** manage these in the perioperative period.

	Withhold	Continue
Tricyclic Antidepressants	<input type="checkbox"/>	<input type="checkbox"/>
SSRIs	<input type="checkbox"/>	<input type="checkbox"/>
Benzodiazepines	<input type="checkbox"/>	<input type="checkbox"/>
Lithium	<input type="checkbox"/>	<input type="checkbox"/>
Beta blocker for IHD	<input type="checkbox"/>	<input type="checkbox"/>
Beta blocker for Hypertension	<input type="checkbox"/>	<input type="checkbox"/>
Beta blocker for arrhythmia	<input type="checkbox"/>	<input type="checkbox"/>
ACE Inhibitor for hypertension	<input type="checkbox"/>	<input type="checkbox"/>
ACE Inhibitor for congestive heart failure	<input type="checkbox"/>	<input type="checkbox"/>
ARBs (Sartans)	<input type="checkbox"/>	<input type="checkbox"/>
Statins	<input type="checkbox"/>	<input type="checkbox"/>
Diuretic for hypertension	<input type="checkbox"/>	<input type="checkbox"/>
Diuretic for congestive heart failure	<input type="checkbox"/>	<input type="checkbox"/>
Aspirin in patient with IHD	<input type="checkbox"/>	<input type="checkbox"/>
Aspirin in patient with a coronary stent	<input type="checkbox"/>	<input type="checkbox"/>
Calcium Channel Blocker	<input type="checkbox"/>	<input type="checkbox"/>

Comments:



Preoperative Assessment Practice Questionnaire

9 Timing of Preoperative Assessment

9.1 *Preoperative assessment and investigations are frequently performed some time before surgery. What time limit would you consider acceptable for each investigation, if the investigations were indicated in the case being considered and the patient has not had a change in clinical status in the interim?*

	48 hours	7 days	2 weeks	6 weeks	6 months	1 year	2 years
Health Status Questionnaire	<input type="checkbox"/>	<input type="checkbox"/>	<input type="checkbox"/>	<input type="checkbox"/>	<input type="checkbox"/>	<input type="checkbox"/>	<input type="checkbox"/>
Physical Examination	<input type="checkbox"/>	<input type="checkbox"/>	<input type="checkbox"/>	<input type="checkbox"/>	<input type="checkbox"/>	<input type="checkbox"/>	<input type="checkbox"/>
ECG	<input type="checkbox"/>	<input type="checkbox"/>	<input type="checkbox"/>	<input type="checkbox"/>	<input type="checkbox"/>	<input type="checkbox"/>	<input type="checkbox"/>
CXR	<input type="checkbox"/>	<input type="checkbox"/>	<input type="checkbox"/>	<input type="checkbox"/>	<input type="checkbox"/>	<input type="checkbox"/>	<input type="checkbox"/>
CBC	<input type="checkbox"/>	<input type="checkbox"/>	<input type="checkbox"/>	<input type="checkbox"/>	<input type="checkbox"/>	<input type="checkbox"/>	<input type="checkbox"/>
Renal Profile	<input type="checkbox"/>	<input type="checkbox"/>	<input type="checkbox"/>	<input type="checkbox"/>	<input type="checkbox"/>	<input type="checkbox"/>	<input type="checkbox"/>
Coagulation Screen	<input type="checkbox"/>	<input type="checkbox"/>	<input type="checkbox"/>	<input type="checkbox"/>	<input type="checkbox"/>	<input type="checkbox"/>	<input type="checkbox"/>
RBG	<input type="checkbox"/>	<input type="checkbox"/>	<input type="checkbox"/>	<input type="checkbox"/>	<input type="checkbox"/>	<input type="checkbox"/>	<input type="checkbox"/>
Liver Profile	<input type="checkbox"/>	<input type="checkbox"/>	<input type="checkbox"/>	<input type="checkbox"/>	<input type="checkbox"/>	<input type="checkbox"/>	<input type="checkbox"/>
Se. Albumin	<input type="checkbox"/>	<input type="checkbox"/>	<input type="checkbox"/>	<input type="checkbox"/>	<input type="checkbox"/>	<input type="checkbox"/>	<input type="checkbox"/>
Urinalysis	<input type="checkbox"/>	<input type="checkbox"/>	<input type="checkbox"/>	<input type="checkbox"/>	<input type="checkbox"/>	<input type="checkbox"/>	<input type="checkbox"/>
Non-invasive Stress Testing	<input type="checkbox"/>	<input type="checkbox"/>	<input type="checkbox"/>	<input type="checkbox"/>	<input type="checkbox"/>	<input type="checkbox"/>	<input type="checkbox"/>
Echocardiogram	<input type="checkbox"/>	<input type="checkbox"/>	<input type="checkbox"/>	<input type="checkbox"/>	<input type="checkbox"/>	<input type="checkbox"/>	<input type="checkbox"/>
Angiography	<input type="checkbox"/>	<input type="checkbox"/>	<input type="checkbox"/>	<input type="checkbox"/>	<input type="checkbox"/>	<input type="checkbox"/>	<input type="checkbox"/>
Spirometry	<input type="checkbox"/>	<input type="checkbox"/>	<input type="checkbox"/>	<input type="checkbox"/>	<input type="checkbox"/>	<input type="checkbox"/>	<input type="checkbox"/>
Arterial Blood Gases	<input type="checkbox"/>	<input type="checkbox"/>	<input type="checkbox"/>	<input type="checkbox"/>	<input type="checkbox"/>	<input type="checkbox"/>	<input type="checkbox"/>
Venous Blood Gases	<input type="checkbox"/>	<input type="checkbox"/>	<input type="checkbox"/>	<input type="checkbox"/>	<input type="checkbox"/>	<input type="checkbox"/>	<input type="checkbox"/>
Pulse Oximetry	<input type="checkbox"/>	<input type="checkbox"/>	<input type="checkbox"/>	<input type="checkbox"/>	<input type="checkbox"/>	<input type="checkbox"/>	<input type="checkbox"/>

Comments:

10 Other Comments

10.1 *Do you have any other comments regarding preoperative assessment?*

Thank you for taking the time to fill in this questionnaire.



1051833853 0020

Appendix B

Patient Satisfaction Questionnaire

B.1 English Version

The English version of the patient satisfaction questionnaire is reproduced below. The questionnaire was typeset using Scripts for Data Acquisition with Paper-based Surveys (SDAPS) software [167].

POAC Patient Satisfaction Questionnaire



Filling in this questionnaire will help to ensure that the Preoperative Assessment Clinic (POAC) is fulfilling its role, and help us identify areas which need improvement. We are grateful for your time in giving us your feedback.

Please mark the boxes as shown below. Use a black or blue ballpoint pen

To check box: To Uncheck/Correct:

1 Reception

1.1 What was the scheduled time of your appointment?

- | | |
|---|--------------------------------|
| <input type="checkbox"/> 07:30 | <input type="checkbox"/> 08:00 |
| <input type="checkbox"/> 08:30 | <input type="checkbox"/> 09:00 |
| <input type="checkbox"/> 09:30 | <input type="checkbox"/> 10:00 |
| <input type="checkbox"/> 10:30 | <input type="checkbox"/> 11:00 |
| <input type="checkbox"/> 11:30 | <input type="checkbox"/> 12:00 |
| <input type="checkbox"/> 12:30 | <input type="checkbox"/> 13:00 |
| <input type="checkbox"/> Later than 13:30 | |

1.2 Please rate the service you got at Reception:

Poor Good

2 Nurse

2.1 How long did you have to wait to see the nurse?

- Seen immediately
 Less than 5 minutes
 6 — 15 minutes
 16 — 30 minutes
 More than 30 minutes
 Don't know/ Can't remember

2.2 Did the nurse seem to know about your medical history?

- He/She knew enough
 He/She knew something, but not enough
 He/She knew little or nothing
 Don't know / Can't say

2.3 Were you able to discuss the things you wanted to with the nurse?

- Yes, definitely
 Yes, to some extent
 No

2.4 Did the nurse listen to what you had to say?

- Yes, definitely
 Yes, to some extent
 No

2.5 If you asked the nurse questions, did you get answers you could understand?

- Yes, definitely
 Yes, to some extent
 No
 I did not have any questions
 I did not have the opportunity to ask questions

2.6 Did you have confidence and trust in the nurse?

- Yes, definitely
 Yes, to some extent
 No

2.7 Please rate your visit with the nurse:

Poor Good

3 ECG

If you did not need an ECG, please go to Section 4.

3.1 How long did you have to wait for your ECG?

- Seen immediately
 Less than 5 minutes
 6 — 15 minutes
 16 — 30 minutes
 More than 30 minutes
 Don't know/ Can't remember

3.2 Please rate the service you got at the ECG Room:

Poor Good



757050630 0001

POAC Patient Satisfaction Questionnaire



4 Doctor

5 Anaesthetist

- 4.1 How long did you have to wait to see the doctor?
- Seen immediately
 Less than 5 minutes
 6 — 15 minutes
 16 — 30 minutes
 More than 30 minutes
 Don't know/ Can't remember
- 4.2 Did the doctor seem to know about your medical history?
- He/She knew enough
 He/She knew something, but not enough
 He/She knew little or nothing
 Don't know / Can't say
- 4.3 Were you able to discuss the things you wanted to with the doctor?
- Yes, definitely
 Yes, to some extent
 No
- 4.4 Did the doctor listen to what you had to say?
- Yes, definitely
 Yes, to some extent
 No
- 4.5 If you had asked the doctor questions, did you get answers you could understand?
- Yes, definitely
 Yes, to some extent
 No
 I did not have any questions
 I did not have the opportunity to ask questions
- 4.6 Did you have confidence and trust in the doctor?
- Yes, definitely
 Yes, to some extent
 No
- 4.7 Please rate your visit with the doctor:
- Poor Good
- 5.1 Did you see the anaesthetist?
- Yes
 No, I did not need to
 No, even though I wanted to
If you did not see the anaesthetist, please go to Section 6.
- 5.2 How long did you have to wait to see the anaesthetist?
- Seen immediately
 Less than 5 minutes
 6 — 15 minutes
 16 — 30 minutes
 More than 30 minutes
 Don't know/ Can't remember
- 5.3 Did the anaesthetist seem to know about your medical history?
- He/She knew enough
 He/She knew something, but not enough
 He/She knew little or nothing
 Don't know / Can't say
- 5.4 Were you able to discuss the things you wanted to with the anaesthetist?
- Yes, definitely
 Yes, to some extent
 No
- 5.5 Did the anaesthetist listen to what you had to say?
- Yes, definitely
 Yes, to some extent
 No
- 5.6 If you asked the anaesthetist questions, did you get answers you could understand?
- Yes, definitely
 Yes, to some extent
 No
 I did not have any questions
 I did not have the opportunity to ask questions



757050630 0002

POAC Patient Satisfaction Questionnaire



5.7 Did you have confidence and trust in the anaesthetist?

- Yes, definitely
- Yes, to some extent
- No

5.8 Please rate your visit with the anaesthetist:

Poor Good

6 Information

6.1 Before your appointment, did you know why you had to go to the POAC?

- Yes
- No

6.2 Before your appointment, did you know what would happen during your visit to the POAC?

- Yes
- No

6.3 During your visit to the POAC, did anyone explain the following:

	No	Nurse	Doctor	Anaesthetist	Don't Know
What anaesthesia involves	<input type="checkbox"/>	<input type="checkbox"/>	<input type="checkbox"/>	<input type="checkbox"/>	<input type="checkbox"/>
What your options for anaesthesia are	<input type="checkbox"/>	<input type="checkbox"/>	<input type="checkbox"/>	<input type="checkbox"/>	<input type="checkbox"/>
What to bring with you to for the operation	<input type="checkbox"/>	<input type="checkbox"/>	<input type="checkbox"/>	<input type="checkbox"/>	<input type="checkbox"/>
What happens when you arrive in the operating room	<input type="checkbox"/>	<input type="checkbox"/>	<input type="checkbox"/>	<input type="checkbox"/>	<input type="checkbox"/>
What the possible side-effects of anaesthesia are	<input type="checkbox"/>	<input type="checkbox"/>	<input type="checkbox"/>	<input type="checkbox"/>	<input type="checkbox"/>
How the pain will be controlled after the operation	<input type="checkbox"/>	<input type="checkbox"/>	<input type="checkbox"/>	<input type="checkbox"/>	<input type="checkbox"/>
Which medicines you should take prior to surgery	<input type="checkbox"/>	<input type="checkbox"/>	<input type="checkbox"/>	<input type="checkbox"/>	<input type="checkbox"/>
Which medicines you should discontinue prior to surgery	<input type="checkbox"/>	<input type="checkbox"/>	<input type="checkbox"/>	<input type="checkbox"/>	<input type="checkbox"/>
When you can last eat and drink prior to surgery	<input type="checkbox"/>	<input type="checkbox"/>	<input type="checkbox"/>	<input type="checkbox"/>	<input type="checkbox"/>

7 General

7.1 How would you rate the organization of the POAC?

Poor Good

7.2 Do you feel you were treated with respect and dignity while at the POAC?

- Yes, definitely
- Yes, to some extent
- No

7.3 Overall, how would you rate the care you received at the POAC?

Poor Good



757050630 0003

POAC Patient Satisfaction Questionnaire



8 Comments

8.1 Do you have any other comments?

Thank you for taking the time to fill in this questionnaire.



757050630 0004

B.2 Maltese Version

The Maltese version of the patient satisfaction questionnaire is reproduced below. The questionnaire was typeset using Scripts for Data Acquisition with Paper-based Surveys (SDAPS) software [167].

Kwestjonarju ta' Sodisfazzjon fil-POAC



Jekk timla dan il-kwestjonarju, tgħin biex naraw li l-'Preoperative Assessment Clinic' (POAC) qed jaqdi il-funzjoni tiegħu, u tgħinna naraw fejn hemm bżonn titjib. Napprezzaw il-kontribut tiegħek.

Jekk jogħġbok immarka il-kaxxa kif jidher hawn taħt. Uża pinna sewda jew blu.

Biex timmarka il-kaxxa: Biex tneħhi il-marka/Tikkoreġi:

1 Ir-Reception

1.1 Għal x'hin kien l-appuntament?

- | | |
|-------------------------------------|--------------------------------|
| <input type="checkbox"/> 07:30 | <input type="checkbox"/> 08:00 |
| <input type="checkbox"/> 08:30 | <input type="checkbox"/> 09:00 |
| <input type="checkbox"/> 09:30 | <input type="checkbox"/> 10:00 |
| <input type="checkbox"/> 10:30 | <input type="checkbox"/> 11:00 |
| <input type="checkbox"/> 11:30 | <input type="checkbox"/> 12:00 |
| <input type="checkbox"/> 12:30 | <input type="checkbox"/> 13:00 |
| <input type="checkbox"/> Wara 13:30 | |

1.2 Kif tqis is-servizz li ħadt mir-Reception?

Hażin Tajjeb

2 L-Infirmiera

2.1 Kemm domt tistenna biex tara l-infirmiera?

- Mal-ewwel
- Inqas minn 5 minuti
- Bejn 6 u 15-il minuta
- Bejn 16 u 30 minuta
- Iktar minn 30 minuta
- Ma nafx/Ma niftakarx

2.2 L-Infirmiera kienet taf dwar l-istorja medika tiegħek?

- Kienet taf biżżejjed
- Kienet taf xi haġa, imma mhux biżżejjed
- Kienet taf ftit jew xejn
- Ma nafx ngħid

2.3 Stajt tiddiskuti l-affarijiet li ridt mal-infirmiera?

- Iva
- Iva, sa ċertu punt
- Le

2.4 L-infirmiera qagħdet tisma' dak li kellek xi tgħid?

- Iva
- Iva, sa ċertu punt
- Le

2.5 Jekk staqsejt xi domandi lill-infirmiera, stajt tifhem ir-risposti li ħadt?

- Iva
- Iva, sa ċertu punt
- Le
- Ma kellek xi domandi
- Ma kellek xi domandi

2.6 Kellek fiduċja fl-infirmiera?

- Iva
- Iva, sa ċertu punt
- Le

2.7 Kif tqis il-vista mal-infirmiera?

Hażin Tajjeb

3 Ritratt tal-Qalb (ECG)

Jekk ma' kellekx bżonn ritratt tal-qalb, mur f' sezzjoni 4.

3.1 Kemm domt tistenna għar-ritratt tal-qalb?

- Mal-ewwel
- Inqas minn 5 minuti
- Bejn 6 u 15-il minuta
- Bejn 16 u 30 minuta
- Iktar minn 30 minuta
- Ma nafx/Ma niftakarx

3.2 Kif tqis is-servizz li ħadt biex għamilt tar-ritratt tal-qalb?

Hażin Tajjeb



2801299900 0001

Kwestjonarju ta' Sodisfazzjon fil-POAC**4 It-Tabib**

4.1 Kemm domt tistenna biex tara t-tabib?

- Mal-ewwel
 Inqas minn 5 minuti
 Bejn 6 u 15-il minuta
 Bejn 16 u 30 minuta
 Iktar minn 30 minuta
 Ma nafx/Ma niftakarx

4.2 It-tabib kien jaf dwar l-istorja medika tiegħek?

- Kien jaf biżżejjed
 Kien jaf xi haġa, imma mhux biżżejjed
 Kien jaf ftit jew xejn
 Ma nafx ngħid

4.3 Stajt tiddiskuti l-affarijiet li ridt mat-tabib?

- Iva
 Iva, sa ċertu punt
 Le

4.4 It-tabib qagħad jisma' dak li kellek xi tghid?

- Iva
 Iva, sa ċertu punt
 Le

4.5 Jekk staqsejt xi domandi lit-tabib, stajt tifhem ir-risposti li ħadt?

- Iva
 Iva, sa ċertu punt
 Le
 Ma kelli domandi
 Ma kelli ċans nistaqsi domandi

4.6 Kellek fiduċja fit-tabib?

- Iva
 Iva, sa ċertu punt
 Le

4.7 Kif tqis il-vista mat-tabib?

Hażin Tajjeb

5 L-Anestetista (Tabib tal-Loppju)

5.1 Kellek bżonn tara l-anestetista?

- Iva
 Le, ma kelli bżonn
 Le, għalkemm ridt inkellmu

Jekk ma rajtx l-anestetista, mur f' sezzjoni 6.

5.2 Kemm domt tistenna biex tara l-anestetista?

- Mal-ewwel
 Inqas minn 5 minuti
 Bejn 6 u 15-il minuta
 Bejn 16 u 30 minuta
 Iktar minn 30 minuta
 Ma nafx/Ma niftakarx

5.3 L-Anestetista kien jaf dwar l-istorja medika tiegħek?

- Kien jaf biżżejjed
 Kien jaf xi haġa, imma mhux biżżejjed
 Kien jaf ftit jew xejn
 Ma nafx ngħid

5.4 Kellek ċans tiddiskuti l-affarijiet li ridt mal-anestetista?

- Iva
 Iva, sa ċertu punt
 Le

5.5 L-Anestetista qagħad jisma' dak li kellek xi tghid?

- Iva
 Iva, sa ċertu punt
 Le

5.6 Jekk staqsejt xi domandi lill-anestetista, stajt tifhem ir-risposti li ħadt?

- Iva
 Iva, sa ċertu punt
 Le
 Ma kelli domandi
 Ma kelli ċans nistaqsi domandi

5.7 Kellek fiduċja fl-anestetista?

- Iva
 Iva, sa ċertu punt
 Le



2801299900 0002

Kwestjonarju ta' Sodisfazzjon fil-POAC

5.8 Kif tqis il-vista mal-anestetista?

Hażin Tajjeb**6 Informazzjoni**

6.1 Qabel ma ġejt, kont taf għaliex kellek bżonn tiġi l-POAC?

- Iva
 Le

6.2 Qabel ma ġejt, kont taf x'kien ser jiġri fil-POAC?

- Iva
 Le

6.3 Waqt li kont fil-POAC, xi hadd spjegalek fuq dawn l-affarijiet:

	Le	L-Infirmiera	It-Tabib	L-Anestetista	Ma Nafx
X' jinvolti l-loppju	<input type="checkbox"/>	<input type="checkbox"/>	<input type="checkbox"/>	<input type="checkbox"/>	<input type="checkbox"/>
X' għażliet tista tagħmel dwar il-loppju	<input type="checkbox"/>	<input type="checkbox"/>	<input type="checkbox"/>	<input type="checkbox"/>	<input type="checkbox"/>
X' għandek iġġib miegħek għall-operazzjoni	<input type="checkbox"/>	<input type="checkbox"/>	<input type="checkbox"/>	<input type="checkbox"/>	<input type="checkbox"/>
X' jiġri meta tasal fis-sala tal-operazzjoni	<input type="checkbox"/>	<input type="checkbox"/>	<input type="checkbox"/>	<input type="checkbox"/>	<input type="checkbox"/>
X' jistgħu jkunu l-effetti hżiena tal-loppju	<input type="checkbox"/>	<input type="checkbox"/>	<input type="checkbox"/>	<input type="checkbox"/>	<input type="checkbox"/>
Kif l-uġiegh jiġi kkontrollat wara l-operazzjoni	<input type="checkbox"/>	<input type="checkbox"/>	<input type="checkbox"/>	<input type="checkbox"/>	<input type="checkbox"/>
Liema mediċini għandek tkompli qabel l-operazzjoni	<input type="checkbox"/>	<input type="checkbox"/>	<input type="checkbox"/>	<input type="checkbox"/>	<input type="checkbox"/>
Liema mediċini għandek twaqqaf qabel l-operazzjoni	<input type="checkbox"/>	<input type="checkbox"/>	<input type="checkbox"/>	<input type="checkbox"/>	<input type="checkbox"/>
Meta l-aħħar li tista tiekol jew tixrob qabel l-operazzjoni	<input type="checkbox"/>	<input type="checkbox"/>	<input type="checkbox"/>	<input type="checkbox"/>	<input type="checkbox"/>

7 Ġenerali

7.1 Kif tqis l-organizzazzjoni tal-POAC?

Hażin Tajjeb

7.2 Thoss li ġejt itrattat b'rispett u dinjita waqt li kont fil-POAC?

- Iva
 Iva, sa ċertu punt
 Le

7.3 Kollox ma' kollox, kif tqis il-kura li ħadt mil-POAC?

Hażin Tajjeb

2801299900 0003

Kwestjonarju ta' Sodisfazzjon fil-POAC**8 Kummenti**

8.1 Ghandek xi kummenti oħra?

Grazzi tal-hin li hadt biex timla dan il-kwestjonarju



2801299900 0004

Appendix C

Questionnaire for Evaluation of the Preoperative Assessment

The questionnaire for the technical evaluation of the preoperative assessment is reproduced below. The questionnaire was typeset in L^AT_EX using Scripts for Data Acquisition with Paper-based Surveys (SDAPS) software [167].

Evaluation of Preoperative Assessment

An exercise is being undertaken to improve the quality of preoperative patient clerking. Please give feedback on any unsatisfactory preoperative clerking of your patients which you encounter. This will help identify problems which need to be addressed.

This questionnaire will be scanned electronically for data extraction.

Please mark the boxes as shown below, with a black or blue ballpoint pen

To check box: To Uncheck/Correct:

1 Case Details

1.1 Speciality:

- General Urology Vascular Cardiac Neuro Plastics
 Ophth ENT MaxFax Dental Ortho Gynae

Other:

1.2 Patient ASA Physiological Score

- 1 2 3 4 5

1.3 Timing of Procedure

- Elective/Scheduled Urgent/Emergency

1.4 Grade of Surgery

- Minor Intermediate Major Complex Major

1.5 Where was the preoperative assessment performed?

- POAC Ward Other

1.6 What clerking documentation was used?

- iSoft Other Proforma Freeform Clerking

1.7 Was the preoperative assessment and preparation of the patient **completely** satisfactory?

- Yes No

If you answered yes, you have completed the questionnaire.

If you answered no, please continue to Section 2

2 General

2.1 Was the preoperative clerking documented in the patient's notes?

- Yes Yes, but incomplete No

2.2 Were the preoperative investigation results present in the patient's notes?

- Yes Yes, but incomplete No

2.3 Was the timing of the preoperative assessment appropriate?

- Yes No, too long before surgery No, too close to surgery

Evaluation of Preoperative Assessment

2.4 Were you consulted about this patient before the day of surgery?

- Yes No, it was not necessary No, but should have been

3 Patient History & Comorbidities

3.1 Was the assessment and management of patient comorbidities satisfactory?

- Yes No

If you answered yes, please continue to Section 4

If you answered no, please answer the remaining questions in this section.

3.2 Which of these conditions was **inadequately** assessed or managed?

Cardiovascular

- | | | |
|--|--|---|
| <input type="checkbox"/> Hypertension | <input type="checkbox"/> Ischaemic Heart Disease | <input type="checkbox"/> Congestive Heart Failure |
| <input type="checkbox"/> Arrhythmia | <input type="checkbox"/> Valvular Heart Disease | <input type="checkbox"/> Pacemaker |
| <input type="checkbox"/> Implanted Defibrillator | <input type="checkbox"/> Coronary Stents | <input type="checkbox"/> Other CVS disease |

Respiratory

- | | | |
|--|-------------------------------|---|
| <input type="checkbox"/> Asthma | <input type="checkbox"/> COPD | <input type="checkbox"/> Obstructive Sleep Apnoea |
| <input type="checkbox"/> Other Respiratory Disease | | |

Airway Assessment

- | | | |
|---|---|--|
| <input type="checkbox"/> Difficult Airway | <input type="checkbox"/> Difficult Intubation | <input type="checkbox"/> Dental Problems |
|---|---|--|

GI

- | | |
|---|---|
| <input type="checkbox"/> Gastric Reflux | <input type="checkbox"/> Peptic Ulcer Disease |
|---|---|

Misc

- | | | |
|--|---|---|
| <input type="checkbox"/> Renal Failure | <input type="checkbox"/> Hepatic Disease | <input type="checkbox"/> Anaemia |
| <input type="checkbox"/> Diabetes Mellitus | <input type="checkbox"/> Thyroid Disorder | <input type="checkbox"/> Neurological Condition |

Other

3.3 What were the main issues (mark all relevant)?

- Known condition not documented
- Inadequate Systemic Enquiry
- Inadequate Physical Examination
- Severity underestimated
- Inadequately Investigated
- POAC Anaesthetist not consulted
- Other Specialist not consulted
- Not optimised

Other:



3446460251 0002

Evaluation of Preoperative Assessment

3.4 How important was this error or omission?

Unimportant Very Important

4 Investigations

4.1 Was the preoperative workup (blood or other special investigations) satisfactory?

Yes No

If you answered yes, please continue to Section 5.

If you answered no, please answer the remaining questions in this section.

4.2 What were the main issues (mark all appropriate)?

	Not Requested	Not Performed	Results not Available	Not Followed Up
CBC	<input type="checkbox"/>	<input type="checkbox"/>	<input type="checkbox"/>	<input type="checkbox"/>
Electrolytes	<input type="checkbox"/>	<input type="checkbox"/>	<input type="checkbox"/>	<input type="checkbox"/>
Renal Profile	<input type="checkbox"/>	<input type="checkbox"/>	<input type="checkbox"/>	<input type="checkbox"/>
Blood Glucose	<input type="checkbox"/>	<input type="checkbox"/>	<input type="checkbox"/>	<input type="checkbox"/>
HBA ₁ C	<input type="checkbox"/>	<input type="checkbox"/>	<input type="checkbox"/>	<input type="checkbox"/>
Coagulation Screen	<input type="checkbox"/>	<input type="checkbox"/>	<input type="checkbox"/>	<input type="checkbox"/>
Liver Profile	<input type="checkbox"/>	<input type="checkbox"/>	<input type="checkbox"/>	<input type="checkbox"/>
Arterial Blood Gases	<input type="checkbox"/>	<input type="checkbox"/>	<input type="checkbox"/>	<input type="checkbox"/>
ECG	<input type="checkbox"/>	<input type="checkbox"/>	<input type="checkbox"/>	<input type="checkbox"/>
Stress ECG	<input type="checkbox"/>	<input type="checkbox"/>	<input type="checkbox"/>	<input type="checkbox"/>
Echocardiogram	<input type="checkbox"/>	<input type="checkbox"/>	<input type="checkbox"/>	<input type="checkbox"/>
CXR	<input type="checkbox"/>	<input type="checkbox"/>	<input type="checkbox"/>	<input type="checkbox"/>
Spirometry	<input type="checkbox"/>	<input type="checkbox"/>	<input type="checkbox"/>	<input type="checkbox"/>
Type & Screen	<input type="checkbox"/>	<input type="checkbox"/>	<input type="checkbox"/>	<input type="checkbox"/>

Other

4.3 How important was this error or omission?

Unimportant Very Important

5 Drug History and Management

5.1 Was the documentation and perioperative management of the patient's medication satisfactory?

Yes No

If you answered yes, please continue to Section 6

If you answered no, please answer the remaining questions in this section.

5.2 Did the patient have a drug allergy?

- No, correctly documented
- No, but incorrectly documented as having a history of allergy
- Yes, correctly documented
- Yes, but not documented
- Yes, but documented as 'No Allergies'
- Allergy status not documented

Evaluation of Preoperative Assessment

5.3 Was the perioperative management of the patient's regular medications satisfactory?

- Yes No

If you answered yes, please continue to Section 5.5

If you answered no, please answer the remaining questions in this section.

5.4 What were the issues with the perioperative management of the patient's regular medications (mark all appropriate)?

	Not Documented	Inappropriately Stopped	Inappropriately Continued
Psychotropics	<input type="checkbox"/>	<input type="checkbox"/>	<input type="checkbox"/>
Beta blockers	<input type="checkbox"/>	<input type="checkbox"/>	<input type="checkbox"/>
ACE Inhibitor	<input type="checkbox"/>	<input type="checkbox"/>	<input type="checkbox"/>
ARBs (Sartans)	<input type="checkbox"/>	<input type="checkbox"/>	<input type="checkbox"/>
Statins	<input type="checkbox"/>	<input type="checkbox"/>	<input type="checkbox"/>
Diuretic	<input type="checkbox"/>	<input type="checkbox"/>	<input type="checkbox"/>
Ca ⁺⁺ Blocker	<input type="checkbox"/>	<input type="checkbox"/>	<input type="checkbox"/>
Aspirin	<input type="checkbox"/>	<input type="checkbox"/>	<input type="checkbox"/>
Antiplatelet Drugs	<input type="checkbox"/>	<input type="checkbox"/>	<input type="checkbox"/>
Warfarin	<input type="checkbox"/>	<input type="checkbox"/>	<input type="checkbox"/>
OHAs	<input type="checkbox"/>	<input type="checkbox"/>	<input type="checkbox"/>
Insulin	<input type="checkbox"/>	<input type="checkbox"/>	<input type="checkbox"/>

Other

5.5 How important was this error or omission?

- Unimportant Very Important

6 Adverse Outcomes

6.1 Was there a delay in surgery related to inadequacies in the preoperative assessment?

- No
 Postponed to later in the list
 Rescheduled to another day

Other:

6.2 If surgery went ahead, were there any clinical sequelae for the patient in the perioperative period?

- No
 Minor event, (Self-limiting or successfully treated peroperatively with no other sequelae)
 Major event (life threatening or could lead to permanent disability)

If the patient had no, or only minor complications, please go to Section 7



3446460251 0004

Evaluation of Preoperative Assessment

6.3 If the patient experienced a **major** event, what impact did this have on postoperative care

- Normal postoperative management
- Prolonged stay in Recovery Room
- Prolonged Hospital Stay
- Unplanned ICU Admission

Other:

6.4 What were the *long term* sequelae for the patient

- No long-term sequelae
- Surgery abandoned
- Long-term minor disability expected
- Long-term major disability expected
- Patient died

Other:

6.5 Do you consider that the complications described were a consequence of inadequate preoperative assessment or management?

Very Unlikely Very Likely

7 Comments

7.1 Comments:

Evaluation of Preoperative Assessment
Thank you.



3446460251 0006

Appendix D

Cognitive Aids

The final design for the proposed cognitive aids are given below. In the annotated style, the human body diagram is reproduced under royalty-free license for educational and research purposes.

The copyright is held by:

Male Body Image Naveen Kalwa © 123RF.com

Female Body Image Sebastian Kaulitzki © 123RF.com

Figure D.1: Cognitive Aid Grid Layout — Male

Name: _____ Age: _____ ID: _____		Date: _____	
Procedure	ALERTS	Rx	General/ASA
CVS	Respiratory	Airway	GIT
Hepatic	Renal	Endocrine	Metabolic
Neuro/Psych	Musculoskel	Haematology	
		Investigations	PENDING

KEY	
■	NAD
■	Low Risk
■	Medium Risk
■	High Risk

Doctor:	
Reg. No:	
Signature:	

Figure D.2: Cognitive Aid Grid Layout — Female

Name: _____ Age: _____ ID: _____		Date: _____	
Procedure	ALERTS	Rx	General/ASA
CVS	Respiratory	Airway	GIT
Hepatic	Renal	Endocrine	Metabolic
Neuro/Psych	Musculoskel	Haematology	Gynae
		Investigations	PENDING

KEY	Doctor: _____
NAD	Reg. No: _____
Low Risk	Signature: _____
Medium Risk	
High Risk	

Figure D.3: Annotated Diagram Style Display — Male

Name: _____ Age: _____ ID: _____		Date: _____		
Procedure	ALERTS	General/ASA	Rx	Investigations
Musculoskel	Neuro/Psych			Airway
		CVS	Respiratory	
Hepatic	Endocrine		GIT	Haematology
	Metabolic	Renal		
			PENDING	

KEY	
	NAD
	Low Risk
	Medium Risk
	High Risk

Doctor: _____

Reg. No: _____

Signature: _____

Sebastian Kaulitzki
(c) 123RF.COM

Figure D.4: Annotated Diagram Style Display — Female

Name: _____ Age: _____ ID: _____		Date: _____												
Procedure	ALERTS	General/ASA	Rx	Investigations										
Musculoskel	Neuro/Psych			Haematology										
		CVS	Respiratory											
		Hepatic	GIT											
Metabolic	Renal	Gynae	Endocrine	PENDING										
<table border="1" style="width: 100%; border-collapse: collapse;"> <tr> <th colspan="2" style="text-align: center;">KEY</th> </tr> <tr> <td style="width: 15px; height: 15px; background-color: green;"></td> <td>NAD</td> </tr> <tr> <td style="width: 15px; height: 15px; background-color: yellow;"></td> <td>Low Risk</td> </tr> <tr> <td style="width: 15px; height: 15px; background-color: orange;"></td> <td>Medium Risk</td> </tr> <tr> <td style="width: 15px; height: 15px; background-color: red;"></td> <td>High Risk</td> </tr> </table>		KEY			NAD		Low Risk		Medium Risk		High Risk	Doctor: _____ Reg. No: _____ Signature: _____		
KEY														
	NAD													
	Low Risk													
	Medium Risk													
	High Risk													

Appendix E

Situation Awareness: Case Scenarios and Questions

The case scenarios used in the Situational Awareness Study are given over-leaf, together with the associated Annotated and Grid cognitive aids, and the questions for each scenario.

Case 1

PREOPERATIVE CLERKING NURSE ASSESSMENT	
Name: XXXX XXXX (male)	Date: Recent Date
Age: 68 yrs	ID: 999999T

POAC Nurse Assessment

Planned Procedure: Right femoropopliteal bypass graft

Comorbidities: Ischaemic Heart Disease, Hypertension, Diabetes Mellitus, Chronic Renal Failure

Drug History: Atenolol 50mg dly, Amlodipine 10mg dly, Gliclazide 80mg tds, Aspirin 75mg dly

No known drug allergies

Family History: Father died MI 72 ys of age. Mother diabetic. Sibs – DM, HT

Prev Surgery: Coronary stents x3 - 4 years ago

Parameters

Height (cm): 175cm

Weight (cm): 95 kg

BMI: 36

Systolic BP (mmHg): 160

Diastolic BP (mmHg): 95

Heart Rate (per min): 56 bpm

Airway Assessment

Limitation of neck movement? no

Hoarseness? no

Swallowing Difficulty? no

Laryngoscopy grade: not known

Bridges/Crowns/Implants/Loose teeth? no

*Mallampati Score: III

Mouth opening (cm): 3

Thyromental Distance (cm): 4cm

*Beard? YES

Education

Information leaflet discussed with patient.

Case 1

PREOPERATIVE CLERKING FY ASSESSMENT	
Name: XXXX XXXX (male)	Date: Recent Date
Age: 68 yrs	ID: 999999T

POAC FY Assessment

Planned Procedure: Right femoropopliteal bypass graft

Proposed Surgery Date: 30th November, 2018

Proposed Admission Date: 29th November 2018

Ward: Admission lounge →

Cardiovascular

*Do you suffer from CHEST PAIN? YES. On moderate exertion

*Do you suffer from HYPERTENSION? YES. Controlled

Have you ever had a heart attack? no

Do you have a heart murmur? no

Do you have any other heart condition? no

Do you have a pacemaker? no

*Has issues climbing two flights of stairs? YES. Sometimes gets chest pain

Respiratory

Do you suffer from asthma? no

Do you suffer from cough? no

Do you bring up sputum/suffer from COPD? No

Any Snoring/Tiredness related issues? No

Gastro/Renal

Do you suffer from heartburn/reflux? no

Have you ever had jaundice/liver issues? No

*Do you suffer from KIDNEY DISEASE? YES. Moderate CRF. EGFR 45ml/min

Neurological/Musculoskeletal

Do you suffer from epilepsy? no

Any blackouts/faints/unconsciousness? no

Have you ever had a stroke? no

Any diseases affecting the nerves? no

*Do you have any NECK OR SPINAL ISSUES? YES. Arthritic changes c/spine

Endocrine

*Do you suffer from DIABETES? YES. Controlled with OHAs

Do you suffer from thyroid disease? No

Haematological

Do you suffer from anaemia? no

Any bleeding or excessive bruising? no

Do you suffer from clotting disorders? no

Case 1

Do you ever get PE or DVT? no
 Issues with previous blood transfusions? No

Social

Do you live alone? no
 Do you drink alcohol? Social
 How many cigarettes do you smoke daily? Approx 10
 Ever taken any recreational drugs? no
 Can you be pregnant? No
 What is your occupation? Retired

Anaesthetic History

Any relatives with anaesthesia issues? No
 Any issues with previous anaesthetics? No
 *Problems with taking NSAIDS in the past? YES. Advised to avoid due to CRF

Post Operative Nausea and Vomiting Risk

Female? No
 Smoker? YES
 Prev Postop Nausea/Vomiting/Motion Sickness? No
 *INTERMEDIATE/MAJOR SURGERY? YES (1 point)
 Apfel score: 1

ECG

Sinus Rhythm. Rate 60/min. Voltage criteria for LVH. ST-T V4-6

CXR

No abnormality

Physical Examination

General appearance of concern? No

Cardiovascular Examination

Heart rate and rhythm? Normal regular
 JVP raised? No
 Cyanosis? No
 Heart sounds: S1+S2+0
 Lower limb oedema: no
 Peripheral pulses: Rt. LL pulses impalpable below femoral

Respiratory Examination

Any chest deformity: no
 Chest auscultation: clear

Surgical Site examinations

Surgical site examination findings: Pulses as detailed. Otherwise NAD

Preparation for Surgery

*ASA: 3

Case 1

Discussed with Anaesthetist: Case not discussed

OK to proceed: Yes

*Pending SPECIAL INVESTIGATIONS: YES - echocardiogram

Pending referrals (cardiology, other): no

*Medications to **OMIT** before surgery: Gliclazide

Admission: Admit day before surgery.

Diabetic regime from 10pm

Lab. Investigations

Hb: 14g%

WBC: 8,000 /uL

Pt: 220,000 /uL

Na+: 138 mEq/L

K+: 4.2 mEq/L

Cl-: 104 mEq/L

Creatinine: 150 umol/L

eGFR: 40 ml/min/1.73m²

RBG: 7.4 mmol/L

HbA1C: 6.8%

Case 1 Annotated Aid

Name: XXXX XXXX
 Age: 68 yrs
 ID: 999999T

Date: Recent Date

Procedure	ALERTS	General/ASA	Rx	Investigations																				
<table border="1"> <tr><td style="background-color: green;"> </td></tr> <tr><td style="background-color: yellow;"> </td></tr> <tr><td style="background-color: orange;">X</td></tr> <tr><td style="background-color: red;"> </td></tr> </table> Right Femoro-Popliteal Bypass Graft			X		<table border="1"> <tr><td style="background-color: green;">X</td></tr> <tr><td style="background-color: yellow;"> </td></tr> <tr><td style="background-color: orange;"> </td></tr> <tr><td style="background-color: red;"> </td></tr> </table>	X				<table border="1"> <tr><td style="background-color: green;"> </td></tr> <tr><td style="background-color: yellow;"> </td></tr> <tr><td style="background-color: orange;">X</td></tr> <tr><td style="background-color: red;"> </td></tr> </table> ASA: 3 BMI: 36			X		<table border="1"> <tr><td style="background-color: green;"> </td></tr> <tr><td style="background-color: yellow;">X</td></tr> <tr><td style="background-color: orange;"> </td></tr> <tr><td style="background-color: red;"> </td></tr> </table> Atenolol Amlodipine Gliclazide Aspirin NKDA		X			<table border="1"> <tr><td style="background-color: green;"> </td></tr> <tr><td style="background-color: yellow;">X</td></tr> <tr><td style="background-color: orange;"> </td></tr> <tr><td style="background-color: red;"> </td></tr> </table> ECG: SR: 60/min LVH ST-T: V4-6		X		
X																								
X																								
X																								
X																								
X																								

Musculoskel	Neuro/Psych	Airway	Haematology																
<table border="1"> <tr><td style="background-color: green;"> </td></tr> <tr><td style="background-color: yellow;">X</td></tr> <tr><td style="background-color: orange;"> </td></tr> <tr><td style="background-color: red;"> </td></tr> </table> C/Spine Arthritic changes		X			<table border="1"> <tr><td style="background-color: green;">X</td></tr> <tr><td style="background-color: yellow;"> </td></tr> <tr><td style="background-color: orange;"> </td></tr> <tr><td style="background-color: red;"> </td></tr> </table>	X				<table border="1"> <tr><td style="background-color: green;"> </td></tr> <tr><td style="background-color: yellow;"> </td></tr> <tr><td style="background-color: orange;">X</td></tr> <tr><td style="background-color: red;"> </td></tr> </table> -Mallampati 3 -Mouth opening: 3cm -Thyromental distance: 4cm -Beard.			X		<table border="1"> <tr><td style="background-color: green;">X</td></tr> <tr><td style="background-color: yellow;"> </td></tr> <tr><td style="background-color: orange;"> </td></tr> <tr><td style="background-color: red;"> </td></tr> </table> Hb: 14g% WBC: 8,000 Plt: 220	X			
X																			
X																			
X																			
X																			

CVS	Respiratory								
<table border="1"> <tr><td style="background-color: green;"> </td></tr> <tr><td style="background-color: yellow;"> </td></tr> <tr><td style="background-color: orange;">X</td></tr> <tr><td style="background-color: red;"> </td></tr> </table> BP [^] - 160/95 IHD - stents x 3 4 yrs ago Angina on mod. exertn.			X		<table border="1"> <tr><td style="background-color: green;"> </td></tr> <tr><td style="background-color: yellow;">X</td></tr> <tr><td style="background-color: orange;"> </td></tr> <tr><td style="background-color: red;"> </td></tr> </table> Smokes 10/day		X		
X									
X									
Hepatic	GIT								
<table border="1"> <tr><td style="background-color: green;">X</td></tr> <tr><td style="background-color: yellow;"> </td></tr> <tr><td style="background-color: orange;"> </td></tr> <tr><td style="background-color: red;"> </td></tr> </table>	X				<table border="1"> <tr><td style="background-color: green;">X</td></tr> <tr><td style="background-color: yellow;"> </td></tr> <tr><td style="background-color: orange;"> </td></tr> <tr><td style="background-color: red;"> </td></tr> </table>	X			
X									
X									

Metabolic	Renal	Endocrine	PENDING																
<table border="1"> <tr><td style="background-color: green;"> </td></tr> <tr><td style="background-color: yellow;">X</td></tr> <tr><td style="background-color: orange;"> </td></tr> <tr><td style="background-color: red;"> </td></tr> </table> DM - OHA RBG: 7.4 mmol/L HbA1C: 6.8%		X			<table border="1"> <tr><td style="background-color: green;"> </td></tr> <tr><td style="background-color: yellow;"> </td></tr> <tr><td style="background-color: orange;">X</td></tr> <tr><td style="background-color: red;"> </td></tr> </table> CRF Creat: 150umol/l EGRF: 45 ml/min Elect: WNL			X		<table border="1"> <tr><td style="background-color: green;"> </td></tr> <tr><td style="background-color: yellow;">X</td></tr> <tr><td style="background-color: orange;"> </td></tr> <tr><td style="background-color: red;"> </td></tr> </table> DM - OHA		X			<table border="1"> <tr><td style="background-color: green;"> </td></tr> <tr><td style="background-color: yellow;"> </td></tr> <tr><td style="background-color: orange;">X</td></tr> <tr><td style="background-color: red;"> </td></tr> </table> Echo: Pending HGT: On Admissn			X	
X																			
X																			
X																			
X																			

KEY	
	NAD
	Low Risk
	Medium Risk
	High Risk

Doctor: Dr. ZZZZ ZZZZ

Reg. No: 9999

















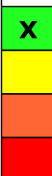

Signature: *Signed*



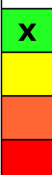

Sebastian Kaulitzki
 (c) 123RF.COM

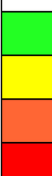
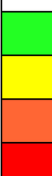
Case 1 Grid Aid

Name: XXXX XXXX (Male)
Age: 68 yrs
ID: 999999T

Date: Assume Recent Date

<p>Procedure</p> 	<p>ALERTS</p> 	<p>Rx</p> <p>Atenolol Amlodipine Gliclazide Aspirin</p> <p>NKDA</p> 	<p>General/ASA</p> <p>ASA: 3 BMI: 36</p> 
<p>CVS</p> <p>BP^ - 160/95 IHD - stents x 3 4 yrs ago Angina on mod. exertn.</p> 	<p>RS</p> <p>Smokes 10/day</p> 	<p>Airway</p> <p>-Mallampati 3 -Mouth opening: 3cm -Thyromental distance: 4cm -Beard.</p> 	<p>GIT</p> 
<p>Hepatic</p> 	<p>Renal</p> <p>CRF Creat: 150 umol/l EGFR: 45 ml/min Elect: WNL</p> 	<p>Endocrine</p> <p>DM - OHA</p> 	<p>Metabolic</p> <p>DM - OHA RBG: 7.4 mmlo/L HbA1C: 6.8%</p> 
<p>Neuro/ψ</p> 	<p>MSK</p> <p>C/Spine Arthritic Changes</p> 	<p>Haematology</p> <p>Hb: 14g% WBC: 8,000 Pit: 220</p> 	
		<p>Investigations</p> <p>ECG: SR: 60/min LVH ST-T: V4-6</p> 	<p>PENDING</p> <p>Echo: Pending HGT: On Admissn</p> 

KEY	
	NAD
	Low Risk
	Medium Risk
	High Risk

Doctor: Dr. ZZZZ ZZZZ

Reg. No: 9999

Signature: 

Case 1 Question Bank

Give a True/False answer:

1. Do you agree with the assigned ASA classification?
2. The patient is an insulin-dependent diabetic.
3. The patient has very poor diabetic control.
4. The patient had coronary artery stenting four years ago.
5. The patient has had no angina episodes since undergoing coronary artery stenting.
6. The patient has a history of CVA.
7. This patient stopped smoking three years ago.
8. The patient is allergic to penicillin.
9. There are no pending preoperative investigations.
10. Bag-mask ventilation is likely to be difficult.
11. There are indications that endotracheal intubation may be difficult.
12. Nonsteroidal anti-inflammatory agents (NSAIDs) are contraindicated in this patient.

Case 2

PREOPERATIVE CLERKING NURSE ASSESSMENT

Name: YYYY YYYY (female)

Date: Recent Date

Age: 76 yrs

ID: 888888T

POAC Nurse Assessment

Planned Procedure: Revision Right Total Hip Replacement

Comorbidities: Atrial Fibrillation, Aortic Stenosis, Hypothyroidism, CVA 3 years ago, Upper GI bleed due to NSAIDs 5 years ago.

Echocardiogram: Aortic stenosis – gradient 60mmHg. Hypertrophic left ventricle. EF~55%

Drug History: Digoxin 0.25 mg/dy, Warfarin acc to INR, thyroxine 50mcg/dy
ALLERGIC TO PENICILLIN. INTOLERANT TO NSAIDS

Family History: Nil relevant

Prev Surgery: Right THR 10 years ago

Parameters

Height (cm): 160cm

Weight (cm): 72 kg

BMI: 28

Systolic BP (mmHg): 120

Diastolic BP (mmHg): 85

Heart Rate (per min): 83 bpm irregular

Airway Assessment

Limitation of neck movement? no

Hoarseness? no

Swallowing Difficulty? no

Laryngoscopy grade: not known

Bridges/Crowns/Implants/Loose teeth? edentulous

Mallampati Score: I

Mouth opening (cm): 6

Thyromental Distance (cm): 5cm

Beard? no

Education

Information leaflet discussed with patient.

Case 2

PREOPERATIVE CLERKING FY ASSESSMENT	
Name: YYYY YYYY(female)	Date: Recent Date
Age: 76 yrs	ID: 888888T

POAC FY Assessment

Planned Procedure: Revision Right Total Hip Replacement

Proposed Surgery Date: 30th November, 2018

Proposed Admission Date: 29th November 2018

Ward: Ortho 2

Cardiovascular

Do you suffer from CHEST PAIN? YES. Occasionally

Do you suffer from hypertension? no

Have you ever had a heart attack? no

*Do you have a HEART MURMUR? YES

*Do you have any OTHER HEART CONDITION? YES – ATRIAL FIBRILLATION

Do you have a pacemaker?no

*Has issues climbing two flights of stairs? YES. Limited by hip pain

Respiratory

Do you suffer from asthma? no

Do you suffer from cough? no

Do you bring up sputum/suffer from COPD? no

Any Snoring/Tiredness related issues? no

Gastro/Renal

*Do you suffer from HEARTBURN/REFLUX? YES. Severe reflux on lying down

Have you ever had jaundice/liver issues? no

Do you suffer from kidney disease? no

Neurological/Musculoskeletal

Do you suffer from epilepsy? no

Any blackouts/faints/unconsciousness? no

*Have you ever had a STROKE? YES. Slight residual weakness left UL

Any diseases affecting the nerves? no

Do you have any neck or spinal issues? no

Endocrine

Do you suffer from diabetes? no

*Do you suffer from THYROID DISEASE? YES. Hypothyroid on treatment

Haematological

Do you suffer from anaemia? no

Any bleeding or excessive bruising? no

*Do you suffer from CLOTTING DISORDERS? YES – On Warfarin

Case 2

Do you ever get PE or DVT? no

*Issues with previous blood transfusions? YES. O negative, difficult crossmatch due to atypical antibodies

Social

Do you live alone? no

Do you drink alcohol? Social

How many cigarettes do you smoke daily? none

Ever taken any recreational drugs? no

Can you be pregnant? No

What is your occupation? housewife

Anaesthetic History

Any relatives with anaesthesia issues? No

Any issues with previous anaesthetics? No

*Problems with taking NSAIDS in the past? YES. H/O haemorrhagic gastritis

Post Operative Nausea and Vomiting Risk

Female? YES (1pt)

Smoker? No (1pt)

Prev Postop Nausea/Vomiting/Motion Sickness? No

*INTERMEDIATE/MAJOR SURGERY? YES (1 point)

Apfel score: 3

ECG

Rate 78/min. AF. Voltage criteria for LVH

CXR

No abnormality

Physical Examination

General appearance of concern? No

Cardiovascular Examination

Heart rate and rhythm? 75 irreg. irreg

JVP raised? No

Cyanosis? No

Heart sounds: S1+S2+3/6 ESM

Lower limb oedema: no

Peripheral pulses: palpable

Respiratory Examination

Any chest deformity: no

Chest auscultation: clear

Surgical Site examinations

Surgical site examination findings: NAD

Preparation for Surgery

*ASA: 3

Case 2

Discussed with Anaesthetist: Pending discussion

*OK to proceed: NO

*Pending Special Investigations: INR on admission

Pending referrals (cardiology, other): no

*Medications to **OMIT** before surgery: WARFARIN – as advised by physicians

Admission: Admit day before surgery.

Lab. Investigations

Hb: 12g%

WBC: 7,300 /uL

Plt: 175,000 /uL

Na+: 140 mEq/L

K+: 4.7 mEq/L

Cl-: 100mEq/L

Creatinine: 74 umol/L

eGFR: 68 ml/min/1.73m²

RBG: 5.4 mmol/L

Case 2 Annotated Aid

Name: YYYY YYYY (female)

Age: 76 Yrs

ID: 888888T

Date: Recent Date

Procedure	ALERTS	General/ASA	Rx	Investigations																																								
<table border="1"> <tr><td>Green</td><td>Right Revision</td></tr> <tr><td>Yellow</td><td>Total Hip Replacement</td></tr> <tr><td>Orange</td><td>X</td></tr> <tr><td>Red</td><td></td></tr> </table>	Green	Right Revision	Yellow	Total Hip Replacement	Orange	X	Red		<table border="1"> <tr><td>Green</td><td>ALLERGIC TO PENICILLIN</td></tr> <tr><td>Yellow</td><td></td></tr> <tr><td>Orange</td><td>X AVOID NSAIDS</td></tr> <tr><td>Red</td><td></td></tr> </table>	Green	ALLERGIC TO PENICILLIN	Yellow		Orange	X AVOID NSAIDS	Red		<table border="1"> <tr><td>Green</td><td>ASA: 3</td></tr> <tr><td>Yellow</td><td>BMI: 28</td></tr> <tr><td>Orange</td><td>X</td></tr> <tr><td>Red</td><td></td></tr> </table>	Green	ASA: 3	Yellow	BMI: 28	Orange	X	Red		<table border="1"> <tr><td>Green</td><td>Digoxin</td></tr> <tr><td>Yellow</td><td>Thyroxine</td></tr> <tr><td>Orange</td><td>Warfarin-</td></tr> <tr><td>Red</td><td>X to withhold</td></tr> </table>	Green	Digoxin	Yellow	Thyroxine	Orange	Warfarin-	Red	X to withhold	<table border="1"> <tr><td>Green</td><td>Echo:</td></tr> <tr><td>Yellow</td><td>See CVS</td></tr> <tr><td>Orange</td><td>X</td></tr> <tr><td>Red</td><td></td></tr> </table>	Green	Echo:	Yellow	See CVS	Orange	X	Red	
Green	Right Revision																																											
Yellow	Total Hip Replacement																																											
Orange	X																																											
Red																																												
Green	ALLERGIC TO PENICILLIN																																											
Yellow																																												
Orange	X AVOID NSAIDS																																											
Red																																												
Green	ASA: 3																																											
Yellow	BMI: 28																																											
Orange	X																																											
Red																																												
Green	Digoxin																																											
Yellow	Thyroxine																																											
Orange	Warfarin-																																											
Red	X to withhold																																											
Green	Echo:																																											
Yellow	See CVS																																											
Orange	X																																											
Red																																												

Musculoskel	Neuro/Psych	Airway	Haematology																																
<table border="1"> <tr><td>Green</td><td>Weakness</td></tr> <tr><td>Yellow</td><td>X Left UL (CVA)</td></tr> <tr><td>Orange</td><td></td></tr> <tr><td>Red</td><td></td></tr> </table>	Green	Weakness	Yellow	X Left UL (CVA)	Orange		Red		<table border="1"> <tr><td>Green</td><td>CVA 3ys ago</td></tr> <tr><td>Yellow</td><td>X Slight residual weakness left UL</td></tr> <tr><td>Orange</td><td></td></tr> <tr><td>Red</td><td></td></tr> </table>	Green	CVA 3ys ago	Yellow	X Slight residual weakness left UL	Orange		Red		<table border="1"> <tr><td>Green</td><td>Edentulous</td></tr> <tr><td>Yellow</td><td>X</td></tr> <tr><td>Orange</td><td></td></tr> <tr><td>Red</td><td></td></tr> </table>	Green	Edentulous	Yellow	X	Orange		Red		<table border="1"> <tr><td>Green</td><td>Hb: 12g%</td></tr> <tr><td>Yellow</td><td>Blood type: O neg</td></tr> <tr><td>Orange</td><td>X Difficult x-match</td></tr> <tr><td>Red</td><td>WARFARIN</td></tr> </table>	Green	Hb: 12g%	Yellow	Blood type: O neg	Orange	X Difficult x-match	Red	WARFARIN
Green	Weakness																																		
Yellow	X Left UL (CVA)																																		
Orange																																			
Red																																			
Green	CVA 3ys ago																																		
Yellow	X Slight residual weakness left UL																																		
Orange																																			
Red																																			
Green	Edentulous																																		
Yellow	X																																		
Orange																																			
Red																																			
Green	Hb: 12g%																																		
Yellow	Blood type: O neg																																		
Orange	X Difficult x-match																																		
Red	WARFARIN																																		

CVS	Respiratory																
<table border="1"> <tr><td>Green</td><td>AF: 83/min</td></tr> <tr><td>Yellow</td><td>Aortic stenosis</td></tr> <tr><td>Orange</td><td>X Grad: 60mmHg on echo</td></tr> <tr><td>Red</td><td>LVH EF 55%</td></tr> </table>	Green	AF: 83/min	Yellow	Aortic stenosis	Orange	X Grad: 60mmHg on echo	Red	LVH EF 55%	<table border="1"> <tr><td>Green</td><td></td></tr> <tr><td>Yellow</td><td>X</td></tr> <tr><td>Orange</td><td></td></tr> <tr><td>Red</td><td></td></tr> </table>	Green		Yellow	X	Orange		Red	
Green	AF: 83/min																
Yellow	Aortic stenosis																
Orange	X Grad: 60mmHg on echo																
Red	LVH EF 55%																
Green																	
Yellow	X																
Orange																	
Red																	

Hepatic	GIT																
<table border="1"> <tr><td>Green</td><td></td></tr> <tr><td>Yellow</td><td>X</td></tr> <tr><td>Orange</td><td></td></tr> <tr><td>Red</td><td></td></tr> </table>	Green		Yellow	X	Orange		Red		<table border="1"> <tr><td>Green</td><td>H/O NSAID induced GI Bleed</td></tr> <tr><td>Yellow</td><td></td></tr> <tr><td>Orange</td><td>X</td></tr> <tr><td>Red</td><td>Reflux++</td></tr> </table>	Green	H/O NSAID induced GI Bleed	Yellow		Orange	X	Red	Reflux++
Green																	
Yellow	X																
Orange																	
Red																	
Green	H/O NSAID induced GI Bleed																
Yellow																	
Orange	X																
Red	Reflux++																

Metabolic	Renal	Gynae	Endocrine	PENDING																																								
<table border="1"> <tr><td>Green</td><td>X</td></tr> <tr><td>Yellow</td><td></td></tr> <tr><td>Orange</td><td></td></tr> <tr><td>Red</td><td></td></tr> </table>	Green	X	Yellow		Orange		Red		<table border="1"> <tr><td>Green</td><td>X Urea,Elect, Creat:</td></tr> <tr><td>Yellow</td><td></td></tr> <tr><td>Orange</td><td></td></tr> <tr><td>Red</td><td>WNL</td></tr> </table>	Green	X Urea,Elect, Creat:	Yellow		Orange		Red	WNL	<table border="1"> <tr><td>Green</td><td>X</td></tr> <tr><td>Yellow</td><td></td></tr> <tr><td>Orange</td><td></td></tr> <tr><td>Red</td><td></td></tr> </table>	Green	X	Yellow		Orange		Red		<table border="1"> <tr><td>Green</td><td>Hypothyroid, on Rx</td></tr> <tr><td>Yellow</td><td>X</td></tr> <tr><td>Orange</td><td>TFT: WNL</td></tr> <tr><td>Red</td><td></td></tr> </table>	Green	Hypothyroid, on Rx	Yellow	X	Orange	TFT: WNL	Red		<table border="1"> <tr><td>Green</td><td>INR on Admission</td></tr> <tr><td>Yellow</td><td></td></tr> <tr><td>Orange</td><td></td></tr> <tr><td>Red</td><td>X</td></tr> </table>	Green	INR on Admission	Yellow		Orange		Red	X
Green	X																																											
Yellow																																												
Orange																																												
Red																																												
Green	X Urea,Elect, Creat:																																											
Yellow																																												
Orange																																												
Red	WNL																																											
Green	X																																											
Yellow																																												
Orange																																												
Red																																												
Green	Hypothyroid, on Rx																																											
Yellow	X																																											
Orange	TFT: WNL																																											
Red																																												
Green	INR on Admission																																											
Yellow																																												
Orange																																												
Red	X																																											

KEY	
Green	NAD
Yellow	Low Risk
Orange	Medium Risk
Red	High Risk

Doctor: Dr. ZZZZ ZZZZ

Reg. No: 9999

Signature: *Signed*

Case 2 Grid Aid

Name: YYYY YYYY (female)
 Age: 76 Yrs
 ID: 888888T

Date: Recent Date

Procedure Right Revision Total Hip Replacement	ALERTS ALLERGIC TO PENICILLIN AVOID NSAIDS	Rx Digoxin Thyroxine Warfarin- to withhold	General/ASA ASA: 3 BMI: 28
CVS AF: 83/min Aortic stenosis Grad: 60mmHg on echo LVH EF 55%	Respiratory 	Airway Edentulous 	GIT H/O NSAID induced GI Bleed Reflux++
Hepatic 	Renal Urea,Elect, Creat: WNL 	Endocrine Hypothyroid, on Rx TFT: WNL 	Metabolic
Neuro/Psych CVA 3ys ago Slight residual weakness left UL	Musculoskel Weakness Left UL (CVA) 	Haematology Hb: 12g% Blood type: O neg Difficult x-match WARFARIN	Gynae
 	 	Investigations Echo: See CVS 	PENDING INR on Admission

KEY	
	NAD
	Low Risk
	Medium Risk
	High Risk

Doctor: Dr. ZZZZ ZZZZ

Reg. No: 9999

Signature: *Signed*

Case 2 Question Bank

Give a True/False answer:

1. The patient is in controlled atrial fibrillation.
2. The patient has a history of CVA.
3. The patient should take all her normal medications until the day of surgery.
4. Type and screen request for two units of blood will be adequate.
5. Surgery should be postponed due to inadequately treated hypothyroidism.
6. The effect of warfarin has worn off sufficiently to proceed with surgery.
7. The patient has vulnerable dentition.
8. This patient is at increased risk of regurgitation.
9. Antibiotic prophylaxis with flucloxacillin and gentamicin can be used in this case.
10. Left ventricular function is relatively well preserved.
11. The patient would tolerate vasodilation and hypotension poorly.
12. Nonsteroidal anti-inflammatory drugs (NSAIDs) should be avoided.

Case 3

PREOPERATIVE CLERKING NURSE ASSESSMENT	
Name: VVVV VVVV (female)	Date: Recent Date
Age: 58 yrs	ID: 777777T

POAC Nurse Assessment

Planned Procedure: Wide Local Excision Right Breast Lump and Sentinel Lymph node biopsy

Comorbidities: Hypertension, diabetes, obstructive sleep apnoea – refused CPAP

Drug History: Perindopril 8mg daily, Gliclazide 80mg tds, Metformin 500mg tds

Family History: Nil relevant

Prev Surgery: No previous procedures

Parameters

Height (cm): 165cm

Weight (cm): 140 kg

BMI: 51

Systolic BP (mmHg): 150

Diastolic BP (mmHg): 90

Heart Rate (per min): 90 bpm regular

Airway Assessment

Limitation of neck movement? no

Hoarseness? no

Swallowing Difficulty? no

Laryngoscopy grade: not known

Bridges/Crowns/Implants/Loose teeth? no

Mallampati Score: II

Mouth opening (cm): 6

Thyromental Distance (cm): 5cm

Beard? no

Education

Information leaflet discussed with patient.

Case 3

PREOPERATIVE CLERKING FY ASSESSMENT	
Name: VVVV VVVV (female)	Date: Recent Date
Age: 58 yrs	ID: 777777T

POAC FY Assessment

Planned Procedure: Wide Local Excision Right Breast Lump and Sentinel Lymph node biopsy
 Proposed Surgery Date: 30th November, 2018
 Proposed Admission Date: 29th November 2018
 Ward: Surgical 2

Cardiovascular

Do you suffer from chest pain? no
 *Do you suffer from HYPERTENSION? YES
 Have you ever had a heart attack? no
 Do you have a heart murmur? no
 Do you have any other heart condition? no
 Do you have a pacemaker?no
 *Has issues climbing two flights of stairs? YES. Gets short of breath

Respiratory

Do you suffer from asthma? no
 Do you suffer from cough? no
 Do you bring up sputum/suffer from COPD? no
 *Any SNORING/TIREDNESS related issues? YES

Gastro/Renal

Do you suffer from heartburn/reflux? no
 Have you ever had jaundice/liver issues? no
 Do you suffer from kidney disease? no

Neurological/Musculoskeletal

Do you suffer from epilepsy? no
 Any blackouts/faints/unconsciousness? no
 Have you ever had a stroke? no
 Any diseases affecting the nerves? no
 Do you have any neck or spinal issues? no

Endocrine

*Do you suffer from diabetes? YES
 Do you suffer from thyroid disease? no

Haematological

Do you suffer from anaemia? no
 Any bleeding or excessive bruising? no
 Do you suffer from clotting disorders? no

Case 3

Do you ever get PE or DVT? no
 Issues with previous blood transfusions? no

Social

Do you live alone? no
 Do you drink alcohol? no
 *How many cigarettes do you smoke daily? 10
 Ever taken any recreational drugs? no
 Can you be pregnant? No
 What is your occupation? secretary

Anaesthetic History

Any relatives with anaesthesia issues? no
 Any issues with previous anaesthetics? no
 Problems with taking NSAIDS in the past? no

Post Operative Nausea and Vomiting Risk

Female? YES (1pt)
 Smoker? yes
 Prev Postop Nausea/Vomiting/Motion Sickness? No
 *INTERMEDIATE/MAJOR SURGERY? YES (1 point)
 Apfel score: 2

ECG

Sinus Rhythm. Rate 78/min.

CXR

Ordered

Physical Examination

General appearance of concern? Obese

Cardiovascular Examination

Heart rate and rhythm? 85 regular
 JVP raised? No
 Cyanosis? No
 Heart sounds: S1+S2+0
 *LOWER LIMB OEDEMA: YES +
 Peripheral pulses: palpable

Respiratory Examination

Any chest deformity: no
 Chest auscultation: clear

Surgical Site examinations

Surgical site examination findings: Mass right breast Upper Outer quadrant

Preparation for Surgery

*ASA: 3

Case 3

Discussed with Anaesthetist: no
OK to proceed: yes
Pending Special Investigations: CXR, Echocardiogram
Pending referrals (cardiology, other): no

*Medications to **OMIT** before surgery: OHAs
Admission: Admit day of surgery.

Lab. Investigations

Hb: 13g%
WBC: 8,700 /uL
Plt: 243,000 /uL

Na+: 138 mEq/L
K+: 5.8mEq/L
Cl-: 104mEq/L





















Creatinine: 140 umol/L
eGFR: 39 ml/min/1.73m²

















RBG: 19.4 mmol/L

Case 3 Annotated Aid





Name: VVVV VVVV (female)
Age: 58 yrs
ID: 777777T



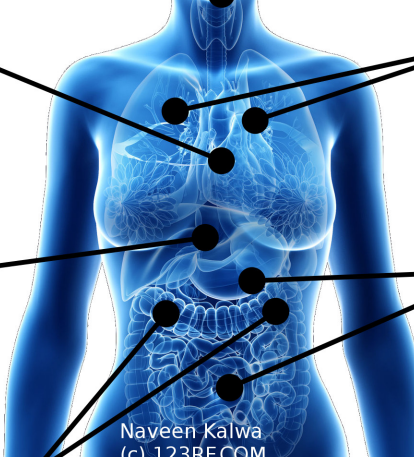

Date: Recent Date





Procedure	ALERTS	General/ASA	Rx	Investigations
    WLE Rt. breast + Sentinel In biopsy	   	    ASA: 3 Ht: 165cm Wt: 140kg BMI 51	    Perindopril Gliclazide Metformin	    ECG: NAD





Musculoskel	Neuro/Psych	Airway	Haematology
   	   	    BMI ^	    Hb: 13g% WBC: 8,700 Pit: 243,000























CVS



 BP^ on Rx
 SOB on 2 flights of stairs





Hepatic





Respiratory



 OSA - Declines CPAP
 Smokes: 10/dy

GIT





Naveen Kalwa
 (c) 123RF.COM

Metabolic	Renal	Gynae	Endocrine	PENDING
    Diabetes HGT: 19mmol/L K+: 5.8mEq/l Na+: 138mEq/L Cl-: 104mEq/l	    Creat: 130umol/L eGFR: 39ml/min	   	   	    CXR Echo

KEY	
	NAD
	Low Risk
	Medium Risk
	High Risk

Doctor: Dr. ZZZZ ZZZZ











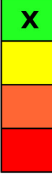



Reg. No: 9999

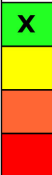

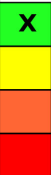

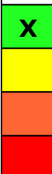
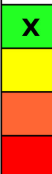
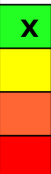
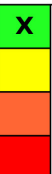
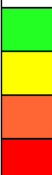
Signature: 

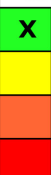
Case 3 Grid Aid

Name: VVVV VVVV (female)
 Age: 58 yrs
 ID: 777777T

Date: Recent Date

Procedure  WLE Rt. breast + Sentinel In biopsy	ALERTS  X	Rx  Perindopril Gliclazide Metformin	General/ASA  ASA: 3 Ht: 165cm Wt: 140kg BMI 51
CVS  BP^ on Rx SOB on 2 flights of stairs	Respiratory  OSA - Declines CPAP Smokes: 10/dy	Airway  BMI ^	GIT  X
Hepatic  X	Renal  Creat: 130umol/L eGFR: 39ml/min	Endocrine  X	Metabolic  Diabetes HGT: 19mmol/L K+: 5.8mEq/l Na+: 138mEq/L Cl-: 104mEq/l
Neuro/Psych  X	Musculoskel  X	Haematology  Hb: 13g% WBC: 8,700 Pit: 243,000	Gynae  X
		Investigations  ECG: NAD	PENDING  CXR Echo

KEY	
	NAD
	Low Risk
	Medium Risk
	High Risk

Doctor: Dr. ZZZZ ZZZZ

Reg. No: 9999

Signature: 

Case 3 Question Bank

Give a True/False Answer:

1. The patient suffers from hypertension.
2. Her diabetes is well controlled on oral hypoglycaemic agents.
3. The patient is a non-smoker.
4. The patient has poor exercise tolerance (less than four metabolic equivalents).
5. The patient's echocardiogram shows no significant abnormality.
6. The patient has impaired renal function.
7. It would be advisable to postpone surgery until the patient is optimised metabolically.
8. Nonsteroidal anti-inflammatory drugs (NSAIDs) could be used for postoperative analgesia.
9. The patient has ECG evidence of Left Ventricular Hypertrophy.
10. The patient is likely to require endotracheal intubation.
11. The patient is at increased risk of perioperative Deep Vein Thrombosis.
12. The patient is at increased risk of developing postoperative atelectasis.

Appendix F

User Satisfaction Questionnaires

F.1 Preoperative User

Questionnaire to assess preoperative users satisfaction with Cognitive Aids

Feedback

Please assess the utility and usability of the two charts.

This questionnaire will be scanned electronically for data extraction.

Please mark the boxes as shown below, with a black or blue ballpoint pen

To check box: To Uncheck/Correct:



(a) Grid Layout

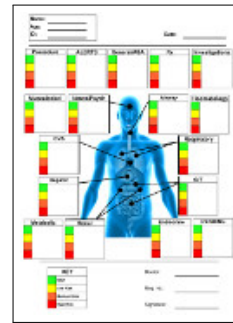

(b) Annotated Layout

1 Demographics

1.1 Your Grade

- FY1
 FY2
 BST
 HST
 RSp
 Consultant

1.2 Are you working or training in anaesthesia

- Yes
 No

2 Grid Layout

2.1 For the 'Grid' layout, assess the following features:

	Strongly Disagree				Strongly Agree
The layout is aesthetically pleasing	<input type="checkbox"/>	<input type="checkbox"/>	<input type="checkbox"/>	<input type="checkbox"/>	<input type="checkbox"/>
Information is clearly conveyed	<input type="checkbox"/>	<input type="checkbox"/>	<input type="checkbox"/>	<input type="checkbox"/>	<input type="checkbox"/>
The layout is confusing	<input type="checkbox"/>	<input type="checkbox"/>	<input type="checkbox"/>	<input type="checkbox"/>	<input type="checkbox"/>
It is "user friendly"	<input type="checkbox"/>	<input type="checkbox"/>	<input type="checkbox"/>	<input type="checkbox"/>	<input type="checkbox"/>
It helps me identify issues quickly	<input type="checkbox"/>	<input type="checkbox"/>	<input type="checkbox"/>	<input type="checkbox"/>	<input type="checkbox"/>
It helps me remember important issues	<input type="checkbox"/>	<input type="checkbox"/>	<input type="checkbox"/>	<input type="checkbox"/>	<input type="checkbox"/>

cntd. next page

Feedback

3 Annotated Layout

3.1 For the 'Annotated' layout, assess the following features:

	Strongly Disagree				Strongly Agree
The layout is aesthetically pleasing	<input type="checkbox"/>	<input type="checkbox"/>	<input type="checkbox"/>	<input type="checkbox"/>	<input type="checkbox"/>
Information is clearly conveyed	<input type="checkbox"/>	<input type="checkbox"/>	<input type="checkbox"/>	<input type="checkbox"/>	<input type="checkbox"/>
The layout is confusing	<input type="checkbox"/>	<input type="checkbox"/>	<input type="checkbox"/>	<input type="checkbox"/>	<input type="checkbox"/>
It is "user friendly"	<input type="checkbox"/>	<input type="checkbox"/>	<input type="checkbox"/>	<input type="checkbox"/>	<input type="checkbox"/>
It helps me identify issues quickly	<input type="checkbox"/>	<input type="checkbox"/>	<input type="checkbox"/>	<input type="checkbox"/>	<input type="checkbox"/>
It helps me remember important issues	<input type="checkbox"/>	<input type="checkbox"/>	<input type="checkbox"/>	<input type="checkbox"/>	<input type="checkbox"/>

4 Comparing Layouts

4.1 Comparing the two layouts, which do you find preferable for the features below?

	Grid				Annotated
The layout is aesthetically pleasing	<input type="checkbox"/>	<input type="checkbox"/>	<input type="checkbox"/>	<input type="checkbox"/>	<input type="checkbox"/>
Information is clearly conveyed	<input type="checkbox"/>	<input type="checkbox"/>	<input type="checkbox"/>	<input type="checkbox"/>	<input type="checkbox"/>
The layout is confusing	<input type="checkbox"/>	<input type="checkbox"/>	<input type="checkbox"/>	<input type="checkbox"/>	<input type="checkbox"/>
It is "user friendly"	<input type="checkbox"/>	<input type="checkbox"/>	<input type="checkbox"/>	<input type="checkbox"/>	<input type="checkbox"/>
It helps me identify issues quickly	<input type="checkbox"/>	<input type="checkbox"/>	<input type="checkbox"/>	<input type="checkbox"/>	<input type="checkbox"/>
It helps me remember important issues	<input type="checkbox"/>	<input type="checkbox"/>	<input type="checkbox"/>	<input type="checkbox"/>	<input type="checkbox"/>

5 Comments

5.1 Please enter any comments below.



F.2 Attending Anaesthetist

Questionnaire to assess attending anaesthetist satisfaction with Cognitive Aids

How many years have you worked in anaesthesia (including training)?

<2	3-5	6-10	>10
----	-----	------	-----



For the PLAIN layout, assess the following features:

The layout is aesthetically pleasing	Strongly Disagree <input type="checkbox"/> <input type="checkbox"/> <input type="checkbox"/> <input type="checkbox"/> <input type="checkbox"/> Strongly Agree
Information is clearly conveyed	Strongly Disagree <input type="checkbox"/> <input type="checkbox"/> <input type="checkbox"/> <input type="checkbox"/> <input type="checkbox"/> Strongly Agree
The layout is confusing	Strongly Disagree <input type="checkbox"/> <input type="checkbox"/> <input type="checkbox"/> <input type="checkbox"/> <input type="checkbox"/> Strongly Agree
It is user friendly	Strongly Disagree <input type="checkbox"/> <input type="checkbox"/> <input type="checkbox"/> <input type="checkbox"/> <input type="checkbox"/> Strongly Agree
It helps me identify issues quickly	Strongly Disagree <input type="checkbox"/> <input type="checkbox"/> <input type="checkbox"/> <input type="checkbox"/> <input type="checkbox"/> Strongly Agree
It helps me remember important issues	Strongly Disagree <input type="checkbox"/> <input type="checkbox"/> <input type="checkbox"/> <input type="checkbox"/> <input type="checkbox"/> Strongly Agree

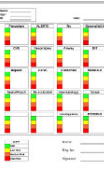

For the GRID layout, assess the following features:

The layout is aesthetically pleasing	Strongly Disagree <input type="checkbox"/> <input type="checkbox"/> <input type="checkbox"/> <input type="checkbox"/> <input type="checkbox"/> Strongly Agree
Information is clearly conveyed	Strongly Disagree <input type="checkbox"/> <input type="checkbox"/> <input type="checkbox"/> <input type="checkbox"/> <input type="checkbox"/> Strongly Agree
The layout is confusing	Strongly Disagree <input type="checkbox"/> <input type="checkbox"/> <input type="checkbox"/> <input type="checkbox"/> <input type="checkbox"/> Strongly Agree
It is user friendly	Strongly Disagree <input type="checkbox"/> <input type="checkbox"/> <input type="checkbox"/> <input type="checkbox"/> <input type="checkbox"/> Strongly Agree
It helps me identify issues quickly	Strongly Disagree <input type="checkbox"/> <input type="checkbox"/> <input type="checkbox"/> <input type="checkbox"/> <input type="checkbox"/> Strongly Agree
It helps me remember important issues	Strongly Disagree <input type="checkbox"/> <input type="checkbox"/> <input type="checkbox"/> <input type="checkbox"/> <input type="checkbox"/> Strongly Agree

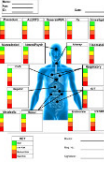

For the ANNOTATED layout, assess the following features:

The layout is aesthetically pleasing	Strongly Disagree <input type="checkbox"/> <input type="checkbox"/> <input type="checkbox"/> <input type="checkbox"/> <input type="checkbox"/> Strongly Agree
Information is clearly conveyed	Strongly Disagree <input type="checkbox"/> <input type="checkbox"/> <input type="checkbox"/> <input type="checkbox"/> <input type="checkbox"/> Strongly Agree
The layout is confusing	Strongly Disagree <input type="checkbox"/> <input type="checkbox"/> <input type="checkbox"/> <input type="checkbox"/> <input type="checkbox"/> Strongly Agree
It is user friendly	Strongly Disagree <input type="checkbox"/> <input type="checkbox"/> <input type="checkbox"/> <input type="checkbox"/> <input type="checkbox"/> Strongly Agree
It helps me identify issues quickly	Strongly Disagree <input type="checkbox"/> <input type="checkbox"/> <input type="checkbox"/> <input type="checkbox"/> <input type="checkbox"/> Strongly Agree
It helps me remember important issues	Strongly Disagree <input type="checkbox"/> <input type="checkbox"/> <input type="checkbox"/> <input type="checkbox"/> <input type="checkbox"/> Strongly Agree



Comparing the PLAIN and GRID layouts, which do you prefer for the features below?

The layout is aesthetically pleasing	PLAIN <input type="checkbox"/> <input type="checkbox"/> <input type="checkbox"/> <input type="checkbox"/> <input type="checkbox"/> GRID
Information is clearly conveyed	PLAIN <input type="checkbox"/> <input type="checkbox"/> <input type="checkbox"/> <input type="checkbox"/> <input type="checkbox"/> GRID
The layout is confusing	PLAIN <input type="checkbox"/> <input type="checkbox"/> <input type="checkbox"/> <input type="checkbox"/> <input type="checkbox"/> GRID
It is user friendly	PLAIN <input type="checkbox"/> <input type="checkbox"/> <input type="checkbox"/> <input type="checkbox"/> <input type="checkbox"/> GRID
It helps me identify issues quickly	PLAIN <input type="checkbox"/> <input type="checkbox"/> <input type="checkbox"/> <input type="checkbox"/> <input type="checkbox"/> GRID
It helps me remember important issues	PLAIN <input type="checkbox"/> <input type="checkbox"/> <input type="checkbox"/> <input type="checkbox"/> <input type="checkbox"/> GRID



Comparing the PLAIN and ANNOTATED layouts, which do you prefer for the features below?

The layout is aesthetically pleasing	PLAIN <input type="checkbox"/> <input type="checkbox"/> <input type="checkbox"/> <input type="checkbox"/> <input type="checkbox"/> ANNOTATED
Information is clearly conveyed	PLAIN <input type="checkbox"/> <input type="checkbox"/> <input type="checkbox"/> <input type="checkbox"/> <input type="checkbox"/> ANNOTATED
The layout is confusing	PLAIN <input type="checkbox"/> <input type="checkbox"/> <input type="checkbox"/> <input type="checkbox"/> <input type="checkbox"/> ANNOTATED
It is user friendly	PLAIN <input type="checkbox"/> <input type="checkbox"/> <input type="checkbox"/> <input type="checkbox"/> <input type="checkbox"/> ANNOTATED
It helps me identify issues quickly	PLAIN <input type="checkbox"/> <input type="checkbox"/> <input type="checkbox"/> <input type="checkbox"/> <input type="checkbox"/> ANNOTATED
It helps me remember important issues	PLAIN <input type="checkbox"/> <input type="checkbox"/> <input type="checkbox"/> <input type="checkbox"/> <input type="checkbox"/> ANNOTATED



Comparing the GRID and ANNOTATED layouts, which do you prefer for the features below?

The layout is aesthetically pleasing	GRID <input type="checkbox"/> <input type="checkbox"/> <input type="checkbox"/> <input type="checkbox"/> <input type="checkbox"/> ANNOTATED
Information is clearly conveyed	GRID <input type="checkbox"/> <input type="checkbox"/> <input type="checkbox"/> <input type="checkbox"/> <input type="checkbox"/> ANNOTATED
The layout is confusing	GRID <input type="checkbox"/> <input type="checkbox"/> <input type="checkbox"/> <input type="checkbox"/> <input type="checkbox"/> ANNOTATED
It is user friendly	GRID <input type="checkbox"/> <input type="checkbox"/> <input type="checkbox"/> <input type="checkbox"/> <input type="checkbox"/> ANNOTATED
It helps me identify issues quickly	GRID <input type="checkbox"/> <input type="checkbox"/> <input type="checkbox"/> <input type="checkbox"/> <input type="checkbox"/> ANNOTATED
It helps me remember important issues	GRID <input type="checkbox"/> <input type="checkbox"/> <input type="checkbox"/> <input type="checkbox"/> <input type="checkbox"/> ANNOTATED

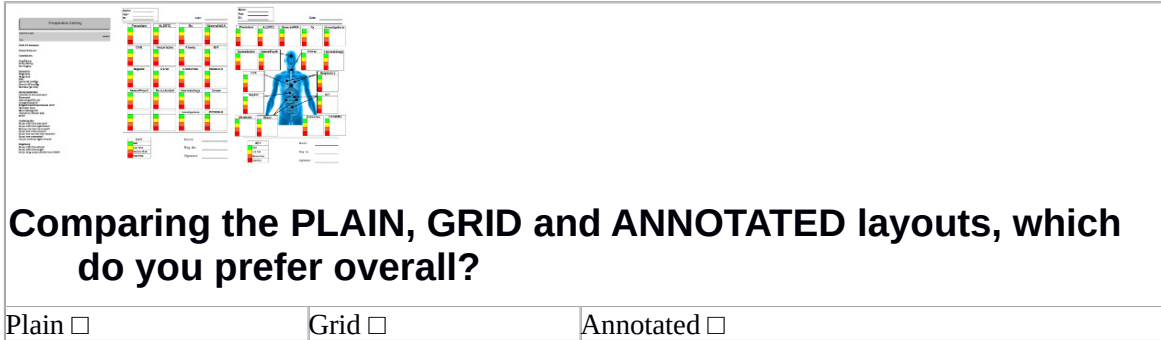

Comparing the PLAIN, GRID and ANNOTATED layouts, which do you prefer overall?

Plain Grid Annotated