

Improved Path Planning of the Blade for an Automatic Spinach Harvester

Naoto Takayama * Tatsuya Yamaguchi * Akihiro Fujisawa *
Tomokazu Kamijo * Koki Nakajima * Yoshifumi Seki *
Haruki Hayashi * Yuichi Chida *

* *Shinshu University, Nagano, 3808553 Japan (e-mail: chida@shinshu-u.ac.jp)*

Abstract: The tendency of spinach crop to get damaged during harvesting, even when harvested by human hands, is the most significant challenge in automating the spinach harvesting process. To overcome this, an automatic spinach harvester was developed previously using a novel harvesting concept by which the crop is harvested without grasping or clamping. In this method, path planning for a root cutting blade traveling in soil is very important for successful harvesting. An effective path generation method which can handle uneven ground was proposed, but the blade motion in this method causes large variations in the depth of the path. In this study, we propose a modified path which reduces the variation in blade motion in the vertical direction by modifying the parameters of the original path generation method. Field experiments were conducted to demonstrate its effectiveness, and the results show that the modified path achieves superior harvesting performance compared to the conventional path.

Copyright © 2020 The Authors. This is an open access article under the CC BY-NC-ND license (<http://creativecommons.org/licenses/by-nc-nd/4.0>)

Keywords: Automatic harvester, Spinach, Path planning

1. INTRODUCTION

Automatic harvesting of crops by a machine is useful for light agricultural work. Some automatic harvesters have been developed for rice cultivation, and advanced technologies have been applied to them by Zhang et al. (2013); Kurita et al. (2012). The development of automatic harvesters for various fruits and other applications has also been shown in multiple studies such as Li et al. (2011). However, automatic harvesting without causing damage to certain soft vegetables such as spinach is difficult, and a widely-used harvester has never been developed in Japan. The most challenging factor in developing a machine to harvest it is that the spinach crop is easily damaged, even when harvesting by human hands. Despite this difficulty, Japan-specific conditions require automatic harvesting with the same quality as manual procedures in the crop market for the harvester. In order to overcome these difficulties, some trials of the development of an automatic spinach harvester have been accomplished by Kobayashi (1998); Yoshida et al. (2000); Nishizawa (2012). In contrast, an automatic spinach harvester has been developed by Hirano et al. (2013); Hatakeyama et al. (2014, 2017); Fujisawa et al. (2014); Chida, Y. (2015) using a novel harvesting method by which spinach can be harvested without grasping or clamping it, thus ensuring that it is not damaged. To implement this method, the root of spinach must be successfully cut from within the soil by a wide cutter blade. Therefore, the blade is controlled in the vertical direction as well as at the angle required for harvesting. In this case, the primary important factor for successful harvesting is minimizing the amount of soil movement caused by the travel of the cutter blade. For this purpose, the blade must travel in the soil with a specified

arc path which does not move the soil. In Yamaguchi et al. (2017), the authors have proposed an effective path of the blade based on this perspective, and the effectiveness of the path is verified by experiments in a spinach field. However, because the variation of the blade in the vertical direction is relatively large in Yamaguchi et al. (2017), unevenness was observed in the lengths of the root and the improvement is required for Japan-specific conditions. In this study, we propose a modified path which reduces the variation of the blade in the vertical direction for the improvement. The practical feasibility of the modified path is evaluated through experiments in a spinach field using the modified harvester.

2. OUTLINE OF THE HARVESTER

2.1 Configuration of the harvester

The developed harvester, shown in Fig. 1 and Fig. 2, consists of a root cutting blade which cuts the root of the spinach in the soil, a height control unit which controls the vertical position of the blade, an angle control unit which controls the angle of the arm of the height control unit, the conveyance unit which transfers the root-cut spinach to the upper side using conveyers, a laser sensor which detects the ground surface position, and a crawler which drives the harvester with a gasoline engine. Specifications of the harvester is indicated in Table 1.

2.2 Height control unit

The configuration of the height control unit is shown in Fig. 3. The height control unit consists of a motor, feed screw, arm, and a linear potentiometer. The root

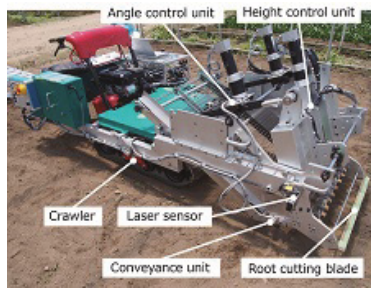


Fig. 1. Developed automatic spinach harvester

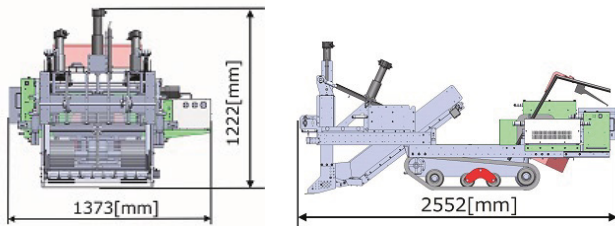


Fig. 2. Configuration of the automatic spinach harvester

Table 1. Specification of the automatic spinach harvester

| | |
|------------------------------|----------|
| Length | 2552[mm] |
| Width | 1373[mm] |
| Height | 1222[mm] |
| Root cutting blade width | 760[mm] |
| Crawler engine maximum power | 3098[W] |
| Crawler speed | 60[mm/s] |

cutting blade is fixed at the bottom position of the arm, and the height of the blade is controlled by the motor. Specifications of the height control unit is indicated in Table 2.

2.3 Angle control unit

The configuration of the angle control unit is shown in Fig. 4. The angle control unit consists of a motor, rack-and-pinion mechanism, the arm of the height control unit, and an encoder. The motor drives the rack-and-pinion mechanism by pushing or pulling the “P” point of the height control unit. The height control unit rotates about the point “R” as indicated in the red part in Fig. 4, and the angle of the root cutting blade is controlled to the specified angle. Specifications of the angle control unit is indicated in Table 3.

2.4 Harvest principle

The crawler proceeds at a constant speed, and the position of the root cutting blade is controlled such that it maintains the specified depth beneath the ground surface using the height control unit. Then, the root of the spinach is cut by the blade. The ground position is detected by the laser sensor, and the angle control unit simultaneously controls the angle of the blade to the specified angle trajectory which enables successful harvesting.

The concept used for successful harvesting without grasping nor clamping spinach is called “passive handling” shown in Fig. 5 and Chida, Y. (2015). In this method,

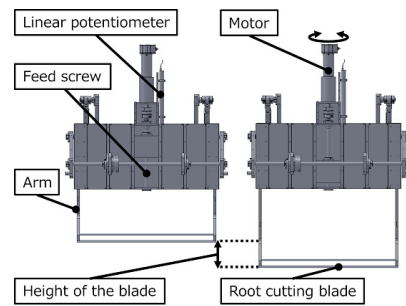


Fig. 3. Configuration of the height control unit

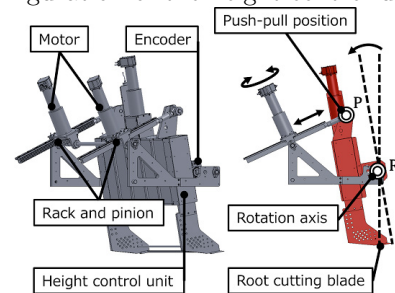


Fig. 4. Configuration of the angle control unit

Table 2. Specification of the height control unit

| | |
|-----------------|----------------|
| Driving method | DC servo motor |
| Maximum power | 400[W] |
| Motion range | ± 70 [mm] |
| Resolution | 1[mm] |
| Reduction ratio | 14:1 |
| Feed screw lead | 10[mm] |

Table 3. Specification of the angle control unit

| | |
|-----------------|-------------------|
| Driving method | DC servo motor |
| Maximum power | 400[W] \times 2 |
| Motion range | ± 30 [deg] |
| Resolution | 5000[ppr] |
| Reduction ratio | 308:1 |
| Feed screw lead | 110[mm] |

the root-cut spinach is transferred to the upper side of the harvester. The feasibility and effectiveness of passive handling have been verified by field experiments; the results are shown in Hirano et al. (2013); Hatakeyama et al. (2014, 2017). In order to implement passive handling, setting the path of the root cutting blade through the soil is important. In particular, it is shown that the smaller the total amount of passing volume of the root cutting blade, the more advantageous it is for harvesting, because, as per previous research, there is minimal rise of soil in such cases Fujisawa et al. (2014, 2015). One of the desired path generation methods designed to reduce the total amount of passing volume of the root cutting blade has been proposed by Yamaguchi et al. (2017), and its effectiveness has been verified by field tests. Field tests were carried out in a greenhouse in Nagano, Japan. An example of the greenhouse is shown in Fig. 6. The ceiling of the greenhouse is covered by a rain-cover and the side is opened to the air.

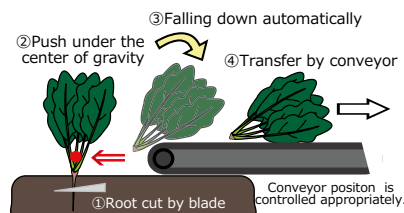


Fig. 5. Passive handling concept



Fig. 6. Spinach field in Nagano

3. PATH GENERATION METHOD BY YAMAGUCHI

3.1 Outline of the path generation

In this study, the path generation method proposed in Yamaguchi et al. (2017) is modified to provide superior root cutting performance based on the results by Takayama et al. (2016). In Yamaguchi et al. (2017), the coordinates of the path of the root cutting blade are defined as (x_w, y_w) , as shown in Fig. 7. The origin of the coordinate in x_w is the initial position of the blade and that for y_w is the vertical position of the rotating axis “R” of the angle control unit in the initial state. It is assumed that the harvester proceeds with a constant speed V_c in the positive direction in x_w . The coordinates of the root cutting blade are determined by three variables: the movement of the crawler in x_w direction, $x_c(t) = V_c \cdot t$, the length of the arm of the height control unit, $r(t)$, and the angle of the angle control unit, $\theta(t)$.

An equation of the position and the angle of the blade traveling the generated path is derived in the following section. In this case, it is assumed that the speed of the crawler is constant, the ground surface is flat, and the position “R” proceeds on the x_w axis. After the position and angle of the blade are determined, the target values of the arm length or the arm angle, which are control variables in the harvester, are derived by kinematically transforming the equation of the tip position.

3.2 Path planning concept

Because of the previously stated advantage of having a smaller total passing volume of the root cutting blade Fujisawa et al. (2014, 2015), the path generation method proposed in Yamaguchi et al. (2017) is effective. In the method, the tip position of the root cutting blade proceeds on the arc path such that it always points the blade toward the arc tangent, as shown in Fig. 8. By modifying the path, we can further reduce the total amount of passing volume of the root cutting blade. As a result, a path for one cycle consists of two types of sub-paths: the first, “Path 1,” is the arc tangent path, and the second, “Path 2,” is the path by which the blade translates in the vertical direction to the initial position of the next cycle.

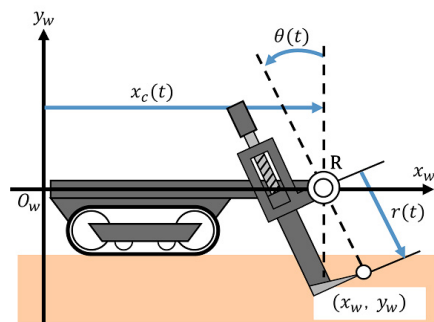


Fig. 7. Coordinates and variables for the harvester

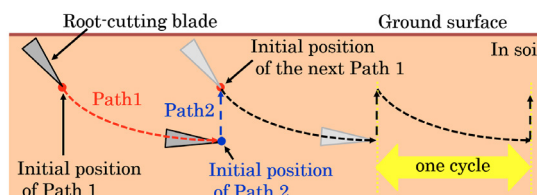


Fig. 8. Path of the blade by Yamaguchi et al. (2017)

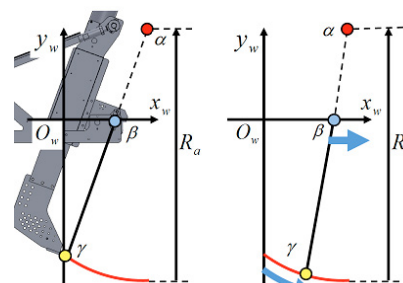


Fig. 9. Required constraint for the path by Yamaguchi et al. (2017)

The method by Yamaguchi et al. (2017) satisfies the conditions that the tip position of the blade is always on the arc and the tip direction follows the arc tangent direction. These conditions are equivalent to the positions of three marks, α , β , and γ , always being on a geometrical straight line such as shown in Fig. 9, where R_a , α , β , and γ are the radius of the arc path on Path 1, the rotational center of the arc, the rotational center of the arm of the angle control unit, and the tip position of the root cutting blade, respectively.

3.3 Coordinate equation of the blade

Coordinate equation for Path 1 A geometrical model of Path 1 is shown in Fig. 10. The parameters are Y_{a0} , Y_{w0} , and A , which guarantee that the three points, α , β , and γ are on a straight line. Y_{a0} , Y_{w0} , and A are the coordinate elements of α on the y_w axis, one of the initial positions of γ on the y_w axis, and the variation of the path in the vertical direction, respectively. It is necessary to align the following conditions with these three parameters.

$$Y_{a0} > 0, Y_{w0} < 0, A < 0 \quad (1)$$

By Fig. 10, because a triangle $\alpha P \gamma$ is a right triangle,

$$|\overline{\alpha\gamma}|^2 = |\overline{\alpha P}|^2 + |\overline{\gamma P}|^2 \quad (2)$$

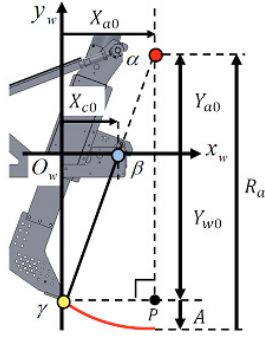


Fig. 10. Coordinate and variables for initial position in Path 1

is satisfied, where $|\overline{\alpha\gamma}|$ is the distance between the point α and the point γ , and the others are similarly defined. The radius of the circle, R_a , is derived by Fig. 10 such that

$$R_a = Y_{a0} - Y_{w0} - A, \quad (3)$$

and (2) and $|R_a| = |\overline{\alpha\gamma}|$ derives

$$R_a^2 = (Y_{a0} - Y_{w0})^2 + X_{a0}^2. \quad (4)$$

Then, the following is derived:

$$X_{a0} = \sqrt{R_a^2 - (Y_{a0} - Y_{w0})^2} \quad (5)$$

Furthermore, by considering $X_{a0}/X_{c0} = (Y_{a0} - Y_{w0})/(-Y_{w0})$, the following is derived:

$$X_{c0} = X_{a0} \left(\frac{-Y_{w0}}{Y_{a0} - Y_{w0}} \right). \quad (6)$$

Next, the coordinate of the tip position of the blade, x_w and y_w , is indicated by using R_a , X_{a0} , and X_{c0} , which are obtained by (3), (5), and (6). Figure 11 shows a model in which the tip of the blade moves through Path 1 by moving the clawer at a constant velocity. $\theta_w(t)$ is the angle of the arm on the x_w -axis, which is described as

$$\theta_w(t) = \tan^{-1} \left(\frac{Y_{a0}}{X_{a0} - (X_{c0} + x_c(t))} \right), \quad (7)$$

where $x_c(t)$, X_{a0} , X_{c0} , and Y_{a0} are variables, and $x_c(t)$ indicates the moving distance of the harvester on the x_w -axis at a constant speed. Because $|\overline{\alpha\gamma}|$ is always equal to R_a , the coordinate of the tip of the blade, $(x_w(t), y_w(t))$, is described using $\theta_w(t)$, X_{a0} , and Y_{a0} as

$$x_w(t) = X_{a0} - R_a \cos \theta_w(t), \quad (8)$$

$$y_w(t) = Y_{a0} - R_a \sin \theta_w(t). \quad (9)$$

Coordinate equation for Path 2 A geometric model of Path 2 is shown in Fig. 12. In Path 2, the blade is translated in the vertical direction from the end of Path 1 to the initial position and angle of Path 1 in the next cycle. According to Fig. 12, the position of the tip of the blade on the y_w axis changes from $Y_{w0} + A$ to Y_{w0} , but its traveling speed is not restricted. Then, the travel time from $Y_{w0} + A$ to Y_{w0} is a design parameter, and it is determined as follows: the position β translates in the x_w direction with the constant velocity V_c . If y_w travels to Y_{w0} by synchronizing with the time taken to move β to X_{c0} ,

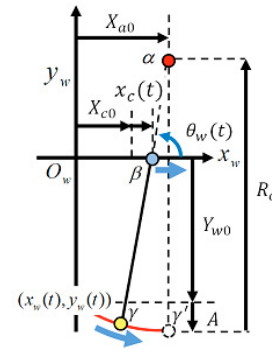


Fig. 11. Coordinate and variables for transition motion in Path 1

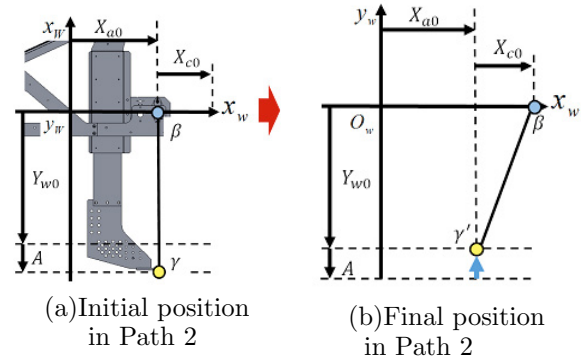


Fig. 12. Motion of β and γ in Path 2

the blade is set to the initial state of Path 1. As the time required is X_{c0}/V_c for moving X_{c0} with a constant velocity, the coordinates of the tip of the blade are described as

$$x_w(t) = X_{a0}, \quad (10)$$

$$y_w(t) = Y_{w0} + A - \frac{A \cdot V_c}{X_{c0}}(t - t_1), \quad (11)$$

where t_1 is defined in (13).

Summary of equations of Path 1 and Path 2 In Fig. 10, β travels the distance $X_{a0} - X_{c0}$ in the x_w direction in Path 1. In Path 2, β travels the distance X_{c0} in the x_w direction by Fig. 12. Then, the total amount of length which β travels is X_{a0} by Path 1 and Path 2. The harvester travels in the x_w direction with a constant velocity V_c ; thus, the period of the harvesting motion of the blade is described by

$$T = X_{a0}/V_c. \quad (12)$$

Then, the time required to traverse Path 1, t_1 , is indicated by

$$t_1 = (X_{a0} - X_{c0})/V_c. \quad (13)$$

Therefore, Path 1 and Path 2 are represented by the following equations:

Path 1: (8), (9) ($0 \leq t < t_1$)

Path 2: (10), (11) ($t_1 \leq t < T$)

3.4 Derivation of control target

By Fig. 7, the coordinates of the tip of the blade are described as follows, by using the arm length, $r(t)$, which

is controlled by the height control unit, and the arm angle, $\theta(t)$, which is controlled by the angle control unit:

$$x_w(t) = r(t) \cdot \sin \theta(t) + x_c(t), \quad (14)$$

$$y_w(t) = -r(t) \cdot \cos \theta(t). \quad (15)$$

By using (14) and (15), the target arm length of $r(t)$ and the angle $\theta(t)$ for Path 1 and Path 2 are obtained by

$$r_{ref}(t) = \sqrt{(x_w(t) - x_c(t))^2 + y_w(t)^2}, \quad (16)$$

$$\theta_{ref}(t) = -\tan^{-1} \left(\frac{x_w(t) - x_c(t)}{y_w(t)} \right). \quad (17)$$

Equations (16) and (17) are used to set the control objective in the height control unit and the angle control unit, respectively.

3.5 Summary of path generation procedure

The objective path is generated by the following procedure.

Step 0 (Initial setup) The design parameters for the design of the path, Y_{a0} , Y_{w0} , and A are specified. Y_{a0} , Y_{w0} , and A are the initial y_w coordinate value of the point α , the initial y_w coordinate value of the point γ , and the variation distance in the vertical direction in Path 1, respectively. The radius of the arc in Path 1 is determined as $Y_{a0} - Y_{w0} - A = R_a$.

Step 1 R_a , X_{a0} , and X_{c0} are derived by (3), (5), and (6) using the values Y_{a0} , Y_{w0} , and A .

Step 2 The total period for Path 1 and Path 2, T , and the required time for traversing Path 1, t_1 , are derived by (13) using the constant velocity of the harvester, V_c .

Step 3 In $0 \leq t < t_1$, the coordinate (x_w, y_w) is determined by the equation of Path 1. On the other hand, the coordinate (x_w, y_w) is determined by the equation of Path 2 in the period in $t_1 \leq t < T$.

(a) In the case of Path 1, $0 \leq t < t_1$

The coordinate of the target position of the tip of the blade, $x_w(t)$ and $y_w(t)$, is determined by (8) and (9), where $\theta_w(t)$ is given by (7), and $X_{c0}(t) = V_c t$, R_a , X_{a0} , and X_{c0} are parameters given in Step 0 and 1.

(b) In the case of Path 2, $t_1 \leq t < T$

$x_w(t)$ and $y_w(t)$ are determined by (10) and (11).

Step 4 By using the $x_w(t)$, $y_w(t)$, and $X_{c0}(t) = V_c t$ obtained in Step 3, $r_{ref}(t)$ and $\theta_{ref}(t)$, which are the targets of the height control unit and the angle control unit, are determined based on (14) and (15).

Step 5 Return to Step 3 for the next path generation period.

4. MODIFICATION OF THE OBJECTIVE PATH

4.1 Objective of path modification

When the variation of the vertical variation of the path, $|A|$, in Fig. 10 is large, the remaining length of the root-cut spinach varies based on the magnitude of $|A|$. Therefore, $|A|$ should be small in order to obtain uniform harvest results. If we set $A = -20$ [mm], the expected variation of the length of the remaining root after harvest is 20 [mm]. Although minimal variation of the length of the remaining root is expected, the path-following control is affected by

Table 4. Path parameters

| | Conventional | Modified |
|---------------|--------------|----------|
| V_c [mm/s] | 60 | |
| R_a [mm] | 1500 | |
| Y_{a0} [mm] | 1000 | |
| Y_{w0} [mm] | -480 | -490 |
| A [mm] | -20 | -10 |
| X_{a0} [mm] | 244 | 172 |
| X_{c0} [mm] | 79 | 56 |
| T [s] | 4.0 | 2.8 |

soil, and thus, it is unclear whether successful harvesting can be carried out for the specified $|A|$. In this study, the objective path is generated for specified values of $|A|$, and the comparative results are shown for the specified values of $|A|$.

4.2 Modified path generation

In the conventional study by Yamaguchi et al. (2017), $A = -20$ is specified, indicating that the depth of the blade varies by 20 [mm]. Here, we specify $A = -10$, and the harvesting performance is compared with that in the case where $A = -20$. At the same time, we compare the differences between the obtained paths. In our study, where $A = -10$, the depth of the blade is 10 mm, which is shallower than that in the case where $A = -20$. In order to specify the parameters such that the lowest positions of the blade are the same in the cases $A = -20$ and $A = -10$, we specified that $Y_{w0} + A = -500$ [mm] in each case. Thus, $Y_{w0} = -490$ [mm] is specified for the modified path parameter, and the radius R_a is unchanged. The other parameters, V_c and Y_{a0} , are the same. X_{a0} , X_{c0} , and T are derived by (5), (6), and (12). The parameters are shown in Table 4. In the present paper, “conventional” and “modified” indicate the blade path for $A = -20$ and $A = -10$, respectively.

By using parameters in Table 4, the path of the root cutting changes from the conventional one, and some characteristic parameters of the path change, such as R_a , X_{a0} , X_{c0} , and T . The changes of the characteristic parameters are shown as follows: $R_a^C = R_a^M$, $X_{a0}^C > X_{a0}^M$, $X_{c0}^C > X_{c0}^M$, and $T^C > T^M$, where the superscript C and M indicate the conventional and modified parameters, respectively. According to the relationship between the characteristic parameters of the conventional and modified paths, the values of parameters X_{a0} , X_{c0} , and T decrease if the value of $|A|$ is decreased. This indicates that not only the variation in the vertical direction but also that in the horizontal direction in the modified path decrease if the $|A|$ value is decreased. Additionally, the period of the path reduces if $|A|$ is small.

4.3 Comparison of the root cutting path

The coordinates of the root cutting paths, $x_w(t)$ and $y_w(t)$, are obtained by parameters in Table 4 based on (8), (9), (10), and (11). The obtained path of the root cutting blade is shown in Fig. 13, where $y_w = -500$ [mm] corresponds to the position in soil that is 30 [mm] beneath the surface of ground from the harvesting object. The control target value for the height and angle control units, r_{ref} and θ_{ref} , are obtained by (16) and (17). The obtained trajectories of

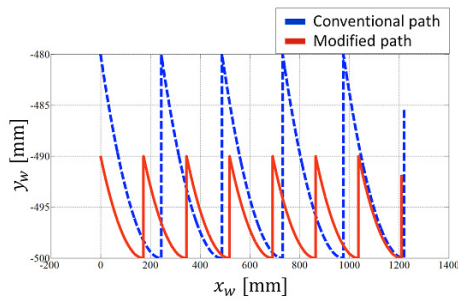
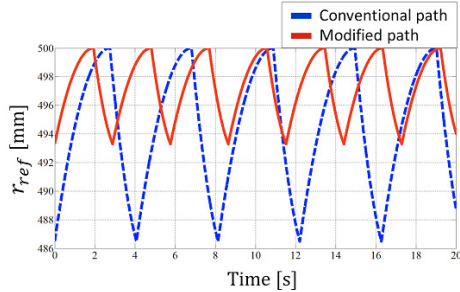
Fig. 13. Comparison of path of (x_w, y_w) 

Fig. 14. Comparison of arm length

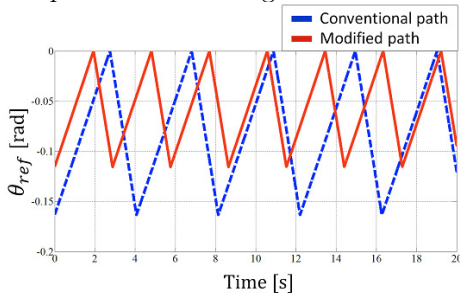


Fig. 15. Comparison of arm angle

r_{ref} and θ_{ref} for the paths are shown in Fig. 14 and Fig. 15. It is shown that the variation of the vertical direction on the y_w axis for the modified path decreases to 10 [mm] in Fig. 13, and the period for the path also decreases as compared to that for the conventional path.

5. EVALUATION BY EXPERIMENTS IN SPINACH FIELD

5.1 Conditions of experiment

The experiments are conducted on an agricultural production field in Nagano prefecture in Japan. The harvester harvested three rows of spinach simultaneously. An example of the field for the harvesting test is shown in Fig. 16. The traveling speed of the harvester was around $V_c = 60$ [mm/s], and the evaluation of the harvesting was carried out using harvested spinach by advancing the harvester by 5 [m]. The forward velocity of the harvester as $V_c = 60$ [mm/s] sounds slow, but it is more efficient than manual work by the speed. The conventional and modified paths of the root cutting blade described in the present paper were used for the experimental evaluation. As mentioned previously, parameters of the paths are shown in Table 4, and the parameters of A and Y_{w0} are different in the conventional and the modified paths. However, the



Fig. 16. Test field for spinach harvesting



Fig. 17. State of harvesting by the automatic harvester



Fig. 18. Examples of harvested spinach by the harvester

value of the lowest position of the blade is the same in the two paths: the value is 30 [mm] beneath the ground surface.

Tracking control for the height control and the angle control was carried out to follow the target path. The target values for the height and the angle control were generated using the previous procedure, and the sampling interval for the control was $T_s = 1$ [ms]. The controller was implemented in the digital signal processing (DSP) unit. PID-based controllers for the height and angle control were adopted for the tracking control. Parameters of the controller are tuned by the parameter space design method shown in Saeki et al. (1998); Hatakeyama et al. (2017).

State of the harvesting test in fields is shown in Fig. 17 and examples of harvested spinach by the harvester are shown in Fig. 18

5.2 Evaluation of tracking control performance

The tracking performances for the specified paths are compared in this section. Figures 19 and 20 show the tracking control performance of the height control for the conventional and the modified paths by experiments. The responses in Fig. 19 and Fig. 20 are reflected from the ground surface position measured by the laser sensor, so the magnitude of the responses are different from Fig. 14. The tracking control performances for the angle control are shown in Fig. 21 and Fig. 22. The spike signals appearing in some of these figures indicate data loss during measurement. The tracking performances for the specified paths are shown in Fig. 23 and Fig. 24. In these figures,

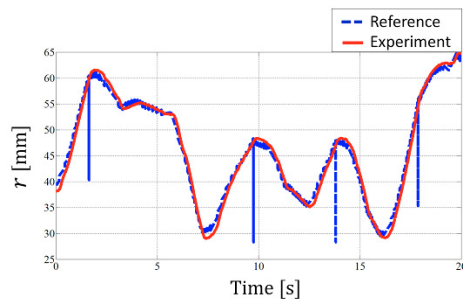


Fig. 19. Tracking control result of the height control on the conventional path

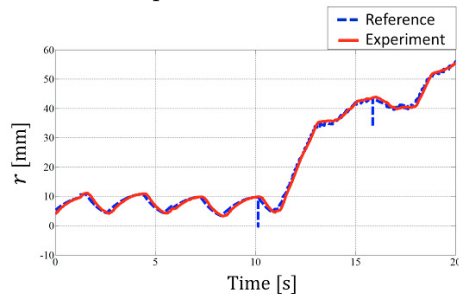


Fig. 20. Tracking control result of the height control on the modified path

$y_w = -500$ [mm] is corresponding to the position under -30 [mm] from the surface of the ground.

In Fig. 19 and Fig. 20, it can be seen that because the controller provides sufficient tracking control performance in the conventional and modified paths, the path modification does not influence the path of the blade here. In Fig. 21 and Fig. 22, the controller shows a response delay around 0.3 [s], which is likely to be caused by factors in the mechanical system configuration, such as friction in the control unit. The errors in the averages of the target and the tracking response are around zero in the conventional and the modified path in Fig. 21 and Fig. 22. The standard deviation of the errors for the conventional path and the modified path are 1.3 [deg] and 1.0 [deg], respectively. Therefore, it is shown that the harvester maintains sufficient tracking performance in terms of angle control for the modification of the path. Furthermore, it is verified that the tracking performance on the modified path is superior to that on the conventional path in Fig. 23 and Fig. 24. This is because the variation in movement on the modified path is smaller than that on the conventional path.

5.3 Comparison of harvesting performance

In this section, we evaluate the remaining length of the harvested spinach on the conventional and modified paths. For this purpose, the remaining lengths of the root-cut spinach are measured in each experiment. The histogram of the remaining length of the harvested spinach is shown in Fig. 25. The total amount of spinach and the average length of the remaining root as well as its standard deviation are shown in Table 5. The results show that all of the lengths of spinach harvested by the harvester are longer than 5 [mm], and the spinach is not damaged; thus, all of it can be shipped to the market. This shows that the developed automatic harvester successfully harvests

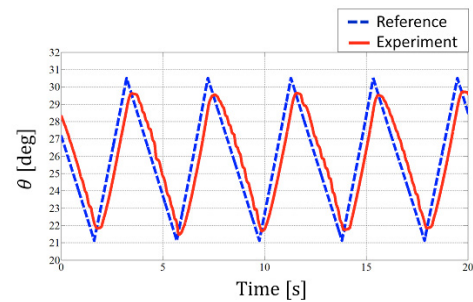


Fig. 21. Tracking control result of the angle control on the conventional path

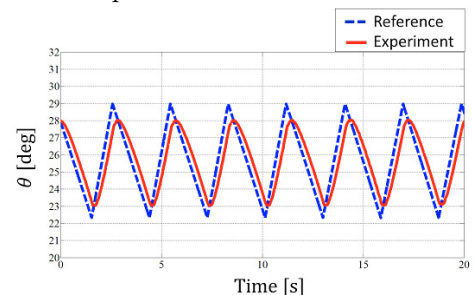


Fig. 22. Tracking control result of the angle control on the modified path

spinach with adequate performance. By Fig. 25, it can be seen that the remaining lengths of the harvested spinach are concentrated from 20 to 30 [mm] in the conventional and modified paths. Furthermore, the remaining lengths on the modified path are more concentrated to 30 [mm], which is the bottom of the blade in the modified path, and the variation in the remaining root length is smaller than that in the conventional path. The results show the harvester demonstrates superior performance on the modified path as compared to the conventional path.

6. CONCLUSIONS

In this study, a modified path generation method of the root cutting blade of a previously developed automatic harvester of spinach is proposed. The possibility of sufficiently tracking the modified path using the control system of the automatic harvester is verified, and the modification is successfully executed. The harvesting performance with the modified harvester is verified by field experiments, and the results demonstrate that the modified path provides superior harvesting performance as compared to the conventional path. We have executed many experiments in some fields by using the proposed path and it is verified that the harvester offers adequate harvesting performance by the experimental results. But the experiments have been executed in limited fields to greenhouses whose ceiling is covered by a rain-cover. It is a future work to enlarge the applicable field for the harvester.

ACKNOWLEDGEMENTS

The experiments in this study have been carried out thanks to the support of the National Federation of Agricultural Cooperative Associations in Nagano prefecture, Kaishin Industry Co., LTD., and Mr. Eiji Netsu. This

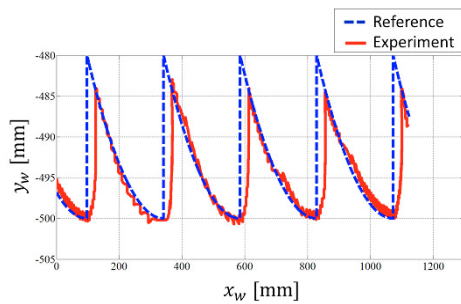


Fig. 23. Results of the tracking response on the conventional path

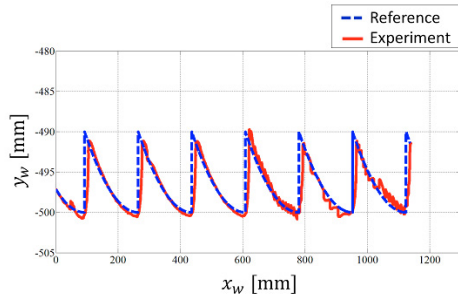


Fig. 24. Results of the tracking response on the modified path

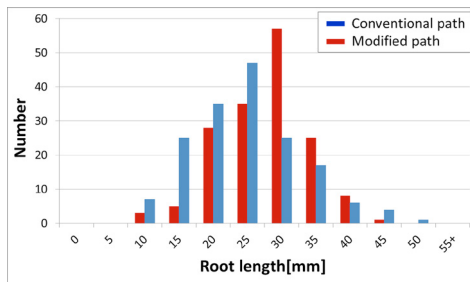


Fig. 25. Comparison of remaining lengths of the root-cut spinach

Table 5. Remaining lengths of the root-cut spinach by experimental results

| | Conventional path | Modified path |
|------------------------|-------------------|---------------|
| Total Number | 167 | 162 |
| Average[mm] | 22.6 | 26.1 |
| Standard Deviation[mm] | 7.9 | 6.3 |

work was supported by JSPS KAKENHI Grant Number JP16H02352.

REFERENCES

- Chida, Y. (2015), Development of an Automatic Harvester of Spinach Based on Passive Handling, *Journal of the Japan Society for Precision Engineering* 81(9), pp.815-818 (in Japanese).
- Fujisawa, A., Chida, Y., Nakamura, Y., Hirano, K., Tsuchiya, T., Hatakeyama, T., Yamaguchi, T., Iizuka, K., Shimada, T. and Kitazawa, S. (2014), Motion Analysis of the Root-Cutting Blade for an Automatic Spinach Harvester, *Proc. of the 12th International Conference on Motion and Vibration Control*.
- Fujisawa, A., Chida, Y. and Iizuka, K. (2015), Behavior analysis of soil by motion of a root-cutting blade in soil for an automatic spinach harvester, *Transactions of the JSME* 81(832), (in Japanese)
- Hatakeyama, T., Chida, Y., Hirano, K., Nakamura, Y., Tsuchiya, T., Yamaguchi, T., Fujisawa, A., Kitazawa, S. and Shimada, T. (2014), Tracking control of cutting blade of automatic spinach harvester, *Proc of the ISFA2014*
- Hatakeyama, T., Hirano, K., Nakamura, Y., Fujisawa, A., Tsuchiya, T., Yamaguchi, T., Chida, Y. and Yoshimura, T. (2017), Arm length and arm angle control of two-degree of freedom system of an automatic harvester for soft vegetables (1st report, arm length control of a root cutting blade) *Transactions of the JSME* 83(851), pp.16, (in Japanese)
- Hirano, K., Nakamura, Y., Tsuchiya, T., Chida, Y., Shimada, T., Fujigasaki, S. and Kitazawa, S. (2013), Design and control Two-Degree-of-Freedom Position Control Mechanism of a Root Cutting Blade in a Spinach Harvester. *Proc. of the 56th Japan Joint Automatic Control Conference*, (in Japanese).
- Kobayashi, Y. (1998), Development of simplified spinach harvester (Part 1). *Journal of the Japanese Society of Agricultural Machinery*, 60(2), 103–110 (in Japanese).
- Kurita, H., Iida, M., Suguri, M., and Masuda, R., (2012), Application of Image Processing Technology for Unloading Automation of Robotic Head-Feeding Combine Harvester. *Engineering in Agriculture, Environment and Food* 5(4), pp.146-151
- Li, P., Lee, S., and Hsu, H. (2011), Review on fruit harvesting method for potential use of automatic fruit harvesting systems. *Procedia Engineering* 23, pp.351-366
- Nishizawa, J. (2012), Development and utilization of harvesting machine for spinach and other tender greens for processing use, *Research Journal of Food and Agriculture*, 35(11), 37–41 (in Japanese).
- Saeki, M., Kimura, J., Kurata, H. and Taiji, S. (1998), Parameter Space Design Method of PID Controller for H_{∞} Control Problem. *Transactions of the Institute of Systems, Control and Information Engineers* 1(11), pp.35–40 (in Japanese)
- Takayama, N., Fujisawa, A., Kamijo, T., Nakajima, H., Seki, Y., Hayashi, H., Uehara, K., Netsu, E., Chida, Y., Ohba and S., Tenpaku, H. (2016), On path planning of the root cutting blade for an automatic spinach harvester. *Proc. of the 59th Japan Joint Automatic Control Conference*, (in Japanese).
- Yamaguchi, T., Chida, Y. and Fujisawa, A. (2017), Target path setting method of root cutting blades for an automatic harvester for soft leaf vegetables and its verification by field tests. *Transactions of the JSME* 83(845), pp.18, (in Japanese)
- Yoshida, T., Kubota, J. and Maeoka, K. (2000), Development of harvesting technology for spinach (part1). *Journal of the Japanese Society of Agricultural Machinery*, 62(3), 149–156 (in Japanese).
- Zhang, Z., Noguchi, N., Ishii, K., Yang, L., and Zhang, C. (2013), Development of a Robot Combine Harvester for Wheat and Paddy Harvesting. *IFAC Proceedings Volumes* 46(4), pp.45-48