

UDC 531/534:621:631.3

DOI: 10.15587/1729-4061.2022.253135

*The industrial development of cities is the main cause of the destruction and degradation of natural resources around the world. Urbanization negatively affects the species composition of plants, the atmosphere and soil cover of areas of populated areas of large cities of the World. Tree plantations are the main mechanism for stabilizing the ecological situation in large cities and arid territories of the countries of the World.*

*In this regard, in order to obtain a large number of genetically identical plants using their micropropagation, it is necessary to automate the main stages of this technological process.*

*The result of the study is the creation of an adaptive phalanx gripper of a robotic complex for automating the technological process of handling operations. That will have a positive effect on solving the urgent problem of planting greenery in large cities and areas of arid territories not only in the Republic of Kazakhstan, but also in other countries of the World and represents a fundamentally new approach to solving the environmental problems of the Earth.*

*The article substantiates various options for structural-kinematic schemes of the robot gripper, taking into account the stochastic conditions of its interaction with the overloaded object. Mathematical methods have been created for the selection and justification of the geometric, structural-kinematic and dynamic parameters of grippers for overloading plant microshoots and their computer 3D models. Software has been developed for modeling the functioning of a remotely controlled physical prototype of a mobile robot with an adaptive gripper for reloading microshoots from a transport tank to a cargo tank*

**Keywords:** robot, adaptive gripper, Kalman coefficient, microshoot overload, plant micropropagation

# CREATION OF AN INNOVATIVE ROBOT WITH A GRIPPER FOR MOVING PLANT MICROSHOOTS FROM THE IN VITRO TRANSPORT TANK TO THE WORKING TANK WITH SOIL GROUND AT THE STAGE OF THEIR ADAPTATION IN SOIL GROUND DURING MICROCLONAL REPRODUCTION

**Abylay Kaimov**

*Corresponding author*

PhD, Researcher of Mechanics\*

E-mail: a.kaim94@gmail.com

**Suleimen Kaimov**

PhD, Researcher of Mechanics\*

**Yerzhan Syrgaliyev**

PhD, Advisor

Department of Solid State Physics

Nazarbayev University Research and Innovation System

Kabanbay Batyr ave., 53, Nur-Sultan, Republic of Kazakhstan, 010000

**Amandyk Tuleshov**

PhD, Professor\*

**Talgat Kaiym**

PhD, Professor

Department of Mechanics

Military Engineering Institute of Radio Electronics and Communications

of the Ministry of Defense of the Republic of Kazakhstan

Zhandosova str., 53, Almaty, Republic of Kazakhstan, 050060

**Aidarkhan Kaimov**

PhD, Information Technology Specialist

Department of Information Systems

Al-Farabi Kazakh National University

Al-Farabi ave., 71, Almaty, Republic of Kazakhstan, 050040

**Altynay Primbetova**

Master, Specialist

Department of Information Technology

Halyk Bank of Republic of Kazakhstan

Al-Farabi ave., 40, Almaty, Republic of Kazakhstan, 050060

**Vitaly Gribanov**

PhD, Researcher\*

\*Department of Mechanics

Institute of Mechanics and Engineering named after U. A. Joldasbekov

Kurmangazy str., 29, Almaty, Republic of Kazakhstan, 050010

Received date 12.01.2022

Accepted date 23.02.2022

Published date 28.02.2022

**How to Cite:** Kaimov, A., Kaimov, S., Syrgaliyev, Y., Tuleshov, A., Kaiym, T., Kaimov, A., Primbetova, A., Gribanov, V. (2022). Creation of an innovative robot with a gripper for moving plant microshoots from the in vitro transport tank to the working tank with soil ground at the stage of their adaptation in soil ground during microclonal reproduction. *Eastern-European Journal of Enterprise Technologies*, 1 (7 (115)), 48–58. doi: <https://doi.org/10.15587/1729-4061.2022.253135>

## 1. Introduction

To solve the urgent problem of improving the climate on Earth, a United Nations conference was held in Paris in December 2015, at which all countries of the world were recom-

mended to adopt their national programs to reduce greenhouse gas emissions into the Earth's atmosphere to improve the climate. As it is known, tree plantations are one of the ways to improve the ecological situation in the settlements of large cities and arid territories of the countries of the world.

In the last 15–20 years, there has been an active greening of urban areas of large cities and arid territories of the countries of the world. For example, only in the Republic of Kazakhstan, large-scale landscaping of territories is planned until 2025: planting 2 billion trees in forests and 15 million in large cities and arid areas of settlements.

It is known that micropropagation of plants has a number of advantages: high multiplication factor; healing; the ability to work all year round and plan the release of plants by a certain date; preservation of valuable genotypes; obtaining homogeneous clones. At present, in the Republic of Kazakhstan, the technological process of micropropagation of plants is carried out with the use of human manual labor. This circumstance makes it practically impossible to solve the problem of planting greenery in large cities and areas of arid territories of the Republic of Kazakhstan and other countries of the World in this way. The effect of microclonal propagation of plants on an industrial scale to solve the problem of planting greenery in large cities and areas of arid territories in the Republic of Kazakhstan and other countries of the World depends on the degree of automation of the transfer of plant microshoots from the transport tank *in vitro* to the working tank with soil.

---

## 2. Literature review and problem statement

---

Reducing the import of planting material is one of the main tasks of planting greenery in large cities and areas of arid territories in the Republic of Kazakhstan and other countries of the world. In this regard, the need for domestic high-quality planting material of woody plants has increased [1].

The effect of micropropagation on an industrial scale depends on the ability of the robotic gripper to transfer plants from *in vitro* on a large scale at low cost and with high survival into the soil. Reloading operations of the technological process of plant microcloning at present in a number of countries of the World, including the Republic of Kazakhstan, are carried out manually or using robotic devices with a complex robot grip control system, which leads to a significant increase in the cost of plant microcloning products.

In work [2], the process of gripping, orientation, and gripper errors was studied. Modular schemes for the execution of grippers are proposed. However, this work did not study the main methods of technical implementation of capturing elastic and brittle thin-walled objects on the model of a thin-walled ring, which most accurately models the outer surface of plant microshoots. When capturing which, it is necessary to take into account the limitations on the gripping forces from the conditions for ensuring the necessary margins of strength and the smallness of elastic movements at the points of contact of the gripper with the plant microshoot.

In [3], it is proposed to divide the tongs, for unification, into functional and constructive parts, which makes it possible to synthesize various types of tongs based on standard mechanisms. However, the issues of power adaptation of the gripping mechanism are not considered there.

In [4], robots with electromechanical drives were studied. In almost all known robotic grippers, the same motor is used to move the working elements of the gripper and to generate the gripping force. In typical types of robot gripper, for the process of capturing an overloaded object and creating the necessary force for holding, one common engine is used. But at present, they are trying to separate these

operations, and the engine is used for the gripping process, and the reloaded object is held by elastic gripping elements of the gripper jaws or magnets, which significantly reduces the reliability of gripping the reloaded object and the gripper positioning accuracy.

In the article [5], experimental studies of the performance of the phalanx grippers of the robot were carried out. The actuators of the phalanges of the tongs are flat lever mechanisms. This robotic system with a phalanx tong has been tested for reloading agro-horticultural products. In this work, there are no studies of the parameters of the robot gripper, taking into account the stochastic conditions of its interaction with an overloaded object, which significantly reduces the accuracy of estimating the gripper parameters.

In the article [5], to calculate the gripping force of the grip, such a power parameter of the grip as its grip index was substantiated. Based on it, the preliminary geometric parameters of the phalanx tong were specified, selected from the geometric conditions for ensuring the capture of an overloaded object, for example, a ripe tomato. However, this approach does not provide a reliable assessment of the value of this most important power parameter of the gripper to ensure the conditions for the necessary margins of gripping reliability and the insignificance of elastic movements at the contact points of the gripping jaws of the phalangeal gripper with the area of the outer surface of a ripe tomato.

In the article [6], the dependence of the gear ratio of the robot gripper drive on the gripping force of the gripper was studied. Various robot grip drives have been investigated. In the known devices of electromechanical drives of the robot gripper, a lever mechanism and a screw-nut mechanism are used as an actuator, which are connected to the electric motor through a gearbox and a coupling. The main requirement for the grip, when the electric motor is turned off, is the inadmissibility of reverse motion. Therefore, various devices are used in the gripper drives to eliminate this process: blockers, brakes, ratchets, etc. The disadvantage of these devices is their low reliability, increased weight and size. Pneumatic grippers have low speed compared to electric drives, low accuracy and rigidity of positioning of the reloaded object due to its large inertia and the presence of gear reducers and a compressor. The use of a gripper electric drive has its advantages: simplicity of design and control, the possibility of creating unification and quick automatic replacement, and the absence of a high-pressure air supply. The advantage of using an electric drive in a gripper is its high accuracy and load capacity when working under conditions of high dynamic loads. Small-sized electric motors (DC, synchronous, asynchronous, collector) with power up to 1 kW, rated speed up to 3000 rpm and rated torques up to 10 Nm are widely used for the electric drive of the gripper. Small-sized DC electric motors, which are used to create high-speed control systems, have received wide application in the gripper electric drive. The main disadvantage of these devices is the need to use complex control systems for the operation of the gripping mechanism.

Currently, robots use electric and hydraulic actuators with one degree of freedom. Such a drive provides an unambiguous relationship between input and output motion. However, to overcome the variable resistance force, it is necessary to use a variable gear ratio between the input and output. The variable drive must include a controlled gearbox. Such a drive contradicts the requirement to minimize the weight and dimensions of the robot modules. Existing electrical and hydraulic systems have a «hard» connection

between the movement of the input and output pistons. The output link moves at a constant speed. In machine drives, it is necessary to use mechanical and hydraulic mechanisms with a variable speed of the output piston corresponding to a variable load. Various control systems are used for this purpose.

In [7], an adaptive scheme for controlling the output force is proposed for hydraulic cylinders using direct measurement of the output force through strain gauges. Due to the large and somewhat uncertain piston friction force, the chamber pressure control cylinder with Coulomb-viscous friction prediction may not be sufficient to achieve precise control of the output force. In the proposed approach, the error in the output force as a result of direct measurement is used not only for feedback control, but also to update the parameters of the corresponding friction model, which includes the Coulomb-viscous friction force in the sliding motion and the output force depending on the frictional force in the sliding motion. Stability is guaranteed as pressure force error and output force error. Under the constraint of the required output force and its derivative, the asymptotic stability as an error, the pressure force and output errors are also caused to be guaranteed. Experimental results show that a good pressure force control system does not necessarily guarantee good output force control, and that adaptive friction compensation is superior to friction compensation.

The article [8] developed gripping devices for reloading objects, adapting to various shapes of the outer surface of objects to be manipulated. Another option for creating a tactile adaptation system using a tactile hydraulic controller was proposed in [9].

With these well-known devices, adaptation to the shape of the surface of the reloaded object is ensured through the use of overhead drives with sensitive tactile elements of the gripping jaws. But such a system of adaptation to the surface of the object of manipulation has low reliability, efficiency and a complex system for controlling the tactile elements of the gripping jaws of the robot.

The article [10] carried out theoretical studies of the adaptive mechanism. The adaptive mechanism has two degrees of freedom, and performs power adaptation to a variable external load. The adaptive drive works without a gearbox and without a control system. Let's consider it expedient to use an adaptive hydraulic mechanism to drive the robot gripper, which overcomes a variable technological load.

Articles [11–13] present studies of the scientifically based choice of geometric, structural-kinematic, strength and dynamic parameters of an innovative manipulator gripper for reloading fuel elements of nuclear power plants with a thin-walled annular cross section. The adjustment of the kinematic and dynamic parameters of the prototype designs of the grippers was carried out on the basis of the developed algorithms and computer calculation programs, as well as the use of a modern system of integrated technology for virtual modeling and engineering analysis of CAD/CAM/CAE/PDM systems. The development of software and mathematical software is implemented on computing devices compatible with Inventor, APM WinMashine systems. When experimentally determining the gripping force of the robot gripper prototype for reloading reloaded objects, errors were found in their evaluation by three identical force sensors installed at each end of the gripping jaws. These errors are due to the following factors: the lack of consideration of the stochastic conditions for the interaction of the gripper with the reloaded object, as well as the lack of an adaptive gripper drive.

The conducted literature review suggests that the article proposes a solution to the extremely urgent problem of creating an innovative robot gripper with its adaptive drive for overloading a plant microshoot, taking into account the stochastic conditions of its interaction with a plant microshoot. This makes it possible to increase the reliability of the gripper, simplify its design and its control system to automate the operations of reloading plant microshoots during their microcloning and significantly reduce their production cost to solve the global problem of landscaping the territories of settlements in the Republic of Kazakhstan and other countries of the World.

---

### 3. The aim and objectives of the study

---

The study is devoted to the creation of an innovative adaptive gripper of a robotic complex for automating the transshipment operations of plants during their microclonal propagation.

- selection and justification of the general concept of the robotic complex;
- selection and justification of the structural and kinematic parameters of the phalangeal gripper of the robot;
- determination of gripping forces taking into account the stochastic conditions of its interaction with an overloaded object;
- experimental studies of the robot phalangeal gripper prototype.

---

### 4. Materials and methods

---

The studies were carried out using the methods of the theory of elasticity and the theory of machines and mechanisms, methods of mathematical modeling, the finite element method. All the main ways of gripping elastic and brittle thin-walled objects are studied on the model of a thin-walled ring, which most accurately models the outer surface of the object being reloaded. When capturing which, it is necessary to take into account the restrictions on the gripping forces from the conditions for ensuring the necessary margins of strength and the smallness of elastic movements at the points of contact of the structural elements of the gripper with the plant microshoot.

The design of the robot gripper structure was carried out using a 3D CAD model. The tong prototype was built using 3D printing. The prototype phalangeal gripper was tested in several gripping operations on various objects, such as a tennis ball and a ripe tomato. To measure the magnitude of the gripping force, various tests were carried out using three force sensitive resistors (FSR). Each test consisted of three to ten main tasks on the selection and placement of an overloaded item. During the tests, each item was lifted from its original position and transported to a working container. Another test tested the reliability and stability of the grip of the reloaded object: the robot gripper grabbed a ripe tomato and moved it along a given route at a maximum speed (1.0 m/s) to check whether the gripped object is securely held by the robot gripper.

The system consists of three FSR sensors that are connected to the Arduino Nano, and three resistances, the value of which is 10 kOhm. To measure the power consumed by the motor, the ACS 712 power module was connected in series to a power supply with a voltage value of 6 V.

The results of experimental studies of the tested grippers on the magnitude of the gripping force and the amount of energy consumed, measured by FSR sensors, for example, for a tennis ball, unripe and ripe tomatoes, are presented. The results obtained represent the change in time of the grip force measured by each sensor and the power consumption value obtained by multiplying the measured current by the 6 V power supply. The time was taken from the Arduino Nano's internal clock and measured in milliseconds.

Analytical and experimental studies have been carried out to improve the reliability of estimating the gripping force of a robot gripper during overload, for example, a tennis ball and a ripe tomato with the determination of the Kalman coefficient.

The adjustment of kinematic and dynamic parameters of prototypes of the grip design was carried out on the basis of the developed algorithms and computer calculation programs, and a modern system of integrated technology for virtual modeling and engineering analysis of CAD/CAM/CAE/PDM systems was also used. The developed software and mathematical software are implemented on computing devices compatible with Inventor, APM WinMashine systems. The methodology of scientific research was based on mechanical models, which were studied with and without taking into account their elasticity. On the basis of modeling and testing, appropriate changes were made to the drawings of the design documentation for the models of the prototype gripper. On the basis of the adjusted design documentation, demonstration prototypes of innovative gripper designs were developed. For the created samples of grippers, applications for inventions for patents were submitted to the patent office of the Republic of Kazakhstan.

The software developed to control the adaptive gripper of a mobile robot is divided into two levels. The lower level includes control modules for individual mechanisms of the mobile robot, which are executed on the microcontroller of the system. The upper level represents a software module that is executed on the control computer and implements a set of functions for calculating the main parameters of control algorithms for electric drives of mobile robot and manipu-

lator moving platforms in real time, depending on the specified operating modes. The exchange of information between the programs of the lower and upper levels is carried out according to a protocol based on the developed system of control commands. The format and the complete list of commands are multi-vector movement of the gripper with an overloaded object, holding it in the gripping position, releasing the object.

The lower-level modules are written in C++ in the Raspberry development environment and are loaded into the microcontroller program memory using a programmer/debugger. The microcontroller generates all the main control signals for the actuators of the mobile robot, including DC motors for the drives of the wheeled chassis of the robot, the servo drive of the turntable and the actuators (linear drives) of the manipulator.

**5. Research results of an innovative adaptive robot gripper for automating reloading operations of plant microshoots**

**5.1. Selection and justification of the general concept of the robotic complex**

Selection and substantiation of the general concept of a robotic complex of a manipulation device with a phalanx gripper for automating the transshipment operations of micro shoots from a transport container to a working container with soil during microclonal propagation of plants.

The technological process of plant microcloning consists of the steps shown in Fig. 1: in vitro introduction; animation of plant microshoots; rooting of plant micro shoots; adaptation of plant micro shoots in the soil; obtaining seedlings of plants and mini plants of plants. At present, their implementation is carried out with the use of human manual labor, which makes it impossible to solve the urgent problem of planting greenery in settlements in many parts of the world. In this regard, a solution to this problem is proposed by creating a robotic complex of a manipulation device with a gripper for moving plant micro shoots from an in vitro transport container to a working container with soil.

**Stages of micropropagation of woody plants (silver poplar, Bolle poplar) for landscaping**







Time	Stage	Photo	
15 days	Introduction to in vitro culture to obtain the main shoot from the axillary bud.		Introduction to in vitro culture
40 days	Animation of micro shoots (10 plants in one jar). From one microshoot, on average, 20 additional microshoots are formed.		Microshoot cartoon
50 days	Rooting of microshoots (10 plants in one jar). One microshoot, on average, forms 10 roots.		Rooting micro shoots
30 days	Adaptation of microshoots in the soil.		Adaptation of microshoots
90 days	Obtaining seedlings 25-50 cm.		Obtaining seedlings up to 50 cm
90 days	Obtaining seedlings 50-150 cm.		Seedlings up to 150 cm
Total	<b>It takes 315 days to get seedlings up to 150 cm.</b>		

Fig. 1. The main stages of plant microcloning

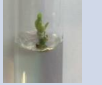
Fig. 2 shows the conceptual image of an innovative robotic complex of a manipulation device with a phalanx gripper for moving plant micro shoots from an in vitro transport container to a working container with soil at the stage of their adaptation in the soil during microclonal propagation.

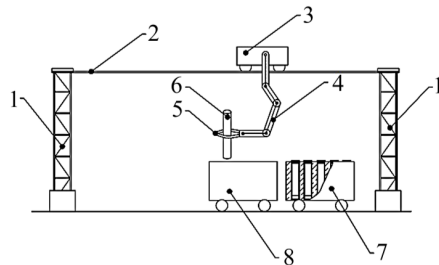

Fig. 2. Scheme of transshipment of plant sprouts from a shipping container into a cargo container with soil using an innovative phalanx gripper of an industrial robot manipulator:  
1 – support post; 2 – horizontal crossbar; 3 – vehicle;  
4 – manipulator; 5 – innovative phalanx tong;  
6 – plant micro shoot; 7 – transport container;  
8 – cargo container with soil

The functioning of this robotic complex is described in the articles [12–14].

## 5. 2. Selection and justification of the structural and kinematic parameters of the phalangeal gripper of the robot

As is known, the shape of the outer surface of the plant microshoot has an elongated cylindrical shape and a thin outer surface similar to agro-horticultural products, for example, cucumbers, bananas have a cylindrical shape. Ripe tomatoes and apples are also roughly spherical and have a thin outer surface. Therefore, the designed gripper is intended for handling goods that have a cylindrical or spherical shape with a thin outer surface. The average diameter of most considered horticultural products is in the range of 40 to 100 mm. Weight also varies even among identical species, but is always in the range from 50 to 500 g [5]. The mechanical properties of apples, pears and tomatoes have been measured in several research projects [4, 5]. Since the ripe tomato has the worst mechanical characteristics, it was used as a reference fruit for the development of tongs for this product line.

The prospective look of the tong for reloading operations of this product line is determined by the following functional and economic features:

- the gripper actuator has a block diagram with 1–3 degrees of freedom to move two or more of its gripping jaws to the object being reloaded;

- to be able to control the gripping force of the reloaded object to avoid damage to its outer surface and the lack of control of the gripping force is the main disadvantage of the gripper;

- artificial brushes, consisting of several anthropomorphic phalanges, capable of adapting to the shape of the captured object, wrapping around it. They can be flexible and adapt to most shapes, but they require multiple actuators and sensors, making the grip more difficult and costly to control;

- pneumatic grippers that use a partial vacuum to grip an object with a non-porous surface. The clutch is difficult to control and can deform or damage the outer surface of the objects being handled. In addition, the suction cups may not adhere to some of the concave and/or uneven outer surfaces

of the items being handled, rendering them inoperable. For these reasons, pneumatic devices cannot function reliably when these items are overloaded.

Thus, the optimal gripper structure for reloading these products should have articulated phalanges to adapt them to the cylindrical and spherical shapes of the reloaded objects with adjustable grip force and a simple control system.

The main structural component of the robotic gripper of the robot is the gripping sponge, since it is this structural element that is in direct contact with the captured object. Sponge development can be approached using the following solutions:

- rigid jaws, consisting of one solid body and they are moved by the gripper actuator. They ensure the grip of the overloaded object also due to friction. Most modern grip designs use them as they are fairly easy to design, build and manage.

- Articulated gripping jaws, which are formed by two or more structural elements connected by driven flexible rods. They can adapt their gripper configuration to the outside shapes of the goods being handled, but require a more sophisticated multi-motor control system.

- Elastic gripping jaws based on elastic materials. This sponge has a structure that can adapt to the irregular shape of the outer surface of the items being handled. The compliance factor increases the contact surface, therefore, the stress on the gripped object is reduced.

After evaluating these aspects, a structure diagram of a phalangeal gripper with gripping jaws was selected as the design of the gripper for reloading horticultural products and plant microshoot shown in Fig. 3.

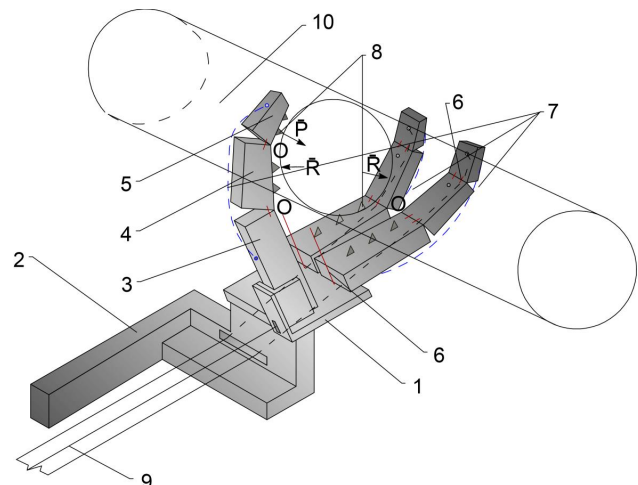

Fig. 3. Three-phalange adaptive gripper of the robot manipulator for reloading plant microshoots from the transport container into the working container with soil:

- 1 – tile-base for attaching the main phalanx of the gripper lever; 2 – mounting arm of the manipulator; 3 – main phalanx; 4 – middle phalanx; 5 – pointed phalanx; 6 – hinge for fastening adjacent phalanges to each other; 7 – tightening spring; 8 – gripping sponge; 9 – flexible traction element, 10 – plant micro shoot

The rotation of the phalanges of the gripper levers is supposed to be carried out using the two most effective options for the location of the gripping jaws of the phalanges of the gripper levers near the upper part of the plant microshoot body:

- two gripping jaws, shown in Fig. 4, a, located on the inner surface of the phalanges of the gripper levers, are located on one side of the outer surface of the microshoot body

section of the plant, one gripping sponge, located on the outer inner surface of the phalanx of the gripper lever, is located near the opposite side of the outer surface area of the plant microshoot body;

– two gripping jaws, shown in Fig. 4, *b*, located on the outer inner surface of the phalanges of the gripper lever, are located on one side of the outer surface of the plant microshoot body section and two holding sponges, located on the outer inner surfaces of the phalanges of the gripper lever, are located near the opposite side the outer surface of the plant microshoot body area.

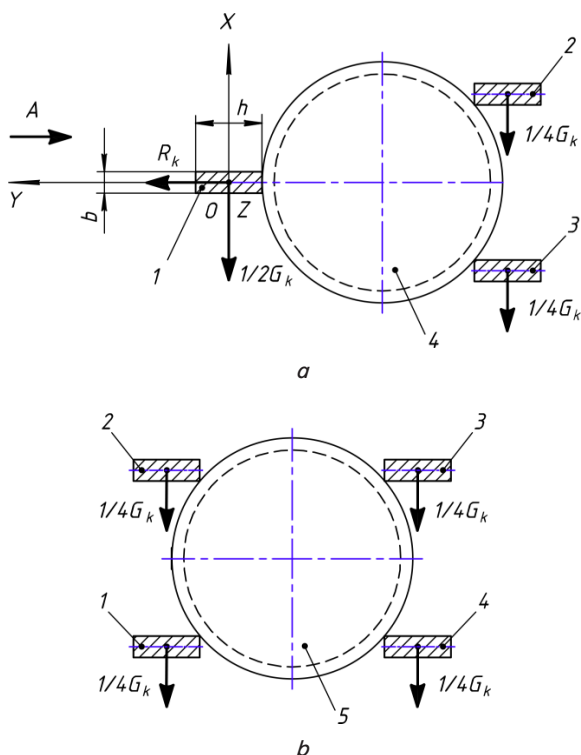

Fig. 4. Different options for capturing an object: *a* – variants of the scheme of loading the gripping jaws of the phalanges of the gripper lever (view along the longitudinal axis of the gripping jaw); *b* – when clamping a part of the plant micro shoot body from above and below with gripping sponges; 1, 2, 3, 4 – gripping jaws; 5 – plant micro shoot *b* – the length of the holding tooth; *h* is the width of the gripping jaw

Among all possible options, the grip force index [5] is used as a design criterion, since it is a compact expression for evaluating the performance of the grip mechanism.

First, the lengths of each phalanx  $l_1$  and  $l_2$  of the two-phalanx tong are determined from the geometrical conditions for capturing the object, and the length of each phalanx should be more than half of the maximum diameter of the captured object. Next, the values of these phalanx lengths are optimized using the gripping force index, that is, it directly depends on the accuracy of estimating the gripping force of the object with the tong.

The value of the gripping force of an object by a gripper in [5] is determined from the geometry of the configuration of its actuator, that is, only from the condition of the static equilibrium of the object during its gripping.

For example, most agro-horticultural products have a weight in the range of 0.5 to 2.0 N. Then the maximum

gripping force  $P_{max}$  can be calculated directly. Taking into account the product weight of 5.0 N and the calculated safety factor of 2.5,  $P_{max}$  is calculated to be 106.66 N, and the average gripping force  $P_{mean}$  is 56.41 N [5]. Therefore, for the design of an innovative robot gripper, the accuracy of estimating the gripping force of the robot gripper is relevant.

An increase in the number of working elements of the grip gives an expansion of the area of permissible values of the forces of gripping a ring with a large diameter from the conditions of the absence of deformation and stress in the area of contact of the working element of the phalangeal grip with a plant microshoot. Therefore, in this study, cases of capturing the annular structural element of a plant microshoot are considered at four, six and eight points of contact of the inner surface of the working element of the phalanx gripper with the outer surface of the plant microshoot. In works [11, 12] the following formulas for calculating the maximum and minimum allowable values of the gripping force of a thin-walled ring were substantiated from the conditions for ensuring the reliability of the grip and the insignificance of the values of elastic displacements at the points of contact of the working element of the gripper with the ring both in the static and dynamic state of the gripper in the process of interaction with the overloaded object and taking into account its physical and mechanical characteristics.

The value of the pressing force of the outer inner surfaces of each phalanx 3–5, with the retaining teeth 8 attached to each of them, of each gripper lever to the outer limiting surface of the upper part of the microshoot body of the plant 10, which is shown in Fig. 4, is determined by the formula:

$$P_{max} = \frac{\sigma_{add} l t^2}{0.3967}, \tag{1}$$

and

$$P_{min} = \frac{G + F_I}{8f}, \tag{2}$$

where  $P_{max}$  – the value of the maximum permissible gripping force of the gripper ring when performing minor elastic movements at the points of contact of the working element of the gripper with the ring;  $\sigma_{add}$  – the value of the allowable normal voltage of an object having an annular cross section;  $l$  and  $t$  – the width and thickness of the ring;  $P_{min}$  – the value of the minimum allowable gripping force on the outer surface of the ring for reliable retention of the plant micro shoot;  $G$  – the weight of the ring and  $F_I$  – the magnitude of the inertial force acting on the ring.

### 5.3. Determination of gripping forces taking into account the stochastic conditions of its interaction with an overloaded object

The magnitude of the force  $P$ , i.e.  $P_k$ , with which the gripper interacts with the upper part of the body of the captured object, is determined from the following system of equations:

$$\begin{cases} P_{k+1} = P_k + u_k + \gamma_k, \\ z_k = P_k + \delta_k, \end{cases} \tag{3}$$

where  $P_k$  – the magnitude of the force  $P$ , determined taking into account the random error of its deviation in the «ideal model»;  $x_{k+1}$  – the magnitude of the force  $P$ , determined taking into account the random error of its deviation

in the «ideal model» in a different time interval;  $u_k$  – the magnitude of the force  $P$ , which controls the evolution of the state matrix of its change, with which the gripper interacts with the surface of the upper part of the body of the manipulated object, which is determined analytically by formula (1) or (2);  $z_k$  – the magnitude of the force  $P$ , determined experimentally, taking into account the systematic error caused by the accuracy of the measuring instruments;  $\gamma_k$  and  $\delta_k$  – accordingly, the errors of the mathematical model of the analytical calculation and experimental determination of the magnitude of the force  $P$ , measured by technical means of measurement, and the analytical values of the force  $P$  are determined by (1) or (2).

In this case, random errors caused by the deviation of the designed three-phalanx adaptive gripper of the manipulator from its «ideal» model are determined by statistical moments  $M_{\gamma_i}$ , whose values and their distribution laws do not depend on time (iteration numbers  $i$ ); mean error values are zero:  $M_{\gamma_i} = M_{\delta_i} = 0$ . The law of distribution of random variables of the force of grasping an object with a gripper may not be known, but their dispersions are known  $\sigma_{\gamma}^2$  and  $\sigma_{\delta}^2$ . It is assumed that all random errors in determining the magnitude of the gripping force of an object with a gripper are independent.

It is assumed that at the  $i$ -th step the filtered value from the sensor is found  $P_i^{opt}$ , which approximates the true coordinate of the system  $P_i$ . The unknown value  $P_{i+1}$  is determined by the formula:

$$P_{i+1} = P_i + u_i + \gamma_i, \tag{4}$$

where  $u_i$  – the value that controls the evolution of the state matrix of the change in force  $P$ .

Therefore, having not yet determined the value of the grasping force of the gripper object from the sensor, it is assumed that at step  $i+1$  the system evolves according to this law and the sensor will show the grasping force of the object by the gripper close to the value  $P_i^{opt} + u_i$ . Simultaneously with this circumstance, at step  $i+1$ , there is an inaccurate reading from the sensor  $z_{i+1}$ . The idea is that in order to get the best approximation to the true coordinate  $x_{i+1}$  the so-called «golden» mean between the indication  $z_{i+1}$  source from the sensor and  $P_i^{opt} + u_i$  being its prediction. The sensor reading is given a Kalman weight  $K$ , and the predicted value  $(1-K)$  is given a value  $P_{i+1}^{opt}$  is determined by the formula:

$$P_{i+1}^{opt} = K \cdot z_{i+1} + (1-K) \cdot (P_i^{opt} + u_i), \tag{5}$$

where  $K$  is the value of the Kalman weight coefficient, which is chosen such that the resulting optimal value of the coordinate  $P_{i+1}^{opt}$  would be closest to the value of the true coordinate  $P_{i+1}$ . For example, if it is known that the readings from the sensor are very accurate, then the degree of confidence in it will be greater and the value will have a greater weight ( $K$  is close to one). If the sensor is estimated with significant errors, then it is necessary to focus more on the theoretically predicted value  $P_i^{opt} + u_i$ . In general, to find the exact value of the Kalman coefficient, it is necessary to minimize the magnitude of random and systematic errors  $\gamma_k$  and  $\delta_i$ .

To determine the exact value of the Kalman coefficient, it is necessary to minimize the value  $e_{i+1}$ , which is the mathematical expectation of the square of the error:

$$e_{i+1} = P_{i+1} - P_{i+1}^{opt}. \tag{6}$$

After substituting formula (4) into equation (5), it turns out:

$$e_{i+1} = (1-K) \cdot (e_i + \gamma_i) - K \cdot \delta_{i+1}. \tag{7}$$

The average value of the mathematical expectation from the squared error is minimized:

$$M(e_{i+1}^2) \rightarrow \min. \tag{8}$$

The mathematical expectation of the value of the square of the error in determining the force  $P$  of the interaction of the three-phalanx adaptive grip of the industrial robot manipulator with the object of manipulation when it is reloaded from the transport container to the working container is determined by the formula:

$$M(e_{i+1}^2) = (1-K)^2 (Me_i^2 + \sigma_{\gamma}^2) + K^2 \sigma_{\delta}^2. \tag{9}$$

According to formula (9), the minimum value of the mathematical expectation of the squared error is determined under the condition:

$$K_{i+1} = \frac{Me_i^2 + \sigma_{\gamma}^2}{Me_i^2 + \sigma_{\gamma}^2 + \sigma_{\delta}^2}. \tag{10}$$

To determine the value of the Kalman weight coefficient, it is necessary to calculate the values of the statistical moments of random errors of the mathematical model and systematic errors in measuring the gripping force  $P$  of the three-phalanx adaptive grip of the robot when it interacts with the upper section of the manipulated object. Thus, the algorithm for solving the developed mathematical model, estimating the stochastic system of the dynamic process of interaction of the three-phalanx adaptive gripper of the manipulator with the object of manipulation is implemented using an iterative formula for calculating the value of the Kalman weight coefficient.

During an experimental study of the operation of pressing each phalanx of the gripper, with the gripping jaws of each gripper lever attached to each of them, to the surface of the upper section of the object of manipulation, an experimental relationship was obtained between the value of the force  $P$  and the length of each phalanx. The found Kalman coefficient made it possible to reduce the errors in the indication of the grip force sensor.

The prototype phalangeal gripper was tested in various operations for gripping an overloaded object, such as a tennis ball and a ripe tomato. Operations were carried out to capture the reloaded item with a tong and move it from its original position to the working container. And its movement along a given route with a maximum speed (1.0 m/s) to test a reliable and stable hold of an overloaded object by a tong. During experimental studies, errors were established between the values of the gripping force of an overloaded object, which were measured by three sensors in each test. This error is due to the need to improve the accuracy of estimating the gripping force parameter of the object being overloaded by the robot gripper. Unlike well-known studies, the experimental data obtained were refined by determining the Kalman coefficient, which ensured an increase in the accuracy of estimating the robot grip force parameter, as well as the structural and kinematic parameters of the robot grip.

When  $\sigma_{\gamma}=1$  and  $\sigma_{\delta}=10$  and when  $K=0.1$  there was a stabilization of changes in the values of the Kalman coefficient.

The maximum and minimum errors of the sensor in estimating the value  $P$  of the gripping force of the phalangeal tong were respectively  $\epsilon_{\max}=5 \cdot 10^{-2}$  and  $\epsilon_{\min}=0.09 \cdot 10^{-2}$ .

**5. 4. Experimental studies of the robotic phalanx gripper prototype**

To test the performance of the developed gripper, its prototype was built using 3D printing. The gripper was equipped with a RB350018-2AH22R geared motor and mounted on a serial UR5 robotic arm from Universal Robots. An experimental sample of the gripper was built on a Stratasys Dimension Elite 3D printer [12, 13], which was able to print objects up to  $200 \times 200 \times 300$  mm in size with a layer thickness of 0.254 mm. The material used by the printer was ABS plastic. The corresponding structural elements of the parts were made of polyurethane foam rubber using a 10 mm thick layer. The printed prototype is shown in Fig. 5.



Fig.5. Prototype gripper built using 3D printing

The work was controlled through the user interface of the UR5 robot [12], which allows to plan the movement of the robot by setting waypoints and predefined commands triggered by input signals.

Table 1

Elementary analysis of operations for a selective assignment of laboratory tests of the functioning of the developed adaptive robot manipulator gripper for reloading agro-horticultural products

Transfer task	T	M	A	P
The manipulator moves to a gripping position	–	×	–	–
Product seized	–	–	×	–
The manipulator picks up an object	×	–	–	–
The manipulator moves to the release point	×	–	–	–
Manipulator lowers to first release position	×	–	–	–
Object released	–	–	×	–

The prototype triphalangeal gripper has been tested in several different picking and placing operations for various products (ripe and unripe tomatoes, peaches, apples). Each test consisted of three to ten main selection and placement tasks. The tested «pick and place» task for an individual product is described in Table 1 using a rudimentary decomposition of operations to plan operations. An elementary action is defined as the smallest manipulative entity that can be performed through the simplest actuation action in a robotic system with a single programming instruction. Elementary

actions are detected and classified as move ( $T$ ), move ( $M$ ), active pause ( $A$ ) and passive pause ( $P$ ) [13]. Once all the elementary actions have been defined, they can be organized into a suitable and efficient sequence of manipulating the movements of the robot arm’s gripper movements for reloading agro-horticultural products. In addition, they make it easy to identify instructions for programming the operation of the robot arm’s grip.

During the tests, each product was lifted from its original position, transported to the nest of the final package and released into it. In addition, another test tested the stability of the grip: the robot’s gripper grabs a tomato and moves it along a given path at maximum speed (1.0 m/s) to check if the grasped object is securely held by the robot’s gripper.

During the tests, none of the horticultural products were damaged by these handling manipulations, in accordance with Table 2 of the sample task of laboratory tests, since no signs of compression or cracks were found during visual inspection of the manipulated object, shown in Fig. 6. Limited pressing force does not allow relative movement between the horticultural products and the phalanges of the tong. The full cycle time for one operation of the «select and place» task is 2.0 seconds for a maximum path length of 1.0 m, and the maximum moment of force holding the object with the tong is 0.098 Nm.

To measure grip strength, other tests were carried out using three force sensing resistors (FSRs) that return a voltage that is related to the force acting on their sensing surface. The sensors were placed between the rigid and pliable part of the fins. The system consists of three FSR sensors [12, 13], which are connected to the Arduino Nano, and three 10 kOhm step-down resistors. To measure the power consumed by the motor, an ACS 712 power supply module was connected in series with a 6 V power supply.

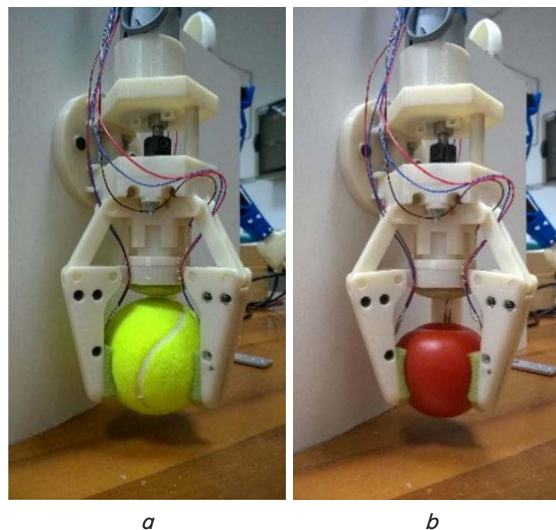

Fig. 6. Test configuration for measuring static grip strength: a – tennis ball, side view; b – ripe tomato, front view

Fig. 7–10 show the results of experimental studies of tested grippers on grip strength and energy consumption, measured by FSR sensors, for a tennis ball and a ripe tomato. The various graphs mentioned above represent the time course of the grip force measured by each sensor and the power consumption obtained by multiplying the measured current by the 6 V power supply. The time was taken from the Arduino Nano’s internal clock and is measured in milliseconds.



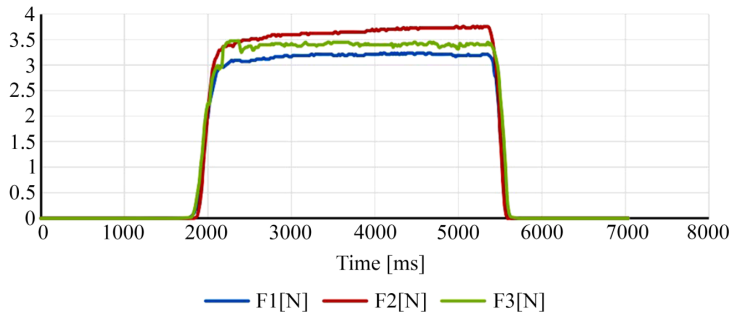

Fig. 7. Grip force test results measured by FSR sensors on a tennis ball

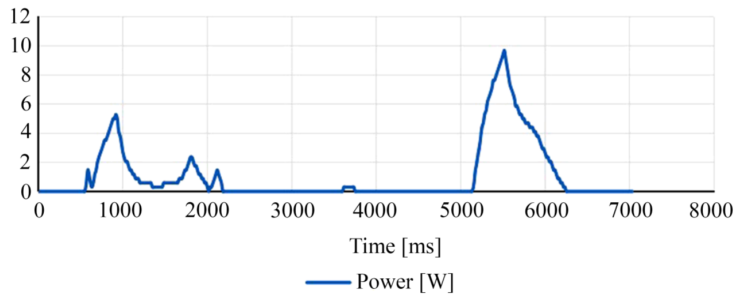

Fig. 8. Power consumption test results [W] for a tennis ball

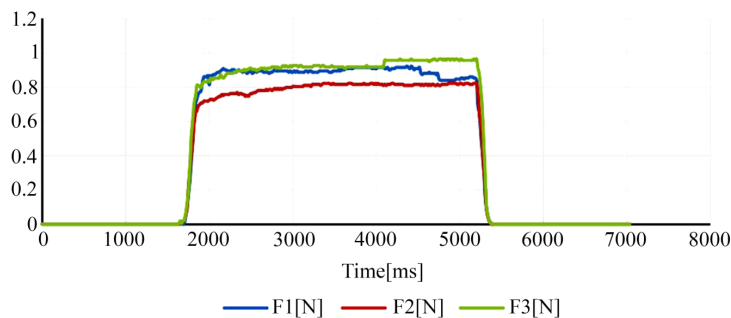

Fig. 9. Grip force test results measured by FSR sensors for ripe tomato

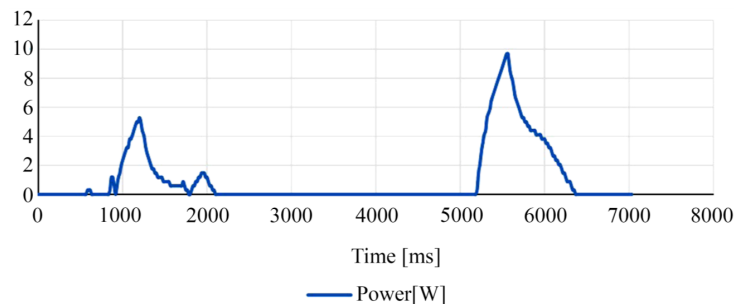

Fig. 10. Power consumption test results [W] for a ripe tomato

Fig. 7–9 show grip strength changes during the tennis ball and unripe tomato test. The shape of the function again approaches a square wave with an average grip force of 3.12 N and 0.88 N, respectively, for a tennis ball and a ripe tomato. The evolution of energy consumption is shown in Fig. 8–10 and is also similar. With a maximum power consumption of 12.8 and 9.8 W peak release, respectively, for a tennis ball and a ripe tomato.

The temporal dynamics of both the gripping force and energy consumption are almost the same in all tests performed. Therefore, it depends on the type of movement and only slightly depends on the applied gripping force. The contact

is not characterized by a peak force, since the design of the gripper uses an adaptive hydraulic drive [14, 15], which provides automatic limitation of the gripping force without damaging the outer surface of the reloaded cargo. When conducting experimental studies, errors were found between the values that were measured by three sensors in each test.

Confidence intervals were built to estimate the gripping force with a reliability of  $\gamma=0.95$ , respectively, to the overload of a tennis ball and a ripe tomato. For example, for a tennis ball with a sample size of  $n=200$ ,  $\sigma=10$ ,  $\bar{X}_s=3.12N$  and Student's coefficient  $t=1.96$ , the accuracy of estimating  $\delta$  was  $\delta=1.39$  and its confidence interval was  $(3.12N-1.39N<3.12N+1.39N)$ . Using the Pearson criterion, at a significance level of  $\alpha=0.05$ , with the number of intervals  $K$  of the distribution of the random value of the gripping force  $K=11$ ,  $\bar{X}_s=3.12N$ ,  $\sigma_s=0.49$ , by the number of degrees of freedom  $r=11-3=8$  let's define  $\chi_{observ.}^2=12.42$ . According to the table of critical distribution points, let's find  $\chi_{cr.}^2(0.05;8)=15.5$ . From a comparison of the obtained values of the critical distribution points  $\chi_{observ.}^2$  and  $\chi_{cr.}^2(0.05;8)$  the conclusion is made about the normal distribution of the general population of the studied random variable of the gripping force. From a comparison of the obtained values of the critical distribution points  $\chi_{observ.}^2$  and  $\chi_{cr.}^2(0.05;8)$  the conclusion is made about the normal distribution of the general population of the studied random variable of the gripping force.

## 6. Discussion of the scientific results on the creation of the robotic complex

The result of the solution of the first task of the study was the construction of a general concept of a robotic complex with a tong for automating the handling operations of plant microshoots having a cylindrical shape and a longitudinal annular section, shown in Fig. 6. A cylindrical shape with an annular section, for example, a micro shoot of a plant, a ripe tomato, etc., shown in Fig. 6, b.

As a result of solving the second task of the study, it was found that when designing an innovative gripper for automating the overload of plant microshoots, it is necessary to improve the accuracy of estimating the gripping force of the robotic gripper, which determines its design parameters.

Analytical dependences (1), (2) are presented for determining the maximum and minimum allowable values of the gripping force of cylindrical and spherical objects with an annular cross section, for example, a microshoot of a plant, a ripe tomato, etc. They are determined from the conditions for ensuring the reliability of gripping and the insignificance of the magnitude of elastic a gripper element with the outer surface of a reloaded object, for example, a microshoot of a plant, a ripe tomato, etc. Both for static and dynamic modes of operation of the gripper and taking into account the physical and mechanical characteristics of the reloaded object, for example, a microshoot of a plant, a tennis ball and a ripe tomato.

To ensure reliable retention of a reloaded object having a cylindrical shape and a longitudinal annular section, the most effective options for the location of the structural elements of the gripper – gripper jaws near the upper part of the plant microshoot body are substantiated. Two gripping sponges (Fig. 4, *a*), located on the inner surface of the phalanges of the gripper levers, are located on one side of the outer surface of the microshoot body area of the plant. And one gripping sponge, located on the outer inner surface of the phalanx of the gripper lever, is located near the opposite side of the outer surface of the microshoot body section of the plant. Two gripping sponges (Fig. 4, *b*) located on the outer inner surface of the phalanges of the gripper lever are located on one side of the outer surface of the microshoot body section of the plant and two gripping sponges located on the outer inner surfaces of the phalanges of the gripper lever are located near the opposite side of the outer surface of the site plant microshoot body.

As a result of solving the third problem of the study, the values of gripping forces obtained by analytical and experimental methods are refined by finding the optimal Kalman coefficient using formula (10), which is obtained by minimizing the average value of the mathematical expectation from the square of the error in determining the value of the gripping force when it interacts with an overloaded object, for example, a ripe tomato, tennis ball, etc. Then, for the refined value of the gripping force, the gripping index is determined to optimize the length values of each of its phalanges.

In the fourth task of the study, the performance of the created prototype gripper was tested for reloading objects of cylindrical and spherical shapes with an annular section, for example, a tennis ball, a ripe tomato, etc. Extensive experimental studies of the gripper during overload, for example, a ripe tomato, tennis ball, together with description of their implementation, both in static and dynamic modes of its operation, confirmed its performance. The reliability of the conducted experimental studies is confirmed by the correct results of their statistical processing.

On the basis of the research carried out, an innovative phalanx gripper of a robotic complex was created to automate the handling operations of plant microshoots during their microclonal propagation. This will automate the transfer operations of the technological process of microclonal propagation of plants using a reliable robotic complex with a simple control system with a gripper, which will significantly reduce the cost of their production. The effect of microclonal propagation of plants on an industrial scale to solve the problem of planting greenery in large cities and areas of arid territories in the Republic of Kazakhstan and other countries of the World depends on the degree of automation of the transfer of plant microshoots from the transport tank in vitro to the working tank with soil. This circumstance makes it possible to solve the problem of planting greenery in large cities and areas of arid territories of the Republic of Kazakhstan and other countries of the World in this way.

In well-known works [4, 5], the geometrical parameters of the phalanx grip are determined using the grip force index, which is directly proportional to the accuracy of estimating the grip force of the object with the grip. The value of the gripping force of the object by the gripper is determined taking into account the weight of the overloaded object and the geometry of the configuration of the links of its actuator from the condition of static equilibrium of the overloaded object during its capture. The calculated gripping force is multiplied by a safety factor called the safety coefficient.

Therefore, for designing an innovative robot gripper for reloading a plant microshoot, which has a cylindrical shape with a longitudinal annular section, the accuracy of estimating the gripping force of the robot gripper is extremely important. In the proposed method, based on the study of the capture of objects having a cylindrical and spherical shape with a longitudinal annular section, methods for calculating the maximum and minimum allowable values of the efforts to capture a plant microshoot are substantiated. Both in static and dynamic modes of operation of the tong and taking into account the physical and mechanical characteristics of the overloaded object. The values of gripping forces obtained by analytical and experimental methods are refined by finding the optimal Kalman coefficient. Then the tong grip index is determined to optimize the length values of each of its phalanges. The accuracy of estimating the value of gripping force by the proposed method is significantly higher than in known methods. The accuracy of estimating the value of gripping force by the proposed method is significantly higher than in known methods.

The conducted experimental studies have shown that the contact of the gripper with the object is not characterized by a peak force, if an adaptive hydraulic drive, for which an innovative patent has been obtained, is used in the design of the gripper prototype [15], which provides automatic limitation of the gripping force without damaging the external outer surface of the reloaded items. Due to the operation of the adaptive drive, the grip force at the time of holding, for example, a ripe tomato, is almost constant and its average value is 0.88N.

In subsequent publications, it is planned to present research materials devoted to the selection and justification of the innovative appearance of a robotic complex with a grip based on a functional and economic assessment of its functioning, and the results of experimental studies of the adaptive drive of the robot grip for automating overload operations of microclonal plant reproduction [15].

---

## 7. Conclusions

---

1. The study substantiates the functional and economic requirements for the perspective shape of the tong for transshipment operations of goods having spherical and cylindrical shapes with an annular section, for example, plant microshoot, ripe tomato, etc. grip. The general concept of a robotic complex with a phalanx gripper for reloading the asthenia microshoot during their microclonal reproduction was chosen.

2. A mathematical model is substantiated for estimating the maximum and minimum permissible values of the gripping force when gripping a thin-walled ring from the conditions for ensuring the reliability of its grip and the insignificance of elastic displacements at the points of contact of the working element of the gripper with its outer surface in the process of reloading operations and taking into account its physical and mechanical properties, characteristics. Based on these requirements for the shape of the phalangeal gripper, the structural-kinematic and geometric parameters of the phalanges of the gripper and their structural elements – gripping jaws and their installation on the upper part of the body of a reloaded object with an annular section, for example, a plant microshoot, were substantiated. The variants of the scheme of loading the gripping sponges of the phalanges of the gripper lever when they clamp a part of the plant microshoot body are substantiated. In the study, the main methods of gripping elastic and fragile objects with an annular cross section, for example, a microshoot of a plant, a ripe tomato and etc.

3. A mathematical method has been developed to increase the reliability of the assessment of the gripping force, which directly affects the accuracy of the assessment of the main parameters of the structural elements of the gripper of a robotic device, for example, its geometric parameters. The dependence of the accuracy of the assessment of the main parameters of the gripper on the value of the assessment of its gripping force has been established. During experimental studies, errors were established between the values of the grip force, which were measured by three sensors in each test. The obtained experimental data were refined by determining the Kalman coefficient, which ensured an increase in the accuracy of estimating the gripping force parameter of the robot gripper.

4. A prototype design of a three-phalanx robot gripper has been created to automate the handling operations of various objects, for example, a tennis ball, a ripe tomato, a plant microshoot. It was tested in laboratory and production conditions at the international scientific center in Cassino (Italy). Software has been developed for simulating the functioning of a remotely controlled operating prototype of a mobile robot with an adaptive gripper for overloading a plant microshoot.

On the basis of the research carried out, an innovative phalanx gripper of a robotic complex was created to automate the technological process of transshipment operations of plant microshoots during their microclonal reproduction.

The concept of building a perspective image of a controlled mobile robot with a gripper for automating reloading operations, as well as a method for improving the accuracy of estimating the geometric, structural-kinematic and dynamic parameters of an adaptive gripper, taking into account the stochastic environment of its operation, are new, are of scientific and practical interest and can be directly applied in engineering not only in the Republic of Kazakhstan, but also in other countries of the World.

The conducted studies have shown that the contact of the gripper with the object is not characterized by a peak force, if an adaptive hydraulic drive is used in the design of the prototype gripper, developed in the course of the research, which provides automatic limitation of the gripping force without damage to the outer surface of the reloaded items. Due to the operation of the adaptive drive, the grip force at the time of holding, for example, a ripe tomato, is almost constant and its average value is 0.88N.

---

#### Acknowledgments

---

This research has been/was/is funded by the Science Committee of the Ministry of Education and Science of the Republic of Kazakhstan (Grant No. AP09562257).

---

#### References

- Kakimzhanova, A., Karimova, V., Nurtaza, A. (2017). Commercialization of the technology of microclonal propagation of tree plants for industrial use for greening in cities. *Journal of Biotechnology*, 256, S107. doi: <https://doi.org/10.1016/j.jbiotec.2017.06.1166>
- Timofeev, A. V. (1988). *Adaptivnye robototekhnicheskie komplekсы*. Sankt-Peterburg: Mashinostroenie, 332. Available at: <http://roboticslib.ru/books/item/f00/s00/z0000018/index.shtml>
- Figurin, A. V. (1988). *Strukturno-parametricheskii sintez skhvatov promyshlennykh robotov*. Leningrad, 199. Available at: <https://www.dissercat.com/content/strukturno-parametricheskii-sintez-skhvatov-promyshlennykh-robotov>
- Ceccarelli, M. (2004). *Fundamentals of Mechanics of Robotic Manipulation*. Springer, 312. doi: <https://doi.org/10.1007/978-1-4020-2110-7>
- Ceccarelli, M., Rodriguez, N. E. N., Carbone, G. (2005). Design and tests of a three finger hand with 1-DOF articulated fingers. *Robotica*, 24 (2), 183–196. doi: <https://doi.org/10.1017/s0263574705002018>
- Rodríguez, F., Moreno, J. C., Sánchez, J. A., Berenguel, M. (2012). Grasping in Agriculture: State-of-the-Art and Main Characteristics. *Mechanisms and Machine Science*, 385–409. doi: [https://doi.org/10.1007/978-1-4471-4664-3\\_15](https://doi.org/10.1007/978-1-4471-4664-3_15)
- Zhu, W.-H., Piedboeuf, J.-C., Gonthier, Y. (2002). Emulation of a space robot using a hydraulic manipulator on ground. *Proceedings 2002 IEEE International Conference on Robotics and Automation (Cat. No.02CH37292)*. doi: <https://doi.org/10.1109/robot.2002.1013577>
- Petković, D., Pavlović, N. D. (2011). A New Principle of Adaptive Compliant Gripper. *Mechanisms and Machine Science*, 143–150. doi: [https://doi.org/10.1007/978-94-007-2727-4\\_13](https://doi.org/10.1007/978-94-007-2727-4_13)
- Zareinia, K., Sepehri, N. (2015). A Hybrid Haptic Sensation for Teleoperation of Hydraulic Manipulators. *Journal of Dynamic Systems, Measurement, and Control*, 137 (9). doi: <https://doi.org/10.1115/1.4030337>
- Ivanov, K. S. (2013). Creation of Adaptive-Mechanical Continuously Variable Transmission. *Applied Mechanics and Materials*, 436, 63–70. doi: <https://doi.org/10.4028/www.scientific.net/amm.436.63>
- Kaiym, T. T., Gribanov, V. F., Temirbekov, E. S., Kaimov, S. T., Kaimov, Ab. T., Kaimov, A. T. et. al. (2017). The modeling of the theoretical and mathematical system and specifically the stochastic processes of the dynamical system an innovative mechanism for grasping of the robot for overloading the highly radioactive firm waste of fuel element from the secondary container into the main container. *News of the National Academy of Sciences of the Republic of Kazakhstan, Series of Geology and Technical Sciences*, 2 (422), 157–174. Available at: <http://rmebrk.kz/journals/3434/2454.pdf>
- Temirbekov, E. S., Kaiym, T. T., Ceccarelli, M., Bostanov, B. O., Kaimov, S. T., Kaimov, A. T. (2018). Grasps of Robot Manipulator When Overloading Solid High-Radioactive Elements and Their Calculation. *Advances in Italian Mechanism Science*, 316–323. doi: [https://doi.org/10.1007/978-3-030-03320-0\\_34](https://doi.org/10.1007/978-3-030-03320-0_34)
- Kaimov, S., Kaimov, A. T., Kaimov, A. T., Ceccarelli, M., Kaiym, T., Kaimova, G. et. al. (2018). A Gripper Mechanism to Automate Overload Process for Fuel Elements. *Mechanisms and Machine Science*, 118–128. doi: [https://doi.org/10.1007/978-3-030-00365-4\\_15](https://doi.org/10.1007/978-3-030-00365-4_15)
- Kaimov, S., Kaimov, A. (2020). Pat. No. 35040 KZ. Auto speed transmission. No. 2020/0153.1; declared: 04.03.2020; published: 30.04.2021. Available at: [https://drive.google.com/file/d/1BLgY-qRL\\_yDLZ\\_0hqvR4y67RUQq99cT6/view?usp=sharing](https://drive.google.com/file/d/1BLgY-qRL_yDLZ_0hqvR4y67RUQq99cT6/view?usp=sharing)
- Kaimov, S., Kaimov, A. (2021). Pat. No. 6839 KZ. Adaptive robotic gripper. No. 2021/0999.2; declared: 22.10.2021; published: 04.02.2022. Available at: <https://drive.google.com/file/d/107rKdMlx3qDLO2E5eaXdf81oL8x8CtWb/view?usp=sharing>