

Cymatic Bricolage:
Visualizing everyday aural experience

by

Sean Procyk

A thesis exhibition & supporting paper presented to the
OCAD University
in partial fulfillment of the requirements
for the degree of
Master's of Fine Arts
In
The Interdisciplinary Master's of Art, Media and Design Program

Function 13,
156 Augusta Avenue,
Toronto, Ontario, Canada
June 24 to July 3, 2010

 Sean Procyk 2010

This document is licensed under the Creative Commons
Attribution-Noncommercial-No Derivative Works 3.0 Canada License

To see the license go to

<http://creativecommons.org/licenses/by-nc-nd/3.0/>

or go to Creative Commons, 171 Second Street, Suite 300,
San Francisco, California 94105, USA

Copyright Notice

You are free to:

 To share — To copy, distribute and transmit the work

Under the following conditions:

 Attribution — You must attribute the work in the manner specified by the author or licensor (but not in any way that suggests that they endorse you or your use of the work).

 Noncommercial — You may not use this work for commercial purposes.

 No Derivative Works — You may not alter, transform, or build upon this work.

With the understanding that:

Waiver — Any of the above conditions can be waived if you get permission from the copyright holder.

Public Domain — Where the work or any of its elements is in the public domain under applicable law, that status is in no way affected by the license.

Other Rights — In no way are any of the following rights affected by the license:

- Your fair dealing or fair use rights, or other applicable copyright exceptions and limitations;
- The author's moral rights;
- Rights other persons may have either in the work itself or in how the work is used, such as publicity or privacy rights.

Notice — For any reuse or distribution, you must make clear to others the license terms of this work. The best way to do this is with a link to this web page.

Author's Declaration

I hereby declare that I am the sole author of this thesis.

This true copy of the thesis, including any required final revisions, as accepted by my examiners.

I authorize OCAD University to lend this to other institutions or individuals for the purpose of scholarly research.

I understand that my thesis may be made electronically to the public.

I further authorize the Ontario College of Art & Design to reproduce this thesis by photocopying or by other means, or in part, at the request of other institutions or individuals purpose of scholarly research.

Signature _____

Cymatic Bricolage: Visualizing everyday aural experience
By Sean Procyk

Interdisciplinary Master's of Art, Media and Design
MFA 2010
OCAD University

Abstract

Historically, the sound of an object or material was rarely considered by its maker unless it was intended to be acoustic by design. As a result, the contemporary environment is made up of unintentional aural byproducts. *Cymatic Bricolage* is an interdisciplinary method that investigates this notion of unplanned aural experience by re-contextualizing discarded objects as soniferous. In the exhibition of this work sounds are visualized to create an immersive audiovisual experience reflecting my experience of being exposed to an environment that periodically produces physical waste and is characterized by unintentional acoustic spaces. It builds upon the traditional Cymatic Method, developed by Hans Jenny between 1965 and 1975, by using physical and aural cultural byproducts to establish a relationship between sight and sound.

Dedication

To the ear, for the eye.

Table of Contents

List of Figures	vii
Preface	viii
 <u>PART ONE: Introduction</u>	
Mapping the Research	1
Research Questions	2
 <u>PART TWO: From Assemblage to Unintentional Aural Experience</u>	
Bricolage	3
Aural Bricolage	4
Visually Constructed Sounds	5
Practice – Making – Sounds	6
 <u>PART THREE: Seeing Sound</u>	
Quantifying Acoustic Experiences	10
Experience of Visualized Sound: A Brief History	10
The Traditional Cymatic Method	12
Cymatics and Perception	14
Contemporary Cymatic Research	15
Extending Cymatics Through Bricolage	16
 <u>PART FOUR: Cymatic Bricolage</u>	
Developing the Method	18
Installation	21
 <u>PART FIVE: Contributions</u>	
Conclusions	27
Future Research	28
Postscript	29
 Bibliography	 30
Appendix A: Arduino Code	31
Appendix B: Accompanying Material	35

List of Figures

Figure:	Title:	pp.
1	Untitled digital photography	6
2	Concept sketch for <i>Saw IV</i> & <i>Saw IV</i>	7
3	Flat-lined sound studies	9
4	Illustration of the traditional Cymatic Method	13
5	<i>Ondulation</i> (Thomas McIntosh)	16
6	Periodic Illustration	17
7	<i>Sound projector</i>	19
8	<i>The center for wave phenomenology</i>	20
9	<i>Alchemy of bricolage</i>	21
10	Construction drawing for <i>The Fan</i>	23
11	Construction drawing for <i>The Vent</i>	24
12	Audiovisual effect of <i>The Fan</i> (static)	26
13	Audiovisual effect of <i>The Vent</i> (static)	26

All images were produced by the artist, except where specified.

Preface

I have always been drawn to multi-sensorial experiences where the distinction between aural and visual phenomena is blurred. The earliest memory I have of this type of experience is playing a toy xylophone with colored keys. At the time I believed the notes it produced corresponded to the color of each key. The mallet for striking the keys was black. I understood intuitively that black did not have a sound, which is why it could be used for making coloured things sound. Over the years, this primary experience of linked colour and sound evolved into my interest for exploring conditions where the visual and aural come together, which naturally led me to venues where I could see music being performed. Multi-media musical performance introduced me to a whole new type of aural experience that was enhanced by the effects of lighting in space. Repeated exposure to this type of immersive experience drove me to integrate audio-visual explorations with my practice.

While enrolled in a Bachelor of Architectural Studies program at Carleton University I explored the relationship between architecture and music.¹ Due to the requirements of an architecture program my work was directed towards the visual and built physical form, so the aural aspects were never privileged in the design process, and hence never fully investigated in my undergraduate work. One of my objectives for doing a Master's of Fine Arts in the Interdisciplinary Master's of Art, Media and Design program was to explore and develop an interdisciplinary methodology that would allow me to incorporate sound and its visualization with my construction-based practice.

¹ I perceive architecture as the design of physical materials in space, while music is the design of aural events in time.

In his book *Our Sonic Environment and the Soundscape: The Tuning of the World* (1977), the Canadian composer R. Murray Schafer stated that, “all visual representations of sound are arbitrary and fictitious” (Schafer, 127). By this he meant that any representation of sound is shaped by the individual(s) who develop it. *Cymatic Bricolage* creates a visualization of sound built in response to my previous architectural practice, my awareness of multi-sensorial experience and my emerging interest in sound. This thesis research uses an interdisciplinary method that combines elements from disparate art and design practices¹ to create an audiovisual experience that enhances existing aural conditions of an environment. The sounds in the installation are visualized using the Cymatic Method, which was developed between 1965 and 1975 by Swiss scientist Hans Jenny. In his research, Jenny used speakers that were connected to a frequency generator to vibrate physical materials, such as water and flour. Following this experimental procedure he observed that liquid and powder materials will move in response to sound, creating a direct link between visual and aural phenomena. One objective of this thesis project is to build on the traditional Cymatic Method by using it to establish an audiovisual experience in response to the sounds of the gallery where it is installed. In the final installation the sound of ventilation and its turbulent air flow are used to produce Cymatic effects in water. Another objective of this investigation aims to open up contemporary Cymatic research to interdisciplinary art and aural design practices that visualize sound.

¹ such as physical construction, light art, sound art, electronics and computer programming

The physical and aural aspects of this installation were determined by the incidental discovery of found objects and my exposure to poorly planned acoustic environments. According to Michel De Certeau in *The Practice of Everyday Life* (1988), this approach to making, which is “dependent upon the possibilities offered by circumstance,” is a form of bricolage (De Certeau, 29). In the context of visualizing sound, I use the bricolage method to “make do” with discarded objects and materials by diverting their intended order (30). By combining the Cymatic and Bricolage methods I am exploring the possibility of re-contextualizing found objects as sound producing objects and using them to construct an audiovisual experience. This thesis paper investigates the significance of this notion by considering the role of sound in architecture and industrial design within the context of an interdisciplinary practice of art, media and design.

Research Questions

There are two research questions that form the basis of this thesis investigation. The first question, which is meant to promote exploration and development of the *Cymatic Bricolage* method, asks; *how can an audio-visual experience be created using discarded objects and materials?*

The second question is a response to the objective of creating an experience where sound is visualized. It asks; *how can the aural experience of an environment be enhanced through the visualization of its sounds?*

Bricolage PART TWO: From Assemblage to Unintentional Aural Experience

I see the urban environment as a landscape of obsolete cultural artifacts, many of which could be functional with minor repairs or could be remade into something entirely different. Trash is an endless resource for material, which is also a source of inspiration that moves my studio practice in unanticipated directions. My approach to building has always been informed by the experience of finding materials, which instigate intuitive forms of constructing, such as assemblage. In *Assemblage, Bricolage and the Practice of Everyday Life* (2008) Anna Dezeuze describes Bricolage as a, “do-it-yourself process of constructing objects from odds and ends”, which in the context of visual arts, can take the form of assemblage and the construction of environments (Dezeuze, 31). Dezeuze quotes William Seitz in *The Art of Assemblage* to expand the definition of bricolage to “the fitting together of [heterogeneous] parts and pieces” (Quoted in Dezeuze, 31). The work included in the thesis installation was realized through a similar bricolage process where discarded physical materials were combined with digital and electronic forms of media, such as pre-recorded sounds, digitally projected images and electronically controlled lights. For this thesis project I combined some of these elements for the first time, which extended my Bricolage practice from object-based juxtaposition to multi-media assemblage. I called these process-based explorations *Mediassemblage* because they brought together disparate elements of art and design practice, such as physical construction, assemblage, light art, sound art, electronics and computer programming. Using this interdisciplinary approach to assemblage I explored the possibility of reinterpreting and reinventing discarded objects to produce audio-visual effects.

Aural Bricolage

A similar aural perspective for reimagining the environment is offered by R. Murray Schafer when he asks the reader to "... regard the soundscape of the world as a huge musical composition, unfolding around us ceaselessly. We are simultaneously its audience, its performers and its composers..." (Schafer, 205).² This notion of a "universal concert" was identified by Schafer in response to his research that mapped changes to the Western aural environment as it developed throughout history (206). His main observation was that, "the world suffers from an overpopulation of sounds; [where] there is so much acoustic information that little of it can emerge with clarity." (71) On a daily basis we are subjected to a cacophony of unnecessary sounds, such as the drone of building ventilation systems, the hum of computer processors and the buzzing of electric lights. Schafer's research reveals that sounds of this nature originated during the industrial and electric revolutions as mechanical technologies began to pick up speed (88). A similar observation is made by Barry Blesser and Linda-Ruth Salter in their book *Spaces Speak, are you listening?* (2007). Blesser and Salter point out that, "with efficient manufacturing and distribution of mechanical goods, individuals readily acquired the means for contributing yet more noise to the public soundscape" (Blesser and Salter, 108). The research of Schafer, Blesser and Salter shows that the contemporary aural environment is littered with byproducts from the physically constructed environment.

² Schafer uses the term "soundscape" to describe the invisible landscape of sound that makes up the aural experience of an environment.

Visually Constructed Sounds

The phenomena of aural byproducts made me more sensitive to sounds while working with discarded objects. Considering the aural effects produced by these objects directed this investigation towards exploring the role of sound in contemporary design practices. In the book *Sound in Design* (1999), Jens Bernsen states that in Industrial Design, “the operational sound [of a product] is a consequence of construction. It is rarely a sound that is built into the product on purpose.” (Bernsen, 47) The media theorist Derrick De Kerckhove also identifies this issue in *The Skin of Culture* (2005), stating that, “we design things to look pleasing but we usually do not bother to make them sound pleasing.” (De Kerckhove, 100) These two contemporary theorists argue that we overlook the experience of sound in design. By introducing new products to a society we also introduce new sounds, creating an environment made up of unintentional aural byproducts (Bernsen, 47).

The root of the problem, according to Blesser and Salter is that, “our modern technological society tends to devalue hearing ... preferring sight as the principal means for sensing the environment” (Blesser and Salter, 361). They specifically argue that we do not consider the aural and tactile as much as the visual aspects when creating architectural space.³ Jens Bernsen also identifies a lack of aural consideration in the design of products when he states that, “sight dominates man’s sensory experience of the world. What we experience by means of the other four senses has a less determining influence” (Bernsen, 7). The literature on aural experience within the built physical environment suggests that we suppress our sense of hearing by allowing sight to dominate. This perceptual bias has created an environment of unintentional soniferous objects and space that characterizes Schafer’s proposed universal concert.

³ As someone who has gone through architectural education I strongly agree with this statement. In my four years of architectural education the issue of acoustics rarely, if ever came up during lessons.

Practice – Making – Sounds

Considering the issue of unintentional aural experience I expanded my bricolage practice to include the use of discarded soniferous objects. This influenced a series of video and sound recordings that illustrate a gradual shift in my practice from the exclusively physical to the audiovisual. The set of images in figure 1 capture a silhouette of me intuitively combing found objects into different arrangements to investigate possible connections between them. During this exploration my workspace was situated in front of an 8' x 4' screen upon which I projected concert footage from Nine Inch Nails' *Lights in the Sky Tour* (2007). The presence of this concert footage shows my early attempt to create an immersive audiovisual experience in collaboration with my physical practice. This documentation also demonstrates the influence that multi-sensorial musical performance has on my process of working.

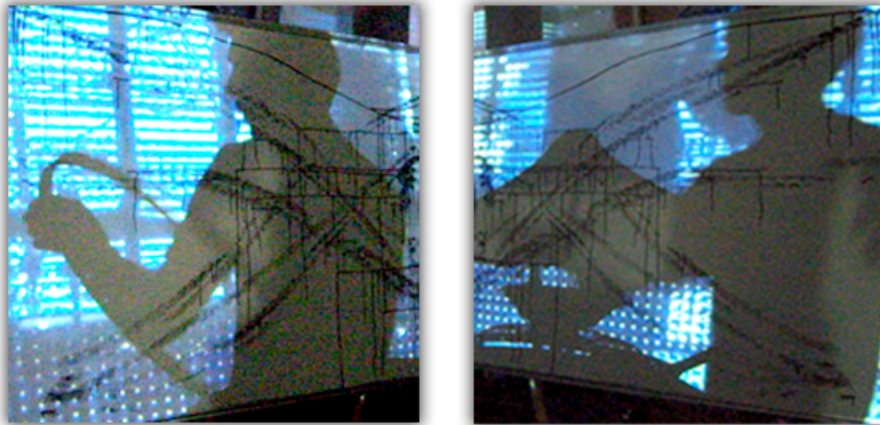

Figure 1: untitled digital photography, mediaassemblage, 2009

In these photos my figure is collaged with the video footage from Nine Inch Nails' Lights in the Sky tour. The lighting effects from this performance were created from a matrix of high-powered LED's. In the final installation of this thesis project I make use of the same blue LEDs to create an immersive audio-visual experience.

The second iteration of this audiovisual investigation focused the practical research more towards the issue of unintentional sounds discussed by Schafer, Bernsen, De Kerkove, Blesser and Salter. Working in OCAD's fabrication studios, I began considering the contribution that tools and the process of construction have on Shafer's universal concert. Using video and sound recording I focused on highlighting sounds made during the process of working with tools, such as the drill press, plastics lathe, table saw and a stone saw. An iteration of this exploration was shown in *bricoscope*, an exhibition I did in collaboration with Danielle Bleackley during the Fall of 2009 (Fig. 2). The piece consisted of a computer monitor and speakers placed within a wooden box built from discarded plywood. Video and sound documentation shown in the piece were of the box being built, which established a connection between the physical object, its process of construction and the sound of this process.

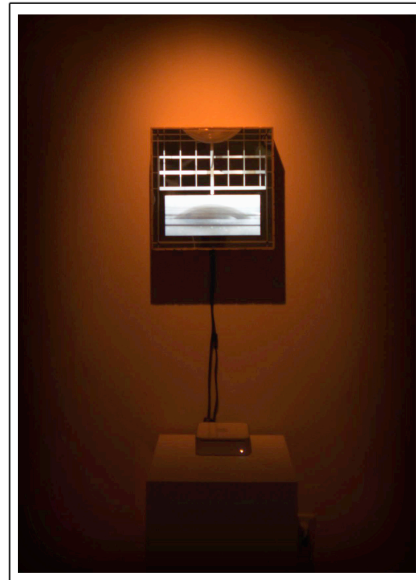
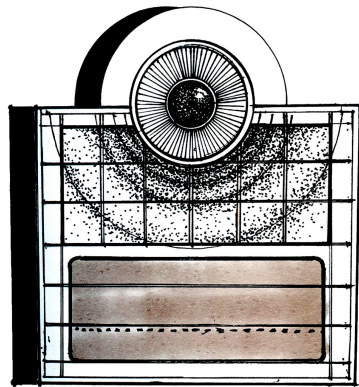

Figure 2: image left: concept sketch for *Saw IV*, image right: *Saw IV*, reclaimed plywood, computer monitor, acrylic polymer, 2009

For the final thesis installation and exhibition I chose to emphasize the unintentional sound of ventilation, in response to two circumstances that unfolded during my time at OCAD. The first was the discovery of five metal ventilation grates that were discarded after OCAD renovated the 6th floor of 205 Richmond Street. I was drawn to these objects because of their grid aesthetic, which referenced the mapping or graphing of sound for me. During my preliminary material explorations one of these grates was turned into light box, which I used for testing Cymatic effects for the final installation. This piece is discussed in more detail in the *Installation* section of this paper.

The second circumstance that led me to use ventilation as the subject matter for the thesis exhibition was my daily exposure to the almost subsonic drone that can be heard in the lobby of OCAD's building at 100 McCaul Street. Initially I was irritated by this ever present hum, but was able to temporarily filter it out from my conscious experience. I was reintroduced to the ventilation sound when it extended itself into the audio recordings I made in the fabrication workshops. Figure 3 illustrates the four sound visualizations that I recorded while investigating the relationship between constructing and the sounds produced by tools. The four recordings were blanketed by the hum of air ventilation, which I tried to remove in Adobe Audition.⁴ After working with sound as a two dimensional representation in the computer software, I felt that it had no connection to my actual aural experience. Part Three of this paper identifies possible reasons why the graphic method for visualizing sound had this affect on me.

⁴ Adobe Audition is a computer software for editing sound.

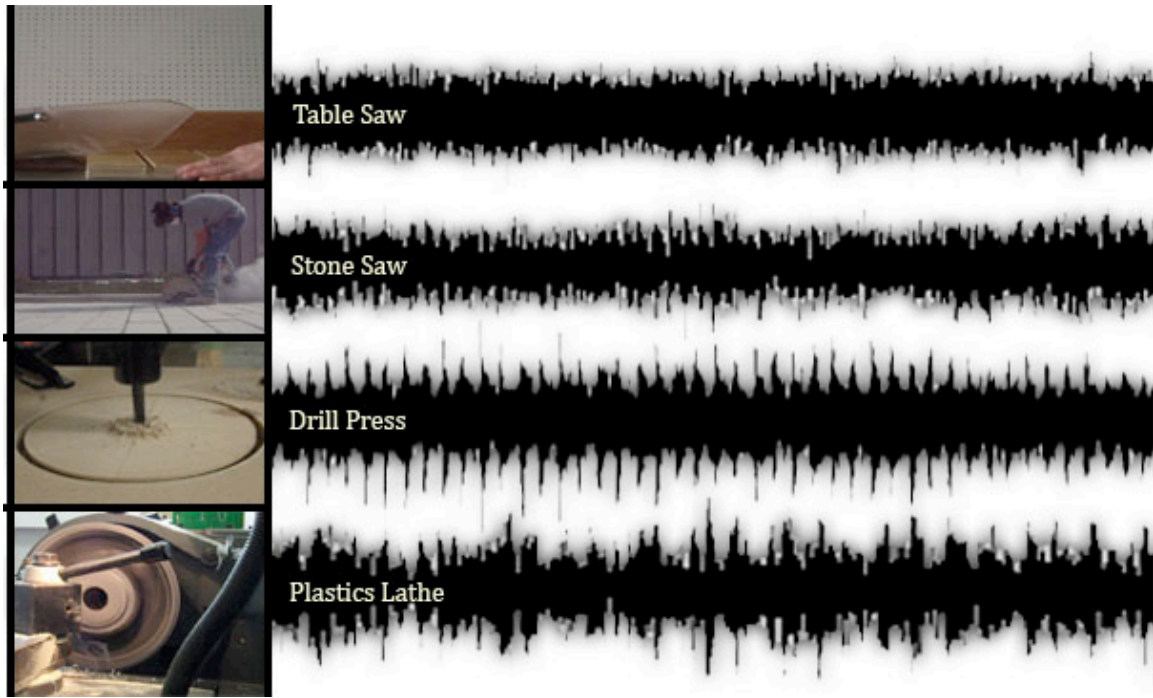

Figure 3: flat-lined sound studies, visualized in Adobe Audition, 2009

Schafer calls this type of sound wave profile `flat-lined` because it lacks any sense of duration or progression and appears as a flat-line when visualized graphically. These graphical representations, produced by the sound of a drill press, table saw, lathe and stone saw, maintain fairly consistent amplitudes when factors in the physical process remain unchanged.

As a result of the aforementioned circumstances, the first thing that captured my attention while visiting Function 13, the exhibition space for my thesis show, was the physical presence of duct work and the sound of ventilation in the space. In response to this I built an audio-visual experiences that emphasizes the unintentional sound of ventilation. To locate the materials for building the installation I spoke with one of OCAD`s facilities managers who informed me of more renovations taking place at the building on Richmond Street. From the demolition we were able to salvage about 12 feet of round duct work, which completed the physical collection of materials for this thesis project.

By situating the aural aspect of my audiovisual research in the realm of unintentional aural experience, I am revisiting the issue that established the use of graphic visualization for acoustic research. Blesser and Salter point out that the graphic approach for visualizing sound developed with the formation of acoustic engineering, which developed in response, “to the perceived need for taming the pervasive noise in public streets and private offices” (Blesser and Salter, 108). This method, which is used by acousticians, is based on quantitative data and appears as a graph of measurable variables. Schafer sees this as problematic because, “the standard acoustic diagram ... may not correspond at all with the natural instincts of aural perception” (Schafer, 125). In other words, graphic visualizations of sound offer little information about our actual qualitative experience of sound. Blesser and Salter frame this notion in contemporary architectural research by stating that, “the literature is relatively silent on the subject of how people experience aural space. We know much about measuring acoustic processes and sensory detection, but less about the phenomenology of aural space” (Blesser and Salter, 12). Schafer, Blesser and Salter agree that an experiential method for visualizing sound is lacking in the field of aural research, which suggests an opportunity to explore an alternative method for visualizing sound beyond the scope of methods used by traditional sound researchers.

Experience of Visualized Sound: A Brief History⁵

Historically, more imaginative approaches for visualization of sound took place in art and science. In the visual arts, artists began by exploring how painting could be used to interpret the

⁵ While doing this research I discovered many discrepancies related to the dates and the inventors of certain artistic styles and sound visualization instruments. I would like to acknowledge that I am aware that there may be minor inconsistencies between sources and have done my best to provide an accurate lineage of the developments in visual sound in art and science. The history of sound visualization is beyond the scope of this thesis paper and would be the subject of a completely separate research paper.

movement of sound and music on the canvas. Working in this way artists like Wassily Kandinsky, Frantisek Kupka and Oskar Kokoschka used color and form as analogy to musical notes and structures (Brougher et al, 16). These artists, especially Kandinsky, were driven by a desire to create “an art based upon multi-sensorial aesthetic experience,” although this was never fully achieved due to the limitations of paint and canvas (34). As the desire to depict music persisted into the 20th Century, new forms of media were used for visualizing sound, opening it up to practices like light art, which naturally lent itself to installation, photography and abstract cinema.

In the realm of science, sound visualization was explored through the invention of audiovisual instruments that established a relationship between musical harmony and colour theory. For example Louis Bertrand Castel, who invented the first Color Organ in 1734, achieved this by projecting coloured light into space in response to music. From the late 16th century to early 20th century there were multiple prototypes designed to perform this function. Two other significant developments in this type of instrumentation are the Clavier a Lumieres conceived by Alexander Scriabin in 1915 and the series of Kinetic Light Machines patented by Stanton MacDonald-Wright and Morgan Russell between 1945 and 1950. When these sound visualization inventions gained popularity they were exhibited in concert halls, which created a form of entertainment that combined aspects of visual arts, scientific inquiry and theater performance. In the late 20th century, new sound and lighting technologies allowed explorations in art and science to reach a common ground through multimedia musical performance (71). Sound visualization in art and science created a legacy of cross-disciplinary explorations that transcended stylistic boundaries and spawned the birth of hybrid genres of art.

Cymatic Bricolage contributes to this field of cross-disciplinary exploration by using elements of physical construction, light art, electronics, assemblage, computer programming and sonic art to visualize sound. This thesis project gets its interdisciplinary character through the combination of these different practices and their media, which I use to create an immersive

experience where the sounds of an environment become enhanced through their visualization. This thesis project builds on the previous sound visualization research by using discarded materials and unintentional aural byproducts to establish the connection between visual and aural phenomena. The aural experience in the thesis exhibition is created by the sound of a fan, while the visual experience is established by water moving in response to the air. The audiovisual connection is made explicit using sound amplification and projection of blue light through water.⁶

The Traditional Cymatic Method

Cymatics is the only method that allows me to use discarded soniferous objects for producing audiovisual effects without reducing sound to a quantitative, visual representation. According to Hans Jenny, the Cymatic Method creates, “a visual experience which can be fully equated to the aural experience”, where physical materials move in response to a vibrating speaker (Jenny 1967, 63). The traditional Cymatic experimental procedure reveals three general components that enable the direct connection between aural and visual phenomena (fig. 4). The first component is a *Frequency Generator*, which Jenny used to produce variable frequencies of sound that could be altered during an experiment. The next component uses a *Transducer* that oscillates in response to the particular frequency generated. Jenny used piezo-electric plates and speakers as transducers. Finally a *Medium* is required to render invisible vibrations visible, thus revealing the periodic nature of that set of experimental conditions. Liquid and particulate materials were the primary media used in Jenny’s experiments. By using the Cymatic Method to create a multi-sensorial environment, my work suggests that Cymatics can reintegrate audio-visual experience within contemporary interdisciplinary art & design practices that visualize both intentional and unintentional aural environments.

⁶ In this work I applied blue light as a way of colour coding the results, allowing me to easily identify it from documentation of my previous sound visualization explorations. My previous sound visualization explorations and their colours are discussed in Part Four of this paper.

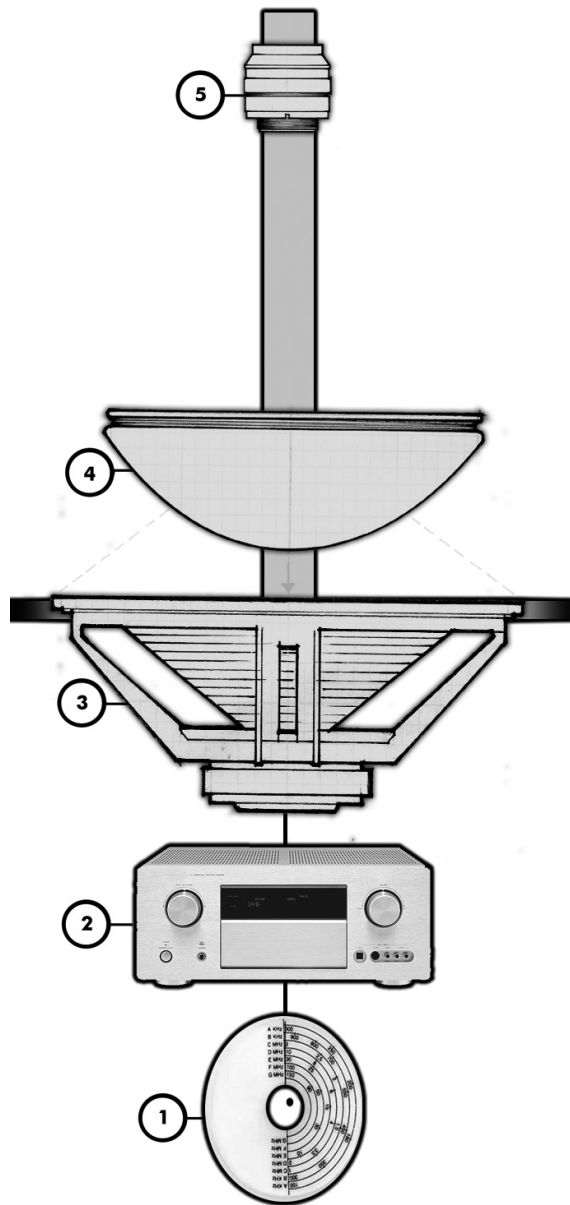

Figure 4: Illustration of the traditional Cymatic Method employing the *FTM Formula*

Components; 1.Frequency Generator (F), 2.Amplifier, 3.Transducer (T), 4.Container to hold the medium being vibrated (M), 5.Viewing apparatus

Cymatics and Perception

The direct relationship between what is seen and what is heard is essential to the Cymatic method and is emphasized by Jenny in the following statement:

In attempting to observe the phenomena of vibration, one repeatedly feels a spontaneous urge to make the processes visible and to provide ocular evidence of their nature. For it is obvious that, by virtue of abundance, clarity, and conscious nature of the information communicated by the eye, our mode of observation must be visual ... the sense of hearing cannot attain that clarity of consciousness which is native to that of sight ... It is not surprising then, that workers in experimental acoustics should have striven to make this phenomena visible during important periods of the development of science. (Jenny 1967, 21)

Jenny suggests that our understanding of sound is enhanced through its visualization, which brings into question the very nature of human perception and its effect in shaping our experience. In the *Global Village* (1989), Marshal McLuhan describes two modes of human perception that shape our understanding of the surrounding environment. According to McLuhan, we gather information from “visual space” and “acoustic space” (McLuhan, 35). He describes visual space as a mode of perceiving the world where information seems to be separate from the observer. By isolating external stimuli from the observer, vision creates a space of exclusion where only one thing can be experienced at a time. McLuhan argues that this is responsible for the sequential logic which characterizes Western thought. He explains that, “Western culture has been mesmerized by a picture of the universe as a limited container in which all things are arranged according to the vanishing point, in linear geometric order” (36). The tendency to quantify experience can be seen in the two-dimensional method for visualizing sound, where by the spectrum of audible frequency is separated into individual, measurable bands for graphing. Acoustic space, on the other hand, has no central focus and can be heard and felt everywhere, which permits the simultaneous experience of multiple sensations. This interplay between sensory phenomena experienced through acoustic space opens up the possibility for multi-sensorial experience, which is one of the key objectives of this thesis.

Contemporary Cymatic Research

The dominance of visual perception was recognized by Jenny and he improved aural visualization using the Cymatic Method. The video and photographic documentation that Jenny contributed to the field of Cymatics created a methodological benchmark that researchers continue to use almost 40 years later. To my knowledge, in the time since Jenny's research became public no alternative methods for producing Cymatic results have been used. Contemporary Cymatic researchers continue to improve the method using newer sound, video and photographic technology to either produce or document Cymatic effects. For example in 2002, German photographer Alexander Lauterwasser published *Wasser Klang Bilde*,⁷ which is a book that documents his Cymatic experiments. His high quality photographs provide a more detailed look at Cymatic effects by highlighting the topographical shapes formed by vibration (Wasser-Klang-Bilder Website). Improvement on traditional Cymatic instrumentation has also been made by English acoustic engineer John Stuart Reid, who is considered a pioneer in the field of contemporary Cymatic research. His major contribution is the first ever patented Cymatic instrument, which he calls the "Cymascope" ("Cymascope" Website).⁸

Beyond traditional scientific Cymatic research there are a few creative practitioners applying the method to areas such as fine arts and multi-media musical performance, although there appears to be little to no information published on these practices. My thesis project aims to open this area of research and discourse to the disparate field of aural research that visualizes sound. One artist working in this way is Thomas McIntosh, whose piece *Ondulation* (2002-2010) is an immersive Cymatic experience. The installation is a large rectangular basin of water that vibrates to sound. The water vibrations are then projected onto the walls of the space using light

⁷ translates to "Water Sound Images"

⁸ John Stuart Reid's website is an excellent gateway to the field of Cymatics. It offers a history of Cymatics and Cymatic-related inquiries, while providing a comprehensive map of the contemporary field. I encourage readers who are interested in learning more about Cymatics to visit his site for further information.

(Fig. 5). According to McIntosh, “the simultaneity of sensory experiences presented by *Ondulation* provokes an intriguing paradox of perception” that “invites reflection on the underlying conditions of perception itself” (“Undefine” Website). Although McIntosh does not explicitly state it in the description of the piece, *Ondulation* explores the relationship between visual and acoustic space that McLuhan theorized. My project builds on McIntosh’s immersive audio-visual experience within the context of an art gallery by considering how discarded objects and unintentional aural byproducts can be used to create the affects.

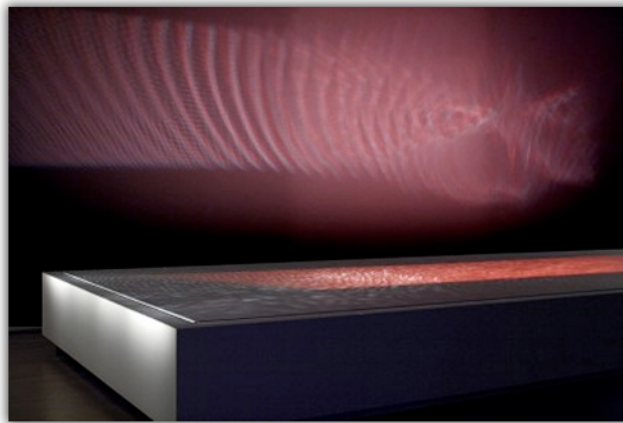

Figure 5: *Ondulation*, Thomas McIntosh, 2002-2010 (“Undefine” Website)

Extending Cymatics Through Bricolage

The aforementioned contemporary researchers employing the Cymatic Method continue to use sound drivers, such as speakers, to produce vibration when Jenny specifically stated that, “the phenomena of vibrational effects and waves can be visualized in a variety of ways” (Jenny, 11). In actual fact it is periodic phenomena that are the focus of Cymatics (Fig. 6). which means that the research may include, “the whole scope of morphology and physiology, biology and histology” as well as, “the vast spectrum extending from gamma radiation, through the ultraviolet

and visible light to infrared (heat rays), to electric waves (microwaves and radio waves)” (Jenny, 18). In this statement Jenny proposes an enormous field of periodic exploration, all of which fall under the title of Cymatic research. I use this as an opportunity to adapt the Cymatic Method by applying it to the constructed environment, which is an area Jenny may not have considered. In this thesis project the Cymatic Method is expanded through bricolage by using discarded objects and unintentional sounds to generate audiovisual effects. More specifically, *Cymatic Bricolage* reconsiders discarded soniferous objects as transducers in the *Frequency Generator, Transducer, and Medium* (FTM) formula (as shown in fig. 4) for producing Cymatic effects.

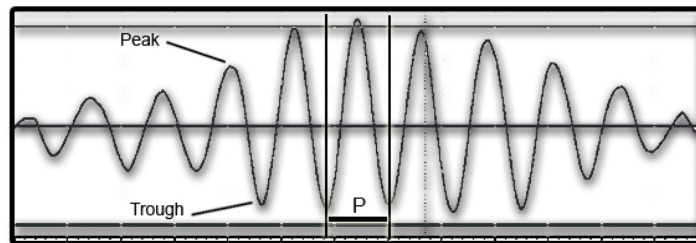

Figure 6: Periodic Illustration

Hans Jenny defines periodic processes as systems that “show a continually repeated change from one set of conditions to another, opposite set” (Jenny, 17). The period (P) in this illustration is the length of time it takes for one peak / trough / peak cycle to take place. This is a representation taken from a snippet of sound produced by an electric fan and visualized using Adobe Audition.

For the installation I used the periodic motion of a fan, which emits a sound when in motion, to excite the surface of the medium water. The fan produces a turbulent air flow which makes a turbulent pattern in the water instead of a periodic waveform. The speed (frequency) of this fan is generated by the position of a viewer in relation to a proximity sensor in the space. The closer the viewer gets to this sensor, the faster the fan will blow. A blue light illuminates the container of water, projecting its movement into the gallery space. To emphasize the relation

between the sound of ventilation and its visual effect on the water I amplified a fan using a piezo-electric contact microphone. Applying the Cymatic method in this way builds upon traditional Cymatic research through the use of an alternative mode of transduction, which makes aural phenomena visible.

Developing the Method

PART FOUR: Cymatic Bricolage

There are three projects that informed my methodology of merging the Cymatic and bricolage methods.⁹ Each project used one colour of light, which I chose to aid the process of identifying and classifying the documented audiovisual effects. The first project began with an exploration based on the observation that some speakers have tuned ports for air to escape (fig. 7). The air is most noticeable when notes from the lower frequency of audible sound are played through the speaker. Based on this phenomenon I saw potential to create physical movement, which would establish an analogue relationship between sound and vision. For this project I built a subwoofer and lined its port with reflective mylar. When the sound driver vibrated to a low frequency air was pushed out of the hole, vibrating the reflective mylar. By placing a white light inside the speaker box, I was able to project that vibration into the space. I highlighted this dynamic reflection of light by building a screen for its projection. The prototype is significant to this thesis for two reasons: first, it identifies my first attempt at building an instrument used to explore the relationship between sound and light. Second, this piece was built entirely from discarded materials.

⁹ The first two projects were undertaken prior to this Master's research and do not form a part of this thesis, but are given as background and context for this research.

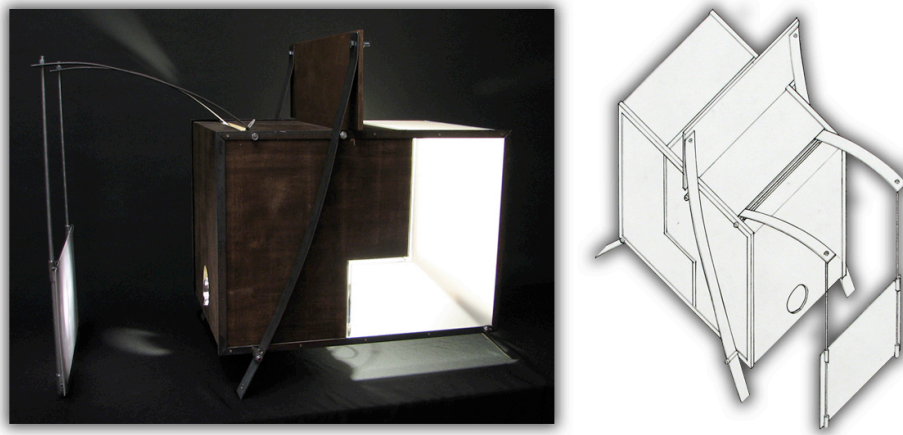

Figure 7: *sound projector*, reclaimed wood, acrylic polymer, metal, light, subwoofer, 2006

The second significant exploration took a different approach that used sound to create movement in water. Figure 8 shows a prototype that was built by converting the form of an existing subwoofer into a water tank. The subwoofer itself was acquired from a second-hand store, while the materials for the water tank and speaker casing were salvaged. To build the water tank, I vacuum formed a piece of 1/8" opaque acrylic polymer. The center of the plastic form had a circular depression in it, which was dimensioned to fit a circular mirror. By placing a mirror in the center of this tank then filling it with water, my objective was to project the water vibrations out of the tank and into the surrounding environment using red light. I tested multiple light sources and found that the vibrations were most apparent when using a single point light source. I chose the green laser because it was the strongest single point light source I had access to. I performed the experiments by projecting the water vibrations onto the walls and ceiling of the space. This experiment demonstrates my first attempt at creating an instrument and an environment for observing sound vibration.

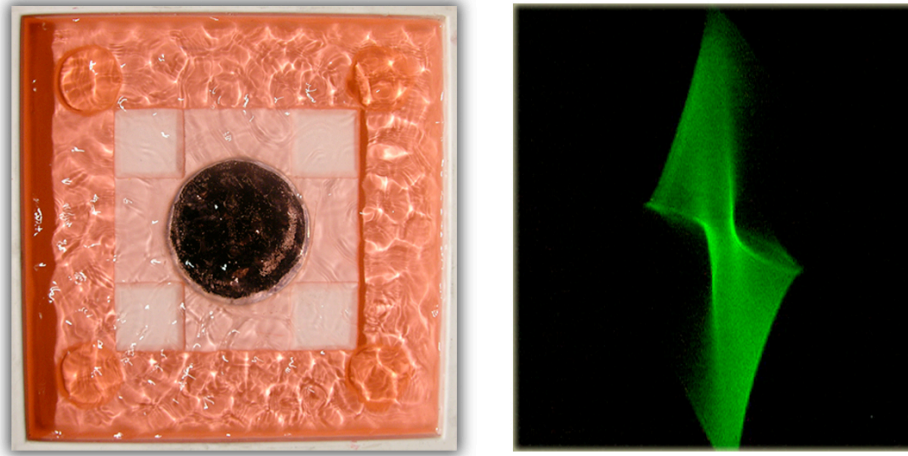

Figure 8: *the center for wave phenomenology*, subwoofer, acrylic polymer, water, glass mirror, green laser, 2007

The most recent project is shown in Figure 9 and uses the same method of projecting the effects of light (this time orange light) into space. The major development to my method was in the process of arriving at the physical form of the subwoofer. I continued to use scrap materials, but with the addition of the found object. The process began when I found a hexagonal window, which had the ideal dimensions for the water tank. This hexagonal shape determined the form of the subwoofer casing. This project was shown at the “Interduction (SIC)” graduate show in May 2009, which was the first time I had the opportunity to exhibit this type of work.

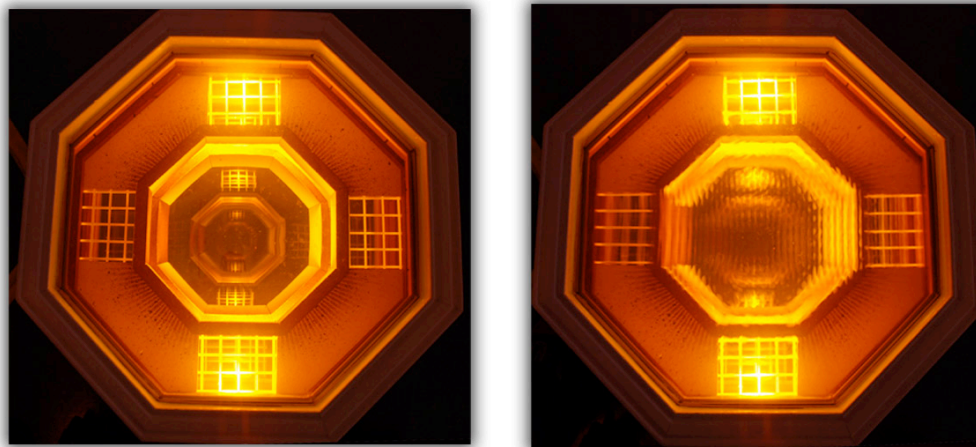

Figure 9: *alchemy of bricolage*, reclaimed wood, hexagonal window, subwoofer, water, light, 2009

Installation¹⁰

Cymatic Bricolage is being shown at Function 13, which is an art gallery / design book store located in Kensington Market in Toronto, Ontario, Canada. This exhibition space is being shared with Guillermina Buzio, who is another student enrolled in the Interdisciplinary Master's of Art, Media and Design program. We agreed to share a space for the exhibition because both of our works require a low-lit environment for experiencing subtle lighting effects or video projection. To create this environment we removed the existing track lights in the gallery and lined the walls with black fabric. Sharing the space was also important to my piece because, when installed, my work appears to be part of the building's mechanical system and may go unnoticed at first. When the video work of Guillermina draws viewers into the space, an ultrasonic sensor activates my piece to produce audiovisual effects in response to the sound of ventilation in the gallery.

¹⁰ A complete description of the final form of my installation cannot be stated because much of what I do while installing is dependent on circumstance. While in the space where I am installing there is a certain level of improvisation that cannot be preconceived before I am actually in the space with the materials I have collected.

My thesis exhibition consists of three elements; a physical component, an electronic component and a digital component. The physical component is made up of two instrument prototypes for producing Cymatic effects in response to sounds of the space.¹¹ *The Fan* is the first iteration of this instrument (fig. 10). It was built to sit horizontally facing upwards so it could be used for testing different Cymatic effects. In the final installation of this piece I used a 12 volt computer fan to produce movement in water. When building this piece I did not consider reinstalling it back into the ventilation system, which is why it sits flat facing up. There are two ways to view this piece. One way is to cover the top of the ventilation grate with a piece of sandblasted acrylic. When viewed in this way, the effects remain enclosed within the instrument, making the piece more of an art object. When the cover is off the effects are projected into the space, which is how it will be shown in the final installation.

The second physical component, *The Vent*, was built in consideration of installing it in the gallery's ventilation system (fig. 11). It was important to disguise the physical presence of the Cymatic instrument, so that its visual effects are the main focus. This changed my building habits from assemblage to physical construction, although I arrived at this piece through a process of bricolage. The major construction detail for this piece was installing the oscillator and water inside the vent in the gallery space. I achieved this by building a wood box in the same dimension as two ventilation grates. Then using a wooden frame I secured a flat piece of clear acrylic on top of the wooden box. Once these components were assembled I put them in an oven. After about 7 minutes the flat piece of acrylic lost its strength and was pulled down into a bowl shape by the force of gravity. This piece of formed acrylic made the water proof container that is installed inside the vent.

¹¹ I call them prototypes because in actual fact they simulate the sounds of the space. This installation was built in response to the sound of ventilation in the gallery space. The air from the vent was not strong enough to move a surface of water and I was unable to amplify the sound enough to produce traditional Cymatic effects. Therefore I used computer fans as oscillators, in order to enhance the affect.

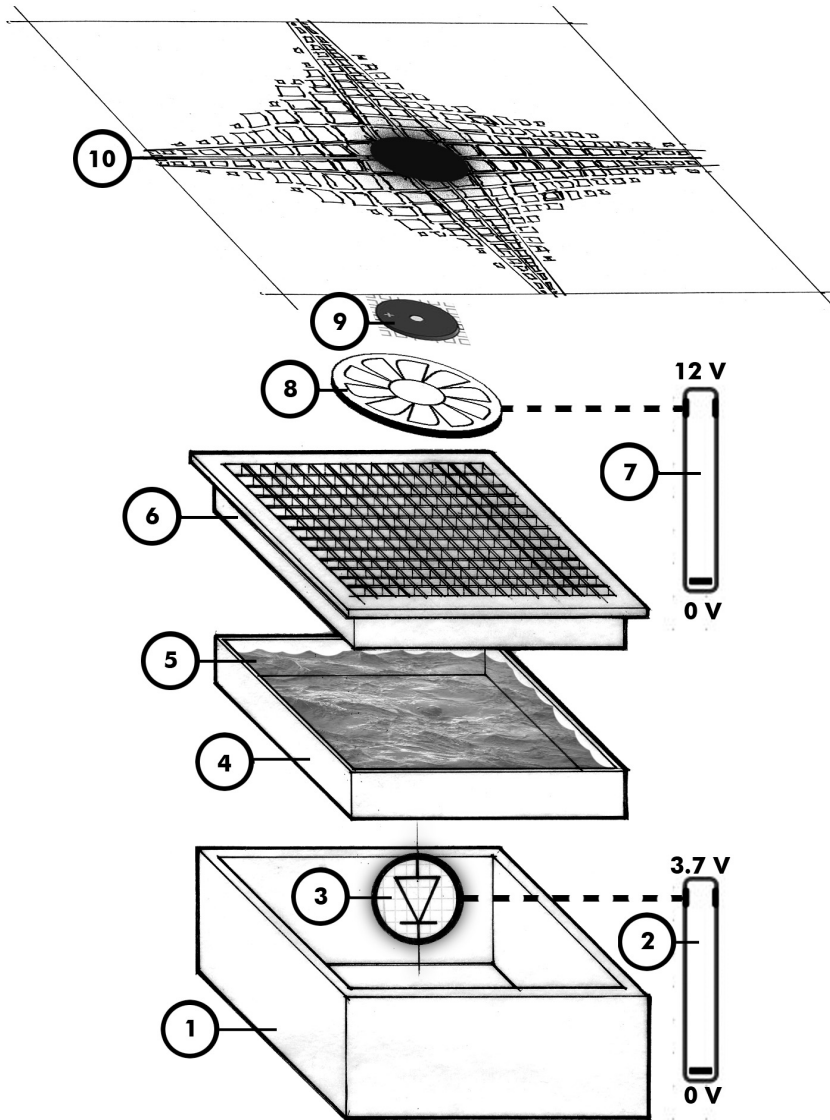

Figure 10: Construction drawing for *The Fan*.

1. Casing built from reclaimed wood, 2. Variable voltage control powering LED, 3. Blue high-powered LED (3.7V), 4. Waterproof tank, 5. Water, 6. Ventilation grate, 7. Variable voltage control powering the fan, 8. Computer fan (12V), 9. Piezo-electric contact microphone, 10. Audiovisual effect (fig. 12)

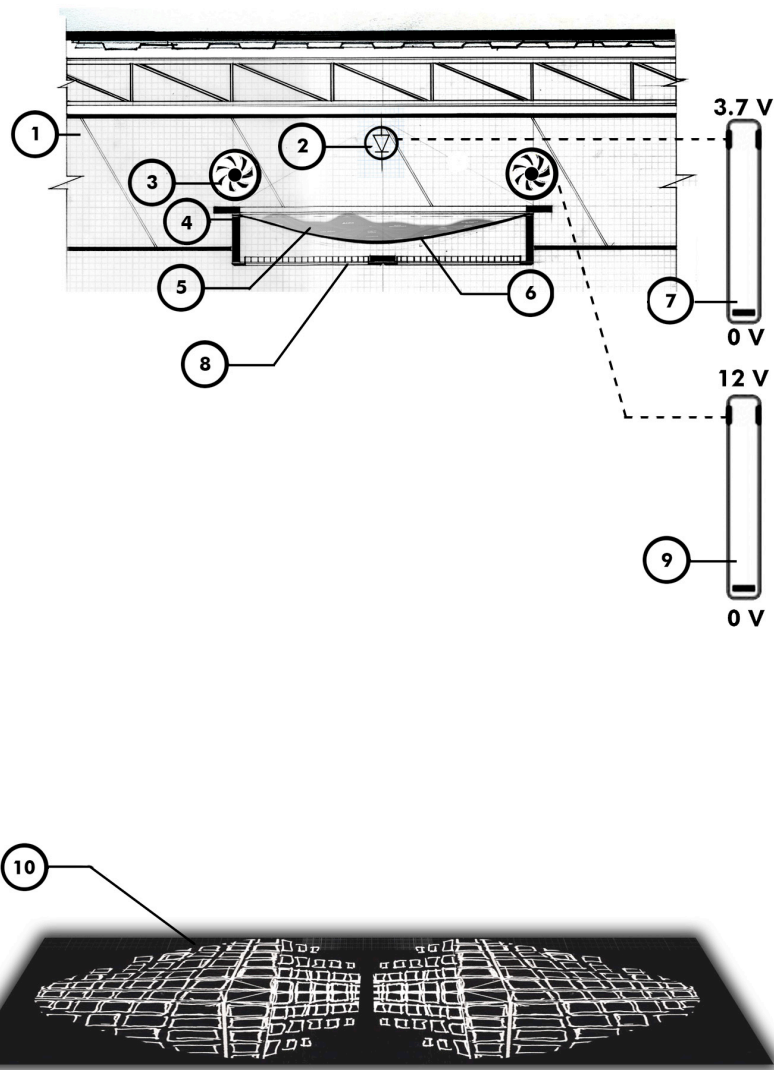

Figure 11: Construction drawing for *The Vent*

1.18" Ventilation duct, 2.Blue high-powered LED (3.7V), 3.Computer fan (12V), 4.Casing built from reclaimed wood, 5.water, 6.Acrylic container formed by heat and gravity, 7.Variable voltage control powering LED, 8.Two ventilation grates, 9. Variable voltage control powering computer fans, 10.Audiovisual effect (fig. 13)

The electronic component of the installation consists of two blue high-powered LED's, two 12 V computer fans, one UV sensor and either two piezo contact mics or two lavalier mics.¹² All these components are networked to an Arduino microcontroller¹³ inside a wooden box.¹⁴ The circuit was placed in this box for protection while being transported back and forth between my house and OCAD. By working on this circuit for such an extended period of time, the aesthetic of electronics began to evoke the spirit of my bricolage practice. The process of building a circuit involves networking heterogeneous electronic components so they work together to perform a certain function. This notion of networking reflects my bricolage practice of bringing together different practices and their media, which is represented in the final installation by the circuit box. *The Box* is a hub that unites the digital and physical aspects of the Cymatic Bricolage installation and methodology. I chose to emphasize this as a center piece for the show by laser cutting Cymatic Bricolage 2010 into its acrylic cover. This piece acts as an entry point for the installation and my process of working.

The digital component of this installation was written in the Arduino programming language. The program I wrote operates by either reading information from the gallery or sending information back to the gallery. When someone walks into the space a sensor sends an input signal to the chip, which then triggers it to output a current to the fans and lights. As the viewer gets closer to the sensor the amount of electrical current increases, causing the fans to speed up and lights to get brighter. When the fan speeds up more disturbances are created in the water, making the effect more noticeable in the space. The Arduino chip is an essential component for connecting audio to visual and thus enhancing the experience of the space. In the experience of the work, the viewer becomes the frequency generator in the Cymatic formula. A second

¹² At the time of writing, I am in the process of testing the type of sound each mic produces.

¹³ The Arduino microcontroller is an open-source electronic chip that can be programmed to create interactive objects and spaces. (See appendix A)

¹⁴ This wooden box was found in the trash in the Fall of 2009.

component takes the sound produced by the fan and sends it to through a series of mixers, where it is amplified, multiplied and sent through a low-pass filter before being played-back in the space.

One concept I explored in this project is the interplay between visual and acoustic aesthetic experiences. By projecting the silhouette of the ventilation grid through a container of moving water, its linear boundaries of the grid become unfixed. This creates a visual effect that is constantly moving, while maintaining an identifiable shape and form. The combination of this visual effect with the sound of the fan amplified in the space creates a condition where visual and acoustic perceptual experiences are closely related. (figs:12 & 13)

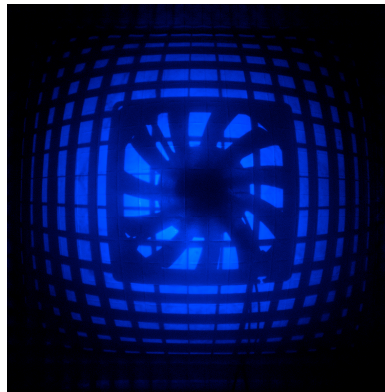

Figure 12: Audiovisual effect from *The Fan* (static)

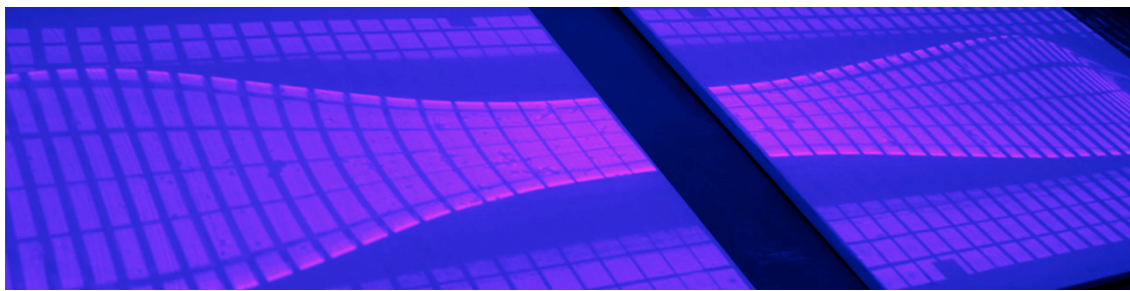

Figure 13: Audiovisual effect from *The Vent* (static)

During the two years working on this research project, I explored multiple ways of integrating audiovisual experience with my construction-based practice in a meaningful way. In response to this objective I formulated the first research question, which asked; *how can an audiovisual experience be created using found objects and materials?* By continually revisiting this question two disparate practices, Cymatics and Bricolage, found a common ground in the theoretical discourse surrounding the role of sound in architectural and industrial design practices. Investigating this field revealed that in historical and contemporary design practices more emphasis is placed on visual aesthetics, while aural experience is generally a byproduct. Exploring unintentional aural experience in relation to Schafer's notion of a universal concert established a critical context for the addition of sound to my existing practice, while making me more sensitive to aural experience.

My circumstantial approach to making combined with my heightened awareness to sound shaped this iteration of Cymatic Bricolage in response to the unintentional sound of ventilation in the gallery. Used in this way, Cymatic Bricolage responds to my second research question, which explored *how visualizing sound could be used to enhance the aural experience of an environment.* The final installation in collaboration with this supporting paper suggests that the Cymatic Bricolage method can make a contribution to contemporary art and design practices that are concerned with the study of aural experience of existing environmental conditions.

By turning the sound of a physical object or space into a visual experience, Cymatic Bricolage reopens the dialogue between visualizing sound and the phenomena of unintentional aural experience, which began with acoustics. It builds on previous two-dimensional sound visualization research by proposing an alternative method that is closer to aural experience. The alternative method used in this thesis project is the Cymatic Method, which contextualizes it

within the interdisciplinary art, media and design practices that explore the correlation between vision and sound for the purpose of understanding aural experience.

The iteration of Cymatic Bricolage I built for this thesis is the first of many installations that considers sound in relation to visual and physical experiences. By developing this method I have created the possibility for imagining a series of site specific installations where viewer perception is drawn to the sound of an object or environment. Cymatic Bricolage establishes a dialogue between the physical environment and its sounds through an experiential visualization where viewers perceive a space in visual and acoustic terms simultaneously. Such an experience may heighten viewer perception to existing aural experiences, encouraging them to consider their contribution to Schafer's universal concert.

Future Research

The research possibilities that I have opened up with this thesis are tremendous and I am excited to continue what I have started. A series of work I plan to produce in the near future will use my collection of sound producing objects to create multiple Cymatic prototypes. By using these soniferous objects to produce Cymatic effects, I will further explore Jenny's proposed field of periodic phenomena in relation to the built environment. In this investigation sound-producing objects or space are used as *Transducers* in the Cymatic method. Used in this way, the Cymatic Method can further explore aural experience of existing objects or spaces, which may contextualize the method as a way of testing sound in architectural and industrial design.

Postscript¹⁵

Following the plan stated in the written thesis, I completed the installation of the proposed thesis project. This was the first time I had seen the work in its entirety, with all its elements brought together into one experiential installation. Based on feedback from the examining committee, the piece was seen as successful in drawing the viewer's attention to the aural experience of the gallery space through the use of sound visualization. Using the found ventilation duct and installing it in the space disguised the physical aspect of the work as the gallery ventilation system. This allows viewers to focus on its audiovisual effects, rather than its presence in the space. In this way, the work acted as an entry point to the soundscape of the gallery, making the viewer also aware of other sounds heard from within the space, such as the sound accompanying Mina's videos, the store-front sounds from Function 13's bookstore and the street sounds from Augusta Avenue.

The sound emitted by the fan was processed to simulate the sound of ventilation in the space, however it was not exactly the same. I became aware of the low drone from the 12 volt fan as coming from another source, such as the sound of an air craft flying over head or a train passing by from a subway below. This aspect of the piece in combination with the audiovisual effect created an unanticipated affect that was beyond my original intention for the experience. This affect was a byproduct of the work, so I can only speculate about its evocative dimension. It seemed to speak to evoke an intuitive, emotional response, described by some as crating an eerie, mysterious and haunting atmosphere in the space. For me it evokes a meditative or contemplative feeling similar to the experience of staring at the flames of a fire. I think for the piece to maintain its integrity it might be best to leave this aspect of the experience open to viewer interpretation.

¹⁵ The postscript was written in response to comments made by the examining committee regarding the affect of the work and its effect on the viewer's experience of the space.

Bibliography

- Bernsen, Jens, *Sound in design*. Denmark: Danish Design Center, 1999.
- Blessner, Barry, Linda-Ruth Salter, *Spaces speak, are you listening?* Cambridge: MIT Press, 2007.
- Brougher, Kerry, *Visual music: synaesthesia in art and music since 1900*. London: Thames and Hudson, 2005.
- "Cymascope: *Sound made visible*". <http://www.cymascope.com/> (accessed May 12, 2010).
- De Certeau, Michel, *The practice of everyday life*. New York: University of California Press, 1988.
- De Kerckhove, Derrick, *The skin of culture: investigating the new electronic reality*, Toronto: Somerville House Pub., 1995.
- Dezeuze, Anna, "Assemblage, bricolage, and the practice of everyday life". *Art Journal* 67 (2008): 31-37.
- Jenny, Hans, *Cymatics*. Basil: Basilius Presse, 1974.
- Jenny, Hans, *Cymatics: The structure and dynamics of waves and vibrations*. Basil: Basilius Presse, 1967.
- McLuhan, Marshall, *The Global Village*. New York: Oxford UP, 1989.
- Schafer, R. Murray, *The soundscape: Our sonic environment and the tuning of the world*. Rochester, NY: Destiny Books, 1994.
- Sietz, William Chapin, *The art of assemblage*. New York : Museum of Modern Art; distributed by Doubleday, 1961.
- Undefine. "Thomas McIntosh – Ondulation."
<http://www.undefine.ca/en/projects/ondulation/> (accessed May 12, 2010)
- Wasser-Klang-Bilder: Chladnische klangfiguren von Alexander Lauterwasser. "Kymatik – Cymatics – Sound figures." <http://www.wasserklangbilder.de/> (accessed May 12, 2010)

Appendix A: Arduino Code

```
const int numOfReadings1 = 10; // number of readings to take/ items
                                // in the array
                                // "const" means value will not change
int readings1[numOfReadings1]; // stores the distance readings in an array
                                // or readings = 10
int arrayIndex1 = 0; // arrayIndex of the current item in the array
int total1 = 0; // stores the cumulative total
int averageDistance1 = 0; // stores the average value

const int numOfReadings2 = 10; // number of readings to take/ items in the
                                // array
                                // "const" means value will not change
int readings2[numOfReadings2]; // stores the distance readings in an array
                                // or readings = 10
int arrayIndex2 = 0; // arrayIndex of the current item in the array
int total2 = 0; // stores the cumulative total
int averageDistance2 = 0;

                                // setup pins and variables for SRF05 sonar
                                // device

int echoPin1 = 2; // SRF05 echo pin (digital 2)
int initPin1 = 3; // SRF05 trigger pin (digital 3)
unsigned long pulseTime1 = 0; // stores the pulse in Micro Seconds
                                // unsigned stores large variables without
                                // negative numbers (0 - 4,294,967,295)
                                // "long" allows for large numbers to be
                                // stored

unsigned long distance1 = 0;

int echoPin2 = 4; // SRF05 echo pin (digital 2)
int initPin2 = 5; // SRF05 trigger pin (digital 3)
unsigned long pulseTime2 = 0; // stores the pulse in Micro Seconds
                                // unsigned stores large variables without
                                // negative numbers (0 - 4,294,967,295)
                                // "long" allows for large numbers to be
                                // stored

unsigned long distance2 = 0;

                                // variable for storing the distance (cm)
                                // setup pins/values for LED

int fanLED = 11; // Red LED, connected to digital PWM pin 9
int fanLEDValue = 0;
int blowerLED = 10; // Red LED, connected to digital PWM pin 9
int blowerLEDValue = 0;
int fanPin = 9;
int fanValue = 0;
```

```

int blowerPin = 6;
int blowerValue = 0;

// stores the value of brightness for the LED
// (0 = fully off, 255 = fully on)

//setup

void setup() {

  pinMode(fanLED, OUTPUT);
  pinMode(blowerLED, OUTPUT);
  pinMode(blowerPin, OUTPUT);
  pinMode(fanPin, OUTPUT); // sets pin 9 as output
  pinMode(initPin1, OUTPUT); // set init pin 3 as output
  pinMode(echoPin1, INPUT); // set echo pin 2 as input
  pinMode(initPin2, OUTPUT); // set init pin 3 as output
  pinMode(echoPin2, INPUT);

  // create array loop to iterate over every item in the array

  for (int thisReading1 = 0; thisReading1 < numOfReadings1; thisReading1++)
    // ++ adds one to thisReading allowing it to
    // complete the array from 0 - 9

    {
    readings1[thisReading1] = 0;
    }

  for (int thisReading2 = 0; thisReading2 < numOfReadings2; thisReading2++)
    // ++ adds one to thisReading allowing it to
    // complete the array from 0 - 9

    {
    readings2[thisReading2] = 0;
    }

    // initialize the serial port, lets you view the
    // distances being pinged if connected to
    // computer

    Serial.begin(9600);
  }

  // execute
  void loop() {
  digitalWrite(initPin1, HIGH); // send 10 microsecond pulse
  delayMicroseconds(10); // wait 10 microseconds before turning off
  digitalWrite(initPin1, LOW); // stop sending the pulse
  pulseTime1 = pulseIn(echoPin1, HIGH); // Look for a return pulse, it should be high
  // as the pulse goes low-high-low
  //pulseIn tells pin 2 to listen for echo
  distance1 = pulseTime1/58; // Distance = pulse time / 58 to convert to
  // cm.
  total1 = total1 - readings1[arrayIndex1]; // subtract the last distance

```



```

readings1[arrayIndex1] = distance1; // add distance reading to array
total1 = total1 + readings1[arrayIndex1]; // add the reading to the total
arrayIndex1 = arrayIndex1 + 1; // go to the next item in the array
// At the end of the array (10 items) then
// start again

if (arrayIndex1 >= numOfReadings1) {
    arrayIndex1 = 0;
}

averageDistance1 = total1 / numOfReadings1; // calculate the average distance

digitalWrite(initPin2, HIGH); // send 10 microsecond pulse
delayMicroseconds(10); // wait 10 microseconds before turning off
digitalWrite(initPin2, LOW); // stop sending the pulse
pulseTime2 = pulseIn(echoPin2, HIGH); // Look for a return pulse, it should be high
// as the pulse goes low-high-low
//pulseIn tells pin 2 to listen for echo

distance2 = pulseTime2/58; // Distance = pulse time / 58 to convert to
// cm.

total2 = total2 - readings2[arrayIndex2]; // subtract the last distance
readings2[arrayIndex2] = distance2; // add distance reading to array
total2 = total2 + readings2[arrayIndex2]; // add the reading to the total
arrayIndex2 = arrayIndex2 + 1; // go to the next item in the array
// At the end of the array (10 items) then
// start again

if (arrayIndex2 >= numOfReadings2) {
    arrayIndex2 = 0;
}

averageDistance2 = total2 / numOfReadings2;

// if the distance is less than 255cm then change the brightness of the LED

if (averageDistance1 <= 250) { // [changed 255 to 147 based on readings from serial
    // monitor]
    fanLEDValue = 255 - averageDistance1 /25;
    // this means the smaller the distance
    // the brighter the LED.
} else {
    fanLEDValue = 255 - averageDistance1 /2.08;
    // this means the smaller the distance
    // the brighterthe LED.
}

if (averageDistance1 <= 350) {
    // [changed 255 to 147 based on readings
    // from serial monitor]
    fanValue = 255 - averageDistance1 /25;
    // this means the smaller the distance the
    // brighter the LED.
}

```

```

    } else {
fanValue = 255 - averageDistance1 /2.08;
// this means the smaller the distance the
// fast the fan will spin.
    }

if (averageDistance2 <= 250) { // [changed 255 to 147 based on readings
// from serial monitor]
blowerLEDValue = 255 - averageDistance2 /20;
// this means the smaller the distance
// the brighter the LED.
    } else {
blowerLEDValue = 255 - averageDistance2 /2.08;
// this means the smaller the
// distance the brighterthe LED.
    }

if (averageDistance2 <= 300) { // [changed 255 to 147 based on readings
// from serial monitor]
blowerValue = 255 - averageDistance2 /20;
// this means the smaller the distance the faster the fan
// will spin.
    } else {
blowerValue = 255 - averageDistance2 /2.08;
// this means the smaller the distance
// the faster the fan will spin.
    }

    analogWrite(fanLED, fanLEDValue);
    analogWrite(blowerLED, blowerLEDValue);
    analogWrite(blowerPin, blowerValue);
    analogWrite(fanPin, fanValue); // Write current value to LED pins
    Serial.println(averageDistance1, DEC);
    Serial.println(averageDistance2, DEC); // print out the average distance to the
// debugger
    delay(100);
}

```

Appendix B: Accompanying Material

The following accompanying material is available on the DVD included in the folder with this thesis paper:

- Video and photographic documentation of the thesis installation at Function 13