

The Effect of Central Counterparties on Counterparty Risk, Liquidity and Systemic Risk of Over-the-Counter Markets

**Dissertation zur Erlangung des Doktorgrades der Wirtschafts-
wissenschaften (Dr. oec.)**

Fakultät Wirtschafts- und Sozialwissenschaften

Universität Hohenheim

Institut für Financial Management

vorgelegt von

Gregor Schönemann

aus *Berlin*

2020

Date of Disputation: May 19, 2021

Faculty Dean: Prof. Dr. Karsten Hadwich

Primary Supervisor: Prof. Dr. Monika Gehde-Trapp

Secondary Supervisor: Prof. Dr. Jörg Schiller

Chairman of the Examination Board: Prof. Dr. Hans-Peter Burghof

Danksagung

An der Fertigstellung einer Dissertation sind weitaus mehr Menschen beteiligt als es auf den ersten Blick scheinen mag. Ohne intensivste fachliche und private Unterstützung ist es jedoch schwer vorstellbar, dass solch ein Projekt zu einem guten Ende gebracht werden kann. Daher ist es mir ein großes Anliegen, einige Personen namentlich zu nennen, die mit dem Abschluss dieser Arbeit untrennbar verbunden sind.

Zunächst und vor allem danke ich meiner Betreuerin, Prof. Dr. Monika Gehde-Trapp. Dank Ihnen habe ich das wissenschaftliche Arbeiten auf höchstem Niveau kennengelernt, sodass ich versuchen konnte, Ihnen darin zu folgen. Sie haben mich nicht mit einfachen Lösungen gehen lassen und dadurch sehr viel Potential aus mir herausgeholt, von dem ich nicht wusste, dass ich es habe. Ihre Schwerpunktsetzungen und Förderung haben meine Fähigkeiten in sehr vielen Bereichen substantiell erweitert, insbesondere in Themen, die ich von mir aus nicht angegangen wäre. Dadurch wird diese Zeit dauerhaft prägend für den Rest meines Lebens bleiben. Vielen Dank für Ihre Unterstützung auch in kritischen Phasen.

Mein Dank geht auch an den Zweitgutachter meiner Arbeit, Prof. Dr. Jörg Schiller. Sie waren und sind mir ein großes Beispiel in Ihrer Bereitschaft, Doktoranden auch außerhalb Ihres Fachgebiets zu fördern und Zeit für fachliche Diskussionen zu opfern. Ich danke auch Prof. Dr. Hans-Peter Burghof für seine Bereitschaft, den Vorsitz der mündlichen Prüfung zu übernehmen. Darüber hinaus jedoch war Ihr Wert als Bindeglied zwischen den verschiedenen Fachgebieten unschätzbar wertvoll für mich und hat in meinen Augen die Forschungsqualität sowie den Zusammenhalt unter den Promovierenden stark gefördert.

Ein besonderer Dank geht an meine direkten Kollegen Linda Klingler und Tapas Mohapatra, die alle Auf und Abs der ganzen Promotionszeit direkt miterlebt haben und mir darin eine große Hilfe waren - sowohl in den Fachthemen als auch in der Gemeinschaft. Aber auch außerhalb des eigenen Fachgebiets durfte ich viele Weggefährten treffen, welche die Zeit in Hohenheim mit Fachkenntnis und großem Spaß bereichert haben. Um nur einige zu nennen: Marius Burth, Achim Fecker, Marcel Gehrung, Sabrina Götz, Andreas Hecht, Maximilian Holzmeier, Inan Ince, Saeed Jamshidi, Fabian Krause, Michael Kühnen, Stefan Nothacker, Felix Ostertag, Daniel Schmidt, Alina Sigel, Jan Swiatkowski, Julius Tennert und Fabian Wahl. Ein Dank für die Unterstützung geht auch an die damaligen studentischen Hilfskräfte Patrick Groß, Louisa Herbst, Benedikt Kipka und Jenny Jakobs.

Für das unermüdliche Korrekturlesen und das Ertragen von unzumutbaren Anwendungen des Präsens' danke ich Philip Flenley von Herzen.

Ich danke meinen Freunden in Berlin, Hamburg, NRW und Stuttgart für die Treue und die kleinen wie großen Aufmunterungen während meiner ganzen Zeit im Süden Deutschlands. Ein besonderer Dank geht an Christian und Benjamin für eure Kameradschaft.

Auch meinen Geschwistern möchte ich hier Dank sagen, weil ihr (oft unbewusst) eine große Konstante und Rückhalt in meinem Leben seid, was einen großen Wert und keine Selbstverständlichkeit darstellt.

Meine Eltern haben ohne Frage den größten Anteil daran, dass ich in die Lage gekommen bin, promovieren zu dürfen. Ihr habt mir in allen Dimensionen, in denen Unterstützung möglich ist, den Rücken frei gehalten und mir unglaublich viel in meinem Leben ermöglicht. Jeder Dank sagt zu wenig und trotzdem - habt großen Dank!

Schlussendlich danke ich meiner Verlobten Susanna, vor allem für die Geduld und das unermüdliche Verständnis in der finalen Phase der Dissertation, in der ich nur unzureichend fähig zu jeglichem Gespräch oder gar Beziehung war. Deine Leistung an dieser Stelle ist für mich schwer zu begreifen.

Gregor Schönemann
Frankfurt am Main
Juli 2022

Soli Deo Gloria

Contents

List of Figures	v
List of Tables	vii
List of Abbreviations	xi
1 Introduction	1
2 Meet me in the middle – Central clearing and netting efficiency in the Credit Default Swap market	7
2.1 Introduction	8
2.2 Data sources, descriptive statistics and sample comparison	14
2.2.1 Descriptive statistics	17
2.2.2 Comparison of data sample with DTCC top 1,000 dataset and with samples from related studies of the CDS market	18
2.3 Empirical analysis	21
2.3.1 Baseline model - OLS estimation with fixed effects	21
2.3.2 The effect of central clearing for contracts of different degrees of pre-treatment netting efficiency	23
2.3.3 The effect of central clearing on netting efficiency for cohorts of early- and late-adopter CDS contracts	26
2.4 Robustness checks	27
2.4.1 Relative netting efficiency	28
2.4.2 Matched sample analysis	29
2.4.3 Restricted event window around clearing eligibility date	31
2.4.4 Placebo test	32
2.5 Summary and conclusion	33
A Appendix to Chapter 2	34
3 Multidimensional effects of central clearing on CDS market liquidity and their economic channels - A regression discontinuity approach	43
3.1 Introduction	44

CONTENTS

3.2	Data and sample creation	51
3.3	Empirical analysis	56
3.3.1	Baseline model - Semi-parametric regression discontinuity estimation	56
3.3.2	The effect of central clearing on CDS market liquidity for CDS contracts of different fundamental risk and liquidity risk	59
3.3.3	The effect of counterparty risk and inventory risk on CDS market liquidity before and after the introduction of central clearing	64
3.3.3.1	The effect of central clearing on CDS market liquidity through counterparty risk	64
3.3.3.2	The effect of central clearing on CDS market liquidity through CDS spread volatility	67
3.3.3.3	The effect of central clearing on CDS market liquidity through netting efficiency	69
3.3.3.4	The effect of central clearing on individual banks' inventory risk through lower regulatory capital charges	70
3.4	Robustness checks	72
3.4.1	Testing for discontinuities in covariates	72
3.4.2	Sensitivity to observation period	74
3.4.3	Accounting for autocorrelation	81
3.4.4	Placebo tests	83
3.4.5	Non-parametric regression discontinuity design	85
3.5	Conclusion	86
B	Appendix to Chapter 3	88
4	Firewall or superspreader? - CDS central clearing and contagion risk within the CDS dealer network	93
4.1	Introduction	94
4.2	Data description and correlation analysis	102
4.2.1	Data sources and correlation analysis	103
4.2.2	Adjustment of the original time series to the dynamics of the CDS financial network	105
4.3	Empirical analysis	112
4.3.1	Cointegration test	112
4.3.2	Granger causality test	114

CONTENTS

4.3.3	Volatility spillover analysis	117
4.3.4	Connectedness of CDS dealers: the Diebold-Yilmaz approach .	120
4.3.5	The effect of contagion risk on CDS premia prior to and after the introduction of central clearing	123
4.4	Robustness tests	125
4.4.1	Analysis of contagion risk within the CDS dealer network in calendar time	126
4.4.2	Unweighted CDS time series	134
4.4.3	Stock market data	141
4.5	Summary and conclusion	148
C	Appendix to Chapter 4	149
5	Conclusion	153
	Bibliography	157

CONTENTS

List of Figures

2.1.1	The impact of central clearing on netting efficiency for different pre- and post-clearing scenarios	11
2.1.2	The impact of central clearing on netting efficiency via the the risk intermediation chain	12
2.2.1	Number of clearing eligible CDS contracts per individual clearing date	16
2.2.2	Time series of CDS gross positions, CDS net positions, and CDS netting efficiency 30 weeks prior to and after central clearing eligibility	19
A.1	Overview on the impact of central clearing on netting efficiency in the CDS market through different economic channels	35
3.1.1	Time series of aggregate CDS gross positions from 2009-2018	44
3.2.1	Visualization of the regression discontinuity for different measures of CDS market liquidity	55
3.4.1	RD treatment effect and confidence intervals for different post-clearing bandwidths	80
B.1	Overview on the impact of central clearing on market liquidity in the CDS market through different economic channels	89
4.1.1	Contagion risk in bilaterally cleared markets and centrally cleared markets	94
4.2.1	CDS spread time series of core and peripheral dealers from 2009-2018	104
4.2.2	Average pairwise CDS return correlations for different subsets of G14 dealers (calendar time)	107
4.2.3	Average pairwise CDS return correlations for different subsets of G14 dealers (event time)	109
C.1	Computation of CDS event time series	150

LIST OF FIGURES

List of Tables

2.2.1	Descriptive statistics of aggregate CDS positions, netting efficiency and corresponding control variables	18
2.2.2	Sample comparison by industry composition	20
2.2.3	Sample comparison by CDS gross positions	21
2.3.1	The effect of central clearing on CDS gross positions, net positions, and netting efficiency	22
2.3.2	Effect of central clearing on CDS positions and netting efficiency for different levels of pre-clearing netting efficiency (interaction approach)	25
2.3.3	Effect of central clearing on CDS positions and netting efficiency across quintiles of contracts according to their clearing eligibility date	27
2.4.1	Effect of central clearing on relative CDS positions and netting efficiency	29
2.4.2	Matched sample analysis on the effect of central clearing on CDS gross positions, net positions and netting efficiency	30
2.4.3	The effect of central clearing on CDS gross positions, net positions and netting efficiency (8 weeks pre-/post-clearing event window) . .	31
2.4.4	Placebo test (netting efficiency)	33
A.1	Effect of central clearing on CDS gross positions for different levels of pre-clearing netting efficiency (subsampling approach)	36
A.2	Effect of central clearing on CDS net positions for different levels of pre-clearing netting efficiency (subsampling approach)	37
A.3	Effect of central clearing on CDS netting efficiency for different levels of pre-clearing netting efficiency (subsampling approach)	38
A.4	The effect of central clearing on relative CDS positions and netting efficiency for different levels of pre-clearing netting efficiency (interaction approach)	39
A.5	Panel unit root test on model residuals	40
A.6	Covariate improvement due to nearest-neighbor matching	41
3.2.1	Descriptive statistics on measures of CDS market liquidity and corresponding control variables	53

LIST OF TABLES

3.3.1	Effect of central clearing on market liquidity in a regression discontinuity design	58
3.3.2	RD effect of central clearing on CDS market liquidity across contracts for different levels of pre-clearing fundamental risk	61
3.3.3	RD effect of central clearing on CDS market liquidity across contracts for different levels of pre-clearing liquidity risk (bid-ask spread)	62
3.3.4	RD effect of central clearing on CDS market liquidity across contracts for different levels of pre-clearing liquidity risk (gross trading volume)	63
3.3.5	Counterparty risk as an economic channel for the effect of central clearing on CDS market liquidity	66
3.3.6	CDS spread volatility as an economic channel of the effect of central clearing on CDS market liquidity	68
3.3.7	Netting efficiency as an economic channel of the effect of central clearing on CDS market liquidity	70
3.3.8	The impact of central clearing on individual banks' CDS positions .	71
3.4.1	Regression discontinuity estimation for covariates	73
3.4.2	Donut RD estimation of the effect of central clearing on CDS market liquidity	76
3.4.3	RD effect of central clearing on CDS market liquidity using a 52-week pre-clearing window and a 4-week post-clearing window	77
3.4.4	RD effect of central clearing on CDS market liquidity using data-driven bandwidths (MSE & CER)	79
3.4.5	RD effect of central clearing on CDS market liquidity in a dynamic model	82
3.4.6	Placebo test (CDS market liquidity)	84
3.4.7	Non-parametric regression discontinuity estimation	85
B.1	Panel unit root test on model residuals	90
B.2	Woolridge test on autocorrelation in fixed effects panels	91
4.2.1	Correlation matrix of individual pairwise G14 dealer correlation coefficients	105
4.2.2	Heteroskedasticity-adjusted CDS return correlation coefficients . . .	111
4.3.1	Cointegration test	113
4.3.2	Granger causality test	116
4.3.3	CDS return volatility spillover analysis (ADL model)	119

LIST OF TABLES

4.3.4 Diebold-Yilmaz spillover table (event time) 121

4.3.5 Pre- and post-clearing effect of contagion risk on CDS premia . . . 124

4.4.1 Cointegration test (calendar time) 127

4.4.2 Granger causality test (calendar time) 129

4.4.3 CDS return volatility spillover analysis (calendar time) 130

4.4.4 Diebold-Yilmaz spillover table (calendar time) 132

4.4.5 Cointegration test (unweighted time series) 135

4.4.6 Granger causality test (unweighted time series) 137

4.4.7 CDS return volatility spillover analysis (unweighted time series) . . 138

4.4.8 Diebold-Yilmaz spillover table (unweighted time series) 139

4.4.9 Cointegration test (stock prices) 141

4.4.10 Granger causality test (stock return volatilities) 143

4.4.11 Stock return volatility spillover analysis 145

4.4.12 Diebold-Yilmaz spillover table (stock data) 146

C.1 Unit root tests on CDS return and CDS spread time series in event
time 151

LIST OF TABLES

List of Abbreviations

ADL	autoregressive distributed lag
AIC	Akaike Information Criterion
bn	billion
bp	basis point
CCP	central clearing counterparty
CDS	Credit Default Swap
CER	coverage error ratio
DFA	Dodd-Frank-Act
DTCC	Depository Trust & Clearing Corporation
EMIR	European Market Infrastructure Regulation
EU	European Union
HACC	heteroskedasticity-adjusted correlation coefficient
ICE	Intercontinental Exchange
LIBOR	London Interbank Offer Rate
MSE	mean squared error
OIS	Overnight Index Swap
OLS	ordinary least squares
OTC	over-the-counter
PUR	panel unit root
RD	regression discontinuity
RDD	regression discontinuity design
SEF	Swap Execution Facility
TIW	Trade Information Warehouse
TRACE	Trade Reporting and Compliance Engine
US	United States

LIST OF TABLES

USD	United States dollar
VaR	value at risk
VAR	vector autoregressive

1 Introduction

"CCPs are increasingly turning into institutions of unprecedented systemic importance." (Benoît Coeuré, 2014)

The introduction of central clearing on formerly bilaterally cleared over-the-counter (OTC) markets has been one of the biggest changes in the landscape of financial markets during the last decade. The studies in this thesis examine this landmark in financial markets regulation by analysing its effect on the three probably most relevant areas of financial market stability: counterparty risk, market liquidity and systemic risk. This thesis contributes to existing literature as it

- i examines unexplored effects of central clearing on Credit Default Swap (CDS) markets,
- ii identifies economic channels of the effect of central clearing, and
- iii applies existing methodologies to new areas in the field of finance.

To the best of our knowledge, the study in Chapter 2 of this thesis is the first to provide evidence on the effect of central clearing on counterparty risk from the perspective of total exposures and netting efficiency. My analysis in Chapter 3 challenges existing findings on the effect of central clearing on CDS market liquidity by applying a regression discontinuity analysis and extends the literature as I examine three dimension of market liquidity and identify economic channels through which central clearing may affect CDS market liquidity. The study in Chapter 4 is the first empirical study on the effect of central clearing on systemic risk within the CDS financial network and suggests a novel way to analyze contagion and default dependence dynamics within financial networks by applying methodologies from seminal studies on international capital markets spillover.

Previous literature extensively shows that trading mechanisms in financial markets strongly affect the ease of trading as well as the risk allocation across market participants (O'Hara, 1998; Kissell, 2014). Bilateral clearing on widely unregulated

OTC markets allow the exchange of highly bespoke financial products, that match very individual trading needs. Search cost and transaction costs, however, are high in OTC markets and operational risk as well as counterparty risk remain completely with the original trading parties. Organized and regulated financial exchanges are able to provide a high degree of market liquidity through an efficient matching of buyers and sellers and take over trade execution and counterparty risk, but only for standardized products that attract high trading volumes. Central clearing can be considered as an intermediate step between bilateral trading and exchange-based trading. In centrally cleared markets, trade inception takes place just as in bilaterally cleared markets. Once two market participants agree on a trade, a central clearing counterparty (CCP) takes over clearing and settlement operations as well as counterparty risk by becoming the buyer to the original seller and the seller to the original buyer.

Until the outbreak of the global financial crisis 2007/2008, CCPs were mostly attached to exchanges for the clearing and settlement of less complex financial products like stocks, options or futures. In the case of stocks in particular, the clearing and settlement period is only a matter of days until securities and cash are exchanged between buyer and seller. Even for options and futures, this period only lasts for a few weeks or months. The length of this period is of crucial importance as the CCP guarantees the delivery of all payments that arise from the centrally cleared contract during this time, and is therefore exposed to the counterparty risk of its trading partners (i.e. clearing members).

As a result of the unnoticed excessive build-up of OTC trading positions by large financial institutions in the run-up to the global financial crisis 2007/2008, the subsequent defaults of these institutions and the loss of trust among OTC market participants, OTC markets have become the focus of financial regulation. Especially Credit Default Swaps were subject of regulatory discussions, reaching from increasing CDS market transparency to the banning of uncovered ('naked') CDS. A Credit Default Swap insures the buyer against the default of a reference entity (e.g. a company or a state) that is determined by the contract. If this reference entity defaults, the CDS seller is obliged to pay a contract-specific amount of cash or securities to the CDS buyer. As a compensation for offering this default protection, the CDS seller receives a quarterly CDS premium similar to an insurance fee. At the Pittsburgh summit in 2009, the leaders of the G20 states decided to introduce central clearing of standardized OTC derivatives, including CDS on individual ref-

erence entities (single-name CDS) or on a basket of reference entities (multi-name CDS).

The resolution of the G20 nations has been implemented in the United States (US) via the Dodd-Frank-Act (DFA) and in the European Union (EU) via the European Market Infrastructure Regulation (EMIR). These policies intend a smooth transition from bilateral CDS clearing to centrally cleared CDS trading. So far, only a few multi-name CDS products are required for central clearing. Central clearing of single-name CDS remains voluntary.

The voluntary nature of single-name CDS central clearing raises concerns about its effectiveness and ability to sustainably enhance financial stability. One of the most debated features of a CCP is its ability to offset redundant positions of clearing members across their multiple counterparties (Jackson and Manning, 2007; Duffie and Zhu, 2011; Cox et al., 2013; Cont and Kokholm, 2014; Lewandowska, 2015; Garratt and Zimmerman, 2017; Hayakawa, 2018). Especially the large CDS market makers ('G16 dealers') usually have multiple offsetting open positions of the same contract at the same time but with different counterparties so that they cannot be netted out. This is why gross positions are usually considerably higher than net positions on the CDS market and their ratio (netting efficiency) typically ranges far below one. If all of these trades are centrally cleared, the CCP becomes the only counterparty to all of these positions and can net out all redundant positions and reduce overall CDS positions in the market. This reduction of redundant positions reduces counterparty risk and can increase financial stability, as it reduces overall positions, that are potentially subject to default. The effect of CCPs on netting efficiency is strongest, if all trades are centrally cleared. If central clearing is voluntary, trading volume may be split by CDS market participants into a bilaterally cleared part and a centrally cleared part and lead to a higher fragmentation of the CDS market, lower netting efficiency and a low effectiveness of the CCP. Trading volume may also be split across CCPs which as a consequence decreases the effect of central clearing on netting efficiency further. Last, bilaterally cleared markets may already be quite efficient from a perspective of position netting since there is evidence that only a few dominant CDS dealers are the counterparty to most CDS positions, which in turn affects netting efficiency positively. While there are numerous theoretical studies on these parameters that determine the effect of central clearing on the CDS market, Chapter 2 of this thesis - 'Meet me in the middle – Central clearing and netting efficiency in the Credit Default Swap market' - is the first study that provides

empirical evidence on the effect of voluntary central clearing on netting efficiency in the market for single-name CDS.

From a risk management perspective, central clearing for CDS is a remarkable step, considering the maturity of five years for the most traded CDS contracts. A long clearing period makes the management of market risk, liquidity risk, and counterparty risk increasingly complex. This may lead to strict risk management practices applied by CCPs due to the high uncertainty and number of parameters that affect the valuation of CDS. As a consequence, cost of collateral may be large for centrally cleared trades (Aitken and Singh, 2009; Brunnermeier and Pedersen, 2009; Sidanius and Zikes, 2012; Singh, 2010; Heller and Vause, 2012; Duffie et al., 2015). In addition, CCPs charge clearing fees that increase order processing costs. Higher post-trade transparency through publication of trading volumes, open interests and prices by CCPs may change market liquidity by affecting the share of informed and uninformed trading (Pagano and Roell, 1996; Bloomfield and O'Hara, 1999; Lin, 2016). On the other hand, a highly creditworthy CCP with strict risk management requirements may reduce counterparty risk and increase dealer competition. Removing this trading friction can improve market liquidity (Jarrow and Yu, 2001; Kraft and Steffensen, 2007; Arora et al., 2012; Morkoetter et al., 2012; Loon and Zhong, 2014; Du et al., 2019). Chapter 3 of this thesis - 'Multidimensional effects of central clearing on CDS market liquidity and their economic channels – a regression discontinuity approach' - uses a regression discontinuity design (RDD) to examine the effects of central clearing on market liquidity. An RDD allows a clearer identification than previous studies by controlling for fixed effects, and a time trend that can differ before and after the introduction of central clearing. Furthermore, my analysis takes a holistic view on CDS market liquidity as it is not restricted to measures of market breadth and market depth as in previous studies, but also examines the effect of central clearing on CDS market resiliency. Furthermore, I investigate whether the effect of central clearing differs across contracts with high or low pre-clearing liquidity risk and fundamental risk. Additionally, I analyze four different channels through which central clearing may affect CDS market liquidity: counterparty risk, cost of collateral, netting efficiency and regulatory capital charges.

Chapter 4 “Firewall or superspreader? - CDS central clearing and contagion risk within the CDS dealer network” analyzes whether voluntary central clearing of single-name CDS contracts increases financial stability by reducing contagion risk. Central clearing may mainly affect contagion risk through the default loss absorbing capacity of CCPs but also through aspects like change in overall risk

exposures and market liquidity that are examined in Chapter 2 and 3. If a CCP is poorly capitalized but heavily used as trading partner, central clearing may actually increase contagion risk since all CDS market participants are tied together by their trading relationships with the CCP (Allen and Gale, 2000; Markose et al., 2012). A well-capitalized CCP, however, may be able to effectively insulate all clearing members from each other's default risk (Zhu, 2011; Capponi et al., 2017). This study contributes to the literature in two ways: it provides the first empirical evidence on the effect of central clearing on contagion risk and it shows a novel way to model empirically default dependence dynamics within a financial network with time series models. For this purpose, we manipulate the original time series of CDS dealers' CDS spreads and CDS returns in order to incorporate the specific CDS financial network dynamics and to be able to divide our time series into a pre- and post-clearing period despite the staggered introduction of CDS central clearing eligibility. This allows us to examine contagion risk by analyzing cointegration relationships, Granger causality, volatility spillovers and dynamic financial network spillover effects as shown in previous studies (Kasa, 1992; Gelos and Sahay, 2001; Jung and Maderitsch, 2014; Diebold and Yilmaz, 2009, 2012). Furthermore, we provide first empirical evidence on the pricing consequence of contagion risk on CDS premia.

Chapter 5 summarizes the key findings and shortcomings of the studies contained in this thesis as well as potential implications for policymakers and financial regulation.

2 Meet me in the middle – Central clearing and netting efficiency in the Credit Default Swap market

Monika Gehde-Trapp¹ & Gregor Schoenemann²

Abstract

We study the effect of central clearing on netting efficiency in the CDS market. We examine the development of position data and netting efficiency using aggregate data from the Depository Trust Clearing Corporation (DTCC). Our main finding is that gross and net outstanding positions in cleared contracts increase but the effect of gross positions is substantially larger. Hence, central clearing decreases netting efficiency to a considerable extent. Furthermore, we analyze different quintile portfolios of CDS contracts according to pre-clearing netting efficiency. We find that only those contracts that were most efficiently netted bilaterally, decrease in netting efficiency after the introduction of central clearing. The negative effect of central clearing on netting efficiency is more pronounced for the first contracts that have been made eligible for central clearing.

JEL classification: G12, G15, G18, G23, G28

Keywords: Central clearing, credit default swaps, netting efficiency, counterparty risk

¹University of Hohenheim, Schurzstraße 42, 70599 Stuttgart, Germany, email: monika.gehde-trapp@uni-hohenheim.de

²University of Hohenheim, Schurzstrasse 42, 70599 Stuttgart, Germany, email: gregor.schoenemann@uni-hohenheim.de

We are grateful for helpful comments from Christian Koziol, Ping McLemore, Karsten Schweikert, and participants at the 4th Winter Finance Workshop Hohenheim, FMA Europe 2019, and the DGF 2019. We thank for database access to Bloomberg, TRACE and Eikon / Datastream provided by DALAHO Hohenheim.

2.1 Introduction

In this paper, we examine how central clearing affects netting efficiency (defined as the ratio of net positions to gross positions) in the market for Credit Default Swaps. Under the assumption of constant gross positions, multiple theoretical papers show that central clearing can change netting efficiency by affecting net positions (Baer et al., 2004; Jackson and Manning, 2007; Duffie and Zhu, 2011; Galbiati and Soramäki, 2012; Cont and Kokholm, 2014; Heath et al., 2016; Garratt and Zimmerman, 2017; Hayakawa, 2018). Since CDS market participants frequently buy and sell the same contract, net positions are usually much lower than the corresponding gross positions. Under bilateral clearing, only trades with the same transaction partner can be netted to reduce gross positions. Centrally cleared trades, however, allow for multilateral netting via a central clearing counterparty. By increasing netting efficiency, central clearing can increase dealers' capacity to provide market liquidity.

To the best of our knowledge, our paper is the first to empirically analyze the impact of central clearing on netting efficiency as the ratio of net positions to gross positions. Dealers in the CDS market aim at zero net positions and high gross positions in order to yield high revenues from liquidity provision without any exposure to market or idiosyncratic risks. Gross positions increase counterparty risk, because they are potentially subject to default. The default of a market participant increases the exposure of its counterparties to market risk and idiosyncratic risk and incurs replacement costs. Consequently, Shachar (2012) finds increasing CDS inter-dealer exposures to decrease liquidity provision of dealers. An increase in netting efficiency may foster liquidity provision of dealers, as it allows them to enter into more trades without effectively increasing their counterparty risk in terms of gross positions. End-users optimize CDS net positions according to their hedging needs, their view on the reference entity's default probability and arbitrage opportunities (Oehmke and Zawadowski, 2017). The introduction of central clearing may impact dealers' (end-users') choice of their gross (net) positions by affecting counterparty risk, inventory costs, market transparency, and bargaining power in the CDS market. Further results of central clearing with an impact on netting efficiency could be a change in the extent of dealer diversification, and in the length of the risk intermediation chain.

Figure A.1 shows how central clearing may impact different determinants of dealers' (end-users') choice of CDS gross (net) positions with respect to different economic channels. First, central clearing may reduce the negative effect of counterparty risk on CDS premia (Arora et al., 2012; Morkoetter et al., 2012; Loon and Zhong, 2014; Kaya, 2016; Kroon and van Lelyveld, 2018; Molleyres, 2018; Du et al., 2019). Thus, central clearing can increase CDS premia and price efficiency in the CDS market (Silva et al., 2018). This makes the CDS market more attractive for end-users, since CDS selling yields higher CDS premia and CDS hedging strategies are more effective (Hansen and Moore, 2016; Oehmke and Zawadowski, 2017). The reduced relevance of counterparty risk in the CDS market under central clearing may foster liquidity provision through higher dealer competition (Slive et al., 2012; Loon and Zhong, 2014; Mayordomo and Posch, 2016).

Second, central clearing may change inventory costs of dealers and end-users by affecting collateral demand and regulatory capital requirements. Brunnermeier and Pedersen (2009) show the negative relation between collateral demand and liquidity provision of dealers in general. The impact of central clearing on collateral demand in the CDS market through margin requirements can be positive (Singh, 2010; Sidanius and Zikes, 2012; Heller and Vause, 2012) or negative (Duffie et al., 2015), meaning the introduction of central clearing can result in lower or higher liquidity provision of dealers. Similarly, lower regulatory capital requirements for exposures towards CCPs (Basel Committee on Banking Supervision, 2014) may free up capital of CDS market participants (Minton et al., 2009; Kenyon and Green, 2012; Yorulmazer, 2013; Shan et al., 2017; Klingler and Lando, 2018).

Third, the introduction of central clearing may increase market transparency in the CDS market. Market transparency affects market liquidity by making informed trading less profitable, as additional market information allows uninformed traders to infer trading motives of informed traders more accurately and to adjust bid-ask spreads accordingly (Glosten and Milgrom, 1985; Kyle, 1985; Easley and O'Hara, 1987; Qiu and Yu, 2012). Increased market transparency may be more attractive for uninformed traders but less attractive for informed traders. The dominating CCP on the market for CDS, Intercontinental Exchange (ICE) Clear Credit, increases post-trade transparency through publishing trading volume, open interest and settlement prices on a daily basis for the last six months of its cleared contracts. Findings from similar increases in post-trade transparency on OTC markets point to a decrease in trading volume (e.g. introduction of TRACE on the corporate bond market in Bessembinder et al. (2006); Edwards et al. (2007); Goldstein et al. (2007); Asquith

et al. (2019) or the introduction of the Dodd-Frank Act (Loon and Zhong, 2016)). Increased market transparency may also reduce price volatility with the beginning of central clearing as found in multiple studies (Lyons, 1996; Loon and Zhong, 2014; Mayordomo and Posch, 2016; Menkveld et al., 2015; Bernstein et al., 2019). Lower price volatility decreases inventory holding costs by reducing daily price changes that result in corresponding margin calls.

Last, the introduction of CCPs as a new type of market participant on the CDS market can affect the bargaining power of CDS dealers. Since only large dealers may become clearing members of CCPs, the introduction of central clearing can strengthen the bargaining position of dealers with respect to end-users that have a demand for clearing services (Hendershott et al., 2017; Iercosan and Jiron, 2017). Dealers may exploit this bargaining position by increasing transaction costs (Duffie et al., 2005; Iercosan and Jiron, 2017; Di Maggio et al., 2017; Collin-Dufresne et al., 2018; Eisfeldt et al., 2018; Li and Schürhoff, 2019; Üslü, 2019). As a result, the CDS market may become more unattractive for end-users as a venue for trading corporate credit.

The model predictions on netting efficiency are ambiguous: First, the trading volume cleared by CCPs matters. Panel A and Panel B of Figure 2.1.1 show that CDS market participants must clear sufficient trading volume with one CCP if multilateral netting across counterparties is to improve netting efficiency compared to bilateral clearing (Jackson and Manning, 2007; Duffie and Zhu, 2011; Cox et al., 2013; Cont and Kokholm, 2014; Hayakawa, 2018). However, if dealer diversification is low prior to the introduction of central clearing, centrally cleared trading volume may negatively affect netting efficiency as shown in Panel C of Figure 2.1.1 (Cont and Kokholm, 2014).

Second, market participants who are averse to counterparty risk concentration, as suggested by Eisfeldt et al. (2018), may diversify trading volume across CCPs. Panel D of Figure 2.1.1 shows that the splitting of trading volume across CCPs reduces netting efficiency compared to central clearing with one single CCP (Duffie and Zhu, 2011; Anderson et al., 2013; Cox et al., 2013; Cont and Kokholm, 2014; Heath et al., 2016). Second, the similarity of trading behavior across dealers is relevant: higher dealer competition for order flow due to lower relevance of counterparty risk for centrally cleared trades (Loon and Zhong, 2014; Du et al., 2019) can lead to more similar trading behavior of dealers for clearing eligible contracts. In the model of Duffie and Zhu (2011), the resulting higher cross-counterparty exposure correlation

2.1. INTRODUCTION

increases netting efficiency under central clearing but decreases it in the models of Cox et al. (2013), Cont and Kokholm (2014) and Heath et al. (2016).

Figure 2.1.1: The effect of central clearing on netting efficiency for different pre- and post-clearing scenarios

Numbers show net positions (left) / gross positions (right) of individual market participants, and the market aggregate is shown in bold font. Gross (net) positions are defined as gross (net) protection bought. Dealers are denoted as D 1, D 2, and D 3. Arrows go from CDS protection seller to CDS protection buyer

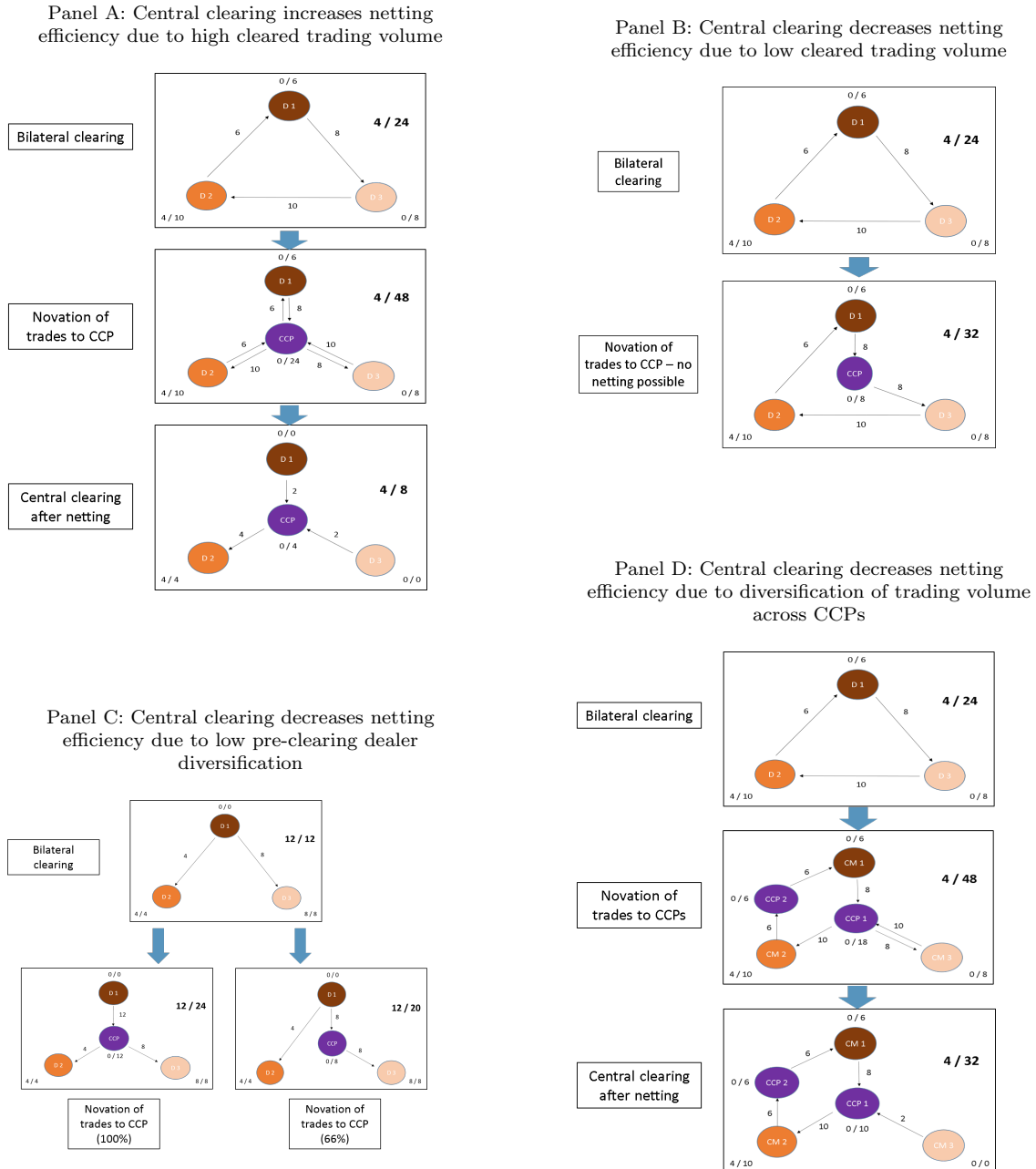
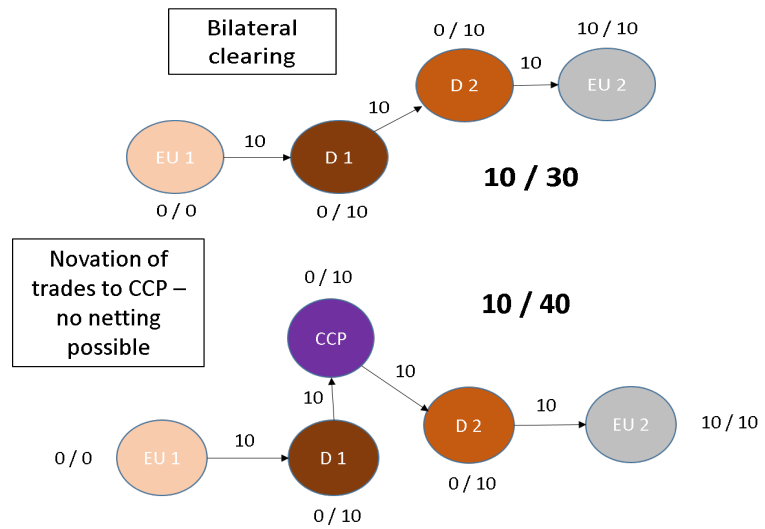

Figure 2.1.2: The impact of central clearing on netting efficiency via the the risk intermediation chain

Numbers show net positions (left) / gross positions (right) of individual market participants, and the market aggregate is shown in bold font. Gross (net) positions are defined as gross (net) protection bought. Dealers are denoted as D 1, D 2, and D 3. Arrows go from CDS protection seller to CDS protection buyer. Only interdealer trades can be centrally cleared.

Panel A: Central clearing decreases netting efficiency through increasing steps in the risk intermediation chain



Panel B: Central clearing increases netting efficiency through decreasing steps in the risk intermediation chain

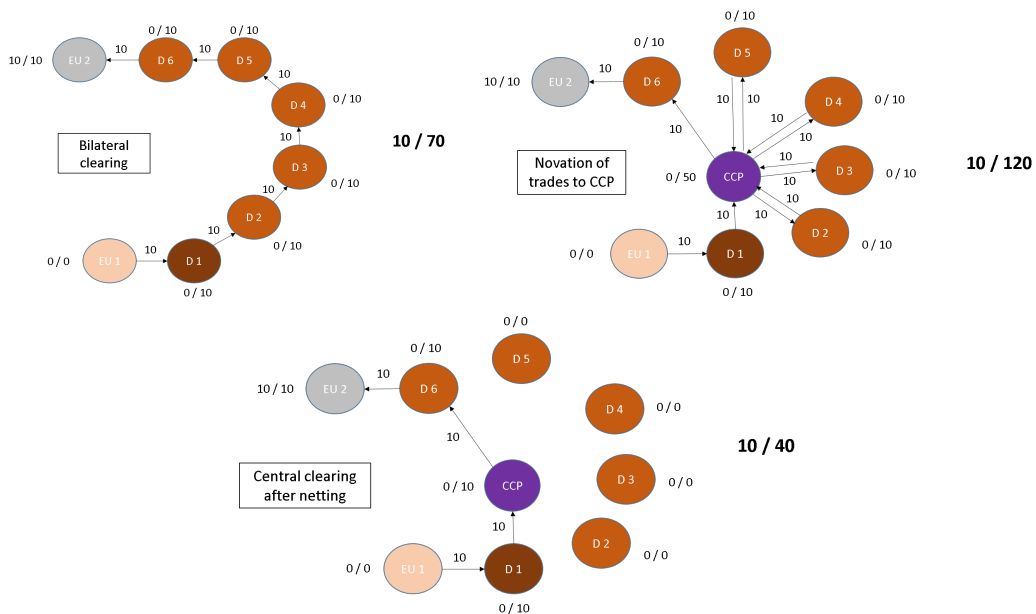

Third, central clearing may affect netting efficiency by changing risk intermediation in the CDS market. One characteristic of the CDS market is a risk intermediation chain that connects end-users with active core dealers via smaller peripheral

dealers (Peltonen et al., 2014; Eisfeldt et al., 2018). Panel A of Figure 2.1.2 shows that CCPs can decrease netting efficiency if the risk intermediation chain is very short and intermediate dealers do not become obsolete. Panel B of Figure 2.1.2 shows, that in the case of a long risk intermediation chain with many redundant gross positions, central clearing can considerably increase netting efficiency. The discussion of the existing literature shows that the ability of CCPs to increase netting efficiency is an empirical question and is therefore the focus of this study. Using a time series of trade reports from the Depository Trust & Clearing Corporation, we collect market-wide contract-specific gross and net positions for 147 CDS contracts between 2009 and 2017. 122 of these contracts become eligible for central clearing on 35 dates during our observation interval. This staggered introduction allows us to cleanly identify the impact of central clearing eligibility on gross and net positions and netting efficiency as any confounding factors would have to occur systematically at all clearing dates in order to bias our results. We show that CDS gross positions and net positions increase significantly with the beginning of central clearing eligibility. The economic effect of central clearing on gross positions is considerably stronger than its effect on net positions. As a result, netting efficiency decreases by roughly 9.58% of its statistical mean during our observation period. In summary, our findings imply that dealers provide more liquidity and increase their inventories with the beginning of central clearing. The liquidity effect, however, is substantially stronger.

Next, we next split our sample to study the cross-sectional determinants of netting efficiency. First, we find that netting efficiency only decreases for contracts that were netted most efficiently prior to central clearing eligibility. This is in line with Cont and Kokholm (2014), who show that netting efficiency is negatively affected by high market concentration prior to central clearing because concentration of trading volume in a few dominant counterparties implies a high degree of netting efficiency. Introducing a CCP then decreases concentration and effectively reduces netting opportunities. Second, we find that the effect of central clearing on netting efficiency is most pronounced for the first contracts that have been made eligible for central clearing. This suggests that any effects of central clearing are only realized when centrally cleared contracts have a sufficiently large market share (Duffie and Zhu, 2011).

Our paper extends the literature about OTC derivatives market structures by analyzing the direct effect of voluntary central clearing on netting efficiency. To the best of our knowledge, no other study empirically examines the effect of central

clearing on any direct measure of netting efficiency on the CDS market nor tests the hypotheses of Duffie and Zhu (2011) and Cont and Kokholm (2014) on the impact of pre-clearing dealer diversification and cleared trading volume on netting efficiency. Akari et al. (2019) are closest to our study: in one of their analyses, they examine the impact of central clearing on gross and net positions separately by running a fixed effects regression and a t-test on the mean and median of treatment and control group in a matched sample. They find increasing gross positions and constant net positions in the fixed effects regression and in the t-test on the mean and increasing gross and net positions in the t-test on the median. They look at CDS gross and net positions separately as measures of trading activity but do not examine their joint development in terms of netting efficiency or provide any more detailed economic explanations for the effect of central clearing on netting efficiency in the CDS market. We close this gap in the literature by providing a novel proxy for netting efficiency and by analyzing differential effects of central clearing along the cross-section of CDS contracts in terms of pre-clearing netting efficiency and clearing eligibility duration.

2.2 Data sources, descriptive statistics and sample comparison

Our initial dataset consists of weekly Trade Information Warehouse (TIW) reports from the Depository Trust & Clearing Corporation from November 7, 2008 to May 4, 2018. The reports contain weekly aggregate data on open CDS positions. TIW reports contain data on the top 1,000 reference entities in terms of net outstanding positions in the given week. TIW reports capture approximately 98% of all globally executed single-name CDS transactions (DTCC, 2019).

In order to measure liquidity provision and inventory risk for a specific contract i at date t , we collect aggregate gross and net outstanding positions.⁴ Aggregate gross positions for a specific CDS contract in a given week are measured as the sum of the notional values over all outstanding CDS contracts. There is one protection buyer and one protection seller to every outstanding CDS contract. The DTCC counts the notional value of every open CDS transaction only once to the aggregate gross position in the respective contract. Therefore, gross outstanding positions for a spe-

⁴Aggregate CDS gross and net positions are reported in Section I, Table 6 of any weekly TIW report.

2.2. DATA SOURCES, DESCRIPTIVE STATISTICS AND SAMPLE COMPARISON

cific contract in a given week are identical to the sum of all CDS protection bought (or sold) in terms of notional values for the respective contract. As the DTCC can identify the counterparties to every open CDS contract, it also aggregates the gross positions on counterparty level. The DTCC distinguishes whether a counterparty is the protection buyer or the protection seller to an open CDS position. The net outstanding position of a specific counterparty is the difference between the open gross positions, to which the counterparty acts as a buyer, and the open gross positions, to which the counterparty acts as a seller. The DTCC computes aggregate net outstanding positions as the sum of net outstanding positions over all counterparties. Since there is a buyer and a seller to every CDS contract, the aggregate net outstanding position is always zero. Therefore, the DTCC reports the sum of net outstanding positions over all net protection sellers as aggregate net outstanding positions.

We consider net outstanding positions to be a proxy for inventory risk. To hold a net position in a CDS implies a directional view on the default probability of the reference entity. End-users usually hold net positions in CDS, because they hedge exposures from other financial markets (e.g. bond market), speculate or act as arbitrageurs (e.g. hedge funds). If net positions increase, some CDS market participants show growing risk appetite since they are willing to provide more insurance against the default of reference entities. Dealers try to hold zero net positions (i.e. a flat inventory), because they solely aim at making profits by providing liquidity to the market.

Dealers stand ready to be the counterparty in transactions with end-users or other dealers. However, they aim to mitigate the risks immediately that they have taken on in these transactions. Typically, they achieve this goal by entering a position that offsets the previous one. If every transaction can be offset perfectly, this leads to a flat CDS inventory. Dealers are compensated for providing liquidity by earning the bid-ask spread. Assuming a constant bid-ask spread, the profit of dealers increases if they maximize gross trading volume. Therefore, we consider gross outstanding positions to be a proxy that is related to dealers' activity in liquidity provision.

There are limits to liquidity provision. Offsetting an existing position by opening a new position creates new exposure to another counterparty if the exposure cannot be netted due to an already existing position with that counterparty that offsets this new position. A default of the counterparty can incur losses because open positions

at default are closed out and need to be set up again. If counterparty exposures become too high, dealers restrict liquidity provision (Shachar, 2012).

By increasing the netting opportunities, central clearing can lead to an increase in liquidity provision of dealers if central clearing allows dealers to increase CDS trading volume without increasing actual gross and net positions. If we examine gross and net positions separately, however, we cannot derive any precise conclusions from it in terms of netting efficiency. If gross positions rise, this could be caused by end-users that have simultaneously increased their CDS net protection bought. An increase in gross positions could also be accompanied by an increase in net positions if dealers fail to find counterparties for trades that are supposed to offset the transactions with their clients.

In order to get clear results on the relation between gross and net outstanding positions in the CDS market prior to and after the beginning of central clearing eligibility, we create a new proxy for netting efficiency. We compute netting efficiency as the ratio of net outstanding positions to gross outstanding positions for contract i in week t :

$$\text{nett_eff}_{i,t} = \frac{\text{net_position}_{i,t}}{\text{gross_position}_{i,t}} \quad (2.1)$$

To explore the effects of central clearing, we analyze 35 dates on which single-name CDS contracts become eligible for central clearing. Figure 2.2.1 displays the timeline and the number of reference entities, for which the Intercontinental Exchange initiated central clearing at each clearing event.

Figure 2.2.1: Number of clearing eligible CDS contracts per individual clearing date
 Number of clearing eligible contracts per clearing event: The bar plot shows the number of contracts that become eligible for central clearing at each individual clearing eligibility event. Each bar represents one clearing eligibility event from our sample.

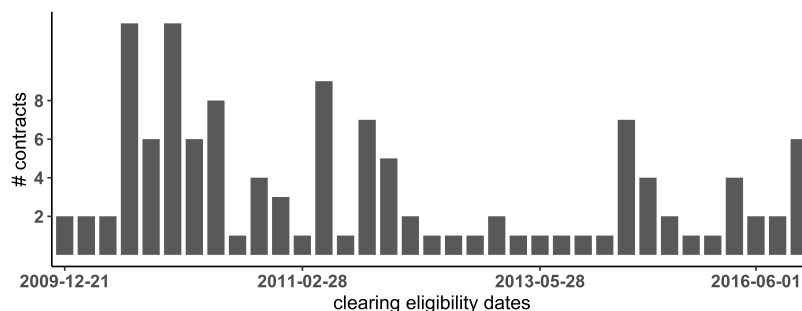

Weekly CDS gross outstanding positions and net outstanding positions are directly related to the amount of CDS trading in the corresponding week. The absolute weekly change in aggregate gross (net) outstanding positions constitutes the gross (net) trading volume in the respective week. To control for other determinants of CDS trading, we follow Oehmke and Zawadowski (2017). We collect corporate bond transaction data from the Trade Reporting and Compliance Engine (TRACE), which we clean according to Dick-Nielsen (2009, 2014). CDS quotes from Credit Market Analysis (CMA) and option implied stock volatility are from Bloomberg. We use these data sources to compute controls for the existence of arbitrage opportunities (*neg.basis*, a dummy taking on a value of 1 if the CDS-bond basis is negative, and *arbitrage*, the maximum absolute CDS-bond basis), hedging motives from the bond market (*bond_trading*, the cumulated weekly trading volume of all bonds issued by the reference entity), and speculation (*vola*, the weekly average option implied volatility of the underlying reference entity's stock).

2.2.1 Descriptive statistics

Data availability for the control variables limits the size of our dataset: Bond data via TRACE is only available for North American reference entities. CDS quotes and option implied stock volatility are also only available for a subset of reference entities and a limited time span. In summary, we obtain a full set of controls for 115 different CDS contracts between 2009 and 2017 for which we have 53991 week-contract observations. Table 2.2.1 gives summary statistics for the dependent variables and the control variables. We use the arithmetic average to compute mean values.

Table 2.2.1 shows that on average, CDS market participants hold around 14.1 bn gross notional volume per contract in a given week. These 14.1 billion result in roughly 1.11 billion net notional volume with an average weekly netting efficiency of 8.74%. Since we use arithmetic averages, the average netting efficiency does not equal the ratio of average gross and net positions.

We now consider the evolution of gross and net positions over time. Figure 2.2.2 shows the time series of cross-sectional averages of all reference entities that become clearing eligible in the 30 weeks before and after they become eligible for central clearing. The clearing date is indicated by the red vertical line. Panel A shows average gross and net positions and Panel B average netting efficiency. Gross positions increase sharply by around 1bn notional value for contracts that become

Table 2.2.1: Descriptive statistics of aggregate CDS positions, netting efficiency and corresponding control variables

This table shows descriptive statistics for our sample of CDS contracts. The sample consists of contracts for which data on the selected control variables are available. *gross_position* (*net_position*) is the cumulated outstanding gross (net) notional value of a CDS contract in billion (bn) United States dollar (USD) at the end of the respective week. *nett_eff* is the ratio of gross outstanding positions to net outstanding positions in percentage points. We also compute relative ratios of the dependent variables, which are defined as in Equation (2.5). *neg_basis* is a dummy variable which turns 1 if the CDS-bond basis is negative. *arbitrage* is the average weekly maximum arbitrage opportunity measured as the maximum absolute CDS-bond basis in percent. We calculate the CDS-bond basis as the difference between the CDS spread and the difference between the bond’s yield to maturity over the three month London Interbank Offer Rate (LIBOR), minus the three-month Overnight Index Swap (OIS). We take averages across daily values to obtain weekly values. In order to proxy hedging demand and speculation opportunities, we use *bond_trading*, the cumulative weekly trading activity in billion USD on the reference entity’s bonds across all issues, and *vola* which is the option implied volatility of the underlying reference entity’s stocks.

Statistic	N	Mean	St. Dev.	Min	Max
gross_position	53,991	14.105	12.165	0.169	128.958
net_position	53,991	1.112	0.871	0.043	7.365
nett_eff	53,991	8.736	3.091	3.007	43.020
gross_position_rell	53,991	0.894	0.662	0.042	6.908
net_position_rell	53,991	0.897	0.638	0.048	4.702
nett_eff_rell	53,991	0.964	0.288	0.232	4.292
vola	53,991	30.246	15.783	7.530	250.420
bond_trading	53,991	0.089	0.169	0.00000	2.743
arbitrage	53,991	3.256	72.702	0.001	16,350.410
neg_basis	53,991	0.054	0.227	0	1

eligible for central clearing during this 30-weeks’ time window after the start of central clearing eligibility. Net positions seem to be largely unaffected by central clearing eligibility as they continue their declining trend after contracts become eligible for central clearing. Consequently, we see that netting efficiency of clearing eligible contracts decreases by roughly one percentage point within only a few weeks after they become eligible for central clearing.

2.2.2 Comparison of data sample with DTCC top 1,000 dataset and with samples from related studies of the CDS market

To conclude the description of our data set, we compare our sample to the original DTCC sample of top 1,000 reference entities and to the samples of related studies of the CDS market. Doing so allows us to judge if our sub-sample is indicative of this larger segment of the CDS market and whether it is comparable to similar studies.

2.2. DATA SOURCES, DESCRIPTIVE STATISTICS AND SAMPLE COMPARISON

Figure 2.2.2: Time series of CDS gross positions, CDS net positions, and CDS netting efficiency 30 weeks prior to and after central clearing eligibility

These figures show average CDS gross and net positions (Panel A, in billion USD) and average CDS netting efficiency (Panel B, in percentages) 30 weeks prior to and after the beginning of central clearing.

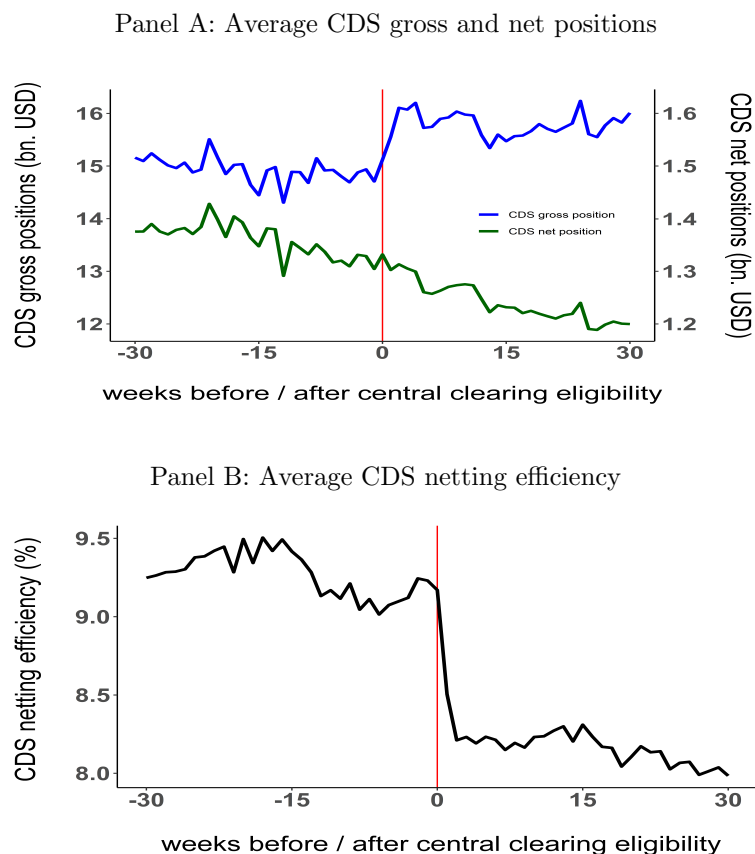

Table 2.2.2 shows that the distribution of reference entities across industries in our sample is comparable to the distribution of reference entities in the DTCC top 1,000 dataset and to related studies. Compared to the DTCC top 1,000 dataset, consumer goods, consumer services and healthcare are considerably over-represented and financials are notably under-represented. Industrials and utilities are slightly under-represented and the other industries are rather over-represented but these differences are small on an absolute scale. Apart from the utility sector, the industry weights in our sample never exceed the most extreme industry weights of other studies. In summary, we find that the industry distribution in our sample is comparable to the samples used in similar studies.

The effect of central clearing on netting efficiency may vary with the market liquidity of the contract. Since the contracts we are studying are subject to voluntary central clearing, market participants may tend to clear transactions in one contract

Table 2.2.2: Sample comparison by industry composition

In this table, we compare the industry composition of our sample dataset with the industry composition of the full DTCC top 1,000 dataset and of related studies on the CDS market. The industry classification is provided by the DTCC. In the first column, we report the share of reference entities belonging to the respective industry in the full DTCC top 1,000 dataset. The second column shows the share of reference entities belonging to the same industry in our sample. The remaining columns show the share of reference entities belonging to the same industry in related studies of the CDS market by Gehde-Trapp et al. (2015), Kaya (2016) and Loon and Zhong (2014). All values are in percentage points.

	DTCC Top 1,000 [%]	Our sam- ple [%]	Gehde- Trapp et al. (2015) [%]	Kaya (2016) [%]	Loon & Zhong (2014) [%]
Basic materials	7.14	8.84	14.70	9.40	5.30
Consumer goods	12.33	17.69	23.70	11.80	12.12
Consumer services	14.67	21.09	12.90	21.10	23.48
Energy	7.14	7.48	0.00	10.60	7.58
Financials	22.97	7.48	15.27	0.00	16.67
Healthcare	3.89	9.52	4.68	10.60	7.58
Industrials	14.47	13.61	12.28	17.60	13.64
Tech. & Telecomm.	3.70	6.12	5.22	10.70	9.09
Utilities	6.88	3.40	6.63	8.20	4.55
Other	0.00	0.00	4.50	0.00	0.00

rather with the CCP and transactions in another contract rather bilaterally. Bellia et al. (2018) examine a transaction-level dataset in order to identify contract characteristics of centrally cleared transactions. They find that more liquid contracts are less likely to be cleared centrally. That is why we examine the relative liquidity provision of dealers to CDS contracts in our sample compared to the DTCC top 1,000 dataset. To compare the distribution of our sample across gross position groups with the DTCC top 1,000 dataset, we divide both samples into quintiles in terms of CDS gross positions. We then determine the quintile to which a reference entity belongs for both our sample and the DTCC top 1,000 sample, and display the corresponding proportions in Table 2.2.3.

As expected, we here find that our sample consists of contracts to which dealers supply rather much liquidity. Reference entities in our dataset always belong to the same or to a higher quintile in the original dataset. E.g., a reference entity from the third quintile in our dataset is either in the first quintile (probability 6.9%) or in the second quintile (probability 93.1%) of the DTCC top 1,000 dataset. Considering the findings of Bellia et al. (2018), this may imply that the share of centrally cleared transactions could be lower for contracts in our sample compared to the total universe of CDS contracts. However, the upper triangular shape of the table implies that less widely held CDS contracts in our sample are also less widely

Table 2.2.3: Sample comparison by CDS gross positions

In this table, we assign the reference entities in our sample to CDS gross position quintiles for our dataset and the DTCC top 1,000 dataset according to average CDS gross position in our observation period. This table shows the share of reference entities in a given gross position quintile in our dataset (columns) and in a given CDS gross position quintile in the top 1,000 dataset (rows). All values are in percentage points.

		Our sample				
		Q1 [%]	Q2 [%]	Q3 [%]	Q4 [%]	Q5 [%]
DTCC Top 1,000	Q1 [%]	100	82.76	6.9	0	0
	Q2 [%]	0	17.24	93.1	100	20
	Q3 [%]	0	0	0	0	60
	Q4 [%]	0	0	0	0	20
	Q5 [%]	0	0	0	0	0

held in the DTCC top 1,000 sample. Hence, we expect that the results derived for our reduced sub-sample are representative of the full DTCC top 1,000 sample.

2.3 Empirical analysis

In this section, we analyze the impact of central clearing on gross and net positions and netting efficiency. Our baseline regression uses ordinary least squares (OLS) estimation with fixed effects. In additional specifications, we let the treatment effect vary between contracts with high and low pre-treatment netting efficiency and early- and late-adopter contracts.

2.3.1 Baseline model - OLS estimation with fixed effects

To explore our main question, we run the following regression model:

$$CDS_{i,t} = \alpha + \beta * CCP_{i,t} + \zeta * X_{i,t} + \gamma_t + \delta_i + \epsilon_{i,t} \quad (2.2)$$

$CDS_{i,t}$ denotes gross positions, net positions, and netting efficiency for CDS contract i at time t . $CCP_{i,t}$ is a dummy variable which takes the value of one if a contract is eligible for central clearing. $X_{i,t}$ contains the control variables *neg-basis*, *arbitrage*, *bond.trading*, and *vola*. We also interact *arbitrage* with *neg-basis* to account for the different ease of entering into an arbitrage position for positive and negative basis values. γ_t captures week fixed effects that control for contract-independent, time-varying effects, e.g. macroeconomic shocks. δ_i denotes contract fixed effects that capture contract-specific, time-constant effects, e.g. industry ef-

fects. We cluster standard errors by contract and weeks. The results for estimating Equation (2.2) are given in Table 2.3.1.

Table 2.3.1: The effect of central clearing on CDS gross positions, net positions, and netting efficiency

This table shows results for regression (2.2), the regression of gross positions, net positions, and netting efficiency on the central clearing dummy. The dependent variables and control variables are defined as in Table 2.2.1. The main independent variable, *CCP*, is a dummy variable which takes the value of 1 if a contract is eligible for central clearing. We include week and contract fixed effects. We cluster standard errors by contract and week. In parentheses, we display standard errors, which are computed according to Arellano (1987).

	<i>Dependent variable:</i>		
	gross_position	net_position	nett_eff
	(1)	(2)	(3)
CCP	3.210*** (0.590)	0.116** (0.052)	−0.837*** (0.286)
bond_trading	9.097** (4.310)	0.710** (0.310)	0.575 (0.514)
arbitrage	−0.0002*** (0.0001)	0.00000 (0.00001)	0.0003*** (0.0001)
neg_basis	−0.605 (0.381)	−0.010 (0.036)	0.008 (0.211)
vola	0.142*** (0.033)	0.007*** (0.002)	−0.007 (0.007)
arbitrage:neg_basis	−0.150 (0.207)	−0.015 (0.011)	−0.099** (0.046)
Contract FE	YES	YES	YES
Week FE	YES	YES	YES
F Statistics	496.808	444.153	224.4738
Observations	53,991	53,991	53,991
Adjusted R ²	0.850	0.836	0.719

*p<0.1; **p<0.05; ***p<0.01

Table 2.3.1 shows a strong increase in gross notional positions when contracts become eligible for central clearing. The effect is statistically highly significant and economically sizable: central clearing increases gross notional positions by 3.21 billion USD, or 22.76% of the mean gross position of 14.1 billion USD. In contrast, the statistically significant positive effect of central clearing on net positions amounts only to 115.5 million (mn) USD or 10.39% of the mean net position. The joint impact of these two effects on net and gross positions is considerable: netting efficiency decreases by 0.8371 percentage points (9.58% of the mean netting efficiency) and is statistically significant at the 1% level. Therefore, market participants seem to increase liquidity provision and their counterparty exposure with the beginning of central clearing.

The results for the control variables *bond_trading* and *vola*, are consistent with the findings of Oehmke and Zawadowski (2017) Both have a positive and highly statistically significant effect on CDS gross and net positions. We do not find any statistically significant effect of arbitrage considerations on net positions as documented in Oehmke and Zawadowski (2017) but a slight negative effect of *arbitrage* on gross positions.

For netting efficiency, we find a positive impact of *arbitrage* at the 1% significance level. The impact of the interaction between *arbitrage* and *neg_basis* is negative and statistically significant at the 5% level. However, the economic magnitude of these effects is negligible. The effects of the remaining control variables are not statistically significant. This is plausible since the control variables affect gross and net positions in a similar way.

In summary, the results show an increase in gross positions and net positions and a decrease in netting efficiency. Market participants trade more actively with the beginning of central clearing. Hence, central clearing induces market participants to build up higher inventories. This could reflect the willingness of market participants to trade with the arguably less risky CCP even at the cost of higher counterparty exposures. *Ceteris paribus*, the additional transaction with the CCP extends the risk intermediation chain in the interdealer market. If sufficient transactions are not cleared, this leads to a lower netting efficiency when compared to bilateral clearing. Dealer diversification may be too low prior to the introduction of central clearing as indicated by recent data (Office of the Comptroller of the Currency, 2016) and empirical studies (Peltonen et al., 2014), so that central clearing cannot yield a higher netting efficiency. Lower regulatory capital charges on centrally cleared positions can be an incentive for market participants to take on higher inventory in contracts that become clearing eligible.

In the following, we examine whether we find evidence for a less optimal market structure under central clearing and whether the effect of central clearing on netting efficiency changes with clearing eligibility duration.

2.3.2 The effect of central clearing for contracts of different degrees of pre-treatment netting efficiency

In this section, we test the hypothesis whether more efficiently netted bilateral markets are more negatively affected by the introduction of central clearing in terms of netting efficiency when compared to less efficiently netted bilateral markets. Cont

and Kokholm (2014) show that netting efficiency under central clearing is negatively affected by a high skewness of exposures prior to the introduction of central clearing. High skewness of exposures means that only a few market participants are the counterparties to the majority of trades. In this scenario, netting opportunities are more likely to occur within these dominant market participants compared to a scenario in which exposures are more equally distributed across market participants. We expect that more efficiently netted bilateral markets decrease stronger in netting efficiency with the beginning of central clearing eligibility compared to less efficiently netted bilateral markets.

In order to test this hypothesis, we calculate the average pre-clearing netting efficiency for each contract i during the whole period prior to its clearing eligibility date. We then define dummy variables $ne_quint1_i, ne_quint2_i, \dots, ne_quint5_i$ etc. that take on a value of 1 if contract i lies in the highest, second-highest, ..., lowest cross-sectional quintile in terms of average pre-clearing netting efficiency, and 0 otherwise. We run the following regression:⁵

$$\begin{aligned}
 CDS_{i,t} = & \alpha + \beta_1 * ne_quint1_i + \beta_2 * ne_quint2_i + \beta_3 * ne_quint3_i \\
 & + \beta_4 * ne_quint4_i + \beta_5 * CCP_{i,t} * ne_quint1_i \\
 & + \beta_6 * CCP_{i,t} * ne_quint2_i + \beta_7 * CCP_{i,t} * ne_quint3_i \\
 & + \beta_8 * CCP_{i,t} * ne_quint4_i + \beta_9 * CCP_{i,t} * ne_quint5_i \\
 & + \zeta * X_{i,t} + \gamma_t + \delta_i + \epsilon_{i,t}
 \end{aligned} \tag{2.3}$$

In contrast to Equation (2.2), $CCP_{i,t} * ne_quint1_i, CCP_{i,t} * ne_quint2_i$ etc. now allow us to identify the impact of the pre-clearing market structure on post-clearing netting efficiency as hypothesized by Cont and Kokholm (2014). We again include week and contract fixed effects, and the full set of control variables.

Tables 2.3.2 shows results for the different netting efficiency quintiles. We only find the negative effect of central clearing on netting efficiency for contracts that are in the two highest quintiles in terms of netting efficiency prior to central clearing eligibility. Central clearing decreases netting efficiency for contracts that were already netted relatively efficiently under bilateral clearing. The economic magnitude of the effect is lower for contracts in the second quintile compared to the first quintile. We test these results with a subsampling approach by dividing our sample into five

⁵Due to the inclusion of fixed effects, the individual coefficients of variables included in the interaction terms are not displayed in the regression output.

2.3. EMPIRICAL ANALYSIS

Table 2.3.2: Effect of central clearing on CDS positions and netting efficiency for different levels of pre-clearing netting efficiency (interaction approach)

This table shows regression results of the effect of central clearing on gross positions, net positions, and netting efficiency by pre-clearing netting efficiency quintiles (Equation (2.3)). We use five interaction terms of the CCP dummy and *ne_quint1*, *ne_quint2* etc. which indicate whether a contract belongs to first (second etc.) quintile in terms of pre-treatment netting efficiency. Control variables and week and contract fixed effects are as in Table 2.3.1 but are not reported here. We cluster standard errors by contract and week. In parentheses, we display standard errors which are computed according to Arellano (1987).

	<i>Dependent variable:</i>		
	gross_position	net_position	nett_eff
	(1)	(2)	(3)
CCP:ne_quint1	7.188*** (1.022)	0.267* (0.148)	-2.867*** (0.573)
CCP:ne_quint2	5.302*** (1.068)	0.195* (0.105)	-0.935** (0.393)
CCP:ne_quint3	5.327*** (1.224)	0.265*** (0.097)	-0.530 (0.407)
CCP:ne_quint4	1.817 (1.187)	0.143 (0.098)	0.315 (0.364)
CCP:ne_quint5	-0.282 (1.693)	0.072 (0.110)	0.731 (0.507)
Controls	YES	YES	YES
Contract FE	YES	YES	YES
Week FE	YES	YES	YES
F Statistics	466.3225	398.0655	185.0151
Observations	45,120	45,120	45,120
Adjusted R ²	0.858	0.838	0.705

*p<0.1; **p<0.05; ***p<0.01

subsamples according to quintiles of pre-clearing netting efficiency. Tables A.1-A.3 display results for the subsampling approach for gross positions, net positions and netting efficiency. The results are very similar. These results are in line with the findings of Cont and Kokholm (2014), who hypothesize a negative effect of central clearing for skewed CDS exposures in the interdealer market. Skewed CDS exposures mean that many positions are held with only one or very few dealers. This results in a high degree of netting efficiency under bilateral clearing. In this setting, the addition of a CCP to the market impairs netting efficiency. This corresponds to the situation depicted in Panel C of Figure 2.1.1. However, it could still be possible that more cleared trading volume is needed for a positive effect of central clearing on netting efficiency (Panel A and B of Figure 2.1.1), which is why we analyze the impact of clearing eligibility duration on netting efficiency in the next section.

2.3.3 The effect of central clearing on netting efficiency for cohorts of early- and late-adopter CDS contracts

In an additional analysis, we let the treatment effect vary between contracts that become clearing eligible at an earlier or later point in time. Duffie and Zhu (2011) show that the share of centrally cleared trading volume positively affects the effect of central clearing on netting efficiency. We expect the trading volume of CCPs and the corresponding economic effects to increase over time. Consequently, we expect the effect of central clearing on netting efficiency to be most pronounced for the first CDS contracts that are made eligible for central clearing. In order to test this hypothesis, we create five dummy variables that indicate whether a contract belongs to the first (second,..., fifth) quintile of contracts that becomes eligible for central clearing ($cdate_quint1_i, cdate_quint2_i, \dots, cdate_quint5_i$). We replace our original treatment dummy by five interaction terms between the original treatment dummy and the quintile dummies that indicate a relatively early or late clearing eligibility date. We also include all controls and fixed effects from our baseline regression:⁶

$$\begin{aligned}
 CDS_{i,t} = & \alpha + \beta_1 * cdate_quint1_i + \beta_2 * cdate_quint2_i + \beta_3 * cdate_quint3_i \\
 & + \beta_4 * cdate_quint4_i + \beta_5 * CCP_{i,t} * cdate_quint1_i \\
 & + \beta_6 * CCP_{i,t} * cdate_quint2_i + \beta_7 * CCP_{i,t} * cdate_quint3_i \\
 & + \beta_8 * CCP_{i,t} * cdate_quint4_i + \beta_9 * CCP_{i,t} * cdate_quint5_i \\
 & + \zeta * X_{i,t} + \gamma_t + \delta_i + \epsilon_{i,t}
 \end{aligned} \tag{2.4}$$

The results in Table 2.3.3 show that the negative effect of central clearing on netting efficiency is most pronounced for contracts that belong to the earlier cohorts of clearing eligible contracts. The coefficients for the first two quintiles is statistically significant and negative. Contracts in the other quintiles are not affected to a statistically significant extent. These results provide evidence that the effects of central clearing may materialize itself as trading activity of CCPs increases. Naturally, trading activity of CCPs may increase over time so that the effects of voluntary central clearing may be best observed using the early cohorts of clearing eligible contracts. The negative effect for earlier cohorts of clearing eligible contracts may point to the scenario in Panel C of Figure 2.1.1: if CDS market participants buy

⁶Due to the inclusion of fixed effects, the individual coefficients of variables included in the interaction terms are not displayed in the regression output.

2.4. ROBUSTNESS CHECKS

Table 2.3.3: Effect of central clearing on CDS positions and netting efficiency across quintiles of contracts according to their clearing eligibility date

This table shows regression results of the effect of central clearing on gross positions, net positions, and netting efficiency by quintiles of contracts according to their respective clearing eligibility dates (Equation (2.4)). We use five interaction terms of the CCP dummy and *cdate Quint1*, *cdate Quint2*, ..., *cdate Quint5*, which indicate whether a contract belongs to an earlier or later group of contracts that becomes eligible for central clearing. Control variables and week and contract fixed effects are as in Table 2.3.1 but are not reported here. We cluster standard errors by contract and week. In parentheses, we display standard errors, which are computed according to Arellano (1987).

	<i>Dependent variable:</i>		
	gross_position	net_position	nett_eff
	(1)	(2)	(3)
CCP:cdate Quint1	3.530*** (1.332)	0.081 (0.102)	−0.730** (0.336)
CCP:cdate Quint2	1.449 (1.460)	−0.207 (0.144)	−0.853** (0.419)
CCP:cdate Quint3	3.741*** (1.277)	0.163 (0.109)	−0.274 (0.330)
CCP:cdate Quint4	6.339*** (1.139)	0.458*** (0.121)	−0.707 (0.533)
CCP:cdate Quint5	3.293*** (1.012)	0.146** (0.072)	−0.659 (0.491)
Contract FE	YES	YES	YES
Week FE	YES	YES	YES
F Statistics	462.7866	423.4952	176.0695
Observations	46,761	46,761	46,761
Adjusted R ²	0.855	0.844	0.691

*p<0.1; **p<0.05; ***p<0.01

credit protection mainly from one or very few dealers prior to the beginning of central clearing, cleared trading volume may actually negatively affect netting efficiency under central clearing. However, the negative effect of central clearing on netting efficiency for the earliest cohort is smaller than for the second quintile. This could also point to positive effect of central clearing on netting efficiency for very high centrally cleared trading volumes that have not been reached by any of the CDS contracts in the voluntary central clearing regime.

2.4 Robustness checks

In this chapter, we present the results of four robustness checks. First, we re-run our baseline regressions with relative dependent variables that capture a potential effect of central clearing on uncleared contracts. Second, we create a matched sample

based on potential determinants of the CCP’s decision to make a CDS contract eligible for central clearing, and run our baseline model (Equation (2.2)) on this sample. In an additional specification, we take a subset of this matched sample by restricting the event window to eight weeks prior to and after the beginning of central clearing eligibility. Finally, we perform a placebo test by replacing the original clearing eligibility dates of all treated contracts with random dates between the beginning of our observation period and three months before the actual clearing eligibility date.

2.4.1 Relative netting efficiency

Central clearing should mainly affect contracts that actually become eligible for central clearing. However, it is also conceivable that non-eligible contracts show a reaction when other contracts become eligible for central clearing. For example, we could observe a decrease in net positions for non-eligible contracts which we would erroneously interpret as an increase of net positions for cleared contracts when estimating the Equations (2.2) and (2.3). Therefore, we now define all dependent variables at time t as the ratio of the dependent variable to the average value of the dependent variable for all uncleared contracts at time t :

$$\text{CDS}_{\text{rel},i,t} = \frac{\text{CDS}_{i,t}}{\text{CDS}_{\text{uncleared},t}} \quad (2.5)$$

We re-run the estimation of the regressions (2.2) and (2.3) with these new dependent variables. Tables 2.4.1 and A.4 give the coefficient estimates. All controls and fixed effects are as in Equations (2.2) and (2.3).

Table 2.4.1 shows similar results compared to those we observe in Table 2.3.1. For the overall effect of central clearing on gross positions, we obtain a statistically significant positive effect with an order of magnitude of 23.68% relative to the sample mean (compared to 22.76% in Table 2.3.1). For net positions, we again obtain a positive and statistically significant effect. Netting efficiency decreases by 11.09% (compared to 9.58% in Table 2.3.1). This effect is statistically highly significant. Across pre-clearing netting efficiency quintiles, the effect of central clearing on gross positions is more consistent in Table A.4 than in Table 2.3.2. Net positions are largely unaffected and netting efficiency displays a decrease even for the three highest quintiles of pre-clearing netting efficiency compared to two quintiles in Table 2.3.2.

2.4. ROBUSTNESS CHECKS

Table 2.4.1: Effect of central clearing on relative CDS positions and netting efficiency

This table shows regression results of the effect of central clearing on relative gross positions, relative net positions, and relative netting efficiency. We take the relative dependent variables which are defined in Table 2.2.1. The main independent variable, *CCP*, is a dummy variable which takes the value of 1 if a contract is eligible for central clearing. Control variables and week and contract fixed effects are as in Table 2.3.1. We cluster standard errors by contract and week. In parentheses, we display standard errors, which are computed according to Arellano (1987).

	<i>Dependent variable:</i>		
	gross_position_rel	net_position_rel	nett_eff_rel
	(1)	(2)	(3)
CCP	0.212*** (0.042)	0.082** (0.039)	−0.107*** (0.031)
bond_trading	0.228* (0.122)	0.392** (0.157)	0.037 (0.060)
arbitrage	−0.00000* (0.00000)	0.00000 (0.00001)	0.00003*** (0.00001)
neg_basis	−0.004 (0.019)	−0.002 (0.029)	−0.001 (0.020)
vola	0.005*** (0.001)	0.003** (0.001)	−0.001 (0.001)
arbitrage:neg_basis	−0.003 (0.007)	−0.007 (0.005)	−0.009** (0.004)
Contract FE	YES	YES	YES
Week FE	YES	YES	YES
F Statistics	795.9788	525.0655	152.06
Observations	53,991	53,991	53,991
Adjusted R ²	0.901	0.857	0.634

*p<0.1; **p<0.05; ***p<0.01

2.4.2 Matched sample analysis

We expect CCPs to select contracts for clearing eligibility based on risk characteristics of the contract and of the underlying reference entity. This introduces a selection bias to our original analysis. Slive et al. (2012) find that netting efficiency negatively affects the probability of a contract being selected for central clearing. This relation may bias our results towards finding a negative effect of central clearing on netting efficiency if we do not adjust for the selection bias. In accordance with the findings of Slive et al. (2012), we expect that CDS trading activity, netting efficiency and contract-specific risk affect the decision of a CCP to select contracts for clearing eligibility. We create a new sample based on pre-treatment values of gross positions, net positions, netting efficiency, stock volatility and bond trading volume. We use nearest-neighbor matching without replacement and with a caliper

of 0.1. This matching procedure allows us to reduce the difference in pre-treatment covariates by 55.62% to 98.93% (see Table A.6).

Table 2.4.2: Matched sample analysis on the effect of central clearing on CDS gross positions, net positions and netting efficiency

This table shows results for regression (2.2), the regression of gross positions, net positions, and netting efficiency on the central clearing dummy. The database for these results is a matched sample, conditioned by nearest-neighbor matching on the following variables: *gross_positions*, *net_positions*, *nett_eff*, *vola*, and *bond_trading*. The main independent variable, *CCP*, is a dummy variable which takes the value of 1 if a contract is eligible for central clearing. We include week and contract fixed effects. We cluster standard errors by contract and week. In parentheses, we display standard errors, which are computed according to Arellano (1987).

	<i>Dependent variable:</i>		
	<i>gross_position</i>	<i>net_position</i>	<i>nett_eff</i>
	(1)	(2)	(3)
CCP	2.340*** (0.549)	0.061 (0.044)	-0.725** (0.290)
bond_trading	2.173 (2.760)	0.217 (0.240)	0.330 (0.728)
arbitrage	-0.0001* (0.0001)	-0.00000 (0.00000)	0.0002*** (0.0001)
neg_basis	-0.380 (0.296)	0.006 (0.031)	0.100 (0.183)
vola	0.136*** (0.029)	0.008*** (0.002)	-0.004 (0.012)
arbitrage:neg_basis	-0.256* (0.151)	-0.021** (0.009)	-0.166* (0.087)
Contract FE	YES	YES	YES
Week FE	YES	YES	YES
F Statistics	232.687	222.537	132.0931
Observations	30,178	30,178	30,178
Adjusted R ²	0.826	0.820	0.729

*p<0.1; **p<0.05; ***p<0.01

Table 2.4.2 shows the results of our baseline model using the matched sample. The economic effects are smaller but still sizable, and show the same signs as in our baseline model. Apart from the insignificant coefficient of the CCP dummy on CDS net positions, the level of statistical significance for the CCP dummy in the different models is very similar to the results from our baseline model in Table 2.3.1.

2.4.3 Restricted event window around clearing eligibility date

In another model specification, we restrict the event window in the matched sample to eight weeks prior to and after the beginning of central clearing eligibility. A short observation period around the clearing eligibility date may lead to an underestimation of the true effect of central clearing eligibility on netting efficiency if the effect is positively correlated with the trading activity of CCPs. As a consequence, the economic effect of central clearing eligibility may increase over time as the results from Table 2.3.3 indicate. However, a short event window reduces the impact of effects that are unrelated to the clearing eligibility event. If we obtain results in this analysis that are similar to the results of our baseline analysis, we can be confident

Table 2.4.3: The effect of central clearing on CDS gross positions, net positions and netting efficiency (8 weeks pre-/post-clearing event window)

This table shows results for regression (2.2), the regression of gross positions, net positions, and netting efficiency on the central clearing dummy. We use the matched sample as in the results of Table 2.4.2 and restrict the observation period to eight weeks prior and after the start of central clearing eligibility. The main independent variable, *CCP*, is a dummy variable which takes the value of 1 if a contract is eligible for central clearing. We include week and contract fixed effects. We cluster standard errors by contract and week. In parentheses, we display standard errors, which are computed according to Arellano (1987).

	<i>Dependent variable:</i>		
	gross_position	net_position	nett_eff
	(1)	(2)	(3)
CCP	0.722*** (0.145)	0.035** (0.014)	-0.304*** (0.104)
bond_trading	-0.765 (0.467)	-0.085* (0.050)	0.235 (0.436)
arbitrage	0.043 (0.044)	0.003 (0.006)	-0.020 (0.035)
neg_basis	0.137 (0.217)	-0.009 (0.020)	-0.152 (0.150)
vola	0.011 (0.020)	-0.001 (0.002)	-0.016 (0.014)
arbitrage:neg_basis	-0.170 (0.191)	0.007 (0.014)	0.223 (0.158)
Contract FE	YES	YES	YES
Week FE	YES	YES	YES
F Statistics	654.7771	442.6016	131.0073
Observations	1,215	1,215	1,215
Adjusted R ²	0.994	0.991	0.970

*p<0.1; **p<0.05; ***p<0.01

that our baseline results are not significantly driven by confounding effects that are unrelated to the clearing eligibility event and not included as covariates.

Table 2.4.3 displays the results from our analysis using an eight-week observation period before and after the central clearing eligibility date. Naturally, the economic magnitude of the effect is smaller since the trading activity by CCPs and the corresponding economic effects are likely to increase over time (compare Table 2.3.3). However, the effects of central clearing on gross positions, net positions and netting efficiency remain statistically significant.

2.4.4 Placebo test

For the placebo test, we use the matched sample with a restricted event window of eight weeks prior to and after the beginning of central clearing eligibility. We select this model because it is the most restrictive specification, in which we find a statistically significant effect of central clearing on netting efficiency. To replace the actual event dates by placebo dates, we use all CDS contracts in our matched sample that become clearing eligible at some point in time. We replace their actual clearing eligibility dates by random dates between the beginning of our observation period and three months before their actual clearing dates.

Since central clearing is voluntary after the beginning of central clearing eligibility, the shift to central clearing and the observation of the corresponding economic effects can happen at any date after the beginning of central clearing eligibility. However, we should not be able to observe any systematic treatment effect on dates that lie before the actual clearing eligibility date. Excluding three months before clearing eligibility reduces anticipatory effects such as increased trading of uncleared contracts with the intention to novate them to the CCP after the clearing eligibility date (Akari et al., 2019). We replace the actual clearing dates with these random placebo dates, create the placebo CCP dummy accordingly and restrict the sample to eight weeks prior to and after the beginning of the placebo central clearing eligibility.

We run a regression on our placebo CCP dummy as well as on the controls and fixed effects from our baseline regression. We repeat this process 1,000 times and expect 10 (50; 100) statistically significant coefficients of our placebo CCP dummy on netting efficiency on a 1% (5%; 10%) significance level.

Table 2.4.4 displays the results of our placebo test. The results show that 12 (63; 114) placebo dummy coefficients are significant on a 1% (5%; 10%) significance

Table 2.4.4: Placebo test (netting efficiency)

This table shows the number of coefficients on different levels of statistical significance from our placebo test. For the placebo test, we replace the original treatment dates with random dates that lie between the beginning of our observation period and three months before the start of clearing eligibility. We use these placebo treatment dates in our regression model (2.2), in order to compute the loading on the placebo CCP dummy coefficient. We repeat this procedure 1,000 times and count the frequency of coefficients that are statistically significant at 1%, 5%, and 10% level. We expect 10 (50; 100) statistically significant coefficients of our placebo CCP dummy on netting efficiency on 1% (5%; 10%) significance level.

p value	# coefficients
$p < 0.01$	12
$p < 0.05$	63
$p < 0.1$	114

level, which is close to the expected values from the theory. These results provide evidence that our findings are not the result of a misspecified empirical model.

2.5 Summary and conclusion

We empirically study the effect of central clearing on gross and net positions as well as their ratio - netting efficiency - in the CDS market. Our empirical results clearly indicate that CDS market participants increase their gross positions and net positions with the commencement of central clearing. The economic effect of central clearing on gross positions, however, is substantially larger than its effect on net positions. As a result, netting efficiency decreases with central clearing eligibility. The impact is economically considerable and statistically significant. We observe this effect only for the contracts that are most efficiently netted prior to the introduction of central clearing. Furthermore, the negative effect of central clearing on netting efficiency seems to be observed only for contracts that are longer eligible for central clearing, meaning that higher centrally cleared trading volume may not finally lead to an increase in CDS netting efficiency. In summary, we show that on average central clearing increases the extent to which market participants are willing to take on counterparty exposures.

Our analysis opens up interesting avenues for future research. Theoretical models offer clear hypotheses on the reasons for the cross-sectional differences we document. Testing whether these suggested hypotheses can explain the cross-sectional differences is only straightforward when bilateral exposures between market participants can be observed. The availability of new exposure data under MiFID II will allow direct exploration of these hypotheses.

A Appendix to Chapter 2

Figure A.1: Overview on the impact of central clearing on netting efficiency in the CDS market through different economic channels

This figure visualizes how the introduction of central clearing can affect the determinants of CDS netting efficiency. Central clearing (grey frame) may affect both, CDS gross positions (large red box) and CDS net positions (large blue box). Central clearing affects CDS gross and net positions through different economic channels (small red/blue boxes). Using arrows and positive and negative signs, this figure also visualizes the economic mechanisms through which the impact of central clearing finally leads to an impact on gross or net positions (*ceteris paribus*, indicated by bold-bordered positive or negative sign) and CDS netting efficiency. For gross positions for example, central clearing may affect counterparty risk negatively. This in turn, leads to an increase in dealer competition and consequently to an increase in liquidity provision. As a result of increased liquidity provision, CDS gross positions may rise (bold-bordered positive sign) and netting efficiency decreases. Apart from the CDS market participants' choice of CDS gross and net positions, the number of CCPs (green) and the cleared trading volume (red/blue) affect CDS netting efficiency under central clearing.

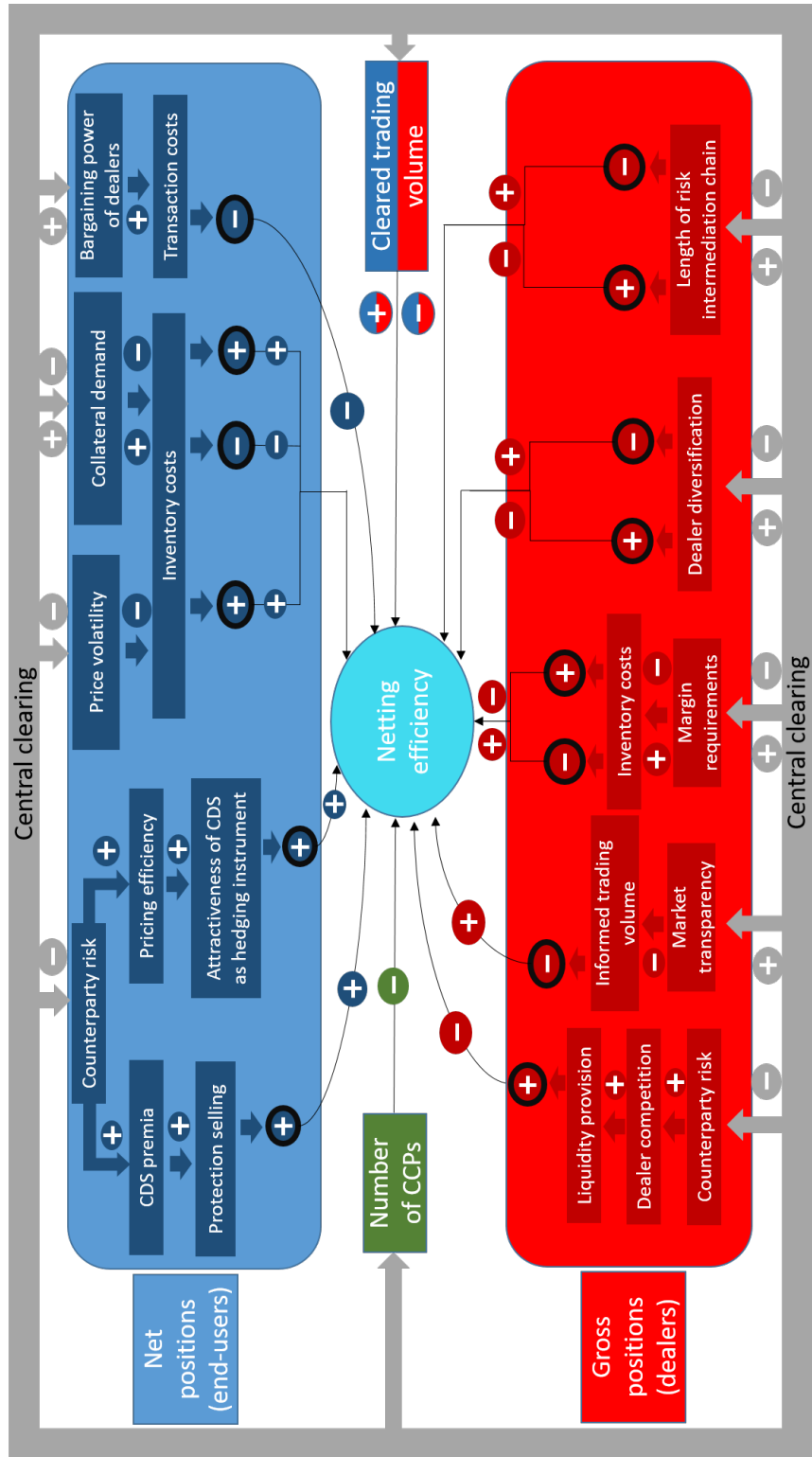

Table A.1: Effect of central clearing on CDS gross positions for different levels of pre-clearing netting efficiency (subsampling approach)

This table shows regression results of the effect of central clearing on CDS gross positions. We divide the original dataset into five subsamples according to the five quintiles by netting efficiency. Control variables and week and contract fixed effects are as in Table 2.3.1. We cluster standard errors by contract and week. In parentheses, we display standard errors, which are computed according to Arellano (1987).

	<i>Dependent variable:</i>				
	gross_position				
	quint1	quint2	quint3	quint4	quint5
	(1)	(2)	(3)	(4)	(5)
CCP	3.446*** (0.748)	3.051*** (0.718)	4.600*** (1.363)	5.320*** (1.703)	2.916 (1.805)
bond_trading	3.928 (2.679)	0.550 (1.843)	-2.030 (1.369)	20.215*** (4.601)	14.831 (10.369)
arbitrage	-0.00002 (0.00004)	-0.009 (0.014)	0.255** (0.116)	0.039*** (0.015)	-0.0003 (0.002)
neg_basis	0.377 (0.529)	0.555 (0.534)	0.063 (0.490)	-2.389*** (0.739)	2.738** (1.228)
vola	0.023 (0.054)	0.007 (0.060)	0.063* (0.038)	0.151** (0.065)	0.174** (0.068)
arbitrage:neg_basis	-0.691 (0.451)	-0.375 (0.756)	-0.139 (0.121)	-0.481 (0.343)	-1.297*** (0.398)
Contract FE	YES	YES	YES	YES	YES
Week FE	YES	YES	YES	YES	YES
F Statistics	113.9593	89.6488	116.138	112.9922	118.234
Observations	8,609	9,280	8,957	9,371	8,903
Adjusted R ²	0.866	0.825	0.864	0.855	0.867

Note:

*p<0.1; **p<0.05; ***p<0.01

A. APPENDIX TO CHAPTER 2

Table A.2: Effect of central clearing on CDS net positions for different levels of pre-clearing netting efficiency (subsampling approach)

This table shows regression results of the effect of central clearing on CDS net positions. We divide the original dataset into five subsamples according to the five quintiles by netting efficiency. Control variables and week and contract fixed effects are as in Table 2.3.1. We cluster standard errors by contract and week. In parentheses, we display standard errors, which are computed according to Arellano (1987).

	<i>Dependent variable:</i>				
	net_position				
	quint1	quint2	quint3	quint4	quint5
	(1)	(2)	(3)	(4)	(5)
CCP	0.060 (0.113)	0.019 (0.090)	0.120 (0.101)	0.289** (0.117)	0.335** (0.132)
bond_trading	0.659*** (0.243)	0.014 (0.246)	-0.080 (0.251)	1.264*** (0.419)	1.065 (0.840)
arbitrage	0.00000 (0.00001)	-0.001 (0.001)	0.025** (0.010)	0.001 (0.002)	-0.0002 (0.0002)
neg_basis	0.033 (0.085)	0.059 (0.051)	0.018 (0.042)	-0.123*** (0.032)	0.231** (0.097)
vola	-0.005 (0.010)	-0.001 (0.005)	0.006* (0.003)	0.009** (0.004)	0.009** (0.004)
arbitrage:neg_basis	-0.032 (0.064)	-0.015 (0.055)	-0.024** (0.010)	-0.059* (0.033)	-0.076*** (0.018)
Contract FE	YES	YES	YES	YES	YES
Week FE	YES	YES	YES	YES	YES
F Statistics	77.1991	56.2434	81.8749	141.7626	93.3688
Observations	8,609	9,280	8,957	9,371	8,903
Adjusted R ²	0.814	0.746	0.817	0.881	0.837

Note:

*p<0.1; **p<0.05; ***p<0.01

Table A.3: Effect of central clearing on CDS netting efficiency for different levels of pre-clearing netting efficiency (subsampling approach)

This table shows regression results of the effect of central clearing on CDS netting efficiency. We divide the original dataset into five subsamples according to the five quintiles by netting efficiency. Control variables and week and contract fixed effects are as in Table 2.3.1. We cluster standard errors by contract and week. In parentheses, we display standard errors, which are computed according to Arellano (1987).

	<i>Dependent variable:</i>				
	nett_eff				
	quint1	quint2	quint3	quint4	quint5
	(1)	(2)	(3)	(4)	(5)
CCP	-2.272*** (0.540)	-0.961* (0.537)	-0.566 (0.705)	-0.253 (0.412)	0.595 (0.468)
bond_trading	1.890 (2.110)	0.344 (0.965)	0.540 (0.769)	-0.104 (0.742)	0.558 (1.259)
arbitrage	0.0002*** (0.0001)	0.005 (0.006)	-0.012 (0.043)	0.005 (0.009)	-0.002*** (0.0005)
neg_basis	-0.339 (0.259)	-0.446 (0.353)	-0.365 (0.405)	-0.315 (0.229)	0.629** (0.314)
vola	-0.062* (0.035)	-0.016 (0.018)	0.031 (0.023)	0.009 (0.010)	-0.0005 (0.008)
arbitrage:neg_basis	0.353 (0.236)	-0.012 (0.196)	-0.303*** (0.065)	0.040 (0.280)	-0.146 (0.142)
Contract FE	YES	YES	YES	YES	YES
Week FE	YES	YES	YES	YES	YES
F Statistics	37.9494	40.9698	35.063	40.0569	25.7825
Observations	8,609	9,280	8,957	9,371	8,903
Adjusted R ²	0.680	0.680	0.653	0.673	0.579

Note:

*p<0.1; **p<0.05; ***p<0.01

Table A.4: The effect of central clearing on relative CDS positions and netting efficiency for different levels of pre-clearing netting efficiency (interaction approach)

This table shows regression results of the effect of central clearing on relative gross positions, relative net positions, and relative netting efficiency. We use five interaction terms of the CCP dummy and *ne_quint1* (*ne_quint2* etc.), which indicates whether a contract belongs to first (second etc.) quintile in terms of pre-treatment netting efficiency. Control variables and week and contract fixed effects are as in Table 2.3.1. We cluster standard errors by contract and week. In parentheses, we display standard errors, which are computed according to Arellano (1987).

	<i>Dependent variable:</i>		
	gross_position_rel (1)	net_position_rel (2)	nett_eff_rel (3)
CCP:ne_quint1	0.397*** (0.066)	0.206* (0.121)	-0.333*** (0.069)
CCP:ne_quint2	0.252*** (0.063)	0.105 (0.072)	-0.126*** (0.040)
CCP:ne_quint3	0.266*** (0.067)	0.145** (0.058)	-0.082** (0.036)
CCP:ne_quint4	0.164** (0.065)	0.101 (0.063)	0.015 (0.036)
CCP:ne_quint5	0.140** (0.062)	0.065 (0.067)	0.065 (0.048)
Controls	YES	YES	YES
Contract FE	YES	YES	YES
Week FE	YES	YES	YES
F Statistics	772.7658	486.9616	127.3079
Observations	45,120	45,120	45,120
Adjusted R ²	0.909	0.863	0.621

*p<0.1; **p<0.05; ***p<0.01

Table A.5: Panel unit root test on model residuals

This table shows p-values for fisher-type panel unit root (PUR) tests on the residuals of our baseline OLS fixed effects regression from Equation (2.2). Fisher-type tests test the null hypothesis, whether all individual time series in the panel dataset contain a unit root or not (Maddala and Wu, 1999). We conduct the panel unit root test for the panel of residuals from regression model (2.2). ‘***’ indicates statistical significance at the 1% level.”

Dep. var. model residuals	Fisher-type PUR test
gross_positions	0.0000***
net_position	0.0000***
nett_eff	0.0000***

A. APPENDIX TO CHAPTER 2

Table A.6: Covariate improvement due to nearest-neighbor matching)

We perform a nearest-neighbor matching without replacement (caliper: 0.1) in order to obtain a sample conditioned on the following variables: *gross_positions*, *net_positions*, *nett_eff*, *vola*, and *bond_trading*. The following panels provide a comparison between the full sample and the matched sample. Panel A shows the means in the covariates for treated units and untreated units and the mean difference between these groups for the full sample. Panel B shows the means in the covariates for treated units and untreated units and the mean difference between these groups for the matched sample. Panel C reports the reduction in the mean differences for the covariates of treatment group and control group when using the matched sample instead of the full sample.

Panel A: Difference in means of possible determinants of central clearing eligibility for full sample

	Means Treated	Means Control	Mean Diff
distance	0.692	0.464	0.229
gross_position	11.924	17.392	-5.468
net_position	0.947	1.361	-0.414
nett_eff	8.676	8.826	-0.150
vola	25.075	38.040	-12.965
bond_trading	0.069	0.119	-0.049

Panel B: Difference in means of possible determinants of central clearing eligibility after nearest-neighbor matching without replacement (caliper: 0.1)

	Means Treated	Means Control	Mean Diff
distance	0.599	0.581	0.018
gross_position	13.370	13.429	-0.059
net_position	1.079	1.083	-0.004
nett_eff	8.849	8.916	-0.066
vola	29.971	31.077	-1.106
bond_trading	0.079	0.082	-0.003

Panel C: Reduction in means of possible determinants of central clearing eligibility in percent after nearest-neighbor matching without replacement (caliper: 0.1)

	Mean Diff.
distance	92.067
gross_position	98.928
net_position	98.934
nett_eff	55.625
vola	91.470
bond_trading	94.872

3 Multidimensional effects of central clearing on CDS market liquidity and their economic channels - A regression discontinuity approach¹

Gregor Schoenemann²

Abstract

In this study, I analyze the effect of central clearing on market liquidity in the CDS market. This study extends existing literature by using semi-parametric and non-parametric regression discontinuity designs in order to isolate the effect of central clearing on measures of market tightness, market depth and market resiliency. In the baseline specification, I find evidence for a decrease in absolute bid-ask spreads and an increase in gross trading volume with the beginning of central clearing. Bid-ask spread resiliency decreases with the beginning of central clearing. However, we observe positive effects of central clearing on CDS market liquidity only for CDS contracts of high fundamental and liquidity risk, whereas low-risk contracts are negatively affected. Further results indicate that lower trading frictions may explain the positive effects of central clearing on CDS market liquidity. Especially the lower relevance of counterparty risk and lower regulatory capital charges seem to positively affect dealer competition and risk-taking capacity in the CDS market.

JEL classification: G12, G15, G18, G28

Keywords: Central clearing, credit default swaps, market liquidity, regression discontinuity

¹This is the author's original manuscript of an article published by Wiley in the Journal of Futures Markets available online at <https://doi.org/10.1002/fut.22288>.

²University of Hohenheim, Schurzstrasse 42, 70599 Stuttgart, Germany, e-Mail: gregor.schoenemann@uni-hohenheim.de

I am grateful for helpful comments from Monika Gehde-Trapp, Fabian Wahl, Jörg Schiller, Karsten Schweikert and participants at the Brown-Bag seminar Hohenheim 2018. I thank for database access to Bloomberg, TRACE and Eikon / Datastream provided by DALAHO Hohenheim.

3.1 Introduction

The purpose of this paper is to explore the effect of central clearing on the market liquidity of Credit Default Swaps. The introduction of central clearing counterparties may affect market liquidity through a change in clearing fees, margin requirements, regulatory capital charges, netting efficiency and post-trade transparency. These differences of centrally cleared markets compared to bilaterally cleared markets can affect order processing costs, inventory costs, adverse selection and bargaining costs. As a consequence, CDS dealers may adjust transaction costs (market tightness), the capacity to trade large orders (market depth), and the continuous provision of liquidity (market resiliency) once central clearing has been introduced. I find evidence that central clearing eligibility does not affect all dimensions of market liquidity in a similar way. While market tightness and market depth seem to increase with the beginning of central clearing, market resiliency seems to decrease in terms of bid-ask spreads.

Figure 3.1.1: Time series of aggregate CDS gross positions from 2009-2018

This figure shows time series of total CDS gross positions (red), dealers' CDS gross positions (blue), and clients' CDS gross positions (green). Time series are displayed in billion USD notional value.

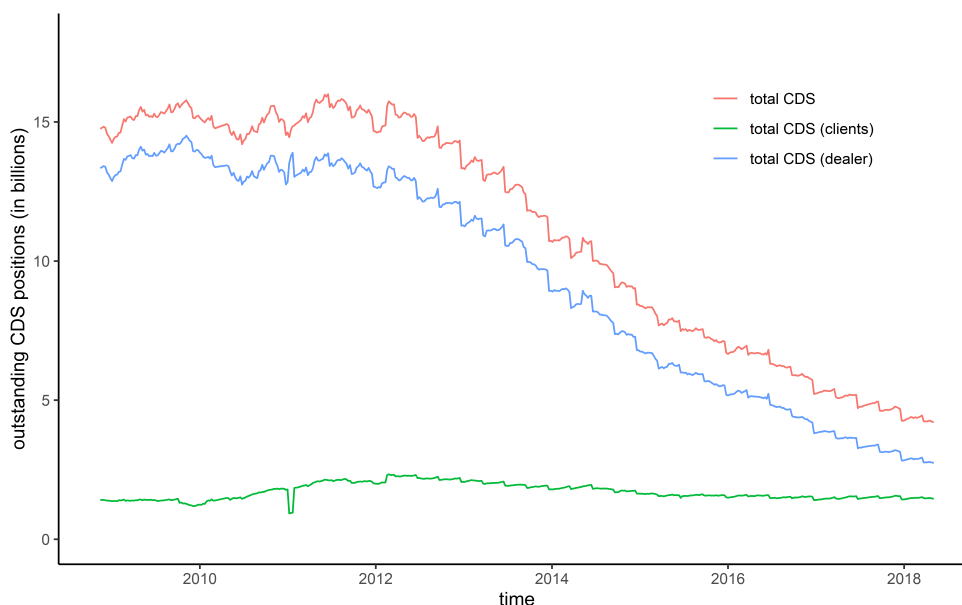

The effect of central clearing on CDS market liquidity is relevant due to the effect of market liquidity on price efficiency and financial stability. First, Figure 3.1.1 shows clearly that CDS dealers have withdrawn from the CDS market since the onset of the financial crisis.³ If dealers reduce liquidity provision in the CDS market, it remains unclear whether the CDS market can continue to keep its leading role in price discovery and price efficiency compared to the corporate bond market (Norden and Weber, 2004; Blanco et al., 2005; Zhu, 2006; Trapp, 2008; Forte and Peña, 2009; Coudert and Gex, 2010; Lin et al., 2011; Oehmke and Zawadowski, 2017; Schweikert, 2019). The financial crisis seems to have triggered an increase in risk aversion of CDS market participants towards the underlying risk sources of CDS contracts: fundamental risk, liquidity risk and counterparty risk. This increasing risk aversion may explain the shift from single-name CDS contracts to sovereign CDS contracts and the shift from bilateral clearing to central clearing on the CDS market (Aldasoro and Ehlers, 2018).

A very safe CCP that guarantees contractual payments at all times may restore the trust of market participants in the CDS market for single-name contracts and encourage trading activity. Second, researchers, regulators as well as investors and risk managers use CDS premia as a proxy for credit risk. Consequently, a divergence between CDS premia and the fundamental value of CDS contracts due to low market liquidity affects e.g. investment decisions or risk management decisions (Tang and Yan, 2007; Bongaerts et al., 2011; Buehler and Trapp, 2014; Arakelyan and Serrano, 2016). Third, market liquidity is important for the risk management of CCPs. When a clearing member of a CCP defaults, the position of that clearing member is terminated and offset against the collateral pledged by the defaulter. In this case, the CCP has an unbalanced CDS portfolio and is exposed to market and idiosyncratic risk. The CCP will seek to replace the defaulting position or to sell the offsetting position which may incur high replacement costs in case of low market liquidity. Consequently, low market liquidity may threaten financial stability as it prevents the efficient management of defaulting positions by the CCP.

This paper contributes to the literature by examining the impact of CDS central clearing on three different dimensions of market liquidity: market tightness, market depth, and market resiliency. To the best of my knowledge, previous studies only focus on market tightness and market depth (Slive et al., 2012; Loon and Zhong, 2014; Silva et al., 2018; Akari et al., 2019). The dimension of market resiliency may

³Increased use of trade compression may partly explain the decrease in gross positions. We see, however, a very similar development for net positions.

be of particular relevance for assessing the potential of a CCP to make the CDS market more robust in times of stress when market liquidity needs to be replenished within a short period of time. Furthermore, I use a regression discontinuity design in order to tackle a potential selection bias that is inherent to studies with a sample of CDS contracts which are selected by CCPs for clearing eligibility. Akari et al. (2019) show that the results on the impact of central clearing on CDS market liquidity are highly sensitive to the chosen methodological approach.

Empirical evidence on the effect of central clearing on market liquidity suggests a largely positive relationship (Slive et al., 2012; Loon and Zhong, 2014; Silva et al., 2018; Bernstein et al., 2019). However, Menkveld et al. (2015) find a statistically significant and negative liquidity effect of central clearing introduction for equities traded at NASDAQ OMX in terms of trading volume, and Akari et al. (2019) find no effect of central clearing on various measures of CDS market breadth and CDS market depth.

Authors of previous studies on the impact of central clearing on market liquidity recognize the existence of potential endogeneity issues in this research question, since the selection process by CCPs of contracts that become eligible for central clearing is unlikely to be randomized. Instead, the selection of contracts for central clearing by CCPs seems to be negatively affected by the market liquidity of the contract and default probability of the reference entity, and positively affected by the trading activity in the contract (Slive et al., 2012; Loon and Zhong, 2014; Silva et al., 2018). This is plausible because these contract characteristics affect the riskiness of a contract and, as a consequence, the risk of the CCP when engaging in the clearing of such a contract. Once voluntary central clearing is introduced, a second endogeneity issue emerges: market participants tend to clear CDS contracts of low liquidity risk rather bilaterally and CDS contracts of higher liquidity risk rather centrally (Bellia et al., 2018). This implies an endogenous relationship between the treatment effect of central clearing and CDS market liquidity that must be accounted for if the effect of central clearing on CDS market liquidity ought to be identified cleanly. An RDD allows to account for such a relationship between treatment effect and market outcome by the inclusion of an event time trend that can take different functional forms before and after treatment occurs. This allows me to capture adjustments in trading behavior of CDS market participants in anticipation of central clearing eligibility and to account for their decision which contracts to clear bilaterally or centrally after the introduction of central clearing, which depends on the liquidity risk of the respective contracts. These dynamic features make an RDD more flexible

3.1. INTRODUCTION

and suitable to tackle the endogeneity problem than static matching approaches (see Slive et al. (2012), Loon and Zhong (2014) and Silva et al. (2018)) or pure fixed effects models like in Akari et al. (2019). To the best of my knowledge, an RDD has not so far been used for examining the impact of central clearing on CDS market liquidity.

The economic hypotheses about the effect of central clearing on market liquidity are not straightforward. Changes in order processing costs, inventory costs, adverse selection and bargaining power of dealers due to the introduction of central clearing may positively or negatively affect market liquidity. Figure B.1 illustrates the potential effects of central clearing on CDS market liquidity and their economic channels. First, additional explicit costs like clearing fees of CCPs may generally increase bid-ask spreads and decrease trading volumes (Demsetz, 1968; Domowitz et al., 2001; Aitken et al., 2017) but can also foster dealer competition and decrease bid-ask spreads (Degryse et al., 2016, 2017). In contrast to bilateral trading agreements, CCPs require clearing fees for every trade as compensation for the provision of clearing and settlement services. Higher clearing fees decrease the profits of dealers for providing liquidity. As a result, dealers may widen bid-ask spreads in order to remain constant in profits per trade. Existing studies estimate that order-processing costs (e.g. clearing fees) make up between 30% and 60% of the bid-ask spread that is charged by dealers (Glosten and Harris, 1988; Stoll, 1989; Lin et al., 1995; Huang and Stoll, 1997; Brockman and Chung, 1999; Wang and Yau, 2000; Shang et al., 2018). That is why it is likely that dealers may respond to higher order processing costs for centrally cleared trades by widening bid-ask spreads. This may decrease both the attractiveness of the CDS market for end-users and trading activity. Indeed, Degryse et al. (2017) show that clearing fees affect transaction costs positively.

Second, the liquidity provision of dealers can change if central clearing alters inventory costs. Inventory costs may change under central clearing due to a change in margin requirements, netting efficiency, regulatory capital charges, and price volatility. CCPs may require more collateral due to their stricter risk management standards compared to bilateral clearing (Aitken and Singh, 2009; Brunnermeier and Pedersen, 2009; Singh, 2010; Heller and Vause, 2012; Sidanius and Zikes, 2012; Duffie et al., 2015). Higher collateral requirements tighten funding constraints of dealers and increase bid-ask spreads and decrease market depth and resiliency through lower liquidity provision of dealers (Brunnermeier and Pedersen, 2009; Singh, 2010; Heller and Vause, 2012). However, lower overall gross positions through increased netting opportunities of CCPs (Singh, 2010; Duffie and Zhu, 2011; Sidanius and Zikes, 2012; Cont and Kokholm, 2014), and lower regulatory capital charges for centrally cleared

trades can make inventory management more efficient and decrease inventory constraints of dealers (Minton et al., 2009; Hasan and Wu, 2016; Shan et al., 2017). This may increase the willingness of dealers to provide liquidity and allow dealers to absorb liquidity shocks faster so that markets become deeper and more resilient. While Shachar (2012) finds support for this hypothesis, Gehde-Trapp et al. (2015) do not find consistent empirical evidence for a persistent relation between inventory risk and CDS market liquidity.

Since central clearing of single-name contracts is voluntary, collateral demand after the introduction of central clearing eligibility depends in theoretical models on parameters that are unknown prior to the introduction of central clearing eligibility as follows: collateral demand decreases with cleared trading volume, number of clearing members, pre-clearing dealer diversification and number of cleared contracts but increases in the number of CCPs in the market (Heller and Vause, 2012; Duffie et al., 2015). This is why the effect of central clearing on market liquidity is inherently an empirical question.

Third, central clearing can affect market liquidity through its impact on post-trade transparency. Market transparency has been shown to affect market liquidity in theoretical models (Pagano and Roell, 1996) but also empirically, e.g. for the introduction of the post-trade reporting system TRACE on the corporate bond market (Edwards et al., 2007; Goldstein et al., 2007; Bessembinder and Maxwell, 2008; Asquith et al., 2019) or the introduction of Swap Execution Facility (SEF)s on the CDS market (Loon and Zhong, 2016). The dominating CCP on the market for CDS, ICE Clear Credit, publishes trading volume, open interest and settlement prices on a daily level for its cleared contracts for the last six months. This higher level of post-trade transparency may allow market participants to infer more information on supply and demand in the CDS market and to narrow bid-ask spreads accordingly. Informed traders, however, may refrain from CDS trading if they see information advantages disappear with increasing market transparency. This may negatively affect market liquidity and price efficiency (Pagano and Roell, 1996; Bloomfield and O'Hara, 1999; Lin, 2016). Furthermore, higher market transparency can decrease price volatility and reduce collateral demand. Additional public information may decrease the dispersion in the opinion of CDS market participants on the fundamental values of different CDS. High price volatility increases the maximum amount of collateral that must be held available by dealers in order to satisfy potential variation margin calls. Previous empirical studies find a decrease in price volatility with

the beginning of central clearing (Loon and Zhong, 2014; Mayordomo and Posch, 2016; Menkveld et al., 2015; Bernstein et al., 2019).

Fourth, central clearing may change the role of counterparty risk in the pricing of CDS contracts by CDS dealers. A high default probability of the protection seller impairs the value of the protection sold (Jarrow and Yu, 2001; Kraft and Steffensen, 2007; Arora et al., 2012; Morkoetter et al., 2012; Loon and Zhong, 2014; Du et al., 2019). Dealers may reflect their potentially incomplete knowledge about the default risk of their transaction partners in larger bid-ask spreads. Furthermore, low-risk dealers seem to have a competitive advantage and get compensated for their high creditworthiness (Du et al., 2019). If counterparty risk considerations become obsolete under central clearing due to the high creditworthiness of the CCP, bid-ask spreads may decrease due to a lower pricing consequence of counterparty risk and due to higher competition for order flow between low-risk and high-risk dealers (Slive et al., 2012; Loon and Zhong, 2014; Mayordomo and Posch, 2016).

Last, central clearing can affect profit margins of dealers per transaction by introducing a new tier into the OTC market structure. The exclusive access of clearing members to central clearing services may increase switching costs for clients to other dealers. Existing theoretical literature suggests that dealers use their bargaining power for charging higher transaction costs (Duffie et al., 2005; Hendershott et al., 2017; Eisfeldt et al., 2018; Üslü, 2019). In this case, we assume that central clearing increases the negotiating power of dealers, and increases transaction costs for clients. This is in line with the findings of Iercosan and Jiron (2017) who find higher transaction costs for clients that trade mostly with the same dealer. Higher transaction costs could drive end-users to trade on other markets for corporate credit (e.g. the market for corporate bonds) and decrease trading volume in the CDS market.

I use a panel dataset with time series of weekly bid-ask spreads, CDS premia and weekly trading volume for 100 different clearing eligible CDS contracts. The observation period reaches from 2009 to 2017. To provide a more comparable measure of market liquidity across contracts, I calculate relative bid-ask spreads by taking the ratio between the absolute bid-ask spread and the corresponding CDS premium. In order to be able to attribute a potential change in relative bid-ask spreads to the nominator (absolute bid-ask spreads) or the denominator (CDS premium), I examine the effect of central clearing on CDS premia separately. As proxies for market depth, I use gross and net trading volume from Trade Information Warehouse reports of the Depository Trust & Clearing Corporation and the Amihud illiquidity ratio for measuring price impact. I proxy the resiliency of CDS spreads, bid-ask

spreads and gross and net inventory by regressing their first differences on their levels in a rolling regression on a daily or weekly level. The coefficient of the lagged level variable indicates to what extent past liquidity shocks affect liquidity provision in the next period.

I find evidence that the effect of central clearing differs across different dimensions of market liquidity. My results indicate that the introduction of central clearing improves CDS market liquidity in terms of absolute bid-ask spreads and gross trading volume. Net trading volume and bid-ask spread resiliency seem to decrease. Bid-ask spreads decrease especially for contracts with high fundamental and liquidity risk, whereas bid-ask spread resiliency decreases only for contracts with low fundamental and liquidity risk. Gross trading volume decreases for the most strongly traded contracts and increases for the most thinly traded contracts prior to central clearing. Bid-ask spreads decrease for the most thinly and for moderately strongly traded contracts prior to central clearing.

My results suggest counterparty risk and inventory risk to be economic channels through which central clearing affects measures of CDS market liquidity and CDS premia to an economically significant extent. I examine the effect of three potential drivers of inventory costs: price volatility, netting efficiency and regulatory capital charges. Among these drivers of inventory costs, lower regulatory capital charges for centrally cleared positions seem to exhibit the strongest negative (positive) effect on inventory costs (CDS market liquidity) with the beginning of central clearing eligibility.

By looking at different dimensions of market liquidity, we can infer different economic implications. Dealers seem to compete more aggressively for order flow with the beginning of central clearing eligibility by posting narrower bid-ask spreads. This is in line with existing findings on increased quoting activity with the beginning of central clearing (Slive et al., 2012; Loon and Zhong, 2014; Mayordomo and Posch, 2016). This increasing competition for order flow in centrally cleared markets and subsequent lower profits per trade for dealers may incentivize dealers to generate higher trading volumes in order to keep total revenues from liquidity provision stable. The increase in CDS market liquidity seems to be attributable to a higher activity of high-risk dealers as suggested by Mayordomo and Posch (2016). Furthermore, dealers seem to increase liquidity provision for high-risk contracts. CCPs may reduce counterparty risk concerns of market participants so that high-risk dealers set themselves up as alternative dealers if they post competitive bid-ask quotes. The negative effect on bid-ask spread resiliency, however, questions how robust the

increase in liquidity provision is. Higher collateral demand may cause collateral shortage in the course of demand surges for CDS protection and prevent subsequent liquidity provision so that it takes market liquidity and prices longer to revert to former levels.

3.2 Data and sample creation

I create my sample of CDS contracts from the weekly TIW reports of the DTCC between November 2008 and December 2017 that capture data on the top 1,000 reference entities in terms of outstanding CDS positions and reflect 98% of all globally executed single-name CDS transactions (DTCC, 2019).

The weekly TIW reports allow me to collect a direct measure of CDS market depth: CDS gross trading volume and net trading volume. If dealers do not provide much liquidity at the best bid and ask prices but charge markups on large orders, the CDS market becomes a costly venue for trading large amounts of credit risk. This may reduce CDS trading volumes. In this scenario, the price impact is high as well. For measuring the price impact, I compute the weekly Amihud illiquidity ratio for every CDS contract individually. For this purpose, I collect daily CDS returns and collapse them to weekly frequency by computing the weekly average. I define the Amihud illiquidity ratio as the ratio between CDS returns ($cds_ret_{i,t}$) and CDS trading volume ($gross_trading_{i,t}$). Since every trade may have a price impact, no matter whether any fundamental risk is transferred or not, I choose CDS gross trading volume as denominator in my definition of the CDS Amihud illiquidity ratio:

$$cds_amihud_{i,t} = \frac{cds_ret_{i,t}}{gross_trading_{i,t}} \quad (3.1)$$

I measure market tightness by the absolute bid-ask spreads and relative bid-ask spreads (percentage spreads). I compute relative bid-ask spreads as the ratio of the absolute bid-ask ($ba_spread_{i,t}$) spread and the CDS mid quote ($cds_mid_{i,t}$):

$$pct_spread_{i,t} = \frac{ba_spread_{i,t}}{cds_mid_{i,t}} \quad (3.2)$$

If the CCP charges higher clearing fees, dealers may pass on these costs to customers. The smaller role of counterparty risk in the pricing of CDS contracts may reduce bid-ask spreads and increase CDS premia due to lower adverse selection. In order to disentangle these differential effects of central clearing on nominator and

denominator of the relative bid-ask spread, I use the CDS mid quote as a dependent variable in my empirical analysis as well, although it is not a direct measure of CDS market liquidity.

I compute different measures of market resiliency in order to examine how fast prices and market liquidity revert to former levels after deviations from these levels occur. The absorption of these deviations depends on the ability of dealers to manage their inventories efficiently and to identify informed and uninformed traders. Central clearing may alter the willingness of dealers to provide liquidity after liquidity shocks occurred by affecting the inventory management of dealers through higher netting efficiency and post-trade transparency. For this purpose, I regress the change in CDS mid quotes and the change in market liquidity from $t-1$ to t on the level of prices and market liquidity in $t-1$ (Kempf et al., 2015; Black et al., 2016). I denote the variables of interest as $Liq_{i,t}$ in the following regression:

$$\Delta Liq_{i,t} = \alpha + \beta_1 * Liq_{i,t-1} + \epsilon_{i,t} \quad (3.3)$$

Principally, dealers in OTC markets aim at a desired inventory level that varies between different dealers. They reduce liquidity provision if their inventory moves away from its desired position and try to move its inventory into the opposite direction of the past order flow. In efficient financial markets, prices float around an equilibrium price and revert to this price if deviations due to non-informed trades occur. This is why changes in the levels of the variables lead to an opposing effect in the change of the variables in next period. Consequently, we expect a negative coefficient between 0 and 1 for the regression-based resiliency measures. The higher the absolute value of the coefficient, the more resilient the market is. In order to capture the resiliency of different dimensions of market liquidity, I use the CDS mid quote as a measure for computing price resiliency, the absolute bid-ask spread as a measure of market liquidity and gross and net positions as measures of dealers' inventory in this regression. I use a rolling window of 90 days for the price resiliency and bid-ask spread regressions and a rolling window of twelve weeks for the inventory resiliency regressions. These daily (weekly) coefficients are my proxies for market resiliency. In order to facilitate the interpretation of the resiliency coefficients, I multiply them by -1 so that market resiliency increases in the coefficient.

3.2. DATA AND SAMPLE CREATION

Table 3.2.1: Descriptive statistics on measures of CDS market liquidity and corresponding control variables

This table shows summary statistics for our sample of CDS contracts. The sample consists of contracts for which data on the selected control variables are available. The first 10 variables are the dependent variables: *ba_spread* (*pct_spread*) is the average absolute (relative) bid-ask spread in basis points across all CDS contracts in a given week. *cds_mid* is the average mid quote in basis points across all CDS contracts in a given week. *gross_trading* (*net_trading*) is the average gross (net) trading volume for all CDS contracts in a given week (in million USD). *cds_amihud* is the average weekly Amihud illiquidity ratio, i.e. the ratio of CDS return to CDS trading volume for a given reference entity, across all CDS contracts. *price_res*, *ba_res*, *gross_inv_res*, and *net_inv_res* are the resiliency proxies for CDS mid quotes (*price_res*), bid-ask spreads (*ba_res*), gross positions (*gross_inv_res*) and net positions (*net_inv_res*) based on regression (3.3). *equity_amihud_ratio* is the weekly Amihud illiquidity ratio of the underlying reference entity's stock. As company-specific risk measures, I use the leverage of a reference entity (*leverage*), option implied stock volatility (*stock_vola*) and current market capitalization in million USD (*market_cap*). *bond_trading* is the cumulative weekly trading activity in million USD on the reference entity's bonds across all issues. *option_trading* is the cumulative weekly trading activity in million USD on the reference entity's stock options. *arbitrage* is the average weekly absolute CDS-bond basis in bps. We calculate the CDS-bond basis as the difference between the CDS spread and the bond's yield to maturity over the three-month LIBOR minus the three-month overnight index swap.

Statistic	N	Mean	St. Dev.
<i>ba_spread</i>	29,123	6.955	5.448
<i>pct_spread</i>	29,123	0.086	0.047
<i>cds_mid</i>	29,123	105.742	108.110
<i>gross_trading</i>	29,123	-20.258	242.763
<i>net_trading</i>	29,123	-1.434	25.661
<i>cds_amihud</i>	29,123	0.563	49.849
<i>price_res</i>	29,123	-0.042	0.043
<i>ba_res</i>	29,123	-0.454	0.273
<i>gross_inv_res</i>	29,123	-0.356	0.272
<i>net_inv_res</i>	29,123	-0.325	0.264
<i>stock_vola</i>	29,123	25.451	12.165
<i>market_cap</i>	29,123	48.677	58.309
<i>leverage</i>	29,123	6.405	19.173
<i>arbitrage</i>	29,123	215.720	493.395
<i>bond_trading</i>	29,123	120.520	205.100
<i>option_trading</i>	29,123	88.631	238.560
<i>amihud_ratio</i>	29,123	0.0002	0.020

CHAPTER 3. MULTIDIMENSIONAL EFFECTS OF CENTRAL CLEARING ON CDS MARKET LIQUIDITY AND THEIR ECONOMIC CHANNELS - A REGRESSION DISCONTINUITY APPROACH

I use all contracts for which data on my dependent variables are available. I use Bloomberg as data source for absolute CDS bid-ask spreads (*ba_spread*) and CDS mid quotes (*cds_mid*). I control for other determinants of CDS market liquidity, like hedging needs, speculation and arbitrage opportunities (Oehmke and Zawadowski, 2017). I employ these trading motives by controlling for bond trading volume (*bond_trading*), option implied stock volatility (*stock_vola*), and the size of the CDS-bond basis (*arbitrage*). I further control for liquidity spillovers from equity and option markets by including the stock amihud illiquidity ratio (*equity_amihud_ratio*) and option trading volume (*option_trading*) (Tang and Yan, 2007). I also control for firm-specific distance-to-default by including current market capitalization (*market_cap*) and leverage (*leverage*). Data on corporate bonds are gathered from the TRACE database and are cleaned according to Dick-Nielsen (2009, 2014). All other data are obtained from Bloomberg.

The lack of data availability in TRACE restricts my sample to US reference entities. Furthermore, I collapse our dataset to weekly observations since the TIW data are reported weekly. I obtain a full set of controls for 100 reference entities that amount to 29123 contract-week observations. Summary statistics are displayed in Table 3.2.1.

Table 3.2.1 shows that the average CDS premium for a reference entity in our sample amounts to 105.74basis point (bp) and the absolute bid-ask spread amounts to 6.96bp. Since the resiliency measures are already multiplied by -1 in Table 3.2.1, their original values are negative and between 0 and 1 as expected.

Figure 3.2.1 displays graphically the regression discontinuity of our dependent variables for our observation period without inclusion of controls. The x-axis is measured in weeks until (after) central clearing eligibility before (after) the red line. There seems to be a positive effect on CDS mid quotes and gross trading volume. Absolute and relative bid-ask spreads, CDS Amihud illiquidity ratio as well as resiliency measures for CDS spreads, bid-ask spreads and gross inventory seem to decrease. This would indicate that market tightness and market depth increases with the introduction of central clearing but market resiliency decreases.

3.2. DATA AND SAMPLE CREATION

Figure 3.2.1: Visualization of the regression discontinuity for different measures of CDS market liquidity

These plots show average values across all contracts for all of our dependent variables (grey dots) and corresponding linear regression functions (red line) prior to and after the start of central clearing eligibility.

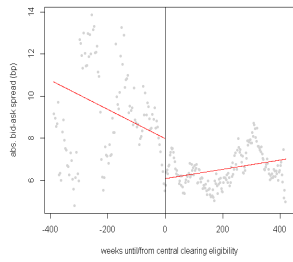

(a) abs. bid-ask spread

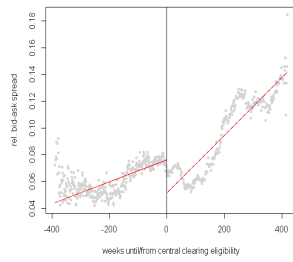

(b) rel. bid-ask spread

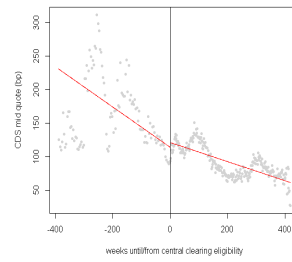

(c) CDS mid quotes

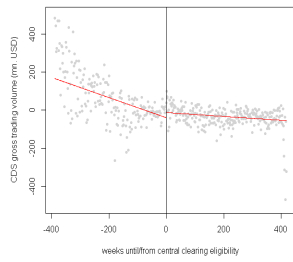

(d) Gross trading volume

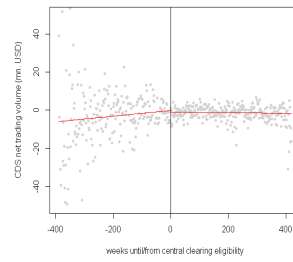

(e) Net trading volume

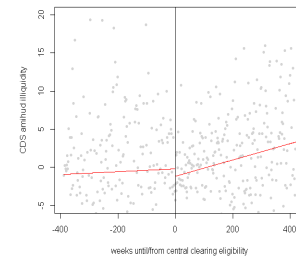

(f) CDS Amihud

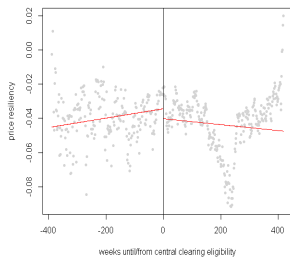

(g) Price resiliency

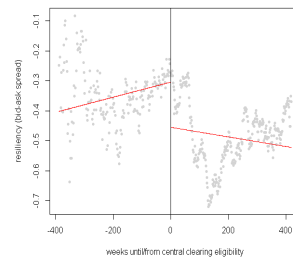

(h) Bid-ask resiliency

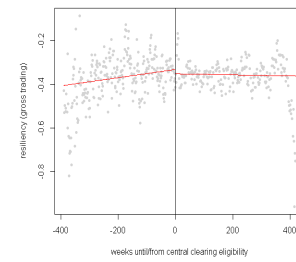

(i) Gross inventory resiliency

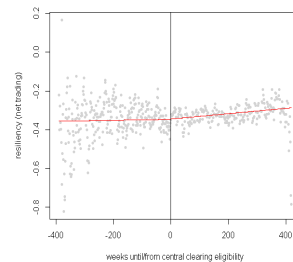

(j) Net inventory resiliency

3.3 Empirical analysis

In this section, I analyze the impact of central clearing on absolute and relative bid-ask spreads, CDS premia, trading volume and the resiliency of prices, bid-ask spreads and inventories using a semi-parametric regression discontinuity design. I also analyze whether the effect of central clearing on CDS market liquidity differs with the fundamental risk and liquidity risk of CDS contracts. Furthermore, I examine different potential channels through which central clearing may affect CDS market liquidity and CDS premia: counterparty risk, CDS spread volatility, netting efficiency and regulatory capital charges.

3.3.1 Baseline model - Semi-parametric regression discontinuity estimation

For the analysis of the effect of central clearing on market liquidity and CDS premia in the CDS market, I estimate the following regression:

$$\begin{aligned}
 \text{CDS}_{i,t} = & \alpha + \beta_1 * \text{CCP}_{i,t} + \beta_2 * \text{clearing_distance}_{i,t} \\
 & + \beta_3 * \text{CCP}_{i,t} * \text{clearing_distance}_{i,t} \\
 & + \zeta * X_{i,t} + \gamma_t + \delta_i + \epsilon_{i,t}
 \end{aligned} \tag{3.4}$$

$\text{CDS}_{i,t}$ denotes different variables related to the market liquidity of a CDS contract i at time t : absolute bid-ask spread (*ba_spread*), relative bid-ask spread (*pct_spread*), CDS mid quote (*cds_mid*), gross trading volume (*gross_trading*), net trading volume (*net_trading*), CDS Amihud illiquidity ratio (*cds_amihud*), and proxies for the resiliency of CDS spreads (*price_res*), bid-ask spreads (*ba_res*), gross inventory (*gross_inv_res*) and net inventory (*net_inv_res*). $\text{CCP}_{i,t}$ is a dummy variable which takes the value of one if a contract is eligible for central clearing. My running variable *clearing_distance* displays the weeks until (after) the beginning of central clearing. This variable takes on the value of 0 for a CDS contract in the week when the CDS contract is made eligible for central clearing. The week before (after) the introduction of central clearing, it takes on the value of -1 (1) etc. I only use linear regression discontinuity (RD) models since the use of higher-order polynomials may lead to imprecise estimates (Gelman and Imbens, 2017). $X_{i,t}$ contains the control variables *stock_vola*, *market_cap*, *leverage*, *arbitrage*, *bond_trading*, *option_trading* and *equity_amihud_ratio*. γ_t and δ_i capture week and contract fixed effects.

3.3. EMPIRICAL ANALYSIS

The inclusion of fixed effects allows me to control for general trends that affect all contracts, e.g. macroeconomic developments (financial crisis, interest rate changes, market volatility), and for contract-specific characteristics that do not change over time (e.g. industry).⁴ $CCP_{i,t}$ is my RD estimator.

I use the logarithm of the dependent variables ba_spread , pct_spread and cds_mid and of all control variables except $equity_amihud_ratio$ in order to fit the statistical properties of the data better to the linear RD model. For the resiliency measures, I perform a weighted least squares regression that uses the inverse standard errors of the estimated coefficients from (3.3) as observation weights. $clearing_distance$ models the relation between the event-related time and the dependent variable which is equivalent to an event time trend. The inclusion of the interaction term allows this relation to differ on both sides of the cutoff. The results for estimating Equation (3.4) are given in Table 3.3.1.

Table 3.3.1 displays results for the estimation of the effect of central clearing on CDS market liquidity in an RDD with covariates, fixed effects and clustered standard errors. The results show a significant decrease of absolute bid-ask spreads, CDS premia, net trading volume, and bid-ask spread resiliency with the beginning of central clearing eligibility and a statistically significant increase in gross trading volume. The remaining variables are unaffected by the start of central clearing eligibility. My baseline results indicate a positive effect of central clearing on CDS market liquidity when we consider the decrease in transaction costs and the increase in gross trading volume. The decrease in net trading volume and bid-ask spread resiliency points, however, to lower credit risk mitigation through the CDS market and lower continuous liquidity provision with the introduction of central clearing. The economic significance of the effects differs across dimensions of market liquidity. Whereas the negative effect of central clearing on bid-ask spreads and CDS spreads is economically small or even negligible (1.44% and 0.08% of statistical mean), the effect on resiliency measures and trading volume are economically considerable or even huge (7.19-10.39% for resiliency measures and 180.19–184.67% for trading volume measures).

⁴We check the residuals of the estimated models for panel unit roots. We can reject the null hypotheses that all time series contain a unit root. Table B.1 displays the results of the panel unit root tests.

CHAPTER 3. MULTIDIMENSIONAL EFFECTS OF CENTRAL CLEARING ON CDS MARKET LIQUIDITY AND THEIR ECONOMIC CHANNELS - A REGRESSION DISCONTINUITY APPROACH

Table 3.3.1: Effect of central clearing on market liquidity in a regression discontinuity design
 This table shows results for regression (3.4), the semi-parametric regression discontinuity estimate around the beginning of central clearing for all dependent variables. We use a polynomial function of order 1. I apply flexible polynomial functions, i.e. I allow the regression functions to be different on both sides of the cutoff. The main independent variable, *CCP*, is a dummy variable which takes the value of 1 if a contract is eligible for central clearing. I include week and contract fixed effects and cluster standard errors by contract and week. In parentheses, I display standard errors which are computed according to Arellano (1987).

	<i>Dependent variable:</i>									
	ba-spread (1)	pct-spread (2)	cds-mid (3)	gross-trading (4)	net-trading (5)	cds-amhd (6)	price-res (7)	ba-res (8)	gross-inv-res (9)	net-inv-res (10)
CCP	-0.100** (0.044)	-0.020 (0.037)	-0.080** (0.037)	37.410*** (11.670)	-2.584*** (0.767)	-0.509 (1.211)	-0.003* (0.002)	-0.047*** (0.017)	0.002 (0.018)	-0.023 (0.017)
clearing-distance	-0.094*** (0.034)	-0.031 (0.026)	-0.063* (0.037)	-35.898* (18.483)	-2.303* (1.394)	1.776 (4.130)	0.001 (0.002)	-0.010 (0.022)	-0.041 (0.029)	-0.055 (0.035)
log(leverage)	0.089 (0.055)	0.038 (0.052)	0.051 (0.044)	9.858 (6.029)	0.397 (0.576)	-0.217 (1.439)	0.003 (0.003)	0.031* (0.017)	-0.026 (0.019)	0.042*** (0.015)
log(stock-vola)	0.105*** (0.036)	-0.060*** (0.022)	0.163*** (0.038)	16.719*** (5.917)	-0.659 (0.611)	-0.372 (1.316)	-0.003** (0.001)	0.022 (0.018)	0.012 (0.015)	0.034* (0.020)
log(option-trading)	0.008 (0.008)	-0.013* (0.007)	-0.022** (0.006)	5.374*** (1.866)	0.073 (0.185)	0.421 (0.380)	0.0004 (0.0004)	0.003 (0.005)	-0.001 (0.004)	-0.007 (0.005)
log(market-cap)	-0.325*** (0.046)	0.338*** (0.041)	-0.663*** (0.048)	-7.613 (7.812)	-0.193 (0.427)	-0.153 (1.134)	-0.002 (0.002)	-0.052** (0.024)	-0.008 (0.013)	-0.008 (0.016)
log(bond-trading)	0.022*** (0.008)	-0.014* (0.007)	0.035*** (0.011)	5.394*** (1.573)	-0.197 (0.189)	-0.171 (0.366)	0.0003 (0.0004)	-0.004 (0.004)	0.004 (0.005)	-0.002 (0.004)
log(arbitrage)	-0.073*** (0.017)	0.030* (0.017)	-0.102*** (0.019)	-0.924 (2.921)	-0.211 (0.364)	0.296 (0.747)	0.001 (0.001)	-0.016 (0.013)	0.007 (0.008)	0.008 (0.010)
equity-amhd_ratio	-0.030 (0.028)	-0.034 (0.029)	0.004 (0.034)	26.905*** (10.154)	-4.404 (3.917)	-17.364*** (3.547)	0.008 (0.005)	-0.070*** (0.027)	-0.182** (0.082)	0.005 (0.031)
CCP:clearing-distance	0.001*** (0.0003)	0.001*** (0.0003)	0.0001 (0.0003)	0.480*** (0.154)	-0.019*** (0.006)	-0.003 (0.008)	-0.00001 (0.00001)	-0.0003 (0.0001)	-0.0002 (0.0001)	-0.0001 (0.0001)
Contract FE	YES	YES	YES	YES	YES	YES	YES	YES	YES	YES
Week FE	YES	YES	YES	YES	YES	YES	YES	YES	YES	YES
F Statistics	223.6779	218.4453	557.7363	47.2822	6.3008	1.9032	18.1111	40.0492	432.7571	327.2253
Observations	29,123	29,123	29,123	29,123	29,123	29,123	29,123	29,123	29,123	29,123
Adjusted R ²	0.811	0.808	0.915	0.472	0.093	0.017	0.248	0.430	0.893	0.863

*p<0.1; **p<0.05; ***p<0.01

3.3.2 The effect of central clearing on CDS market liquidity for CDS contracts of different fundamental risk and liquidity risk

In this section, I examine whether the effect of central clearing on CDS contracts differs with their fundamental risk or liquidity risk. For this purpose, I calculate the average CDS mid quote, bid-ask spread and gross trading volume over the whole pre-clearing period for all CDS contracts in the sample and sort all contracts into quintiles. A low quintile number for a contract indicates a low average pre-clearing risk measure, i.e. low CDS mid quote, low bid-ask spread or high gross trading volume. If the CCP is considered a highly creditworthy counterparty, CDS market participants may trust more in the delivery of the contractual payments for centrally cleared transactions in case of the default of a reference entity. Consequently, the introduction of central clearing may change the risk aversion of CDS market participants to trade contracts with high fundamental or liquidity risk, i.e. contracts for which the occurrence of a credit event and corresponding payment streams are more likely, transaction costs are higher and ease of trading lower.

A high default probability of the reference entity means a higher default probability of the protection-selling counterparty that has to make the contractual payments in case of a credit event. Low market liquidity of a contract leaves market participants with the choice of bearing the fundamental risk or taking on the counterparty risk and liquidity risk. If a CCP is available in the market, market participants may be more willing to buy such high-risk CDS contracts since they know that the CCP steps in if one of their original counterparties defaults. This reduced counterparty risk of the CCP may decrease liquidity risk because the counterparty is safe and decreases the need to sell CDS positions quickly in times of market stress, and may lower the fundamental risk if the CCP is creditworthy enough to guarantee all contractual payments. This is why high-risk contracts may benefit more strongly from the introduction of central clearing on the CDS market in terms of CDS market liquidity.

In order to analyze whether the market liquidity of CDS contracts with low fundamental and liquidity risk are differently affected by the introduction of central clearing than contracts with high fundamental or liquidity risk, I estimate the following fixed effects regression:⁵

⁵Due to the inclusion of fixed effects, the individual coefficients of variables included in the interaction terms are not displayed in the regression output.

$$\begin{aligned}
CDS_{i,t} = & \alpha + \beta_1 * risk_quint1_i + \beta_2 * risk_quint2_i + \beta_3 * risk_quint3_i \\
& + \beta_4 * risk_quint4_i + \beta_5 * CCP_{i,t} * risk_quint1_i \\
& + \beta_6 * CCP_{i,t} * risk_quint2_i + \beta_7 * CCP_{i,t} * risk_quint3_i \\
& + \beta_8 * CCP_{i,t} * risk_quint4_i + \beta_9 * CCP_{i,t} * risk_quint5_i \\
& + \zeta * X_{i,t} + \gamma_t + \delta_i + \epsilon_{i,t}
\end{aligned} \tag{3.5}$$

$CDS_{i,t}$ denotes the dependent variables for contract i at time t from regression (3.4). $risk_quint1_i$ ($risk_quint2_i$ etc.) is a dummy variable that indicates whether a contract belongs to the lowest (second-lowest etc.) quintile of contracts in terms of one of the above specified average pre-clearing fundamental or liquidity risk measures: CDS mid quote, bid-ask spread, and gross trading volume. I include week and contract fixed effects and the full set of control variables.

Table 3.3.2 shows results of the effect of central clearing on different quintiles of CDS contracts according to their fundamental risk in terms of their average pre-clearing CDS mid quote (mid_quint1_i , mid_quint2_i etc.). We see that the negative effect of central clearing on absolute bid-ask spreads can only be observed for CDS contracts with the highest fundamental risk, whereas the negative effect on bid-ask spread resiliency seems to only affect contracts with low fundamental risk. Furthermore, we see a positive effect of central clearing also in terms of the relative bid-ask spreads for CDS contracts with high fundamental risk and a negative effect on price resiliency for contracts with low fundamental risk. We see the positive effect of central clearing on gross trading volume for contracts of high and low fundamental risk. The results clearly show that the effect of central clearing introduction can differ across contracts with different risk characteristics and I find CDS market liquidity mainly to increase (decrease) for contracts of high (low) fundamental risk with the beginning of central clearing.

Table 3.3.3 shows results on the effect of central clearing on different quintiles of CDS contracts according to their liquidity risk in terms of their average pre-clearing absolute bid-ask spreads (ba_quint1_i , ba_quint2_i etc.). These results are very much in line with the results from Table 3.3.2. We only see positive effects of central clearing on CDS market liquidity in terms of absolute and relative bid-ask spreads and gross trading volume for contracts with high liquidity risk. Again, only low-risk contracts are negatively affected in terms of relative bid-ask spreads and bid-ask spread resiliency by the introduction of central clearing.

Table 3.3.2: RD effect of central clearing on CDS market liquidity across contracts for different levels of pre-clearing fundamental risk

This table shows results for regression (3.5), the fixed effects regression estimate of the effect of central clearing on CDS contracts in different pre-clearing mid quote quintiles for all dependent variables. I include week and contract fixed effects and cluster standard errors by contract and week. In parentheses, I display standard errors which are computed according to Arellano (1987).

	<i>Dependent variable:</i>									
	ba-spread	pct-spread	cds-mid	gross-trading	net-trading	cds-amihud	price-res	ba-res	gross-inv-res	net-inv-res
	(1)	(2)	(3)	(4)	(5)	(6)	(7)	(8)	(9)	(10)
log(leverage)	0.100** (0.051)	0.088* (0.046)	0.012 (0.046)	29.583** (13.561)	0.318 (0.687)	-1.438 (1.741)	-0.0003 (0.003)	0.032 (0.022)	-0.030 (0.023)	0.032* (0.018)
log(stock_vola)	0.113** (0.041)	-0.050** (0.025)	0.163** (0.040)	26.414** (9.085)	-1.135 (0.713)	-0.476 (1.439)	-0.003** (0.001)	0.020 (0.020)	0.014 (0.016)	0.033 (0.021)
log(option_trading)	0.005 (0.008)	-0.018** (0.007)	0.023** (0.006)	3.581* (2.030)	0.171 (0.202)	0.547 (0.386)	0.001** (0.0004)	0.003 (0.005)	-0.001 (0.005)	-0.007 (0.005)
log(market_cap)	-0.331** (0.045)	0.350** (0.046)	-0.681** (0.047)	-4.755 (7.132)	-0.073 (0.433)	-0.964 (1.140)	-0.004* (0.002)	-0.069** (0.026)	-0.001 (0.014)	-0.006 (0.018)
log(bond_trading)	0.019* (0.008)	-0.006 (0.007)	0.025** (0.011)	5.172** (1.694)	-0.285 (0.189)	-0.153 (0.377)	0.002 (0.004)	-0.005 (0.004)	-0.005 (0.005)	-0.002 (0.005)
log(arbitrage)	-0.060** (0.019)	0.042** (0.018)	-0.102** (0.022)	-0.948 (2.563)	0.098 (0.366)	-0.129 (0.828)	0.0004 (0.001)	-0.016 (0.008)	0.006 (0.015)	0.014 (0.010)
equity_amihud_ratio	-0.026 (0.024)	-0.006 (0.026)	-0.020 (0.026)	29.154** (9.615)	-4.095 (3.589)	-18.652** (3.199)	0.005 (0.003)	-0.075** (0.029)	-0.172** (0.083)	0.016 (0.032)
CCP:mid-quint1	-0.044 (0.047)	0.065* (0.037)	-0.109** (0.051)	37.398** (18.049)	-3.891* (2.061)	2.054 (2.886)	-0.008** (0.004)	-0.152** (0.041)	-0.043* (0.026)	-0.025 (0.039)
CCP:mid-quint2	0.041 (0.034)	-0.045 (0.082)	0.087 (0.085)	21.759** (10.522)	-0.252 (1.175)	-0.349 (1.708)	-0.001 (0.002)	-0.064** (0.026)	0.059* (0.032)	-0.003 (0.027)
CCP:mid-quint3	-0.023 (0.074)	0.019 (0.061)	-0.042 (0.062)	26.141* (13.622)	-1.163 (1.251)	0.530 (2.057)	-0.003 (0.003)	0.026 (0.029)	0.001 (0.028)	-0.029 (0.030)
CCP:mid-quint4	-0.193** (0.057)	-0.048 (0.055)	-0.145** (0.065)	1.244 (15.463)	-1.086 (1.113)	-1.820 (1.489)	-0.003 (0.002)	-0.019 (0.033)	0.001 (0.027)	0.009 (0.040)
CCP:mid-quint5	-0.299** (0.068)	-0.194** (0.065)	-0.104** (0.047)	34.778** (15.893)	-3.424* (2.033)	-1.853 (2.106)	-0.0001 (0.003)	-0.010 (0.030)	0.018 (0.029)	-0.037 (0.028)
Contract FE	YES	YES	YES	YES	YES	YES	YES	YES	YES	YES
Week FE	YES	YES	YES	YES	YES	YES	YES	YES	YES	YES
F Statistics	177.61	177.61	177.61	177.61	177.61	177.61	177.61	177.61	177.61	177.61
Observations	25,359	25,359	25,359	25,359	25,359	25,359	25,359	25,359	25,359	25,359
Adjusted R ²	0.791	0.809	0.911	0.451	0.092	0.016	0.258	0.422	0.899	0.872

*p<0.1; **p<0.05; ***p<0.01

CHAPTER 3. MULTIDIMENSIONAL EFFECTS OF CENTRAL CLEARING ON CDS MARKET LIQUIDITY AND THEIR ECONOMIC CHANNELS - A REGRESSION DISCONTINUITY APPROACH

Table 3.3.3: RD effect of central clearing on CDS market liquidity across contracts for different levels of pre-clearing liquidity risk (bid-ask spread)

This table shows results for regression (3.5), the fixed effects regression estimate of the effect of central clearing on CDS contracts in different pre-clearing bid-ask spread quintiles for all dependent variables. I include week and contract fixed effects and cluster standard errors by contract and week. In parentheses, I display standard errors which are computed according to Arellano (1987).

	<i>Dependent variable:</i>									
	ba-spread (1)	pcr-spread (2)	cds_mid (3)	gross_trading (4)	net_trading (5)	cds_amihd (6)	price_res (7)	ba_res (8)	gross_inv_res (9)	net_inv_res (10)
log(leverage)	0.099* (0.051)	0.074 (0.048)	0.025 (0.046)	32.665*** (14.142)	0.139 (0.656)	-1.363 (1.740)	-0.0005 (0.003)	0.036 (0.023)	-0.031 (0.023)	0.039*** (0.017)
log(stock_vola)	0.113*** (0.042)	-0.049** (0.025)	0.162*** (0.043)	25.692*** (8.972)	-1.152 (0.701)	-0.447 (1.422)	-0.003** (0.001)	0.017 (0.020)	0.014 (0.017)	0.034* (0.020)
log(option_trading)	0.008 (0.008)	-0.016** (0.006)	0.024*** (0.006)	3.430* (2.016)	0.181 (0.204)	0.574 (0.408)	0.001** (0.0004)	0.003 (0.005)	0.001 (0.005)	-0.008 (0.005)
log(market_cap)	-0.340*** (0.045)	0.343*** (0.045)	-0.583*** (0.047)	-5.304 (6.562)	-0.272 (0.462)	-0.983 (1.139)	-0.004* (0.002)	-0.060** (0.026)	-0.002 (0.014)	-0.004 (0.018)
log(bond_trading)	0.020** (0.008)	-0.007 (0.007)	0.027** (0.011)	5.148*** (1.679)	-0.281 (0.190)	-0.148 (0.386)	0.0002 (0.0004)	-0.005 (0.004)	-0.005 (0.005)	-0.002 (0.005)
log(arbitrage)	-0.057*** (0.019)	0.044** (0.018)	-0.101*** (0.022)	-0.807 (2.569)	0.065 (0.364)	-0.111 (0.835)	0.0004 (0.001)	-0.018 (0.015)	0.006 (0.008)	0.014 (0.010)
equity_amihd_ratio	-0.025 (0.025)	-0.006 (0.025)	-0.019 (0.026)	28.829*** (9.548)	-4.192 (3.627)	-18.468*** (3.232)	0.005 (0.003)	-0.073** (0.029)	-0.174*** (0.083)	0.007 (0.031)
CCP:ba-quint1	0.010 (0.030)	0.122** (0.054)	-0.112** (0.048)	27.634* (15.746)	1.189 (1.713)	-0.697 (2.509)	-0.005* (0.002)	-0.168*** (0.029)	0.005 (0.026)	-0.045 (0.028)
CCP:ba-quint2	-0.036 (0.043)	-0.055 (0.061)	0.019 (0.090)	2.556 (15.718)	-1.692 (1.574)	0.519 (1.752)	-0.002 (0.003)	-0.030 (0.032)	0.025 (0.032)	0.018 (0.032)
CCP:ba-quint3	0.054 (0.063)	0.040 (0.040)	0.014 (0.055)	12.183 (16.707)	-1.543 (1.370)	2.496 (2.193)	-0.002 (0.002)	-0.051* (0.029)	0.036* (0.019)	-0.061* (0.037)
CCP:ba-quint4	-0.193*** (0.060)	-0.028 (0.043)	-0.165** (0.073)	18.525 (16.407)	-3.140*** (2.708)	-2.443* (1.437)	-0.003 (0.002)	-0.014 (0.032)	-0.030 (0.026)	-0.016 (0.025)
CCP:ba-quint5	-0.312*** (0.062)	-0.243*** (0.067)	-0.069 (0.049)	43.499*** (14.306)	-2.231 (2.075)	-1.815 (1.973)	-0.001 (0.003)	0.002 (0.029)	0.017 (0.029)	0.011 (0.040)
Contract FE	YES	YES	YES	YES	YES	YES	YES	YES	YES	YES
Week FE	YES	YES	YES	YES	YES	YES	YES	YES	YES	YES
F Statistics	179.0208	179.0208	179.0208	179.0208	179.0208	179.0208	179.0208	179.0208	179.0208	179.0208
Observations	25.359	25.359	25.359	25.359	25.359	25.359	25.359	25.359	25.359	25.359
Adjusted R ²	0.792	0.811	0.910	0.451	0.092	0.016	0.257	0.425	0.899	0.872

*p<0.1; **p<0.05; ***p<0.01

Table 3.3.4: RD effect of central clearing on CDS market liquidity across contracts for different levels of pre-clearing liquidity risk (gross trading volume)

This table shows results for regression (3.5), the fixed effects regression estimate of the effect of central clearing on CDS contracts in different pre-clearing gross trading volume quintiles for all dependent variables. I include week and contract fixed effects and cluster standard errors by contract and week. In parentheses, I display standard errors which are computed according to Arellano (1987).

	<i>Dependent variable:</i>									
	(1)	(2)	(3)	(4)	(5)	(6)	(7)	(8)	(9)	(10)
	ba-spread	pct-spread	cds-mid	gross-trading	net-trading	cds-amihud	price_res	ba_res	gross_inv_res	net_inv_res
log(leverage)	0.146*** (0.047)	0.106** (0.046)	0.040 (0.051)	28.473** (11.818)	0.689 (0.667)	-0.929 (1.758)	-0.001 (0.003)	0.022 (0.020)	-0.029 (0.022)	0.037** (0.017)
log(stock_vola)	0.112*** (0.042)	-0.053** (0.025)	0.165*** (0.042)	25.634*** (8.710)	-1.082 (0.694)	-0.493 (1.406)	-0.003** (0.001)	0.017 (0.020)	0.014 (0.017)	0.036* (0.020)
log(option_trading)	0.005 (0.008)	-0.019*** (0.007)	0.023*** (0.006)	4.389** (2.107)	0.174 (0.205)	0.529 (0.380)	0.001* (0.0004)	0.003 (0.005)	-0.001 (0.005)	-0.007 (0.005)
log(market_cap)	-0.330*** (0.046)	0.342*** (0.047)	-0.673*** (0.045)	-2.955 (6.548)	-0.207 (0.445)	-0.722 (1.120)	-0.003* (0.002)	-0.003** (0.027)	-0.003 (0.014)	-0.004 (0.017)
log(bond_trading)	0.020** (0.008)	-0.007 (0.007)	0.027* (0.011)	4.911*** (1.590)	-0.250 (0.184)	-0.147 (0.373)	0.0002 (0.0004)	-0.004 (0.004)	-0.005 (0.005)	-0.002 (0.005)
log(arbitrage)	-0.059*** (0.019)	0.043** (0.018)	-0.102*** (0.022)	-1.032 (2.544)	0.073 (0.359)	-0.156 (0.839)	0.0004 (0.001)	-0.019 (0.015)	0.006 (0.008)	0.014 (0.010)
equity_amihud_ratio	-0.033 (0.023)	-0.004 (0.027)	-0.029 (0.026)	26.834*** (9.816)	-4.197 (3.906**)	-18.730*** (3.216)	0.005 (0.003)	-0.075** (0.029)	-0.182** (0.085)	0.009 (0.030)
CCP:gross.quint1	-0.044 (0.036)	0.014 (0.044)	-0.058 (0.051)	-79.887*** (25.007)	3.906** (1.719)	-0.931 (1.932)	0.001 (0.003)	-0.019 (0.032)	0.064*** (0.024)	-0.007 (0.032)
CCP:gross.quint2	-0.240*** (0.056)	-0.033 (0.039)	-0.206*** (0.051)	3.423 (12.489)	-6.727*** (1.702)	-3.394* (1.908)	-0.002 (0.003)	-0.074** (0.031)	-0.035 (0.025)	-0.059** (0.029)
CCP:gross.quint3	-0.102 (0.083)	-0.023 (0.080)	-0.080 (0.074)	25.650* (13.707)	-2.036** (0.881)	1.163 (1.469)	-0.003 (0.002)	-0.016 (0.029)	0.009 (0.031)	-0.033 (0.022)
CCP:gross.quint4	-0.072 (0.064)	-0.128* (0.065)	0.056 (0.061)	42.174*** (11.321)	-0.707 (1.146)	0.062 (2.095)	-0.002 (0.003)	-0.024 (0.025)	0.014 (0.025)	0.030 (0.038)
CCP:gross.quint5	-0.149*** (0.045)	-0.017 (0.043)	-0.133*** (0.037)	88.189*** (18.149)	-0.519 (1.231)	-1.643 (2.579)	-0.006*** (0.002)	-0.091** (0.038)	0.026 (0.031)	-0.023 (0.030)
Contract FE	YES	YES	YES	YES	YES	YES	YES	YES	YES	YES
Week FE	YES	YES	YES	YES	YES	YES	YES	YES	YES	YES
F Statistics	173.3918	173.3918	173.3918	173.3918	173.3918	173.3918	173.3918	173.3918	173.3918	173.3918
Observations	25,359	25,359	25,359	25,359	25,359	25,359	25,359	25,359	25,359	25,359
Adjusted R ²	0.787	0.807	0.911	0.454	0.093	0.016	0.258	0.419	0.809	0.872

*p<0.1; **p<0.05; ***p<0.01

Table 3.3.4 shows results on the effect of central clearing on different quintiles of CDS contracts according to their liquidity risk in terms of their average pre-clearing gross trading volume (*gross_quint1_i*, *gross_quint2_i* etc.). These results show a negative effect of central clearing on absolute bid-ask spreads for contracts that are strongly traded and for contracts that are thinly traded before the introduction of central clearing. Interestingly, we see a strong positive effect of central clearing eligibility on gross trading volume for contracts that are thinly traded before the introduction of central clearing but a strong negative effect on contracts that are strongly traded before the introduction of central clearing. These results may point to a shift in trading volume from low-risk contracts to high-risk contracts, that may lead to a higher risk in the CDS portfolios of CDS market participants. Resiliency measures largely decrease for contracts of different pre-clearing gross trading volume. Only gross inventory resiliency increases for low-risk contracts.

3.3.3 The effect of counterparty risk and inventory risk on CDS market liquidity before and after the introduction of central clearing

My results show effects of CDS central clearing on all three dimensions of market liquidity. In this section, I would like to examine potential economic channels for the effects of central clearing on market liquidity that we observe. One reason could be that the counterparty risk of dealers becomes less relevant for price discovery and trading activity under central clearing due to the uniform counterparty risk of the CCP to all CDS market participants. Furthermore, netting efficiency may affect trading activity and liquidity provision due to the elimination or build-up of redundant positions. The volatility of CDS spreads may affect market liquidity differently under central clearing compared to bilateral clearing due to a change in collateralization costs. Last, regulatory capital charges differ for centrally cleared positions and may change inventory risk-taking capacity of CDS market participants.

3.3.3.1 The effect of central clearing on CDS market liquidity through counterparty risk

I examine the effect of counterparty risk on CDS market liquidity before and after central clearing eligibility by estimating the following regression:

$$\begin{aligned}
 CDS_{i,t} = & \alpha + \beta_1 * CCP_{i,t} + \beta_2 * clearing_distance_{i,t} \\
 & + \beta_3 * CCP_{i,t} * clearing_distance_{i,t} \\
 & + \beta_4 * G14_cdsmid_mean_t \\
 & + \beta_5 * G14_cdsmid_mean_t * CCP_{i,t} \\
 & + \zeta * X_{i,t} + \gamma_t + \delta_i + \epsilon_{i,t}
 \end{aligned} \tag{3.6}$$

$CDS_{i,t}$ denotes the dependent variables for contract i at time t from regression (3.4). $G14_cdsmid_mean_t$ is our proxy for counterparty risk: the average CDS premium of the G14 CDS dealers in a given week. The additional interaction term estimates the effect of this variable on our measures of market liquidity after the beginning of central clearing. The other variables are as described above.

Table 3.3.5 displays results for the estimation of an RD on the effect of central clearing on CDS market liquidity with the inclusion of counterparty risk as control variable. In order to assess the effect of counterparty risk on CDS market liquidity before and after the introduction of central clearing, I jointly consider the coefficients $G14_cdsmid_mean_t$, the interaction term $G14_cdsmid_mean_t * CCP_{i,t}$ and the difference in the treatment effect ($CCP_{i,t}$) between Table 3.3.1 and Table 3.3.5. The change in $CCP_{i,t}$ from Table 3.3.1 to Table 3.3.5 is relevant since any effect from the new covariate loads on $CCP_{i,t}$ in regression (3.4) so that the respective change in $CCP_{i,t}$ reflects the effect of counterparty risk in regression (3.6). I follow this procedure for the inclusion of CDS volatility and netting efficiency in later regressions.

We see a statistically significant positive baseline effect of counterparty risk on absolute and relative bid-ask spread. The interaction terms show that, given the introduction of central clearing, counterparty risk positively affects CDS market liquidity as it decreases absolute and relative bid-ask spreads and increases net trading volume. Still, counterparty risk exhibits a statistically significant negative effect on gross trading volume and bid-ask spread resiliency under central clearing. However, the effects are economically marginal.

CHAPTER 3. MULTIDIMENSIONAL EFFECTS OF CENTRAL CLEARING ON CDS MARKET LIQUIDITY AND THEIR ECONOMIC CHANNELS - A REGRESSION DISCONTINUITY APPROACH

Table 3.3.5: Counterparty risk as an economic channel for the effect of central clearing on CDS market liquidity
 This table shows results for regression (3.6), the semi-parametric regression discontinuity estimate of the effect of central clearing on CDS market liquidity for all dependent variables. I use a polynomial function of order 1. I apply flexible polynomial functions, i.e. I allow the regression functions to be different on both sides of the cutoff. The main independent variable, *G14-cdsmid_mean*, is the weekly average CDS spread across all G14 CDS dealers. I include week and contract fixed effects. I cluster standard errors by contract and week. In parentheses, I display standard errors which are computed according to Arellano (1987).

	<i>Dependent variable:</i>									
	ba-spread	pct-spread	cds_mid	gross_trading	net_trading	cds_aminhd	price_res	ba_res	gross_inv_res	net_inv_res
	(1)	(2)	(3)	(4)	(5)	(6)	(7)	(8)	(9)	(10)
CCP	0.131 (0.085)	0.236*** (0.067)	-0.105** (0.053)	80.496*** (26.859)	-5.168*** (1.222)	0.692 (2.278)	-0.005 (0.004)	0.083* (0.043)	0.054 (0.039)	-0.012 (0.038)
clearing_distance	-0.090*** (0.035)	-0.028 (0.025)	-0.063* (0.036)	-35.848* (18.566)	-2.378* (1.410)	1.632 (4.129)	0.0005 (0.002)	-0.011 (0.022)	-0.040 (0.028)	-0.056 (0.035)
G14.cdsmid_mean	0.006*** (0.002)	0.005*** (0.002)	0.001 (0.001)	-0.455 (1.193)	-0.182 (0.249)	-0.437 (0.288)	-0.0002 (0.0002)	-0.002* (0.001)	-0.004 (0.003)	-0.001 (0.002)
log(leverage)	0.095* (0.055)	0.045 (0.053)	0.050 (0.044)	10.973* (6.366)	0.333 (0.576)	0.180 (1.442)	0.003 (0.003)	0.034** (0.016)	-0.025 (0.019)	0.042*** (0.015)
log(stock-vola)	0.099*** (0.035)	-0.067*** (0.022)	0.166*** (0.038)	15.683*** (5.571)	-0.595 (0.599)	-0.397 (1.322)	-0.003** (0.001)	0.022 (0.018)	0.011 (0.015)	0.034* (0.021)
log(option-trading)	0.008 (0.008)	-0.014* (0.007)	0.022*** (0.006)	5.324*** (1.880)	0.078 (0.186)	0.423 (0.379)	0.0004 (0.0004)	0.003 (0.005)	-0.001 (0.004)	-0.007 (0.005)
log(market_cap)	-0.321*** (0.046)	0.342*** (0.040)	-0.663*** (0.048)	-6.933 (8.165)	-0.232 (0.435)	-0.130 (1.130)	-0.002 (0.002)	-0.052** (0.024)	-0.006 (0.013)	-0.010 (0.016)
log(bond-trading)	0.022*** (0.008)	-0.014** (0.007)	0.035*** (0.011)	5.389*** (1.616)	-0.197 (0.189)	-0.172 (0.364)	0.0003 (0.0004)	-0.004 (0.004)	-0.004 (0.005)	-0.002 (0.004)
log(arbitrage)	-0.072*** (0.018)	0.030* (0.017)	-0.102*** (0.019)	-0.883 (3.168)	-0.217 (0.358)	0.291 (0.752)	0.001 (0.001)	-0.015 (0.012)	0.007 (0.008)	0.008 (0.010)
equity_aminhd_ratio	-0.043 (0.026)	-0.047* (0.028)	0.005 (0.035)	25.295** (10.222)	-4.225 (3.951)	-17.242*** (3.533)	0.008* (0.005)	-0.076*** (0.028)	-0.188** (0.083)	0.005 (0.031)
CCP-clearing_distance	0.0005* (0.0003)	0.0004 (0.0002)	0.0001 (0.0003)	0.418*** (0.136)	-0.016*** (0.006)	-0.005 (0.009)	-0.00001 (0.00002)	-0.0005*** (0.0001)	-0.0003*** (0.0001)	-0.0001 (0.0001)
CCP-G14.cdsmid_mean	-0.002*** (0.001)	-0.002*** (0.0005)	0.0002 (0.0004)	-0.357** (0.164)	0.021** (0.009)	-0.010 (0.015)	0.00002 (0.00002)	-0.001*** (0.0003)	-0.0005 (0.0003)	-0.0001 (0.0003)
Contract FE	YES	YES	YES	YES	YES	YES	YES	YES	YES	YES
Week FE	YES	YES	YES	YES	YES	YES	YES	YES	YES	YES
F Statistics	228.4584	224.9914	555.8857	47.2294	6.2922	1.8991	18.0591	40.7937	432.0769	326.0648
Observations	29,123	29,123	29,123	29,123	29,123	29,123	29,123	29,123	29,123	29,123
Adjusted R ²	0.815	0.813	0.915	0.472	0.093	0.017	0.248	0.435	0.893	0.863

*p<0.1; **p<0.05; ***p<0.01

If we look at the change in the baseline effect $CCP_{i,t}$ from Table 3.3.1 to Table 3.3.5 for the variables that are statistically significantly affected by $CCP_{i,t}$ in Table 3.3.1, the results are very similar. In the baseline regression, central clearing affects the absolute bid-ask spread negatively. If we include counterparty risk in the regression, the effect of central clearing on absolute bid-ask spreads becomes positive. I interpret this difference to be the effect of central clearing on absolute bid-ask spreads via the economic channel of counterparty risk. Since we include counterparty risk in (3.6), $CCP_{i,t}$ does not load negatively on absolute bid-ask spreads any more, as the mechanism between counterparty risk and absolute bid-ask spread is affected by the introduction of central clearing itself. By reducing the role of counterparty risk as a trading friction, central clearing also seems to increase CDS spreads and net trading volume. Gross trading volume and bid-ask spread resiliency, however, are negatively affected through the counterparty risk channel.

Overall, the introduction of central clearing seems to affect CDS market tightness positively by reducing counterparty risk concerns. Market depth and market resiliency, however, seem to be negatively affected by central clearing eligibility. The economic effects of central clearing through counterparty risk on CDS market liquidity are moderate. This is consistent with the findings of Arora et al. (2012) and Du et al. (2019). I conclude that counterparty risk is no influential determinant of CDS market liquidity or CDS premia. Furthermore, central clearing does not change the role counterparty risk plays in the pricing of CDS contracts in a fundamental way. This is in line with the findings of Du et al. (2019) who put forth the hypothesis that counterparty risk is managed by CDS market participants by the selection of safe CDS dealers as transaction partners.

3.3.3.2 The effect of central clearing on CDS market liquidity through CDS spread volatility

I examine the effect of CDS volatility on CDS market liquidity before and after central clearing eligibility by estimating the following regression:

$$\begin{aligned}
 CDS_{i,t} = & \alpha + \beta_1 * CCP_{i,t} + \beta_2 * clearing_distance_{i,t} \\
 & + \beta_3 * CCP_{i,t} * clearing_distance_{i,t} + \beta_4 * cds_vola_{i,t} \\
 & + \beta_5 * cds_vola_{i,t} * CCP_{i,t} + \zeta * X_{i,t} + \gamma_t + \delta_i + \epsilon_{i,t}
 \end{aligned} \tag{3.7}$$

CHAPTER 3. MULTIDIMENSIONAL EFFECTS OF CENTRAL CLEARING
ON CDS MARKET LIQUIDITY AND THEIR ECONOMIC CHANNELS - A
REGRESSION DISCONTINUITY APPROACH

The results for estimating Equation (3.7) are given in Table 3.3.6. I exclude trading volume measures as dependent variables due to potential reverse causality because trading volume can be a driver of price volatility.

Table 3.3.6: CDS spread volatility as an economic channel of the effect of central clearing on CDS market liquidity

This table shows results for regression (3.7), the semi-parametric regression estimate for a regression discontinuity around the beginning of central clearing for all dependent variables. I use a polynomial function of order 1. I apply flexible polynomial functions, i.e. I allow the regression functions to be different on both sides of the cutoff. The main independent variable, *cds_vola*, is the CDS spread volatility of a CDS contract over the last 20 days in a given week. I include week and contract fixed effects. I cluster standard errors by contract and week. In parentheses, I display standard errors which are computed according to Arellano (1987).

	<i>Dependent variable:</i>							
	ba_spread	pct_spread	cds_mid	cds_amihud	price_res	ba_res	gross_inv_res	net_inv_res
	(1)	(2)	(3)	(4)	(5)	(6)	(7)	(8)
CCP	-0.103** (0.048)	-0.045 (0.044)	-0.058 (0.040)	-1.737 (1.798)	0.003 (0.002)	-0.025 (0.019)	-0.004 (0.020)	-0.009 (0.019)
clearing_distance	-0.092*** (0.034)	-0.030 (0.027)	-0.062* (0.037)	1.750 (4.131)	0.0005 (0.003)	-0.009 (0.022)	-0.040 (0.029)	-0.056 (0.035)
cds_vola	0.002*** (0.001)	0.001* (0.001)	0.001 (0.001)	-0.033 (0.033)	-0.0001*** (0.00005)	0.001*** (0.0002)	0.0005 (0.0004)	0.0004* (0.0002)
log(leverage)	0.091* (0.053)	0.042 (0.050)	0.050 (0.045)	-0.154 (1.430)	0.002 (0.002)	0.029* (0.016)	-0.024 (0.018)	0.041*** (0.015)
log(stock_vola)	0.079** (0.034)	-0.083*** (0.022)	0.161*** (0.038)	-0.330 (1.400)	0.001 (0.001)	0.015 (0.018)	0.004 (0.015)	0.033 (0.021)
log(option_trading)	0.009 (0.008)	-0.013** (0.006)	0.021*** (0.006)	0.429 (0.382)	0.0003 (0.0003)	0.003 (0.005)	-0.001 (0.004)	-0.007 (0.005)
log(market_cap)	-0.325*** (0.046)	0.337*** (0.041)	-0.662*** (0.048)	-0.188 (1.138)	-0.002 (0.002)	-0.052** (0.024)	-0.008 (0.013)	-0.011 (0.016)
log(bond_trading)	0.021*** (0.008)	-0.014** (0.007)	0.035*** (0.011)	-0.169 (0.366)	0.0004 (0.0004)	-0.004 (0.004)	-0.004 (0.004)	-0.002 (0.004)
log(arbitrage)	-0.072*** (0.017)	0.031* (0.017)	-0.103*** (0.019)	0.309 (0.743)	0.001 (0.001)	-0.016 (0.013)	0.007 (0.008)	0.008 (0.010)
equity_amihud_ratio	-0.024 (0.028)	-0.029 (0.027)	0.004 (0.036)	-17.347*** (3.525)	0.006 (0.004)	-0.070*** (0.027)	-0.183** (0.082)	0.006 (0.031)
CCP:clearing_distance	0.001*** (0.0003)	0.001*** (0.0003)	0.0001 (0.0003)	-0.002 (0.008)	-0.00001 (0.00001)	-0.0003*** (0.0001)	-0.0002* (0.0001)	-0.0001 (0.0001)
CCP:cds_vola	-0.0002 (0.001)	0.001 (0.001)	-0.001 (0.001)	0.037 (0.037)	-0.0001*** (0.00004)	-0.001** (0.0003)	0.0001 (0.0004)	-0.0004 (0.0003)
Contract FE	YES	YES	YES	YES	YES	YES	YES	YES
Week FE	YES	YES	YES	YES	YES	YES	YES	YES
F Statistics	227.6699	221.5261	556.3744	1.8983	19.9751	40.2752	432.7755	326.1744
Observations	29,123	29,123	29,123	29,123	29,123	29,123	29,123	29,123
Adjusted R ²	0.814	0.810	0.915	0.017	0.269	0.432	0.893	0.863

* p<0.1; ** p<0.05; *** p<0.01

Table 3.3.6 shows that CDS spread volatility exhibits statistically and economically negligible baseline effects on CDS market liquidity. The interaction terms show a negative effect of CDS volatility on price and bid-ask spread resiliency. The economic effect, however, again is very small. Similarly, the changes in the baseline effect $CCP_{i,t}$ from Table 3.3.1 to Table 3.3.6 are marginal at best. Only CDS spreads and bid-ask spread resiliency are no longer statistically significantly affected by central clearing eligibility in Table 3.3.6 as CDS volatility seems to capture a significant portion of variation that loaded on the corresponding treatment dummies in Table 3.3.1. This result on the impact of CDS volatility on the pricing of CDS contracts is in line with the findings of Kaya (2016), who finds a positive impact of central clearing on CDS premia via the CDS volatility channel. One explanation may be

an increase in market transparency due to the introduction of central clearing that leads to a decrease in the level of CDS spread volatility as found in previous studies (Loon and Zhong, 2014; Mayordomo and Posch, 2016; Menkveld et al., 2015; Bernstein et al., 2019). Higher collateral requirements of CCPs may hamper continuous liquidity provision and decrease bid-ask spread resiliency.

3.3.3.3 The effect of central clearing on CDS market liquidity through netting efficiency

I examine the effect of netting efficiency on CDS market liquidity before and after central clearing eligibility by estimating regression (3.8). The results for estimating Equation (3.8) are given in Table 3.3.7.

$$\begin{aligned} \text{CDS}_{i,t} = & \alpha + \beta_1 * \text{CCP}_{i,t} + \beta_2 * \text{clearing_distance}_{i,t} \\ & + \beta_3 * \text{CCP}_{i,t} * \text{clearing_distance}_{i,t} + \beta_4 * \text{nett_eff}_{i,t} \\ & + \beta_5 * \text{nett_eff}_{i,t} * \text{CCP}_{i,t} + \zeta * X_{i,t} + \gamma_t + \delta_i + \epsilon_{i,t} \end{aligned} \quad (3.8)$$

$\text{nett_eff}_{i,t}$ is my proxy for netting efficiency and defined as follows:

$$\text{nett_eff}_{i,t} = \frac{\text{net_position}_{i,t}}{\text{gross_position}_{i,t}} \quad (3.9)$$

Since net positions and gross positions form my proxy for netting efficiency, I do not consider the effect of netting efficiency on gross trading volume and net trading volume due to the mechanic correlation that may hinder a sensible interpretation of the results.

Table 3.3.7 shows that netting efficiency only has a negative effect on relative bid-ask spreads and price impact but no further effects on any of the other CDS market liquidity variables. This does not change with the beginning of central clearing. The interaction terms are not statistically significant. Looking at the change in the $\text{CCP}_{i,t}$ coefficient from Table 3.3.1 to Table 3.3.7, we see a positive difference for absolute bid-ask spreads, CDS spreads, and bid-ask spread resiliency. However, the economic significance is negligible. In summary, netting efficiency does not seem to constitute a major economic channel for the effect of central clearing on CDS market liquidity.

CHAPTER 3. MULTIDIMENSIONAL EFFECTS OF CENTRAL CLEARING
ON CDS MARKET LIQUIDITY AND THEIR ECONOMIC CHANNELS - A
REGRESSION DISCONTINUITY APPROACH

Table 3.3.7: Netting efficiency as an economic channel of the effect of central clearing on CDS market liquidity

This table shows results for regression (3.8), the semi-parametric regression estimate for a regression discontinuity around the beginning of central clearing for all dependent variables. I use a polynomial function of order 1. I apply flexible polynomial functions, i.e. I allow the regression functions to be different on both sides of the cutoff. The main independent variable, *nett_eff*, is the ratio of net positions to gross positions of a CDS contract in a given week as defined in Equation 3.9. I include week and contract fixed effects. I cluster standard errors by contract and week. In parentheses, I display standard errors which are computed according to Arellano (1987).

	<i>Dependent variable:</i>							
	ba_spread	pct_spread	cds_mid	cds_amihud	price_res	ba_res	gross_inv_res	net_inv_res
	(1)	(2)	(3)	(4)	(5)	(6)	(7)	(8)
CCP	-0.043 (0.098)	-0.004 (0.092)	-0.039 (0.078)	-2.659 (3.007)	-0.005 (0.006)	-0.040 (0.051)	0.020 (0.043)	0.040 (0.040)
clearing_distance	-0.094*** (0.034)	-0.027 (0.027)	-0.067* (0.037)	1.921 (4.149)	0.001 (0.002)	-0.009 (0.022)	-0.042 (0.029)	-0.056* (0.034)
nett_eff	0.003 (0.010)	-0.019** (0.009)	0.022*** (0.007)	-0.810** (0.346)	-0.0002 (0.001)	-0.003 (0.005)	0.001 (0.005)	0.003 (0.004)
log(leverage)	0.089 (0.055)	0.035 (0.054)	0.054 (0.043)	-0.339 (1.419)	0.003 (0.003)	0.030* (0.016)	-0.026 (0.019)	0.041*** (0.015)
log(stock_vola)	0.105*** (0.036)	-0.061*** (0.022)	0.166*** (0.038)	-0.395 (1.278)	-0.003** (0.001)	0.022 (0.018)	0.012 (0.015)	0.034* (0.020)
log(option_trading)	0.008 (0.008)	-0.012* (0.007)	0.021*** (0.005)	0.451 (0.385)	0.0003 (0.0004)	0.003 (0.005)	-0.001 (0.004)	-0.007 (0.005)
log(market_cap)	-0.327*** (0.047)	0.347*** (0.041)	-0.674*** (0.048)	0.249 (1.172)	-0.002 (0.002)	-0.049** (0.025)	-0.008 (0.013)	-0.012 (0.017)
log(bond_trading)	0.022*** (0.008)	-0.014** (0.007)	0.035*** (0.011)	-0.174 (0.361)	0.0003 (0.0004)	-0.003 (0.004)	-0.004 (0.005)	-0.002 (0.004)
log(arbitrage)	-0.073*** (0.017)	0.031* (0.018)	-0.104*** (0.019)	0.347 (0.719)	0.001 (0.001)	-0.015 (0.013)	0.007 (0.007)	0.008 (0.010)
equity_amihud_ratio	-0.028 (0.029)	-0.028 (0.029)	-0.0005 (0.034)	-17.228*** (3.558)	0.008 (0.005)	-0.068** (0.027)	-0.181** (0.083)	0.007 (0.031)
CCP:clearing_distance	0.001*** (0.0003)	0.001*** (0.0002)	0.0001 (0.0003)	-0.002 (0.008)	-0.00002 (0.00001)	-0.0003*** (0.0001)	-0.0002 (0.0001)	-0.0001 (0.0001)
CCP:nett_eff	-0.007 (0.011)	-0.004 (0.010)	-0.003 (0.008)	0.195 (0.296)	0.0003 (0.001)	-0.001 (0.006)	-0.002 (0.005)	-0.007* (0.004)
Contract FE	YES	YES	YES	YES	YES	YES	YES	YES
Week FE	YES	YES	YES	YES	YES	YES	YES	YES
F Statistics	223.0529	222.7328	565.5519	1.9159	18.0523	39.969	431.242	326.4104
Observations	29,123	29,123	29,123	29,123	29,123	29,123	29,123	29,123
Adjusted R ²	0.811	0.811	0.916	0.017	0.248	0.430	0.893	0.863

*p<0.1; **p<0.05; ***p<0.01

3.3.3.4 The effect of central clearing on individual banks' inventory risk through lower regulatory capital charges

Lower regulatory capital charges may reduce inventory costs under central clearing. The lower regulatory risk-weight of centrally cleared positions can decrease financial constraints of market participants due to lower capital charges. This decrease in capital charges can increase inventory risk-taking behavior of dealers in the CDS market. I examine quarterly FR Y-9C reports and Bank Holding Company Performance Reports (BHCPR) for 25 large US banks with an aggregate position in credit derivatives of around 10.25bn USD. I estimate whether the total CDS positions of these banks change with the share of centrally cleared CDS transactions. I proxy the share of centrally cleared CDS transactions by the ratio of regulatory capital

3.3. EMPIRICAL ANALYSIS

that must be provided for centrally cleared transactions to the regulatory capital that must be provided for all CDS transactions. I run the following regression:

$$\text{total_cds}_{i,t} = \alpha + \beta_1 * \text{rwa_ccp}_{i,t} + \zeta * X_{i,t} + \gamma_t + \epsilon_{i,t} \quad (3.10)$$

$\text{rwa_ccp}_{i,t}$ is the ratio of risk-weighted assets from centrally cleared CDS positions to total risk-weighted assets from CDS positions for bank i in quarter t :

$$\text{rwa_ccp}_{i,t} = \frac{\text{rwa_cds_ccp}_{i,t}}{\text{rwa_cds_total}_{i,t}} \quad (3.11)$$

Building on previous studies, I control for further determinants of individual banks' CDS positions ($X_{i,t}$): total assets, equity ratio, non-performing loans, liquid assets, return on assets, return on equity and net interest margin (Shan et al., 2017; Hasan and Wu, 2016; Minton et al., 2009). γ_t are quarter fixed effects.

Table 3.3.8: The impact of central clearing on individual banks' CDS positions

This table shows results for regression (3.10), the regression of individual banks' total CDS positions on the fraction of risk-weighted assets from centrally cleared CDS positions to the total risk-weighted assets from CDS positions (rwa_ccp). Further explanatory variables are total assets, total loans, total deposits, equity ratio, non-performing loans, liquid assets, return on assets (roa), return on equity (roe) and net income margin (nim). I include quarter fixed effects in column (6). The constant is omitted in the regression output. I cluster standard errors by bank and quarter. In parentheses, I display t-statistics which are computed according to Arellano (1987).

	Dependent variable:					
	total_cds					
	(1)	(2)	(3)	(4)	(5)	(6)
rwa_ccp	1.916*** (0.220)	0.211* (0.112)	0.723*** (0.189)	1.640*** (0.226)	0.254** (0.121)	0.443* (0.244)
total_assets		0.002*** (0.0001)			0.002*** (0.0001)	0.002*** (0.001)
total_loans		-0.006*** (0.0005)			-0.006*** (0.001)	-0.006*** (0.001)
total_deposits		0.001*** (0.0004)			0.002** (0.001)	0.002 (0.002)
equity_ratio			-0.002 (0.003)		-0.001 (0.002)	-0.001 (0.002)
non_perform_loans			-0.058*** (0.012)		-0.001 (0.010)	-0.009 (0.023)
liquid_assets			0.004*** (0.0004)		-0.001 (0.001)	-0.001 (0.003)
roa				12.765 (13.661)	-3.886 (6.364)	13.485*** (5.001)
roe				-184.599 (364.845)	1.894 (166.751)	-87.924*** (20.145)
nim				-18.585*** (4.708)	4.218* (2.386)	11.671*** (3.446)
Quarter FE	NO	NO	NO	NO	NO	YES
Observations	264	264	264	264	264	264
Adjusted R ²	0.221	0.847	0.561	0.259	0.846	0.871

*p<0.1; **p<0.05; ***p<0.01

I find total CDS positions to increase with an increasing fraction of centrally cleared CDS positions. Table 3.3.8 shows that the economic effect of central clearing on CDS inventory in terms of gross positions amounts to 44mn USD per one percent increase in regulatory capital from cleared CDS transactions relative to total regulatory capital from CDS transactions. Across all specifications, the effect is statistically significant at least at 10% level. The results indicate that the low risk-weight of centrally cleared positions frees up risk-taking capacity in terms of CDS gross inventory. This additional risk-taking capacity may explain the baseline positive effects of central clearing on CDS market liquidity.

3.4 Robustness checks

In this section, I present different robustness checks to the baseline regression on the impact of central clearing eligibility on different dimensions of market liquidity. I follow the seminal paper by Hausman and Rapson (2018) that provides detailed guidance on testing RD estimations with time as running variable for robustness. Consequently, I check my sample for discontinuities in different exogenous covariates (section 3.4.1), I test my results for their sensitivity to the selected observation period (3.4.2), re-run the discontinuity estimation by using a non-parametric approach (3.4.3), test and account for potential autocorrelation in the dependent variables (3.4.4), and perform a placebo test (3.4.5).

3.4.1 Testing for discontinuities in covariates

A regression discontinuity design requires the assumption of smooth covariate movement around the cutoff. Otherwise, the identification of any potential effect cannot be valid since the discontinuity in the dependent variable could be caused by a discontinuity in one or more covariates. I test my covariates for a discontinuity around our cutoff in the running variable $clearing_distance_{i,t}$. I include contract and week fixed effects and cluster standard errors by contract and week.

$$\begin{aligned} Cov_{i,t} = & \alpha + \beta_1 * CCP_{i,t} + \beta_2 * clearing_distance_{i,t} \\ & + \beta_3 * CCP_{i,t} * clearing_distance_{i,t} + \zeta * X_{i,t} + \gamma_t + \delta_i + \epsilon_{i,t} \end{aligned} \tag{3.12}$$

Table 3.4.1: Regression discontinuity estimation for covariates

This table shows results for regression (3.4), the semi-parametric regression discontinuity estimate around the beginning of central clearing for the control variables leverage, stock volatility, option trading volume, market capitalization, bond trading volume, arbitrage and equity Amihud illiquidity ratio. I use a polynomial function of order 1. I apply flexible polynomial functions, i.e. I allow the regression functions to be different on both sides of the cutoff. The main independent variable, *CCP*, is a dummy variable which takes the value of 1 if a contract is eligible for central clearing. I include contract fixed effects and cluster standard errors by contract and week. In parentheses, I display standard errors which are computed according to Arellano (1987).

	<i>Dependent variable:</i>						
	leverage (1)	stock_vola (2)	option_trading (3)	market_cap (4)	bond_trading (5)	arbitrage (6)	equity_amihud_ratio (7)
CCP	-0.057 (0.062)	0.031 (0.032)	-0.023 (0.088)	-0.028 (0.061)	-0.079 (0.109)	-0.015 (0.049)	0.0003 (0.0002)
Contract FE	YES	YES	YES	YES	YES	YES	YES
Week FE	YES	YES	YES	YES	YES	YES	YES
F Statistics	438.0605	96.3217	232.249	1075.0911	157.5871	55.4417	1.5403
Observations	28,072	28,072	28,072	28,072	28,072	28,072	28,072
Adjusted R ²	0.896	0.653	0.821	0.955	0.756	0.518	0.011

Note: *p<0.1; **p<0.05; ***p<0.01.

$Cov_{i,t}$ denotes different control variables for the effect of central clearing on CDS market liquidity: leverage (*leverage*), option implied stock volatility (*stock_vola*), option trading volume (*option_trading*), market capitalization (*market_cap*), bond trading volume (*bond_trading*), the CDS bond basis (*arbitrage*) and the equity Amihud illiquidity ratio (*equity_amihud_ratio*). γ_t and δ_i capture week and contract fixed effects.

The results for estimating Equation 3.12 are given in Table 3.4.1. Table 3.4.1 displays results for a semi-parametric regression discontinuity test on our covariates. In order to rule out any anticipatory effect of CDS market participants to central clearing, I exclude two months of observations before and after the introduction of central clearing. I do not find any statistically significant effect in the covariates around the beginning of central clearing. Based on this test, the assumption seems plausible that any discontinuity in the dependent variables may come from the central clearing effect and not from any confounding covariates.

3.4.2 Sensitivity to observation period

Since I perform an RD estimation in the context of an event study, it is important to consider potential anticipatory effects of market participants prior to the actual event. Market participants may already change their trading behavior during the weeks before a contract becomes eligible for central clearing and novate these positions when central clearing eligibility starts. Due to the fundamental risk of CDS contracts, it may not be plausible to expect such anticipatory effects far in advance of the start of central clearing but only when the time until clearing eligibility is short enough to avoid any major downside risks. Principally, the event time trend $clearing_distance_{i,t}$ in my RDD captures such anticipatory effects. As an additional robustness check, I re-run regression (3.4) but exclude two months of observations before and after the start of central clearing in order to rule out any anticipatory trading behavior by CDS market participants prior to the start of central clearing.

Table 3.4.2 displays results of this 'Donut-RD'. The results are largely robust to the exclusion of observations very close around the cutoff. However, the economic effect of central clearing on bid-ask spreads is almost three times larger. One explanation may be that clients make transactions during the weeks before clearing eligibility that are determined to be novated to the CCP as soon as the contract becomes clearing eligible. This demand may be reflected in the bid-ask spreads al-

3.4. ROBUSTNESS CHECKS

ready prior to the actual clearing eligibility event. In this specification, the negative coefficient for price resiliency becomes statistically significant the 5% level.

In an additional specification, I restrict my observation window to 52 weeks before the start of central clearing eligibility of a contract and to 4 weeks after the clearing eligibility start. Again, I exclude 4 weeks of observations prior to the start of central clearing eligibility due to potential anticipatory effects. It has been widely recognized that the validity of RD estimators relies on a large number of cross-sectional observations close to the specified cutoff. Using observations very far from the cutoff may bias the RD estimate. Furthermore, this design allows us to make our results more comparable to the results of Loon and Zhong (2014) who use an identical event window around central clearing eligibility.

Table 3.4.3 shows results on our baseline regression using the Loon and Zhong (2014) observation window around the beginning of central clearing eligibility. In this specification, the effects of central clearing on net trading volume and on bid-ask spread resiliency are not statistically significant any more and the effect on absolute bid-ask spreads is only significant at the 10% level. The results on gross trading volume even hold if I use this very short post-event window. Additionally, net inventory resiliency is positively affected by the introduction of central clearing at the 5% significance level.

Table 3.4.4 shows results for two different data-driven bandwidth estimation procedures: mean squared error (MSE) approximation and coverage error ratio (CER). I test the robustness of the results by restricting the observation window around central clearing eligibility to the MSE and CER bandwidth estimates. In two additional specifications, I allow the bandwidth to be different on both sides of the cutoff.

The results in Table 3.4.4 again show a consistent statistically significant decrease of absolute bid-ask spreads and bid-ask spread resiliency and an increase in gross trading volume. Using the data-driven bandwidths, we also see gross inventory resiliency and price resiliency being negatively affected by the introduction of central clearing. Net trading volume is only statistically significantly negatively affected in the specifications using the MSE bandwidths. The other measures of market liquidity seem to be unaffected as results are inconsistent and only marginally significant at best.

CHAPTER 3. MULTIDIMENSIONAL EFFECTS OF CENTRAL CLEARING ON CDS MARKET LIQUIDITY AND THEIR ECONOMIC CHANNELS - A REGRESSION DISCONTINUITY APPROACH

Table 3.4.2: Donut RD estimation of the effect of central clearing on CDS market liquidity

This table shows results for regression (3.4), the semi-parametric regression discontinuity estimate around the beginning of central clearing for all dependent variables. I exclude eight weeks prior to and after the beginning of central clearing eligibility. I use a polynomial function of order 1. I apply flexible polynomial functions, i.e. I allow the regression functions to be different on both sides of the cutoff. The main independent variable, *CCP*, is a dummy variable which takes the value of 1 if a contract is eligible for central clearing. I include week and contract fixed effects. I cluster standard errors by contract and week. In parentheses, I display standard errors which are computed according to Arellano (1987).

	Dependent variable:									
	ba-spread	pct-spread	cbs-mid	gross-trading	net-trading	cbs-amihud	price-res	ba-res	gross-inv-res	net-inv-res
	(1)	(2)	(3)	(4)	(5)	(6)	(7)	(8)	(9)	(10)
CCP	-0.290*** (0.056)	-0.033 (0.043)	-0.088** (0.043)	42.126*** (13.243)	-2.805*** (0.867)	-0.729 (1.502)	-0.003** (0.002)	-0.059*** (0.020)	0.001 (0.027)	-0.034* (0.020)
clearing-distance	0.001 (0.0003)	-0.029 (0.026)	-0.065* (0.039)	-37.204* (19.252)	-2.061 (1.406)	1.996 (4.247)	0.0004 (0.002)	-0.003 (0.021)	-0.069* (0.037)	-0.010 (0.037)
log(leverage)	0.090 (0.061)	0.034 (0.052)	0.048 (0.045)	9.312 (6.138)	0.450 (0.604)	-0.150 (1.522)	0.003 (0.003)	0.033** (0.017)	-0.028 (0.020)	-0.049*** (0.018)
log(stock-vola)	0.200*** (0.033)	-0.060*** (0.022)	0.167*** (0.038)	16.751*** (3.846)	-0.624 (0.625)	-0.537 (1.357)	-0.003** (0.001)	0.021 (0.019)	0.010 (0.020)	0.037* (0.021)
log(option-trading)	0.003 (0.008)	-0.013* (0.007)	0.022*** (0.006)	5.575*** (1.802)	0.052 (0.178)	0.390 (0.398)	0.0004 (0.0004)	0.003 (0.005)	-0.004 (0.006)	-0.003 (0.005)
log(market-cap)	-0.341*** (0.046)	0.336*** (0.042)	-0.563*** (0.048)	-6.144 (7.870)	-0.400 (0.439)	0.118 (1.202)	-0.002 (0.002)	-0.053*** (0.026)	-0.022 (0.021)	0.013 (0.018)
log(bond-trading)	0.021*** (0.007)	-0.015** (0.007)	0.037*** (0.011)	5.435*** (1.304)	-0.147 (0.193)	-0.228 (0.370)	0.0003 (0.0004)	-0.004 (0.004)	-0.001 (0.005)	-0.006 (0.005)
log(arbitrage)	0.007 (0.018)	0.029* (0.017)	-0.101*** (0.019)	-0.212 (2.831)	-0.166 (0.373)	0.304 (0.754)	0.001 (0.001)	-0.014 (0.013)	0.005 (0.014)	0.014 (0.009)
equity-amihud-ratio	0.089* (0.051)	-0.035 (0.029)	0.012 (0.036)	29.463*** (10.272)	-5.699 (3.780)	-17.962*** (3.698)	0.009* (0.005)	-0.063*** (0.027)	-0.047 (0.105)	-0.250*** (0.049)
CCP-clearing-distance	0.001*** (0.0003)	0.001*** (0.0003)	0.00004 (0.0003)	0.515*** (0.161)	-0.021*** (0.006)	-0.007 (0.008)	-0.00001 (0.00001)	-0.0004 (0.0001)	0.0001 (0.0001)	-0.0004 (0.0001)
Contract FE	YES	YES	YES	YES	YES	YES	YES	YES	YES	YES
Week FE	YES	YES	YES	YES	YES	YES	YES	YES	YES	YES
F Statistics	712.6967	212.8965	552.3072	47.8434	6.0813	1.872	17.6461	38.5032	216.4124	225.5224
Observations	28,072	28,072	28,072	28,072	28,072	28,072	28,072	28,072	28,072	28,072
Adjusted R ²	0.734	0.809	0.917	0.484	0.092	0.017	0.250	0.429	0.812	0.818

*p<0.1; **p<0.05; ***p<0.01

Table 3.4.3: RD effect of central clearing on CDS market liquidity using a 52-week pre-clearing window and a 4-week post-clearing window

This table shows results for regression (3.4), the semi-parametric regression discontinuity estimate around the beginning of central clearing for all dependent variables. I restrict the observation period to 52 weeks prior to and four weeks after the beginning to central clearing eligibility, in order to obtain comparable results to Loon and Zhong (2014). I also exclude four weeks of observations prior to central clearing eligibility start. I use a polynomial function of order 1. I apply flexible polynomial functions, i.e. I allow the regression functions to be different on both sides of the cutoff. The main independent variable, *CCP*, is a dummy variable which takes the value of 1 if a contract is eligible for central clearing. I include week and contract fixed effects. I cluster standard errors by contract and week. In parentheses, I display standard errors which are computed according to Arellano (1987).

	<i>Dependent variable:</i>									
	ba_spread	pct_spread	cds_mid	gross_trading	net_trading	cds_amihud	price_res	ba_res	gross_inv_res	net_inv_res
	(1)	(2)	(3)	(4)	(5)	(6)	(7)	(8)	(9)	(10)
CCP	-0.078* (0.045)	-0.042 (0.046)	-0.036 (0.047)	248.588** (103.883)	-12.289 (7.687)	13.466 (14.054)	-0.001 (0.006)	-0.025 (0.019)	0.031 (0.066)	-0.232** (0.117)
clearing_distance	0.020 (0.072)	-0.014 (0.061)	0.034 (0.033)	-65.310 (58.688)	-10.246 (8.461)	3.343 (12.005)	-0.005 (0.006)	-0.040 (0.027)	-0.001 (0.053)	0.065 (0.144)
log(leverage)	0.092 (0.194)	-0.121 (0.168)	0.213 (0.261)	-10.949 (60.886)	12.090 (9.425)	20.505 (21.904)	0.007 (0.025)	-0.310*** (0.105)	0.264 (0.306)	0.026 (0.215)
log(stock_vola)	0.096** (0.047)	-0.019 (0.029)	0.115* (0.059)	17.648 (32.488)	-0.588 (3.106)	-11.294** (5.500)	-0.006 (0.007)	0.017 (0.027)	-0.038 (0.052)	-0.044 (0.057)
log(option_trading)	-0.011* (0.006)	-0.006 (0.006)	-0.005 (0.008)	5.184 (8.883)	0.380 (1.094)	1.840 (2.514)	-0.00005 (0.001)	0.008** (0.003)	0.011 (0.015)	-0.006 (0.012)
log(market_cap)	-0.287*** (0.094)	0.258** (0.102)	-0.546*** (0.118)	-71.459 (67.466)	-8.409 (7.994)	0.535 (13.341)	0.012 (0.013)	0.120* (0.070)	-0.003 (0.161)	-0.142 (0.135)
log(bond_trading)	0.007 (0.006)	-0.009* (0.005)	0.016*** (0.005)	8.875 (7.667)	-1.263 (0.797)	0.731 (1.045)	0.0005 (0.001)	-0.007 (0.005)	-0.001 (0.010)	0.001 (0.011)
log(arbitrage)	-0.031 (0.024)	0.032** (0.014)	-0.063** (0.029)	-10.980 (19.979)	-1.312 (1.776)	3.861 (3.541)	-0.003 (0.003)	-0.014 (0.016)	-0.008 (0.028)	0.004 (0.042)
equity_amihud_ratio	-0.037 (0.034)	-0.033 (0.057)	-0.004 (0.053)	-35.773 (130.670)	8.668 (15.205)	-33.405* (19.355)	-0.029*** (0.011)	-0.128*** (0.044)	-0.144 (0.185)	0.715*** (0.135)
CCP_clearing_distance	0.020 (0.013)	0.019 (0.012)	0.001 (0.011)	-66.139** (32.065)	0.863 (2.736)	-5.195 (3.921)	-0.001 (0.001)	0.002 (0.005)	0.013 (0.018)	0.086** (0.034)
Contract FE	YES	YES	YES	YES	YES	YES	YES	YES	YES	YES
Week FE	YES	YES	YES	YES	YES	YES	YES	YES	YES	YES
F Statistics	76.3786	36.8779	106.1755	2.254	1.219	1.689	4.4158	11.483	3.1317	4.6712
Observations	2,227	2,227	2,227	2,227	2,227	2,227	2,227	2,227	2,227	2,227
Adjusted R ²	0.930	0.864	0.949	0.181	0.037	0.108	0.376	0.649	0.273	0.393

* p<0.1; ** p<0.05; *** p<0.01

It is interesting to note that the data-driven bandwidth selection procedures suggest a large bandwidth in the context of an event study on the introduction of central clearing on the CDS market because the number of observations is consistently above 17,000 and often close to the full sample size. Considering the fact that central clearing remains voluntary after its introduction, the economic effects may be incorporated into observations further away from the cutoff. Market participants do not have to use CCPs as trading partners but can decide when and how much trading volume they shift to CCPs. This is why the economic effect of central clearing eligibility may increase over time, whereas the direction of the effect may not be clear in the first weeks after the start of central clearing eligibility. This special context may justify choosing a large bandwidth although this is not the standard identification strategy in the context of an RDD with a large cross-section.

Due to the sensitivity of the results to the bandwidth choice, it seems to be useful to exploit the time dimension more extensively. In order to get an idea how fast the economic effects of voluntary central clearing on CDS market liquidity are incorporated into the market, I show graphically the sensitivity of the RD estimate to the chosen bandwidth in Figure 3.4.1. I estimate the baseline model with bandwidths of 13, 26, 39, 52, 78, 104, 130, 156, 182 and 208 weeks around the beginning of central clearing eligibility. Figure 3.4.1 shows the RD estimates and corresponding confidence intervals for different bandwidths. I only let the bandwidth vary for the post-clearing period. I keep the pre-clearing period fixed to 52 weeks. This may provide evidence about the time frame that is needed until the effects of central clearing in a voluntary clearing scheme are incorporated into the CDS market, and new equilibria for the market liquidity measures are established.

3.4. ROBUSTNESS CHECKS

Table 3.4.4: RD effect of central clearing on CDS market liquidity using data-driven bandwidths (MSE & CER)

The following tables show results for regression (3.4), the semi-parametric regression discontinuity estimate around the beginning of central clearing for all dependent variables. I restrict the observation period according to different MSE (Panel A & B) and CER (Panel C & D) bandwidth estimators according to Imbens and Kalyanaraman (2012) and Calonico et al. (2020). I use a polynomial function of order 1. I apply flexible polynomial functions, i.e. I allow the regression functions to be different on both sides of the cutoff. The main independent variable, *CCP*, is a dummy variable which takes the value of 1 if a contract is eligible for central clearing. I include week and contract fixed effects. I cluster standard errors by contract and week. In parentheses, I display standard errors which are computed according to Arellano (1987).

Panel A: MSE bandwidth estimator (same bandwidth on both sides of the cutoff)										
	ba_spread	pct_spread	cds_mid	gross_trading	net_trading	cds_amihud	price_res	ba_res	gross_inv_res	net_inv_res
	(1)	(2)	(3)	(4)	(5)	(6)	(7)	(8)	(9)	(10)
CCP	-0.171*** (0.039)	-0.057 (0.090)	-0.097 (0.063)	208.946*** (62.088)	-4.359** (1.977)	-2.445 (4.091)	-0.006** (0.003)	-0.093*** (0.024)	-0.088** (0.035)	-0.031 (0.040)
Observations	24,958	21,708	25,247	17,603	19,997	19,737	23,270	24,637	23,270	21,520
Adjusted R ²	0.706	0.833	0.921	0.555	0.111	0.014	0.255	0.439	0.836	0.839
<i>Note:</i> * p<0.1; ** p<0.05; *** p<0.01										
Panel B: MSE bandwidth estimator (different bandwidths on both sides of the cutoff)										
	ba_spread	pct_spread	cds_mid	gross_trading	net_trading	cds_amihud	price_res	ba_res	gross_inv_res	net_inv_res
	(1)	(2)	(3)	(4)	(5)	(6)	(7)	(8)	(9)	(10)
CCP	-0.240*** (0.038)	-0.054 (0.056)	-0.098 (0.068)	209.830*** (65.989)	-5.084** (2.178)	-1.931 (3.807)	-0.005** (0.002)	-0.071*** (0.022)	-0.088** (0.035)	-0.034 (0.039)
Observations	25,689	25,896	24,536	17,351	19,561	20,165	25,781	26,350	23,072	22,378
Adjusted R ²	0.706	0.816	0.922	0.558	0.112	0.013	0.251	0.433	0.836	0.835
<i>Note:</i> * p<0.1; ** p<0.05; *** p<0.01										
Panel C: CER bandwidth estimator (same bandwidth on both sides of the cutoff)										
	ba_spread	pct_spread	cds_mid	gross_trading	net_trading	cds_amihud	price_res	ba_res	gross_inv_res	net_inv_res
	(1)	(2)	(3)	(4)	(5)	(6)	(7)	(8)	(9)	(10)
CCP	-0.128*** (0.045)	-0.083 (0.067)	-0.098* (0.052)	104.994*** (26.291)	-2.457 (1.762)	0.490 (2.650)	-0.005** (0.002)	-0.071*** (0.022)	-0.059** (0.029)	-0.036 (0.035)
Observations	24,426	24,437	26,709	21,708	23,270	23,072	25,354	26,350	25,354	24,248
Adjusted R ²	0.705	0.822	0.919	0.533	0.102	0.016	0.251	0.433	0.828	0.829
<i>Note:</i> * p<0.1; ** p<0.05; *** p<0.01										
Panel D: CER bandwidth estimator (different bandwidths on both sides of the cutoff)										
	ba_spread	pct_spread	cds_mid	gross_trading	net_trading	cds_amihud	price_res	ba_res	gross_inv_res	net_inv_res
	(1)	(2)	(3)	(4)	(5)	(6)	(7)	(8)	(9)	(10)
CCP	-0.168*** (0.039)	-0.038 (0.047)	-0.100* (0.056)	111.968*** (26.786)	-3.346* (1.771)	1.075 (2.530)	-0.002 (0.002)	-0.064*** (0.021)	-0.058** (0.029)	-0.033 (0.033)
Observations	24,926	27,205	26,240	21,520	22,971	23,369	27,072	27,452	25,247	24,841
Adjusted R ²	0.706	0.811	0.920	0.537	0.103	0.016	0.248	0.430	0.829	0.826
<i>Note:</i> * p<0.1; ** p<0.05; *** p<0.01										

CHAPTER 3. MULTIDIMENSIONAL EFFECTS OF CENTRAL CLEARING ON CDS MARKET LIQUIDITY AND THEIR ECONOMIC CHANNELS - A REGRESSION DISCONTINUITY APPROACH

Figure 3.4.1: RD treatment effect and confidence intervals for different post-clearing bandwidths

These figures show RDD estimates and corresponding confidence intervals for all dependent variables of regression 3.4 depending on different post-clearing bandwidths. Apart from the bandwidth selection, I estimate the RDDs according to regression 3.4.

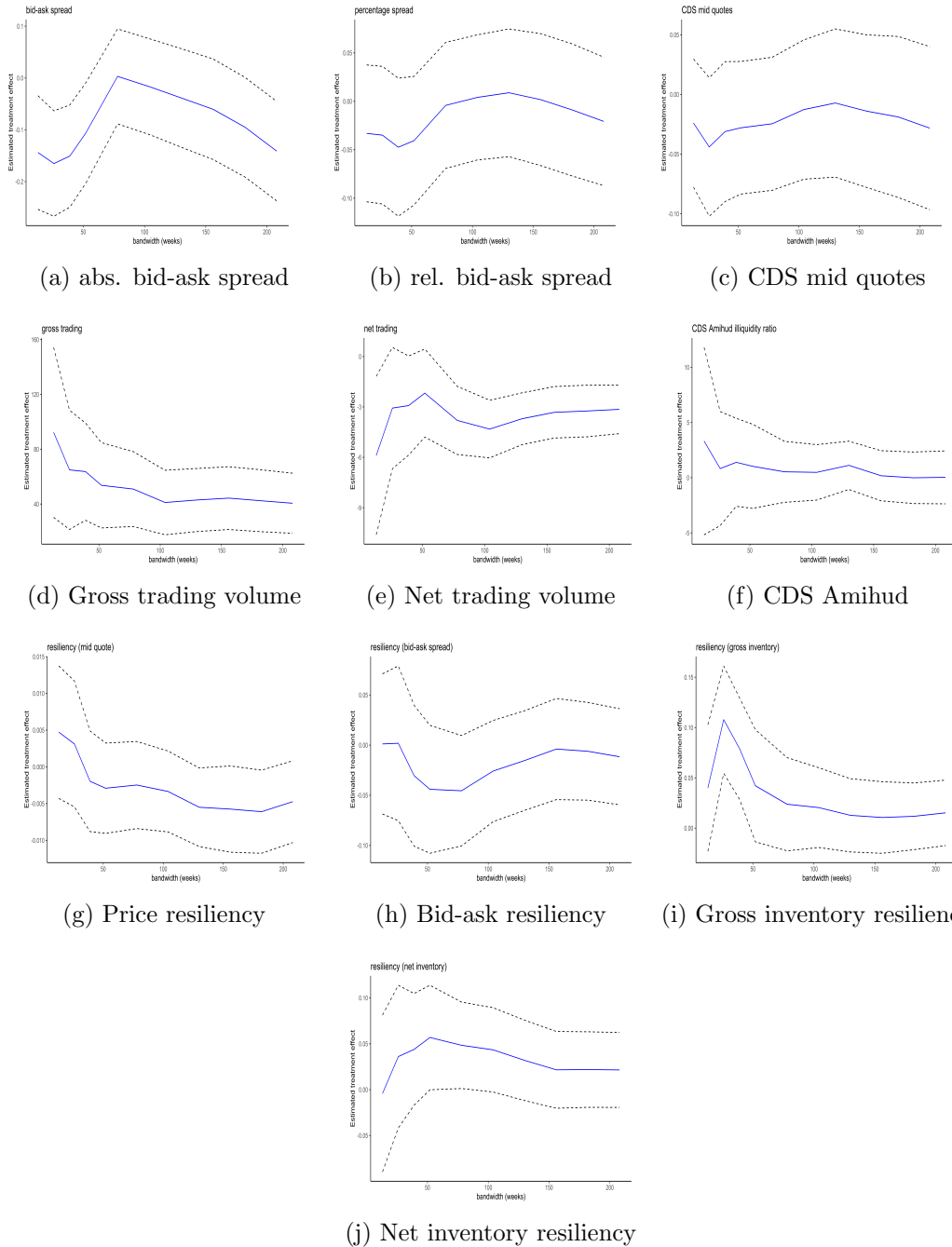

Figure 3.4.1 visualizes that the treatment effect changes relatively strong over time for bid-ask spreads, gross trading volume, net trading volume, bid-ask spread resiliency and resiliency of gross and net inventories. The results highlight the importance of considering long-term observation windows around the beginning of central clearing eligibility in order to get more detailed insights about the reactions of market participants to the possibility of voluntary central clearing.

3.4.3 Accounting for autocorrelation

Serial correlation in the dependent variable or error terms can bias the estimate of the treatment effect in an RD setting with time as the running variable, since serial dependence during the shift from the pre-treatment period to the post-treatment period distorts the observed treatment effect (Hausman and Rapson, 2018). In the baseline regression (3.4), I account for serial correlation in the error terms by clustering standard errors across time and contracts. In this section, I examine potential effects of serial dependence in the dependent variables. First, I check the panel time series of my dependent variables on autocorrelation with the test on serial correlation in linear panel data models of Woolridge (2002).

Table B.2 shows results for the Woolridge test on serial correlation in linear panel data models. We can reject the null hypothesis of no autocorrelation in the panel data time series for all dependent variables except CDS net trading volume and the CDS Amihud illiquidity ratio. In order to examine whether serial dependence in the dependent variables affects the RD estimates from Table 3.3.1, I estimate the following dynamic RD model that includes the first lag of the dependent variable in the regression:

$$\begin{aligned}
 CDS_{i,t} = & \alpha + \beta_1 * CCP_{i,t} + \beta_2 * clearing_distance_{i,t} \\
 & + \beta_3 * CCP_{i,t} * clearing_distance_{i,t} + \beta_4 * CDS_{i,t-1} \\
 & + \zeta * X_{i,t} + \gamma_t + \delta_i + \epsilon_{i,t}
 \end{aligned} \tag{3.13}$$

$CDS_{i,t}$ denotes the dependent variables for contract i at time t from regression (3.4). $CDS_{i,t-1}$ is the lagged dependent variable that captures potential serial correlation. The other variables are as described above. Since the simultaneous inclusion of fixed effects and lagged terms in panel models is a potential source of bias, I do not include any fixed effects (Nickell, 1981). The results for estimating Equation (3.13) are given in Table 3.4.5 .

CHAPTER 3. MULTIDIMENSIONAL EFFECTS OF CENTRAL CLEARING ON CDS MARKET LIQUIDITY AND THEIR ECONOMIC CHANNELS - A REGRESSION DISCONTINUITY APPROACH

Table 3.4.5: RD effect of central clearing on CDS market liquidity in a dynamic model
 This table shows results for regression (3.13), the semi-parametric regression discontinuity estimate around the beginning of central clearing for all dependent variables. We use a polynomial function of order 1. I apply flexible polynomial functions, i.e. I allow the regression functions to be different on both sides of the cutoff. The main independent variable, *CCP*, is a dummy variable which takes the value of 1 if a contract becomes eligible for central clearing. Next to the baseline covariates, I include the lagged value of the dependent variable as external regressor. In parentheses, I display standard errors which are computed according to Arellano (1987).

	<i>Dependent variable:</i>									
	ba-spread (1)	pct-spread (2)	cds-mid (3)	gross-trading (4)	net-trading (5)	cds-annhd (6)	price-res (7)	ba-res (8)	gross-inv-res (9)	net-inv-res (10)
CCP	-0.020*** (0.003)	-0.015*** (0.003)	-0.002 (0.001)	18.538*** (6.283)	-0.497 (0.665)	-1.067 (1.301)	-0.002*** (0.0005)	-0.010*** (0.002)	-0.004 (0.005)	0.003 (0.004)
clearing-distance	0.0001*** (0.00002)	0.0001*** (0.00002)	-0.00002** (0.00001)	-0.511*** (0.042)	0.014*** (0.004)	0.022** (0.009)	0.00000 (0.00000)	0.00001 (0.00001)	0.0001** (0.00003)	0.00004 (0.00003)
lag[log(ba-spread)]	0.906*** (0.003)									
lag[log(pct-spread)]		0.915*** (0.003)								
lag[log(cds-mid)]			0.964*** (0.001)							
lag(gross-trading)				-0.065*** (0.006)						
lag(net-trading)					0.003 (0.006)					
lag(cds-annhd)						-0.006 (0.006)				
lag(ba-res)							0.900*** (0.003)			
lag(gross-inv-res)								0.963*** (0.002)		
lag(net-inv-res)									0.691*** (0.005)	
lag(price-res)										0.785*** (0.004)
log(leverage)	0.006* (0.003)	0.005 (0.003)	-0.002 (0.002)	8.671 (6.785)	0.044 (0.719)	0.120 (1.405)	0.0002 (0.0005)	0.0001 (0.002)	-0.003 (0.006)	0.002 (0.005)
log(stock-vola)	0.019*** (0.002)	-0.003 (0.002)	0.008*** (0.001)	25.563*** (4.885)	0.563 (0.517)	0.016 (1.011)	0.001*** (0.0003)	0.004*** (0.001)	-0.016*** (0.004)	0.004 (0.003)
log(option-trading)	0.002** (0.001)	-0.002* (0.001)	0.003*** (0.0004)	4.666** (1.925)	-0.051 (0.204)	0.549 (0.398)	-0.001*** (0.0001)	-0.001* (0.001)	-0.0004 (0.002)	-0.002 (0.001)
log(market-cap)	-0.036*** (0.003)	0.033*** (0.003)	-0.033*** (0.002)	-13.770** (5.914)	-0.059 (0.626)	-2.351* (1.225)	0.001 (0.0004)	-0.002 (0.002)	-0.001 (0.005)	-0.003 (0.004)
log(bond-trading)	0.002* (0.001)	-0.001 (0.001)	0.001** (0.0004)	5.639*** (1.783)	-0.079 (0.189)	-0.080 (0.369)	-0.00002 (0.0001)	0.0004 (0.0005)	-0.005*** (0.001)	-0.002* (0.001)
log(arbitrage)	0.0002 (0.002)	0.011*** (0.002)	-0.005*** (0.001)	-0.029 (3.125)	-0.530 (0.331)	0.058 (0.647)	-0.0005** (0.0002)	0.001 (0.001)	0.003 (0.003)	-0.005** (0.002)
equity-ambhd-ratio	0.019 (0.037)	0.055 (0.037)	-0.042** (0.017)	-3.437 (76.791)	0.858 (8.134)	-29.029* (15.909)	0.004 (0.005)	-0.001 (0.021)	-0.085 (0.062)	0.016 (0.051)
CCP:clearing-distance	0.0001*** (0.00002)	0.0001*** (0.00002)	0.00000 (0.00001)	0.424*** (0.043)	-0.014*** (0.005)	-0.009 (0.009)	-0.00000 (0.00000)	0.00000 (0.00001)	-0.0001** (0.00004)	-0.00000 (0.00003)
F Statistics	15258.4677	26556.8537	119570.2403	37.0277	1.4467	2.1882	10884.8744	31770.1531	2131.937	3764.6697
Observations	25,304	25,304	25,304	25,304	25,304	25,304	25,304	25,304	25,304	25,304
Adjusted R ²	0.869	0.920	0.981	0.012	-0.004	-0.003	0.825	0.932	0.480	0.620

*p<0.1; **p<0.05; ***p<0.01

Table 3.4.5 shows that our results also hold in a dynamic panel data setting. Overall, the coefficients are considerably smaller but the significance levels remain largely similar. Only the treatment coefficient on net trading volume becomes insignificant in this specification, whereas the treatment coefficient on relative bid-ask spreads and price resiliency are negative and statistically significant at the 1% level.⁶ I conclude that serial dependence in my dependent variables do not seem to significantly bias the estimated treatment effects in regression (3.4).

3.4.4 Placebo tests

In this section, I provide results on a placebo event study using a regression discontinuity design. I run placebo tests in order to rule out that the observed effect around the beginning of central clearing eligibility is a random event. I construct a new treatment dummy that simulates a treatment at a random date prior to the actual beginning of central clearing. I replace the original treatment dummy in regression (3.4) with this placebo dummy. I use the Loon and Zhong (2014) specification because this short observation window is the most restrictive specification in which I find statistically significant effects of central clearing on CDS market liquidity. All other specifications of the regression discontinuity design are as in equation (3.4). I repeat the placebo test 1,000 times.

If the observed effect in Table 3.3.1 is not random, I expect to observe 100 (50; 10) treatment coefficients that are significant at 10% (5%; 1%) level at random treatment dates. I perform the placebo test on all dependent variables since any large deviations from the theoretical expectations may indicate a misspecification of my baseline RDD. I do not construct placebo dummies that simulate treatment after the beginning of central clearing. Since treated contracts are eligible but not mandated for central clearing, market participants can still decide during the treatment period whether they want to clear their transactions bilaterally or centrally. Any date after central clearing eligibility could therefore still capture effects of increased use of central clearing, and significant coefficients of placebo dummies could not be interpreted as confounding effects. That is clearly not the case prior to the beginning of central clearing. Furthermore, I do not allow the placebo treatment date to be

⁶Since the time series dimension is large (which reduces Nickell's bias), I estimate the dynamic RD model again with fixed effects. The results are largely identical, only the treatment coefficients for price resiliency and relative bid-ask spreads (as in the baseline regression) become insignificant. The results are also robust if standard errors are clustered.

CHAPTER 3. MULTIDIMENSIONAL EFFECTS OF CENTRAL CLEARING
ON CDS MARKET LIQUIDITY AND THEIR ECONOMIC CHANNELS - A
REGRESSION DISCONTINUITY APPROACH

Table 3.4.6: Placebo test (CDS market liquidity)

This table shows the number of coefficients on different levels of statistical significance from our placebo tests. For the placebo tests, I replace the original treatment dates by random dates that lie between the beginning of our observation period and three months before the start of clearing eligibility. I use these placebo treatment dates in our regression model (3.4) in order to compute the loading on the placebo CCP dummy coefficient and restrict the observation period to 52 weeks prior to and four weeks after the beginning to central clearing eligibility. I repeat this procedure 1,000 times for every dependent variable and count the frequency of coefficients that are statistically significant at 1%, 5%, and 10% level. I expect 10 (50; 100) statistically significant coefficients of our placebo CCP dummy at the 1% (5%; 10%) significance level.

Level of statistical significance	1%	5%	10%
ba_spread	7	64	119
pct_spread	12	56	121
cds_mid	5	42	94
gross_trading	8	42	91
net_trading	8	49	99
cds_amihud	3	32	86
price_res	11	78	137
ba_res	14	62	114
gross_inv_res	24	83	141
net_inv_res	28	77	144

later than 12 weeks prior to the actual clearing date in order to rule out any economic effects in anticipation of the clearing eligibility event.

Table 3.4.6 displays results of our placebo tests for all dependent variables. Generally, the placebo tests provide evidence for the non-randomness of the clearing effect on the liquidity measures as shown in Table 3.3.1. For most of the dependent variables, I find a number of statistically significant coefficients on all significance levels that does not deviate to a large extent from the theoretical expectations. For four dependent variables, I find rather low numbers of coefficients that are statistically significant at conventional significance levels. This may indicate a too restrictive model that makes it hard to identify statistical relationships between the treatment dummy and my dependent variables. However, there are also six dependent variables for which I find more coefficients on conventional statistical significance levels than expected from statistical theory.

This test picks up the conclusion of Akari et al. (2019) about the sensitivity of empirical results on the effect of central clearing on CDS market liquidity to the chosen econometric technique. The placebo test may be seen as evidence that it is a non-trivial challenge to come up with an econometric technique that sufficiently does justice to the complexity of aggregate empirical data on CDS market liquidity. Still, I argue that the moderate deviations from the theoretical ideal do not provide

3.4. ROBUSTNESS CHECKS

sufficient and consistent evidence that the results in this paper do not point into the correct direction in terms of the causal relation between central clearing and CDS market liquidity, especially in the light of the various robustness checks that show the reliability of my results in different econometric specifications.

3.4.5 Non-parametric regression discontinuity design

Another approach to estimate a regression discontinuity is to use a non-parametric approach. In this approach, weights are assigned to observations according to a kernel function. Observations close to the cutoff get higher weights than observations further away from the cutoff. As a kernel function, I use a triangular kernel. Bandwidth selection is employed according to Imbens and Kalyanaraman (2012) and I use bandwidth bias-correction according to Calonico et al. (2014). I estimate the RD with covariates and fixed effects. Results are displayed in Table 3.4.7.

The results are largely consistent with the results from Table 3.3.1. Absolute bid-ask spreads and bid-ask spread resiliency are negatively affected at the 5% statistical significance level and gross trading volume and resiliency of CDS mid quotes are positively affected at the significance level of 1% and 10% respectively. In this specification, the resiliency of gross and net inventory is positively affected by central

Table 3.4.7: Non-parametric regression discontinuity estimation

This table shows the estimates of the effect of central clearing eligibility on all dependent variables using a non-parametric regression discontinuity design based on regression (3.4). We use a linear functional form and allow the regression functions to be different on both sides of the cutoff. The bandwidth is estimated according to Imbens and Kalyanaraman (2012). I include the same covariates as in Table 3.3.1 and include contract and week fixed effects. Weights are assigned to the observations using a triangular kernel function. Robust bias-corrected confidence intervals are computed according to Calonico et al. (2014).

	ba_spread	pct_spread	cds_mid	gross_trading	net_trading
CCP	-0.0375**	0.0055	-0.0269	32.4496***	-1.3881
Std. Err.	0.0153	0.0164	0.0187	12.0301	1.2966
p-value	0.0143	0.7379	0.1494	0.007	0.2843
Bandwidth	60.8062	59	67	81.7493	113
Observations (untreated)	2456	2398	2620	2962	3500
Observations (treated)	4190	4052	4606	5666	7852
Order of polynomial	1	1	1	1	1
	cds_amihud	price_res	ba_res	gross_inv_res	net_inv_res
CCP	-0.9575	0.0027*	-0.0272**	0.0618***	0.0507***
Std. Err.	1.7735	0.0015	0.0123	0.0127	0.0127
p-value	0.5893	0.0779	0.027	0	1e-04
Bandwidth	113	63.914	53.4979	93.4913	66.7545
Observations (untreated)	3482	2540	2253	3162	2620
Observations (treated)	7787	4404	3699	6493	4606
Order of polynomial	1	1	1	1	1

clearing introduction. The effect is highly statistically significant and its economic effect is large.

3.5 Conclusion

I empirically examine the effect of central clearing on different dimensions of market liquidity: tightness, depth, and resiliency. The empirical results show that dealers narrow bid-ask spreads, increase gross trading volume but seem to provide market liquidity less continuously in terms of bid-ask spreads with the beginning of central clearing eligibility of CDS single-name contracts.

The effects of central clearing on CDS market liquidity differ across groups of contracts with similar fundamental and liquidity risk. In almost all cases, I find positive effects of central clearing on CDS market liquidity through lower bid-ask spreads for contracts with high fundamental and liquidity risk. The gross trading volume of thinly traded CDS contracts is positively affected by central clearing eligibility, whereas the trading volume of the strongly traded CDS contracts is rather negatively affected. Market resiliency decreases for thinly traded contracts and contracts with low fundamental risk. My results point to a lower relevance of counterparty risk which may have a positive impact on CDS premia and may lead to a reduction in bid-ask spreads. I find CDS inventories to increase in the fraction of risk-weighted assets from centrally cleared positions. Higher inventory risk-taking capacity through lower regulatory capital charges for centrally cleared positions may explain the higher gross trading volumes with the introduction of central clearing. CDS spread volatility does not seem to affect market liquidity differently with central clearing eligibility.

I conclude that higher collateralization costs do not seem to play a major role in the provision of market liquidity of CDS dealers under central clearing. Still, CDS dealers seem to provide CDS market liquidity less continuously for centrally cleared contracts. This could point to potential collateral shortages after large trading volumes and deviations from market equilibrium occur under central clearing.

My analysis leads to further interesting questions as foci for future research. Whereas there are now several studies on the baseline effect of central clearing on CDS market liquidity using different methodologies (Slive et al., 2012; Loon and Zhong, 2014; Silva et al., 2018; Akari et al., 2019), this study provides first empirical evidence on the economic channels through which central clearing affects CDS market liquidity. Furthermore, my findings point to a shift in CDS trading

3.5. CONCLUSION

activity from low-risk contracts to high-risk contracts. As a result, central clearing may lead CDS market participants to increase CDS portfolio risk. In order to deepen our understanding of the intermediary role of the economic channels and of the risk-taking behavior of CDS market participants in the presence of central clearing, more robust econometric techniques as well as data on bilateral CDS positions and posted collateral for single CDS market participants are required.

B Appendix to Chapter 3

Figure B.1: Overview on the impact of central clearing on market liquidity in the CDS market through different economic channels
 This figure visualizes how the introduction of central clearing can affect different determinants of CDS market liquidity. Using arrows and positive and negative signs, this figure visualizes the economic mechanisms through which the impact of central clearing leads finally to an impact on different dimensions of CDS market liquidity by affecting dealer competition, adverse selection and inventory costs. Matching incoming and outgoing arrows in the last layer are denoted by numbers. For example, central clearing may affect post-trade transparency positively. This, in turn, leads to a decrease in adverse selection. Lower adverse selection may decrease CDS market depth by disincentivizing trading activity of informed traders. This, in turn, may decrease CDS market breadth and positively affect market depth as it makes the market more attractive for uninformed traders. Furthermore, the market structure under voluntary central clearing is affected by the cleared trading volume and the number of CCPs in the market

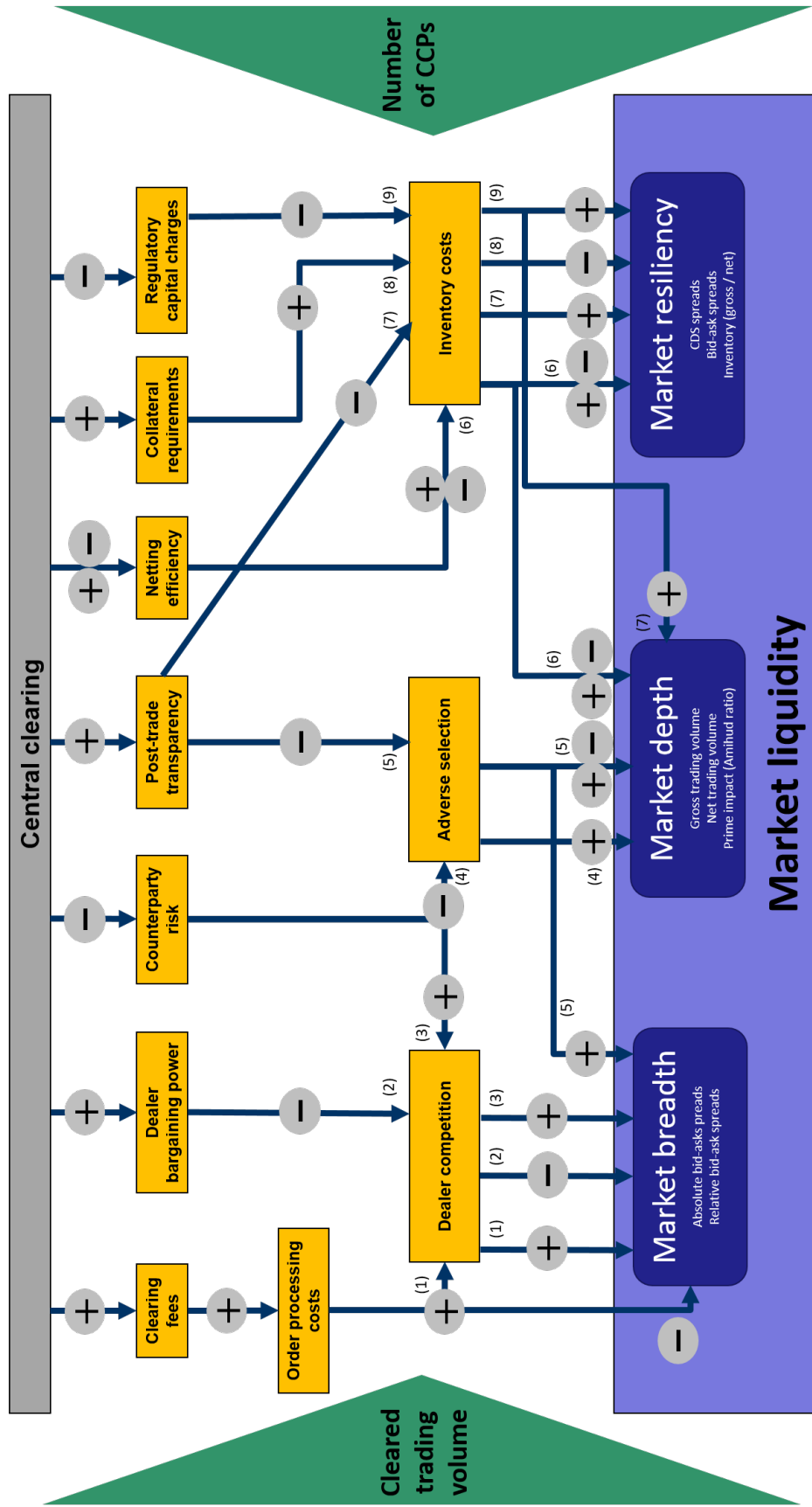

CHAPTER 3. MULTIDIMENSIONAL EFFECTS OF CENTRAL CLEARING
ON CDS MARKET LIQUIDITY AND THEIR ECONOMIC CHANNELS - A
REGRESSION DISCONTINUITY APPROACH

Table B.1: Panel unit root test on model residuals

This table shows p-values for fisher-type panel unit root tests on the residuals of our baseline regression discontinuity estimation based on equation 3.4. Fisher-type tests test the null hypothesis whether all individual time series in the panel dataset contain a unit root (Maddala and Wu, 1999). I conduct the panel unit root test for the panel of residuals from regression model (3.4). '***' indicates statistical significance at the 1% level.

Dep. var. model residuals	Fisher-type PUR test
ba_spread	0.0000***
pct_spread	0.0000***
cds_mid	0.0000***
gross_trading	0.0000***
net_trading	0.0000***
cds_amihud	0.0000***
price_res	0.0000***
ba_res	0.0000***
gross_inv_res	0.0000***
net_inv_res	0.0000***

B. APPENDIX TO CHAPTER 3

Table B.2: Woolridge test on autocorrelation in fixed effects panels

This table shows the p-values for the Woolridge test on autocorrelation in fixed effects panels for the dependent variables from regression (3.4).

Dependent variable	p value
ba_spread	0.000***
pct_spread	0.000***
cds_mid	0.000***
gross_trading	0.000***
net_trading	0.4925
cds_amihud	0.732
price_res	0.000***
ba_res	0.000***
gross_inv_res	0.000***
net_inv_res	0.000***

CHAPTER 3. MULTIDIMENSIONAL EFFECTS OF CENTRAL CLEARING
ON CDS MARKET LIQUIDITY AND THEIR ECONOMIC CHANNELS - A
REGRESSION DISCONTINUITY APPROACH

4 Firewall or superspreader? - CDS central clearing and contagion risk within the CDS dealer network

Michael Brosi¹ & Gregor Schoenemann²

Abstract

In this study, we empirically analyze the effect of central clearing of Credit Default Swaps (CDS) on contagion risk among the largest CDS dealers (G14 dealers). We use CDS spread data to measure the default risk of individual dealers and apply time series techniques from international capital market spillover literature to examine cointegration relationships, Granger causality, volatility spillovers and dealer connectedness within the CDS financial network. With the introduction of central clearing, we find contagion risk to decline considerably in different methodologies, especially among the most active CDS dealers. Our results do not seem to be driven by a global negative time trend of systemic risk and do not seem to represent the overall contagion risk among CDS dealers, irrespective of the source of contagion. Furthermore, our results largely hold when using stock prices instead of CDS spreads. We do not find evidence that contagion risk affects pricing behavior of CDS market participants.

JEL classification: G12, G15, G18, G28

Keywords: Central clearing, credit default swaps, contagion, systemic risk

¹University of Copenhagen, email: micha.brosi@web.de

²University of Hohenheim, Schurzstrasse 42, 70599 Stuttgart, Germany, e-Mail: gregor.schoenemann@uni-hohenheim.de

We are grateful for helpful comments from Monika Gehde-Trapp, Saeed Jamshidi, Robert Jung, Karsten Schweikert and participants at the 6th Finance Workshop Hohenheim. We thank for database access to Bloomberg, TRACE and Eikon / Datastream provided by DALAHO Hohenheim.

4.1 Introduction

In this paper we study how central clearing of Credit Default Swaps (CDS) affects systemic risk among CDS dealers. We define systemic risk from the perspective of contagion as the risk of default spillovers. In bilaterally cleared markets, default losses tend to propagate through the financial system by affecting those institutions most that are most strongly exposed to the defaulting institution. Such a scenario is depicted in Panel A of Figure 4.1.1.

In centrally cleared CDS trades, a central clearing counterparty takes on the counterparty risk by becoming the buyer to every seller, and the seller to every

Figure 4.1.1: Contagion risk in bilaterally cleared markets and centrally cleared markets

This figure shows different potential default loss propagation scenarios in bilaterally and centrally cleared markets. Panel B and Panel C assume different sizes of the CCP's capital resources for capturing default losses (red circle around CCP item). "D" and "CM" denote dealer and clearing member respectively. The links between the nodes visualize the exposures between different entities within the financial network, with exposure size increasing in boldness of the link. Defaults are visualized by crossed-out entities.

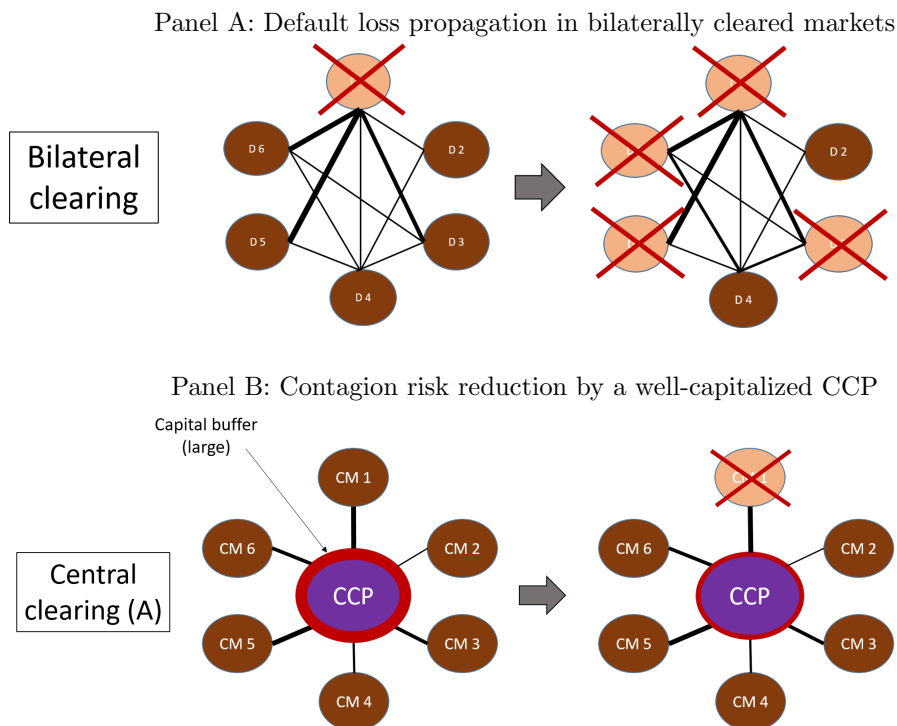

Panel C: Contagion risk increase by a poorly capitalized CCP

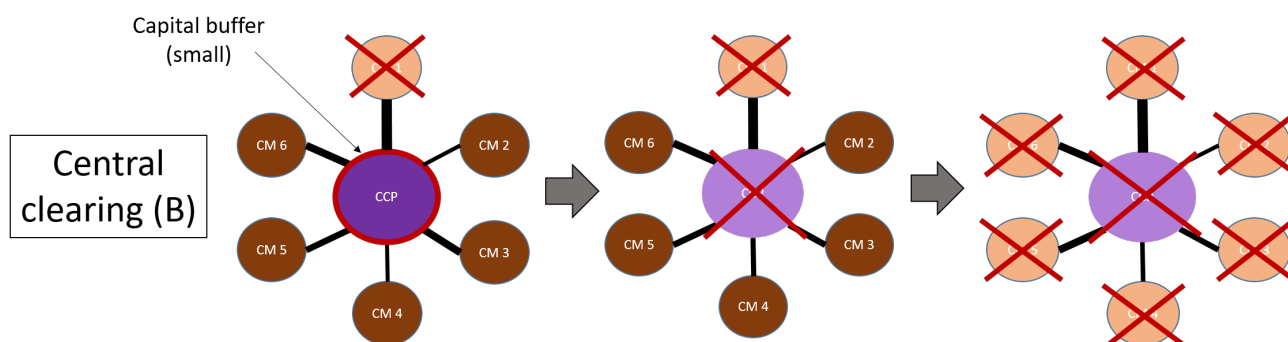

buyer. A CCP uses a ‘waterfall’ of financial resources to cover potential losses from the default of its clearing members as indicated by the red circle around the CCP item in Panel B and Panel C of Figure 4.1.1.

This default ‘waterfall’ consists of variation margins, initial margins, a default fund, own capital and haircuts on variation margins and shall prevent the propagation of default losses through the financial system beyond the counterparties, that are directly involved in the trade (contagion risk). Therefore, a well-capitalized CCP may decrease the contagion risk among its clearing members by effectively insulating them from each other’s default through a large capital buffer that also covers financial losses in extreme default scenarios (see Panel B of Figure 4.1.1). Yet, CCPs with insufficient capital resources may increase contagion risk within the CDS dealer network as Panel C of Figure 4.1.1 shows. In this case, a CCP creates financial ties between all participants of the financial network through its trading relationships with them but does not prevent effectively the spillover of default losses from itself to its clearing members. Multiple theoretical papers show that the design of the default waterfall affects trading incentives of clearing members and the resiliency of the financial system (Haene and Sturm, 2009; Glasserman et al., 2015; Capponi et al., 2017; Huang, 2019).

To the best of our knowledge, this is the first empirical study on the effect of CDS central clearing on systemic risk. More specifically, we analyze the vulnerability of the CDS dealer network to contagious effects among participants of the CDS financial network. For this purpose, we examine the risk of default spillovers among major CDS dealers (G14 dealers) before and after the introduction of central clearing. We hypothesize that contagion risk among CDS dealers decreases (increases) if a CCP on the CDS market can (not) effectively insulate the CDS dealers from each other’s default. The effective prevention of default loss spillover effects by the

CCP to the network of CDS dealers may depend on the structure of the CDS dealer network, clearing membership requirements, the design of the default waterfall, the degree of netting efficiency, and CDS market liquidity.

A financial network is characterized by trading relationships between different entities. These trading relationships allow default losses to propagate through the financial system because the default on a promised payment may in turn cause defaults of entities that are supposed to receive these payments and that rely on the fulfillment of the contract (Eisenberg and Noe, 2001).

The vulnerability of a financial network to such contagious effects depends on the specific network structure. A financial network consists of nodes (entities) and links (trading relationships) that tie different nodes together. The size of a node is determined by the market share of the corresponding institution and the strength of the links describes the exposure of an institution to other entities in the network. The connectivity between participants of a financial network can foster contagious effects since all ties in the form of trading relationships between network participants are potential channels for the propagation of default losses. However, diversified trading relationships within a financial network can also serve loss mutualization. In the case of a network with diversified trading relationships, default losses are spread homogeneously across the network and borne evenly by the remaining network participants (Nier et al., 2007; Battiston et al., 2012; Battiston and Caldarelli, 2013). The introduction of central clearing may decrease the diversification of trading relationships across multiple counterparties at the cost of counterparty risk concentration within an arguably more creditworthy CCP.

Allen and Gale (2000) show theoretically that a complete network, in which entities of similar size and exposures are all connected to each other, is resilient to local shocks that hit one institution, since exposures and interdependencies are diversified across all network participants. Consequently, connectivity among network participants increases the resiliency of financial networks towards contagion and prevents contagion above network-specific connectivity thresholds (Babus, 2007; Cont and Moussa, 2010). Cont and Moussa (2010) show, however, that the impact of network connectivity depends on the capitalization of the network. Connectivity in well-capitalized networks increases the resiliency of the network towards contagious effects but increases contagion risk in under-capitalized financial networks. Tiered networks consist of nodes and links of heterogeneous sizes and strengths, i.e. there are few dominant network participants with a higher systemic relevance and a larger number of less relevant network participants. In this case, a local shock can have

severe consequences if it hits a dominant network participant to which many other market participants are strongly exposed (Allen and Gale, 2000; Markose et al., 2012). Still, heterogeneous networks seem to be less prone to contagion (Borovkova and El Mouttalibi, 2013; Cont and Moussa, 2010). Indeed, financial entities appear to form networks in order to insure against contagion and endogenously form a network structure that suits this purpose best (Babus, 2007).

Like on other over-the-counter derivatives markets, CDS market participants are found to form a tiered network in the form of a core-periphery structure (Peltonen et al., 2014; Di Maggio et al., 2017; Hollifield et al., 2017; Eisfeldt et al., 2018; Li and Schürhoff, 2019). The findings of Du et al. (2019) show that CDS market participants prefer counterparties with low default probability and existing trading relationships that allow for the netting of offsetting positions. The core of CDS dealers may have a set of favorable trading characteristics like high creditworthiness, large netting opportunities, and economies of scale that incentivize market participants to primarily trade with them. Theoretical papers show that concentration risk exacerbates the systemic relevance of a financial institution and the contagion risk in the network (Cont et al., 2012; Cont and Moussa, 2010). Furthermore, multiple theoretical studies show that the higher the cleared trading volume is, the more effective the CCP. In this case, concentration risk is even more pronounced compared to a network structure in which a set of core dealers share the concentration risk. That is why it is not clear ex-ante whether the CDS market can effectively be made more resilient to contagion by the transition from bilateral clearing to central clearing.

Central clearing may allow contagion risk to be reduced through increased transparency as well as improved identification and regulation of potentially contagious institutions. Cont et al. (2012) argue that in heterogeneous financial networks, like interbank or dealer networks, regulation should not be uniform across all network participants (e.g. higher capital requirements for all institutions) but focus on the most contagious institutions. Central clearing allows the regulation of systemic risk on the level of clearing members and on the level of CCPs.

On the level of clearing members, a CCP may gain more information on the open positions of each individual clearing member than every individual network participant in a bilateral market would be able to. The CCP observes the trading relationships between each clearing member and all other market participants, whereas in a bilateral market, each market participant does not know the extent of any of its counterparties' other trading relationships, apart from its own positions.

Therefore, an individual margining of clearing members according to their trading positions with the CCPs may lead to more appropriate margin levels that better reflect the individual contribution of every clearing member to systemic risk.

Apart from variation margins that reflect the current value of the contract and are also part of bilateral CDS contracts, clearing members pledge initial margins to the CCP that are supposed to cover unfavorable price movements after a potential default. Acharya and Bisin (2014) show that the individual margining rule of CCPs should follow the risk-taking behavior of its clearing members and take on a super-linear structure. Superlinear margining disincentivizes the build-up of large trading positions that could cause large default losses to the financial system. Superlinear margining may also be necessary since clearing members may diversify their trading volume across different CCPs in the market. A margin rule that only takes the observable positions at the respective CCP into account may not be sufficient as it underestimates the negative effect on prices and market liquidity in case of a default (Glasserman et al., 2015). Empirical findings show that collateralization varies strongly across clearing members (Capponi et al., 2017). How effective collateralization schemes in voluntary central clearing regimes with incomplete position transparency are, remains an empirical question.

Second, the CCP itself as a potentially contagious institution is the focus of financial regulation. The central aspects of CCP regulation focus on the size of the default fund and the assumption made about the minimum liquidation period after the default of a clearing member. Lewandowska (2015) shows that complete loss mutualization can decrease systemic risk. However, it remains unclear how large the default resources must be in order to ensure that all potential losses from default can be mutualized among the remaining clearing members. Regulatory frameworks like the Dodd-Frank Act in the US or the European Market Infrastructure Regulation in the EU prescribe that the capital resources should be able to cover the default of the largest (DFA) or the two largest (EMIR) clearing members respectively (Cover-1 / Cover-2 scenario).

Scenarios like Cover-2 treat the occurring defaults as independent of each other. Existing literature shows, however, that the total default losses within a financial network increase in the interdependence of clearing member defaults and highly depend on the assumptions made about the correlation between multiple defaults (Cumming and Noss, 2013; Murphy and Nahai-Williamson, 2014; Barker et al., 2016; Bielecki et al., 2018; Paddrik and Young, 2019). Furthermore, loss mutualization via a default fund can increase excessive risk-taking under a Cover-2 scenario since the

clearing members' individual contribution to the default fund decreases with every new clearing member, unless a very large dealer joins the CCP as the largest or second-largest clearing member (Ghamami and Glasserman, 2016; Capponi et al., 2019). Simultaneously, the probability of default increases in the number of clearing members. Consequently, Capponi et al. (2017) and Bielecki et al. (2018) show that the Cover-2 requirement may not lead to an optimal design of the default fund unless opportunity cost of collateral is high.

Capponi et al. (2017) suggests the default fund should be of a size that can capture default costs of a constant fraction of the number of clearing members instead of a constant absolute number. The model of Bielecki et al. (2018) allows to calculate a ratio of initial margins to default fund resources based on the joint credit quality of clearing members over time and on different levels of risk. In multiple specifications, they achieve a ratio of initial margins to default fund of 0.1, which is close to empirical observations. Haene and Sturm (2009) show that high initial margins negatively affect the probability of moral hazard as they stress the 'defaulter pays' component within the composition of default resources. Only in the case of the default probability of a clearing member being lower than the opportunity cost of capital, the relevance of default fund resources for covering default losses should be stressed. Since margins are in practice of greater relevance for the default waterfall compared to the default fund, the opportunity cost of capital seems to be estimated as lower than the default probability of a clearing member.

Central clearing may not only change the way how losses from default are distributed within the network of CDS dealers but it can also change the total loss given default through increased netting opportunities. If CDS dealers use the CCP extensively for the clearing and settlement of their CDS trades, counterparty diversification decreases so that offsetting positions are more likely to occur with the same counterparty – the CCP. If offsetting positions occur with the same counterparty, they can be cancelled and replaced by one contract that reflects the net value of all existing contracts. This remaining net position is much smaller than the total value of the original gross positions. The smaller size of the total CDS positions in the market decreases potential default losses, liquidation and replacement activities, and subsequent price and liquidity drops after a default occurred. In order to achieve a higher netting efficiency compared to a bilateral market structure, the CCP needs critical masses of cleared trading volume and clearing members that depend on the bilateral market structure prior to the introduction of central clearing

(Duffie and Zhu, 2011; Heath et al., 2016; Cont and Kokholm, 2014; Lewandowska, 2015; Garratt and Zimmerman, 2017).

In order to attain a higher netting efficiency in a voluntary central clearing scheme, it is crucial for the CCP to attract sufficient trading volume. For this purpose, the CCP must be of a higher creditworthiness than any other dealer and membership requirements, as well as cost of collateral, must be low (Briukhova et al., 2019). However, as argued above, low collateral requirements can increase contagion risk leading to conflicting incentives within the business model of CCPs with respect to systemic risk. Armakola and Laurent (2015) also show that a high-quality base of clearing members is crucial because a low credit quality of clearing members gives rise to default losses in the first place, and creditworthy surviving clearing members may be needed for further liquidity injections in the form of margin calls, haircuts on variation margins, or the replenishment of the default fund.

The conflict for CCPs between high risk management standards (to ensure a low default probability) and low costs for clearing members (to attract high trading volumes) gives rise to concerns about a ‘race to the bottom’ between different CCPs in which competition among CCPs drives risk management standards down (Zhu, 2011). Empirical findings and theoretical simulations, however, show that collateral requirements are set more conservatively than current regulation and industry-standards like value at risk (VaR) imply (Zhu, 2011; Capponi et al., 2017). One example is the liquidation period after default of a clearing member, that is set to five days by ICE Clear Credit which is considerably longer than the regulatory requirement of one (DFA) or two days (EMIR) respectively (Ghamami and Glasserman, 2016; Capponi et al., 2017). Huang (2019) shows that higher collateral requirements may be rational for CCPs and clearing members alike since high risk management standards decrease the losses for surviving clearing members that have to be distributed in case of a default. Lower losses in case of a default may overcompensate higher costs of collateral in the first place.

High netting efficiency may reduce adverse effects in stressed market scenarios. Huang (2019) shows for equity markets that the exposures of CCPs rise drastically in periods of market stress. Market volatility and crowding are main drivers of increased CCP exposures during market stress. Capponi et al. (2017) find CCPs to increase collateral requirements when market stress, e.g. market volatility or credit risk, increases. Funding costs have a negative impact on collateral levels possibly because positions that require high collateral are liquidated by market participants in times of high funding costs. Consequently, Barker et al. (2016) find market volatility

to increase liquidity risks via default risk. They show default losses to mainly consist of liquidity costs (additional margin calls, liquidation and replacement costs as a result of low market liquidity) but less of defaults on actual payments, i.e. pure credit risk. The pure credit risk assessment may be of minor importance to CCPs and clearing members in comparison to aspects of funding and market liquidity. Avellaneda and Cont (2013) stress this point by modeling the optimal liquidation strategy for the auctioning of defaulting portfolios of trading partners, i.e. clearing members of the CCP. Principally, offsetting positions should be auctioned at the same time. Still, the current level of market liquidity must be assessed, as market illiquidity may exacerbate overall losses. In order to take into account the effect of market variables on default losses, EMIR requires a countercyclical buffer of 25% of the total margins that can be exhausted in times when margin requirements rise significantly, i.e. after periods of low market stress.

As pointed out above, the theoretical models from existing literature on the relation between central clearing and systemic risk are highly dependent on their underlying assumptions. Therefore, our study adds to the literature by providing empirical evidence on the impact of central clearing of CDS on contagion risk in the CDS dealer network. We measure the default risk of 14 major CDS dealers by the 5-year CDS spread. In order to calibrate our time series on the contagion risk that arises specifically from the CDS market, we weight the individual time series by the CDS market share of every individual CDS dealer as indicated by the Quarterly Derivatives Statistics of the Office of the Comptroller of the Currency (OCC). In order to be able to clearly identify the effect of CDS central clearing on contagion risk in the CDS dealer network, we create new CDS time series that are centered around the clearing eligibility event. For this purpose, we take clearing eligibility dates of 467 CDS contracts that become clearing eligible during our observation period, compute temporal distances in days to the central clearing eligibility event for all calendar days, and take the average CDS spread over all identical distances to the clearing eligibility event.

We apply time series techniques from the literature on international capital market spillovers using these new time series: cointegration tests (Kasa, 1992; Chou et al., 1994; Gray, 2009), Granger causality tests (Gray, 2009; Gelos and Sahay, 2001; Özen et al., 2014), volatility spillover analysis (Jung and Maderitsch, 2014), and empirical financial network connectivity modeling (Diebold and Yilmaz, 2009, 2012). Additionally, we use panel data analysis in order to examine the pricing consequence of contagion risk on CDS premia.

We find a largely consistent decrease of contagion risk within the CDS dealer network. We can attribute this decrease in contagion risk to a lower default risk dependence among the dominant CDS dealers that form the core of the core-periphery network. Additionally, the risk of peripheral dealers seems to be less affected by the risk of core dealers after the introduction of central clearing. Yet, the economic significance of contagion risk in the CDS market appears to be small. Consequently, we do not find evidence for any pricing effect of contagion risk on CDS premia.

Our findings are comparable to the results from the reinsurance sector. Reinsurers take on a similar role as CCPs do since they neutralize market risk at the cost of counterparty risk. Existing studies show that primary insurers are more closely interconnected by the activities of reinsurers but overall systemic risk does not increase (van Lelyveld et al., 2011; Cummins and Weiss, 2014; Park and Xie, 2014; Davison et al., 2016). We conclude that, despite the observed decrease in systemic risk measures, the introduction of CCPs on the CDS market may not be self-evident from the perspective of contagion risk.

Our paper adds to the literature by providing an empirical analysis of the effect of voluntary CDS central clearing on contagion risk. To the best of our knowledge, our study is the first to provide a purely reduced-form approach in order to examine the effect of CDS central clearing on contagion risk, measured as CDS dealer default risk dependence. We contribute to the literature on financial network analysis by showing a method to adapt time series techniques from the literature on international capital markets spillovers to OTC network dynamics. This opens up new perspectives for future research on the analysis of financial networks.

4.2 Data description and correlation analysis

In this chapter, we describe our initial dataset, show descriptive statistics and compute correlation coefficients among CDS dealers as a first tentative contagion risk measure. This section also focuses on the manipulation of our original CDS mid quote time series that is supposed to increase the precision of the economic and econometric identification of the effect of CDS central clearing on contagion risk.

4.2.1 Data sources and correlation analysis

Our initial dataset consists of daily CDS mid quotes of 14 large CDS dealers, the so-called G14 dealers.⁴ We obtain the CDS mid quote time series from Bloomberg. We choose CDS mid quotes as data input since CDS spreads are widely considered to be the purest market-based indicator of individual default risk. Therefore, a time series analysis of CDS spreads may be best suited to analyze the co-movement of individual default risk around the introduction of CDS central clearing. Our observation period starts in June 2009, roughly six months before the first CDS contract becomes eligible for central clearing and ends in December 2018. Our initial dataset contains 2355 observations of daily CDS mid quotes for all 14 major CDS dealers.

Panel A of Table C.1 shows results of Augmented-Dickey-Fuller tests on the existence of a unit root in our original CDS spread time series. For seven out of 14 CDS spread time series, we cannot reject the null hypothesis of a unit root at the 5% significance level. Since non-stationary time series have time-varying means and standard deviations, descriptive statistics on our CDS spread time series cannot be expected to be informative. Instead, we look closer into cross-sectional variation of the G14 dealers' CDS spreads and their variation over time in the plots of Figure 4.2.1. In order to get a more easily legible figure, we visualize the time series of the five dominant CDS dealers and of the nine peripheral dealers separately.⁵

Figure 4.2.1 displays large cross-sectional variation and variation over time for the individual time series. The two most prominent spikes can be attributed to the global financial crisis in 2009 and to the euro crisis 2012/2013. It is interesting to note that both cross-sectional variation and variation over time seem to decrease over time. Furthermore, Figure 4.2.1 provides graphical evidence that the time series of individual CDS dealers exhibit a clear and consistent co-movement during the entire observation period. We analyze the co-movement between the individual default risk of CDS market participants by looking at the correlation matrix displayed in Table 4.2.1.

⁴The 14 CDS dealer (and their mnemonics in this study) are: Bank of America (BOFA), Barclays (BC), BNP Paribas (BNP), Citibank (CITI), Crédit Agricole (LCL), Crédit Suisse (CS), Deutsche Bank (DB), Goldman Sachs (GS), HSBC (HSBC), JP Morgan (JPM), Morgan Stanley (MS), Société Générale (SG), UBS (UBS), and Wells Fargo (WF). We restrict our analysis to the G14 dealers (instead of G16), as we could not retrieve CDS spread data for Nomura and The Royal Bank of Scotland.

⁵The five most dominant CDS dealer in terms of outstanding positions are: Bank of America, Citibank, Goldman Sachs, HSBC, and JP Morgan. In the remainder of the paper, we refer to them as G5 or core dealers. We refer to the remaining dealers as periphery or peripheral dealers.

CHAPTER 4. FIREWALL OR SUPERSPREADER? - CDS CENTRAL CLEARING AND CONTAGION RISK WITHIN THE CDS DEALER NETWORK

Figure 4.2.1: CDS spread time series of core and peripheral dealers from 2009-2018
This figure shows CDS spreads of the five largest CDS dealers and the nine remaining peripheral dealers across our observation period between 2009 and 2018.

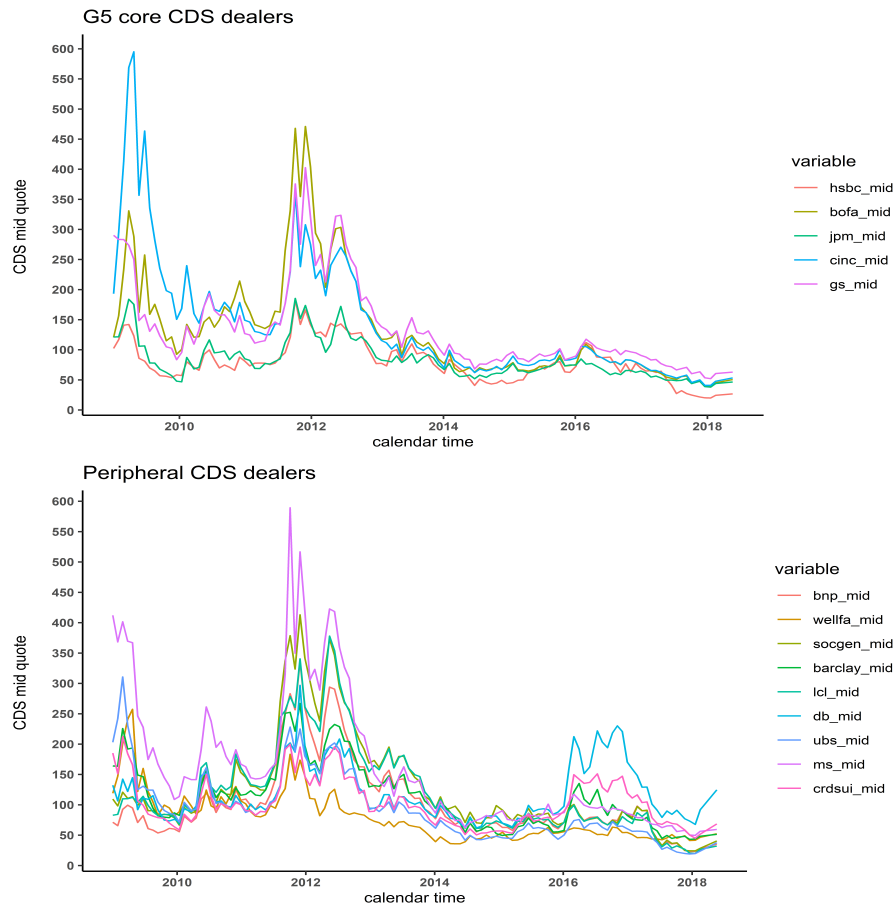

As expected, Table 4.2.1 displays many pairwise correlation values of 0.7 and higher, indicating a strong co-movement of individual CDS dealer default risk. This is not surprising as these major CDS dealers are not only linked by their CDS trading relationships but also by many other economic relationships like credit and lending or exposures on other financial markets. However, there are also several lower correlation coefficients between 0.3 and 0.6 reported in Table 4.2.1. The strength of the financial ties seems to differ across pairs of CDS market participants. Our dataset seems to provide sufficient variation across time and in the cross-section of CDS spreads, as well as for the correlation measures that can be exploited in a time series analysis.

4.2. DATA DESCRIPTION AND CORRELATION ANALYSIS

Table 4.2.1: Correlation matrix of individual pairwise G14 dealer correlation coefficients

This table shows the pairwise CDS return Pearson correlation coefficients for all pairs of G14 dealers.

	HSBC	BOFA	BNP	WF	JPM	SG	BC	C	DB	LCL	GS	UBS	MS	CS
HSBC	1													
BOFA	0.825	1												
BNP	0.835	0.826	1											
WF	0.656	0.823	0.451	1										
JPM	0.878	0.893	0.748	0.849	1									
SG	0.817	0.846	0.989	0.477	0.750	1								
BC	0.922	0.885	0.871	0.723	0.890	0.871	1							
C	0.640	0.784	0.420	0.938	0.813	0.445	0.694	1						
DB	0.816	0.809	0.973	0.474	0.743	0.976	0.874	0.455	1					
LCL	0.678	0.524	0.613	0.310	0.497	0.546	0.634	0.288	0.530	1				
GS	0.879	0.929	0.839	0.771	0.931	0.847	0.913	0.742	0.830	0.560	1			
UBS	0.860	0.874	0.711	0.850	0.916	0.728	0.904	0.834	0.725	0.492	0.933	1		
MS	0.849	0.938	0.803	0.817	0.928	0.818	0.908	0.798	0.804	0.520	0.986	0.946	1	
CS	0.870	0.734	0.718	0.636	0.794	0.676	0.862	0.602	0.673	0.843	0.808	0.822	0.793	1

4.2.2 Adjustment of the original time series to the dynamics of the CDS financial network

In a first step, we incorporate the dynamics of the CDS network into our original time series by weighting every observation point by the market share of the respective dealer in the CDS market. We calculate the CDS market share from the US Quarterly Report on Bank Trading and Derivatives Activities of the Office of the Comptroller of the Currency that reports gross positions in single-name CDS for the 25 most active CDS trading banks. Although the OCC report refers only to US corporations or subsidiaries of European banks registered in the US, it seems that the data in these reports are suitable to model the CDS financial network empirically because we find a similar degree of CDS market concentration and CDS dealer dominance just as found in previous studies (Brunnermeier et al., 2013; Peltonen et al., 2014; Levels et al., 2018). From the OCC reports, we get market weights for the financial institutions in our sample by dividing their CDS gross position by the total CDS gross position across all institutions in the corresponding OCC report. For the institutions that belong to our sample but are not listed in the OCC report, we distribute the difference between the aggregate market weight of the listed institutions and one equally across these institutions. This happens only for institutions with a very low CDS market weight (peripheral dealers) because the five dominant CDS trading banks (G5) are consistently listed throughout our observation period and tend to make up for roughly 95% of all outstanding CDS gross positions.

Now we analyze graphically the development of the CDS return correlation between the G14 CDS dealers during our observation period. In the presence of a global systemic risk time trend, any time series analysis will be biased. This is why we track the development of contagion risk among different subsets of the G14 dealers in terms of average CDS return correlation in Figure 4.2.2.

Besides the average CDS return correlation across all G14 dealers, Figure 4.2.2 displays the average pairwise CDS return correlation for the five largest dealers, the remaining peripheral dealers, and for all core-periphery dealer pairs separately. We observe that the range of the average pairwise CDS return dealer correlations is mainly between 0.3 and 0.7, with some downward spikes across all samples. Only the average CDS return correlation among peripheral CDS dealers is consistently higher and ranges mainly between 0.5 and 0.9. In all CDS return correlation time series, we cannot observe a global time trend that may introduce a structural bias into empirical time series models.

Due to the numerous clearing eligibility dates and the large variety of potential confounding factors, it does not seem optimal to analyze the effect of central clearing with time series along the calendar time dimension. This is why we manipulate the original time series so that they are centered around the event of the introduction of central clearing. Figure C.1 visualizes the procedure for a subsample of one dealer time series and three clearing eligibility dates.

Figure 4.2.2: Average pairwise CDS return correlations for different subsets of G14 dealers (calendar time)
 This figure shows average pairwise Pearson CDS return correlations for different subsets of G14 dealers during our observation period. We use a 60-day rolling window for the correlation estimation.

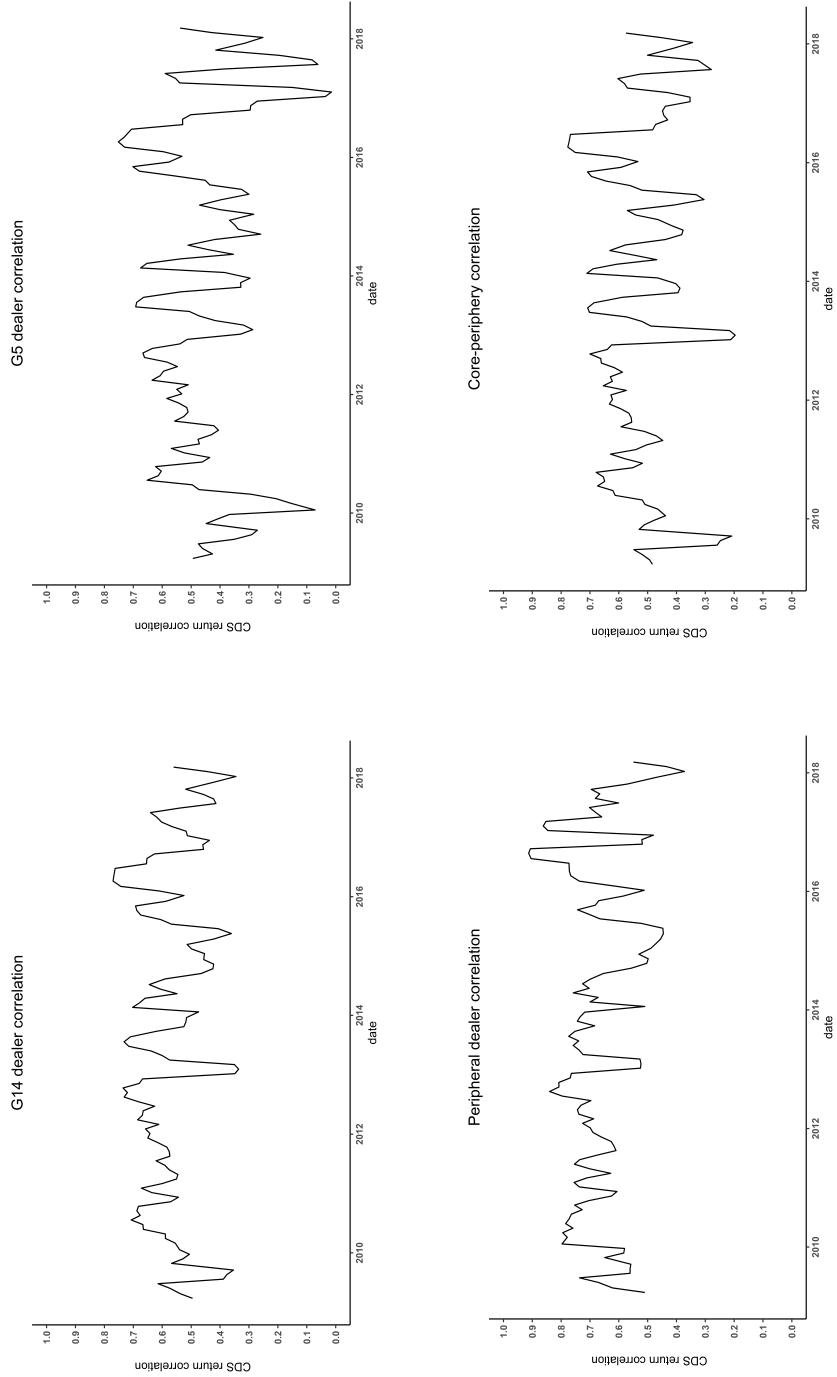

CHAPTER 4. FIREWALL OR SUPERSPREADER? - CDS CENTRAL CLEARING AND CONTAGION RISK WITHIN THE CDS DEALER NETWORK

First, we collect all dates at which CDS contracts become eligible for central clearing from 2009 until the end of 2018 from ICE Clear Credit, the dominant CCP for CDS. From these clearing dates, we compute the difference between the observation date and clearing eligibility date in days for every CDS contract that becomes clearing eligible during our observation period and for every observation date. If contract “XYZ” becomes clearing eligible on 21st of December, this “clearing distance” for XYZ takes on the value of -5 (+6) on the 16th (27th) of December. As we have 461 CDS contracts in our sample that become clearing eligible between 2009 and 2018, we obtain 461 time series of clearing distances. In order to obtain time series of CDS mid quotes for the G14 dealers that are largely unaffected by confounding factors along calendar time and also allow us to clearly identify changes in the contagion risk among CDS network participants around the introduction of central clearing, we take averages of CDS mid quotes across all identical clearing distances for each time series of individual dealers’ CDS mid quotes. This procedure creates new time series of CDS mid quotes for each of the G14 CDS dealers in event time dimension with observations in days prior to and after central clearing eligibility instead of calendar time. Furthermore, most observations in the event time series consist of numerous observations from the original time series along calendar time. This eliminates the problem of local time trends because the observations in event time consist of data inputs across all years of observations. We repeat the procedure (weighting and creating event time series) for CDS returns.

Our analysis may be biased by potential reverse causality if contagion risk among the G14 dealers decreases over time due to decreasing CDS exposures as a result of the financial crisis. If this trend is persistent during our observation period, we may find an overall decrease in contagion risk from the pre- to the post-clearing period solely as a result of this global time trend. The introduction of central clearing could also incentivize CDS trading and increase contagion risk for the post-clearing period through increased financial ties among the G14 dealers via the CDS market. In both cases, the results may be partly or fully explainable by an endogenous relationship between CDS central clearing introduction and contagion risk. In order to check whether we face time trends in our event time series of CDS return correlations, we visualize the average CDS return correlation time series of all G14 dealers, G5 dealers, peripheral dealers, and core-periphery dealer pairs around the beginning of CDS central clearing introduction. We display the CDS return correlation time series based on the adjusted CDS return event time series in Figure 4.2.3.

Figure 4.2.3: Average pairwise CDS return correlations for different subsets of G14 dealers (event time)
 These figures show average pairwise Pearson CDS return correlations for different subsets of G14 dealers around the introduction of CDS central clearing. We use a 60-day rolling window for the correlation estimation.

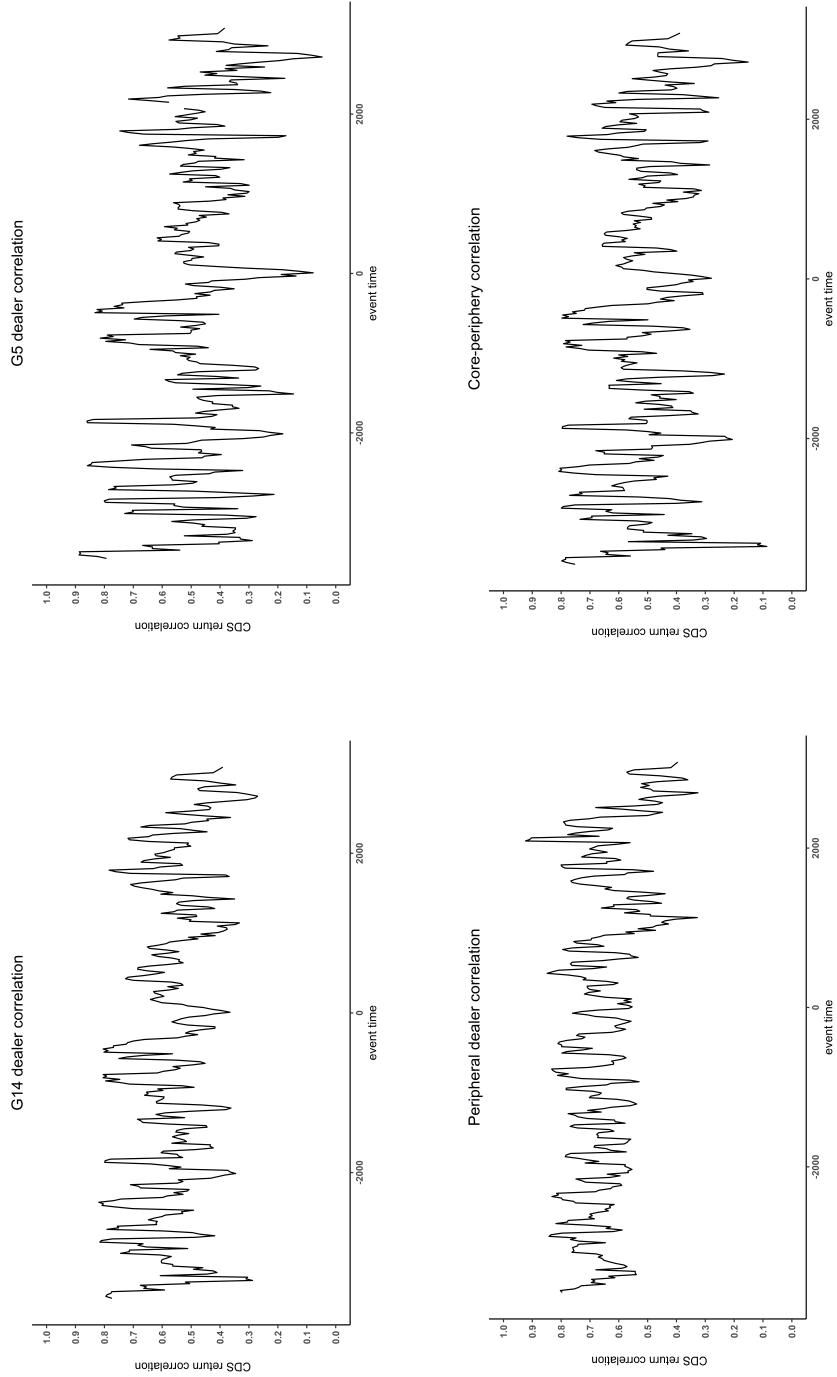

The average pairwise CDS return correlations as shown in Figure 4.2.3 look similar to the time series displayed in Figure 4.2.2. We do not observe a clear time trend and therefore reverse causality seems to be unlikely. Furthermore, we test the different CDS return time series and CDS return correlation time series for stationarity by an Augmented-Dickey-Fuller test. Panel B of Table C.1 shows that we can reject the null hypothesis on the existence of a unit root for all of these time series. This finding supports our view that we do not encounter an overarching time trend in CDS dealer contagion risk during our observation period.

Finally, we test whether the average pairwise CDS return correlation between the G14 dealers changes with the introduction of central clearing. For this purpose, we calculate the individual pairwise CDS return correlations for all pairs of G14 dealers and take the average of all pairwise correlations at every observation date. This procedure creates a time series of the average pairwise CDS return correlation across all G14 dealers in event time. In order to examine contagion risk among different subsets of CDS dealers separately, we repeat this procedure for core dealer pairs only, peripheral dealer pairs only, and core-periphery dealer pairs only. The rolling time window for the correlation measure is 60 days and we restrict the observation window to 200 days prior to and after the beginning of central clearing eligibility. As outlined in Forbes and Rigobon (2002), it is important to note that in the presence of heteroskedastic time series with increasing variance over time, a change in the correlation measure cannot be interpreted as a change in contagion risk within the financial network. This is why we adjust the correlation coefficient for the period with the higher average 60-day rolling CDS return variance across all G14 dealers by the change in this variance from the low-variance to the high-variance period as shown in Equation 4.1:

$$\rho_t^* = \frac{\rho_t}{\sqrt{(1 - \delta)(1 - (\rho_t^2))}} \quad (4.1)$$

with:

$$\delta = \frac{\sigma_{high}^2}{\sigma_{low}^2} - 1 \quad (4.2)$$

The results on the heteroskedasticity-adjusted correlation coefficient (HACC) prior to and after the introduction of central clearing for different subsets of CDS dealers are given in Table 4.2.2.

4.2. DATA DESCRIPTION AND CORRELATION ANALYSIS

Panel A of Table 4.2.2 shows that the average CDS return correlation among the G14 dealer decreases by 0.01 with the introduction of central clearing but this change is not statistically significant on conventional significance levels. We see stronger decreases in the HACCs among core CDS dealers (0.04) and among peripheral CDS dealers (0.02). Only the HACC between core dealers and peripheral dealers increases. In conclusion, the HACC analysis points to a slight decrease in contagion risk among most parts of the CDS financial network but also to different contagion risk dynamics between different subsets of CDS dealers.

Table 4.2.2: Heteroskedasticity-adjusted CDS return correlation coefficients

This table shows the average heteroskedasticity-adjusted CDS return correlation coefficients for different subsets of G14 dealers prior to and after the introduction of central clearing and a t-test of the difference in the corresponding means. The heteroskedasticity-adjusted correlation coefficients (HACCs) are computed according to Equation 4.1 and 4.2. Besides the average HACCs for all dealer pairs (Panel A), we use different subsets of CDS dealers in order to analyze contagion risk between core and peripheral dealers (Panel B), core dealers only (Panel C), and peripheral dealers only (Panel D). We restrict the observation period to 200 days prior to and 200 days after the introduction of central clearing.

Panel A: All dealer pairs

statistic	value
ρ_{pre}	0.49
ρ_{post}	0.48
t test	-1.00

Panel B: Core-periphery dealer pairs

statistic	value
ρ_{pre}	0.40
ρ_{post}	0.44
t test	5.00

Panel C: G5 core dealer pairs

statistic	value
ρ_{pre}	0.34
ρ_{post}	0.30
t test	-4.00

Panel D: Peripheral dealer pairs

statistic	value
ρ_{pre}	0.64
ρ_{post}	0.62
t test	-3.00

4.3 Empirical analysis

In this section, we examine the impact of CDS central clearing on contagion risk by analyzing the default risk dependence between the G14 CDS dealers. First, we test whether cointegration relationships between the CDS spreads of CDS dealers change with the introduction of central clearing. Second, we perform bi- and multivariate Granger causality tests for the G5 CDS dealers and peripheral dealers separately, prior to and after the introduction of central clearing, in order to analyze whether the number of Granger causing relationships increases or decreases. Third, we analyze volatility spillovers from the three largest CDS dealers to the remaining dealers prior to and after the introduction of central clearing in order to examine whether the number of significant coefficients changes. Fourth, we use forecast error variance decomposition for the computation of a unique spillover index for the whole CDS dealer network prior to and after the introduction of central clearing. Last, we test in a fixed effects analysis whether the pricing effect of contagion risk on CDS premia changes with the introduction of central clearing.

4.3.1 Cointegration test

In this section, we analyze the co-movement of individual dealers' default risk by testing for cointegration of their CDS spread time series. The cointegration test provides evidence as to whether time series have a persistent relation to each other or not. Economically, we assume the cointegration relationships between CDS dealers' CDS spreads are based on the trading relationships created in the CDS market and the mutual exposures arising from them. Since cointegration cannot exist between exclusively stationary time series, we test the CDS spread event time series for non-stationarity by an Augmented Dickey-Fuller test. Panel C of Table C.1 shows that we cannot reject the null hypothesis of non-stationarity for almost all of the time series for the pre-clearing period as well as for the post-clearing period. If we cannot reject the hypothesis of cointegration for two individual time series, we assume that one time series is a linear combination of the other time series. This means that they exhibit a strict co-movement over time. If central clearing insulates CDS dealers from each other's default risk, we expect a lower number of CDS spread time series of the G14 dealers to be cointegrated after the introduction of central clearing. We perform a cointegration test according to the methodology of Johansen (1991) for the CDS spread time series of the G5 CDS core dealers and of peripheral dealers for the

4.3. EMPIRICAL ANALYSIS

pre- and the post-clearing periods separately. The results of the cointegration tests among core and peripheral CDS dealers for pre-clearing and post-clearing period are given in Table 4.3.1.

Panel A of Table 4.3.1 displays the test results on cointegration among the G5 CDS dealers for the pre-clearing period. For the pre-clearing period, we can reject the hypothesis that four or fewer of the five time series of the G5 CDS dealers are not cointegrated at a significance level of 5%. For the post-clearing period (Panel B), we cannot reject the hypothesis that there is no cointegration at all among the CDS spread time series of the G5 dealers at a significance level of 5%.

We see a similar decrease in the number of cointegration relationships among peripheral dealers from the pre-clearing period to the post-clearing period in Panel C and Panel D. In the pre-clearing period, we can reject the hypothesis of no cointegration among all CDS spread time series of peripheral dealers at 5% significance

Table 4.3.1: Cointegration test

This table shows cointegration tests on CDS spread time series for CDS core and periphery dealers separately prior to and after the introduction of central clearing. We test cointegration by the maximum eigenvalue test statistic and allow for a constant term in the cointegration relationship. The number of lags is determined by the Akaike Information Criterion (AIC). Panel A (B) shows results on the cointegration of CDS spread time series of the five largest CDS dealers prior to (after) the introduction of central clearing. Panel C (D) shows results on the cointegration of CDS spread time series of the remaining nine peripheral CDS dealers prior to (after) the introduction of central clearing. Green- (red-)colored values are (not) exceeded by the test statistic and (do not) lead to a rejection of the null hypothesis of no cointegration on the corresponding level of statistical significance.

Panel A: G5 - Pre-clearing					Panel B: G5 - Post-clearing				
	test stat	10pct	5pct	1pct		test stat	10pct	5pct	1pct
r _i =4	5.58	7.52	9.24	12.97	r _i =4	2.54	7.52	9.24	12.97
r _i =3	19.11	13.75	15.67	20.2	r _i =3	7.34	13.75	15.67	20.2
r _i =2	42.67	19.77	22	26.81	r _i =2	16.82	19.77	22.00	26.81
r _i =1	91.88	25.56	28.14	33.24	r _i =1	20.40	25.56	28.14	33.24
r=0	203.18	31.66	34.4	39.79	r=0	44.34	31.66	34.40	39.79

Panel C: Periphery - Pre-clearing					Panel D: Periphery - Post-clearing				
	test stat	10pct	5pct	1pct		test stat	10pct	5pct	1pct
r _i =8	10.89	7.52	9.24	12.97	r _i =8	3.10	7.52	9.24	12.97
r _i =7	16.26	13.75	15.67	20.2	r _i =7	8.33	13.75	15.67	20.2
r _i =6	41.06	19.77	22	26.81	r _i =6	11.63	19.77	22	26.81
r _i =5	125.07	25.56	28.14	33.24	r _i =5	17.27	25.56	28.14	33.24
r _i =4	199.52	31.66	34.4	39.79	r _i =4	25.31	31.66	34.4	39.79
r _i =3	205.20	37.45	40.3	46.82	r _i =3	30.43	37.45	40.3	46.82
r _i =2	306.45	43.25	46.45	51.91	r _i =2	43.99	43.25	46.45	51.91
r _i =1	518.22	48.91	52	57.95	r _i =1	75.61	48.91	52	57.95
r=0	605.66	54.35	57.42	63.71	r=0	98.40	54.35	57.42	63.71

level. For the post-clearing period, we can reject the hypothesis of no cointegration for only three or fewer CDS spread time series of peripheral dealers.

From the pre-clearing period to the post-clearing period, we observe a considerable decrease in cointegration relationships between the CDS spread time series of the G5 dealers as well as for the peripheral dealers. This provides evidence for a lower co-movement of the default risk across core and peripheral CDS dealers with the introduction of central clearing. Thus, CCPs may decouple the individual default risk of CDS dealers by insulating them from each other's default risk through additional capital buffers that can capture potential default losses.

4.3.2 Granger causality test

In this section, we analyze mutual dealer default risk dependence among CDS dealers by performing bi- and multivariate Granger causality tests on the 20-day CDS return volatilities of the G5 dealers and peripheral dealers separately. In our case, the direction of Granger causality is not the central point of this analysis but the existence of statistically significant Granger-causal relationships among core and peripheral CDS dealers.

First, we perform bivariate Granger causality tests across all core dealer pairs in both possible directions. For five time series, the different test directions give us twenty different Granger causality tests. Next, we extend our analysis by multivariate Granger causality tests on time series of core and peripheral CDS dealers separately. For the five core (nine peripheral) dealers, we test the null hypothesis that the CDS return volatility time series of one dealer is simultaneously Granger-caused by the remaining four (eight) dealers' CDS return volatility time series. We perform these Granger causality tests for pre-clearing period and post-clearing period separately according to the following vector autoregressive (VAR) model:

Bivariate Granger causality test:

$$\begin{aligned}
 \text{cds_vol20}_{i,t} = & \alpha + \beta_1 * \text{cds_vol20}_{i,t-1} + \dots + \beta_p * \text{cds_vol20}_{i,t-p} \\
 & + \gamma_1 * \text{cds_vol20}_{j,t-1} + \dots + \gamma_p * \text{cds_vol20}_{j,t-p} \\
 & + \epsilon_{i,t}
 \end{aligned} \tag{4.3}$$

Multivariate Granger causality test:

$$\begin{aligned}
 \text{cds_vol20}_{i,t} = & \alpha + \beta_1 * \text{cds_vol20}_{i,t-1} + \dots + \beta_p * \text{cds_vol20}_{i,t-p} \\
 & + \gamma_1 * \text{cds_vol20}_{j1,t-1} + \dots + \gamma_p * \text{cds_vol20}_{j1,t-p} \\
 & + \theta_{k-1} * \text{cds_vol20}_{jk-1,t-1} + \dots + \theta_{k-1} * \text{cds_vol20}_{jk-1,t-p} \\
 & + \epsilon_{i,t}
 \end{aligned} \tag{4.4}$$

i denotes one dealer, while j denotes a remaining dealer from the same subset of core or peripheral dealers to which i belongs. k denotes the number of total entities in the subset of core dealers and peripheral dealers respectively. The number of lags p to be included is determined by the AIC, with a maximum of ten lags. If CCPs lead to a better insulation of CDS dealers from the default risk of other dealers, we expect a lower number of Granger-causal relationships in the post-clearing period compared to the pre-clearing period. The results for bi- and multivariate Granger causality tests for the pre- and post-clearing periods are given in Table 4.3.2.

Panel A of Table 4.3.2 displays F statistics and p values for the bivariate Granger causality tests across the five largest CDS dealers in the pre-clearing period. For the pre-clearing period, the results show statistically highly significant Granger-causal relationships for all pairs of the CDS dealers in our analysis. For the post-clearing period (Panel B), only ten of the twenty potentially Granger-causal relationships are statistically significant at the 5% level. From pre-clearing period to post-clearing period, we see that the number of statistically significant Granger-causal relationships among the G5 CDS dealers decreases by 50%.

Panels C-F of Table 4.3.2 display F statistics and p values for the multivariate Granger causality tests across the G5 and peripheral dealers in the pre- and post-clearing period. For the pre-clearing period, the results show statistically highly significant Granger-causal relationships across all G5 CDS dealers (Panel C). For the post-clearing period, only three out of five potentially Granger-causal relationships from a G5 dealer to the other G5 dealers are statistically significant at the 5% level, and F statistics decrease by more than 90% for all Granger-causal relationships (Panel D).

The results for the subset of peripheral dealers are not as strong as for the G5 dealers. For the pre-clearing period (Panel E), the time series of all dealers seem to be Granger-caused by the time series of the other dealers in the corresponding subset. For the post-clearing period (Panel F), we find that the time series of Cr dit

CHAPTER 4. FIREWALL OR SUPERSPREADER? - CDS CENTRAL
CLEARING AND CONTAGION RISK WITHIN THE CDS DEALER
NETWORK

Suisse is not Granger-caused by the other peripheral dealers and the F statistics for almost all Granger causality tests decrease by roughly 90%.

Table 4.3.2: Granger causality test

This table shows bi- and multivariate Granger causality tests on CDS return volatility time series for CDS core and periphery dealers separately prior to and after the introduction of central clearing. Panel A (Panel B) shows results on bivariate Granger causality tests according to regression (4.3) on pairs of log realized 20-day CDS return volatilities among core and peripheral CDS dealers prior to (after) the introduction of central clearing. Panel C/E (Panel D/F) shows results on multivariate Granger causality tests according to regression (4.4) using the G5/peripheral dealers' log realized 20-day stock return volatilities prior to (after) the introduction of central clearing. The number of lags included is selected according to the Akaike Information Criterion under the assumption of a constant and a time trend in the VAR model.

Panel A: G5 - Pre-clearing (bivar.)

Variables	F statistic	p-value
HSBC - BOFA	10.60	0.00
BOFA - HSBC	10.63	0.00
HSBC - CINC	27.59	0.00
CINC - HSBC	12.11	0.00
HSBC - JPM	85.38	0.00
JPM - HSBC	82.94	0.00
HSBC - GS	63.93	0.00
GS - HSBC	62.20	0.00
BOFA - CINC	32.71	0.00
CINC - BOFA	11.66	0.00
BOFA - JPM	8.23	0.00
JPM - BOFA	7.09	0.00
BOFA - GS	10.25	0.00
GS - BOFA	9.72	0.00
CINC - JPM	13.81	0.00
JPM - CINC	28.78	0.00
CINC - GS	12.64	0.00
GS - CINC	27.87	0.00
JPM - GS	87.22	0.00
GS - JPM	89.45	0.00

Panel B: G5 - Post-clearing (bivar.)

Variables	F statistic	p-value
HSBC - BOFA	0.56	0.85
BOFA - HSBC	1.27	0.24
HSBC - CINC	1.70	0.07
CINC - HSBC	2.53	0.01
HSBC - JPM	2.22	0.01
JPM - HSBC	2.76	0.00
HSBC - GS	0.35	0.97
GS - HSBC	1.97	0.03
BOFA - CINC	2.18	0.02
CINC - BOFA	0.25	0.99
BOFA - JPM	3.96	0.00
JPM - BOFA	1.93	0.04
BOFA - GS	0.34	0.97
GS - BOFA	1.51	0.13
CINC - JPM	1.98	0.04
JPM - CINC	4.28	0.00
CINC - GS	0.28	0.98
GS - CINC	3.33	0.00
JPM - GS	0.39	0.94
GS - JPM	1.05	0.40

Panel C: G5 - Pre-clearing (multivar.)

Variables	F statistic	p-value
HSBC	48.72	0.00
BOFA	36.36	0.00
CINC	28.14	0.00
JPM	48.44	0.00
GS	48.59	0.00

Panel D: G5 - Post-clearing (multivar.)

Variables	F statistic	p-value
HSBC	1.24	0.16
BOFA	2.03	0.00
CINC	1.37	0.07
JPM	1.96	0.00
GS	1.66	0.01

Panel E: Periphery - Pre-clearing (multivar.)

Variables	F statistic	p-value
BNP	82.99	0.00
WF	70.97	0.00
SC	82.74	0.00
BC	83.34	0.00
DB	77.46	0.00
LCL	8.42	0.00
UBS	84.36	0.00
MS	83.48	0.00
CS	83.65	0.00

Panel F: Periphery - Post-clearing (multivar.)

Variables	F statistic	p-value
BNP	6.32	0.00
WF	4.23	0.00
SC	5.64	0.00
BC	2.06	0.01
DB	4.15	0.00
LCL	8.23	0.00
UBS	2.39	0.00
MS	4.04	0.00
CS	1.58	0.06

From the pre-clearing to post-clearing period, we see that the number of statistically significant Granger-causal relationships among the G5 CDS dealers and among peripheral dealers decreases. After the introduction of central clearing, the short-term CDS return volatility of CDS dealers seems to exhibit a weaker effect on other CDS dealers' short-term CDS return volatility, especially in the core of the CDS financial network. The reason may be the default insulating function of CCPs that decouples default risk dependence among CDS dealers.

4.3.3 Volatility spillover analysis

In this section, we analyze volatility spillover effects from the dominant CDS dealers in the core of the CDS financial network to dealers in the periphery that have a lower market weight according to the OCC statistics. The previous section provides evidence on a reduction in contagion risk among core dealers and among peripheral dealers with the introduction of central clearing on the CDS market. For the contagion risk between core and peripheral dealers, we find an increase in the HACCC in section 4.2.2. In this chapter, we examine more specifically whether CCPs change the contagion risk between core and peripheral CDS dealers.

Existing literature on the network structure of OTC markets suggests that peripheral dealers do not diversify their trading volume extensively but rely particularly on one or few core dealers (Hendershott et al., 2017; Iercosan and Jiron, 2017). Therefore, in bilaterally cleared markets they depend strongly on the creditworthiness of these dealers. Central clearing can exacerbate this phenomenon if small dealers have to opt for one dealer as their 'interface' to central clearing services. However, central clearing may make smaller dealers more dependent on the creditworthiness of the CCP and less dependent on the default risk of their preferred core dealer. This may reduce contagion risk between core and peripheral dealers. On the other hand, peripheral dealers generally have lower exposures so that the default risk of their counterparties may not substantially affect their own default risk. In this case, central clearing may not significantly change the default risk dependence between core and peripheral dealers.

For the analysis of default risk dependence between core dealers and peripheral dealers, we perform an autoregressive distributed lag (ADL) model according to Jung and Maderitsch (2014) that regresses the short-term CDS return volatility of a peripheral dealer on the short-term CDS return volatilities of the three CDS dealers with the largest market weight according to the OCC statistics. We define

CHAPTER 4. FIREWALL OR SUPERSPREADER? - CDS CENTRAL
CLEARING AND CONTAGION RISK WITHIN THE CDS DEALER
NETWORK

short-term volatility as the historical 20-day CDS return volatility. Due to the persistence in volatility measures (Andersen et al., 2003, 2001; Choi et al., 2010), we include variables for mid- and long-term volatility in our model (Corsi, 2009) that capture the return volatility over the last 60 and 120 days. We estimate the following regression model:

$$\begin{aligned}
 \text{cds_vol20}_{i,t} = & \alpha \\
 & + \beta_1 * \text{bofa_vol20}_t + \beta_2 * \text{bofa_vol60}_t + \beta_3 * \text{bofa_vol120}_t \\
 & + \beta_4 * \text{citi_vol20}_t + \beta_5 * \text{citi_vol60}_t + \beta_6 * \text{citi_vol120}_t \\
 & + \beta_7 * \text{jpm_vol20}_t + \beta_8 * \text{jpm_vol60}_t + \beta_9 * \text{jpm_vol120}_t \\
 & + \epsilon_{i,t}
 \end{aligned} \tag{4.5}$$

cds_vol20_t denotes the realized 20-day CDS log return volatility CDS dealer i at time t . $\text{bofa_vol20 (60, 120)}_t$, $\text{citi_vol20 (60, 120)}_t$, $\text{jpm_vol20 (60, 120)}_t$ is the realized 20 (60, 120)-day CDS log return volatility of the three largest CDS dealers: Bank of America, Citibank, and JP Morgan. Results for Equation (4.5) are given in Panel A and Panel B of Table 4.3.3.

Panel A of Table 4.3.3 displays results for the ADL model in the pre-clearing period. For the pre-clearing period, the results show three statistically significant relationships between the short-term volatility of a core dealer and a peripheral dealer: one for Citibank and two for JP Morgan. Panel B of Table 4.3.3 displays results for the ADL model in the post-clearing period. For the post-clearing period, the results show only one statistically significant relationship between any of the volatility coefficients of core and peripheral dealers at the 5% significance level. Since most of the statistically significant coefficients in Panel A of Table 4.3.3 become insignificant in Panel B of Table 4.3.3, the results provide evidence that the contagion risk between core and peripheral dealers decreases with the introduction of central clearing. Due to the low number of statistically significant coefficients, the results also imply that the risk of contagion from core to peripheral dealers seems to be moderate at best.

4.3. EMPIRICAL ANALYSIS

Table 4.3.3: CDS return volatility spillover analysis (ADL model)

This table shows results for regression (4.5), the CDS return volatility spillover analysis from CDS core dealers to peripheral dealers. We use the 20-day log realized CDS return volatility of peripheral dealers as dependent variables in the different models 1-10. As independent variables, we use the lagged 20-, 60-, and 120-day log realized CDS return volatilities of the three largest CDS dealers: JP Morgan, Citibank, and Bank of America. We also include the corresponding autoregressive terms of the 20-, 60-, and 120-day log realized CDS return volatility (not reported). We split our sample into the pre-clearing period and the post-clearing period and show corresponding results in Panel A and Panel B. In parentheses, we display Newey-West standard errors.

Panel A: Pre-clearing

	<i>Dependent variable:</i>									
	HSBC	WF	SG	BC	DB	LCL	GS	MS	UBS	CS
	(1)	(2)	(3)	(4)	(5)	(6)	(7)	(8)	(9)	(10)
bofa20	0.0362 (0.0507)	-0.0530 (0.1403)	-0.0093 (0.0341)	0.0119 (0.0422)	-0.0116 (0.0127)	-0.0191 (0.0121)	0.0537 (0.0461)	-0.0076 (0.0678)	0.0174 (0.0699)	0.0015 (0.0396)
bofa60	0.2371 (0.1616)	0.0401 (0.1574)	0.0670 (0.0928)	0.2221 (0.1886)	-0.0098 (0.0372)	-0.0300 (0.0515)	0.0768 (0.1353)	0.4030 (0.3648)	0.2456 (0.2333)	0.1114 (0.1264)
bofa120	-0.2194 (0.1562)	0.2587 (0.2844)	-0.0126 (0.1045)	-0.3043 (0.2113)	0.0604 (0.0531)	0.1164 (0.0880)	0.0770 (0.1339)	-0.4995 (0.3591)	-0.2936 (0.2119)	-0.0857 (0.1284)
citi20	0.0743 (0.2654)	0.1884 (0.2241)	0.0879 (0.1382)	0.0785 (0.2227)	0.0665 (0.0500)	0.1150** (0.0453)	-0.0646 (0.2206)	0.0899 (0.4061)	0.0862 (0.3453)	0.0756 (0.1854)
citi60	-0.8682 (0.5822)	-0.2552 (0.4172)	-0.2044 (0.3141)	-0.5701 (0.5119)	-0.0198 (0.1119)	0.0418 (0.0760)	-0.8276 (0.6321)	-1.6376 (1.1523)	-0.7756 (0.7562)	-0.3824 (0.4189)
citi120	-0.1938 (0.3670)	-0.0525 (0.2472)	-0.0846 (0.1484)	-0.1997 (0.2623)	-0.0082 (0.0671)	-0.0655 (0.0658)	-0.1536 (0.3412)	-0.2517 (0.5373)	-0.3251 (0.4790)	-0.1107 (0.2070)
jpm20	0.2354** (0.1085)	-0.0447 (0.0893)	-0.0053 (0.0536)	0.0708 (0.0857)	-0.0144 (0.0190)	-0.0097 (0.0087)	0.4036** (0.1842)	0.5650* (0.2889)	0.1365 (0.1217)	0.0296 (0.0620)
jpm60	-0.3301 (0.3906)	0.0206 (0.0302)	-0.0919 (0.1420)	-0.3390 (0.3730)	0.0052 (0.0153)	-0.0030 (0.0098)	-0.2418 (0.4489)	-0.5420 (0.7055)	-0.2967 (0.4499)	-0.1829 (0.2031)
jpm120	0.9120* (0.4938)	0.0201 (0.0443)	0.2889 (0.1969)	1.0819* (0.6119)	0.0057 (0.0220)	-0.0184 (0.0252)	0.5440 (0.4792)	1.7005 (1.0634)	1.0078* (0.5390)	0.4874* (0.2631)
Observations	3,512	3,512	3,512	3,512	3,512	3,512	3,512	3,512	3,512	3,512
Adjusted R ²	0.9058	0.9169	0.9162	0.9117	0.9289	0.9205	0.9066	0.9045	0.9048	0.9101

Note:

*p<0.1; **p<0.05; ***p<0.01

Panel B: Post-clearing

	<i>Dependent variable:</i>									
	HSBC	WF	SG	BC	DB	LCL	GS	MS	UBS	CS
	(1)	(2)	(3)	(4)	(5)	(6)	(7)	(8)	(9)	(10)
bofa20	0.0123 (0.0208)	0.0531 (0.0469)	0.0231 (0.0536)	0.0430 (0.0536)	0.0153 (0.0308)	0.0076 (0.0404)	0.0241 (0.0234)	0.0258 (0.0351)	0.0324 (0.0329)	0.0484 (0.0510)
bofa60	0.0117 (0.0330)	-0.1366* (0.0807)	-0.0293 (0.0998)	-0.0122 (0.0409)	0.0333 (0.0458)	-0.0319 (0.0714)	-0.0065 (0.0254)	0.0040 (0.0350)	-0.0492 (0.0392)	-0.0141 (0.0353)
bofa120	-0.0286 (0.0461)	0.0598 (0.0641)	-0.0026 (0.1670)	-0.0817 (0.0543)	-0.0862 (0.0658)	0.0515 (0.1295)	-0.0379 (0.0302)	-0.0264 (0.0299)	-0.0267 (0.0594)	-0.0764 (0.0530)
citi20	-0.0087 (0.0316)	0.1065* (0.0631)	-0.0113 (0.0609)	-0.0109 (0.0510)	0.0173 (0.0480)	-0.0005 (0.0555)	-0.0265 (0.0320)	-0.0021 (0.0370)	0.0107 (0.0533)	-0.0220 (0.0400)
citi60	0.0290 (0.0791)	-0.0909 (0.0868)	-0.0207 (0.1250)	-0.0489 (0.0752)	0.0062 (0.0666)	0.0538 (0.1061)	0.0633 (0.0533)	0.0072 (0.0471)	-0.0563 (0.0758)	-0.0331 (0.0550)
citi120	-0.0569 (0.0757)	0.0011 (0.1075)	-0.0150 (0.1445)	0.1070 (0.0920)	0.0102 (0.0818)	-0.0851 (0.1284)	-0.0062 (0.0509)	0.0400 (0.0710)	0.0587 (0.0909)	0.0657 (0.0779)
jpm20	-0.0068 (0.0284)	-0.0695* (0.0373)	-0.0489 (0.0531)	-0.0655** (0.0314)	-0.0312 (0.0277)	-0.0354 (0.0489)	-0.0134 (0.0233)	-0.0413* (0.0246)	-0.0684* (0.0377)	-0.0597* (0.0332)
jpm60	-0.0567 (0.0685)	0.0908 (0.0798)	0.1405 (0.1767)	0.0395 (0.0628)	-0.0443 (0.0673)	0.0849 (0.1497)	-0.0041 (0.0417)	0.0258 (0.0569)	0.1876* (0.1049)	0.1149 (0.0990)
jpm120	0.1434 (0.0912)	-0.0326 (0.0739)	-0.0130 (0.2282)	0.0363 (0.0650)	0.1112 (0.0682)	0.0056 (0.1780)	0.0285 (0.0404)	-0.0036 (0.0511)	-0.0097 (0.0629)	0.0024 (0.0684)
Observations	2,970	2,970	2,970	2,970	2,970	2,970	2,970	2,970	2,970	2,970
Adjusted R ²	0.9351	0.8983	0.9166	0.9230	0.9191	0.9135	0.8970	0.9052	0.9184	0.9020

Note:

*p<0.1; **p<0.05; ***p<0.01

4.3.4 Connectedness of CDS dealers: the Diebold-Yilmaz approach

After analyzing contagion within different parts of the CDS financial network, we now turn to investigate the contagion risk for the CDS financial network as a whole. For this purpose, we run a forecast error variance decomposition according to Diebold and Yilmaz (2009, 2012). This allows us to attribute different parts of the forecast error variance of one CDS dealer time series to the time series of the other CDS dealers. We use the forecast error variance of a vector autoregressive model with a 20-day period forecast. This allows us to compute the variance decomposition matrix that reflects the spillover effects from one variable to other variables and vice versa. Finally, we add up all spillover effects across all entities in both directions separately with and without the diagonal cell values that represent the autoregressive effects. If we divide the sum of the spillover effects to other variables (NET) by the sum of all spillover effects including the autoregressive effects (GROSS), we obtain one measure for the connectedness of all entities within the CDS financial network. This value indicates in percent how much of the variance within the CDS financial system can be attributed to spillover effects: the so-called spillover index. We compute spillover tables and corresponding spillover indices for CDS returns and 20-day CDS return volatilities and for the pre- and post-clearing period separately. The four spillover tables are displayed in Table 4.3.4. We provide the spillover index values below the corresponding tables.

Table 4.3.4 shows that the spillover index value decreases from the pre-clearing period to the post-clearing period by nine percentage points in both specifications. In line with our findings from the previous sections, this result implies that central clearing seems to reduce contagion risk within the CDS dealer network.

Table 4.3.4: Diebold-Yilmaz spillover table (event time)

This table shows spillover tables according to Diebold and Yilmaz (2012) based on our CDS return (CDS return volatility) event time series. The spillover tables are based on a VAR model with a number of lags determined by the Akaike Information Criterion. The variance decomposition follows the framework of Koop et al. (1996) and Pesaran and Shin (1998). The individual cells provide an estimate for the contribution of dealer i's CDS return (CDS return volatility) innovations to the variance of dealer j's 20-day ahead CDS return (CDS return volatility) forecast error. Panel A (Panel B) shows spillover tables based on CDS returns for the pre-clearing period (post-clearing period). Panel C (Panel D) shows spillover tables based on CDS return volatilities for the pre-clearing period (post-clearing period).

Panel A: CDS return spillover (pre-clearing)

	JPM	CITI	BOFA	GS	HSBC	MS	BNP	WF	SG	BC	DB	LCL	UBS	CS	FROM
JPM	0.10	0.04	0.05	0.09	0.09	0.09	0.08	0.08	0.08	0.08	0.06	0.00	0.08	0.08	0.90
CITI	0.08	0.18	0.08	0.07	0.07	0.06	0.07	0.07	0.06	0.06	0.06	0.01	0.06	0.06	0.82
BOFA	0.09	0.07	0.15	0.08	0.08	0.07	0.07	0.07	0.07	0.07	0.06	0.00	0.07	0.07	0.85
GS	0.09	0.03	0.05	0.10	0.09	0.09	0.08	0.08	0.08	0.09	0.07	0.00	0.09	0.09	0.90
HSBC	0.08	0.03	0.04	0.09	0.10	0.09	0.08	0.08	0.08	0.09	0.07	0.00	0.09	0.09	0.90
MS	0.08	0.03	0.04	0.09	0.09	0.09	0.08	0.08	0.09	0.09	0.07	0.00	0.09	0.09	0.91
BNP	0.07	0.03	0.04	0.08	0.08	0.09	0.10	0.05	0.09	0.09	0.09	0.01	0.09	0.09	0.90
WF	0.09	0.04	0.05	0.10	0.10	0.08	0.06	0.12	0.07	0.08	0.05	0.01	0.08	0.07	0.88
SG	0.07	0.03	0.04	0.08	0.08	0.09	0.09	0.05	0.09	0.09	0.09	0.01	0.09	0.09	0.91
BC	0.08	0.03	0.04	0.08	0.09	0.09	0.09	0.06	0.09	0.09	0.08	0.00	0.09	0.09	0.91
DB	0.07	0.03	0.04	0.07	0.07	0.08	0.10	0.04	0.10	0.09	0.10	0.02	0.09	0.09	0.90
LCL	0.01	0.04	0.01	0.01	0.02	0.02	0.08	0.05	0.06	0.04	0.12	0.47	0.03	0.04	0.53
UBS	0.08	0.03	0.04	0.09	0.09	0.09	0.09	0.06	0.09	0.09	0.08	0.00	0.09	0.09	0.91
CS	0.07	0.03	0.04	0.08	0.08	0.09	0.09	0.05	0.09	0.09	0.08	0.01	0.09	0.09	0.91
NET	0.96	0.45	0.57	1.02	1.02	1.03	1.04	0.78	1.05	1.05	0.97	0.09	1.04	1.04	12.12
GROSS	1.06	0.63	0.72	1.11	1.11	1.13	1.14	0.90	1.14	1.14	1.08	0.56	1.14	1.14	14.00

Spillover Index (pre): 0.87

Panel B: CDS return spillover (post-clearing)

	JPM	CITI	BOFA	GS	HSBC	MS	BNP	WF	SG	BC	DB	LCL	UBS	CS	FROM
JPM	0.27	0.14	0.14	0.10	0.03	0.08	0.03	0.05	0.03	0.03	0.03	0.03	0.03	0.02	0.73
CITI	0.11	0.21	0.11	0.10	0.03	0.10	0.04	0.06	0.04	0.05	0.04	0.03	0.04	0.04	0.79
BOFA	0.13	0.13	0.26	0.09	0.05	0.08	0.03	0.06	0.03	0.03	0.03	0.02	0.02	0.03	0.74
GS	0.09	0.11	0.08	0.22	0.03	0.10	0.04	0.06	0.04	0.06	0.05	0.04	0.04	0.05	0.78
HSBC	0.04	0.05	0.06	0.04	0.27	0.04	0.07	0.02	0.07	0.12	0.06	0.07	0.06	0.05	0.73
MS	0.06	0.09	0.06	0.09	0.02	0.19	0.05	0.06	0.05	0.07	0.06	0.05	0.05	0.07	0.81
BNP	0.02	0.03	0.02	0.03	0.05	0.05	0.18	0.02	0.16	0.07	0.09	0.08	0.09	0.10	0.82
WF	0.06	0.09	0.07	0.08	0.02	0.10	0.04	0.30	0.04	0.04	0.04	0.03	0.04	0.05	0.70
SG	0.02	0.03	0.03	0.03	0.04	0.05	0.16	0.03	0.18	0.07	0.09	0.08	0.09	0.10	0.82
BC	0.02	0.05	0.03	0.05	0.08	0.07	0.07	0.03	0.08	0.19	0.10	0.09	0.08	0.08	0.81
DB	0.02	0.04	0.02	0.04	0.04	0.06	0.10	0.03	0.10	0.10	0.20	0.07	0.08	0.09	0.80
LCL	0.02	0.04	0.02	0.04	0.06	0.06	0.10	0.02	0.09	0.10	0.08	0.21	0.07	0.07	0.79
UBS	0.02	0.04	0.02	0.04	0.04	0.06	0.10	0.03	0.10	0.09	0.08	0.07	0.20	0.11	0.80
CS	0.02	0.03	0.02	0.04	0.03	0.06	0.11	0.03	0.11	0.08	0.09	0.06	0.11	0.19	0.81
NET	0.63	0.87	0.68	0.80	0.54	0.91	0.93	0.50	0.93	0.90	0.84	0.73	0.80	0.85	10.93
GROSS	0.89	1.08	0.93	1.01	0.82	1.11	1.11	0.81	1.11	1.09	1.04	0.95	1.00	1.04	14.00

Spillover Index (pre): 0.78

CHAPTER 4. FIREWALL OR SUPERSPREADER? - CDS CENTRAL
CLEARING AND CONTAGION RISK WITHIN THE CDS DEALER
NETWORK

Panel C: CDS return volatility spillover (pre-clearing)

	JPM	CITI	BOFA	GS	HSBC	MS	BNP	WF	SG	BC	DB	LCL	UBS	CS	FROM
JPM	0.11	0.02	0.02	0.11	0.11	0.10	0.08	0.04	0.09	0.10	0.03	0.00	0.10	0.09	0.89
CITI	0.07	0.39	0.11	0.06	0.06	0.05	0.03	0.02	0.04	0.05	0.01	0.00	0.05	0.05	0.61
BOFA	0.08	0.05	0.26	0.08	0.09	0.06	0.05	0.07	0.05	0.06	0.03	0.01	0.06	0.06	0.74
GS	0.11	0.01	0.02	0.11	0.11	0.10	0.08	0.03	0.09	0.10	0.03	0.00	0.11	0.10	0.89
HSBC	0.10	0.01	0.02	0.10	0.11	0.10	0.08	0.04	0.09	0.10	0.04	0.00	0.11	0.10	0.89
MS	0.10	0.01	0.01	0.10	0.11	0.11	0.08	0.03	0.09	0.11	0.04	0.00	0.11	0.10	0.89
BNP	0.07	0.01	0.02	0.07	0.07	0.08	0.12	0.06	0.11	0.09	0.02	0.02	0.09	0.10	0.88
WF	0.05	0.01	0.02	0.04	0.05	0.05	0.12	0.14	0.09	0.06	0.14	0.11	0.05	0.07	0.86
SG	0.08	0.01	0.02	0.08	0.08	0.09	0.10	0.05	0.10	0.10	0.07	0.01	0.10	0.10	0.90
BC	0.09	0.01	0.02	0.10	0.10	0.09	0.13	0.09	0.11	0.07	0.15	0.08	0.06	0.09	0.85
DB	0.05	0.01	0.02	0.04	0.05	0.05	0.12	0.18	0.07	0.03	0.22	0.26	0.01	0.04	0.74
LCL	0.01	0.01	0.01	0.01	0.01	0.01	0.12	0.18	0.07	0.03	0.22	0.26	0.01	0.04	0.74
UBS	0.10	0.01	0.02	0.10	0.10	0.10	0.09	0.03	0.10	0.10	0.04	0.00	0.11	0.10	0.89
CS	0.09	0.01	0.02	0.09	0.09	0.09	0.10	0.04	0.10	0.10	0.06	0.01	0.10	0.10	0.90
NET	0.99	0.18	0.33	0.98	1.03	0.99	1.15	0.71	1.12	1.07	0.84	0.25	1.07	1.11	11.82
GROSS	1.11	0.57	0.59	1.09	1.14	1.09	1.26	0.85	1.23	1.17	0.99	0.52	1.17	1.22	14.00

Spillover Index (pre): 0.84

Panel D: CDS return volatility spillover (post-clearing)

	JPM	CITI	BOFA	GS	HSBC	MS	BNP	WF	SG	BC	DB	LCL	UBS	CS	FROM
JPM	0.36	0.15	0.17	0.04	0.05	0.03	0.01	0.01	0.01	0.06	0.02	0.03	0.01	0.02	0.64
CITI	0.08	0.27	0.16	0.05	0.07	0.06	0.02	0.02	0.02	0.09	0.04	0.02	0.03	0.05	0.73
BOFA	0.07	0.13	0.22	0.05	0.05	0.09	0.02	0.02	0.03	0.12	0.06	0.02	0.03	0.08	0.78
GS	0.03	0.05	0.07	0.25	0.02	0.12	0.03	0.03	0.03	0.10	0.09	0.03	0.06	0.08	0.75
HSBC	0.06	0.09	0.08	0.03	0.41	0.02	0.02	0.01	0.03	0.10	0.04	0.03	0.05	0.03	0.59
MS	0.01	0.05	0.07	0.08	0.01	0.17	0.04	0.05	0.05	0.13	0.13	0.04	0.07	0.10	0.83
BNP	0.01	0.01	0.02	0.03	0.03	0.04	0.20	0.01	0.21	0.06	0.08	0.12	0.08	0.08	0.80
WF	0.01	0.03	0.04	0.05	0.01	0.13	0.03	0.33	0.03	0.09	0.10	0.03	0.06	0.06	0.67
SG	0.01	0.02	0.02	0.03	0.03	0.04	0.18	0.01	0.21	0.07	0.08	0.11	0.09	0.09	0.79
BC	0.02	0.05	0.08	0.06	0.04	0.12	0.04	0.03	0.05	0.20	0.12	0.04	0.07	0.09	0.80
DB	0.01	0.03	0.04	0.06	0.03	0.12	0.06	0.04	0.07	0.14	0.18	0.05	0.08	0.09	0.82
LCL	0.02	0.02	0.02	0.03	0.02	0.05	0.14	0.02	0.15	0.07	0.09	0.25	0.06	0.05	0.75
UBS	0.01	0.03	0.03	0.05	0.03	0.09	0.07	0.03	0.08	0.10	0.09	0.05	0.21	0.14	0.79
CS	0.01	0.03	0.06	0.05	0.02	0.10	0.07	0.03	0.08	0.12	0.11	0.04	0.12	0.17	0.83
NET	0.35	0.69	0.88	0.61	0.41	1.01	0.75	0.30	0.86	1.26	1.07	0.61	0.80	0.95	10.55
GROSS	0.71	0.96	1.10	0.86	0.82	1.18	0.95	0.63	1.07	1.45	1.26	0.86	1.01	1.13	14.00

Spillover Index (pre): 0.75

4.3.5 The effect of contagion risk on CDS premia prior to and after the introduction of central clearing

In this section, we analyze whether contagion risk exhibits an impact on CDS premia and whether this impact changes with the beginning of central clearing. Previous literature shows that direct counterparty risk affects pricing behavior or counterparty choice on the CDS market (Arora et al., 2012; Morkoetter et al., 2012; Loon and Zhong, 2014; Kaya, 2016; Du et al., 2019; Kroon and van Lelyveld, 2018; Molleyres, 2018). We consider contagion risk as indirect counterparty risk which may also have an impact on CDS premia. Even though the direct counterparty may initially be of high creditworthiness, high contagion risk and high default risk dependence within the network of CDS market participants may erode the creditworthiness of this counterparty through its trading relationships with other, less creditworthy counterparties. The creditworthiness of a market participant's counterparties and the resulting default risk correlation within the CDS financial network may not be contained in the pricing of direct counterparty risk. Therefore, we test whether contagion risk exhibits an impact on CDS premia by regressing CDS mid quotes on the average G14 dealer correlation by estimating the following model:

$$\begin{aligned} \text{cds_mid}_{i,t} = & \alpha + \beta_1 * \text{CCP}_{i,t} + \beta_2 * \text{mean_corr_G14}_t \\ & + \beta_3 * \text{CCP}_{i,t} * \text{mean_corr_G14}_t \\ & + \zeta * X_{i,t} + \gamma_t + \delta_i + \epsilon_{i,t} \end{aligned} \quad (4.6)$$

$\text{cds_mid}_{i,t}$ denotes the CDS mid quote for CDS contract i at time t . $\text{CCP}_{i,t}$ is a dummy variable which takes the value of one when a contract becomes eligible for central clearing. mean_corr_G14_t is the average pairwise CDS return correlation across all G14 dealers at time t . Our variable of interest is the interaction between $\text{CCP}_{i,t}$ and mean_corr_G14_t which allows us to examine how the effect of contagion risk on CDS premia changes with the introduction of central clearing. Additionally, we run model (4.6) for the pre-clearing period and post-clearing period separately without interaction term and compare the loading on the coefficient mean_corr_G14_t in both specifications.

$X_{i,t}$ contains control variables for company-specific risk, arbitrage relationships and liquidity spillovers derived from previous studies (Tang and Yan, 2007; Oehmke and Zawadowski, 2017): the reference entity's option implied stock volatility (*stock-vola*), market capitalization (*market_cap*), leverage factor (*leverage*) and CDS-bond

CHAPTER 4. FIREWALL OR SUPERSPREADER? - CDS CENTRAL
CLEARING AND CONTAGION RISK WITHIN THE CDS DEALER
NETWORK

basis (*arbitrage*). Furthermore, we include a dummy variable that becomes 1 if the CDS bond-basis is negative (*neg_basis*), the Amihud illiquidity ratio of the reference entity's stock (*amihud_ratio*), and trading volume on the reference entity's bonds (*bond_trading*) and option contracts (*option_trading*). δ_i and γ_t are sector and quarter fixed effects. We cluster standard errors by sector and quarter. Results for Equation (4.6) are given in Table 4.3.5.

Table 4.3.5: Pre- and post-clearing effect of contagion risk on CDS premia

The table shows results for regression (4.6), the regression of CDS premia on the average 60-day CDS return Pearson correlation of the G14 CDS dealers prior to and after the introduction of central clearing. Model (1) uses an interaction term between *CCP*, a dummy variable which takes the value of 1 if a contract is eligible for central clearing, and *mean_corr_G14*, the daily average pairwise 60-day CDS return Pearson correlation across all possible pairs of the G14 CDS dealers. For the results of model (2) and (3), we split our sample into the pre-clearing period and the post-clearing period and run regression (4.6) on these samples separately. As controls, we use the option implied stock volatility (*vola*), market capitalization (*market_cap*), leverage (*leverage*), stock Amihud illiquidity ratio (*Amihud_ratio*), bond trading volume (*bond_trading*), option trading volume (*option_trading*), the size of the CDS-bond basis, and a dummy for the existence of a negative CDS-bond basis (*neg_basis*). We include industry and quarter fixed effects. We cluster standard errors by industry and quarter. In parentheses, we display standard errors which are computed according to Arellano (1987).

	<i>Dependent variable:</i>		
	log(cds_mid)		
	full	pre	post
	(1)	(2)	(3)
CCP_weekly	0.021 (0.174)		
mean_corr_G14	-0.037 (0.319)	-0.092 (0.266)	-0.058 (0.377)
stock_vola	0.020*** (0.004)	0.018*** (0.004)	0.020*** (0.005)
market_cap	-0.004*** (0.001)	-0.004*** (0.001)	-0.004*** (0.001)
leverage	0.001*** (0.001)	0.001*** (0.0005)	0.001* (0.001)
neg_basis	1.097*** (0.415)	0.013 (0.072)	1.171*** (0.379)
arbitrage	0.00000 (0.00001)	-0.00003 (0.00004)	0.00000 (0.00001)
amihud_ratio	0.027 (0.020)	0.060* (0.036)	0.053*** (0.008)
bond_trading	0.002*** (0.001)	0.003*** (0.001)	0.002 (0.001)
option_trading	0.0001 (0.0001)	0.0001 (0.0001)	0.0001 (0.0001)
CCP_weekly:mean_corr_G14	-0.160 (0.377)		
Industry FE	YES	YES	YES
Quarter FE	YES	YES	YES
F Statistics	909.5318	366.5283	811.2362
Observations	22,325	10,882	11,443
Adjusted R ²	0.675	0.602	0.757

Note:

*p<0.1; **p<0.05; ***p<0.01

Table 4.3.5 displays results for the effect of contagion risk on CDS premia. We see no statistically significant coefficient of $mean_corr_G14_t$ in all specifications, and the interaction term in specification (1) is also not statistically significant. This leads to the conclusion that contagion risk on the CDS market does not affect the pricing behavior of CDS market participants. This implies that central clearing may not be considered as a necessary addition to the CDS market by CDS market participants from the perspective of contagion risk although CCPs seem to reduce contagion risk among CDS dealers as the previous sections show.

4.4 Robustness tests

In this section, we present several robustness checks that shall rule out any major misspecifications in our original model. In a first robustness check, we perform the same time series methods on our dataset and the corresponding subsamples in calendar time instead of event time. Our original models are not able to determine the direction of causality between central clearing and contagion risk. A reduction in contagion risk could also have foregone the introduction of central clearing. CDS positions have been in decline already for over a decade now and this reduction in mutual exposures loosens the link between the CDS market participants and makes their individual default risk more independent of the default risk of other market participants. Central clearing may be a regulatory response to this decline in CDS trading activity in order to revive market liquidity and to remain the economic function of the CDS market. Consequently, the introduction of central clearing may simply coincide or even result from this contagion risk decline. This is why we analyze whether contagion risk declines principally during our observation period so that our findings may be just a result of this general trend in contagion risk reduction within the CDS financial network. If we do not find a similar decrease of contagion risk among the G14 dealers over time as our findings suggest, we are confident that our data manipulation and the time series methodologies used in the previous section are suitable methods to identify the specific effect of CDS central clearing on contagion risk among CDS market participants.

In a second robustness check, we test whether our findings may be the result of other sources of contagion risk. In order to capture contagion risk that arises specifically from the CDS market relationships between the G14 dealers, we weight the original time series by the individual CDS market share of each CDS dealers according to the OCC statistics (as described in section 4.2.2). In our second robustness

check, we perform the same tests as in the previous chapter using the unweighted time series. If the results are virtually identical to those of the previous section, our results do not seem to capture the CDS market-specific contagion risk.

Finally, we back up our results from the CDS data by performing the same tests using stock market data. CDS data may be affected by the introduction of central clearing themselves and therefore distort the results. Although stock prices do not indicate the default risk of a company as pure as CDS spreads, theoretical and empirical studies show its relation to company-specific probability of default (Merton, 1973, 1974; Clare and Priestley, 2002; Byström, 2004; Vassalou and Xing, 2004; Carr and Linetsky, 2006; Carr and Wu, 2009; Carr and Medan, 2010). Therefore, we hypothesize that the results should be similar when performing the same tests with stock market data and may provide evidence that our baseline models with CDS data are not subject to a major bias due to the effect of central clearing on the CDS spread time series.

4.4.1 Analysis of contagion risk within the CDS dealer network in calendar time

In this section, we analyze how the contagion risk among the G14 CDS dealer network develops along calendar time. If contagion risk changes over time to a similar extent as our results attribute to the introduction of central clearing, our initial results may be misleading. For this purpose, we divide our sample into two parts which roughly correspond to 50% of the sample size and observation period. The date at which we split the sample is July 1st 2013. Similar to splitting our sample into pre-clearing and post-clearing period in the previous chapter, we now split our sample into two parts before and after July 1st 2013.

If our initial results are driven by a global time trend in terms of contagion risk that may have even caused the introduction of central clearing, we should see very similar results when performing the same tests along calendar time. In order to be able to compare our results, we perform the same tests as in the previous chapter by examining cointegration relationships, Granger causality, volatility spillover effects, and CDS dealer connectedness for the same subsets of G14 dealers as in the previous section.

First, we examine whether the extent to which CDS spread time series of the G14 CDS dealers are cointegrated changes over time. Table 4.4.1 displays results

4.4. ROBUSTNESS TESTS

on the cointegration of the CDS spread time series of the G5 (peripheral) dealers for the period before and after July 1st 2013 in its Panels A (B) and C (D).

Panel A of Table 4.4.1 shows that we can reject the null hypothesis of no cointegration between the G5 dealers for the period before July 1st 2013 at only the 10% significance level. Panel B of Table 4.4.1 suggests that we cannot reject the null hypothesis of no cointegration at any conventional significance levels. For the subset of peripheral dealers, we cannot reject the null hypothesis of no cointegration between five or more peripheral dealers at the 5% significance level for the period before July 1st 2013. For the period from July 1st 2013 onwards, we cannot reject the null hypothesis of no cointegration for only two peripheral dealers at the 10% significance level. The results of the cointegration tests indicate that contagion risk among the G5 CDS dealers has been persistently low during our observation period without any major changes.

Table 4.4.1: Cointegration test (calendar time)

This table shows cointegration tests on CDS spread time series for CDS core and periphery dealers separately prior to and after July 1st 2013. We test cointegration by the maximum eigenvalue test statistic and allow for a constant term in the cointegration relationship. The number of lags is determined by the Akaike Information Criterion. Panel A (Panel B) shows results on the cointegration of CDS spread time series of the five largest CDS dealers (G5) prior to (after) July 1st 2013. Panel C (Panel D) shows results on the cointegration of CDS spread time series of the remaining nine CDS dealers (periphery) prior to (after) July 1st 2013. Green- (red-)colored values are (not) exceeded by the test statistic and (do not) lead to a rejection of the null hypothesis of no cointegration on the corresponding level of statistical significance.

Panel A: G5 - Pre July 2013					Panel B: G5 - Post July 2013				
	test stat	10pct	5pct	1pct		test stat	10pct	5pct	1pct
r _j =4	4.83	7.52	9.24	12.97	r _j =4	5.20	7.52	9.24	12.97
r _j =3	6.17	13.75	15.67	20.20	r _j =3	8.79	13.75	15.67	20.20
r _j =2	16.28	19.77	22	26.81	r _j =2	13.94	19.77	22.00	26.81
r _j =1	23.17	25.56	28.14	33.24	r _j =1	16.98	25.56	28.14	33.24
r=0	32.88	31.66	34.4	39.79	r=0	27.68	31.66	34.40	39.79

Panel C: Periphery - Pre July 2013					Panel D: Periphery - Post July 2013				
	test stat	10pct	5pct	1pct		test stat	10pct	5pct	1pct
r _j =8	3.73	7.52	9.24	12.97	r _j =8	3.00	7.52	9.24	12.97
r _j =7	9.07	13.75	15.67	20.2	r _j =7	8.66	13.75	15.67	20.20
r _j =6	10.89	19.77	22	26.81	r _j =6	11.64	19.77	22	26.81
r _j =5	16.60	25.56	28.14	33.24	r _j =5	13.57	25.56	28.14	33.24
r _j =4	27.06	31.66	34.4	39.79	r _j =4	18.40	31.66	34.4	39.79
r _j =3	44.17	37.45	40.3	46.82	r _j =3	24.00	37.45	40.3	46.82
r _j =2	61.75	43.25	46.45	51.91	r _j =2	30.39	43.25	46.45	51.91
r _j =1	71.64	48.91	52	57.95	r _j =1	50.12	48.91	52	57.95
r=0	108.18	54.35	57.42	63.71	r=0	54.37	54.35	57.42	63.71

Contagion risk among peripheral CDS dealers may have slightly decreased during our observation period as Panel C and Panel D show. Considering the negligible change in contagion risk over time, it is unlikely that the results of the cointegration test in the previous chapter can be explained to a significant extent by a global change in the cointegration of the CDS spread time series of the G14 dealers during our observation period.

Second, we analyze Granger causality between the 20-day CDS return volatility time series of G5 CDS dealers and peripheral CDS dealers along calendar time. Panels A-F of Table 4.4.2 display F statistics and p values of bi- and multivariate Granger causality tests for the period before and after July 1st 2013 similar to Table 4.3.2.

Out of twenty Granger-causal relationships among CDS core dealers, Panel A of Table 4.4.2 shows nine Granger-causal relationships that are statistically significant at least at 5% level in the period before July 1st 2013. For the post-clearing period, Panel B of Table 4.4.2 reports seven Granger-causal relationships that are statistically significant at least at the 5% level.

Looking at the results on the multivariate Granger-causal relationships for the G5 dealers in Panel C and Panel D, we find that three of the G5 dealers CDS return volatility time series seem to be Granger-caused by all respective remaining G5 dealers in the pre-clearing period. For the post-clearing period, two G5 dealers' CDS return time series are Granger-caused by the respective remaining G5 dealers.

For the peripheral dealers, we cannot reject the null hypothesis of no Granger causality for all dealers in the pre-clearing period but can reject the null hypothesis for all dealers in the post-clearing period at a significance level of 1%.

These results indicate that contagion risk among the G5 CDS dealers has slightly decreased over time. However, the effect seems to be very small compared to our baseline results, especially since all coefficients are highly significant for the pre-clearing period whereas already around 50% of the coefficients are not statistically significant at the 5% level for the period before July 1st 2013. Contagion risk among peripheral dealers seems to have strongly increased over time. These results seem to imply that the two different time series capture very different effects on contagion risk that do not seem to overlap to a larger extent. Instead, these results make us confident that centering our time series around one central clearing eligibility event creates time series that are not affected by global contagion risk time trends.

Third, we run the ADL model along the calendar time dimension in order to examine whether volatility spillover from the three largest CDS dealers to the re-

4.4. ROBUSTNESS TESTS

maining dealers of the network changes during our observation period. Panel A of Table 4.4.3 displays results of the ADL model for the period before July 1st 2013 and Panel B of Table 4.4.3 for the period after July 1st 2013.

Table 4.4.2: Granger causality test (calendar time)

This table shows bi- and multivariate Granger causality tests on CDS return volatility time series for CDS core and periphery dealers separately prior to and after July 1st 2013. Panel A (Panel B) shows results on bivariate Granger causality tests according to regression (4.3) on pairs of log realized 20-day CDS return volatilities among the five largest CDS dealers prior to (after) June 30th 2013. Panels C/E (Panel D/F) show results on multivariate Granger causality tests among G5/peripheral dealers for the period before (after) July 1st 2013. The number of lags included is selected according to the Akaike Information Criterion under the assumption of a constant and a time trend in the VAR model.

Panel A: G5 - Pre July 2013 (bivar.)

Variables	F statistic	p-value
HSBC - BOFA	0.78	0.51
BOFA - HSBC	0.05	0.82
HSBC - CINC	1.54	0.20
CINC - HSBC	2.50	0.01
HSBC - JPM	2.41	0.07
JPM - HSBC	2.57	0.01
HSBC - GS	20.32	0.00
GS - HSBC	1.52	0.22
BOFA - CINC	5.52	0.02
CINC - BOFA	1.74	0.08
BOFA - JPM	0.01	0.92
JPM - BOFA	2.62	0.01
BOFA - GS	0.57	0.45
GS - BOFA	0.05	0.82
CINC - JPM	1.98	0.05
JPM - CINC	2.76	0.01
CINC - GS	0.83	0.58
GS - CINC	5.26	0.02
JPM - GS	5.72	0.00
GS - JPM	0.40	0.53

Panel B: G5 - Post July 2013 (bivar.)

Variables	F statistic	p-value
HSBC - BOFA	0.78	0.64
BOFA - HSBC	1.19	0.30
HSBC - CINC	0.84	0.59
CINC - HSBC	2.33	0.01
HSBC - JPM	0.63	0.79
JPM - HSBC	1.67	0.13
HSBC - GS	1.01	0.44
GS - HSBC	3.21	0.00
BOFA - CINC	4.99	0.00
CINC - BOFA	4.61	0.00
BOFA - JPM	1.37	0.20
JPM - BOFA	0.68	0.67
BOFA - GS	1.36	0.21
GS - BOFA	4.44	0.00
CINC - JPM	0.90	0.53
JPM - CINC	2.36	0.03
CINC - GS	0.84	0.59
GS - CINC	3.18	0.00
JPM - GS	1.35	0.23
GS - JPM	1.27	0.25

Panel C: G5 - Pre July 2013 (multivar.)

Variables	F statistic	p-value
HSBC	6.20	0.00
BOFA	0.72	0.99
CINC	1.50	0.00
JPM	1.68	0.00
GS	0.86	0.84

Panel D: G5 - Post July 2013 (multivar.)

Variables	F statistic	p-value
HSBC	0.62	1.00
BOFA	1.52	0.00
CINC	1.71	0.00
JPM	0.85	0.84
GS	1.02	0.44

Panel E: Periphery - Pre July 2013 (multivar.) Panel F: Periphery - Post July 2013 (multivar.)

Variables	F statistic	p-value
BNP	0.86	0.93
WF	0.70	1.00
SC	0.90	0.86
BC	0.84	0.96
DB	0.92	0.81
LCL	0.88	0.92
UBS	0.86	0.94
MS	0.88	0.91
CS	0.87	0.92

Variables	F statistic	p-value
BNP	6.44	0.00
WF	18.18	0.00
SC	7.13	0.00
BC	5.64	0.00
DB	6.49	0.00
LCL	12.52	0.00
UBS	10.71	0.00
MS	13.67	0.00
CS	13.53	0.00

CHAPTER 4. FIREWALL OR SUPERSPREADER? - CDS CENTRAL
CLEARING AND CONTAGION RISK WITHIN THE CDS DEALER
NETWORK

Table 4.4.3: CDS return volatility spillover analysis (calendar time)

This table shows results for regression (4.5), the CDS return volatility spillover analysis from CDS core dealers to peripheral dealers. We use the 20-day log realized CDS return volatility of peripheral dealers as dependent variables in the different models 1-10. As independent variables, we use the lagged 20-, 60-, and 120-day log realized CDS return volatilities of the three largest CDS dealers: JP Morgan, Citibank, and Bank of America. We also include the corresponding autoregressive terms of the 20-, 60-, and 120-day log realized CDS return volatility (not reported). In this specification, we split our sample into a period before and after July 1st 2013 and show corresponding results in Panel A and Panel B. In parentheses, we display Newey-West standard errors.

Panel A: Pre July 2013

	<i>Dependent variable:</i>									
	HSBC	WF	SG	BC	DB	LCL	GS	MS	UBS	CS
	(1)	(2)	(3)	(4)	(5)	(6)	(7)	(8)	(9)	(10)
bofa20	-0.0036 (0.0041)	-0.0412 (0.0876)	-0.0216 (0.0521)	-0.0285 (0.0473)	-0.0184 (0.0488)	-0.0215 (0.0525)	-0.0291** (0.0139)	-0.0457 (0.0557)	-0.0216 (0.0527)	-0.0308 (0.0500)
bofa60	-0.0056 (0.0183)	0.5604 (0.6295)	0.2994 (0.3071)	0.3271 (0.3082)	0.2673 (0.2867)	0.3155 (0.3143)	0.0524 (0.0393)	0.3537 (0.3234)	0.3204 (0.3134)	0.3129 (0.3118)
bofa120	0.0220 (0.0183)	-0.3385 (0.4969)	-0.0737 (0.1667)	-0.1221 (0.1758)	-0.0695 (0.1592)	-0.1060 (0.1704)	0.0558 (0.0478)	-0.1052 (0.1763)	-0.1023 (0.1741)	-0.0786 (0.1730)
citi20	0.0183 (0.0117)	0.1205 (0.1875)	0.0939 (0.1294)	0.0908 (0.1097)	0.0817 (0.1253)	0.0855 (0.1111)	0.1524*** (0.0326)	0.1895* (0.1082)	0.0928 (0.1106)	0.1067 (0.1076)
citi60	-0.0448 (0.0305)	-0.8132 (0.8293)	-0.3953 (0.4777)	-0.4034 (0.4625)	-0.3608 (0.4635)	-0.4168 (0.4752)	-0.2199*** (0.0843)	-0.4694 (0.4330)	-0.4029 (0.4463)	-0.4035 (0.4509)
citi120	0.0394* (0.0224)	0.8865 (1.0179)	0.4127 (0.5145)	0.4589 (0.5059)	0.4051 (0.5153)	0.4651 (0.5195)	0.0961** (0.0476)	0.4509 (0.4806)	0.4344 (0.4871)	0.4122 (0.4921)
jpm20	0.0111 (0.0234)	0.1157 (0.1740)	0.1197 (0.1130)	0.0970 (0.0960)	0.1575 (0.1233)	0.0667 (0.0935)	-0.0782* (0.0416)	0.0159 (0.0922)	0.0437 (0.0873)	0.0849 (0.1006)
jpm60	0.0444 (0.0284)	-0.8791 (0.9124)	-0.6742 (0.5428)	-0.6379 (0.5112)	-0.6510 (0.5133)	-0.6333 (0.5223)	0.1389 (0.0901)	-0.6524 (0.5746)	-0.6139 (0.5380)	-0.6661 (0.5290)
jpm120	-0.0858*** (0.0316)	0.7863 (1.2706)	0.6724 (0.6331)	0.6356 (0.6049)	0.6199 (0.5976)	0.6452 (0.5923)	-0.1639* (0.0923)	0.6532 (0.6166)	0.6064 (0.6085)	0.6431 (0.6102)
Observations	1,025	1,025	1,025	1,025	1,025	1,025	1,025	1,025	1,025	1,025
Adjusted R ²	0.9545	0.8969	0.8994	0.8995	0.8998	0.8990	0.9417	0.8990	0.8999	0.9008

Note:

*p<0.1; **p<0.05; ***p<0.01

Panel B: Post July 2013

	<i>Dependent variable:</i>									
	HSBC	WF	SG	BC	DB	LCL	GS	MS	UBS	CS
	(1)	(2)	(3)	(4)	(5)	(6)	(7)	(8)	(9)	(10)
bofa20	0.0388 (0.0694)	-0.0095 (0.0517)	0.0692 (0.0704)	0.0230 (0.1031)	0.0360 (0.0636)	-0.0061 (0.0975)	0.0599 (0.0388)	-0.0209 (0.0669)	0.1050* (0.0591)	0.0463 (0.0792)
bofa60	-0.0086 (0.1094)	-0.1820 (0.1202)	-0.1277 (0.1524)	-0.1065 (0.1843)	-0.1153 (0.1503)	-0.0274 (0.1781)	-0.0650 (0.0870)	-0.1612 (0.1509)	-0.2588** (0.1223)	-0.2238 (0.1438)
bofa120	0.1086 (0.1895)	0.2141 (0.1924)	0.2305 (0.2904)	0.1802 (0.3815)	0.3238 (0.3082)	0.0494 (0.2786)	0.0959 (0.1326)	0.3043 (0.3117)	0.2855 (0.2224)	0.2978 (0.2650)
citi20	-0.0147 (0.0558)	-0.0255 (0.0363)	-0.0140 (0.0753)	-0.0440 (0.0797)	-0.0120 (0.0594)	0.0291 (0.0743)	0.0171 (0.0258)	0.0084 (0.0467)	-0.0926* (0.0547)	-0.0487 (0.0546)
citi60	-0.0644 (0.0929)	0.1383 (0.1102)	-0.0264 (0.1438)	0.0054 (0.1762)	-0.0240 (0.1289)	-0.1186 (0.1683)	-0.0298 (0.0693)	0.0942 (0.1324)	0.1883 (0.1213)	0.1288 (0.1281)
citi120	-0.1126 (0.1791)	-0.1950 (0.2169)	-0.2344 (0.2794)	-0.0992 (0.3858)	-0.2894 (0.2931)	-0.0201 (0.3263)	-0.0150 (0.1079)	-0.2452 (0.3108)	-0.3137 (0.2483)	-0.2858 (0.2832)
jpm20	0.0018 (0.0478)	0.2898* (0.1732)	0.1377 (0.1166)	0.2065 (0.1268)	0.2165* (0.1141)	0.2232* (0.1233)	-0.0450 (0.0382)	0.2832 (0.1800)	0.2200* (0.1181)	0.2540* (0.1422)
jpm60	0.0001 (0.0749)	-0.1882 (0.1301)	0.0419 (0.1370)	-0.0672 (0.1256)	-0.0170 (0.0989)	0.0501 (0.1226)	0.0200 (0.0618)	-0.1842 (0.1426)	-0.1526 (0.1240)	-0.1074 (0.1115)
jpm120	0.1094 (0.1044)	0.1794 (0.2019)	0.0681 (0.1792)	-0.0334 (0.1739)	-0.0023 (0.1476)	-0.0933 (0.1564)	-0.0008 (0.0626)	0.1040 (0.1804)	0.1486 (0.1490)	0.1143 (0.1470)
Observations	1,141	1,141	1,141	1,141	1,141	1,141	1,141	1,141	1,141	1,141
Adjusted R ²	0.9451	0.9266	0.9336	0.9515	0.9327	0.9396	0.9428	0.9356	0.9240	0.9301

Note:

*p<0.1; **p<0.05; ***p<0.01

4.4. ROBUSTNESS TESTS

In this specification, we see rather similar results to those in our baseline specification. We observe four statistically significant coefficients in the pre-clearing period, two of them for the short-term risk of core dealers. In the post-clearing period, we observe only one statistically significant mid-term risk coefficient. If we consider also coefficients that are statistically significant at the 10% level, the number stays constant from the pre-clearing period to the post-clearing period (8). Although the results do not allow us to completely rule out that our baseline findings are caused by declining contagion risk between core and peripheral dealers over time, they do not provide evidence for a strong declining contagion risk time trend.

Last, we compute spillover tables according to Diebold and Yilmaz (2009) and Diebold and Yilmaz (2012) along calendar time again using CDS return and CDS return volatility time series. Also in these specifications, we see an increase in the connectedness within the CDS dealer network during our observation period. This indicates that our results in the previous chapter are not driven by a general trend in decreasing CDS dealer connectedness during our observation period.

In conclusion, we do not see any effects in the decrease of contagion risk within the CDS dealer network along calendar time that are even close to being comparable with our baseline results from the previous section. Instead, we rather see an increase of contagion risk in our measures along calendar time or no significant change at all. This makes us confident that our initial results are not distorted by a global contagion risk time trend or the results of reverse causality. In order for both cases to be possible, we should observe a decrease in the contagion risk measures along calendar time that is similar to the decrease in the contagion risk measures that we attribute to the introduction of central clearing in the previous section. As this is not the case, our methodology seems to allow us to capture the contagion risk that arises specifically from the CDS market.

CHAPTER 4. FIREWALL OR SUPERSPREADER? - CDS CENTRAL
CLEARING AND CONTAGION RISK WITHIN THE CDS DEALER
NETWORK

Table 4.4.4: Diebold-Yilmaz spillover table (calendar time)

This table shows spillover tables according to Diebold and Yilmaz (2012) based on CDS return (CDS return volatility) calendar time series. The spillover tables are based upon a VAR model with a number of lags determined by the Akaike Information Criterion. The variance decomposition follows the framework of Koop et al. (1996) and Pesaran and Shin (1998). The individual cells provide an estimate for the contribution of dealer i 's CDS return (CDS return volatility) innovations to the variance of dealer j 's 20-day ahead CDS return (CDS return volatility) forecast error. Panel A (Panel B) shows spillover tables based on CDS returns for the period before (after) June 30th 2013. Panel C (Panel D) shows spillover tables based on CDS return volatilities for the period prior to (after) June 30th 2013.

Panel A: CDS return spillover before July 2013

	JPM	CITI	BOFA	GS	HSBC	MS	BNP	WF	SG	BC	DB	LCL	UBS	CS	FROM
JPM	0.26	0.14	0.09	0.14	0.05	0.03	0.04	0.03	0.04	0.03	0.04	0.03	0.05	0.03	0.74
CITI	0.14	0.26	0.10	0.13	0.06	0.03	0.04	0.03	0.03	0.03	0.04	0.03	0.05	0.02	0.74
BOFA	0.13	0.15	0.35	0.10	0.05	0.02	0.03	0.03	0.02	0.02	0.02	0.02	0.04	0.01	0.65
GS	0.13	0.12	0.06	0.24	0.05	0.04	0.05	0.02	0.04	0.04	0.05	0.04	0.08	0.04	0.76
HSBC	0.06	0.06	0.01	0.02	0.27	0.05	0.08	0.02	0.07	0.07	0.07	0.07	0.03	0.05	0.73
MS	0.02	0.01	0.01	0.02	0.03	0.14	0.11	0.03	0.11	0.11	0.11	0.11	0.09	0.12	0.86
BNP	0.02	0.02	0.01	0.03	0.04	0.10	0.13	0.02	0.12	0.11	0.12	0.11	0.08	0.10	0.87
WF	0.04	0.04	0.03	0.03	0.03	0.07	0.05	0.39	0.05	0.06	0.05	0.06	0.05	0.07	0.61
SG	0.02	0.02	0.01	0.03	0.04	0.10	0.12	0.02	0.13	0.11	0.12	0.11	0.08	0.10	0.87
BC	0.02	0.02	0.01	0.03	0.04	0.11	0.11	0.02	0.11	0.14	0.11	0.11	0.08	0.10	0.86
DB	0.02	0.02	0.01	0.03	0.04	0.10	0.12	0.02	0.12	0.11	0.13	0.11	0.08	0.10	0.87
LCL	0.04	0.04	0.02	0.01	0.03	0.03	0.11	0.02	0.11	0.11	0.11	0.14	0.08	0.11	0.86
UBS	0.04	0.04	0.02	0.06	0.02	0.10	0.09	0.02	0.09	0.10	0.09	0.09	0.16	0.09	0.84
CS	0.02	0.01	0.01	0.02	0.03	0.12	0.11	0.02	0.11	0.11	0.11	0.11	0.08	0.14	0.86
NET	0.67	0.67	0.41	0.70	0.49	0.97	1.06	0.31	1.02	1.00	1.03	0.99	0.87	0.94	11.13
GROSS	0.93	0.93	0.76	0.94	0.77	1.11	1.19	0.69	1.15	1.13	1.16	1.13	1.03	1.08	14.00

Spillover Index (pre): 0.79

Panel B: CDS return spillover after July 2013

	JPM	CITI	BOFA	GS	HSBC	MS	BNP	WF	SG	BC	DB	LCL	UBS	CS	FROM
JPM	0.24	0.12	0.14	0.11	0.04	0.03	0.04	0.07	0.03	0.02	0.03	0.02	0.08	0.02	0.76
CITI	0.10	0.18	0.11	0.10	0.04	0.04	0.05	0.09	0.04	0.04	0.04	0.04	0.10	0.04	0.82
BOFA	0.13	0.13	0.21	0.10	0.05	0.03	0.04	0.07	0.04	0.03	0.04	0.03	0.08	0.03	0.79
GS	0.09	0.10	0.09	0.19	0.04	0.04	0.05	0.08	0.05	0.04	0.05	0.04	0.10	0.04	0.81
HSBC	0.04	0.05	0.05	0.05	0.20	0.08	0.08	0.03	0.08	0.10	0.08	0.07	0.04	0.05	0.80
MS	0.02	0.04	0.03	0.04	0.06	0.17	0.09	0.05	0.09	0.10	0.09	0.08	0.06	0.09	0.83
BNP	0.02	0.04	0.03	0.04	0.06	0.17	0.15	0.04	0.13	0.08	0.11	0.09	0.06	0.08	0.85
WF	0.05	0.08	0.06	0.06	0.02	0.05	0.06	0.18	0.06	0.05	0.06	0.05	0.12	0.06	0.82
SG	0.02	0.03	0.03	0.04	0.06	0.08	0.13	0.04	0.15	0.08	0.11	0.09	0.06	0.08	0.85
BC	0.02	0.04	0.02	0.04	0.08	0.09	0.09	0.05	0.09	0.16	0.09	0.09	0.06	0.08	0.84
DB	0.02	0.04	0.03	0.04	0.06	0.08	0.12	0.04	0.12	0.08	0.15	0.09	0.06	0.08	0.85
LCL	0.02	0.03	0.02	0.03	0.06	0.09	0.10	0.05	0.10	0.09	0.10	0.17	0.06	0.09	0.83
UBS	0.05	0.09	0.06	0.08	0.03	0.06	0.06	0.11	0.06	0.06	0.06	0.06	0.16	0.07	0.84
CS	0.02	0.04	0.03	0.03	0.04	0.09	0.09	0.06	0.09	0.09	0.09	0.09	0.07	0.16	0.84
NET	0.60	0.81	0.70	0.78	0.64	0.84	1.00	0.78	0.98	0.89	0.94	0.82	0.94	0.80	11.51
GROSS	0.84	0.99	0.91	0.97	0.85	1.00	1.14	0.97	1.13	1.04	1.09	0.99	1.10	0.96	14.00

Spillover Index (post): 0.82

4.4. ROBUSTNESS TESTS

Panel C: CDS return volatility spillover before July 2013

	JPM	CITI	BOFA	GS	HSBC	MS	BNP	WF	SG	BC	DB	LCL	UBS	CS	FROM
JPM	0.52	0.20	0.14	0.11	0.02	0.00	0.00	0.00	0.00	0.00	0.00	0.00	0.00	0.00	0.48
CITI	0.19	0.64	0.10	0.06	0.01	0.00	0.00	0.00	0.00	0.00	0.00	0.00	0.00	0.00	0.36
BOFA	0.08	0.17	0.64	0.06	0.03	0.00	0.00	0.00	0.00	0.00	0.00	0.00	0.00	0.00	0.36
GS	0.03	0.09	0.09	0.68	0.00	0.01	0.01	0.01	0.01	0.01	0.01	0.01	0.01	0.01	0.32
HSBC	0.12	0.08	0.06	0.19	0.52	0.00	0.00	0.01	0.00	0.00	0.00	0.00	0.00	0.00	0.48
MS	0.00	0.00	0.00	0.00	0.00	0.12	0.12	0.07	0.12	0.12	0.11	0.12	0.12	0.12	0.88
BNP	0.00	0.00	0.00	0.00	0.00	0.12	0.12	0.07	0.12	0.12	0.10	0.10	0.12	0.12	0.88
WF	0.00	0.00	0.00	0.00	0.00	0.11	0.10	0.16	0.10	0.10	0.10	0.10	0.10	0.11	0.84
SG	0.00	0.00	0.00	0.00	0.00	0.12	0.12	0.07	0.12	0.12	0.12	0.12	0.12	0.12	0.88
BC	0.00	0.00	0.00	0.00	0.00	0.12	0.12	0.07	0.12	0.12	0.11	0.12	0.12	0.12	0.88
DB	0.00	0.00	0.00	0.00	0.00	0.11	0.12	0.07	0.12	0.12	0.12	0.12	0.11	0.12	0.88
LCL	0.00	0.00	0.00	0.00	0.00	0.12	0.12	0.07	0.12	0.12	0.11	0.12	0.12	0.12	0.88
UBS	0.00	0.00	0.00	0.00	0.00	0.12	0.12	0.07	0.12	0.12	0.11	0.12	0.12	0.12	0.88
CS	0.00	0.00	0.00	0.00	0.00	0.12	0.12	0.07	0.12	0.12	0.11	0.12	0.12	0.12	0.88
NET	0.43	0.54	0.40	0.46	0.08	0.93	0.93	0.58	0.93	0.92	0.92	0.93	0.93	0.93	9.91
GROSS	0.95	1.18	1.04	1.14	0.60	1.05	1.05	0.73	1.04	1.05	1.04	1.04	1.05	1.05	14.00

Spillover Index (pre): 0.71

Panel D: CDS return volatility spillover after July 2013

	JPM	CITI	BOFA	GS	HSBC	MS	BNP	WF	SG	BC	DB	LCL	UBS	CS	FROM
JPM	0.21	0.16	0.13	0.08	0.09	0.01	0.05	0.03	0.04	0.06	0.05	0.01	0.06	0.02	0.79
CITI	0.12	0.20	0.14	0.07	0.08	0.02	0.05	0.04	0.05	0.06	0.05	0.02	0.07	0.04	0.80
BOFA	0.12	0.17	0.18	0.07	0.07	0.02	0.05	0.04	0.04	0.07	0.04	0.02	0.07	0.04	0.82
GS	0.08	0.11	0.10	0.20	0.08	0.04	0.06	0.04	0.05	0.07	0.05	0.03	0.06	0.04	0.80
HSBC	0.09	0.09	0.08	0.05	0.21	0.05	0.06	0.02	0.05	0.13	0.06	0.03	0.05	0.03	0.79
MS	0.07	0.06	0.05	0.04	0.10	0.10	0.07	0.06	0.06	0.12	0.06	0.05	0.08	0.06	0.90
BNP	0.07	0.07	0.06	0.05	0.07	0.04	0.11	0.05	0.10	0.08	0.10	0.05	0.08	0.06	0.89
WF	0.10	0.08	0.06	0.06	0.06	0.04	0.07	0.09	0.06	0.09	0.07	0.05	0.12	0.06	0.91
SG	0.07	0.07	0.06	0.05	0.07	0.04	0.11	0.05	0.11	0.08	0.09	0.05	0.08	0.06	0.89
BC	0.08	0.07	0.06	0.06	0.11	0.05	0.07	0.05	0.06	0.15	0.07	0.04	0.08	0.06	0.85
DB	0.08	0.07	0.06	0.05	0.07	0.04	0.10	0.05	0.09	0.09	0.11	0.05	0.08	0.05	0.89
LCL	0.09	0.08	0.06	0.05	0.07	0.04	0.08	0.06	0.08	0.09	0.08	0.09	0.09	0.06	0.91
UBS	0.10	0.09	0.06	0.06	0.06	0.03	0.07	0.08	0.06	0.09	0.07	0.04	0.12	0.06	0.88
CS	0.08	0.07	0.06	0.06	0.06	0.04	0.08	0.07	0.07	0.10	0.08	0.06	0.11	0.08	0.92
NET	1.16	1.17	0.96	0.74	1.00	0.46	0.91	0.64	0.82	1.13	0.87	0.51	1.04	0.64	12.04
GROSS	1.37	1.37	1.14	0.94	1.21	0.56	1.03	0.73	0.93	1.28	0.98	0.60	1.16	0.72	14.00

Spillover Index (post): 0.86

4.4.2 Unweighted CDS time series

In this section, we perform the test on cointegration relationships, Granger causality, volatility spillover models and CDS dealer connectedness as in the previous chapter but using unweighted CDS time series. This may indicate whether we are able to capture the CDS market-specific contagion risk component in our baseline specifications by weighting our original time series with the individual CDS market share of the corresponding CDS dealer. More specifically, any substantially different findings in terms of the economic size or direction of the effect may make us confident that the weighting of the original time series leads to a data input that represents the dynamics within the CDS financial network more accurately.

First, we perform the cointegration test using unweighted CDS spread data. Again, we use the CDS time series of the five largest CDS dealers according to the OCC statistics and of the remaining peripheral dealers in separate analyses. The results of the cointegration test using the unweighted CDS spread time series of the G5 (peripheral) dealers for the pre-clearing period are given in Panel A (C) of Table 4.4.5 and for the post-clearing period in Panel B (D) of Table 4.4.5.

Panel A of Table 4.4.5 shows that we can reject the null hypothesis that three or fewer unweighted CDS spread time series of the G5 dealers are not cointegrated at a significance level of 1%. For the post-clearing period (Panel B), we cannot reject the null hypothesis of no cointegration for all of the CDS spread time series. For the peripheral dealers, Panel C of Table 4.4.9 shows that we can reject the null hypothesis of no cointegration for eight out of nine unweighted CDS spread time series for the pre-clearing period. For the post-clearing period, Panel D of Table 4.4.9 displays that we can reject the null hypothesis of no cointegration for only two of the unweighted CDS spread time series of the peripheral dealers.

In this analysis, we see a slightly larger decrease in contagion risk indicated by the cointegration tests using unweighted CDS spreads as for the cointegration tests using weighted CDS spreads. Unweighted CDS time series treat all CDS dealers as equally influential on contagion risk. This may overweight trading relationships of low systemic importance and underweight trading relationships with high systemic importance. This is why it may not be surprising to observe a stronger effect of central clearing on contagion risk using the unweighted CDS time series.

In another robustness check, we perform the Granger causality test using the 20-day unweighted CDS return volatility time series of the G5 CDS dealers and

4.4. ROBUSTNESS TESTS

Table 4.4.5: Cointegration test (unweighted time series)

This table shows cointegration tests on unweighted CDS spread time series for CDS core and periphery dealers separately prior to and after the introduction of central clearing. We test cointegration by the maximum eigenvalue test statistic and allow for a constant term in the cointegration relationship. The number of lags is determined by the Akaike Information Criterion. Panel A (Panel B) shows results on the cointegration of CDS spread time series of the five largest CDS dealers prior to (after) the introduction of central clearing. Panel C (Panel D) shows results on the cointegration of CDS spread time series of the remaining nine peripheral CDS dealers prior to (after) the introduction of central clearing. Green- (red-)colored values are (not) exceeded by the test statistic and (do not) lead to a rejection of the null hypothesis of no cointegration on the corresponding level of statistical significance.

Panel A: G5 - Pre-clearing					Panel B: G5 - Post-clearing				
	test stat	10pct	5pct	1pct		test stat	10pct	5pct	1pct
r _j =4	9.89	7.52	9.24	12.97	r _j =4	2.56	7.52	9.24	12.97
r _j =3	12.60	13.75	15.67	20.2	r _j =3	4.87	13.75	15.67	20.2
r _j =2	40.46	19.77	22.00	26.81	r _j =2	17.87	19.77	22	26.81
r _j =1	118.31	25.56	28.14	33.24	r _j =1	24.69	25.56	28.14	33.24
r=0	235.64	31.66	34.40	39.79	r=0	37.90	31.66	34.4	39.79

Panel C: Periphery - Pre-clearing					Panel D: Periphery - Post-clearing				
	test stat	10pct	5pct	1pct		test stat	10pct	5pct	1pct
r _j =8	1.65	7.52	9.24	12.97	r _j =8	4.06	7.52	9.24	12.97
r _j =7	15.92	13.75	15.67	20.2	r _j =7	4.60	13.75	15.67	20.2
r _j =6	21.21	19.77	22	26.81	r _j =6	7.62	19.77	22	26.81
r _j =5	30.37	25.56	28.14	33.24	r _j =5	10.90	25.56	28.14	33.24
r _j =4	47.62	31.66	34.4	39.79	r _j =4	17.77	31.66	34.4	39.79
r _j =3	111.76	37.45	40.3	46.82	r _j =3	24.73	37.45	40.3	46.82
r _j =2	198.52	43.25	46.45	51.91	r _j =2	27.06	43.25	46.45	51.91
r _j =1	282.69	48.91	52	57.95	r _j =1	49.78	48.91	52	57.95
r=0	337.20	54.35	57.42	63.71	r=0	70.55	54.35	57.42	63.71

peripheral dealers as data input. The results on the bi- and multivariate Granger causality tests are displayed in Table 4.4.6.

Panel A (Panel B) of Table 4.4.6 displays F statistics and p values for the bivariate Granger causality tests across the five largest CDS dealers in the pre- (post-) clearing period using 20-day unweighted CDS return volatility time series as data input. As in our initial results, all Granger-causal relationships are statistically highly significant for the pre-clearing period. For the post-clearing period, we observe four Granger-causal relationships becoming statistically insignificant at the 5% level. For the multivariate Granger causality tests, all Granger-causal relationships are statistically highly significant for the pre-clearing period. Panel D of Table 4.4.6 shows that this does not change for the post-clearing period.

The results for the peripheral dealers in Panel E and Panel F are comparable to our baseline results, as all Granger-causal relationships are statistically highly significant for the pre-clearing period, and eight out of nine Granger-causal relationships are statistically highly significant for the post-clearing period. According

to the Granger causality tests using the unweighted CDS return volatility time series, contagion risk among CDS dealers does not seem to change strongly from the pre-clearing to the post-clearing period. This is contrary to our results with the weighted CDS time series which may be able to provide a more detailed picture for the CDS financial network.

Third, we perform the ADL model using unweighted CDS return volatilities in order to test our results on contagious effects from core dealers to peripheral dealers in the CDS market for robustness. The results of the ADL model are displayed in Table 4.4.7. Compared to our initial model using the CDS data input, we see more statistically significant effects of any of the three core dealers' short-term risk on the short-term risk of peripheral dealers for the pre-clearing period. The number of statistically significant coefficients at least at the 5% level decreases from twelve to eight from the pre-clearing period to the post-clearing period. Again, the contagious effects that we find using the unweighted CDS time series seem to be structurally larger compared to the weighted CDS time series. This may point to our expectation that weighting our original time series by the dealer-specific CDS market share allows us to isolate the CDS market-specific contagion risk more accurately.

In the Diebold-Yilmaz framework using the unweighted CDS returns and CDS return volatilities of CDS dealers, we find a slight increase in the connectedness of CDS dealers by 0.01 and 0.04 respectively. This is contrary to our baseline results that report a decrease in CDS dealer connectedness.

In conclusion, we cannot observe a consistent effect of central clearing on the different contagion risk measures using the unweighted CDS spread time series. We observe a stronger decrease of contagion risk following the introduction of central clearing according to the cointegration tests and volatility spillover models, no significant changes for the Granger causality tests and even slight increases according to the volatility spillover tables. Based on these results, we claim that the CDS time series, weighted by the CDS market share in terms of outstanding positions, represent a substantially different contagion risk dynamic than the unweighted CDS time series. We are confident that the different contagion risk dynamic in the weighted CDS time series represents the CDS market-specific contagion risk more accurately due to the incorporation of the CDS financial network trading relationships into the CDS time series.

4.4. ROBUSTNESS TESTS

Table 4.4.6: Granger causality test (unweighted time series)

This table shows bi- and multivariate Granger causality tests on unweighted CDS return volatility time series for CDS core and periphery dealers separately prior to and after the introduction of central clearing. Panel A (Panel B) shows results on bivariate Granger causality tests according to regression (4.3) on pairs of unweighted log realized 20-day CDS return volatilities among core and peripheral CDS dealers prior to (after) the introduction of central clearing. Panel C/E (Panel D/F) shows results on multivariate Granger causality tests according to regression (4.4) using the G5/peripheral dealers' unweighted log realized 20-day CDS return volatilities prior to (after) the introduction of central clearing. The number of lags included is selected according to the Akaike Information Criterion under the assumption of a constant and a time trend in the VAR model.

Panel A: G5 - Pre-clearing (bivar.)

Variables	F statistic	p-value
HSBC - BOFA	42.98	0.00
BOFA - HSBC	12.99	0.00
HSBC - CINC	138.28	0.00
CINC - HSBC	69.16	0.00
HSBC - JPM	37.31	0.00
JPM - HSBC	49.22	0.00
HSBC - GS	32.61	0.00
GS - HSBC	13.73	0.00
BOFA - CINC	9.98	0.00
CINC - BOFA	77.64	0.00
BOFA - JPM	12.55	0.00
JPM - BOFA	32.54	0.00
BOFA - GS	8.98	0.00
GS - BOFA	24.85	0.00
CINC - JPM	31.57	0.00
JPM - CINC	16.09	0.00
CINC - GS	37.52	0.00
GS - CINC	9.26	0.00
JPM - GS	16.21	0.00
GS - JPM	33.03	0.00

Panel B: G5 - Post-clearing (bivar.)

Variables	F statistic	p-value
HSBC - BOFA	2.53	0.01
BOFA - HSBC	3.18	0.00
HSBC - CINC	5.09	0.00
CINC - HSBC	2.68	0.00
HSBC - JPM	2.66	0.01
JPM - HSBC	3.40	0.00
HSBC - GS	3.49	0.00
GS - HSBC	1.89	0.05
BOFA - CINC	8.60	0.00
CINC - BOFA	2.46	0.01
BOFA - JPM	9.37	0.00
JPM - BOFA	1.79	0.06
BOFA - GS	1.46	0.17
GS - BOFA	4.44	0.00
CINC - JPM	2.05	0.03
JPM - CINC	4.63	0.00
CINC - GS	1.24	0.26
GS - CINC	8.27	0.00
JPM - GS	0.56	0.83
GS - JPM	6.04	0.00

Panel C: G5 - Pre-clearing (multivar.)

Variables	F statistic	p-value
HSBC	24.62	0.00
BOFA	10.19	0.00
CINC	23.04	0.00
JPM	20.25	0.00
GS	9.43	0.00

Panel D: G5 - Post-clearing (multivar.)

Variables	F statistic	p-value
HSBC	2.74	0.00
BOFA	3.37	0.00
CINC	2.08	0.00
JPM	3.94	0.00
GS	3.58	0.00

Panel E: Periphery - Pre-clearing (multivar.)

Variables	F statistic	p-value
BNP	19.44	0.00
WF	13.84	0.00
SC	12.54	0.00
BC	16.99	0.00
DB	9.73	0.00
LCL	12.45	0.00
UBS	11.21	0.00
MS	15.53	0.00
CS	12.13	0.00

Panel F: Periphery - Post-clearing (multivar.)

Variables	F statistic	p-value
BNP	1.83	0.00
WF	4.01	0.00
SC	2.33	0.00
BC	1.75	0.00
DB	3.92	0.00
LCL	0.98	0.56
UBS	4.16	0.00
MS	1.82	0.00
CS	2.71	0.00

CHAPTER 4. FIREWALL OR SUPERSPREADER? - CDS CENTRAL
CLEARING AND CONTAGION RISK WITHIN THE CDS DEALER
NETWORK

Table 4.4.7: CDS return volatility spillover analysis (unweighted time series)

This table shows results for regression (4.5), the unweighted CDS return volatility spillover analysis from CDS core dealers to peripheral dealers. We use the 20-day log realized unweighted CDS return volatility of peripheral dealers as dependent variables in the different models 1-10. As independent variables, we use the lagged 20-, 60-, and 120-day log realized CDS return volatilities of the three largest CDS dealers: JP Morgan, Citibank, and Bank of America. We also include the corresponding autoregressive terms of the 20-, 60-, and 120-day log realized CDS return volatility (not reported). We split our sample into the pre-clearing period and the post-clearing period and show corresponding results in Panel A and Panel B. In parentheses, we display Newey-West standard errors.

Panel A: Pre-clearing

	<i>Dependent variable:</i>									
	HSBC	WF	SG	BC	DB	LCL	GS	MS	UBS	CS
	(1)	(2)	(3)	(4)	(5)	(6)	(7)	(8)	(9)	(10)
bofa20	-0.0177 (0.0145)	-0.0198 (0.0350)	0.0176 (0.0177)	0.0045 (0.0230)	-0.0299 (0.0257)	-0.0046 (0.0192)	0.0307 (0.0244)	0.0017 (0.0125)	-0.0386 (0.0237)	0.0014 (0.0217)
bofa60	0.0261 (0.0269)	0.0012 (0.0403)	-0.0320 (0.0249)	-0.0114 (0.0334)	0.0337 (0.0331)	0.0015 (0.0263)	-0.0199 (0.0264)	0.0090 (0.0127)	0.0727* (0.0421)	0.0266 (0.0206)
bofa120	-0.0023 (0.0201)	0.0265 (0.0343)	0.0123 (0.0140)	0.0148 (0.0195)	0.0027 (0.0465)	-0.0143 (0.0164)	0.0031 (0.0245)	-0.0157 (0.0145)	-0.0355 (0.0235)	-0.0096 (0.0138)
citi20	0.0391*** (0.0134)	0.0413* (0.0227)	0.0285* (0.0156)	0.0347** (0.0172)	0.0548*** (0.0212)	0.0239*** (0.0090)	-0.0143 (0.0148)	-0.0032 (0.0037)	0.0005 (0.0123)	0.0033 (0.0123)
citi60	-0.0300 (0.0276)	0.0097 (0.0273)	0.0367** (0.0151)	0.0689 (0.0476)	-0.0528* (0.0305)	-0.0208 (0.0183)	0.0047 (0.0142)	-0.0079 (0.0056)	-0.0687* (0.0394)	-0.0457*** (0.0137)
citi120	-0.0034 (0.0346)	-0.0018 (0.0347)	-0.0501*** (0.0182)	-0.0377 (0.0431)	0.0181 (0.0324)	-0.0073 (0.0212)	0.0063 (0.0232)	0.0094 (0.0119)	0.0355 (0.0244)	0.0038 (0.0144)
jpm20	0.0194 (0.0153)	-0.0136 (0.0459)	0.0063 (0.0165)	-0.0029 (0.0236)	0.0198 (0.0233)	0.0271 (0.0175)	0.0024 (0.0108)	-0.0020 (0.0079)	0.0692*** (0.0193)	0.0499*** (0.0104)
jpm60	-0.0253 (0.0185)	-0.0068 (0.0455)	-0.0236 (0.0265)	0.0152 (0.0377)	-0.0523 (0.0321)	-0.0363 (0.0239)	-0.0020 (0.0274)	-0.0067 (0.0124)	-0.0575** (0.0269)	-0.0122 (0.0132)
jpm120	0.0575** (0.0245)	0.1023 (0.0733)	0.0449 (0.0378)	0.0172 (0.0470)	0.0760* (0.0430)	0.0818** (0.0343)	-0.0132 (0.0215)	0.0142 (0.0150)	0.0780 (0.0520)	0.0190 (0.0361)
Observations	3,512	3,512	3,512	3,512	3,512	3,512	3,512	3,512	3,512	3,512
Adjusted R ²	0.9666	0.9785	0.9734	0.9793	0.9576	0.9622	0.9638	0.9650	0.9489	0.9592

Note:

*p<0.1; **p<0.05; ***p<0.01

Panel B: Post-clearing

	<i>Dependent variable:</i>									
	HSBC	WF	SG	BC	DB	LCL	GS	MS	UBS	CS
	(1)	(2)	(3)	(4)	(5)	(6)	(7)	(8)	(9)	(10)
bofa20	0.0120 (0.0245)	0.0291 (0.0232)	0.0680* (0.0357)	0.0179 (0.0442)	0.0568* (0.0343)	0.0194 (0.0289)	0.0078 (0.0098)	0.0111 (0.0161)	0.0552 (0.0345)	0.0313 (0.0325)
bofa60	0.0372 (0.0397)	-0.0924 (0.0928)	-0.1484* (0.0889)	0.0393 (0.0433)	-0.2284 (0.1422)	-0.0347 (0.0690)	0.0146 (0.0174)	-0.0146 (0.0296)	-0.2583* (0.1543)	-0.1743* (0.0897)
bofa120	-0.1010 (0.0674)	-0.0976 (0.0594)	-0.1526 (0.1330)	-0.1035* (0.0626)	-0.0752 (0.0767)	-0.0158 (0.1182)	-0.0453** (0.0215)	-0.0270 (0.0252)	-0.0925 (0.1129)	-0.0237 (0.0729)
citi20	0.0364 (0.0306)	-0.0030 (0.0321)	-0.0581 (0.0581)	0.0185 (0.0465)	-0.0110 (0.0556)	-0.0037 (0.0436)	0.0090 (0.0200)	0.0037 (0.0154)	-0.0545 (0.0601)	-0.0046 (0.0250)
citi60	0.0393 (0.0729)	0.2031 (0.1337)	0.2859** (0.1264)	-0.0800 (0.0623)	0.3723* (0.2229)	0.1331 (0.0875)	0.0138 (0.0333)	0.0297 (0.0370)	0.4457* (0.2357)	0.1023 (0.0661)
citi120	-0.0743 (0.0730)	-0.0032 (0.1000)	0.0446 (0.1586)	0.1127 (0.0798)	-0.1683 (0.1720)	-0.0918 (0.1122)	0.0160 (0.0361)	0.0319 (0.0493)	-0.0588 (0.1874)	-0.0324 (0.0726)
jpm20	-0.0591** (0.0231)	-0.0306 (0.0234)	-0.0089 (0.0318)	-0.0272 (0.0200)	-0.0850** (0.0422)	-0.0015 (0.0372)	-0.0022 (0.0109)	-0.0071 (0.0129)	-0.0628 (0.0459)	-0.0270 (0.0191)
jpm60	-0.1047 (0.0869)	-0.0201 (0.0611)	0.0481 (0.1081)	-0.0215 (0.0477)	-0.0395 (0.0691)	-0.0169 (0.0998)	-0.0321 (0.0288)	-0.0156 (0.0247)	0.0233 (0.0963)	0.0273 (0.0388)
jpm120	0.2682** (0.1227)	0.1374*** (0.0513)	0.1084 (0.1328)	0.0741 (0.0602)	0.2511** (0.1014)	0.1495 (0.1475)	0.0503 (0.0317)	0.0408 (0.0290)	0.2714** (0.1216)	0.0588 (0.0450)
Observations	2,973	2,973	2,973	2,973	2,973	2,973	2,973	2,973	2,973	2,973
Adjusted R ²	0.9513	0.9606	0.9675	0.9290	0.9539	0.9392	0.9266	0.9377	0.9614	0.9600

Note:

*p<0.1; **p<0.05; ***p<0.01

Table 4.4.8: Diebold-Yilmaz spillover table (unweighted time series)

This table shows spillover tables according to Diebold and Yilmaz (2012) based on our unweighted CDS return and CDS return volatility event time series. The spillover tables are based upon a VAR model with a number of lags determined by the Akaike Information Criterion. The variance decomposition follows the framework of Koop et al. (1996) and Pesaran and Shin (1998). The individual cells provide an estimate for the contribution of dealer i 's CDS return (CDS return volatility) innovations to the variance of dealer j 's 20-day ahead CDS return (CDS return volatility) forecast error. Panel A (Panel B) shows spillover tables based on unweighted CDS returns for the pre-clearing period (post-clearing period). Panel C (Panel D) shows spillover tables based on unweighted CDS return volatilities for the pre-clearing period (post-clearing period).

Panel A: CDS return spillover (pre-clearing)

	JPM	CITI	BOFA	GS	HSBC	MS	BNP	WF	SG	BC	DB	LCL	UBS	CS	FROM
JPM	0.19	0.08	0.08	0.10	0.04	0.07	0.05	0.12	0.06	0.05	0.04	0.04	0.03	0.04	0.81
CITI	0.08	0.19	0.10	0.10	0.05	0.07	0.11	0.05	0.11	0.05	0.04	0.05	0.03	0.04	0.81
BOFA	0.08	0.09	0.19	0.10	0.04	0.08	0.05	0.13	0.04	0.05	0.04	0.04	0.04	0.03	0.81
GS	0.09	0.09	0.09	0.18	0.05	0.10	0.05	0.11	0.04	0.04	0.05	0.04	0.04	0.04	0.82
HSBC	0.03	0.04	0.03	0.04	0.17	0.03	0.10	0.04	0.10	0.08	0.09	0.09	0.07	0.08	0.83
MS	0.08	0.07	0.08	0.12	0.05	0.20	0.05	0.09	0.05	0.05	0.05	0.04	0.04	0.04	0.80
BNP	0.03	0.04	0.03	0.04	0.09	0.03	0.15	0.03	0.11	0.09	0.09	0.10	0.08	0.09	0.85
WF	0.10	0.09	0.11	0.10	0.04	0.07	0.05	0.20	0.05	0.04	0.05	0.03	0.03	0.03	0.80
SG	0.04	0.03	0.03	0.03	0.09	0.03	0.12	0.04	0.16	0.08	0.10	0.11	0.07	0.08	0.84
BC	0.04	0.04	0.03	0.04	0.09	0.04	0.10	0.04	0.09	0.18	0.08	0.08	0.07	0.08	0.82
DB	0.03	0.03	0.03	0.04	0.08	0.03	0.10	0.04	0.10	0.07	0.16	0.10	0.09	0.09	0.84
LCL	0.03	0.03	0.03	0.03	0.09	0.03	0.11	0.03	0.12	0.08	0.10	0.16	0.08	0.08	0.84
UBS	0.03	0.03	0.03	0.03	0.08	0.03	0.10	0.03	0.08	0.08	0.10	0.08	0.18	0.13	0.82
CS	0.03	0.03	0.03	0.03	0.08	0.02	0.10	0.03	0.09	0.08	0.10	0.09	0.12	0.17	0.83
NET	0.70	0.70	0.71	0.79	0.85	0.62	1.04	0.84	0.98	0.82	0.93	0.91	0.80	0.83	11.53
GROSS	0.90	0.90	0.90	0.97	1.03	0.82	1.19	1.04	1.13	1.00	1.09	1.06	0.98	1.00	14.00

Spillover Index (pre): 0.82

Panel B: CDS return spillover (post-clearing)

	JPM	CITI	BOFA	GS	HSBC	MS	BNP	WF	SG	BC	DB	LCL	UBS	CS	FROM
JPM	0.17	0.11	0.11	0.11	0.02	0.11	0.03	0.10	0.04	0.03	0.05	0.03	0.05	0.05	0.83
CITI	0.09	0.15	0.11	0.10	0.03	0.10	0.04	0.08	0.05	0.04	0.06	0.04	0.05	0.05	0.85
BOFA	0.09	0.11	0.14	0.10	0.03	0.10	0.04	0.09	0.05	0.03	0.06	0.03	0.05	0.06	0.86
GS	0.10	0.11	0.11	0.15	0.03	0.12	0.03	0.09	0.04	0.04	0.05	0.04	0.04	0.05	0.85
HSBC	0.03	0.05	0.04	0.05	0.21	0.04	0.09	0.02	0.07	0.13	0.06	0.08	0.06	0.07	0.79
MS	0.10	0.11	0.11	0.12	0.03	0.16	0.03	0.09	0.04	0.04	0.05	0.04	0.04	0.05	0.84
BNP	0.03	0.04	0.04	0.04	0.07	0.03	0.17	0.02	0.14	0.07	0.08	0.10	0.08	0.09	0.83
WF	0.10	0.10	0.11	0.10	0.01	0.09	0.02	0.17	0.05	0.02	0.07	0.03	0.06	0.05	0.83
SG	0.04	0.05	0.05	0.04	0.05	0.04	0.12	0.04	0.15	0.05	0.09	0.08	0.09	0.09	0.85
BC	0.03	0.05	0.05	0.06	0.12	0.05	0.08	0.03	0.07	0.20	0.06	0.08	0.06	0.07	0.80
DB	0.05	0.06	0.06	0.05	0.04	0.05	0.07	0.10	0.10	0.05	0.17	0.05	0.11	0.09	0.83
LCL	0.04	0.05	0.04	0.05	0.07	0.04	0.11	0.03	0.10	0.08	0.06	0.18	0.08	0.07	0.82
UBS	0.05	0.06	0.06	0.05	0.04	0.05	0.07	0.06	0.10	0.05	0.11	0.06	0.17	0.09	0.83
CS	0.04	0.06	0.06	0.05	0.05	0.05	0.08	0.05	0.10	0.06	0.10	0.06	0.10	0.16	0.84
NET	0.78	0.96	0.98	0.91	0.58	0.87	0.79	0.76	0.96	0.68	0.88	0.73	0.88	0.88	11.65
GROSS	0.95	1.11	1.12	1.06	0.80	1.03	0.97	0.94	1.12	0.88	1.04	0.91	1.05	1.04	14.00

Spillover Index (pre): 0.83

CHAPTER 4. FIREWALL OR SUPERSPREADER? - CDS CENTRAL
CLEARING AND CONTAGION RISK WITHIN THE CDS DEALER
NETWORK

Panel C: CDS return volatility spillover (pre-clearing)

	JPM	CITI	BOFA	GS	HSBC	MS	BNP	WF	SG	BC	DB	LCL	UBS	CS	FROM
JPM	0.23	0.10	0.10	0.08	0.02	0.07	0.03	0.10	0.12	0.10	0.01	0.03	0.01	0.01	0.77
CITI	0.04	0.44	0.14	0.05	0.02	0.08	0.01	0.14	0.02	0.03	0.01	0.00	0.01	0.01	0.56
BOFA	0.04	0.09	0.29	0.06	0.05	0.12	0.01	0.15	0.07	0.05	0.04	0.02	0.01	0.01	0.71
GS	0.09	0.09	0.13	0.27	0.03	0.12	0.03	0.04	0.05	0.06	0.03	0.02	0.02	0.03	0.73
HSBC	0.10	0.07	0.06	0.03	0.22	0.04	0.05	0.08	0.06	0.09	0.07	0.05	0.03	0.04	0.78
MS	0.05	0.08	0.10	0.11	0.03	0.33	0.03	0.05	0.04	0.06	0.04	0.03	0.02	0.03	0.67
BNP	0.07	0.07	0.04	0.03	0.06	0.03	0.14	0.09	0.16	0.12	0.05	0.06	0.03	0.05	0.86
WF	0.08	0.16	0.13	0.08	0.03	0.07	0.01	0.26	0.08	0.05	0.02	0.01	0.01	0.01	0.74
SG	0.07	0.05	0.03	0.04	0.04	0.04	0.10	0.07	0.24	0.09	0.04	0.08	0.05	0.06	0.76
BC	0.08	0.12	0.04	0.02	0.05	0.03	0.05	0.17	0.14	0.20	0.04	0.04	0.02	0.02	0.80
DB	0.08	0.09	0.07	0.03	0.14	0.04	0.06	0.09	0.06	0.07	0.16	0.03	0.04	0.05	0.84
LCL	0.07	0.03	0.02	0.05	0.05	0.03	0.13	0.04	0.17	0.07	0.05	0.14	0.06	0.09	0.86
UBS	0.09	0.03	0.03	0.05	0.10	0.03	0.11	0.02	0.06	0.05	0.08	0.05	0.18	0.13	0.82
CS	0.09	0.03	0.04	0.05	0.08	0.04	0.12	0.02	0.09	0.07	0.07	0.08	0.09	0.15	0.85
NET	0.94	1.00	0.92	0.69	0.70	0.74	0.73	1.05	1.11	0.90	0.55	0.49	0.41	0.52	10.74
GROSS	1.18	1.44	1.20	0.96	0.92	1.07	0.87	1.31	1.35	1.10	0.71	0.63	0.59	0.67	14.00

Spillover Index (pre): **0.77**

Panel D: CDS return volatility spillover (post-clearing)

	JPM	CITI	BOFA	GS	HSBC	MS	BNP	WF	SG	BC	DB	LCL	UBS	CS	FROM
JPM	0.14	0.11	0.11	0.08	0.02	0.09	0.00	0.11	0.05	0.01	0.09	0.01	0.09	0.07	0.86
CITI	0.09	0.14	0.11	0.08	0.02	0.10	0.01	0.10	0.05	0.02	0.09	0.01	0.09	0.08	0.86
BOFA	0.09	0.11	0.13	0.08	0.02	0.11	0.01	0.09	0.05	0.03	0.09	0.01	0.08	0.10	0.87
GS	0.10	0.12	0.12	0.15	0.03	0.12	0.01	0.08	0.04	0.03	0.06	0.01	0.06	0.07	0.85
HSBC	0.02	0.06	0.05	0.08	0.39	0.06	0.03	0.01	0.02	0.17	0.01	0.04	0.01	0.05	0.61
MS	0.09	0.11	0.12	0.10	0.02	0.14	0.01	0.08	0.05	0.04	0.07	0.01	0.07	0.09	0.86
BNP	0.03	0.03	0.03	0.03	0.02	0.03	0.24	0.04	0.20	0.02	0.05	0.16	0.14	0.06	0.76
WF	0.09	0.10	0.09	0.05	0.01	0.07	0.00	0.16	0.07	0.00	0.14	0.01	0.14	0.08	0.84
SG	0.06	0.07	0.06	0.04	0.02	0.05	0.08	0.10	0.16	0.01	0.11	0.06	0.10	0.09	0.84
BC	0.03	0.06	0.06	0.08	0.12	0.11	0.03	0.01	0.03	0.30	0.01	0.03	0.02	0.10	0.70
DB	0.08	0.09	0.08	0.04	0.01	0.06	0.01	0.14	0.09	0.00	0.16	0.01	0.15	0.09	0.84
LCL	0.03	0.03	0.02	0.02	0.03	0.02	0.19	0.03	0.17	0.03	0.04	0.30	0.04	0.05	0.70
UBS	0.08	0.09	0.08	0.04	0.01	0.06	0.01	0.15	0.08	0.00	0.15	0.01	0.16	0.09	0.84
CS	0.06	0.08	0.08	0.05	0.02	0.09	0.02	0.09	0.08	0.04	0.10	0.02	0.09	0.15	0.85
NET	0.86	1.08	1.04	0.77	0.36	0.97	0.39	1.05	0.99	0.39	1.01	0.39	0.98	1.01	11.28
GROSS	1.00	1.22	1.17	0.92	0.75	1.11	0.63	1.20	1.15	0.69	1.16	0.69	1.14	1.16	14.00

Spillover Index (pre): **0.81**

4.4.3 Stock market data

In this section, we perform the test on cointegration relationships, Granger causality, volatility spillover models and CDS dealer connectedness as in the previous chapter but with weighted stock prices and stock returns as input data instead of CDS spreads and CDS returns.

First, we perform the cointegration test using stock price data. As before, we use the stock price time series of the five largest CDS dealers according to the OCC statistics and of the remaining peripheral dealers in separate analyses. The results of the cointegration test using the stock price time series of the G5 (peripheral) dealers for the pre-clearing period are given in Panel A (B) of Table 4.4.9 and for the post-clearing period in Panel C (D) of Table 4.4.9.

Panel A of Table 4.4.9 shows that we cannot reject the null hypothesis of no cointegration for three or fewer stock price time series of the G5 dealers at a significance level of 1%. At a 10% significance level, we can reject the null hypothesis that less than five time series are not cointegrated. On the basis of these results, we assume that more than three stock price time series of the G5 dealers are cointegrated in

Table 4.4.9: Cointegration test (stock prices)

This table shows cointegration tests on stock price time series for CDS core and periphery dealers separately prior to and after the introduction of central clearing. We test cointegration by the maximum eigenvalue test statistic and allow for a constant term in the cointegration relationship. The number of lags is determined by the Akaike Information Criterion. Panel A (Panel B) shows results on the cointegration of stock price time series of the five largest CDS dealers (G5) prior to (after) the introduction of central clearing. Panel C (Panel D) shows results on the cointegration of stock price time series of the remaining nine CDS dealers (periphery) prior to (after) the introduction of central clearing. Green- (red-)colored values are (not) exceeded by the test statistic and (do not) lead to a rejection of the null hypothesis of no cointegration on the corresponding level of statistical significance.

Panel A: G5 - Pre-clearing					Panel B: G5 - Post-clearing				
	test stat	10pct	5pct	1pct		test stat	10pct	5pct	1pct
$r_j=4$	8.01	7.52	9.24	12.97	$r_j=4$	5.70	7.52	9.24	12.97
$r_j=3$	14.93	13.75	15.67	20.2	$r_j=3$	8.17	13.75	15.67	20.2
$r_j=2$	30.79	19.77	22	26.81	$r_j=2$	11.25	19.77	22	26.81
$r_j=1$	40.35	25.56	28.14	33.24	$r_j=1$	18.19	25.56	28.14	33.24
$r=0$	79.53	31.66	34.4	39.79	$r=0$	34.85	31.66	34.4	39.79

Panel C: Periphery - Pre-clearing					Panel D: Periphery - Post-clearing				
	test stat	10pct	5pct	1pct		test stat	10pct	5pct	1pct
$r_j=5$	10.89	7.52	9.24	12.97	$r_j=5$	3.10	7.52	9.24	12.97
$r_j=4$	16.26	13.75	15.67	20.2	$r_j=4$	8.33	13.75	15.67	20.20
$r_j=3$	41.06	19.77	22	26.81	$r_j=3$	11.63	19.77	22.00	26.81
$r_j=2$	125.07	25.56	28.14	33.24	$r_j=2$	17.27	25.56	28.14	33.24
$r_j=1$	199.52	31.66	34.4	39.79	$r_j=1$	25.31	31.66	34.40	39.79
$r=0$	205.20	37.45	40.3	46.82	$r=0$	30.43	37	40.30	46.82

the pre-clearing period. Panel B of Table 4.4.9 displays results for the post-clearing period. In the post-clearing period, we cannot reject the null hypothesis of no cointegration for only two stock price time series of the five largest CDS dealers in the post-clearing period.

For the peripheral dealers, Panel C of Table 4.4.9 shows that we can reject the null hypothesis that less than five stock price time series of the peripheral dealers are not cointegrated in the pre-clearing period. For the post-clearing period, Panel D of Table 4.4.9 displays that we cannot reject the null hypothesis, that none of the stock price time series of the peripheral dealers are cointegrated. We see a similar decrease in contagion risk indicated by the cointegration tests using stock prices as for the cointegration tests using CDS spreads as data input. This finding supports our initial results.

In another robustness check, we perform the Granger causality test using the CDS dealers' 20-day stock return volatility time series as data input. The results on the bi- and multivariate Granger causality tests are displayed in Table 4.4.10.

Panel A of Table 4.4.10 displays F statistics and p values for the bivariate Granger causality tests across the five largest CDS dealers in the pre-clearing period using 20-day stock return volatility time series as data input. As in our initial results, all Granger-causal relationships are statistically highly significant for the pre-clearing period. For the post-clearing period, only six of the twenty potentially Granger-causal relationships are statistically significant at the 5% level. Also for the multivariate Granger causality tests (Panels C-F), the number of statistically significant Granger-causal relationships at the 5% level decreases for core dealers from the pre- to the post-clearing period as well as for peripheral dealers. This result on a decrease in contagion risk following the introduction of central clearing is even stronger as in our initial results.

4.4. ROBUSTNESS TESTS

Table 4.4.10: Granger causality test (stock return volatilities)

This table shows bi- and multivariate Granger causality tests on stock return volatility time series for CDS core and periphery dealers separately prior to and after the introduction of central clearing. Panel A (Panel B) shows results on bivariate Granger causality tests according to regression (4.3) and (4.4) on pairs of unweighted log realized 20-day stock return volatilities among core and peripheral CDS dealers prior to (after) the introduction of central clearing. Panel C/E (Panel D/F) shows results on multivariate Granger causality tests according to regression (4.4) using the G5/peripheral dealers' log realized 20-day stock return volatilities for the period prior to (after) the introduction of central clearing. The number of lags included is selected according to the Akaike Information Criterion under the assumption of a constant and a time trend in the VAR model.

Panel A: G5 - Pre-clearing (bivar.)

Variables	F statistic	p-value
HSBC - BOFA	38.22	0.00
BOFA - HSBC	64.98	0.00
HSBC - CINC	20.42	0.00
CINC - HSBC	8.52	0.00
HSBC - JPM	15.57	0.00
JPM - HSBC	60.64	0.00
HSBC - GS	3.10	0.00
GS - HSBC	18.36	0.00
BOFA - CINC	9.65	0.00
CINC - BOFA	11.13	0.00
BOFA - JPM	23.68	0.00
JPM - BOFA	66.44	0.00
BOFA - GS	19.34	0.00
GS - BOFA	25.75	0.00
CINC - JPM	6.37	0.00
JPM - CINC	17.70	0.00
CINC - GS	3.45	0.00
GS - CINC	9.07	0.00
JPM - GS	5.86	0.00
GS - JPM	22.59	0.00

Panel B: G5 - Post-clearing (bivar.)

Variables	F statistic	p-value
HSBC - BOFA	9.64	0.00
BOFA - HSBC	1.74	0.08
HSBC - CINC	0.04	1.00
CINC - HSBC	0.02	1.00
HSBC - JPM	7.64	0.00
JPM - HSBC	0.69	0.72
HSBC - GS	1.28	0.24
GS - HSBC	1.12	0.34
BOFA - CINC	0.25	0.99
CINC - BOFA	0.12	1.00
BOFA - JPM	6.48	0.00
JPM - BOFA	0.57	0.82
BOFA - GS	0.51	0.87
GS - BOFA	1.85	0.05
CINC - JPM	0.26	0.99
JPM - CINC	0.14	1.00
CINC - GS	1.66	0.09
GS - CINC	0.15	1.00
JPM - GS	11.12	0.00
GS - JPM	1.88	0.04

Panel C: G5 - Pre-clearing (multivar.)

Variables	F statistic	p-value
HSBC	20.65	0.00
BOFA	24.25	0.00
CINC	4.36	0.00
JPM	33.82	0.00
GS	14.66	0.00

Panel D: G5 - Post-clearing (multivar.)

Variables	F statistic	p-value
HSBC	3.07	0.00
BOFA	1.85	0.00
CINC	0.57	0.98
JPM	3.55	0.00
GS	1.53	0.02

Panel E: Periphery - Pre-clearing (multivar.)

Variables	F statistic	p-value
WF	8.24	0.00
BC	14.42	0.00
DB	8.26	0.00
UBS	9.54	0.00
CS	7.80	0.00

Panel F: Periphery - Post-clearing (multivar.)

Variables	F statistic	p-value
WF	5.76	0.00
BC	1.30	0.24
DB	1.48	0.16
UBS	0.93	0.49
CS	1.05	0.40

Third, we perform the ADL model using stock return volatilities instead of CDS return volatilities in order to test our results on contagious effects from core dealers to peripheral dealers in the CDS market for robustness. The results of the ADL model are displayed in Table 4.4.11. Compared to our initial model using the CDS data input, we see no consistent and statistically significant effect of any of the three core dealers' short-term risk on the short-term risk of peripheral dealers, neither in the pre-clearing period, nor in the post-clearing period. Panel B of Table 4.4.11 shows that any statistically significant effects of the core dealers' mid- or long-term risk to the short-term risk of peripheral dealers vanish in the post-clearing period. Again, we find our initial findings are supported by the robustness tests using stock prices and stock returns as data input.

In the Diebold-Yilmaz framework using the stock returns and stock return volatilities of CDS dealers, we find a decrease in the connectedness of CDS dealers by 7% and 9% respectively. These findings are in line with our baseline results in terms of the direction as well as of the size of the economic effect.

4.4. ROBUSTNESS TESTS

Table 4.4.11: Stock return volatility spillover analysis

This table shows results for regression (4.5), the stock return volatility spillover analysis from CDS core dealers to peripheral dealers along calendar time. We use the 20-day log realized CDS return volatility of peripheral dealers as dependent variables in the different models 1-10. As independent variables, we use the lagged 20-, 60-, and 120-day log realized CDS return volatilities of the three largest CDS dealers: JP Morgan, Citibank, and Bank of America. We also include the corresponding autoregressive terms of the 20-, 60-, and 120-day log realized CDS return volatility (not reported). We split our sample into the pre-clearing period and the post-clearing period and show corresponding results in Panel A and Panel B. In parentheses, we display Newey-West standard errors.

Panel A: Pre-clearing							
	<i>Dependent variable:</i>						
	HSBC	WF	BC	DB	GS	UBS	CS
	(1)	(2)	(3)	(4)	(5)	(6)	(7)
bofa20	-0.0055 (0.0066)	0.0952 (0.0974)	0.0310 (0.0820)	0.0557 (0.0477)	0.0017 (0.0134)	0.0519 (0.0449)	0.0525 (0.0434)
bofa60	0.0464** (0.0188)	0.1165 (0.1508)	0.2704** (0.1242)	0.0499 (0.0712)	0.0073 (0.0232)	0.0400 (0.0644)	0.0418 (0.0631)
bofa120	-0.0475*** (0.0184)	-1.2944 (0.8979)	-0.9197** (0.4314)	-0.6134 (0.4614)	0.0081 (0.0392)	-0.5731 (0.4286)	-0.6037 (0.4363)
citi20	0.0022 (0.0018)	-0.0134 (0.0138)	0.0054 (0.0095)	-0.0049 (0.0070)	0.0010 (0.0009)	-0.0054 (0.0063)	-0.0065 (0.0066)
citi60	-0.0009 (0.0019)	0.0483 (0.0446)	0.0038 (0.0254)	0.0206 (0.0242)	-0.0007 (0.0014)	0.0206 (0.0217)	0.0219 (0.0219)
citi120	0.0003 (0.0019)	-0.0413 (0.0607)	-0.0061 (0.0356)	-0.0191 (0.0336)	-0.0026 (0.0034)	-0.0190 (0.0298)	-0.0198 (0.0304)
jpm20	-0.0263 (0.0222)	-0.3437 (0.3054)	-0.4667* (0.2402)	-0.1779 (0.1566)	-0.0314 (0.0419)	-0.1566 (0.1436)	-0.1495 (0.1433)
jpm60	0.0555 (0.0492)	0.0048 (0.4242)	0.3728 (0.3766)	-0.0560 (0.2166)	0.0537 (0.0696)	-0.0724 (0.1960)	-0.0570 (0.1704)
jpm120	-0.0924* (0.0500)	3.2464 (2.3915)	1.9577* (1.1366)	1.5906 (1.2358)	-0.0408 (0.0710)	1.5029 (1.1528)	1.5620 (1.1621)
Observations	3,508	3,508	3,508	3,508	3,508	3,508	3,508
Adjusted R ²	0.9808	0.9259	0.9391	0.9298	0.9417	0.9237	0.9270

Note:

*p<0.1; **p<0.05; ***p<0.01

Panel B: Post-clearing							
	<i>Dependent variable:</i>						
	HSBC	WF	BC	DB	GS	UBS	CS
	(1)	(2)	(3)	(4)	(5)	(6)	(7)
bofa20	0.0597 (0.0441)	0.1392* (0.0821)	-0.0334 (0.0578)	-0.0128 (0.0577)	-0.0025 (0.0227)	0.0026 (0.0515)	-0.0038 (0.0550)
bofa60	-0.1063 (0.0717)	-0.3107*** (0.1205)	-0.0382 (0.0494)	-0.0639 (0.0678)	-0.0512 (0.0342)	-0.0701 (0.0538)	-0.0807 (0.0553)
bofa120	0.1117 (0.0958)	0.1728* (0.0980)	-0.0269 (0.0528)	-0.0171 (0.0703)	0.0421 (0.0369)	0.0294 (0.0485)	0.0242 (0.0477)
citi20	-0.00004 (0.0002)	-0.0003 (0.0003)	-0.000001 (0.0003)	0.0001 (0.0002)	0.0002 (0.0005)	0.0001 (0.0002)	0.0001 (0.0002)
citi60	0.00002 (0.0009)	0.0002 (0.0010)	-0.0007 (0.0008)	-0.0003 (0.0009)	-0.0013** (0.0006)	-0.0003 (0.0006)	-0.0003 (0.0007)
citi120	-0.0015 (0.0016)	-0.0039 (0.0028)	0.0014 (0.0014)	0.0008 (0.0017)	0.0004 (0.0009)	-0.00001 (0.0014)	0.0001 (0.0014)
jpm20	-0.0981 (0.0886)	0.0002 (0.0951)	0.0284 (0.0937)	0.0388 (0.0941)	-0.0295 (0.0407)	0.0104 (0.0897)	0.0331 (0.0938)
jpm60	0.6793** (0.3376)	0.2886 (0.2018)	0.2569 (0.1750)	0.3156* (0.1847)	0.0929 (0.0689)	0.2671 (0.1768)	0.2793 (0.1818)
jpm120	-0.4333* (0.2279)	-0.3473 (0.2625)	0.0127 (0.1740)	-0.0481 (0.1845)	-0.0313 (0.0870)	-0.0563 (0.1596)	-0.0570 (0.1603)
Observations	3,063	3,063	3,063	3,063	3,063	3,063	3,063
Adjusted R ²	0.9057	0.8974	0.9129	0.9136	0.9172	0.9081	0.9093

Note:

*p<0.1; **p<0.05; ***p<0.01

Table 4.4.12: Diebold-Yilmaz spillover table (stock data)

This table shows spillover tables according to Diebold and Yilmaz (2012) based on our stock return (stock return volatility) event time series. The spillover tables are based upon a VAR model with a number of lags determined by the Akaike Information Criterion. The variance decomposition follows the framework of Koop et al. (1996) and Pesaran and Shin (1998). The individual cells provide an estimate for the contribution of dealer i's stock return (stock return volatility) innovations to the variance of dealer j's 20-day ahead stock return (stock return volatility) forecast error. Panel A (Panel B) shows spillover tables based on unweighted CDS returns for the pre-clearing period (post-clearing period). Panel C (Panel D) shows spillover tables based on unweighted CDS return volatilities for the pre-clearing period (post-clearing period).

Panel A: Stock return spillover (pre-clearing)

	JPM	CITI	BOFA	GS	HSBC	WF	BC	DB	UBS	CS	FROM
JPM	0.22	0.08	0.13	0.14	0.13	0.07	0.06	0.07	0.05	0.06	0.78
CITI	0.11	0.39	0.13	0.08	0.09	0.05	0.04	0.03	0.03	0.03	0.61
BOFA	0.17	0.11	0.30	0.08	0.11	0.07	0.06	0.04	0.03	0.03	0.70
GS	0.16	0.06	0.07	0.26	0.10	0.04	0.07	0.09	0.08	0.09	0.74
HSBC	0.14	0.08	0.09	0.10	0.06	0.09	0.05	0.08	0.06	0.06	0.73
WF	0.13	0.07	0.10	0.06	0.09	0.44	0.02	0.02	0.03	0.03	0.56
BC	0.07	0.04	0.05	0.08	0.08	0.00	0.26	0.15	0.12	0.14	0.74
DB	0.07	0.02	0.03	0.08	0.06	0.01	0.13	0.23	0.18	0.19	0.77
UBS	0.06	0.03	0.02	0.07	0.06	0.02	0.11	0.19	0.24	0.20	0.76
CS	0.06	0.02	0.02	0.08	0.06	0.02	0.13	0.19	0.19	0.23	0.77
NET	0.97	0.50	0.64	0.77	0.78	0.32	0.71	0.85	0.79	0.83	7.17
GROSS	1.20	0.89	0.94	1.03	1.05	0.76	0.97	1.08	1.02	1.07	10.00

Spillover Index (pre): 0.72

Panel B: Stock return spillover (post-clearing)

	JPM	CITI	BOFA	GS	HSBC	WF	BC	DB	UBS	CS	FROM
JPM	0.35	0.05	0.20	0.10	0.04	0.04	0.06	0.07	0.04	0.06	0.65
CITI	0.09	0.62	0.05	0.04	0.01	0.02	0.04	0.05	0.04	0.04	0.38
BOFA	0.19	0.03	0.33	0.06	0.10	0.04	0.07	0.08	0.05	0.06	0.67
GS	0.12	0.03	0.07	0.40	0.01	0.05	0.08	0.09	0.07	0.08	0.61
HSBC	0.04	0.01	0.12	0.01	0.39	0.06	0.10	0.10	0.09	0.09	0.61
WF	0.05	0.01	0.06	0.05	0.06	0.41	0.08	0.09	0.09	0.10	0.59
BC	0.04	0.02	0.05	0.05	0.06	0.05	0.25	0.16	0.16	0.16	0.75
DB	0.05	0.02	0.05	0.05	0.06	0.05	0.15	0.24	0.16	0.17	0.76
UBS	0.03	0.01	0.04	0.04	0.06	0.06	0.16	0.17	0.24	0.20	0.76
CS	0.04	0.02	0.04	0.05	0.05	0.05	0.15	0.17	0.19	0.24	0.76
NET	0.64	0.19	0.68	0.45	-3.10	-0.43	-1.35	0.96	0.90	0.95	6.53
GROSS	0.99	0.80	1.01	0.85	0.84	0.84	1.14	1.20	1.14	1.19	10.00

Spillover Index (post): 0.65

Panel C: Stock return volatility spillover (pre-clearing)

	JPM	CITI	BOFA	GS	HSBC	WF	BC	DB	UBS	CS	FROM
JPM	0.33	0.03	0.19	0.08	0.26	0.02	0.05	0.01	0.01	0.01	0.67
CITI	0.09	0.66	0.14	0.03	0.06	0.00	0.01	0.00	0.00	0.00	0.34
BOFA	0.27	0.04	0.34	0.10	0.19	0.01	0.04	0.01	0.00	0.00	0.66
GS	0.18	0.01	0.12	0.48	0.12	0.01	0.04	0.01	0.01	0.01	0.52
HSBC	0.25	0.06	0.17	0.06	0.32	0.03	0.05	0.02	0.02	0.02	0.68
WF	0.02	0.00	0.03	0.01	0.02	0.21	0.13	0.21	0.18	0.20	0.79
BC	0.08	0.01	0.08	0.03	0.07	0.13	0.18	0.15	0.13	0.14	0.82
DB	0.02	0.00	0.03	0.01	0.02	0.19	0.13	0.21	0.18	0.20	0.79
UBS	0.01	0.00	0.02	0.01	0.01	0.20	0.13	0.22	0.19	0.21	0.81
CS	0.01	0.00	0.02	0.01	0.01	0.20	0.13	0.22	0.19	0.21	0.79
NET	0.94	0.16	0.80	0.33	0.75	0.78	0.72	0.84	0.74	0.80	6.86
GROSS	1.27	0.83	1.14	0.81	1.07	0.99	0.90	1.05	0.93	1.01	10.00

Spillover Index (pre): 0.69

Panel D: Stock return volatility spillover (post-clearing)

	JPM	CITI	BOFA	GS	HSBC	WF	BC	DB	UBS	CS	FROM
JPM	0.62	0.00	0.20	0.11	0.00	0.01	0.02	0.02	0.01	0.01	0.38
CITI	0.00	0.99	0.00	0.00	0.00	0.00	0.00	0.00	0.00	0.00	0.01
BOFA	0.17	0.00	0.31	0.05	0.10	0.04	0.07	0.09	0.09	0.08	0.69
GS	0.06	0.00	0.06	0.54	0.04	0.03	0.05	0.07	0.07	0.08	0.46
HSBC	0.02	0.00	0.22	0.04	0.35	0.04	0.07	0.10	0.09	0.09	0.65
WF	0.03	0.00	0.07	0.03	0.04	0.31	0.10	0.13	0.15	0.14	0.69
BC	0.02	0.00	0.07	0.03	0.04	0.05	0.28	0.15	0.18	0.18	0.72
DB	0.03	0.00	0.08	0.05	0.05	0.07	0.13	0.22	0.19	0.19	0.78
UBS	0.02	0.00	0.08	0.04	0.05	0.07	0.15	0.18	0.21	0.20	0.79
CS	0.02	0.00	0.08	0.05	0.05	0.07	0.15	0.18	0.20	0.21	0.79
NET	0.37	0.00	0.86	0.39	0.37	0.38	0.73	0.93	0.97	0.98	5.97
GROSS	0.99	0.99	1.17	0.93	0.72	0.69	1.01	1.15	1.17	1.19	10.00

Spillover Index (post): 0.6

4.5 Summary and conclusion

We empirically study the effect of CDS central clearing on systemic risk in the CDS dealer network from the perspective of contagion risk. Our empirical results indicate that the introduction of central counterparties can reduce default risk dependence among the G14 dealers. The effect seems to be especially prevalent for the core of the CDS financial network. This is plausible since the dominant dealers have the largest CDS exposures and, therefore, are particularly relevant for the stability of the CDS financial network. Spillover effects from CDS dealers with high exposures to CDS dealers with low exposures may be reduced as well through the introduction of central clearing, although the effect is not consistent in all specifications. Furthermore, the default risk dependence between core and peripheral dealers does not seem to be particularly strong in bilaterally cleared markets. Contagion risk does not seem to be a relevant pricing component of CDS premia during our observation period. We find evidence that our results are not driven by a global trend of contagion risk decline among CDS dealers. Therefore, our results do not seem to be explainable to a significant extent by reverse causality. We also show that our results cannot represent the overall contagion risk among CDS dealers, but that the incorporation of the CDS dealers' market shares into our time series leads to substantially different results. Our results also largely hold when using stock data instead of CDS data.

This first empirical study on the effect of CDS central clearing on systemic risk may serve as starting point for future research. It may be interesting to test our methodology on other markets that experienced the introduction of central clearing, e.g. on the market for interest rate swaps. Furthermore, it would be interesting to challenge our findings by using other methodologies for the analysis of systemic risk and to focus especially on tail risks, e.g. with Copula models. Last, a structural model as theoretical support for the consistent empirical findings in this study may be insightful.

C Appendix to Chapter 4

CHAPTER 4. FIREWALL OR SUPERSPREADER? - CDS CENTRAL
CLEARING AND CONTAGION RISK WITHIN THE CDS DEALER
NETWORK

Figure C.1: Computation of CDS event time series

This figure illustrates the procedure for the creation of our time series that are centered around the introduction of central clearing on single-name CDS markets using the example of one dealer CDS return time series and three clearing eligibility dates. First, we collect all clearing eligibility dates and compute time series of daily distances to its specific clearing eligibility date for every clearing eligible CDS contract and every observation date. In order to compute the event-centered time series for the dealer's CDS return time series, we take the average CDS return over all identical clearing distances across all clearing eligible CDS contracts: the value of the first red-(blue-, green-) colored observation of the event-centered time series is computed as the average of all other red-(blue-, green-)colored observations in the original time series along calendar time as these observations match identical clearing distances across the three clearing eligible CDS contracts.

calendar time	jpm_cds_return	clearing distance	clearing distance	clearing distance	event time	jpm_cds_return (event-centered)
		cds_contract1 clearing date: 14.12.2009	cds_contract2 clearing date: 21.12.2009	cds_contract3 clearing date: 11.01.2010		
02.01.2009	-0,0388	-346	-353	-374	-346	0,0289
03.01.2009	0,0262	-345	-352	-373	-345	0,0244
04.01.2009	-0,0525	-344	-351	-372	-344	-0,0189
05.01.2009	-0,0231	-343	-350	-371	-343	...
06.01.2009	0,0628	-342	-349	-370	-342	...
07.01.2009	0,1005	-341	-348	-369	-341	...
08.01.2009	0,0342	-340	-347	-368	-340	...
09.01.2009	0,1302	-339	-346	-367	-339	...
10.01.2009	0,0346	-338	-345	-366	-338	...
11.01.2009	-0,0053	-337	-344	-365	-337	...
12.01.2009	-0,0534	-336	-343	-364	-336	...
13.01.2009	-0,0055	-335	-342	-363	-335	...
14.01.2009	0,0436	-334	-341	-362	-334	...
15.01.2009	0,0003	-333	-340	-361	-333	...
16.01.2009	-0,0255	-332	-339	-360	-332	...
17.01.2009	0,0132	-331	-338	-359	-331	...
18.01.2009	-0,0264	-330	-337	-358	-330	...
19.01.2009	-0,0502	-329	-336	-357	-329	...
20.01.2009	-0,1508	-328	-335	-356	-328	...
21.01.2009	0,0234	-327	-334	-355	-327	...
22.01.2009	0,0320	-326	-333	-354	-326	...
23.01.2009	0,0165	-325	-332	-353	-325	...
24.01.2009	-0,0067	-324	-331	-352	-324	...
25.01.2009	-0,0205	-323	-330	-351	-323	...
26.01.2009	-0,0236	-322	-329	-350	-322	...
27.01.2009	-0,0560	-321	-328	-349	-321	...
28.01.2009	-0,0163	-320	-327	-348	-320	...
29.01.2009	0,0082	-319	-326	-347	-319	...
30.01.2009	-0,0047	-318	-325	-346	-318	...
31.01.2009	0,0123	-317	-324	-345	-317	...
01.02.2009	0,0012	-316	-323	-344	-316	...
02.02.2009	0,0101	-315	-322	-343	-315	...
03.02.2009	0,0443	-314	-321	-342	-314	...
04.02.2009	0,1196	-313	-320	-341	-313	...
05.02.2009	0,0697	-312	-319	-340	-312	...

C. APPENDIX TO CHAPTER 4

Table C.1: Unit root tests on CDS return and CDS spread time series in event time

This table shows p-values for Augmented Dickey-Fuller unit root tests on time series of individual CDS dealers' CDS spreads in calendar time dimension (Panel A), average CDS returns and average CDS return correlations of different subsets of G14 dealers (Panel B), and for individual CDS dealers' CDS spreads in event time dimension (Panel C).

Panel A: CDS spreads (cal. time)		Panel B: CDS returns and correlations		Panel C: CDS spreads (event time)		
G14 time series	p value	Variables	p-value	G14 time series	pre	post
HSBC	0.18	cds_ret _{G14}	0.01	HSBC	0.05	0.60
BOFA	0.44	cds_ret _{G5}	0.01	BOFA	0.56	0.74
BNP	0.31	cds_ret _{peri}	0.01	BNP	0.31	0.71
WELLFA	0.01	ρ_{G14}	0.01	WELLFA	0.05	0.85
JPM	0.03	ρ_{G5}	0.01	JPM	0.02	0.25
SOCGEN	0.15	ρ_{peri}	0.01	SOCGEN	0.36	0.69
BARCLAYS	0.04	$\rho_{G5-peri}$	0.01	BARCLAYS	0.27	0.92
CINC	0.17			CINC	0.02	0.85
LCL	0.24			LCL	0.31	0.64
DB	0.05			DB	0.27	0.99
GS	0.01			GS	0.01	0.98
UBS	0.02			UBS	0.27	0.99
MS	0.01			MS	0.03	0.96
CRDSUI	0.09			CRDSUI	0.48	0.94

CHAPTER 4. FIREWALL OR SUPERSPREADER? - CDS CENTRAL
CLEARING AND CONTAGION RISK WITHIN THE CDS DEALER
NETWORK

5 Conclusion

Financial market regulation can have adverse effects on the behavior of individual market participants and on financial stability itself. Especially for activities like trading of OTC derivatives that include complex pricing and risk management of long-term financial contracts, the economic consequences of financial regulation are very likely to be two-sided. We examine the effects of central clearing on the CDS market in terms of netting efficiency, market liquidity and contagion risk in three empirical papers. Indeed, we do not find central clearing to affect these three aspects of financial stability exclusively positively or exclusively negatively and see our results as a call for a more market-specific regulation of financial markets.

In Chapter 2, we find netting efficiency to decrease with the introduction of central clearing. This is surprising as in most statements of regulators on the concept of central clearing, an increase in netting efficiency is usually mentioned as one of the top arguments for the introduction of CCPs. For voluntary central clearing regimes, this does not seem to be true. The negative effect of central clearing on netting efficiency is most pronounced for contracts that have the highest netting efficiency prior to the introduction of central clearing. This result provides empirical evidence in favor of a hypothesis shown by several theoretical papers without any empirical evidence so far. Furthermore, the effect of central clearing on the netting efficiency of centrally cleared contracts seems to increase the longer a contract is eligible for central clearing. Taking these findings together, our results imply that the CDS market was not suitable for a voluntary introduction of central clearing from the perspective of netting efficiency. In markets that are dominated by only few dealers, and which therefore exhibit a comparably high netting efficiency in a bilateral clearing regime, central clearing must be either mandated or foregone if netting efficiency is to be optimized. Consequently, our findings seem to imply a small probability that higher cleared trading volume (e.g. in a mandatory central clearing regime) may be able to eventually lead to a positive effect on netting efficiency. This question remains open for future research. These findings can be transferred to other OTC markets that are subject to voluntary central clearing. Our results recommend a more market-specific financial regulation that takes into account detailed characteristics of the market that is to be regulated.

In Chapter 3, I find central clearing to affect CDS market liquidity positively by decreasing bid-ask spreads and increasing gross trading volume. However, CDS dealers seem to provide market liquidity less continuously after central clearing is introduced. Contracts with high liquidity risks, in terms of high bid-ask spreads and low trading volume, seem to benefit more from central clearing eligibility than low-risk contracts. I find evidence that the positive liquidity effects are mediated by lower counterparty risk and lower regulatory capital charges for centrally cleared positions. Decreasing bid-ask spreads and increasing gross trading volume point strongly to increasing dealer competition as already found in previous studies (Slive et al., 2012; Loon and Zhong, 2014; Mayordomo and Posch, 2016). Central clearing seems to erase low counterparty risk as a competitive advantage. The findings in this study on counterparty risk as an economic channel for positive market liquidity effects of central clearing support this hypothesis even further. I find evidence for lower regulatory capital charges for centrally cleared trades of increasing the inventory risk-taking capacity of CDS dealers after the beginning of central clearing eligibility. Referring back to Chapter 2, this result may also explain the increase in CDS gross positions and decrease in netting efficiency. Lower inventory costs may allow dealers to increase competition and to compensate lower profits per trade due to smaller bid-ask spreads by increasing gross trading volume.

In Chapter 4, we find contagion risk to decrease from the pre-clearing period to the post-clearing period quite consistently across different time series methodologies. After many publications on the optimal design of the different default waterfall resource layers of CCPs, this study finally provides empirical evidence with market-based data as to whether the default waterfall of CDS clearing CCPs is adequately capitalized. However, contagion risk does not seem to affect the pricing behavior of CDS market participants. This raises the question whether a CCP on the CDS market is actually necessary from the perspective of contagion risk. Although CDS have been widely blamed in public media for having caused the financial crisis, economists have been skeptical about it as CDS had rather worked as a vehicle for securitizing subprime mortgages which in turn could be well considered as the cause of the global financial crisis (Stulz, 2010). The CDS market itself remained quite liquid during the crisis and the net exchange of cash as a result of the auction of Lehman Brother's default portfolio was moderate because most clients were buyers and sellers to Lehman Brothers. However, a CCP can decrease contagion risk by preventing the rise of excessive net sellers of CDS protection (see the AIG case in the global financial crisis 2007/2008) through superlinear margining of growing

CDS portfolios. In this case, increasing transparency through mandated CDS trade reporting would be sufficient from the perspective of contagion risk. Whether the effect of central clearing on systemic risk is the direct result of the CCP's sufficient capital resources, or if it is attributable to the prevention of heavy protection sellers by the CCP, remains a question for future research.

The second contribution of this study is to open up a new way of analyzing financial network dynamics in the context of contagion risk using plain time series methodologies. By incorporating the time-varying market dominance of the individual financial network participants into our original dataset, we are able to reflect the financial network dynamics in our time series. Additionally, we compute new time series with observations that represent trading days in event time. The results make us confident that these new time series are fundamentally different compared to our original time series in calendar time. It seems that global time trends do not introduce a major bias into the event time series, and that the new time series indeed seems to capture the contagion risk that arises specifically from the CDS market. It would be important to test this procedure with more accurate data on the market shares of CDS market participants that is not restricted to the US and that is available at a higher observation frequency. Furthermore, a structural model may be helpful to connect this empirical procedure more closely with statistical theory.

This thesis provides evidence on the multi-faceted effects of voluntary central clearing introduction on counterparty risk, market liquidity and systemic risk of over-the-counter markets. The results can be helpful in guiding the next steps of the introduction of central clearing on OTC derivatives markets and to base them on robust empirical evidence.

Bibliography

- V. Acharya and A. Bisin. Counterparty risk externality: Centralized versus over-the-counter markets. *Journal of Economic Theory*, 149:153–182, 2014.
- J. Aitken and M. Singh. Counterparty risk, impact on collateral flows and role for central counterparties. IMF Working Paper, 2009.
- M. Aitken, H. Chen, and S. Foley. The impact of fragmentation, exchange fees and liquidity provision on market quality. *Journal of Empirical Finance*, 41:140–160, 2017.
- M.-A. Akari, R. Ben-Abdullah, M. Breton, and G. Dionne. The impact of central clearing on the market for single-name credit default swaps. *ICD Working Paper*, 18(03), 2019.
- I. Aldasoro and T. Ehlers. The credit default swap market: what a difference a decade makes. *BIS Quarterly Review*, June 2018.
- F. Allen and D. Gale. Financial contagion. *Journal of Political Economy*, 108(1): 1–33, 2000.
- T. G. Andersen, T. Bollerslev, F. X. Diebold, and H. Ebens. The distribution of realized stock return volatility. *Journal of Financial Economics*, 61(1):43–76, 2001.
- T. G. Andersen, T. Bollerslev, F. X. Diebold, and P. Labys. Modeling and forecasting realized volatility. *Econometrica*, 71(2):579–625, 2003.
- S. Anderson, Jean-Philippe Dion, and Hector Perez Saiz. To link or not to link? netting and exposures between central counterparties. *Journal of Financial Market Infrastructure*, 1(4):3–29, 2013.
- A. Arakelyan and P. Serrano. Liquidity in credit default swap markets. *Journal of Multinational Financial Management*, 37:139–157, 2016.
- M. Arellano. Computing robust standard errors for within-groups estimators. *Oxford Bulletin of Economics and Statistics*, 49:431–434, 1987.

BIBLIOGRAPHY

- A. Armakola and J.-P. Laurent. Ccp resilience and clearing membership. Working Paper, 2015.
- N. Arora, P. Gandhi, and F. A. Longstaff. Counterparty credit risk and the credit default swap market. *Journal of Financial Economics*, 103(2):280–293, 2012.
- P. Asquith, T. R. Covert, and P. A. Pathak. The effects of mandatory transparency in financial market design: Evidence from the corporate bond market. *NBER Working Paper*, (19417), 2019.
- M. Avellaneda and R. Cont. Close-out risk evaluation (core): A new risk-management approach for central counterparties. Finance Concepts Working Paper, 2013.
- A. Babus. The formation of financial networks. FEEM Working Paper, 2007.
- H. Baer, V. G. France, and J. T. Moser. Opportunity cost and prudence: an analysis of collateral decisions in bilateral and multilateral settings. *Research in Finance*, 21:201–227, 2004.
- R. Barker, A. Dickinson, A. Lipton, and R. Virmani. Systemic risks in ccp networks. Working Paper, 2016.
- Basel Committee on Banking Supervision. Capital requirements for bank exposures to central counterparties, 2014.
- S. Battiston and G. Caldarelli. Systemic risk in financial networks. *Journal of Financial Management, Markets and Institutions*, 1(2):129–154, 2013.
- S. Battiston, D. Delli Gatti, M. Gallegati, B. Greenwald, and J. E. Stiglitz. Default cascades: When does risk diversification increase stability? *Journal of Financial Stability*, (8):138–149, 2012.
- M. Bellia, R. Panzica, L. Pelizzon, and T. A. Peltonen. The demand for central clearing: To clear or not to clear, that is the question. *SAFE Working Paper*, (193), 2018.
- A. Bernstein, E. Hughson, and M. Weidenmier. Counterparty risk and the establishment of the new york stock exchange clearinghouse. *Journal of Political Economy*, 127(2):689–729, 2019.

BIBLIOGRAPHY

- H. Bessembinder and W. Maxwell. Transparency and the corporate bond market. *Journal of Economic Perspectives*, 22(2):217–234, 2008.
- H. Bessembinder, W. Maxwell, and K. Venkataraman. Market transparency, liquidity externalities, and institutional trading costs in corporate bonds. *Journal of Financial Economics*, 82(2):251–288, 2006.
- T. R. Bielecki, I. Cialenco, and S. Feng. A dynamic model of central counterparty risk. Working Paper, 2018.
- J. R. Black, D. Stock, and P. K. Yadav. The pricing of different dimensions of liquidity: Evidence from government guaranteed bonds. *Journal of Banking and Finance*, 71:119–132, 2016.
- R. Blanco, S. Brennan, and I. W. Marsh. An empirical analysis of the dynamic relation between investment-grade bonds and credit default swaps. *Journal of Finance*, 60(5):2255–2281, 2005.
- R. Bloomfield and M O’Hara. Market transparency: Who wins and who loses? *Review of Financial Studies*, 12(1):5–35, 1999.
- D. Bongaerts, F. De Jong, and J. Driessen. Derivative pricing with liquidity risk: Theory and evidence from the credit default swap market. *Journal of Finance*, 65(1):203–240, 2011.
- S. Borovkova and H. L. El Mouttalibi. Systemic risk and centralized clearing of otc derivatives: A network approach. Working Paper, 2013.
- O. Briukhova, M. D’Errico, and S. Battiston. Reshaping the financial network: Externalities of central clearing and systemic risk. Working Paper, 2019.
- P. Brockman and D. Y. Chung. Bid-ask spread components in an order-driven environment. *Journal of Financial Research*, 22(2):227–246, 1999.
- M. Brunnermeier, L. Clerc, Y. El Oman, S. Gabrieli, S. Kern, C. Memmel, T. Peltonen, N. Podlich, M. Scheicher, and G. Vuillemeier. Assessing contagion risks from the cds market. *ESRB Occasional Paper Series*, (4), 2013.
- Markus K. Brunnermeier and Lasse Heje Pedersen. Market liquidity and funding liquidity. *Review of Financial Studies*, 22(6):2201–2238, 2009. ISSN 0893-9454. doi: 10.1093/rfs/hhn098.

BIBLIOGRAPHY

- W. Buehler and M. Trapp. Time-varying credit risk and liquidity premia in bond and cds markets. Centre of Financial Research Working Paper, 2014.
- H. Byström. The market's view on the probability of banking sector failure: Cross-country comparisons. *Journal of International Financial Markets, Institutions and Money*, 14(5):419–438, 2004.
- S. Calonico, M. D. Cattaneo, and R. Titiunik. Robust nonparametric confidence intervals for regression discontinuity analysis. *Econometrica*, 82(6):2295–2326, 2014.
- S. Calonico, M. D. Cattaneo, and M. H. Farrell. Optimal bandwidth choice for robust bias corrected inference in regression discontinuity designs. *The Econometrics Journal*, pages 1–20, 2020.
- A. Capponi, W. A. Cheng, S. Giglio, and R. Haynes. The collateral rule: An empirical analysis of the cds market. Working Paper, 2017.
- A. Capponi, J. J. Wang, and H. Zhang. Central clearing and the sizing of default funds. Working Paper, 2019.
- P. Carr and V. Linetsky. A jump to default extended cev model: an application of besse processes. *Finance and Stochastics*, 10(3):303–330, 2006.
- P. Carr and D. Medan. Local volatility enhanced by a jump to default. *Journal of Financial Mathematics*, 1(1):2–15, 2010.
- P. Carr and L. Wu. Stock options and credit default swaps: a joint framework for valuation and estimation. *Journal of Financial Econometrics*, 8(1):1–41, 2009.
- K. Choi, W.-C. Yu, and E. Zivot. Long memory versus structural breaks in modeling and forecasting realized volatility. *Journal of International and Money and Finance*, 29(5):857–875, 2010.
- R. Y. Chou, V. K. Ng, and K. Lynn. Cointegration of international stock market indices. IMF Working Paper, 1994.
- A. Clare and R. Priestley. Calculating the probability of failure of the norwegian banking sector. *Journal of Multinational Financial Management*, (12):21–40, 2002.

BIBLIOGRAPHY

- P. Collin-Dufresne, B. Junge, and A. B. Trolle. Market structure and transaction costs of index cds. *Working paper*, 2018.
- R. Cont and A. Moussa. Too interconnected to fail: contagion and systemic risk in financial networks. Columbia University Financial Engineering Report, 2010.
- R. Cont, A. Moussa, and E. Bastos e Santos. Network structure and systemic risk in banking systems. Working Paper, 2012.
- Rama Cont and Thomas Kokholm. Central clearing of otc derivatives: Bilateral vs multilateral netting. *Statistics & Risk Modeling*, 31(1), 2014. ISSN 2193-1402. doi: 10.1515/strm-2013-1161. URL <http://arxiv.org/pdf/1304.5065v1>.
- F. Corsi. A simple approximate long-memory model of realized volatility. *Journal of Financial Economics*, 7(2):174–196, 2009.
- Virginie Coudert and Mathieu Gex. Credit default swap and bond markets: which leads the other? *Financial Stability Review*, (14):161–167, 2010.
- Nathanael Cox, Nicholas Garvin, and Gerard Kelly. Central counterparty links and clearing system exposures. *Research Bank of Australia discussion paper*, (12), 2013.
- F. Cumming and J. Noss. Assessing the adequacy of ccps’ default resources. Bank of England Financial Stability Paper, 2013.
- J. D. Cummins and M. A. Weiss. Systemic risk and the u.s. insurance sector. *The Journal of Risk and Insurance*, 81(3):481–527, 2014.
- M. Davison, D. Leadbetter, B. Lu, and J. Voll. Are counterparty arrangements in reinsurance a threat to financial stability. *Bank of Canada Staff Working Paper*, (2016-39), 2016.
- H. Degryse, M. van Achter, and G. Wuyts. Plumbing of securites markets: The impact of post-trade fees on trading and welfare. 2016. URL <http://dx.doi.org/10.2139/ssrn.2023597>.
- H. Degryse, J. Mendoza, and G. Wuyts. The impact of clearing fees on market quality. Working paper, 2017.
- H. Demsetz. The cost of transacting. *The Quarterly Journal of Economics*, 1968.

BIBLIOGRAPHY

- M. Di Maggio, A. Kermani, and Z. Song. The value of trading relations in turbulent times. *Journal of Financial Economics*, 124(2):266–284, 2017.
- J. Dick-Nielsen. Liquidity biases in trace. *Journal of Fixed Income*, 19(2):43–55, 2009.
- J. Dick-Nielsen. How to clean enhanced trace data. 2014. URL <https://ssrn.com/abstract=2337908>.
- F. Diebold and K. Yilmaz. Measuring financial asset return and volatility spillovers, with application to global equity markets. *Economic Journal*, 119:158–171, 2009.
- F. X. Diebold and K. Yilmaz. Better to give than to receive: Predictive directional measurement of volatility spillovers. *International Journal of Forecasting*, 28:57–66, 2012.
- I. Domowitz, J. Glen, and A. Madhavan. Liquidity, volatility and equity trading costs across countries and over time. *International Finance*, 4(2):221–255, 2001.
- DTCC. Dtc cds kinetics, 2019. URL <https://www.dtccdata.com/products/cds-kinetics>.
- W. Du, S. Gadgil, M. B. Gordy, and C. Vega. Counterparty risk and counterparty choice in the credit default swap market. 2019.
- D. Duffie, N. Gârleanu, and L. H. Pedersen. Over-the-counter markets. *Econometrica*, 73:1815–1847, 2005.
- D. Duffie, M. Scheicher, and G. Vuillemeys. Central clearing and collateral demand. *Journal of Financial Economics*, 116(2):237–256, 2015.
- Darrell Duffie and Haoxiang Zhu. Does a central clearing counterparty reduce counterparty risk? *Review of Asset Pricing Studies*, 1(1):74–95, 2011. ISSN 2045-9920. doi: 10.1093/rapstu/rar001.
- D. Easley and M. O’Hara. Price, trade size, and information in securities markets. *Journal of Financial Economics*, 19(1):69–90, 1987.
- A. K. Edwards, L. E. Harris, and M. S. Piwowar. Corporate bond market transaction costs and transparency. *Journal of Finance*, 62(3):1421–1451, 2007.
- L. Eisenberg and T. H. Noe. Systemic risk in financial systems. *Management Science*, 47(2):236–249, 2001.

BIBLIOGRAPHY

- A. L. Eisfeldt, B. Herskovic, S. Rajan, and E. Siriwardane. Otc intermediaries. OFR Working Paper, 2018.
- K. J. Forbes and R. Rigobon. No contagion, only interdependence: measuring stock market comovements. *Journal of Finance*, 57(5):2223–2261, 2002.
- S. Forte and J. I. Peña. Credit spreads: An empirical analysis on the informational content of stocks, bonds, and cds. *Journal of Banking & Finance*, 33:2013–2025, 2009.
- M. Galbiati and K. Soramäki. Clearing networks. *Journal of Economic Behavior & Organization*, 83(3):609–626, 2012.
- Rodney Garratt and Peter Zimmerman. Centralized netting in financial networks. *Journal of Banking & Finance*, 2017. ISSN 0378-4266. doi: <https://doi.org/10.1016/j.jbankfin.2017.12.008>. URL <http://www.sciencedirect.com/science/article/pii/S0378426617302959>.
- M. Gehde-Trapp, Y. Gündüz, and J. Nasev. The liquidity premium in cds transaction prices: Do frictions matter? *Journal of Banking & Finance*, 61:184–205, 2015.
- A. Gelman and G. Imbens. Why high-order polynomials should not be used in regression discontinuity designs. *Journal of Business & Economic Statistics*, 2017.
- R. G. Gelos and R. Sahay. Financial market spillovers in transition economies. *Economics of Transition*, 9(1):53–86, 2001.
- S. Ghamami and P. Glasserman. Does otc derivatives reform incentivize central clearing? OFR Working Paper, 2016.
- P. Glasserman, C. C. Moallemi, and K. Yuan. Hidden illiquidity with multiple central counterparties. OFR Working Paper, 2015.
- L. R. Glosten and L. E. Harris. Estimating the components of the bid/ask spread. *Journal of Financial Economics*, 21:123–142, 1988.
- L. R. Glosten and P. R. Milgrom. Bid, ask and transaction prices in a specialist market with heterogeneously informed traders. *Journal of Financial Economics*, 14(1):71–100, 1985.

BIBLIOGRAPHY

- M. A. Goldstein, E. S. Hotchkiss, and E. R. Sirri. Transparency and liquidity: A controlled experiment on corporate bonds. *Review of Financial Studies*, 20(2): 235–273, 2007.
- D. Gray. Financial contagion among members of the eu-8 - a cointegration and granger causality approach. *International Journal of Emerging Markets*, 4(4): 299–314, 2009.
- P. Haene and A. Sturm. Optimal central counterparty risk management. Swiss National Bank Working Paper, 2009.
- J. Hansen and A. Moore. The efficiency of central clearing: A segmented markets approach. RBA Research Discussion Paper, 2016.
- I. Hasan and D. Wu. How large banks use cds to manage risk: Bank-firm-level evidence. Bank of Finland Research Discussion Paper, 2016.
- C. Hausman and D. S. Rapson. Regression discontinuity in time: Considerations for empirical applications. *Annual Review of Resource Economics*, 10:533–552, 2018.
- H. Hayakawa. Does a central clearing counterparty reduce liquidity needs? *Journal of Economic Interaction and Coordination*, 13(1):9–50, 2018.
- A. Heath, G. Kelly, and M. Manning. Otc derivatives reform: Netting and networks. *Journal of Financial Stability*, 27:217–233, 2016.
- Daniel Heller and Nicholas Vause. Collateral requirements for mandatory central clearing of over-the-counter derivatives, march 2012, 2012.
- T. Hendershott, D. Li, D. Livdan, and N. Schürhoff. Relationship trading in otc markets. Swiss Finance Institute Research Paper, 2017.
- B. Hollifield, A. Neklyudov, and C. Spatt. Bid-ask spreads, trading networks and the pricing of securitizations. *Review of Financial Studies*, 30:3048–3085, 2017.
- R. D. Huang and H. R. Stoll. The components of the bid-ask spread: A general approach. *The Review of Financial Studies*, 10(4):995–1034, 1997.
- W. Huang. Central counterparty capitalization and misaligned incentives. BIS Working Paper, 2019.
- D. Iercosan and A. A. Jiron. The value of trading relationships and networks in the cds market. Working paper, 2017.

BIBLIOGRAPHY

- G. Imbens and K. Kalyanaraman. Optimal bandwidth choice for the regression discontinuity estimator. *The Review of Economic Studies*, 79(3):933–959, 2012.
- J. P. Jackson and M. J. Manning. Comparing the pre-settlement risk implications of alternative clearing arrangements. Bank of England Working Paper, 2007.
- R. A. Jarrow and F. Yu. Counterparty risk and the pricing of defaultable securities. *Journal of Finance*, 56(5):1765–1799, 2001.
- S. Johansen. Estimation and hypothesis testing of cointegration vectors in gaussian vector autoregressive models. *Econometrica*, 59(6):1551–1580, 1991.
- R. C. Jung and R. Maderitsch. Structural breaks in volatility spillovers between international financial stock markets: Contagion or mere interdependence? *Journal of Banking and Finance*, 47:331–342, 2014.
- K. Kasa. Common stochastic trends in international stock markets. *Journal of Monetary Economics*, 29:95–124, 1992.
- O. Kaya. Cds spreads in the aftermath of central clearing. *International Journal of Financial Markets and Derivatives*, 6(2):75–101, 2016.
- A. Kempf, D. Mayston, M. Gehde-Trapp, and P. K. Yadav. Resiliency: A dynamic view of liquidity. 2015.
- C. Kenyon and A. D. Green. Cds pricing under basel iii: Capital relief and default protection. 2012. URL <https://ssrn.com/abstract=2181289>.
- R. Kissell. *The Science of Algorithmic Trading and Portfolio Management*. Academic Press, 2014.
- S. Klingler and D. Lando. Safe haven cds premiums. *The Review of Financial Studies*, 31(5):1856–1895, 2018.
- G. Koop, M. H. Pesaran, and S. M. Potter. Impulse response analysis in non-linear multivariate models. *Journal of Econometrics*, 74:119–147, 1996.
- H. Kraft and M. Steffensen. Bankruptcy, counterparty risk, and contagion. *Review of Finance*, 11(2):209–252, 2007.
- S. Kroon and I. van Lelyveld. Counterparty credit risk and the effectiveness of banking regulation. DNB Working Paper, 2018.

BIBLIOGRAPHY

- A. S. Kyle. Continuous auctions and insider trading. *Econometrica*, 53(6):1315–1335, 1985.
- A. Levels, R. de Sousa von Stralen, S. Kroon Petrescu, and I. van Lelyveld. Cds market structure and risk flows: the dutch case. *DNB Working Paper*, (592), 2018.
- O. Lewandowska. Otc clearing arrangements for bank systemic risk regulation: A simulation approach. *Journal of Money, Credit and Banking*, 47(6):1177–1203, 2015.
- D. Li and N. Schürhoff. Dealer networks. *Journal of Finance*, 74(1):91–144, 2019.
- H. Lin, S. Liu, and C. Wu. Dissecting corporate bond and cds spreads. *Journal of Fixed Income*, 20(3):7–39, 2011.
- J.-C. Lin, G. C. Sanger, and G. G. Booth. Trade size and components of the bid-ask spread. *The Review of Financial Studies*, 8(4):1153–1183, 1995.
- Y. Lin. Does greater market transparency reduce information asymmetry? *Emerging Markets Finance and Trade*, 52(11):2565–2584, 2016.
- Yee Cheng Loon and Zhaodong Zhong. Does dodd-frank affect otc transaction costs and liquidity? evidence from real-time cds trade reports. *Journal of Financial Economics*, 119(3):645–672, 2016. doi: 10.1016/j.jfineco.2016.01.019.
- Yee Cheng Loon and Zhaodong Ken Zhong. The impact of central clearing on counterparty risk, liquidity, and trading: Evidence from the credit default swap market. *Journal of Financial Economics*, 112(1):91–115, 2014. doi: 10.1016/j.jfineco.2013.12.001.
- R. Lyons. Optimal transparency in a dealership market with an application to foreign exchange. *Journal of Financial Intermediation*, 5:225–254, 1996.
- G. S. Maddala and S. Wu. A comparative study of unit root tests with panel data and a new simple test. *Oxford Bulletin of Economics and Statistics*, special issue 0305-9049:631–652, 1999.
- S. Markose, S. Giansante, and A. R. Shaghghi. Too interconnected to fail’ financial network of us cds market: Topological fragility and systemic risk. *Journal of Economic Behavior Organization*, 83:627–646, 2012.

BIBLIOGRAPHY

- S. Mayordomo and P. N. Posch. Does central clearing benefit risky dealers? *Journal of International Financial Markets, Institutions & Money*, 42:91–100, 2016.
- Albert J. Menkveld, Emiliano Pagnotta, and Marius A. Zoican. Does central clearing affect price stability? evidence from nordic equity markets. 2015. URL <https://ssrn.com/abstract=2350762>.
- R. C. Merton. Theory of rational option pricing. *Bell Journal of Economics and Management Science*, 4(1):141–183, 1973.
- R. C. Merton. On the pricing of corporate debt: the risk structure of interest rates. *Journal of Finance*, 29(2):449–470, 1974.
- B. Minton, R. Stulz, and R. Williamson. How much do banks use credit derivatives to hedge loans? *Journal of Financial Services Research*, 35(1):1–31, 2009.
- J. Molloy. Effect of central clearing on counterparty risk, liquidity and other determinants of corporate credit default swaps. 2018.
- Stefan Morkoetter, Johanna Pleus, and Simone Westerfeld. The impact of counterparty risk on credit default swap pricing dynamics. *The Journal of Credit Risk*, 8(1):63–88, 2012. ISSN 17446619. doi: 10.21314/JCR.2012.136.
- D. Murphy and P. Nahai-Williamson. Dear prudence, won't you come out to play? approaches to the analysis of central counterparty default fund adequacy. Bank of England Financial Stability Paper, 2014.
- S. Nickell. Biases in dynamic models with fixed effects. *Econometrica*, 49(6):1417–1426, 1981.
- E. Nier, J. Yang, T. Yorulmazer, and A. Alentorn. Network models and financial stability. *Journal of Economic Dynamics and Control*, 31(6):2033–2060, 2007.
- L. Norden and M. Weber. Informational efficiency of credit default swap and stock markets: The impact of credit rating announcements. *Journal of Banking & Finance*, 28:2813–2843, 2004.
- Martin Oehmke and Adam Zawadowski. The anatomy of the cds market. *Review of Financial Studies*, 30(1):80–119, 2017. ISSN 0893-9454. doi: 10.1093/rfs/hhw068.
- Office of the Comptroller of the Currency. Quarterly report on bank trading and derivatives activities – fourth quarter 2015, 2016. Washington D. C.

BIBLIOGRAPHY

- Maureen O'Hara. *Market Microstructure Theory*. Wiley, 1998.
- M. Paddrik and H. P. Young. How safe are central counterparties in credit default swap markets? Working Paper, 2019.
- M. Pagano and A. Roell. Transparency and liquidity: A comparison of auction and dealer markets with informed trading. *Journal of Finance*, 51(2):579–611, 1996.
- S. C. Park and X. Xie. Reinsurance and systemic risk: The impact of reinsurance downgrading on property-casualty insurers. *The Journal of Risk and Insurance*, 81(3):587–621, 2014.
- Tuomas A. Peltonen, Martin Scheicher, and Guillaume Vuillemeys. The network structure of the cds market and its determinants. *Journal of Financial Stability*, 13:118–133, 2014. ISSN 15723089. doi: 10.1016/j.jfs.2014.05.004.
- M. H. Pesaran and Y. Shin. Generalized impulse response analysis in linear multivariate models. *Economic Letters*, 58:17–29, 1998.
- J. Qiu and F. Yu. Endogenous liquidity in credit derivatives. *Journal of Financial Economics*, 103:611–631, 2012.
- K. Schweikert. Bootstrap confidence intervals and hypothesis testing for market information shares. *Journal of Financial Economics*, November 2019.
- Or Shachar. Exposing the exposed: Intermediation capacity in the credit default swap market, 2012.
- S. C. Shan, D. Y. Tang, and H. Yan. Credit default swaps and bank regulatory capital. HKIMR Working Paper, 2017.
- Q. Shang, M. Mallory, and P. Garcia. The components of the bid-ask spread: Evidence from the corn futures market. *Agricultural Economics*, 49:381–393, 2018.
- C. Sidanius and F. Zikes. Otc derivatives reform and collateral demand impact. *Financial Stability Paper*, 18-2012, 2012.
- P. Silva, P., C. Vieira, and I. Vieira. Central clearing and cds market quality. *Journal of Futures Markets*, 38(6):731–753, 2018.
- M. Singh. Collateral, netting and systemic risk on the otc derivatives markets. IMF Working Paper, 2010.

BIBLIOGRAPHY

- S. Üslü. Pricing and liquidity in decentralized asset markets. Working paper, 2019. URL <https://ssrn.com/abstract=2841919>.
- Joshua Slive, Jonathan Witmer, and Elizabeth Woodman. Liquidity and central clearing: Evidence from the cds market. Bank of Canada Staff Working Paper, 2012.
- H. R. Stoll. Inferring the components of the bid-ask spread: Theory and empirical tests. *Journal of Finance*, 44(1):115–134, 1989.
- R. M. Stulz. Credit default swaps and the credit crisis. *Journal of Economic Perspectives*, 24(1):73–92, 2010.
- D. Y. Tang and H. Yan. Liquidity, liquidity spillover and credit default swap spreads. Working paper, 2007.
- M. Trapp. *Credit Risk and Liquidity in Bond and CDS Markets*. phdthesis, 2008.
- I. van Lelyveld, F. Liedorp, and M. Kampman. An empirical assessment of reinsurance risk. *Journal of Financial Stability*, 7:191–203, 2011.
- M. Vassalou and Y. Xing. Default risk in equity returns. *Journal of Finance*, 59(2): 831–868, 2004.
- G. H. K. Wang and J. Yau. Trading volume, bid–ask spread, and price volatility in futures markets. *Journal of Futures Markets*, 20(10):943–970, 2000.
- M. Woolridge, J. *Econometric Analysis of Cross Section and Panel Data*. MA: MIT Press, 2002.
- T. Yorulmazer. Has financial innovation made the world riskier? cds, regulatory arbitrage and systemic risk. Working paper, 2013. URL <https://ssrn.com/abstract=2176493>.
- E. Özen, Ö. Letife, S. Grima, and F Bezzina. Investigating causality effects in return volatility among five major futures markets in european countries with a mediterranean connection. *Journal of Financial Management, Markets and Institutions*, 2(2):207–220, 2014.
- H. Zhu. An empirical comparison of credit spreads between the bond market and the credit default swap market. *Journal of Financial Services Research*, 29(3): 211–235, 2006.

BIBLIOGRAPHY

S. Zhu. Is there a 'race to the bottom' in central counterparties competition? Netherlands Central Bank Working Paper, 2011.