

DIFFERENTIAL OBJECT MARKING AND DATIVES IN BASQUE SYNTAX

AUTHOR: Ane Odria Tudanca

THESIS SUPERVISOR: Beatriz Fernández Fernández

2017

University of the Basque Country (UPV/EHU)



DIFFERENTIAL OBJECT MARKING AND DATIVES IN BASQUE SYNTAX

Ane Odria Tudanca

2017

Abstract

In this dissertation, I analyze the *Differential Object Marking* (DOM) attested in certain southwestern Basque varieties, where human and definite objects –specially those of first and second person– tend to bear dative marking instead of the canonical absolutive. Given the morphological identity shared by DOM and the rest of dative arguments, the syntax of causee, experiencer, goal and possessor datives is also examined in this piece of work. Due to their ability to license depictive secondary predication –which is shown to be incompatible with PPs and PP-like datives, I argue that DOM objects enter the derivation as DPs. Besides, as the PCC –which restricts the Agree relations with v – affects the licensing of these non-canonical objects in the same way as it does with canonical absolutives, I claim that DOM objects are equally Case licensed by v . As expected by their original DP categorical status, I show that the PCC is generally unable to be repaired by leaving DOM objects as PPs, without agreeing with the finite verbal form. Moreover, I put forth that the dative Case in DOM objects arises as a consequence of the *Derivational Distinctness Condition* (Richards 2010), which bans the linearization of identical elements that are in an asymmetric c-command relation. With the aim at satisfying such condition, a phasal K head –i.e., the differential marking– is added to the human and definite object when this coincides with a transitive subject in the v P phase domain, allowing each of the arguments to be linearized in a separate *Spell-Out* domain. Hence, the addition of K makes DOM objects different from absolutive objects, and assimilates them to the rest of dative arguments, including causees, experiencers, goals and possessors. Concerning the categorical as well as configurational origin of these datives, I state that while causees, experiencers and possessors are generated as DPs in [Spec, ApplP], goals enter the derivation as PP complements of V, and acquire a DP categorical status after undergoing P-incorporation and further movement to [Spec, ApplP]. Once in that position, all of them receive inherent dative Case from Appl and, due to Case opacity, enter into a defective Agree relation with v . The PP source of goal datives is mainly supported by (i) the inability to license depictive secondary predication and (ii) the availability to occur as non-agreeing PPs in PCC-affected contexts as well as ditransitive causative constructions. Contrary to goals, causee, experiencer and possessor datives are instead able to control this kind of predication and, as expected by their DP source, are generally unable to occur as current PPs in the mentioned contexts. As a consequence, I show that DOM objects are only compatible with goal datives that, by resorting to the PP repair strategy, occur as current PPs.

Acknowledgements

It is time to conclude this work. It has been a long way, but thanks to the people I have had around me, I have finally reached the end! I have been helped along by many people, and I would like to thank them all.

First of all, I would like to mention my supervisor Beatriz Fernández. Beatriz has put all her confidence on me from the very beginning, and even in the hardest moments, has known, as the best coaches do, how to bring out the best of myself, encourage me, clam me, and whenever it has been necessary, give me a break. Thank you very-very much, Beatriz, for all you have given me in all these years.

I am also grateful to Javier Ormazabal, with whom I have not only gained knowledge about linguistics and syntax, but, above all, I have learnt to enjoy and to laugh (loudly!) with linguistics and syntax, and I am thankful for it. It has been a pleasure working with you, Javi!

A special mention to Ane Berro. Ane has often listened to and eased my doubts. She helped me not to get lost along the way, and to get back to the right path, too. And above all, Ane made me believe that it was possible. My most sincere thanks, Ane!

I owe a particular thank to all the professors and researchers from UPV/EHU and CNRS-IKER, who offered to help me endless times. Thank you very much Pablo Albizu, Ricardo Etxepare, Beñat Oyharçabal, Anna Pineda, Milan Rezac, Esther Torrego and Myriam Uribe-Etxebarria. Every comment and suggestion you made was rewarding for me.

I would also like to thank the rest of professors at the Linguistics and Basque Studies Department for sparking my interest in language(s) and the Basque language. I had such wonderful professors and mates in Gasteiz. Thank you everyone!

Thank you very much as well to all the colleagues at the Department of Language and Literature Didactics, for being so generous with me, for giving me the opportunity to focus on this piece of work, and especially, for making me feel at home.

Outside the Basque Country, I would also like to thank Richard S. Kayne and other professors and students from NYU, for taking me so kindly among them in the stay I did in 2012. Many thanks also to Rajesh Bhatt and Michelle Sheehan for writing favourable reports of the dissertation.

Thanks also to Javier Ormazabal, Ricardo Etxepare, Luis Eguren, Arantzazu Elordieta, Milan Rezac, Jon Ortiz de Urbina, Michelle Sheehan and Juan Romero, for accepting being in my dissertation committee.

This work would not be what it is without the help of those who are language experts, and of those who are not. Therefore, a very special gratitude goes out to those who have answered to all my questionnaires without saying a word. Thank you very much to Itsaso Alguacil, Irati Bollar, Irantzu Epelde, Leire Etxebarria, Urtzi Etxeberria, Maider Irisarri, Aritz Irurtzun, Eneko Lasarte, Jone Loiola, Ibon Manterola, Naiara Martin, Ainhoa Mendibil, Aitor Nova, Maddi Sarasola, Ion Telleria and Aimar Uribesalgo. *Would you say that sentence? Yes, I know it is not correct in Standard Basque, but do people say it?* What a mess! You have helped me more than you think.

Many thanks to Iñaki Larrañaga as well, for making the cover of this thesis.

And last but not least, a special mention to those friends who have always been by my side. Real friends. The wonderful times I have spent talking to you, having a walk with you, or at a table have really given me the strength to go on. We have to celebrate this! I will bring the squids and the best ham in the world!

A special gratitude to Gabriel as well. I am not sure if I would have finished this thesis without your help.

To my parents, of course, for the unfailing support. Iker, you decide the place where we are celebrating! And finally, heartfelt thanks to the person who was willing (even more than me!) this thesis to be done. These lines are not enough to express my gratitude for your patience, love and endless support. This work is to you, Aitor.

The research leading to these results has received funding from the European Union's Seventh Framework Program for research, technological development and demonstration under grant agreement no. 613465. Moreover, this research has been

financially supported by the Basque Government (the pre-doctoral grant BFI2010-185 and the project IT665-13) and by the Spanish Ministry of Economy and Competitiveness (FFI2011-26906 and FFI2014-51878-P). Needless to say, all errors are mine.



Esker onak

Iritsi da lan honi amaiera emateko unea. Luzea izan da bidea, baina hein handi batean ingurukoei esker, amaitu dut azkenean! Asko izan dira azken urteotan nirekin izan ditudanak, eta guzti horiei eskerrak emateko baliatu nahiko nituzke ondorengo lerroak.

Beatriz Fernández aipatu nahiko nuke lehendabizi, lan honen zuzendari eta gidari izan dena. Beatrizek hasiera-hasieratik jarri izan du konfiantza osoa nigan, eta une zailenetan ere, beti jakin izan du, entrenatzaile onenek bezala, nire onena ateratzen, ni animatzen, ni lasaitzen, eta beharrezkoa izan denean, niri atsedena ematen. Eskerrik asko, Beatriz, bihotz-bihotzez, urte guzti hauetan eman didazun guztiagatik.

Javier Ormazabalek ere aipamen berezia merezi du. Izugarri ikasi dut hizkuntzalaritzaz eta sintaxiaz Javirekin. Baina batez ere, hizkuntzalaritzaz eta sintaxiaz disfrutatzen, ondo pasatzen eta barre (algarak!) egiten ikasi dut. Eta hori oso eskertzekoa da. Plazer bat izan da zurekin jardutea, Javi!

Ane Berro ezin aipatu gabe utzi. Aneri esker atera ditut momentu askotan aurrera egiteko indarrak. Anek entzun eta arindu ditu nire kezkek sarritan. Anek lagundu dit bide-zidorretan galdu gabe, berriz ere bide zuzenera itzultzeen. Eta batez ere, Aneri esker ikusi dut, baietz, posible zela hau amaitzea. Mila esker, Ane!

Lan hau burutzerako bidean, euren laguntza behin eta berriz eskaini didaten UPV/EHU-ko zein CNRS-IKER-eko irakasle eta ikertzaileei ere nire eskerrik onena eman nahiko nieke. Eskerrik asko, Pablo Albizu, Ricardo Etxepare, Beñat Oyharçabal, Anna Pineda, Milan Rezac, Esther Torrego eta Myriam Uribe-Etxebarriari. Benetan baliagarriak izan dira zuek egindako iruzkin eta iradokizunak.

Hizkuntzalaritza eta Euskal Ikasketetako Saileko gainerako irakasleei ere eskerrik asko karrera zein master garaian hizkuntza(ar)ekiko eta euskararekiko interesa eta jakin-mina piztearren. Irakasle eta ikaskide bikainak izan ditut Gasteizen. Mila esker, denoi!

Eskerrik asko Hizkuntzaren eta Literaturaren Didaktika Saileko lankideei ere, zuen eskuzabaltasunari esker lan honetan buru-belarri jarduteko aukera izan dudalako, eta batez ere, zuen artean etxean bezala sentiarazi nauzuelako.

Euskal Herritik kanpora, Richard S. Kayne eta NYU-ko beste hainbat irakasle eta ikasleei ere eskertu nahiko nieke NYU-n 2012an egindako egonaldian ni hain eskuzabal hartu izana. Baita Rajesh Bhatt eta Michelle Sheehan-i ere tesiaren aldeko txostenak idatzi izana.

Eskerrik asko, halaber, Javier Ormazabal, Ricardo Etxepare, Luis Eguren, Arantzasu Elordieta, Milan Rezac, Jon Ortiz de Urbina, Michelle Sheehan eta Juan Romerori ere, doktore tesi honen epaimahaikide izateko eskaera onartzearren.

Hizkuntzan adituak zein ez, lan honek ikaragarri zor die elkarrizketatutako hiztun guztiei. Horregatik, eskerrak eman nahiko nizkieke, sekula ezetzik esan gabe, nire galdetegi amaigabeak erantzun dituzten horiei. Mila-mila esker, Itsaso Alguacil, Irati Bollar, Irantzu Epelde, Leire Etxebarria, Urtzi Etxeberria, Maider Irisarri, Aritz Irurtzun, Eneko Lasarte, Jone Loiola, Ibon Manterola, Naiara Martin, Ainhoa Mendibil, Aitor Nova, Maddi Sarasola, Ion Telleria eta Aimar Uribesalgori. *Esaldi hau esango zenuke? Bai, badakit ez dagoela ondo Euskara Batuan, baina hau entzun daiteke? Ai ama, zenbat buelta! Zuek uste baino askoz gehiago lagundu didazue, benetan!*

Mila esker Iñaki Larrañagari ere tesiaren azala egitearren.

Eta amaierarako utzi baditut ere, uneoro alboan izan ditudan lagunak aipatu nahiko nituzke. Lagun lagunak. Zuekin berriketan, pasieran, mahai baten bueltan, igarotako une zoragarri eta ahaztezinek ere eman didate aurrera egiteko kemena. Hau ospatu egin behar dugu! Txipiroiak eta munduko urdaiazpikorik onena nire kontu!

Eskerrik asko, bihotz-bihotzez Gabrieli ere bai. Ez dakit zure laguntzarik gabe tesi hau amaitzera iritsiko nintzatekeen.

Gurasoei, nola ez, dena emategatik, eta beti, beti hor egotegatik. Iker, aukeratu bazkari eder bat egiteko tokia! Eta azkenik, tesi hau amaitzea nik beste (edo gehiago!) desio izan duenari eman nahiko nizkioke nire eskerrik beroenak. Lerro hauek ez dira

nahikoa eskainitako pazientzia, maitasun eta babes guztia eskertzeko. Zuri eskaintzen dizut lan hau, Aitor.

Emaitza hauetara ekarri gaituen ikerketak Europar Batasunaren ikerketarako, teknologia garatu eta erakusteko Zazpigarren Esparru Programaren laguntza jaso du 613465 diru-laguntza hitzarmenaren bitartez. Horrez gain, lan hau ondoko instituzio eta ikerketa proiektuei esker idatzi ahal izan dut: Eusko Jaurlaritza (BFI2010-185 doktore-aurreko beka eta IT665-13 ikerketa taldea) eta Espainiako Ekonomia eta Lehiakortasun Ministerioa (FFI2011-26906 eta FFI2014-51878-P ikerketa proiektuak). Lanean zehar egon litezkeen okerren erantzukizuna, jakina, nirea baino ez da.



TABLE OF CONTENTS

Laburpena (summary in Basque).....	1
1. INTRODUCTION	
1.1. Empirical scope of the dissertation.....	9
1.1.1. Canonical vs. non-canonical object marking.....	10
1.1.2. Morphological identity to dative marked indirect objects.....	12
1.2. The framework	14
1.3. Main goals and claims of the dissertation	17
1.4. Overview of the chapters.....	20
1.4.1. Chapter 2: DOM in Basque and across-languages	20
1.4.2. Chapter 3: The syntactic category of DOM objects and the licensing of depictive secondary predication	22
1.4.3. Chapter 4: The PCC, datives and v-Agree in DOM objects.....	24
1.4.4. Chapter 5: DOM and the Derivational Distinctness Condition.....	27
2. DOM IN BASQUE AND ACROSS-LANGUAGES	
2.1. Introduction	32
2.2. A brief description of the phenomenon	32
2.3. DOM across-languages.....	36
2.3.1. DOM in Hindi.....	38
2.3.2. DOM in Spanish	40
2.4. Delimiting the distribution of Basque DOM	46
2.4.1. Main factors governing Basque DOM.....	47
2.4.1.1. Animacy.....	47
2.4.1.2. Specificity	51
2.4.1.3. Other factors like tense and finiteness.....	55
2.4.1.4. Interim summary.....	58
2.4.2. DOM vs. datives in bivalent unergatives.....	60
2.5. Interim summary	66

3. THE SYNTACTIC CATEGORY OF DOM OBJECTS AND THE LICENSING OF DEPICTIVE SECONDARY PREDICATION

3.1.Introduction	70
3.2.Depictive secondary predication and the restriction on the controller	73
3.2.1. Preliminaries	74
3.2.2. Dative indirect objects cannot license depictive secondary predication	79
3.2.3. Causee datives are the exception to the restriction on the controller	83
3.3.DOM objects and depictive secondary predication.....	87
3.3.1. DOM objects license depictive secondary predication.....	88
3.3.2. The predicate does not need to be adjacent to the object controller.....	92
3.3.3. Datives in bivalent unergatives do not license depictive secondary predication	95
3.3.4. Interim summary	98
3.4.Depictive secondary predication allows DP but not PP-like datives.....	100
3.4.1. PP-like datives are not able to license depictive secondary predication	100
3.4.2. DP datives are able to license depictive secondary predication	104
3.4.2.1.Possessor datives	104
3.4.2.2.Experiencer datives	107
3.4.3. Interim summary	109
3.5.Some consequences of the updated restriction on the controller.....	110
3.5.1. The restriction is syntactic in nature.....	111
3.5.2. The restriction requires a derivational analysis fir PP-like datives	115
3.5.3. The restriction supports a Complex Predicate approach to depictive secondary predication	125
3.6.Conclusion and interim summary.....	128

4. PCC EFFECTS AND V-AGREE IN DOM OBJECTS

4.1.Introduction	131
4.2.Preliminaries.....	135
4.3.In favor of a syntactic analysis of the PCC	137
4.3.1. Lack of PCC in non-finite contexts	138
4.3.2. Lack of PCC in non-argumental dative-like markers.....	138
4.3.3. Lack of PCC in bivalent unaccusatives with PP-like datives.....	140

4.3.4. Lack of PCC in external arguments.....	141
4.3.5. PCC in the <i>leísta</i> varieties of Spanish	142
4.3.6. PCC in agreement-less contexts	143
4.3.7. Interim summary.....	143
4.4.The Agree/Case approach of the PCC	144
4.4.1. The PCC is triggered by all agreeing datives in [Spec, ApplP]	145
4.4.2. Defective [person] <i>v</i> -Agree of agreeing datives in [Spec, ApplP]	147
4.4.3. Interim summary.....	151
4.5.The PP repair strategy.....	153
4.5.1. A brief description of the repair	154
4.5.2. The repair consists on adding an Agree/Case locus to P.....	156
4.5.3. The repair is unavailable for DP datives	161
4.5.4. Interim summary.....	164
4.6.The PCC and its repairs in DOM objects	165
4.6.1. DOM objects are affected by the PCC	166
4.6.2. PCC repairs combining DOM objects with goal datives.....	170
4.6.2.1.The PP repair strategy.....	170
4.6.2.2.Embedding first and second person objects within a noun or nominalized clause	174
4.6.2.3.Substitution of the dative by a locative PP	175
4.6.2.4.Interim summary.....	178
4.6.3. No PCC repairs combining DOM object with DP datives	178
4.6.4. Interim summary.....	182
4.6.5. A note on Double Dative Constructions.....	182
4.7.A clitic doubling analysis for the dative markers	191
4.7.1. Main properties of the clitic doubling in inherent datives.....	192
4.7.2. Dative intervention in restructuring unaccusative modal constructions.....	196
4.7.3. Impersonal causative constructions	203
4.8. Conclusion and interim summary.....	207
5. DOM AND THE DERIVATIONAL DISTINCTNESS CONDITION	
5.1.Introduction	212
5.2.The Distinctness Condition	218

5.2.1. Preliminaries.....	218
5.2.2. DOM and the Distinctness Condition.....	220
5.2.3. Accounting for animacy within the Distinctness Condition.....	223
5.2.4. Interim summary.....	227
5.3. The Derivational Distinctness Condition	228
5.3.1. Lack of evidence for Object Shift.....	230
5.3.1.1. Word order with respect to manner adverbs.....	231
5.3.1.2. Word order in ditransitive constructions	235
5.3.1.3. Interim summary.....	241
5.3.2. DOM in interrogative contexts	242
5.3.3. DOM with ergative subjects	247
5.3.4. Against the Dependent Case approach	254
5.3.5. The Derivational Distinctness Condition in Basque DOM varieties.....	258
5.3.5.1. [±Person] subsumes both animacy and specificity	260
5.3.5.2. The addition of the K head makes DOM objects morphologically identical to the rest of dative arguments.....	264
5.3.6. Interim summary.....	266
5.4. The Derivational Distinctness Condition in ditransitive constructions	269
5.4.1. DOM depends on the lack of ApplP: the case of Basque.....	269
5.4.2. DOM depends on the lack of ApplP: the case of Spanish.....	281
5.4.3. Interim summary.....	291
5.5. The Derivational Distinctness Condition in derived transitive constructions	292
5.5.1. Introduction	292
5.5.2. Transitive predication with * <i>edun</i> ‘have’	292
5.5.3. The transitive predication with * <i>edun</i> ‘have’ is derived from <i>izan</i> ‘be’	295
5.5.4. DOM and the transitive predication with * <i>edun</i> ‘have’	296
5.6. Conclusion and interim summary.....	299
6. CONCLUSIONS	
6.1. Summary and general conclusions	303
6.1.1. The syntax of DOM objects.....	303
6.1.1.1. The distribution.....	303

6.1.1.2. The original syntactic category.....	304
6.1.1.3. The Case licensing mechanism.....	305
6.1.1.4. The dative Case assignment	305
6.1.2. The syntax of dative arguments.....	307
6.1.2.1. A dual analysis for the categorical as well as configurational origin	308
6.1.2.2. A uniform analysis for the Case licensing and subsequent clitic doubling.....	311
6.2. Open issues for further research	312
6.2.1. Variation in the distribution of Basque DOM	312
6.2.2. The distinct behavior of DOM and non-DOM varieties/languages	314
Appendix: Some socio-linguistic notes on Basque DOM.....	317
References	323
Abbreviations	339

LABURPENA

Doktore tesi honen xede nagusia hego-mendebaleko zenbait euskal hizkeratan gertatzen den *Osagarrien Markapen Bereizgarria (OMB)* (ingelesez, *Differential Object Marking, DOM*) aztertzea da. Kanonikoki dagokien absolutiboaren ordezt, markapen bereizgarria jasotzen duten osagarriek datibo kasu eta komunztadura erakusten dute, Hizkuntza Tipologiaren zein Kasu Teoriaren ikuspuntutik espero ez den ergatibo-datibo konfigurazioa sortuz (Fernández eta Rezac 2010 2016, Odria 2014). Beheko (1) adibidean ikus daiteke absolutiboz markatutako osagarri kanonikoen (1a) eta markapen bereizgarriko osagarrien (1b) arteko aldea. (2) adibidean, bestalde, markapen bereizgarriko osagarriek zehar osagarrien morfologia berbera erakusten dutela ikus dezakegu.

(1) a, Zuk ni ikusi nauzu

b. Zuk niri ikusi didazu

(2) Zuk niri liburua eman didazu

Markapen bereizgarriko osagarriek, helburu theta-roleko zehar osagarriez gain, bestelako datiboekiko antzekotasun morfologikoa ere erakusten dute. Hori kontuan hartuta, ikerketa lan honetan, arazi, esperimendatzaile, helburu edota jabe datiboen sintaxia ere arakatzen da, markapen bereizgarriko osagarrien eta oro har datiboen jokabide sintaktikoa hobeto ezagutzeko asmoz. Ondoko lau helburuei lotuta egituratzen dira doktore tesi hau osatzen duten lau kapituluak:

(i) Euskararen OMB-aren banaketa eta berau baldintzatzen duten faktoreak deskribatzea, fenomeno beraren erakusgarri diren munduko beste hizkuntza batzuetako datuen argitan (bigarren kapitulua).

(ii) Markapen bereizgarriko osagarrien zein bestelako datiboen sortzezko kategoria sintaktikoa ezagutzeko helburuarekin, DS eta sorburuan PS diren datiboak bereizteko irizpide berri bat proposatzea (hirugarren kapitulua).

- (iii) Markapen bereizgarriko osagarriek eta datiboek oro har Kasua nola zilegiztaten duten argitzea *Pertsona Kasuaren Murriztapena*-rekiko (*PKM*) (ingelesez, *Person Case Constraint, PCC*) erakusten duten jokabidean oinarrituz (laugarren kapitulua).
- (iv) Euskararen OMB-an datibo markapena zein prozesu sintaktikok eragiten duen aztertzea, prozesu horrek OMB-aren banaketa zelan azaltzen duen argituz (bosgarren kapitulua).

OMB-aren banaketa deskribatzeko helburuarekin, bigarren kapituluan euskaraz markapen bereizgarria mugatzen duten faktoreak zeintzuk diren azaltzen da, antzeko jokabidea erakusten duten bestelako hizkuntza OMB-dunei ere begiratuz. Munduko beste hainbat hizkuntzatan gertatzen denez (Bossong 1985 1991, Aissen 2003), euskaraz ere, biziduntasunak (edo zehazkiago, pertsonak) eta zehaztasunak baldintzatzen dute OMB fenomenoaren markapen bereizgarria daramaten osagarriak orokorrean gizakiak eta zehaztuak baitira. Halaxe gertatzen da, adibidez, gaztelania edo hindiera bezalako hizkuntzetan ere. Bestalde, euskararen kasuan, biziduntasunaz eta zehaztasunaz gain, denborak eta jokatusunak ere eragiten dute OMB-aren banaketan, orainaldian zein egitura jokatu gabeetan fenomenoaren agerpena murriztu egiten baita zenbait kasutan.

Markapen bereizgarriko osagarriekin gertatzen den moduan, euskaraz *lagundu* bezalako predikatu inergatiboetako osagarri datiboek ere ergatibo-datibo konfigurazioa sortzen dute (Etxepare 2003, Fernández eta Ortiz de Urbina 2010). Nolanahi ere, markapen bereizgarriko osagarrietan ez bezala, predikatu inergatiboetako osagarrien markapena ez da biziduntasunaren eta zehaztasunaren araberakoa izaten, ezta perpausaren denboraren edo jokatusunaren araberakoa ere. Gainera, predikatu hauen osagarriek helburu theta-rola izan ohi dute, eta horrek are nabarmenago egiten du markapen bereizgarriko osagarriekiko aldea, azken hauek tematikoki gaiak diren osagarriak hautatzen dituzten predikatu iragankor hutsetan agertzen baitira.

Hirugarren kapituluaren helburu nagusia markapen bereizgarriko osagarrien zein bestelako datiboen sortzezko kategoria sintaktikoa identifikatzea da, euskaraz zenbait datibo argumentuk beti DS bezala jokatu beharrean, PS-en moduko jokabidea izan

baitezakete. Horixe gertatzen da, esate baterako, ipar-ekialdeko hizkeretan komunztadurarik erakusten ez duten helburu eta, maiztasun gutxiagorekin bada ere, araziekin. Esperimentatzaile eta jabe datiboak ez bezala, datibo hauek komunztadurarik gabe agertu daitezke aipatutako hizkeretan, eta horrek euren jokabidea PS-ekin parekatzen du –ikus, besteren artean, Fernández, Ortiz de Urbina eta Landa (2009), Etxepare eta Oyharçabal (2013), Etxepare (2014) eta Ormazabal eta Romero (2017). Hizkera horietatik kanpo ere egitura jakin batzuetan helburu datiboak komunztadurarik gabe agertzen direla erakusten dut laugarren kapituluan. Hori dela eta, gainerako datiboek beti DS moduan jokatzen badute ere, helburu datiboak jatorriz PS-ak direla argudiatzen dut tesi honetan

Hirugarren kapituluan, bada, DS eta sortzez PS-ak diren datiboak bereizteko beste irizpide bat plazaratzen dut, bigarren mailako predikazioaren zilegiztatzeari loturikoa, hain zuzen ere. Orain arte uste izan denaren kontra –ikus, batez ere Zabala (1993 2003), aldarrikatzen dut euskaraz –eta gaztelaniaz– bigarren mailako predikazioa ez dela datiboz markatutako zehar osagarri guztiakin ezinezkoa, helburu datiboek baino ez baitute erakusten berau kontrolatzeko ezintasuna. Araziak eta markapen bereizgarriko osagarriak izan dira gaia aztertu duten lanetan bigarren mailako predikazioa zilegiztatzeari begira datiboen artean salbuespentzat hartu izan diren bakarrak (Zabala 1993, Fernández eta Rezac 2010 2016, Odria 2014). Alabaina, kapitulu honetan, arazi eta markapen bereizgarriko osagarriez gain, komunztadurari dagokionez beti DS bezala jokatzen duten esperimentatzaile eta jabe datiboak ere predikazio mota hau zilegiztatzeko gai direla erakusten dut. Hala, bigarren mailako predikazioa zilegiztatzea konfigurazio sintaktikoaren araberakoa izan beharrea, sortzezko kategoria sintaktikoaren araberakoa izan behar dela ondorioztatzen dut, helburu datiboak baitira, gainerako PS-ekin batera, aztertutako datiboen artean predikazio mota hau kontrolatu ezin duten bakarrak.

Hori horrela izanik, markapen bereizgarriko osagarriek bigarren mailako predikazioa kontrolatu ahal izateak osagarri ez-kanoniko hauek sortzez DS kategoriakoak izatea dakar, bigarren mailako predikazioa onartzen duten gainerako datiboak ere beti DS kategoriakoak dira-eta. Horrez gain, bigarren mailako predikazioa izaera desberdineko PS-ekin eta komunztaduradun zein komunztadurarik gabeko helburu datiboekin baino

ez da ezinezkoa, eta hortaz, horrek esan nahi du sortzezko gunean helburu datibo guztiek PS kategoria izan behar dutela, eratorpenaren amaieran komunztadura izan zein ez. Horixe da, hain zuzen ere, datiboen eratorpenezko analisiak proposatzen duena (Ormazabal eta Romero 1998 2017, Albizu 2001). Analisi honen arabera, (helburu) datiboak PS bezala sortzen dira sintaxian eta P burua A-ra inkorporatzean, AS-tik atera eta goragoko posizio batean igotzen dira –jada DS kategoriarekin– Kasua zilegiztatzeko. Guztiak PS bezala sortu arren, P burua inkorporatzetik dator, honenbestez, komunztaduradun eta komunztadurarik gabeko helburu datiboen arteko kontrastea. Bestalde, bigarren mailako predikazioak helburu datiboei PS jatorria egotzen badie ere, arazi, esperimentatzaile eta jabe datiboak DS bezala sortzen direla erakusten du, hauek ez baitute ez komunztadurari begira orokorrean, eta ezta predikazio mota honi dagokionez ere, PS bezala jokatzen.

Laugarren kapituluak markapen bereizgarriko osagarriek eta datiboek oro har Kasua zelan zilegiztatzen duten ikertzen du, horretarako PKM delakoaren eragina eta berau saihesteko estrategiak aztertuz. PKM *a* txikiaren Komunztadura/Kasu eremuan kokatzen da, eta beraz, buru funtzional honekin Komunztadura egiten duten barne argumentuei eragiten die –ikus, besteren artean, Anagnostopoulou (2003), Béjar eta Rezac (2003) eta Rezac (2011). Hori kontuan hartuta, kapitulu honetan, markapen bereizgarriko osagarriek Kasua *a* txikiarekiko Komunztadura erlazioan erkatzen dutela proposatzen dut, PKM-ak absolutibozko osagarri kanonikoei bezala eragiten baitie hauei ere. Komunztaduradun gainerako datiboek [Espez, AplS] gunean jasotzen dute berezko Kasua Apl burutik eta hauek ere *a* txikiarekin egiten dute Komunztadura, lehen edo bigarren pertsonako osagarri bat o-komandatzen dutenean PKM sortuz. Arazo, esperimentatzaile eta jabe datiboak gune sintaktiko horretan sartzen dira eratorpenean. Helburu datiboak, aldiz, beheagoko PS gune batetik iristen dira bertara –hots, [Espez, AplS] gunera, P burua aditzera inkorporatutakoan. Berezko Kasua izanik, [Espez, AplS]-ko datibo argumentuak KS-ak direla onartzen dut hein batean Rezac-i (2008a) jarraituz, eta beraz, KS geruza horrek oztopatuta, datiboek *a*-rekin [persona] tasunetan oinarritutako Komunztadura erlazio defektiboa egiten dutela argudiatzen dut.

PKM helburu datiboek eragiten dutenean, berau saihesteko estrategietako bat helburu datiboa komunztadurarik gabe –hau da, PS bezala– agertzea izan ohi da hainbat euskal

hiztunentzat (Albizu 1997a 2001, Rezac 2009b 2011, Oyharçabal eta Etxepare 2012). Komunztadurarik erakusten ez duten datibo hauek PS estrategia darabiltela onartzen dut Rezac-en (2011) proposamenarekin bat eginez. PS estrategiak sortzez helburu argumentuak islatzen duen P buruaren Komunztadura/Kasu eremua indarrean jartzen du interpretagaitzak diren phi-tasunak gehituta. Honek P buruari bere osagarri gunean sortutako helburu argumentuari berezko datibo Kasua ezartzeko aukera ematen dio. Hala, helburua PS moduan egituratzen da, *a*-rekin Komunztadura egin gabe, eta honenbestez, aditz laguntzailean komunztadurarik eragin gabe. Sortzez DS-ak direnez gero, PS estrategia hau ez da orokorrean arazi, esperimentatzaile edo jabe datiboetan gauzatzen (Albizu 1997a 2001, Rezac 2009b 2011), ezta markapen bereizgarriko osagarrietan ere (Fernández eta Rezac 2010 2016, Odria 2014). Datibo hauek ez dira PS bezala sortzen eratorpen sintaktikoan, eta hortaz, ez dute tasun interpretagaitzak gehitu ahal izateko buru funtzionalik Ondorioz, ezin izaten dute PKM-aren eragina saihestu *a*-rekin Komunztadura egin gabe, hau da, PS moduan geratuta.

Sortzezko DS vs. PS kategoria sintaktikoaren ondorioz, lehen eta bigarren pertsonako markapen bereizgarriko osagarriak komunztadurarik gabeko helburu datiboekin bateragarriak direla erakusten dut, ez ordea, espero izatekoa den bezala, gainerako DS datiboekin. Markapen bereizgarriko osagarriak azken hauekin konbinatzeak ez-gramatikaltasuna dakar orokorrean, perpauseko bi datiboak DS-ak izaki, biek egin behar dutelako ezinbestean Komunztadura *a*-rekin. Markapen bereizgarriko osagarriek eta helburu datiboek osatutako datibo bikoitzeko egituretatik abiatuta, egitura arazi ditransitiboetako datibo bikoitzei ere erreparatzen diet kapitulu honetan. PKM saihesterakoan gertatzen den bezala, datibo bikoitzeko egitura hauetan ere helburu datiboa izan ohi da PS moduan agertzeko gai den bakarra. Araziak, sortzez DS izanik, *a*-rekin Komunztadura egiteko beharra dauka, eta hortaz, ezin izaten du aditz laguntzailean komunztadurarik eragin gabe geratu.

Amaitzeko, laugarren kapituluaren azken atalean, euskaraz aditz laguntzaileko datibo markak, komunztadura markak izan beharrean, klitikoak direla aldarrikatzen dut. Zehazki, klitikoa KS datiboarekin batera sortzen dela onartuta, hau *a*-rekin elkartu aurretik [Espez, *a*S] gunetik igarotzen dela argudiatzen dut.

Tesiaren bosgarren kapituluan, markapen bereizgarriko osagarriek datibo Kasua konfigurazionalki jasotzen dutela aldarrikatzen dut, Richards-ek (2010) plazaratutako *Bereizitasunaren Baldintzak* (ingelesez, *Distinctness Condition*) eraginda, hain zuzen ere. Bereizitasunaren Baldintzak Ahoskatu eremuan elkar o-komandatzen duten label bereko elementuen lerratzea eragozten du, PF (*Phonetic Form*) elkargunearentzat lerratze hori kontraesankorra –eta hortaz, irakurtezina– baita. Baldintza betetzen ez den kasuetan, bi elementu horietako bati K fase burua ezartzen zaio. Horrek buru hori jasotzen duen elementua fase beregain batean ahoskatzea ahalbidetzen du, Bereizitasunaren Baldintza behar bezala betez.

Munduko beste hizkuntza batzuetan markapen bereizgarriko osagarriek *aS* fasetik atera eta KonpS faserako mugida egiten dutela onartuta, Richards-ek aldarrikatzen du hizkuntza hauetan subjektuak eta markapen bereizgarria jasotzen duen osagarriak Bereizitasun efektu bat sortzen dutela azken hau KonpS-ra igotzean, eta beraz, osagarriari K burua –hau da, markapen bereizgarria bera– gehitzen zaiola subjektutik bereizi ahal izateko.

Bereizitasunaren Baldintza, PF elkarguneak bultzatutakoa izanik, berez Ahoskatu eremura mugatuta dago. Hala ere, Richards-ek berak proposatu bezala, tesi honetan argudiatzen dut delako baldintza hau syntaxian bertan dagoela indarrean, eta beraz, ez dela azken Ahoskatu eremuetan bakarrik egiaztatzen. Hori dela eta, euskaraz OMB Eratorpenezko Bereizitasunaren Baldintzak eragiten duela aldarrikatzen dut. OMB-dun euskal hizkeretan, baldintza hau *aS* fase eremuan bertan bortxatzen da, gizakia eta zehaztua den osagarriak [Espez, *aS*]-ko subjektu iragankorarekin bat egiten duenean. Bai osagarria eta bai subjektua φ S labeldunak direla onartuta, $\langle \varphi$ S, φ S \rangle lerratzea ez litzateke PF elkargunearentzat irakurgarria izango, eta egoera hori saihesteko, K burua –hau da, datibo Kasua– ezartzen zaio osagarriari. [Espez, ApIS]-ko komunztaduradun berezko datiboek bezala, markapen bereizgarriko osagarriek ere klitiko buru bat izaten dute atxikia KS-ri lotuta, eta gainerako datiboetan gertatzen den moduan, klitiko buru hori *a* txikiarekin batzen da [Espez, *aS*]-tik igarota. K buruak IS-ko datibo kasu marka azaltzeaz gain, aditz laguntzaileko datibo markak ere azaltzen ditu, beraz.

Euskarari dagokionez, hiru dira Bereizitasunaren Baldintza eratorpenean zehar egiaztatzen dela erakusten duten gertakariak: (i) markapen bereizgarriko osagarrien KonpS-rako mugida baieztatzen duen ebidentziarik eza, (ii) OMB galderetan, hau da, subjektua eta osagarria fase beregainetan ahoskatzen diren testuinguruan agertu ahal izatea, eta (iii) OMB [Espez, IS] gunean KS bihurtzen diren egiturazko subjektu ergatiboekin (Rezac, Albizu eta Etxepare 2014) agertzea.

Eratorpenezko Bereizitasunaren Baldintza OMB-aren banaketa osoa azaltzeko gai da. Izan ere, markapen bereizgarria erakusten duten testuinguruez gain, osagarria gizaki eta zehaztua izanagatik ere, markapen hori ezinezko egiten duten konfigurazioak ere esplikatzen ditu. AplS islatzen duten egitura ditransitiboetan eta **edun* aditzarekin osatutako eratorritako predikazio iragankorreak izaten da markapen bereizgarria ezinezkoa. Egitura ditransitiboetan, komunztaduradun berezko datiboak AplS islatzen du AS eta sS-ren artean, eta honek, fase burua izanda (McGinnis 2001ab), osagarriak eta subjektuak *aS* fasean bat egitea eragozten du. Eratorritako predikazio iragankorreak ere osagarriak eta subjektuak fase eremu berean bat egiten ez dutelako izaten da markapen bereizgarria ezinezkoa. Kasu honetan, Etxepare eta Uribe-Etxebarriarekin (2012) bat eginez, ergatiboz markatutako subjektua Apl isil baten barruan sortzen dela onartzen dut. Hori horrela izanda, osagarriak eta subjektuak ez dute *aS* eremuan bat egiten, eta Bereizitasun efekturik sortzen ez denez, osagarriari ez zaio markapen bereizgarria ezartzen. Ondorioz, gizaki eta zehaztua izan zein ez, osagarria *a*-rekin erkatutako absolutibo kasu eta komunztadurarekin agertzen da. Eratorpenezko Bereizitasunaren Baldintzak bete-beteaz azaltzen ditu, beraz, OMB zilegiztatzen duten egiturak ez ezik, baita berau zilegiztatzen ez dutenak ere.

1. INTRODUCTION

1.1. EMPIRICAL SCOPE OF THE DISSERTATION

The main aim of this dissertation is to analyze the syntax of the *Differential Object Marking* (DOM) (Bossong 1985 1991, Aissen 2003) attested in certain southwestern Basque varieties, where human and definite objects tend to bear dative marking, instead of the canonical absolutive (Fernández & Rezac 2010 2016, Mounole 2012, Odria 2012 2014, Rodríguez-Ordóñez 2013 2016). Southwestern varieties of Basque are those which are in contact with Spanish –and thus, also with Spanish DOM. The Basque varieties situated in the French speaking area are referred as northeastern varieties and, as happens in Standard Basque, they show no DOM, since only the canonical absolutive marking is available for them.

Due to the contact situation with Spanish, Basque DOM has commonly been regarded as a contact-induced phenomenon, which has led to a high socio-linguistic stigmatization (Rodríguez-Ordóñez 2013 2016). In spite of that, in the last centuries the phenomenon under study has undergone a significant spread in southwestern Basque varieties, and has become a common pattern in many of them –see Mounole (2012) for an overview of its diachronic evolution.¹

Partly as a consequence of such stigmatization, Basque DOM has received no attention until recent years. In fact, although the phenomenon was already attested in Bonaparte's ([1869] 1991) dialectological survey, the first studies approaching Basque DOM from a theoretical point of view have not appeared until the last decade –see Fernández & Rezac (2010 2016) and Odria (2012 2014). Following the line of investigation of these papers, this dissertation attempts to make a further step in the syntactic examination of Basque DOM. Considering the general scene of (Basque) datives, it presents a novel

¹ See the appendix for further socio-linguistic aspects on Basque DOM.

proposal for the Case licensing of DOM objects and provides additional predictions for the syntax of the rest of the datives.

With the aim at introducing the empirical scope of the thesis, in what follows the differential or non-canonical object marking is briefly presented focusing on the contrast to the canonical object marking (section 1.1.1) and on the morphological identity to dative marked indirect objects (section 1.1.2).

After setting out its empirical scope, section 1.2 outlines the framework followed in the dissertation. The theoretical contribution is summarized in sections 1.3 and 1.4. Section 1.3 lays out the main goals and claims of the thesis and an overview of chapters 2, 3, 4, and 5 is given in 1.4.

1.1.1. Canonical vs. non-canonical object marking

As I have already pointed out, certain southwestern Basque varieties display DOM, given that a differential marking is assigned to those objects showing a positive value for animacy and specificity. These varieties tend to mark human and definite objects dative, instead of the canonical absolutive expected in an ergative language like Basque.

In Standard as well as other varieties of Basque, the subject is marked with ergative case (*-k*) and the object with absolutive case (*-∅*). Likewise, the finite verbal form agrees with the two arguments by means of their respective markers: *-zu* for the second person ergative and *n-* for the first person singular absolutive.

- (1) Zu-k ni ikusi nauzu
you-E I.A see AUX[1sgA-2sgE]
'You have seen me.'

In contrast to the canonical configuration, southwestern Basque varieties displaying DOM tend to mark human and definite objects dative, as in (2).

- (2) Zu-k ni-ri ikusi didazu
you-E I-D see AUX[1sgD-2sgE]
'You have seen me.'

In (2), the subject is marked with ergative case (*-k*), but the object appears with dative case (*-(r)i*) rather than with the absolutive. Besides, as in (1), the two arguments are

coded by their respective markers in the finite verbal form: the second person ergative by *-zu* and the first person singular dative by *-da-*.

In DOM varieties the dative marking of the object happens to be favored by both animacy and specificity, as in general terms, the object has to be both human and definite in order to be differentially marked. Non-human objects like *ordenagailua* ‘computer’ are never marked dative (3), and generally speaking, neither are indefinite objects like *neska bat* ‘a girl’ in a sentence like (4). In those cases, the object bears absolutive marking, as in Standard Basque.²

(3) a. Ordenagailua ikusi dut
 computer.A see AUX[3sgA-1sgE]
 ‘I have seen the computer.’

b. *Ordenagailua-ri ikusi diot
 computer-D see AUX[3sgD-1sgE]
 ‘I have seen the computer.’

(4) a. Neska bat ikusi dut
 girl one.A see AUX[3sgA-1sgE]
 ‘I have seen a girl.’

b. ??/*Neska bat-i ikusi diot
 girl one-D see AUX[3sgD-1sgE]
 ‘I have seen a girl.’

Contrary to what happens in the DOM of widely studied accusative languages like Spanish, in Basque the differential marking coincides with the ergative marking of the transitive subject, leading thereby to a configuration with two arguments bearing a marked morphological case: the ergative and the dative. As we will see in chapter 2 (section 2.3), Basque is not an exception in this regard, as other languages like Hindi display DOM with an ergative subject as well. This is an unexpected pattern from a typological point of view, because the canonical configuration in transitive clauses is supposed to bear a single marked case, either in the subject –as happens in ergative languages– or in the object –as in accusative languages.

² See chapter 2 (section 2.4) and the appendix for the dialectal as well as idiolectal variation related to the nature of the object bearing the differential marking, as not all varieties/speakers allow every human and definite object to be differentially marked.

Such a typologically atypical frame posits a challenge for the different theories of Case assignment, and in particular, for those Dependent Case approaches assuming that Case licensing in DOM objects arises as a result of a Case competition between the object and the subject –see, among others, Baker & Vinokurova (2010), Baker (2012 2015) and Levin & Preminger (2015). As I explain in chapter 5, these approaches argue that the differential marking yields when –being both unlicensed for Case– the object and the subject coincide in a given local domain and thus enter into a competition to receive Case. In this scenario, the marked –i.e., Dependent– Case can be assigned either to the subject or to the object –the former would result in an ergative language and the latter in an accusative one. Consequently, as a marked Case is bore by both the subject and the object, the situation in Basque varieties with DOM would remain unexplained.

The examination of Basque DOM is then especially interesting on this point, as it does not only contribute to the global understanding of the DOM phenomenon, but also to the theory of Case assignment in its broadest sense. Involving an ergative language, the present study will thus bring more light into current debates on the actual way of Case assignment in DOM objects, and as a consequence, on the syntactic vs. morphological nature of the differential marking *per se*.

1.1.2. Morphological identity to dative marked indirect objects

As occurs in many DOM languages, in Basque the differential marking in human and definite objects happens to be morphologically indistinguishable from the dative marking in indirect objects. The morphological identity shared by DOM and indirect objects is a common pattern cross-linguistically (Bossong 1991: 154, 157-158, Aissen 2003: 446), and other DOM languages governed by both animacy and specificity show the same behavior as well. As we will see in chapter 2, this is the case in Hindi (section 2.3.1) and Spanish (section 2.3.2), among others.

The morphological identity between DOM and indirect objects can be observed by comparing the example in (2) with that in (5). In (5) we see that the indirect object of a ditransitive predicate like *eman* ‘give’ is marked dative in Basque.

(5) Zu-k ni-ri liburua eman didazu
 you-E I-D book.A give AUX[3sgA-1sgD-2sgE]
 ‘You have given me the book.’

In (5), the subject is marked with ergative case (-k), the direct object with the absolutive (- \emptyset) and the indirect object with the dative (-(*r*)i). Besides, the three arguments are cross-referenced by the finite verbal form, which shows the same shape as that in (2): the second person ergative is coded by -zu and the first person singular dative by -da- – in Basque, the third person absolutive is not overtly marked in the verbal form.

Despite being morphologically indistinguishable from indirect objects, in this dissertation I adhere to the default assumption that DOM objects generate in the same syntactic position as canonical absolutes, given that they both share the same thematic as well as argumental relationship. Such a position corresponds to the complement position of V. This is a common acceptance in the literature on the topic, as in spite of the differential marking, DOM objects are considered to be direct objects configurationally.

Be that as it may, the fact that the differential marking makes DOM objects morphologically identical to dative marked indirect objects is a relevant aspect regarding the theoretical discussion addressed in this dissertation. In fact, considering the similarities shared by examples like (2) and (5), the first issue that comes to mind is whether the same morphology implies the same syntax for both of them.

So as to examine whether –despite their direct object origin– DOM objects behave syntactically as indirect objects, it is first of all necessary to clarify what we mean when saying that *they behave syntactically as indirect objects*, since the syntax of dative arguments is still under debate in Basque linguistics. Therefore, with the aim at defining the syntactic nature of DOM objects, the syntax of other dative arguments such as goals (5), causees (6a), experiencers (6b) and possessors (6c) (6d) will also be studied in this dissertation. This will allow us to identify which of the syntactic processes lying behind these datives DOM objects share too.

(6) a. Miren-i etxeko lanak egin-arazi dizkiot
 Miren-D homework.A do-CAUS AUX[3sgA-3sgD-1sgE]
 ‘I have made Miren do the homework.’

b. Miren-i	musika klasikoa	gustatzen	zaio
Miren-D	music classical.A	like	AUX[3sgA-3sgD]
	'Miren likes classical music.'		
c. Miren-i	kotxea lapurtu	diote	
Miren-D	car.A steal	AUX[3sgA-3sgD-3plE]	
	'They have stolen the car to Miren.'		
d Miren-i	liburua galdu	zaio	
Miren-D	book.A lose	AUX[3sgA-3sgD]	
	'Miren has lost the book.'		

Similarly to sentences involving DOM (2) and goal datives (5), a ditransitive verbal form agreeing with the dative argument is exhibited by causees (6a) and possessors (6c) as well. In addition, as shown by (6d), possessors can also occur in a bivalent unaccusative frame, as happens with experiencers (6b). In absence of an ergative subject, in this case the finite verbal form agrees exclusively with absolutive and dative arguments.

Overall, taking into account the morphological similarity to the rest of dative phrases, the present research on Basque DOM will not only be relevant for DOM-internal questions, but also for independent issues regarding the syntax of dative arguments. These include (i) the DP vs. PP-like dual syntactic character of dative arguments, (ii) the constraints as well as repairs of the *Person Case Constraint* (PCC) (Perlmutter 1971, Bonet 1991 1994), or (iii) the widely mentioned discussion on the derived vs. base-generated nature of (certain) dative arguments. Based specially –but not only– on Basque data, this thesis will contribute to these and other aspects concerning the syntax of DOM objects in particular and dative arguments in general.

1.2. THE FRAMEWORK

In this dissertation, I follow the framework of Generative Grammar, and in particular, the Minimalist Program developed by Chomsky (2000 2001 2004 2008) and other authors within such framework.

The architecture of the language assumed by the Minimalist Program conceives that formal –i.e., syntactic/semantic– features are sent to narrow syntax from the Lexicon. These features are referred as Lexical Items and, once in narrow syntax, are modified by the syntactic operations Copy, Merge and Agree. The syntactic structures formed by such operations are ultimately interpreted at the PF (Phonetic Form) and LF (Logical Form) interfaces, and the mapping between syntax and each of these interfaces takes place cyclically, phase by phase.

For the purposes of the theoretical discussion addressed in this dissertation –and specially in chapter 4, in what follows I briefly present the basic background of the Minimalist formalization of Agree (Chomsky 2000 2001), a formal syntactic relation established between a nominal –or DP– and a functional head constituting the agreement complex.

Nominals and functional heads enter the syntactic derivation with interpretable as well as uninterpretable features. Contrary to interpretable features, uninterpretable features are unvalued with regard to the interfaces, and need to be valued by an element bearing the same (set of) feature(s) as interpretable or valued. Valuation of uninterpretable features is a required operation in narrow syntax, because unvalued features are illegible at the interfaces.

Nominals and functional heads enter into an Agree operation in order to value each other's uninterpretable features, as those features that are uninterpretable in the nominal are interpretable in the functional head, and vice versa. Nominals bear interpretable phi-features, including both [number] and [person] features, features that are instead uninterpretable in the functional head. Likewise, functional heads bear an interpretable Case feature, a feature that is in turn uninterpretable in the nominal. In the Agree operation, each of these elements values the uninterpretable feature(s) of the other element, and in the same way, gets its uninterpretable feature(s) valued by such element –valuing reduces to copying a given (set of) valued feature(s) from one element to the other.

In order for Agree to take place, the nominal and the functional head must display the same set of features. That is, they must match in their featural specification. Besides, the

so-called operation is established on purely structural grounds: it is structurally determined within a phase domain involving a c-command relation between the two elements involved in it, as the nominal –also referred as controller or goal– must be c-commanded by the functional head –also known as target or probe.

Overall, by means of Agree, nominals end up Case licensed by getting their uninterpretable Case feature valued by a functional head. The Agree relation established between nominals and functional heads thus ensures that the nominal will end up the derivation with a valued Case feature. Otherwise, it would not be legible at the interfaces, and the Case Filter would be violated –which requires that all nominals in a syntactic derivation must end up bearing Case.

When a nominal receives a Case value by a functional head and no thematic relationship is involved in the Agree operation, such nominal receives structural Case. Put it otherwise, structural Case is dissociated from theta-role assignment and the only condition is to be assigned on the basis of c-command to a nominal in an A-position.³ Apart from structural Case, nominals can receive inherent Case as well. Inherent Case is also assigned by a functional head, but in this case, a thematic relationship is in order between the nominal and the functional head.

Being a formal feature, Case is thus established –or determined– in narrow syntax and realized morpho-phonologically at the PF interface –i.e., in morphology– as a case marker in the nominal, and as an agreement or clitic marker in the finite verb if such Case feature has been valued structurally. Agreement markers are the result of a regular valuing Agree relation that consists of copying the phi-features of the goal to the probe. Conversely, clitic markers involve the movement of a head that brings the interpretable phi-feature bundle of the nominal to the functional head it Agrees with.

³ As functional heads assign structural Case, it has also been referred as functional Case. This has been the case in those studies like Baker (2015) where structural Case is considered to be assigned either functionally –i.e., by means of Agree– or configurationally –i.e., depending on the presence of another nominal within a given configuration.

Departing from these basic assumptions, further theoretical specifications will be made in chapters 4 and 5. Chapter 4 develops the Agree system outlined above, following particularly the main claims made by Rezac (2008a 2011). Chapter 5 presents a specific way of configurational Case assignment, the one that yields as a result of the Distinctness Condition put forth by Richards (2010).

1.3. MAIN GOALS AND CLAIMS OF THE DISSERTATION

This dissertation aims at analyzing the syntax of Basque DOM objects in consideration of the syntactic behavior of the rest of dative arguments, including causees, experiencers, goals and possessors. In order to do so, four main goals have been established, some of them focusing exclusively on DOM objects, and others involving a rather general perspective concerning the syntax of dative phrases. Leaving aside the introductory and concluding chapters –i.e., chapters 1 and 6, the thesis is formed by four chapters, each of them dealing with one of these goals, which are summarized as follows in (7).

(7) Goal #1: to describe the distribution of Basque DOM within a global cross-linguistic scene of the phenomenon (chapter 2).

Goal #2: to provide a novel criterion distinguishing DP and PP-like datives with the aim at determining the original syntactic category of DOM objects in particular and dative arguments in general (chapter 3).

Goal #3: to identify the Case licensing mechanism of DOM objects in particular and dative arguments in general by analyzing the effects as well as repairs of the PCC (chapter 4).

Goal #4: to analyze the syntactic process leading to dative Case assignment in DOM objects (chapter 5).

By answering the research questions lying behind the main goals of the dissertation, certain claims or contributions are made in each of the chapters.⁴

⁴ See the overview of the chapters in section 1.4 for a deeper argumentation of these claims as well as the bibliographical references related to them.

With the aim at describing the distribution of Basque DOM, chapter 2 undertakes a two-fold task. On the one hand, it presents the main factors triggering DOM in Basque and situates the phenomenon in question in a global cross-linguistic scene. The chapter shows that DOM in Basque is mainly triggered by animacy (with a further distinction based on person) and specificity, as DOM objects are generally human and definite. This is a common pattern cross-linguistically, since either together or on their own, animacy and specificity are known to be the most prevalent factors determining DOM among the languages of the world. Besides, although their influence is not as systematic as that caused by the referential properties of the object, I show that clausal properties like tense and finiteness affect the marking of the object as well, given that DOM is sometimes reduced in present tense as well as non-finite contexts. On the other hand, this chapter delimits the final distribution of Basque DOM objects by distinguishing them from –usually goal– datives in bivalent unergative predicates of the *lagundu* ‘accompany, help’ type, where the marking of the object is not governed by the factors determining DOM. This reduces the range of predicates exhibiting DOM to pure transitives involving a theme object.

The main goal of chapter 3 is to provide a novel criterion distinguishing DP and PP-like datives in order to identify the original syntactic category of DOM objects in particular and dative arguments in general. Such a criterion has to do with the licensing of depictive secondary predication, which is proved to be incompatible with PPs as well as PP-like goal datives. I demonstrate that the licensing of secondary predication characterizes DOM objects as DPs, because they are able to license this kind of predication in the same way as the rest of DP datives –i.e., causee, experiencer and possessors. Moreover, with a broader perspective on dative arguments, I state that the licensing of secondary predication provides us a solid hint to understand that DP and PP-like datives should have different categorical –and thus, configurational– sources. As the restriction on the controller –which is structurally determined– prevents both agreeing and non-agreeing goals from controlling secondary predication, a PP original category should be posited for them. This indicates that the actual agreeing behavior of goal datives should be derived from an originally PP complement of V. Likewise, given

that depictives are actually compatible with causee, experiencer and possessor datives, I argue that these are instead generated as DPs in [Spec, ApplP].

Chapter 4 aims at identifying the Case licensing mechanism of DOM objects in particular and dative arguments in general. It claims that DOM objects are Case licensed by v , because –as happens with canonical absolutes– they are affected by the PCC, a syntactic constraint located in the v Agree/Case locus. Concerning the rest of dative arguments, I claim that agreeing datives receive inherent Case in [Spec, ApplP] and enter into a defective [person] Agree relation with v –DP datives reach that position by external merge and PP-like datives by internal merge, after undergoing P-incorporation from their original complement position of V. When the PCC involves PP-like goal datives, many speakers can circumvent the effects of the constraint by resorting to the PP repair strategy. This activates the previously inactive Agree/Case locus in P and allows the goal to occur as a non-agreeing PP. Generally speaking, DP datives are unable to resort to such strategy, because, being originated as DPs, they bear no P head to which uninterpretable phi-features can be added. In addition to causee, experiencer and possessor datives, this is the case of DOM objects too, which provides further support to their DP categorial status. In this regard, I demonstrate that in some cases DOM objects are in fact compatible with goals that resort to the PP repair strategy and thus appear as PPs. The rest of the datives are DPs originally, and as such, they are required to Agree with v . As a consequence, DOM objects are generally ruled out in combination with these datives. Apart from the double dative construction formed by a DOM and a goal dative, I show that causees and goals can also co-occur in ditransitive causative constructions. As expected, in these constructions only goals can resort to the PP repair strategy, providing further support to their PP original syntactic category. To finish, the chapter argues that the dative markers in the finite verbal form correspond to clitics doubling the dative in [Spec, ApplP]. In line with recent research on clitic doubling, I contend that the clitic originates adjoined to the dative in [Spec, ApplP] and m-merges with v after passing through [Spec, v P].

Chapter 5 attempts to analyze the process leading to dative Case assignment in DOM objects. It claims that DOM objects receive dative Case configurationally, when bearing the ϕ P label coincide with the transitive ϕ P subject in the same v P phase domain. This is

in fact predicted by the Derivational Distinctness Condition put forth by Richards (2010), which bans the linearization of identical elements in an asymmetric c-command relation. In accordance with the agreeing inherent datives in [Spec, ApplP], dative Case in DOM objects is syntactically realized as K, a phasal head that makes DOM objects linearize in a separate Spell-Out domain. Given that the dative KP shell bears an adjoined clitic head that needs to attach to v , the addition of K accounts not only for the dative marking in the nominal but also in the finite verbal form. It is thus the addition of the K head the mechanism that makes DOM objects exhibit the same morphology as the rest of dative arguments. The Derivational Distinctness Condition captures in a straightforward way both the presence and absence of DOM in ditransitives involving an inherent dative as well as in the derived transitive predication formed with **edun* ‘have’. The distribution of DOM in ditransitive constructions depends on the presence of the phasal ApplP in between VP and v P. If the inherent dative appears in [Spec, ApplP], the object will not coincide with the subject in the v P phase domain and there will be no need for it to receive the K head. In contrast, if the inherent dative combining with the object is instead realized as a non-agreeing PP, the object will receive the differential marking, because, in absence of ApplP, it will coincide with the subject in the v P phase domain. Because of the PCC, agreeing inherent datives in [Spec, ApplP] are only possible with third person objects. Hence, in ditransitives only first and second person objects can appear dative marked. The absence of DOM in the derived transitive predication built up with **edun* ‘have’ is equally explained by the Derivational Distinctness Condition. The ergative subject in this construction is generated as an oblique argument in ApplP, and becomes a KP as soon as it moves to [Spec, TP]. Thus, given that the object does not coincide with it in any phase domain, the assignment of the K head happens to be unnecessary in this context as well.

1.4. OVERVIEW OF THE CHAPTERS

1.4.1. Chapter 2: DOM in Basque and across-languages

The main goal of chapter 2 is to describe the general distribution of Basque DOM in light of similar configurations attested across-languages. I show that certain

southwestern Basque varieties tend to mark human and definite objects of transitive predicates dative, instead of the canonical absolutive (Fernández & Rezac 2010 2016, Mounole 2012, Odria 2012 2015, Rodríguez-Ordóñez 2013 2016). In these varieties, the object receives a differential marking depending on its value for animacy and specificity, a pattern that belongs to the cross-linguistically widely attested DOM phenomenon (Bossong 1985 1991, Aissen 2003). As happens in many other languages, in Basque, the differential marking is morphologically identical to indirect objects of ditransitive predicates, which are also marked dative. In this regard, Basque DOM patterns with the DOM found in other languages like Hindi and Spanish, as the differential marking, triggered by both animacy and specificity, is morphologically identical to the dative marking in indirect objects. In Hindi, DOM objects coincide with the ergative marking of the subject in past/perfect contexts. As in Basque, this leads to an ergative-dative configuration, a configuration that is unexpected from typological and Case Theoretic approximations. Spanish is also relevant when comparing to Basque DOM, since, in the *leísta* Basque Spanish, DOM occurs not only in the nominal but also in the verbal clitic system. This makes it even closer to the DOM found in Basque, where the differential marking is found both in the nominal and in the finite verbal form.

Having reviewed the main cross-linguistic characteristics of DOM, I turn to examine the factors governing Basque DOM on closer inspection. In Basque, DOM is mainly conditioned by the animacy and specificity of the object (Fernández & Rezac 2010 2016, Mounole 2012, Odria 2012 2014, Rodríguez-Ordóñez 2013 2016). As for animacy, humanness seems to be the main property shared by those objects bearing the differential marking, and among human beings, first and second person objects show a preference when being differentially marked. Along with humanness, person is then an important factor when determining DOM in Basque. In addition to animacy, specificity is a core trigger of Basque DOM too, as generally speaking, DOM objects are definite entities. Besides, Basque DOM is particular in being favored by clausal properties like tense and finiteness (Fernández & Rezac 2010 2016). Even though their influence is not as strong as that caused by the properties of the object, Basque DOM is in some cases reduced in present as well as non-finite contexts.

In order to determine the group of predicates involving DOM, in the last part of the chapter, I distinguish the DOM found in pure transitive predicates like *ikusi* ‘see’ from the dative object of bivalent unergatives of the *lagundu* ‘accompany, help’ type (Etxepare 2003, Fernández & Ortiz de Urbina 2010). Although both share an ergative-dative frame, the dative object of transitive and bivalent unergative predicates is different in many respects. Contrary to the theme theta-role exhibited by DOM objects, most of the datives in bivalent unergatives are goals semantically, suggesting that they are originated in an indirect object position (Fernández & Ortiz de Urbina 2012, Ortiz de Urbina & Fernández 2016). In addition to their first merge position, DOM and datives in bivalent unergatives also differ with regards to the factors determining the dative marking. In contrast to what happens in DOM, the marking of the object in bivalent unergatives is independent from factors such as animacy and specificity, and clausal properties like tense and finiteness are neither significant. Hence, the distinction between DOM and the dative in bivalent unergatives reduces the range of verbs involving DOM to pure transitives assigning a differential marking to its object on the basis of its referential properties.

1.4.2. Chapter 3: The syntactic category of DOM objects and the licensing of depictive secondary predication

This chapter aims at identifying the original syntactic category of DOM objects, given that in Basque, datives show a dual DP vs. PP-like character (Albizu 2001). The main criterion distinguishing the dual categorial status of dative arguments comes from the possibility to occur without triggering dative markers in the finite verbal form, as in northeastern Basque, some datives can occur as non-agreeing, behaving in this respect more akin to PPs than to DPs. This is what happens with goal datives, which –contrary to experiencers and possessors– are able to appear without agreeing with the finite verbal form. In these varieties, causees are able to occur without dative markers too, but in this case the possibility to appear as non-agreeing does not seem to be as extended as with goals (Fernández, Landa & Ortiz de Urbina 2009).⁵ Outside northeastern Basque,

⁵ For non-agreeing datives in northeastern Basque, see Ortiz de Urbina (1995), Albizu (2001 2009), Fernández (1997 2010 2014), Fernández & Landa (2009), Fernández, Ortiz de Urbina & Landa (2009),

non-agreeing datives are limited to specific configurations such as ditransitives affected by the PCC and double dative constructions. As I show in chapter 4, generally speaking, only goals are allowed to occur as non-agreeing in them, indicating that causees pattern like experiencers and possessors in this regard. Based on these facts, in this dissertation I make the distinction between causee, experiencer and possessor datives on the one hand, and goal datives on the other. The former are referred as DP datives and the latter as PP-like datives, as they are able to occur without agreeing with the finite verbal form.

Taking this into account, chapter 3 provides a novel criterion to determine the original syntactic category of DOM objects in particular and dative phrases in general: the licensing of depictive secondary predication. I state that the dual DP or PP-like nature of dative arguments has gone unnoticed when discussing the restriction on the controller of secondary predication, as only PP-like goals have been examined when analyzing the behavior of dative arguments –i.e., agreeing goal datives that can occur as non-agreeing under certain conditions. In contrast to the standard assumption claiming that depictives reject PPs and all kind of dative indirect objects (Zabala 1993 2003, Arregi & Molina-Azaola 2004, Oyharçabal 2010), I demonstrate that secondary predication is only excluded with those datives that can behave as PPs, as DP datives are in fact able to control it (Odria 2015). The availability of DP datives to control depictive secondary predication does not only explain the so far exceptional pattern of the causee (Zabala 1993 2003) and DOM object (Fernández & Rezac 2010 2016, Odria 2012 2014), but also the behavior of experiencer and possessor datives, which can equally control this kind of predication in Basque and Spanish.

The behavior of datives in bivalent unergatives is also addressed in comparison to DOM objects, showing that, in accordance with the rest of PP-like goals, these datives are unable to license secondary predication both in Basque (Fernández & Ortiz de Urbina 2009, Fernández & Rezac 2010 2016, Odria 2012, Ortiz de Urbina & Fernández 2016) and Spanish.

Fernández & Ortiz de Urbina (2010), Etxepare & Oyharçabal (2008abc 2009ab 2013), Etxepare (2014) and Ormazabal & Romero (2017).

Overall, the results in this chapter imply that, instead of determining its syntactic configuration, depictive secondary predication determines the original categorial status of the controller argument. For this reason, I argue that the possibility for DOM objects to control secondary predication does not necessarily entail that DOM objects are direct objects configurationally (Fernández & Rezac 2010 2016, Odria 2012 2014), but that these non-canonical objects are DPs categorically.

Once acknowledging that depictives are compatible with DP but not PP-like datives, certain implications arise with regards to the original category of the rest of dative arguments as well. On the one hand, the restriction on the controller should be accounted for structurally, taking the P head to be the trigger for preventing PP-like datives from controlling secondary predication. On the other hand, given that the licensing of secondary predication distinguishes both agreeing and non-agreeing goals from the rest of DP datives, a different origin should be posited for DP and PP-like datives. In particular, I propose that, contrary to the DP origin of DP datives, a unique PP source should be put forth for all kind of goal datives, be them agreeing or not. As a consequence, agreeing PP-like datives should differentiate from the non-agreeing ones by undergoing a further process of P-incorporation that would be followed by the Case licensing of the already DP argument, as has been proposed, among others, by Ormazabal & Romero (1998 2010 2017) and Albizu (2001 2009). To finish, I highlight that the combination of a structural analysis of depictive secondary predication with a derivational account of PP-like goal datives fits well with recent Complex Predicate analyses of secondary predication, as these are able to explain the fact that those arguments that generate as PP complements of V are unable to undergo the structural operation to license secondary predication.

1.4.3. Chapter 4: The PCC, datives and ν -Agree in DOM objects

In chapter 4, I analyze the Case licensing of DOM objects and claim that, as canonical absolutes, these non-canonical objects are licensed by entering into an Agree relation with the ν head (Odria 2012 2014, Fernández & Rezac 2016).

With the aim at justifying the ν -Agree relation held by DOM objects, the chapter provides further predictions regarding the behavior of agreeing datives like causees,

experiencers, goals and possessors. I argue that these datives receive inherent Case in [Spec, ApplP]. Causee, experiencer and possessors are merged in that position by means of external merge, while goals reach that position by internal merge, after undergoing P-incorporation (Ormazabal & Romero 1998 2010 2017, Albizu 2001 2009). The different categorical origin of DP and PP-like datives is thus vanished at [Spec, ApplP], since after the P-incorporation of goal datives, a DP syntactic category is exhibited by all of them. In this chapter, I argue that dative Case is syntactically realized as K, and thus, that the datives in [Spec, ApplP] are covered within a KP layer (Rezac 2008a 2011). This prevents them from undergoing regular Agree with a clausal Agree/Case locus and reduces the Agree relation these datives entail with ν to a defective [person] Agree.

In order to account for the Case licensing process carried out by DOM objects in particular and dative arguments in general, the chapter focuses on the *PCC* –also known as the *Me-Lui Constraint* (Perlmutter 1971, Bonet 1991 1994). The PCC refers to the incompatibility for first and second person objects to occur along with an agreeing dative. The constraint is syntactic in nature and arises in the ν P domain, when an agreeing inherent dative in [Spec, ApplP] c-commands a first or second person object and both of them are required to Agree with the same ν head. Adhering to the Agree/Case approach of the constraint, in this chapter I state that the PCC arises as a result of a Case licensing failure on first and second person objects (Anagnostopoulou 2003, Béjar & Rezac 2003, Rezac 2007 2008ab 2009ab 2011).

Building on Rezac (2011), I assume that when the PCC is caused by a goal dative, for many speakers, a phi-probe can be added to its originally defective P head in order to repair the effects of the constraint. This turns the non-phasal P head into a phasal head with its own active Agree/Case locus. Consequently, no P-incorporation takes place; the goal stays in its base position by Agreeing with the phi-probe in P, and ν Agrees entirely with the first or second person object. This leads to a construction where the agreement complex cross-references the first or second person object and the goal is realized as a non-agreeing PP (Albizu 1997a 2001 2009, Artiagoitia 2000, Etxepare & Oyharçabal 2008a, Rezac 2009b 2011, Oyharçabal & Etxepare 2012, Fernández & Rezac 2010 2016, Odria 2014). As expected by their DP categorical source, the PP repair strategy is generally untenable for causee, experiencer and possessors (Albizu 1997a 2001, Rezac

2009b 2011). Being generated as DPs, these datives bear no Agree/Case locus that can be activated by adding uninterpretable phi-features, and consequently, PCC effects remain unavoidable.

Having established the syntactic processes lying behind the effects as well as repairs of the PCC, in this chapter I examine how the constraint interacts with DOM objects. I demonstrate that first and second person DOM objects are targeted by the PCC in the same way as canonical absolutes, either when combining with a PP-like (Fernández & Rezac 2010 2016, Odria 2014) or a DP dative. Therefore, assuming that the PCC is a constraint that arises when the two internal arguments in the vP domain are required to Agree with v , I conclude that DOM objects Agree with the v head too.

When PCC effects are triggered by a goal, some DOM speakers are able to repair the constraint by adding a phi-probe to the defective P head of the goal, providing this way a separate Agree/Case locus for each of the internal arguments: P for the goal and v for the DOM object. As a consequence, the resulting finite verb agrees only with the DOM object and the goal happens to be realized as a non-agreeing PP dative, leading thereby to a double dative construction (Fernández & Rezac 2010 2016, Odria 2014). Due to their DP syntactic category, I show that the repair strategy adding uninterpretable phi-features is not feasible for DOM objects, as only the goal can appear as a full PP. This is straightforwardly explained by the fact that, contrary to goals, DOM objects do not generate with a P head to which uninterpretable phi-features can be added. As we will see, the PP repair strategy is not available for all speakers and verbs, and other PCC repairs are also attested when the constraint is triggered by a goal dative. Besides, when the PCC targets first or second person DOM objects combined with DP datives like causees, experiencers and possessors, the constraint happens to be generally irreparable, because being originally DPs, none of the datives is able to occur as a non-agreeing PP.

Departing from the double dative construction formed by a DOM and a goal dative, in this chapter I additionally analyze other combinations of different kind of datives. Reinforcing the separate categorial source for causee and goal datives, I show that in ditransitive causative constructions combining a goal and a causee dative, only the goal can occur as a non-agreeing PP (Deustuko Hizkuntzalaritza Mintegia 1989, Albizu

2001, Ortiz de Urbina 2003a, Duguine 2013, Odria 2014). As happens with DOM objects, causees are DPs originally, and thus, are unable to resort to the PP repair strategy. The possibility to have double dative constructions involving a causee and a goal dative leads us to two main conclusions. On the one hand, it means that, apart from PCC contexts, the PP repair strategy is independently available in ditransitive causative constructions where [Spec, ApplP] is already filled by a DP dative. On the other hand, in addition to the categorical distinction, it proves that DP and PP-like datives should also be generated in a different syntactic position in order to account for the existence of double dative constructions.

Finally, and following Rezac (2008a 2011), the last part of the chapter develops a clitic doubling analysis for the dative markers in the finite verbal form. Assuming that inherent datives are covered within a KP and Agree defectively with v , I claim that, before adjoining to v , the clitic coding these arguments moves to [Spec, v P] –as has been proposed, among others, by Matushansky (2006), Nevins (2011), Harizanov (2014) and Kramer (2014). The movement of the clitic head to [Spec, v P] is justified by two main pieces of evidence: (i) the intervention of the agreeing dative in restructuring unaccusative modal constructions (Albizu 2001, Albizu & Fernández 2002 2006, Ortiz de Urbina 2003b, Goenaga 2006, Rezac, Albizu & Etxepare 2014), and (ii) the intervention of the pro_{arb} causee in impersonal causative constructions (Albizu 2001, Ortiz de Urbina 2003a).

1.4.4. Chapter 5: DOM and the Derivational Distinctness Condition

Having argued that DOM objects pattern like canonical absolutes up to the Agree relation with v , chapter 5 makes a further step in the examination of the syntactic derivation of DOM objects and addresses the main aspect that makes DOM objects distinguish from absolutes and assimilate to the rest of agreeing inherent datives: the mechanism of dative Case assignment. In this chapter, I propose that the dative marking in DOM objects arises as a consequence of the Distinctness Condition put forth by Richards (2010), which bans the linearization of identical elements in an asymmetric c-command relation. Crucially, instead of assuming that Distinctness effects are only visible at the last step of the syntactic derivation –i.e., when the complement of a given

phase is transferred to Spell-Out, I claim that syntax is aware of the Distinctness Condition from the very beginning of the derivation, as suggested by Richards (2010: 86-87, 114, 117, 125-126). Therefore, I argue that, in Basque DOM varieties, when the subject –which bears a φ P rather than a DP label– is merged in [Spec, ν P], the problematic $\langle\varphi$ P, φ P \rangle linearization statement –formed by the subject and the object– ends up being avoided by adding a K head to the human and definite object. Given the phasal nature of K, this turns the $\langle\varphi$ P, φ P \rangle linearization statement into two separate statements, $\langle\varphi$ P \rangle and \langle KP \rangle , and the derivation converges as usual.

K corresponds to the differential marking in DOM objects and makes these objects morphologically identical to the rest of agreeing inherent datives in [Spec, ApplP], which are KPs as well. As happens with the datives in [Spec, ApplP], the KP in DOM objects bears an adjoined clitic head that m-merges with ν after moving to [Spec, ν P] (Matushansky 2006), explaining not only the dative marking in the nominal but also in the finite verbal form. It is thus the addition of the K head the syntactic mechanism that makes DOM objects exhibit the same morphology as the rest of dative arguments.

In its original version, Richards (2010) considers the Distinctness Condition to be applied at Spell-Out domains, when the complement of a given phase is transferred to the PF interface. Notwithstanding, I contend that Distinctness is instead active from the very beginning of the syntactic derivation. Therefore, the Distinctness effect leading to DOM does not yield when –after undergoing Object Shift– the object coincides with the subject in the TP Spell-Out domain, but in the ν P phase domain, as soon as the transitive subject enters the derivation in [Spec, ν P] (Richards (2010: 86-87, 114, 117, 125-126).

In Basque, the Derivational approach of the Distinctness Condition is justified by three main pieces of evidence: (i) the lack of evidence arguing for Object Shift, (ii) the possibility to have DOM in interrogative contexts where either the subject or the object is linearized higher than the TP Spell-Out domain, and (iii) the co-occurrence of DOM with the KP shell (Rezac et al. 2014) of the structural ergative subject in [Spec, TP]. These three pieces of evidence support the idea that, undergoing or not Object Shift, the Derivational version of the Distinctness Condition is superior to its original version,

because it accounts not only for the Distinctness effects that arise at Spell-Out, but also for those that arise throughout the syntactic derivation, explaining this way both the typical DOM in accusative languages like Spanish and the more atypical one in ergative languages like Hindi or Basque.

In addition to explain its presence in transitive configurations, the Derivational Distinctness Condition accounts straightforwardly for the absence of DOM in (i) ditransitive configurations where the object coincides with an agreeing inherent dative in [Spec, ApplP], and (ii) in the derived transitive construction formed with **edun* ‘have’, where the ergative subject is generated as an oblique argument. In ditransitives, the ApplP placed in between VP and vP prevents the object from coinciding with the transitive subject in the same phase domain. Given the phasal nature of ApplP (McGinnis 2001ab 2004), the object will be sent to Spell-Out by the time the subject enters the derivation in [Spec, vP], and hence, no Distinctness effect will arise between the subject and the object. This follows from the fact that the Spell-Out domain of a given phase is transferred to PF as soon as the phase is completed (Chomsky 2000 2001). As expected, the situation happens to be different when the ditransitive configuration contains a non-agreeing goal dative, as happens in PCC-affected contexts. Given that the goal is involved in a lower phasal PP, the object coincides as in the rest of transitive constructions with the subject in [Spec, vP] and the K head is added in order to avoid a Distinctness effect. The availability to have DOM in ditransitive contexts is thus independent from the original DP vs. PP category of the dative argument, as it depends exclusively on whether the dative projects an ApplP or not. Regardless of their original syntactic category, only those datives in [Spec, ApplP] ban the differential marking, which explains that in ditransitives DOM is only available with first and second person objects. Along with Basque, I show that the Derivational version of the Distinctness Condition captures the distribution of DOM in ditransitives involving agreeing as well as non-agreeing datives in Spanish too, since DOM and agreeing datives are also known to be in complementary distribution (Demonte 1994, Romero 1997, Ormazabal & Romero 2013abc).

To finish, I show that the lack of DOM in the derived transitive construction built up with **edun* ‘have’ is equally explained by the Derivational Distinctness Condition.

Contrary to transitives, the ergative subject in this kind construction is generated as an oblique argument in an ApplP/PP (Etxepare & Uribe-Etxebarria 2012), and becomes a KP as soon as it moves to [Spec, TP]. Thus, given that the object does not coincide with it in any phase domain of the syntactic derivation, there will be no need for it to receive the phasal K head.

2. DOM IN BASQUE AND ACROSS-LANGUAGES

2.1. INTRODUCTION

This chapter aims at describing the distribution of Basque DOM in light of similar constructions attested across-languages. Section 2.2 provides a brief description of Basque DOM, emphasizing that, as happens in many other languages, the differential marking –identical to the dative marking in indirect objects– is targeted by animacy and specificity. In order to situate the phenomenon under study in a broader cross-linguistic scene, section 2.3 reviews the DOM of other languages that are governed by animacy and/or specificity as well, and due to their similarities with Basque DOM, pays special attention to the situation in Hindi and Spanish. Hindi DOM is covered in section 2.3.1 and Spanish DOM in 2.3.2. Section 2.4 delimits the distribution of Basque DOM. On the one hand, in 2.4.1 I analyze on closer inspection the factors determining Basque DOM, which include animacy (section 2.4.1.1), specificity (2.4.1.2) and –in a subtler way– clausal factors like tense and finiteness (section 2.4.1.3). On the other hand, section 2.4.2 compares DOM objects with the dative object of bivalent unergative predicates of the *lagundu* ‘accompany, help’ type. In that section, I show that, contrary to what happens in DOM objects, the dative marking in the object of bivalent unergatives does not depend on factors like animacy and specificity, and clausal properties like tense and finiteness are irrelevant as well. Besides, the object of these predicates is mostly a goal, and thus contrasts with the theme theta-role exhibited by DOM objects. To conclude, a summary of the chapter is given in section 2.5.

2.2. A BRIEF DESCRIPTION OF THE PHENOMENON

Basque is an ergative language: the subject of transitive predicates is marked ergative and the object absolutive, as the subject of intransitive predicates. This marking is attested both in the nominal and in the finite verbal form. Take, for instance, the transitive sentence in (1).

- (1) Zu-k ni ikusi nauzu
 You-E I-A see AUX[1sgA-2sgE]
 ‘You have seen me.’

In (1), the subject is marked by ergative case (-*k*) and the object by absolutive case (- \emptyset). The auxiliary selected is the transitive one, **edun* ‘have’, and it cross-references the ergative and absolutive arguments by means of their respective markers: *n-* for the first person singular absolutive and *-zu* for the second person ergative.

Contrary to what happens in Standard as well as other varieties of Basque, certain southwestern varieties⁶ tend to mark the object differently, by means of the dative. In these varieties, instead of –or along with– (1), the pattern attested with transitive predicates is the one in (2).

- (2) Zu-k ni-ri ikusi didazu
 you-E I-D see AUX[1sgD-2sgE]
 ‘You have seen me.’

In (2), the same transitive predicate *ikusi* ‘see’ is used. Nevertheless, the object is marked dative, instead of absolutive: it bears dative case (-(*r*)*i*) and is cross-referenced by the dative marker (-*da-*) in the finite verbal form. Besides, the dative marker in the verb follows the *-i-* morpheme, a morpheme that appears whenever a dative argument is cross-referenced by the verbal complex (Trask 1997, Elordieta 2001, Hualde 2003, Rezac 2006, Fernández 2012 2013 2015ab).

The marking of the object in (2) is morphologically identical to the marking of the indirect object in a ditransitive sentence like (3).

- (3) Zu-k ni-ri liburua eman didazu
 you-E I-D book.A give AUX[3sgA-1sgD-2sgE]
 ‘You have given me the book.’

In (3), the subject is marked ergative (-*k*), the direct object absolutive (- \emptyset) and the indirect object dative (-(*r*)*i*), as the object in the transitive construction in (2). Apart from being marked in the nominal, the three arguments are also cross-referenced by the finite verbal form, which shows the same shape as that in (2): the second person

⁶ As already said in chapter 1, southwestern Basque varieties are those which are in contact with Spanish.

ergative is coded by *-zu* and the first person dative by *-da-* –in Basque, the third person absolutive is not overtly marked in the verbal form.

Moreover, in transitive constructions not all kind of objects are able to bear dative marking. Non-human objects like *ordenagailua* ‘computer’ are never marked dative (4), and generally speaking, neither are indefinite objects like *neska bat* ‘a girl’ in a sentence like (5a).

(4) a. Ordenagailua ikusi dut
 computer.A see AUX[3sgA-1sgE]
 ‘I have seen the computer.’

b. *Ordenagailua-ri ikusi diot
 computer-D see AUX[3sgD-1sgE]
 ‘I have seen the computer.’

(5) a. Neska bat ikusi dut
 girl one.A see AUX[3sgA-1sgE]
 ‘I have seen a girl.’

b. ??/*Neska bat-i ikusi diot
 girl one-D see AUX[3sgD-1sgE]
 ‘I have seen a girl.’

The examples in (4) and (5) show that the dative marking in transitive predicates is conditioned by the animacy and specificity –or referentiality– of the object (Fernández & Rezac 2010 2016, Mounole 2012, Odria 2012 2014, Rodríguez-Ordóñez 2013 2016).⁷

In section 2.4.1, further details are given regarding the nature of the objects that are able to display dative marking. As we will see, the fact that the marking of the object is influenced by animacy and specificity does not necessarily imply that all kind of human and definite objects carry dative marking. On the one hand, for some varieties/speakers, the phenomenon can even be more restricted, and instead of humanness; the cutting point made by animacy can be person as well. This means that in those cases the dative

⁷ Contrary to the example in (4b), that in (5b) is marked as ??/*. Although none of the consultants has taken it as grammatical, there are some exceptional instances of DOM with indefinites like *neska bat* ‘one/a girl’ in the spontaneous speech corpora.

marking occurs with first and second but not third person objects. On the other hand, the dative in examples like (2) is optional for many Basque varieties/speakers, and as such, it does not appear in all the possible cases, as the same object can also be marked absolutive.⁸

Be that as it may, for the time being, recall that in some southwestern varieties the marking of the object is governed by factors like animacy and specificity. This situates examples like (2) in the general scenario of *Differential Object Marking* (DOM), as coined by Bossong (1985), a widely attested phenomenon.

In DOM, objects showing certain properties receive a differential case and/or agreement/clitic marking (Bossong 1985 1991, Comrie 1989, Lazard 2001, Aissen 2003). DOM is attested in at least 300 languages of the world⁹ (Bossong 1985: VIII, Aissen 2003: 436), and in many cases, the differential marking depends on the animacy and specificity of the object (Bossong 1991: 160). Besides, the differential marking tends to show an identical morphology to the dative marking of indirect objects (Bossong 1991: 154, 157-158, Aissen 2003: 446). With few exceptions, Romance and Semitic languages are clear examples of this typological tendency, and so are other modern Indo-Aryan languages like Hindi or Punjabi and Amerindian languages like Guaraní and Aymara (Bossong 1991: 157).

Hence, once we classify the pattern in (2) as an instance of DOM, it is quite clear that the Basque varieties under study follow the two main cross-linguistic tendencies just mentioned. On the one hand, the marking of the object is determined by animacy and specificity, and on the other, the differential marking is morphologically identical to the dative. These two patterns also occur in Hindi and Spanish, two widely mentioned

⁸ Being a non-Standard and socio-linguistically stigmatized pattern, Basque DOM cannot be regarded as a uniform and invariable phenomenon, as it is subject to both dialectal as well as idiolectal variation. See the appendix for further socio-linguistic information on Basque DOM.

⁹ DOM is widespread within the Indo-European family, especially in Indo-Iranian and Romance (Aissen 2003:439). Apart from the Indo-European phylum, DOM also occurs in Finno-Ugric, Dravidian, Turkic, Mongolic, Tungusian, Tibeto-Burmese, Munda, Bantu, Pama-Nyungan, Micronesian, Uto-Aztec, Chibcha and Tupi- Guaraní (Bossong 1991: 144).

DOM languages. Taking this into account, special attention will be given to these two languages in section 2.3 –section 2.3.1 deals with the DOM in Hindi and 2.3.2 with the DOM in Spanish. Analyzing the configurations of other languages than Basque will let us test some of our hypotheses among languages with different typological characteristics but similar behavior with regards to DOM. Before going through the description of the DOM found in these two languages, in the next section I first show how animacy and specificity can alter the marking of the object in other DOM languages.

2.3. DOM ACROSS-LANGUAGES

As we have seen before, cross-linguistically, animacy and specificity can affect the marking of the object either separately or inter-acting with each other. Although in most of the languages DOM is triggered by both animacy and specificity (Bossong 1991, Aissen 2003, Klein & de Swart 2011), in some of them, the marking of the object depends only on either specificity or animacy.

Among the languages showing a DOM that is based only on the animacy of the object Bossong (1991: 160) gives the example of Russian. As illustrated in (6), the animate nominal *dorogix* ‘dear guests’ is marked genitive, and the inanimate *dorogije veščī* ‘expensive things’ receives nominative case, the unmarked one. Thus, in Russian, regardless of specificity, the marking of the object is exclusively contingent on its value for animacy, as non-specific animate objects receive the differential marking.¹⁰

- (6) a. Ja vstreĕa-ju dorog-ix gost-ej
 receive-1sg dear-GEN.pl guest- GEN.pl
 ‘I receive dear guests.’
- b. Ja pokupaj-ju dorog-ije vešč-i
 I buy-1sg dear- N.pl thing- N.pl
 ‘I buy expensive things.’

¹⁰ The glosses in the examples taken from other sources are modified according to the abbreviations used in this dissertation.

On the other side, in other languages, DOM is only driven by specificity. In Turkish, for instance, the accusative marking *-(y)i* correlates with an specific interpretation of the object. As explained by Enç (1991: 4-5), accusative marked objects like (7a) are interpreted as specific, whereas unmarked objects like (7b) are obligatorily interpreted as non-specific.

(7) a Ali bir piano-yu kiralamak istiyor
 Ali one piano-ACC to-rent wants
 ‘Ali wants to rent a certain piano’

b Ali bir piyano kiralamak istiyor
 ‘Ali wants to rent a (non-specific) piano.’

Along with Turkish, Hebrew displays a definiteness-based DOM pattern, as only definite objects are marked with the preposition *et*. Consider the examples in (8) provided by Danon (2006: 3). In (8a), the definite object *haitonim* ‘the newspapers’ must obligatorily be preceded by *et*. On the contrary, the indefinite object (*kama*) *itonim* ‘(some) newspapers’ is not able do so. This shows that the presence of the preposition *et* is linked to definiteness, regardless of animacy.

(8) a. Dan kara *(et) ha-itonim
 Dan read DOM the newspapers
 ‘Dan read the newspapers.’

b. Dan kara (*et) (kama) itonim
 Dan read DOM some newspapers
 ‘Dan read (some) newspapers’

Finally, there are other languages in which DOM is favored by a combination of both animacy and specificity. As in Basque, this happens to be the case in Chaha, Hindi and Spanish, among many others.

In Chaha, animate and specific objects of transitive predicates are obligatorily marked with the prefix *yə-*, as occurs in (9a). On the contrary, inanimate and non-specific objects bear no marking at all, as in (9b) (Richards 2010: 26).

(9) a. Giyə yə-fərəz nək^wəsənim
 dog DOM-horse bit
 ‘A dog bit a (specific) horse’

b. Giyə fəɾəz nəkəsəm
 dog horse bit
 ‘A dog bit a (non-specific) horse.’

Interestingly, Chaha is another DOM language in which the differential marking couples animate and specific objects with indirect objects. In (10), we can observe that the same preposition used for animate and specific objects is now used to mark a goal indirect object (Richards 2010: 29).

(10) Č'am^wɪt yə-tkə x^wɪta giyə awəčnim
 Č'am^wɪt yə-child the dog gave
 ‘Č'am^wɪt gave the child a/the dog.’

Along with Chaha, Hindi and Spanish DOM are also relevant when comparing to Basque DOM. Let us now see the main aspects of the DOM in these two languages with more detail.

2.3.1. DOM in Hindi

In Hindi, animate and/or specific objects carry the postposition *-ko* –see, among many others, Mahajan (1990), Butt (1993), Bhatt & Anagnostopoulou (1996) and Bhatt (2006). As shown in (11a), definite or indefinite human-referring objects like *bacce* ‘a/the child’ bear the postposition *-ko*.¹¹ On the contrary, indefinite inanimate objects like *haar* ‘necklace’ bear no marking at all (Mohannan 1994: 80, 85).

(11) a. Ilaa-ne bacce-ko uTaayaa
 Ilaa-E child-DOM lift.PERF
 ‘Ilaa lifted a/the child.’

 b. Ilaa-ne haar uTaayaa
 Ilaa-E necklace lift.PERF
 ‘Ilaa lifted a/the necklace.’

In Hindi, animacy is the main factor triggering DOM (Aissen 2003: 461) –as we will see, this is also the situation in Basque and Spanish. In general terms, DOM appears to be obligatory for human (and some animate) objects, and optional for inanimates. For inanimate objects, optionality correlates with interpretation, as *-ko* can only occur with

¹¹ *-ko* is possible with indefinites only if they are human or animate, as in (11a) (Aissen 2003: 458).

those that are definite (Aissen 2003: 458, 465, Bhatt 2006: 2-3). In order to illustrate so, Aissen (2003: 465) cites the example in (12) provided by Mohanan (1994: 87-88).

- (12) Ravii-ne kacce ele-ko kaataa
 Ravii-E unripe banana-DOM cut.PERF
 ‘*Ravi cut the unripe banana.*’

Hindi is, thus, similar to Basque, as DOM is influenced by both animacy and specificity. Notwithstanding, the two languages differ in the interrelation between these two factors. In contrast to Basque, the relation between animacy and specificity is not indispensable in all cases in Hindi –an object like ‘unripe banana’ in (12) would never be differentially marked in Basque.

All in all, what is important for the purposes of the discussion is that, like Basque, Hindi DOM is triggered by animacy and specificity.

Another important pattern shared by Hindi and Basque is that the differential marking is identical to the dative marking of indirect objects. Consider, for instance, the example in (13) given by Bhatt & Anagnostopoulou (1996: 11). In (13), the indirect object *Aditi* is marked with *-ko*, and being inanimate and indefinite, the direct object *kitaab* ‘a book’ is left unmarked.

- (13) Ram-ne Aditi-ko kitaab dikhaa-ii
 Ram-E Aditi-DOM book.F show-PERF.F
 ‘*Ram showed a book to Aditi.*’

In addition to the triggering factors and the morphological similarity to indirect objects, Hindi DOM exhibits another aspect that also occurs in Basque. This is the possibility to have a DOM object with an ergative marked subject. In Hindi, the subject of transitive predicates is marked ergative (*-ne*) in past/perfect tenses and nominative (*-ø*) in non-past/non-perfect tenses. Hence, DOM is independent from the ergative or nominative marking of the subject, as it is possible both in past/perfect as well as non-past/non-perfect tenses, co-occurring both with ergative as well as nominative subjects. The examples in (11)-(13) show the co-occurrence of DOM with an ergative subject, and the one in (14) the co-occurrence of DOM with a nominative subject.

- (14) Mina ek bacca/-e(-ko) uthaa rahii hai
 Mina.F a/one child-DOM hit PROG.F be.PRES.3sg
 ‘Mina is picking up a child / a particular child.’

Recall that, as explained in the appendix, the configuration with an ergative subject and an accusative/dative object is typologically less common than the one involving a nominative subject and an accusative object. As expected both in Linguistic Typology as well as Case Theory within Universal Grammar, only one of the two arguments of a transitive predicate is overtly marked in the latter, and in contrast to the canonical pattern, both the subject and the object are overtly marked in the former. Chapter 5 addresses this issue from a Case Theoretic approach.

2.3.2. DOM in Spanish

A similar pattern to Basque and Hindi is attested in Spanish. In Spanish, animate and specific objects are marked by the preposition *a*, and inanimate and non-specific ones are left unmarked –see, among many others, Pensado (1995), Bruggé & Brugger (1996), Torrego (1998), Leonetti (2004), Rodriguez-Mondoñedo (2007), Fábregas (2013) and Ormazabal & Romero (2013abc). This is illustrated in the examples in (15), provided by Ormazabal & Romero (2013a: 222). In (15a), the animate and specific object *la niña* ‘the child’ bears *a*-marking. On the contrary, although specific, the inanimate *el libro* ‘the book’ is unable to be preceded by *a* in (15b), and the same thing happens with the animate generic object *niñas* ‘children’ in (15c)

- (15) a. He encontrado *(a) la niña
 have found.1sg DOM the child.F
 ‘I have found the girl.’
- b. He encontrado (*a) el libro
 have found.1sg DOM the book
 ‘I have found the book.’
- c. He encontrado (*a) niñas
 have found.1sg DOM children.F
 ‘I have found girls.’

As happens in Hindi and in other Romance languages (Bossong 1991: 160-161), animacy prevails over specificity when driving DOM in Spanish (Brugger & Brugé 1996, Leonetti 2004). In section 2.4, we will see that Basque DOM behaves similarly in

this regard, given that animacy has greater impact than specificity when determining the marking of the object.

Contrary to the case system attested in Basque and –partially– Hindi, Spanish is a nominative language, as the subject of both transitive and intransitive predicates bears nominative case, the unmarked case, while the object carries accusative case, the marked one. Hence, the differential marking on the object leads to a typologically expected configuration, with only one of the two arguments of a transitive construction being overtly marked.

In spite of this, Spanish DOM is still akin to Basque and Hindi in exhibiting a marker that is morphologically identical to that found with indirect objects. This is shown in (16). In (16), the indirect object is preceded by the same *a*-marker carried by the animate and specific direct object in (15a).

- (16) Le he comprado un libro a la niña
 3sgD have bought.1sg one book to the child.F
 ‘I have bought the child a book.’

Despite their similarities, Spanish and Hindi behave different to Basque in having the differential marking only in the noun phrase, and not in the verbal complex. As explained in section 2.2, in Basque DOM occurs not only in the nominal, but also in the finite verbal form, as in (2), repeated here as (17).

- (17) Zu-k ni-ri ikusi didazu
 you-E I-D see AUX[1sgD-2sgE]
 ‘You have seen me.’

In this respect, it is worth mentioning that the Spanish spoken in the Basque Country (henceforth, Basque Spanish)¹² exhibits a pattern which makes Spanish DOM even more similar to Basque DOM, as the differential marking is not only attested in the nominal, but also in the clitic system of the verbal complex. The phenomenon I am referring to is known as *Basque Spanish leísmo*, one of the most characteristic aspects

¹² Following Landa (1995), I use the term Basque Spanish to refer to the Spanish variety spoken in the Basque speaking area

of Basque Spanish syntax (Franco 1993, Fernández-Ordóñez 1994 1999, Landa 1995, Urrutia-Cárdenas 1995 2003).¹³

Basque Spanish is a *leísta* dialect: the dative clitic *le(s)* is used instead of the accusative *lo(s)/la(s)* when referring to an animate object.¹⁴ This is illustrated in the examples in (18), where the inanimate object *el coche* ‘the car’ is coded by the accusative clitic *lo*, whereas the dative *le* pronominalizes the animate objects *el chico* ‘the boy’ (19) and *la chica* ‘the girl’ (20).¹⁵

- (18) a. Vi el coche aparcado
 saw.1sg the car parked
 ‘I saw the car parked.’
- b. Lo/*le vi aparcado
 3sgACC/3sgD saw.1sg parked
 ‘I saw it parked.’
- (19) a. Vi al chico contento
 saw.1sg DOM the boy happy
 ‘I saw the boy happy.’
- b. Le vi contento
 3sgD saw.1sg happy
 ‘I saw him happy.’
- (20) a. Vi a la chica contenta
 saw.1sg DOM the girl happy
 ‘I saw the girl happy.’

¹³ The Basque Spanish *leísmo* is also referred as *real leísmo* (Fernández-Ordóñez 1999) or *animated leísmo* (Urrutia-Cárdenas 1995 2003).

¹⁴ Contrary to what happens in Basque Spanish, the *leísmo* in Standard Spanish refers to the coding of masculine, singular (usually personal) direct objects by the dative clitic *le*, substituting this way the accusative *lo* –and only exceptionally *la* (Fernández-Ordóñez 1994: 7 1999: 1319, Landa 1995: 152).

¹⁵ Urrutia-Cárdenas (2003: 292) mentions that the use of *le(s)* can also be extended to inanimate objects. Nevertheless, I agree with Landa (1995: 8) in claiming that such pattern is hardly acceptable among Basque Spanish speakers.

b. Le vi contenta
 3sgD saw.1sg happy
'I saw her happy.'

Being affected by animacy, Basque Spanish *leísmo* can be considered another instantiation of the DOM phenomenon. Note that it coincides with Basque DOM in two main respects. On the one hand, it is driven by animacy –and also specificity, as pronominal clitics are always interpreted as specific, and on the other, the same dative clitic is used to cross-reference both indirect and animate direct objects. The morphological identity between direct (21a) and indirect objects (21b) is exemplified in (21).

- (21) a. Le llevé a casa
 3sgD brought.1sg to house
'I brought him/her at home.'
- b. Le compré un libro
 3sgD bought.1sg one book
'I bought him/her a book.'

Thus, Basque Spanish *leísmo* shares important aspects not only with Basque, but also with Hindi and the Spanish *a*-marking.

Besides, Basque Spanish *leísmo* is special in allowing clitic doubling with *a*-marked objects in their canonical object position (Franco 1993, Landa 1995, Fernández-Ordóñez 1999). This is illustrated in the examples in (22).¹⁶

- (22) a. Le he llevado al niño a casa
 3sgD have carried.1sg DOM the child.M to house
'I have carried the child at home.'

¹⁶ This is rejected in the Standard *leísmo*, where the dative clitic is only able to double indirect objects. In Standard Spanish, the same object would only be marked in the nominal, as in (i) and (ii).

- (i) He llevado al niño a casa
 have carried.1sg DOM child.M to house
'I have carried the child at home.'
- (ii) Conozco a Jon desde pequeño
 know.1sg DOM Jon since child
'I know Jon since he was a child.'

b. Le conozco a Jon desde pequeño
 3sgD know.1sg DOM Jon since child
 'I know Jon since he was a child.'

In (22), the differential marking is found both in the nominal –i.e., *a*-marking– and in the clitic system –i.e., *le* instead of *la* in (22a) and *lo* in (22b). This makes the *leísmo* in Basque Spanish even more similar to Basque DOM. In fact, as observed by Landa (1995: 116), in Basque Spanish, *a*-marked objects are frequently doubled by the dative clitic *le(s)*. In the same vein, the examples in (19a) and (20a) would sound more natural if the *a*-marked object would be doubled by the dative clitic *le*.

Besides, the examples in (22) show that clitic doubling depends on *a*-marking (Landa 1995: 117). That is, those objects that are doubled by a clitic must be *a*-marked, which means that the objects allowing clitic doubling are also animate and specific –or more precisely, animate and presuppositional, as argued by Franco (1993) and Landa (1995).¹⁷ Consider the sentences in (23). In (23a), the object *la niña* ‘the child’ is *a*-marked, and the doubling with the dative clitic *le* is acceptable. On the contrary, in (23b), the object *el libro* ‘the book’ is inanimate, and thus, non-*a*-marked. As a consequence, doubling it with a dative or accusative clitic is ruled out. The same is true for animate non-specific objects like *un secretario* ‘a secretary’ in (20c).

¹⁷ Landa (1995: 162) claims that, instead of specificity, Basque Spanish clitic doubling is constrained by presuppositionality and gives the example in (i) to support her hypothesis.

(i) Los burócratas le llegan a cansar a uno
 the bureaucrats 3sgD manage to tire DOM one
 'Bureaucrats end up boring you.'

The clitic doubled object in (i) cannot be interpreted as specific –*uno* is a generic animate pronoun, and the sentence is still acceptable in Basque Spanish. Based on this fact, Landa concludes that clitic doubling in Basque Spanish is only possible with animate and presuppositional objects. This would also explain the ungrammaticality of examples like (ii) and (iii), which contain non-presuppositional objects (Landa 1995: 165).

(ii) ???Les vi a bastantes hombres
 3plD saw.1sg DOM enough men
 'I saw quite a few men.'

(iii) *Les necesito a seis hombres
 3plD need.1sg DOM six men
 'I need six men.'

- (23) a. Le he visto a la niña
 3sgD have seen.1sg DOM the child.F
 ‘I have seen the child.’
- b. (*Le/lo) he visto el libro
 3sgD/3sgACC have seen.1sg the book
 ‘I have seen the book.’
- c. (*Le/lo) busco un secretario que sepa ingles
 3sgD/3sgACC look for.1sg one secretary that knows English
 ‘I look for a secretary that knows English.’

Note that this is also the case in Basque DOM. In order for the verbal complex bear a dative marker the nominal it cross-references must also bear dative case. Otherwise, if the nominal is left unmarked –i.e., with absolutive case– the same sentence becomes ungrammatical.

- (24) a. Zu-k ni-ri ikusi didazu
 you-E I-D see AUX[1sgA-2sgE]
 ‘You have seen me.’
- b. *Zu-k ni ikusi didazu
 you-E I.A see AUX[1sgA-2sgE]
 ‘You have seen me.’

Summing up, Basque DOM and Basque Spanish DOM –in its two instantiations, *a*-marking and *le* clitic– coincide in a great extent: (i) the factors triggering DOM are animacy and specificity, (ii) the differential marking is morphologically identical to the marking of the indirect object, and (iii) together with the noun phrase, the differential marking is also realized in the clitic system. These shared aspects are interesting because, as highlighted in the appendix, DOM in Basque only exists in the dialects that are in contact with Spanish. In the French spoken area, direct objects are always marked absolutive.¹⁸

¹⁸ In the literature on the topic, it has been suggested that the *leísmo* in Basque Spanish is influenced by Basque (Fernández-Ordóñez 1994 1999, Landa 1995). As Basque makes no gender distinction on direct objects, this could have reinforced the use of the dative *le(s)* instead of *lo(s)* for masculine objects and *la(s)* for feminine ones. This contact situation has also been analyzed in the opposite direction. Mounole (2012), for instance, attributes the spread of Basque DOM to the influence of Spanish, claiming that Basque DOM is at least reinforced by the contact with Spanish. Other authors like Austin (2006 2015) or

2.4. DELIMITING THE DISTRIBUTION OF BASQUE DOM

In section 2.4.1, I deal with the main factors that condition DOM in Basque. As mentioned since the very beginning of the chapter, the main factors lying behind Basque DOM are animacy and specificity, as dative objects of transitive predicates are generally human and definite (Fernández & Rezac 2010 2016, Mounole 2012, Odria 2012 2014, Rodríguez-Ordóñez 2013 2016). Along with animacy and specificity, other factors independent from the nature of the object can also favor the dative marking of the object –albeit in a more subtle way. These are tense and finiteness (Fernández & Rezac 2010 2016). The description of the influence of each of these factors is based on two main (oral) sources: syntactic questionnaires carried out with speakers of different varieties and the transcribed utterances of the unrecorded spontaneous speech of a number of speakers of different varieties.¹⁹

In 2.4.2, DOM objects are distinguished from other datives that also occur in an ergative-dative frame, that is to say, from those that appear with bivalent unergative verbs of the *lagundu* ‘accompany, help’ type (Etxepare 2003, Fernández & Ortiz de Urbina 2009 2010 2012, Ortiz de Urbina & Fernández 2016). Animacy, specificity tense and finiteness can only affect the marking of the object in transitive verbs like *ikusi* ‘see’, but not in bivalent unergatives like *lagundu* ‘accompany, help’. By determining the driving factors as well as the kind of verbs with which they appear, the distribution of Basque DOM will thus be delimited. This will provide us the basis to analyze their syntactic behavior in the following chapters.

Rodríguez-Ordóñez (2013 2016) go even further and claim that Basque DOM is not only reinforced but also induced by the contact with Spanish –see the appendix for further details on this topic. This is, thus, an open issue.

¹⁹ Being a non-Standard stigmatized phenomenon, it is difficult to find written instantiations of DOM in Basque. Most of the written testimonies are found in dialectal grammars and belong to transcriptions of oral conversations of (mostly elderly) speakers of local varieties. These pieces of work are usually limited to saying whether the phenomenon under study is present or not in the described variety, and just a few sentences produced by native speakers are provided as an example of it.

2.4.1. Main factors governing Basque DOM

2.4.1.1. Animacy

Animacy is the main factor conditioning the marking of the object in Basque DOM, as dative marking is only accepted with human-referring objects (Fernández & Rezac 2010 2016, Mounole 2012, Odria 2014, Rodríguez-Ordóñez 2013 2016). This is illustrated in the examples in (25). The object in (25a), *Jon*, is a human being; it bears dative case (-*r*) and it is cross-referenced by the dative marker (-*o*-) in the finite verbal form. On the contrary, the object in (25b), *telebista* ‘television’ is not a human being, and as a consequence, dative marking is ruled out. As shown in (25c), non-human objects like *telebista* ‘television’ can only display absolutive marking.²⁰

- (25) a. Jon-i ikusi diot
Jon-D see AUX[3sgD-1sgE]
‘I have seen Jon.’
- b. *Telebista-ri ikusi diot
television-D see AUX[3sgD-1sgE]
‘I have seen the television.’
- c. Telebista ikusi dut
television.A see AUX[3sgA-1sgE]
‘I have seen the television.’

The data collected in informal conversations are also consistent with this fact, as I have found no dative marking with non-human objects. Therefore, it seems reasonable to conclude that, in order to be dative marked, the object of a transitive predicate has to be human. For most speakers, this excludes not only inanimate objects like *telebista*

²⁰ Some speakers consider examples like (25a) a bit weird, and add that the dative marking of a third person object like *Jon* would be more natural with other verbs. This may be due to the social stigmatization of the DOM with the verb *ikusi* ‘see’, as it is one of the most corrected *errors* at school as well as Basque academies. In spite of that, it is important to highlight that the impossibility to have the dative marking with non-human objects like *telebista* ‘television’ is a robust generalization among the consulted speakers.

‘television’, but also non-human animate objects like *txakurra* ‘dog’, which generally bear absolutive marking as well.²¹

Even though the main cutting point between DOM and non-DOM objects is determined by humanness, the category of person deserves special attention too (Fernández & Rezac 2010 2016, Mounole 2012, Odria 2012 2014, Rodríguez-Ordóñez 2016). Many DOM speakers make a further distinction within human objects and distinguish between first and second person objects on the one hand, and third person objects on the other.²² As a consequence, it is easier to find absolutive marking with third person objects than with first and second person. This distinction is realized in different manners. For some speakers, only first and second person can carry dative marking with a verb like *ikusi* ‘see’. This is the case of a speaker from Zumaia. (26a) and (26b) would be acceptable for this, but not (27a), as the object should be absolutive marked, as in (27b). Observe that the object is first person in (26a), second person in (26b) and third person in (27a) and (27b).

- (26) a. Kali-an ikusiyazu
 street-INES see.AUX[1sgD-2sgE]
 ‘You have seen me in the street.’
- b. Kali-an ikusizut
 street-INES see.AUX[2sgD-1sgE]
 ‘I have seen you in the street.’

²¹ With respect to non-human animate objects, some of the consulted speakers admit that animals like *txakurra* ‘dog’ may exceptionally bear the differential marking in a sentence like *I’m carrying the dog for a walk or I’m carrying the dog to the veterinarian*. Notwithstanding, the dative marking with animals is far from being a common pattern and may probably be particular of certain verbs and speakers. The marginal situation of non-human animates is also observed by Landa (1995: 144) when exploring the distribution of Basque Spanish *leísmo*. This author adds that the most acceptable use of *leísmo* occurs with human objects and the least acceptable with inanimates, while non-human animate objects would be somewhere in between. According to Aissen (2003: 456), this is not uncommon among the languages of the world. Aissen states that it is cross-linguistically infrequent to have the differential marking with all and only human-referring objects, given that animacy-sensitive DOM usually extends beyond or retracts within the human category.

²² This distinction is neither uncommon cross-linguistically (Aissen 2003: 445-446).

(27) a. *Jon-i kali-an ikusiyot
 Jon-D street-INES see.AUX[3sgD-1sgE]
'I have seen Jon in the street.'

b. Jon kali-an ikusiet
 Jon.A street-INES see.AUX[3sgA-1sgE]
'I have seen Jon in the street.'

The distinction between first and second vs. third person objects is not so rigid for other speakers. A speaker from Larrabetzu, for instance, finds DOM with first and second person very natural, but prefers the absolutive for the third one –although the dative is acceptable in this case too. This speaker generally marks first (29a) and second (29b) person objects with dative, yet uses the dative (29a) and –more naturally– the absolutive (29b) for third person.

(28) a. Ez dostezu ikusi?
 not AUX[1sgD-2sgE] see
'Haven't you seen me?'

b. Ikusi dotsut kontzertu-en
 see AUX[2sgD-1sgE] concert-INES
'I have seen you in the concert.'

(29) a. Leire-ri ikusi dotset kotxe barri-en
 Leire-D see AUX[3sgD-1sgE] car new-INES
'I have seen Leire in the new car.'

b. Leire ikusi dot kotxe-an pasetan
 Leire.A see AUX[3sgA-1sgE] car-INES going
'I have seen Leire going in the car.'

The data in the spontaneous speech corpora are once again congruent with the intuition that first and second person are more commonly marked dative in comparison to third person.

The distinct behavior attested between first and second vs. third person is also mentioned in some descriptions of dialectal varieties. Hualde, Elordieta & Elordieta (1994: 125-127), for instance, notice that, in Lekeitio Basque, DOM occurs more frequently with first and second person than with third. Likewise, Ibarra (1995: 427) reports that in Ultzama Basque, first and second person objects are generally marked dative, while DOM with third person objects is just optional. Similar results are

obtained in Gernika Basque too. As demonstrated by Rodríguez-Ordóñez (2016), DOM is more frequently attested with first and second person than with third person. Furthermore, it is important to note that, generally speaking, the DOM examples provided by dialectal grammars involve usually objects of first and second person.

Before concluding the discussion on the influence of person, I would like to add a note on the use of DOM with the familiar second person *hi*. Apart from the second person *zu*, Basque has another second person pronoun, namely *hi*, which is only used in familiar contexts, when there is a close relationship between the speaker and the addressee.²³ Interestingly, DOM is available with *hi* too. This is the case for the consulted speakers from Zumaia (30a), Oñati (30b) and Elgoibar (30c), among others.

- (30) a. Kali-an ikusiyat
street-INES see.AUX[2(fam)sgD-1sgE]
'I have seen you in the street.'
- b. Kali-an ikusi dostat
street-INES see AUX[2(fam)sgD-1sgE]
'I have seen you in the street.'
- c. Kali-an ikusi dixat
street-INES see AUX[2(fam)sgD-1sgE]
'I have seen you in the street.'

Overall, in spite of its significant influence, in this thesis, person is not considered a factor independent from animacy and specificity, but rather a subcategory of animacy itself. This is justified by four main points. First, considering ‘first and second person’ as the positive value for person and ‘human’ for animacy, we see that an entailment relation emerges between the two of them. First and second person are always human beings, yet human beings are not always first or second person. Hence, being first or second person entails being human, but this does not hold in the reverse direction. Second, it is worth considering that the speakers accepting DOM with third person admit it with first and second person as well, but not all speakers allowing dative marking with first and second person admit it with the third one too. This is only

²³ The interested reader can access to Alberdi (1995) for a complete description of the use of the form of address using *hi* and Oyharçabal (1993) for a theoretical account.

expected under the entailment relation just mentioned. Third, as far as I know, there are no speakers allowing DOM with third person objects but not first and second person ones. This can only occur the other way around. Fourth, no speaker has been found having DOM obligatorily with third person and optionally with first and second. As in the case of one of our speakers from Larrabetzu, this can only arise in the opposite direction, DOM being generalized with first and second, but not third person.

Synthesizing the most important aspects regarding the impact of animacy, it can be seen that the main condition for an object to be marked dative is humanness, since DOM is only accepted with human objects. Objects with a value lower in animacy –i.e., non-human animates (in most cases) and the rest of inanimates– can only be absolutive marked. Besides, I have also shown that within human beings, DOM is more common with first and second person than with the third one.

2.4.1.2. Specificity

As for Basque DOM, the significance of specificity was first examined by Mounole (2012). This author argued that only human nominals with a referential interpretation are able to display the differential marking –see also Fernández & Rezac (2010 2016) and Odria (2012 2014). In what follows, I show that, generally speaking, DOM objects are not only referential or specific, but also definite, since indefinites involving a specific interpretation do not commonly allow the differential marking. This makes Basque DOM more restrictive than other languages like Hindi or Spanish, where specificity rather than definiteness seems to be relevant.

As pointed out by Mounole (2012: 368-369), DOM is mostly incompatible with the indefinite determiner *bat* ‘a’, the indefinite quantifier *asko* ‘many’ or the indefinite personal pronoun *inor* ‘nobody’ Consider, for instance, the following examples given by a speaker from Itsasondo. This speaker admits DOM with first, second and –less commonly– third person human objects, as long as they are definite. For him, nominals containing *bat* ‘a’ (31), *asko* ‘many’ (32) and *inor* ‘nobody’ (33) are marked absolutive

with a transitive verb like *ikusi* ‘see’. For this and many other speakers, DOM is generally ruled out in these contexts.²⁴

- (31) a. Neska bat ikusi det
 girl one.A see AUX[3sgA-1sgE]
 ‘I have seen a girl.’
- b. *Neska bat-i ikusi diot
 girl one-D see AUX[3sgD-1sgE]
 ‘I have seen a girl.’
- (32) a. Neska asko ikusittut
 girl many.A see.AUX[3plA-1sgE]
 ‘I have seen many girls.’
- b. *Neska asko-i ikusi diot
 girl many-D see AUX[3plD-1sgE]
 ‘I have seen many girls.’

²⁴ With *ikusi* ‘see’, the only possible exception I have found in this regard is the sentence in (i), provided by a speaker from Mungia.

- (i) Ni-k asko-ri ikusi dotset hori egiten
 I-E many-D see AUX[3sgD-1sgE] that doing
 ‘I have seen many (people) doing that.’

Nevertheless, I believe that in this case the gerundival complement *hori egiten* ‘doing that’ could be taken as the direct object and the indefinite nominal *askori* as the indirect object, explaining this way its dative marking. This is supported by the fact that, at least for some speakers, (i) is more acceptable –but still marginal– than (ii), which is considered ungrammatical with DOM, but grammatical without it (iii).

- (ii) *Ni-k jende asko-ri ikusi diot hondartza-n
 I-E people many-D see AUX[3sgD-1sgE] beach-INES
 ‘I have seen many people in the beach.’
- (iii) Ni-k jende asko ikusi dut hondartza-n
 I-E people many.A see AUX[3sgA-1sgE] beach-INES
 ‘I have seen many people in the beach.’

Given the lack of a gerundival complement like *hori egiten* ‘doing that’, in (ii), *askori* can only be considered as the direct object of *ikusi* ‘see’, and as predicted by the constraint on definiteness, it does not allow dative marking. Likewise, as pointed out by one of the consultants, a similar situation arises with indefinite nominals like *neska bat* ‘a/one girl’ too, which is commonly taken as ungrammatical in a context like (ii), but could exceptionally be more acceptable –though still marginal– in a configuration like (i).

- (33) a. Ez det inor ikusi
not AUX[3sgA-1sgE] anyone.A see
'I haven't seen anyone.'
- b. *Ez diot inorr-i ikusi
not AUX[3sgD-1sgE] anyone-D see
'I haven't seen anyone.'

The data provided by dialectal grammars are consistent with this fact and, generally speaking, the same is true for the data collected in spontaneous speech.²⁵ In (34a), for example, we see that a speaker from Tolosaldea/Goierri employs DOM with the first person but not with the third person indefinite *irakasle bat* 'a teacher', which is in turn marked absolutive.²⁶ The same thing happens in (34b) with the indefinite *ikasle bat* 'a student' in the speech of a speaker from the same variety. This speaker marks dative the first person object but not the third person indefinite. Similarly, (34c) shows that in a sentence produced by a speaker from Elgoibar the object is marked dative when it is first person and absolutive when it involves the indefinite personal pronoun *inor*

²⁵ The exceptions collected in informal conversations involve verbs different to *ikusi* 'see'. These are *kanbiatu* 'change' (i), *aurreratu* 'overtake, pass' (ii), *grabatu* 'record' (iii) and *hartu* 'take, hire' (iv). The sentence in (i) was produced by a speaker from Ondarroa and those in (ii), (iii) and (iv) by three different speakers from Elgoibar.

- (i) Asko-ri kanbixeskue
many-D change.AUX[1plD-3plE]
'They have changed many of us.'
- (ii) Lehengo urteko batzu-eri aurrerau die
previous year some-D get ahead of AUX[3plD-3sgE]
'He/she has got ahead of some (students) from the previous year.'
- (iii) Ni-k nahi nion grabau baten bat-eri kanta-tzen
I-E want AUX[3sgD-1sgE] record some one-D sing-PROG
'I wanted to record someone singing.'
- (iv) Edozein-i hartu-ko diote
anyone-D take/hire-FUT AUX[3sgD-3plE]
'They will hire anyone.'

In absence of a more complete examination of the influence of specificity in different kind of transitive verbs, I leave the explanation of the examples in (i)-(iv) for further research.

²⁶ The example in (34a) was gathered in an informal debate at university, and thus, it was produced in Standard Basque instead of the local variety of the speaker.

‘nobody’. (34a) involves the verb *ikusi* ‘see’, (34b) *bialdu* ‘send’ and (34c) *atera* ‘take out’ and *ezagutu* ‘know’.

- (34) a. Hasieran uste nuen ni hamen gelan sartzen nintzenean
 at first I thought that when I entered here the room
 ez zidate-la irakasle bat bezela ikusiko
 not AUX[2sgD-3plE]-COMP teacher one.A like see-FUT
‘At first I thought that when I entered here the room they were not going to take me as a teacher.’
- b. Ne-i bialdu beharren, ikasle bat bialtzeu
 I-D send instead student one.A send.AUX[3sgA-3sgE]
‘Instead of sending me, he/she sends a student.’
- c. Ne-ri ateratzen diate Elgoibar-tik eta ez
 I-D take out AUX[1sgD-3plE] Elgoibar-ABL and not
 dot inor ezagutzen
 AUX[3sgA-1sgE] anyone.A know
‘They take me out from Elgoibar and I don’t know anyone.’

In her description of DOM in Tolosa Basque, Mounole (2012; 369) adds that DOM can additionally distinguish between specific and non-specific interpretations, arguing that indefinite nominals bearing dative marking entail a specific interpretation when combined with the verb *bilatu* ‘look for’.²⁷ However, I have found no speaker admitting the dative marking with an indefinite nominal in that context; an example like (35a) is considered as ungrammatical by all my consultants –the same result is found by Arraztio (2010) too in Araitz-Betelu Basque. The indefinite object can only carry absolutive marking in that context, as in (35b),

- (35) a. *Idazkari bat-i bilatzen diot
 secretary one-D look for AUX[3sgD-1sgE]
‘I look for a secretary.’
- b. Idazkari bat bilatzen dut
 secretary one.A look for AUX[3sgA-1sgE]
‘I look for a secretary.’

²⁷ Instead of ‘specificity’, Mounole uses the term ‘referentiality’. However, for the sake of simplicity, I continue using the notion ‘specificity’, assuming that both share the same meaning.

Contrary to Mounole (2012), I thus conclude that in order to be dative, the object has to be definite, and that instead of specificity *per se*, the main factor conditioning the marking of the object is definiteness.

2.4.1.3. Other factors like tense and finiteness

In addition to the properties of the object, Basque DOM is conditioned by the properties of the clause too, namely, tense and finiteness, as in some cases, DOM happens to be reduced in present as well as non-finite contexts (Fernández & Rezac 2010 2016). Cross-linguistically, DOM is known to be governed by the animacy and/or specificity of the object, and it is not very common for the marking of the object to be affected by the properties of the clause. Basque DOM is then particular in this respect, and as such, it is interesting to see the manner in which tense and finiteness alter the marking of the object. Notwithstanding, before focusing on each of these factors, it is important to clarify that, compared to animacy and specificity, the properties of the clause influence the marking of the object in a subtler way. On the one hand, the contrast triggered by tense and finiteness does not generally lead to grammatical vs. ungrammatical distinctions, and on the other, the influence of these factors is not as generalized as that caused by the properties of the object.

❖ Tense

Based on Yrizar's (716-750) descriptions of verbal paradigms, Fernández & Rezac (2010: 121 2016: 107) mention that in some varieties DOM is more common in the past than in the present. Crucially, this claim is also shared by some of the consulted speakers in this dissertation. A speaker from Zumaia, for instance, says that for him DOM with first and second person is optional in present tense –especially with second person, yet almost obligatory in past tense. Hence, in the case of this –and other– speakers, the canonical marking is more frequently attested in present tense.

The impact of tense can even be harder, leading to absence vs. presence of DOM depending on the temporal status of the clause. Although not a generalized pattern among the consulted speakers, this is the case of one of the consultants from Larrabetzu. This speaker marks first and second person objects dative only in past tense, not in the

present –see also Arraztio (2010) for a similar pattern in Araitz-Betelu. Consider, for instance, the examples provided by this speaker in (36) and (37). In the present, first (36a) and second (36b) person singular objects display absolutive marking whereas in the past the same objects carry dative marking (37) –third person objects are always absolutive for this speaker, be them in present or past tense.²⁸

- (36) a. Zu-k ni ikusi nozu
 you-E I.A see AUX[1sgA-2sgE]
 ‘You have seen me.’
- b. Goizian eskola-n ikusi zaitut
 in the morning school-INES see AUX[2sgA-1sgE]
 ‘I have seen you at school in the morning.’
- (37) a. Atzo Miren-egaz ikusi notsun
 yesterday Miren-SOC see AUX[2sgD-1sgE]
 ‘Yesterday I saw you with Miren.’
- b. Bilbo-n ikusi dostezun
 Bilbao-INES see AUX[1sgD-2sgE]
 ‘You saw me in Bilbao.’

Similarly, the following example from Elgoibar Basque illustrates that even in the same sentence the object can be marked absolutive in the present and dative in the past (38). With second person objects, this speaker admits both absolutive as well as dative marking in the present, whereas the dative is almost generalized in the past.

- (38) Aspaldi Kutxa-n ez zaitxut ikus-ten [...],
 a long time ago bank-INES not AUX[2sgA-1sgE] see-PROG
 aspaldi ez nizun ikusten
 a long time ago not AUX[2sgD-1sgE] see-PROG
 ‘It has been a long time ago since I saw you in the bank.’

It is nevertheless important to note that the effect of tense is not so conclusive in most DOM varieties or speakers. This is evidenced by the (morpho)-syntactic database Euskara Bariazioan / Basque in Variation (BiV) by Fernández, Berro, Orbegozo, Arriortua & Landa (2016). The database shows that DOM is found in the majority of

²⁸ In past tense, this speaker marks the object absolutive when this is first person plural, but dative when it is second person plural. I leave the examination of this nuance for further research.

the consulted southwestern varieties, as it is attested in 22 out of 24 varieties. The only exceptions are Beizama and Otxandio, as the rest belong to the northeastern varieties of Basque –i.e., the French speaking area. With regards to tense, the database shows that all the varieties having DOM in the past do also have it in the present –Orbaizeta is the only exception in this respect, but its different pattern could be justified by its closeness to northeastern varieties. I thus conclude that instead of conditioning the distribution of the phenomenon, the influence of tense is more likely to be related to its frequency.

❖ Finiteness

Fernández & Rezac (2016: 108) report that for their consultant from Dima DOM is obligatory in finite clauses, both in plain transitives and restructuring constructions, but optional in non-finite ones. In the case of this speaker, DOM is thus reduced in non-finite clauses. Although this is not an extended pattern among the consulted speakers, an identical pattern can be observed in the case of another speaker from Larrabetzu. With second person, DOM is obligatory for this speaker in finite configurations like (39), but optional when it occurs in non-finite ones like (40). In non-finite contexts, the object can be marked either absolutive or dative.

- (39) a. Eroangotsut ni-k etxe-ra
 carry.AUX[2sgD-1sgE] I-E house-ALL
 'I will carry you at home'
- b. Ni-k eroan behar dotsut Galdakao-ra
 I-E carry need AUX[2sgD-1sgE] Galdakao-ALL
 'I must carry you to Galdakao.'
- (40) Zu/zu-ri ikus-ten etorri naz
 you.A/you-D see-NOMI come AUX[1sgA]
 'I have come to see you.'

As far as I know, the influence of finiteness is only observable in the case of few speakers and even in that case, it does not imply a total cut-off of the phenomenon. The contrast is rather between obligatory vs. optional DOM, which means that it can only be found in speakers with obligatory DOM with first and second person objects. This is the case of our speaker from Larrabetzu and Fernández & Rezac's speaker from Dima.

With regards to the natural speech corpora, we see that –as happens with tense– DOM objects occur both in finite as well as non-finite contexts. This is illustrated in (41). In (41a), we can observe that a speaker from Mutriku marks dative the second person object of a non-finite clause constructed with the verb *ikusi* ‘see’. Along with *ikusi* ‘see’, DOM in non-finite configurations is attested with other transitive verbs as well. (41b) involves *obserbatu* ‘observe’, (41c) *zirikatu* ‘provoke’ and (41d) *konbentzitu* ‘convince’. (41b) and (41c) were produced by speakers from Tolosaldea/Goierri and (41d) by a speaker from Elgoibar. Note, moreover, that the DOM object in a non-finite sentence cannot only be second person as in (41a) and (41b), but also third person (41c) (41d).

- (41) a. Arantxa etorri-ko da-la zeu-ri ikus-tera,
 Arantxa.A come-FUT AUX[3sgA]-COMP you-D see-NOMI
 zeu-ri ikus-teko gogua daka-la
 you-D see-NOMI want AUX[3sgA-3sgE]-COMP
‘That Arantxa is going to come to see you, that she wants to see you.’
- b. Ikasle guztik daude zu-ri obserba-tzen
 student all.A be you-D observe-PROG
‘All the students are observing you.’
- c. Beste ikasle-ei zirika-tzen ego-ten da
 other students-D provoke-PROG be-PROG AUX[3sgA]
‘He/she is (always) provoking to other students.’
- d. Saiatu-ko naiz konbentzi-tzen ama-ri
 try-FUT AUX[1sgA] convince-PROG mother-D
‘I will try to convince the mother.’

Overall, despite the contrast attested in (39) and (40), the examples in (41) demonstrate that in Basque finiteness is not a core conditioning of the DOM phenomenon.

2.4.1.4. Interim summary

Like in many other languages, the fundamental factors governing Basque DOM are the properties of the object, that is to say, animacy and specificity. Besides, as happens in Hindi and other Romance languages like Spanish, animacy exceeds the influence of specificity in Basque too. The differential marking seems to be more ungrammatical when the object is non-human and definite than when it is human and indefinite. In fact,

concerning the spontaneous speech corpora, we see that while DOM is never attested with non-human –or inanimate– objects, the differential marking is occasionally found with those that are indefinite –see footnotes 23 and 24.

In this regard, it is important to verify the impact of animacy and –very specially– specificity with different transitive predicates. The syntactic questionnaire carried out in this thesis is mainly based on *ikusi* ‘see’, a proto-typical transitive predicate involving a theme object. Nevertheless, the corpora in spontaneous speech indicate that not all transitive verbs show an identical behavior to *ikusi* ‘see’. Although the cutting point made by humanness is systematic in all the cases, the influence of person and definiteness should be examined with further detail, as these may be more influential with some verbs than with others. The same could happen with tense and finiteness as well. Taking this into account, it is necessary for future research to test how different transitive verbs behave when restricting the differential marking, as DOM appears to be more common with some verbs than with others –see Mounole (2012) and Rodríguez-Ordóñez (2016) on this point.

Leaving aside the (un)systematic nature of certain driving factors in different predicates, it is relevant to realize that the object is semantically a theme in all of them. This makes DOM objects parallel to canonical absolutes, as no semantic nuance is observed when marking the object dative. Along with *ikusi* ‘see’, the rest of the verbs displaying DOM are also pure transitives, involving a theme object. Some of them are *atera* ‘take out’, *bialdu/bidali* ‘send’, *bota* ‘throw away’, *eroan/eraman* ‘carry’, *ezagutu* ‘know’, *harrapatu* ‘catch’, *hartu* ‘take’, *ikusi* ‘see’, *ipini/jarri* ‘put’, *jo* ‘hit’, *tratatu* ‘treat’ and *zaindu* ‘take care’. Based on their semantic identity to canonical absolutes, in chapter 1 I have concluded that DOM objects are direct objects too. This implies that they are generated in the same syntactic position –i.e., in the complement position of V.

In this respect, DOM objects differ from other dative objects that also occur with an ergative subject. These are found in bivalent unergative predicates like *lagundu* ‘accompany, help’, *deitu* ‘call’ or *obeditu* ‘obey’ (Etxepare 2003, Fernández & Ortiz de Urbina 2009 2010). Contrary to what happens in DOM, the dative object corresponds to a goal in many of these verbs and behaves more akin to the indirect object of

ditransitive predicates (Fernández & Ortiz de Urbina 2012, Ortiz de Urbina & Fernández 2016). Therefore, in order to delimit the exact distribution of the phenomenon in question, in section 2.4.2, I briefly compare the two types of dative objects. This will definitely reduce the range of verbs DOM arises with to pure transitives.

2.4.2. DOM vs. datives in bivalent unergatives

Bivalent unergatives are unergative predicates that occur either with a monovalent argument structure as in (42a) or with a bivalent one, causing thereby an ergative-dative configuration, as in (42b) (Etxepare 2003, Fernández & Ortiz de Urbina 2009 2010).²⁹

- (42)
- | | | |
|-----------------------------------|-------------|----------------|
| a. Lan-ean | jarraitu-ko | dut |
| work-PROG | follow-FUT | AUX]1sgE[|
| <i>'I will continue working.'</i> | | |
| b. Jon-i | jarraitu | diogu |
| Jon-D | follow | AUX[3sgD-1plE] |
| <i>'We have followed Jon.'</i> | | |

The example in (42b) shares certain commonalities with DOM constructions, as both are bivalent with respect to their argument structure and both show a dative marked object. This leads to an ergative-dative alignment in both of them, an unexpected pattern from the point of view of typological as well as Case Theoretic linguistics –see chapter 1.

In addition to the ergative-dative frame, both in DOM and bivalent unergatives the dative object alternates with the absolutive, forming a canonical transitive configuration when this is the case. This is illustrated in (43) with the verb *deitu* ‘call’. In (43a), the object is marked absolutive and a canonical transitive ergative-absolutive alignment emerges. On the contrary, in (43b) the same object receives dative marking, giving rise to an ergative-dative configuration, as in (42b) above. Generally speaking, in bivalent

²⁹ Dative objects in bivalent unergative predicates are not reduced to the Spanish spoken area of the Basque Country, and hence, are not only attested among DOM speakers, but also among those speakers that do not admit DOM (Fernández & Ortiz de Urbina 2010 2012, Ortiz de Urbina & Fernández 2016).

unergatives dative marking is preferred in southwestern dialects, while the absolutive is more frequent in northeastern ones.

- (43) a. Goizean deitu zaitut
 in the morning call AUX[2sgA-1sgE]
 ‘I have called you in the morning.’
- b. Goizean deitu dizut
 in the morning call AUX[2sgD-1sgE]
 ‘I have called you in the morning.’

Along with *jarraitu* ‘follow’ and *deitu* ‘call’, bivalent unergatives involve other verbs like *abisatu* ‘notify’, *barkatu* ‘forgive’, *begiratu* ‘look at’, *bultzatu* ‘push’, *deitu* ‘call’, *entzun* ‘hear, listen to’, *eskertu* ‘thank’, *heldu* ‘hold’, *lagundu* ‘accompany, help’ *obeditu* ‘obey’ or *ukitu* ‘touch’ –see Etxepare (2003) and Fernández & Ortiz de Urbina (2009 2010) for a complete classification of this group of predicates.

In spite of their similarities, robust evidence has been provided distinguishing the behavior of DOM objects on the one hand and datives in bivalent unergatives on the other (Fernández & Ortiz de Urbina 2009 2010 2012, Fernández & Rezac 2010 2016, Odria 2012, Ortiz de Urbina & Fernández 2016). While DOM objects are syntactically similar to canonical absolutes, datives in bivalent unergatives pattern more akin to dative indirect objects. This has lead Fernández & Ortiz de Urbina (2012), Ortiz de Urbina & Fernández (2016) and Pineda (2016) to propose that the ergative-dative configuration with bivalent unergative predicates contains a silent direct object and that the sole dative argument is in fact an indirect object introduced by a Low Applicative head *à la* Pylkkänen (2008). As reported by these authors, many of these verbs are verbs of communication –i.e., *abisatu* ‘notify’ or *deitu* ‘call’– or obey verbs –i.e., *obeditu* ‘obey’. Thus, they involve a transfer of message or order, this being equivalent to a silent direct object.³⁰

³⁰ Nevertheless, note that other bivalent unergatives correspond to verbs of relative motion –i.e., *jarraitu* ‘follow’ or *lagundu* ‘accompany, help’– and verbs of physical contact –i.e., *heldu* ‘hold’ or *ukitu* ‘touch’. Therefore, in those cases it would be harder to assume the indirect object hypothesis including a direct object.

All in all, returning to the comparison between DOM and datives in bivalent unergatives, we conclude that the former are themes that enter the derivation as direct objects, and the latter are mostly goals generated as indirect objects.

For the purposes of the description, it is important to explain that in addition to their original position, DOM and datives in bivalent unergatives differ with regards to the factors lying behind the dative marking. Contrary to what happens in DOM, animacy, specificity, tense and finiteness are insignificant when marking the object dative in bivalent unergatives (Fernández & Ortiz de Urbina 2012, Ortiz de Urbina & Fernández 2016). The examples in (44), for instance, show that the dative in verbs like *jarraitu* ‘follow’ (44a), *itxaron/itxoin* ‘wait for’ (44b) and *begiratu* ‘look at’ (44c) is assigned regardless of the animacy of the object, since dative marking with inanimates is natural in all of them.

- (44)
- | | | | |
|---------------|---|----------------|----------|
| a. GPS-ari | jarraitu | diot | |
| GPS-D | follow | AUX[3sgD-1sgE] | |
| | <i>‘I followed the GPS.’</i> | | |
| | | | |
| b. Hemen | itxoin-go | diogu | trena-ri |
| here | wait for-FUT | AUX[3sgD-1plE] | train-D |
| | <i>‘We will wait here for the train.’</i> | | |
| | | | |
| c. Koadroa-ri | begira | geratu naiz | |
| painting-D | look at | stay AUX[1sgA] | |
| | <i>‘I have stayed looking at the painting.’</i> | | |

It is true that in the case of some verbs, the dative marking correlates with the animacy of the object. As noted by Fernández & Ortiz de Urbina (2010: 164), this is the case of *itxaron/itxoin* ‘wait for’. These authors show that, with few exceptions, in the General Basque Dictionary *Orotariko Euskal Hiztegia (OEH)* (Mitxelena & Sarasola 1989-2005), the object of *itxaron/itxoin* ‘wait for’ is marked dative when animate (45a), and either dative (45b) or absolutive (45c) when inanimate.³¹

³¹ Of course, this does not mean that absolutive marking is totally rejected with animate objects. As I have already pointed out, northeastern dialects show a preference to mark both animate and inanimate objects absolutive in bivalent unergative predicates.

- (45) a. Beste asko-ri etxeden ez ta niri etxeden (Cb *Eg* II 71)
 other many-D wait for not and I-D wait
 ‘Not wait for many others and wait for me.’
- b. Bihar joango naz Bilbora
 tomorrow go-FUT AUX[1sgA] Bilbao-ALL
 ontzia-ri itxaro-tera (Echta *Jos* 929)
 ship-D wait for-NOMI
 ‘Tomorrow I will go to Bilbao to wait for the ship.’
- c. Ikastetxe-ra sartzeko ordua itxaro-ten zaudela (Osk *Kurl* 73)
 school-ALL to enter time wait for-PROG AUX[2sgA]-COMP
 ‘While you are waiting for the time to enter school.’

Despite its influence in verbs like *itxaron/itxoin* ‘wait for’, a closer look to the different types of bivalent unergatives indicates that animacy is not a conditioning trigger for the dative marking in these verbs. Its influence can only be particular of certain verbs or even dialects/speakers, and is not as systematic as in DOM. Likewise, being a subcategory of animacy, person is neither determinant in marking the object dative, and the same thing happens with specificity. Consider now the examples provided in (46). The same indefinite particles that are generally excluded with DOM are acceptable in the dative objects of bivalent unergatives like *deitu* ‘call’ (46a), *begiratu* ‘look at’ (46b) or *lagundu* ‘help’ (46c).

- (46) a. Lagun asko-ri deitu diet, baina ez dit
 friends many-D call AUX[3plD-1sgE] but not AUX[1sgD-3sgE]
 inork erantzun
 anyone-E answer
 ‘I have called to many friends, but nobody has answered me.’
- b. Ez zion inor-i begiratu
 not AUX[3sgD-3sgE] anyone-D look at
 ‘He/she didn’t look at anyone.’
- c. Ikasle bat-i lagun-tzen geratu naiz
 student one-D help-PROG stay AUX[1sgA]
 ‘I have stayed helping to a student.’

In addition to the properties of the object, clausal properties do neither favor the dative marking of the object in bivalent unergatives. The object can be marked either dative or absolutive regardless of the temporal as well as finiteness-related status of the clause.

Interestingly, as happens in many other Romance languages (Pineda 2016), Spanish also has some verbs whose objects bear *a*-marking regardless of specificity (Pensado 1995, Torrego 1998 2010, Leonetti 2004, Fábregas 2013). Similar to the Basque bivalent unergatives, in Spanish the animate object of certain verbs carries *a*-marking even with a non-specific reading. This is exemplified by Leonetti (2004: 85) with the verbs *entrevistar* ‘interview’ in (47a) and *admirar* ‘admire’ in (47b).³²

- (47) a. Cada estudiante entrevistará a un personaje conocido
 each student will interview.3sg to a well known person
 ‘Each student will interview a well known person.’
- b. Todas las niñas admiraban a algún cantante
 every children..F admired.3pl to some singer
 ‘Every child admired some singer.’

Likewise, Fábregas (2013: 29) adds that *a*-marking can also be assigned to inanimate objects with other verbs. In (48a), for instance, it is possible for the inanimate object of *acosar* ‘harass’ to bear *a*-marking. Besides, the marking is even obligatory for the inanimate object of *ayudar* ‘help’ in (48b).

- (48) a. La policía acosa (a)l narcotráfico
 the police harass.3sg to the drug-trafficking
 ‘The police harass drug-trafficking.’
- b La policía ayuda *(a)l narcotráfico
 the police help.3sg to the drug-trafficking
 ‘The police help drug-trafficking.’

Similar to what happens in Basque bivalent unergatives, these verbs show a parallelism to pure transitives involving DOM, as both are bivalent and both contain an *a*-marked object. Notwithstanding, contrary to the object of pure transitives, animacy and specificity do not necessarily hold in these verbs. Therefore, as in Basque, not all *a*-marked objects that occur with verbs with a bivalent argument structure involve DOM.

³² A more complete list of this group of verbs include *acusar* ‘accuse’, *admirar* ‘admire’, *afectar* ‘affect’, *ayudar* ‘help’, *castigar* ‘punish’, *entrevistar* ‘interview’, *golpear* ‘beat’, *insultar* ‘insult’, *odiar* ‘hate’, *offender* ‘offend’, *saludar* ‘greet’ and *sobornar* ‘bribe’ (Fábregas 2013: 27-28).

In Basque Spanish, the apparent identity between the objects in pure transitives and in bivalent predicates assigning *a*-marking regardless of animacy and/or specificity is also present in the clitic system, since the dative clitic *le(s)* is used in both of them. Consider the examples in (49). (49a) represents a DOM construction, as its object is semantically a theme and the dative clitic depends on the animacy of the object.³³ In contrast, (49b) belongs to the class of verbs whose (usually) goal object receives *a*-marking regardless of the factors triggering DOM.

- (49) a. Le llevé (al niño) a casa
 3sgD brought.1sg DOM the child.M to house
 ‘I brought the child at home.’
- b. Le ayudé (al niño) a casa
 3sgD helped.1sg DOM the child.M to house
 ‘I helped/accompanied to the child at home.’

As reported by Fernández-Ordóñez (1999: 123-1339), the dative clitic in sentences like (49b) should not be grouped with the *leísmo* attested in sentences like (49a). This author explains that the dative clitic can code the object of verbs that tend to omit their direct object –i.e., *tocar* ‘touch’– as well as the object of verbs whose valency has been reinterpreted, as in *ayudar* ‘help’, *avisar* ‘notify’ or *obedecer* ‘obey’. Fernández-Ordóñez (1999) refers to the pattern in (49a) as *real leísmo* –see footnote 12, while that in (49b) is considered as *apparent leísmo*. Recall once again that the verbs coding their object with the dative clitic *le(s)* are the same that assign *a*-marking in Standard Spanish and dative marking in Basque.

Torrego (2010), Fábregas (2013) and Pineda (2016) claim that, in many of these verbs, the configuration involving *a*-marking regardless of animacy and specificity corresponds to a ditransitive construction. In those cases, the verb happens to be related to a noun, this behaves as the direct object and the *a*-marked object as the indirect object. This is illustrated in (50a) with *golpear* ‘beat’ and *ayudar* ‘help’ in (50b).

³³ Recall that if inanimate, the object in (49a) would instead be coded by an accusative clitic, as in (i).

- (i) Lo/la llevé a casa
 3sgACC/3sgD brought.1sg to house
 ‘I brought it at home.’

(50)	a. Golpear beat	a uno ~ to someone	dar give	un golpe a blow	a uno to someone
	b. Ayudar help	a uno ~ to someone	dar give	ayuda help	a uno to someone

This is in fact the main insight in Fernández & Ortiz de Urbina (2012), Ortiz de Urbina & Fernández (2016) and Pineda (2016) when they claim that the dative in bivalent unergatives belongs to a ditransitive construction involving a silent direct object. The same correspondences in (50a) and (50b) obtain in Basque too with bivalent unergatives like *deitu* ‘call’ (51a), *bultzatu* ‘push’ (51b) or *lagundu* ‘help’ (51c) resorting to the light verb *egin* ‘do’ in the first two and *eman* ‘give’ in the third one.

(51)	a. Norbait-i someone-D	deitu ~ call	norbait-i someone-D	dei egin call do	
	b. Norbait-i someone-D	bultzatu ~ push	norbait-i someone-D	bultza egin push do	
	c. Norbait-i someone-D	lagundu ~ help	norbait-i someone-D	laguntza help	eman give

This implies that both in Basque and Spanish the single object that appears with dative morphology is in fact an indirect object in these cases.

Coming back to the comparison between DOM and the dative of bivalent unergatives, in this section we have seen that even being the unique object of a bivalent configuration, the dative in bivalent unergatives differs from the DOM object in two main points: (i) their semantic theta-role, and (ii) the influence or not of the properties of the object and the clause. Taking this into account, the goal datives that are independent from the mentioned factors will be outside the scope of this dissertation. These datives will only be addressed together with the rest of goal dative arguments.

2.5. INTERIM SUMMARY

In this section, I have first presented the main aspects of the phenomenon under study in this dissertation. I have shown that, instead of the canonical absolutive, certain

southwestern Basque varieties can mark human and definite objects of transitive verbs dative (Fernández & Rezac 2010 2016, Mounole 2012, Odria 2012 2014, Rodríguez-Ordóñez 2013 2016). The pattern attested in these varieties belongs to the cross-linguistically widely attested DOM phenomenon. In DOM, objects with a positive value for animacy and/or specificity carry a non-canonical marking, which coincides in many cases with the dative marker of indirect objects (Bossong 1985 1991, Aissen 2003).

Basque DOM patterns with the DOM found in other languages like Hindi and Spanish. In these languages, DOM is triggered by the animacy as well as specificity of the object and the differential marking is morphologically identical to the dative marker of indirect objects. With respect to Hindi, we have highlighted that the differential marking coincides with the ergative marking of the subject in past/perfect contexts. As in Basque, this leads to an ergative-dative configuration, a configuration that is unexpected from typological and Case Theoretic approaches. The DOM attested in Spanish is also relevant when comparing to Basque DOM. As we have seen, in the *leísta* Spanish spoken in the Basque Country, apart from the nominal, DOM occurs in the clitic system too. This makes it even closer to the DOM found in Basque varieties, where the differential marking is found both in the nominal and in the finite verbal form.

After reviewing the main cross-linguistic characteristics of DOM, I have provided a deeper look to Basque DOM. In Basque, DOM is mainly governed by the animacy and specificity of the object (Fernández & Rezac 2010 2016, Mounole 2012, Odria 2012 2014, Rodríguez-Ordóñez 2013 2016). As for animacy, humanness seems to be the main property shared by those objects bearing the differential marking, and among human beings, first and second person show a preference when being differentially marked. Along with humanness, person is thus an important category when determining DOM in Basque. Together with animacy, specificity is also a core trigger of Basque DOM., as generally speaking, DOM objects are definite entities. Besides, Basque DOM is particular in being also favored by clausal properties like tense and finiteness (Fernández & Rezac 2010 2016). Even though their influence is not as extended as that of animacy and specificity, the differential marking is in some cases reduced in present as well as non-finite contexts.

To finish, with the aim at delimiting the group of predicates involving DOM, I have distinguished the DOM construction attested in pure transitives like *ikusi* ‘see’ from the dative object of bivalent unergatives of the *lagundu* ‘accompany, help’ type (Etxepare 2033, Fernández & Ortiz de Urbina 2009 2010). Despite sharing an ergative-dative configuration, the dative object of transitive and bivalent unergative predicates is different in many respects. Contrary to the theme theta-role exhibited by DOM objects, most of the datives in bivalent unergatives are goals semantically, indicating that they are originated in an indirect object position (Fernández & Ortiz de Urbina 2012, Ortiz de Urbina & Fernández 2016). In addition to their first merge position, DOM and datives in bivalent unergatives differ with regards to the factors determining the dative marking. In contrast to DOM objects, the marking of the object in bivalent unergatives does not depend on factors like animacy and specificity, and clausal properties like tense and finiteness are neither significant. Distinguishing DOM from these datives allows us to restrict the range of verbs involving the differential marking to pure transitives containing a thematic dative object.

3. THE SYNTACTIC CATEGORY OF DOM OBJECTS AND THE LICENSING OF DEPICTIVE SECONDARY PREDICATION

3.1. INTRODUCTION

The main goal of this chapter is to identify the original syntactic category of DOM objects, as in Basque, datives can show a DP or PP-like behavior –see specially Albizu (2001) on this point. The main criterion distinguishing the dual syntactic category of dative arguments comes from the possibility to occur without dative markers in the finite verbal form. Generally speaking, datives pattern with ergative and absolutes in agreeing with the finite verbal form, As a consequence, they have been considered to be DPs as well (Euskaltzaindia 1985; Hualde 1988, Ortiz de Urbina 1989; Fernández 1997, Montoya 1998, Artiagoitia 2000, Albizu 2001, Elordieta 2001, Oyharçabal 2010, Etxepare 2014). Nevertheless, in contrast to what happens with ergative and absolutes, recent research on Basque datives has shown that, in northeastern varieties, some datives can occur without triggering dative markers, behaving in this respect more akin to PPs than to DPs –see, among others, Ortiz de Urbina (1995), Fernández (1997 2010 2014), Fernández & Landa (2009), Fernández, Ortiz de Urbina & Landa (2009), Fernández & Ortiz de Urbina (2010), Albizu (2001 2009), Etxepare & Oyharçabal (2008abc 2009ab 2013), Etxepare (2014) and Ormazabal & Romero (2017).³⁴ This is the case of goal datives, which are able to occur as non-agreeing either in ditransitive or bivalent unaccusative/unergative configurations.³⁵ Contrary to goals, experiencers and

³⁴ Non-agreeing datives are not only found in the French speaking area of the Basque Country, but also in some bordering regions of the Spanish speaking area (Etxepare & Oyharçabal 2013). This is evidenced by the (morpho)-syntactic database *Euskara Bariazioan / Basque in Variation (BiV)* by Fernández et al. (2016).

³⁵ In northeastern Basque, non-agreeing datives also include spatial, aspectual and postposition-like datives.

possessors occur always agreeing with the finite verbal form, showing thereby a clear DP syntactic category. In these varieties Besides, causees are able to occur without dative markers too, but in this case the possibility to appear as non-agreeing does not seem to be as extended as in goals (Fernández, Landa & Ortiz de Urbina 2009).³⁶

Outside northeastern Basque, non-agreeing datives are limited to specific configurations such as ditransitives affected by the PCC and double dative constructions. As I show in chapter 4, generally speaking, only goals are allowed to appear as non-agreeing in ditransitive configurations targeted by the PCC, and the same occurs in ditransitive causative constructions formed by a causee and a goal; the causee is unable to appear as non-agreeing. Based on these facts, in this dissertation I make the two-fold distinction between causee, experiencer and possessor datives on the one hand, and goal datives on the other. The former are referred as DP datives and the latter as PP-like datives, because although goals agree with the finite verb as the rest of DP arguments, they show a PP-like behavior in being able to appear as non-agreeing.³⁷

Taking this into consideration, this chapter aims to provide a novel criterion in order to determine the original syntactic category of DOM objects in particular and dative phrases in general: the licensing of depictive secondary predication. In contrast to the standard assumption claiming that depictive secondary predication rejects all kind of

³⁶ Fernández, Ortiz de Urbina & Landa (2009: 214-215) report that non-agreeing datives in causative constructions should be analyzed on closer inspection, given that in this case the lack of dative markers in the finite verb could be influenced by external factors like indefiniteness (Ortiz de Urbina 1995). Besides, these authors note that, in their corpora, some of the non-agreeing datives in causative constructions belong to goals instead of causees, and add that the availability to have non-agreeing datives in causatives could be affected by idiolectal variation as well, as non-agreeing causees are found in the writings of some but not other northeastern authors.

³⁷ The contrast between DP and PP-like datives has also been supported by the availability to occur as adnominals in headlines, which –along with the rest of PPs– is only possible for those datives that can occur as non-agreeing, namely, for goals –see de Rijk (2008 378), Euskaltzaindia (1995: 346), Albizu (2001: 63, 2009: 13), and specially, Fernández & Sarasola (2010). As demonstrated by Fernández & Sarasola (2010), possessors and experiencers pattern with ergative and absolutes in requiring the genitive marker *-ren* in order to appear as adnominals.

dative indirect objects (Zabala 1993 2003, Arregi & Molina-Azaola 2004, Oyharçabal 2010), I put forth that depictives are only excluded with PP-like datives, that is, with those that can behave as non-agreeing PPs, as DP datives are in fact able to control secondary predication (Odria 2015).

The possibility for DP datives to control secondary predication explains not only the widely mentioned exceptional behavior of the causee (Zabala 1993 2003) and DOM object (Fernández & Rezac 2010 2016, Odria 2012 2014), but also the behavior of possessor and experiencer datives, which are equally able to license this kind of predication. On that assumption, causee and DOM datives should no longer be regarded as extraordinary cases, and the licensing of depictive secondary predication should be taken as an additional diagnostic when identifying the original syntactic category of a given argument.

The chapter is structured as follows. In 3.2, I provide a general picture of the licensing of depictive secondary predication. I present the widely held restriction on the controller, which prevents dative marked indirect objects from controlling secondary predication (Zabala 1993 2003, Arregi & Molina-Azaola 2004, Oyharçabal 2010). I explain that, despite bearing dative marking, the literature on the topic has shown that causees are distinct to indirect objects in being able to control depictive secondary predication not only in Basque (Zabala 1993 2003), but also in other languages like Spanish (Demonte 1987 1988).

In 3.3, I focus on DOM and datives in bivalent unergative predicates and corroborate that only the former allow being modified by secondary predication. Considering the restriction on the controller, this implies that, while datives in bivalent unergatives are true indirect objects, DOM objects are syntactically more akin to absolutive direct objects (Fernández & Ortiz de Urbina 2009 2010 2012, Fernández & Rezac 2010 2016, Odria 2012 2014, Ortiz de Urbina & Fernández 2016).

Section 3.4 discusses the validity of the restriction on the controller of secondary predication. It demonstrates that, in Basque, along with causee and DOM datives, many speakers allow possessor and experiencers to control depictive secondary predication as well (Odria 2015), and the same results are found in Spanish too (Hernanz 1988,

Demonte & Masullo 1999, Fernández-Soriano 1999, Bosque 2011). Hence, the results in this section imply that, instead of determining its syntactic configuration, depictive secondary predication determines the original syntactic category of a given argument, as only PP-like goals are affected by the restriction. For this reason, I argue that the possibility for DOM objects to control depictive secondary predication does not necessarily imply that DOM objects are direct objects configurationally, but that these non-canonical objects generate with a DP syntactic category.

Section 3.5 develops further implications that arise once we acknowledge that depictive secondary predication is compatible with DP but not PP-like datives. On the one hand, the restriction on the controller should be accounted for structurally, taking the presence of the P head to be the trigger for preventing PPs and PP-like datives from controlling depictive predication. On the other hand, given that depictives exclude both agreeing and non-agreeing goals, the restriction implies that a different categorial origin should be posited for DP and PP-like datives. While causees, experiencers and possessors should generate as DPs, goals should instead be originated as PP complements of V. This entails that, although being PPs in their original position, agreeing PP-like goals undergo a process of P-incorporation in order to behave as the rest of DPs in agreeing with the finite verbal form (Ormazabal & Romero 1998 2010 2017, Albizu 2001 2009). In this section, I ultimately point out that the derivational analysis of PP-like datives is consistent with recent approaches that analyze secondary predication as involving Complex Predicate formation.

To finish, section 3.6 closes the chapter by summing up the main conclusions concerning the licensing of depictive secondary predication and the syntactic category of DOM objects and the rest of the datives.

3.2. DEPICTIVE SECONDARY PREDICATION AND THE RESTRICTION ON THE CONTROLLER

In this section, I lay out the main properties and restrictions posed by depictive secondary predication in Basque (3.2.1). I particularly focus on the restriction related to

the nature of the controller, which states that dative marked indirect objects are not allowed to control depictive secondary predication (Zabala 1993 2003, Arregi & Molina-Azaola 2004, Oyharçabal 2010) (3.2.2). Besides, I explain that causee datives are thought to be different to the rest of dative arguments in being able to license depictive secondary predication (Zabala 1993 2003). The section is highly based on Zabala (1993), since this is the only work that examines systematically the syntax of secondary predication in Basque

3.2.1. Preliminaries

Secondary predicates denote a –physical or psychological– state to one of the individuals participating in the event described by the verb. In (1), for instance, the secondary predicate *pozik* ‘happy’ describes the psychological state of *Miren*, which is the subject of the clause. In this context, *pozik* ‘happy’ is not required by the verb, and as a consequence, it is considered to be a *secondary* predicate. From this it follows that the sentence remains grammatical even when the secondary predicate is absent.³⁸

- (1) Miren-ek_i liburu hori (pozik)_i irakurri du
Miren-E book that.A (happy) read AUX
‘Miren has read that book (happy).’

Secondary predicates stand in contrast to *primary* predicates, which are subcategorized by the main verb and are indispensable for the sentence to be grammatical. This is illustrated in (2), where the adjective *azkarra* ‘clever’ acts as a primary predicate which is required by the main verb.

- (2) Miren-ek_i *(azkarra)_i dirudi
Miren-E clever seem
‘Miren seems clever.’

Apart from modifying the subject of the clause as in (1) and (2), secondary as well as primary predicates can be controlled by the direct object as well. Consider, for example, the sentences in (3), where the predicate *urduri* ‘nervous’ is controlled by the direct object *Peru*. In (3a), *urduri* ‘nervous’ acts as a secondary predicate; its presence or

³⁸ The arguments cross-referenced by the finite verbal form of each example are not explicitly coded in the glosses, as this is not relevant for the purposes of the discussion in this chapter.

absence does not affect the grammaticality of the sentence. On the contrary, in (3b), *urduri* ‘nervous’ behaves as a primary predicate; the sentence becomes ungrammatical when the predicate is missing.

- (3) a. Miren-ek Peru_i (urduri)_i ikusi du
 Miren-E Peru.A nervous see AUX
 ‘Miren has seen Peru nervous.’
- b. Albiste horr-ek Miren_i *(urduri)_i utzi du
 piece of news that-E Miren.A urduri leave AUX
 ‘That piece of news has left Miren nervous.’

Besides, secondary predicates that modify the object can be either depictive or resultative (Halliday 1967, Simpson 1983, Rothstein 1983). Both represent a non-durable or non-permanent property of an argument, but while the state denoted by depictives holds during the event described by the verb, the state expressed by resultatives arises as a result of the culmination of the event expressed by the verb. Consider the examples in (4). In (4a), the secondary predicate *merke* ‘cheap’ describes the state of *fruta* ‘fruits’ during the event of buying. In other words, (4a) implies that fruits were cheap at the moment they were being bought. *Merke* ‘cheap’ in (4a) is then a depictive rather than resultative secondary predicate. Contrary to (4a), the resultative secondary predicate *txiki-txiki* ‘in small pieces’ in (4b) describes the state of *fruta* ‘fruits’ when the event of cutting has already finished. (4b) does not entail that fruits were in small pieces when they were being cut, but that fruits ended in small pieces after being cut.

- (4) a. Gu-k fruta_i merke_i erosten dugu azoka-n
 we-E fruits.A cheap buy AUX market-INE
 ‘We buy fruits cheap in the market.’
- b. Gu-k fruta_i txiki-txiki_i mozten dugu
 we-E fruits.A small pieces cut AUX
 ‘We cut fruits to the child in small pieces.’

Resultatives require the ending of the event described by the verb, and as a consequence, they are less productive than the depictives, both in Basque and cross-linguistically (Tenny 1987). Hence, as noted by Zabala (1993: 263, 395), among the adjectives that are semantically compatible with a given nominal, only those that arise

after the culmination of the main event are admitted as resultatives. This is illustrated by the example in (5), provided by Zabala (1993: 263). Although it is semantically possible to have dark or curly hair, these two adjectives cannot behave as resultatives with the main verb *ebaki* ‘cut’, because the state of having dark or curly hair does not arise as a consequence of cutting the hair.

- (5) Ane-ri ilea motz/*beltzaran/*kizkur ebaki diote
 Ane-D hair.A cut/*dark/*curly cut AUX
 ‘Ane has got his hair cut cut/*dark/*curly.’

Although secondary predicates resemble common adjectives in some respect, three main aspects distinguish both of them. First, secondary predication is temporally dependent on the aspectual duration of the main verb. Therefore, it is typically restricted to be of the stage-level type –i.e., those that entail temporally bounded states. Individual-level predicates –i.e., those that do not involve temporally unbounded states– cannot occur in secondary predication.³⁹ Observe the contrast between the grammatical example in (6a) and the ungrammatical in (6b). In (6a), a stage-level predicate is selected, while in (6b), the selected predicate is of the individual-level type.

- (6) a. Gu-k liburuak_i merke_i erosi ditugu
 we-E books.A cheap buy AUX
 ‘We have bought the books cheap.’
- b. *Gu-k liburuak_i interesgarri_i erosi ditugu
 we-E books.A interesting buy AUX
 ‘We have bought the books interesting.’

Second, in Basque, in contrast to individual-level predicates like *interesgarri* ‘interesting’ (7a), stage-level predicates like *merke* ‘cheap’ do not bear the definite article (7b) (Zabala 1993 2003, Artiagoitia 1997, Eguren 2006 2012). Thus, being only compatible with those of the stage-level type, secondary predicates do not appear with the definite article *-a(k)*.

³⁹ For further details on the distinction between individual-level and stage-level predicates, see, among many others, Kratzer (1989).

(7) a. Gu-k liburu_i interesgarri*(-ak)_i erosi ditugu
 we-E book.A interesting buy AUX
 'We have bought interesting books.'

b. Gu-k liburuak_i merke(*-ak)_i erosi ditugu
 we-E books.A cheap buy AUX
 'We have bought the books cheap.'

When it comes to the presence of the definite article, the distinction between individual-level and stage-level predicates is even visible within the same predicate. *Merke* 'cheap', for instance, can either behave as an individual-level (8a) or stage-level predicate (8b), and the definite article is only possible in the former (Zabala 1993: 151).

(8) a. Mota honetako sagarrak merke*(-ak) dira
 apples of this kind.A cheap AUX
 'Apples of this kind are cheap.'

b. Sagarrak merke(*-ak) erosi ditut
 apples.A cheap buy AUX
 'I have bought apples cheap.'

At first glance, one could consider the contrast in (8) to be a categorical one and assume that *merke* is an adverb in (8a) and an adjective in (8b). Nonetheless, Zabala (1993: 150-151) notices that (8a) and (8b) are distinct in that the former involves secondary predication and the latter primary predication. This is proved by the fact that (8b) implies that (i) I have bought apples and that (ii) the apples were cheap when I bought them.

Third, apart from those semantic and morphological restrictions, secondary predicates do also exhibit a restriction regarding the argument they take as a controller, as they are known to be able to modify subjects –in the case of depictives– (9a) and direct objects (9b), but not dative marked indirect objects (9a) and PPs of different sort (9c) (9d) (Zabala 1993 2003, Arregi & Molina-Azaola 2004, Oyharçabal 2010).⁴⁰

⁴⁰ Contrary to secondary predicates, primary predicates are allowed to occur either with ergative (i), absolutive (ii) or dative (iii) arguments.

(i) Miren-ek azkarra dirudi
 Miren-E clever seem
 'Miren seems clever.'

- (9) a. Miren-ek_i Peru-ri_j liburuak pozik_{i/*j} laga dizkio
 Miren-E Peru-D books.A happy leave AUX
 ‘Miren has left Peru the books happy.’
- b. Miren-ek Peru_i pozik_i ikusi du
 Miren-E Peru.A happy see AUX
 ‘Miren has seen Peru happy.’
- c. Miren-ek_i afaria gosetuta_{i/*j} gorde du Peru-rentzat_j
 Miren-E dinner.A hungry keep AUX Peru-DEST
 ‘Miren has kept the dinner hungry for Peru.’
- d. Peru_i lotsatuta_{i/*j} hurbildu da Miren-engana_j
 Peru.A ashamed approach AUX Miren-ALL
 ‘Peru has approached Miren ashamed.’

Along with Basque, the restriction on the controller is persistent among many –but not all– languages of the world.⁴¹ Such a restriction will be the main focus of the remaining of the chapter, as it will allow us to identify the first merge syntactic category of DOM and the rest of dative arguments. The restriction affects both depictive as well as resultative predicates. However, given that resultatives are less productive than the depictives (Zabala 1993: 263, 395), in this chapter I exclusively deal with the restriction on the controller of depictive secondary predication. Before going on, let us review the three main characteristics distinguishing depictive secondary predicates from adjectives in table 1.

-
- (ii) Miren azkarra da
 Miren.A clever be
 ‘Miren is clever.’
- (iii) Miren-i azkarra deritzot
 Miren-D clever find
 ‘I find Miren clever.’

⁴¹ Slavic languages, for instance, are the exception to the restriction on the controller, as depictives can modify both PPs and indirect objects (Marušič et al. 2003 2004).

	Adjectives	Depictives
Temporally dependent on the aspectual duration of the matrix verb	✗	✓
Limited to stage-level predicates	✗	✓
Definite article <i>-(a)k</i>	✓	✗
Restriction on the controller	✗	✓

Table 1: Characteristics distinguishing depictives and adjectives

3.2.2. Dative indirect objects cannot license depictive secondary predication

In Basque, as in other languages like English (Williams 1980, Rothstein 1983), German (McFadden 2004), Japanese (Koizumi 1994) or Spanish (Demonte 1987 1988), depictive secondary predicates are known to be unable to modify PPs and dative marked indirect objects (Zabala 1993 2003, Arregi & Molina-Azaola 2004, Oyharçabal 2010). Such a restriction has been illustrated by examples like those in (9), repeated here in (10), where the secondary predicate *pozik* ‘happy’ can only be licensed by the subject (10a, 10c, 10d) or direct object (10b), and not by dative indirect objects (10a) and PPs of different sort (11c) (11d).

- (10)
- a. Miren-ek_i Peru-ri_j liburuak pozik_{i/*j} laga dizkio
Miren-E Peru-D books.A happy leave AUX
‘Miren has left Peru the books happy.’
- b. Miren-ek Peru_i pozik_i ikusi du
Miren-E Peru.A happy see AUX
‘Miren has seen Peru happy.’
- c. Miren-ek_i afaria gosetuta_{i/*j} gorde du Peru-rentzat_j
Miren-E dinner.A hungry keep AUX Peru-DEST
‘Miren has kept the dinner hungry for Peru.’

d. Peru _i	lotsatuta _{i/*j}	hurbildu	da	Miren-engana _j
Peru.A	ashamed	approach	AUX	Miren-ALL

'Peru has approached Miren ashamed.'

In Basque linguistics, no one has discussed the validity of the restriction on the controller of depictive secondary predication, and even being a prevalent assumption, there have been few attempts to account for it. Zabala's (1993) insightful analysis of Basque predication is an exception in this regard. In order to understand how Zabala explains such a restriction, let me first of all mention the two secondary predication approaches that prevailed in the Government & Binding framework (Chomsky 1981 1986), as her analysis gathers some aspects of each of them.⁴²

The two leading approaches that influenced Zabala's work were the Predication Theory (Williams 1980 1983 1987, Rothstein 1983 1995 2001, Demonte 1987 1988) –which afterwards evolved in the Complex Predicate analysis– and the Small Clause Theory (Chomsky 1981, Stowell 1981 1983). The main concern distinguishing the two approaches was the relation between the depictive and its controller, in particular, whether the secondary predicate formed a syntactic constituent with its subject or not.

On the one hand, the Predication Theory argued that secondary predicates did not form a syntactic constituent with their controller. Under this approach, the secondary predicate was generated without a subject, as an adjunct to some projection of V. The Predication Theory took the secondary predication relation to be akin to the relation between the subject and the main predicate in clausal relation.

On the other hand, the control based Small Clause Theory claimed that secondary predicates formed a syntactic constituent –i.e., small clause– with their controller. This theory was essentially motivated by the Theta Criterion, which states that (i) every argument must be assigned one and only one thematic role, and that (ii) each thematic role must be assigned to one and only one argument (Chomsky 1981: 36). In order to capture the two-fold dependency the controller maintains with the main predicate as

⁴² Along with Zabala (1993: 295-432), the brief summary concerning the early generative analyses on depictive secondary predication is highly based on Rothstein (2006), who presents a comprehensive overview of the beginning as well as evolution of the research on secondary predicates.

well as the secondary one, Chomsky (1981) claimed that the secondary predicate formed a small clause with a PRO subject and that this PRO element was obligatorily controlled by an argument of the main verb. This way, the controller was not simultaneously the argument of more than one lexical head.

Overall, the sentence in (11) was analyzed as (11b) under the Predication Theory, and as (11c) under the Small Clause Theory. In (11b), the secondary predicate *harrituta* ‘surprised’ does not form a syntactic constituent with its subject *Jon*, while in (11c), the same predicate builds up a Small Clause together with the PRO silent element. In this case, the reference of PRO is established by an obligatory control relation with the controller of the predication generated outside the Small Clause.

- (11)
- | | | | | | |
|----|--|-----------------|------------------------------|---------|------|
| a. | Jon-ek _i | albistea | harrituta _i | jaso | zuen |
| | Jon-E | piece of news.A | surprised | receive | AUX |
| | <i>‘Jon received the piece of news surprised.’</i> | | | | |
| b. | [Jon-ek] _i | albistea | [harrituta] _i | jaso | zuen |
| c. | [Jon-ek] _i | albistea | [PRO _i harrituta] | jaso | zuen |

These two approaches are part of Zabala’s (1993: 393-435) analysis of Basque depictive secondary predication. In line with the Small Clause Theory, Zabala assumes that the depictive secondary predicate constitutes a small clause with a PRO silent element. PRO is the subject of the secondary predicate; it receives a theta-role from it, and is obligatorily controlled by an argument of the main clause. This way, no argument is assigned two thematic-roles and the Theta Criterion (Chomsky 1981) is satisfied: the controller argument receives a theta-role from the main predicate and PRO another one from the secondary predicate.

In addition, following Williams (1980) and Rothstein (1983), Zabala argues that the controller and the secondary predicate must establish a structural c-command relation. As in Rothstein (1983), she particularly assumes a c-command relation that is based on maximal projections, namely, an m-command relation. Concretely, Zabala claims that the m-command relation between the depictive secondary predicate and its controller is required for the PRO silent element to be controlled. Such a ‘controller-secondary predicate’ m-command relation would account for the impossibility for depictive

secondary predicates to be controlled by PPs of different sort, because the P head would block the structural relation between the argument and the predicate. This would be the case in the examples in (10c) and (10d), repeated here for convenience in (13).

- (12) a. Miren-ek_i afaria gosetuta_{i/*j} gorde du Peru-rentzat_j
Miren-E dinner.A hungry keep AUX Peru-DEST
'Miren has kept the dinner hungry for Peru.'
- b. Peru_i lotsatuta_{i/*j} hurbildu da Miren-engana_j
Peru.A ashamed approach AUX Miren-ALL
'Peru has approached to Miren ashamed.'

The same structural c-command relation was previously assumed by Demonte (1987 1988) when dealing with Spanish data. As in Basque, in Spanish, PPs like those in (12) are prevented from licensing depictive secondary predication. This is illustrated by the examples in (13).

- (13) a. Juan_i ha guardado la cena para Pedro_j hambriento_{i/*j}
Juan have.3sg kept the dinner for Pedro hungry
'Juan has kept the dinner for Pedro hungry.'
- b. Juan_i se ha acercado a Pedro_j avergonzado_{i/*j}
Juan have.3sg approached to Pedro ashamed
'Juan has approached to Pedro ashamed.'

Apart from the restriction on PPs, Spanish patterns like Basque in excluding dative indirect objects from being subjects of depictive secondary predication too (Demonte 1987 1988, Romero 1997: 142-152, Demonte & Masullo 1999). Observe now the examples in (14). In (14a), the depictive secondary predicate *contento* 'happy' is controlled by the subject of the clause, in (14b) the controller of the predication *a buen precio* 'at good price' is the direct object and in (14c) the depictive *entusiasmado* 'excited' can only be controlled by the subject *Pedro* and not by the dative indirect object *Juan*.

- (14) a. Pedro_i vino a casa contento_i
Pedro came.3sg to house happy
'Pedro came home happy.'
- b. Pedro compró anchoas_i a buen precio_i
Pedro bought .3sg anchovy at good price
'Pedro bought anchovy at good price.'

c. Pedro_i le_j dio un libro a Juan_j entusiasmando_{i/*j}
 Pedro 3sgD gave.3sg a book to Juan exited
 ‘Pedro gave Juan a book exited.’

With the aim at explaining that Spanish rejects depictives with dative indirect objects, Demonte (1987 1988) states that these are PPs headed by the preposition *a*, and groups them with the rest of PP arguments. Following Williams (1980) and Rothstein (1983), this author claims that the c-command relation between the predicate and its controller is not only banned by the P head of PPs like those in (13), but also by the *a* P head of indirect objects like *a Juan* ‘to Juan’ in (15c) (Zabala 1993: 400).

In line with Demonte (1987 1988), Zabala (1993: 265-269, 400, 413-417) applies the PP analysis of dative marked indirect objects to Basque. This author claims that, instead of being a structural case marker, *-(r)i* is a P head in dative arguments, and that hence, it impedes the m-command relation with the depictive secondary predicate. This way, Zabala accounts for the restriction on both PPs and dative indirect objects in a uniform way. Depictives are incompatible with both PPs and indirect objects because the P head that is present in both of them is an obstacle when building the structural m-command relation with the secondary predicate.

3.2.3. Causee datives are the exception to the restriction on the controller

Although assuming that dative indirect objects cannot license depictive secondary predication, Zabala (1993 2003) reports that causee datives can in fact control this kind of predication. In order to understand their behavior, let me first present the basic data regarding Basque causatives.

In Basque causatives, the causee of both transitive and ditransitive predicates is marked dative. This is illustrated in the examples in (15) provided by Ortiz de Urbina (2003a: 607-608).

(15) a. Guraso-ek indabak jan-arazi dizkiote mutila-ri
 parents-E beans.A eat-CAUS AUX boy-D
 ‘The parents have made the boy eat the beans.’

b. Eliza-k pobree-i dirua eman-arazten digu (gu-ri)
 church-E poor-D money.A give-CAUS AUX (we-D)
'The church makes us give money to the poor.'

In unaccusative and unergative predicates, the marking of animate causees is subject to dialectal variation (Deustuko Hizkuntzalaritza Mintegia 1989: 99-107, Ortiz de Urbina 2003a: 602-606). In northeastern varieties, the animate causee of unaccusative (16a) and unergative (16b) predicates is marked absolutive. By contrast, southwestern varieties tend to mark dative the animate causee of both unaccusative (16c) and unergative (16d) predicates.⁴³

- (16) a. Etxe barne-rat sarr-arazi naute
 home inner-ALL enter-CAUS AUX
'They have made me enter home.'
- b. Mutiko horr-ek Miren biziki sufri-arazi du
 boy that-E Miren.A very much suffer-CAUS AUX
'That boy has made Miren suffer very much.'
- c. Etxe barru-ra sartu-arazi didate
 home inner-ALL enter-CAUS AUX
'They have made me enter home.'
- d. Mutil horr-ek Miren-i asko sufritu-arazi dio
 boy that -E Miren-D a lot suffer-CAUS AUX
'That boy has made Miren suffer a lot.'

When analyzing the behavior of the depictive secondary predication in causative constructions, Zabala (1993: 269) takes into account the transitive dative causees attested in all Basque varieties as well as the unaccusative and unergative ones of southwestern dialects. As illustrated by the examples in (17), she proves that depictive secondary predicates can be controlled by the causee of all unaccusative (17a), unergative (17b) and transitive (17c) predicates.⁴⁴

⁴³ For nuances and further details on the dialectal division between northeastern and southwestern Basque with regards to the marking of unaccusative causees see the (morpho)-syntactic database *Euskara Bariazioan / Basque in Variation (BiV)* by Fernández et al. (2016).

⁴⁴ Comparing to intransitive and transitive causatives, secondary predication with ditransitive causatives seems to be harder to process both in Basque and Spanish, as apart from the subject –i.e., causer– and the

- (17) a. Ama-k haurra-ri_i gaixorik_i joan-arazi zion eskola-ra
 mother-E child-D ill go-CAUS AUX school-ALL
'The mother made the child go to school ill.'
- b. Irakasle-ak Mikel-i_i guzti-en aurrean bakarrik_i dantza-arazi dio
 teacher-E Mikel-D in front of everyone alone dance-CAUS AUX
'The teacher has made Mikel dance in front of everyone.'
- c. Ama-k haurra-ri_i indabak gogorik gabe_i jan-arazi zizkion
 mother-E child-D beans.A without wanting eat-CAUS AUX
'The mother made the child eat the beans without wanting.'

In order to justify the possibility for causee datives to control depictive secondary predication, Zabala (1993: 268-269, 414-417, 450-451) claims that the syntactic configuration as well as dative marker of the causee is distinct from that of the rest of the datives. Taking for granted that causative constructions are complex predicates that involve two VPs –main VP₁ + embedded VP₂, she takes causees to be generated as subjects of the embedded VP₂. Following the analysis put forth in Deustuko Hizkuntzalaritza Mintegia (1989), Zabala assumes an incorporation-based complex predicate approach (Baker 1988) of Basque causatives. According to this analysis, the embedded predicate –*joan* ‘go’, *dantzatu* ‘dance’, *jan* ‘eat’ and *eman* ‘give’ in (17)–incorporates into the main predicate *arazi*, forming this way a complex predicate. By doing so, the causee ends up being an argument of the complex predicate and this checks its dative case on structural grounds. Given that the causee is generated as a DP, there is no P head that blocks the mutual m-command relation between the causee and the depictive and secondary predication is licensed as with the rest of ergative or absolutive DP subjects. Therefore, the apparently exceptional behavior exhibited by causee arguments is due to its subject configuration with respect to the embedded predicate on the one hand, and to the distinct nature of its. *-(r)i* dative marker on the other –which is analyzed as a structural case marker instead of a P head.

direct object, they involve two dative arguments: the causee and the indirect object. For this reason, contrary to what I did in Odria (2014), I give no example of ditransitive causatives involving secondary predication. Notwithstanding, even being harder to process, I believe the causee of ditransitive predicates is also able to control secondary predication.

Spanish behaves once again like Basque on this point. Although depictive secondary predication is thought to be excluded with dative indirect objects, causee datives behave distinct to the rest of datives. Take, for instance, the example in (18) provided by Demonte (1987: 154).

- (18) Juan (la)_i hizo bailar a María_i desnuda_i
 Juan 3sgACC made.3sg dance to María naked
'Juan made María dance naked.'

Demonte (1987) claims that the exceptional behavior of causee datives follows from the different structural nature of the preposition *a*. Demonte states that in the case of indirect objects the preposition *a* is a *true* preposition that intervenes in the c-command relation between the argument and the secondary predicate. Conversely, she takes the preposition *a* in causatives like (18) to be a *dummy* preposition; a preposition that does not project a PP and thus lets the causee behave as a DP.

The possibility for the causee to license depictive secondary predication is common in other languages as well. Koizumi (1994), for instance, reports that in Japanese, although dative marked indirect objects are ruled out from licensing depictive secondary predication, causee datives are able to do so. Observe the contrast in (19) (Koizumi 1994: 45).

- (19) a. *Daitooryoo-ga bisyonure-de Taroo-ni kunsyoo-o ataeta
 President-N wet Taroo-D medal-ACC gave
'The president gave a medal to Taro wet.'
- b. Taroo-ga [Ziroo-ni kimono-sugata-de piano-o hik]
 Taroo-N Ziroo-D in kimono piano-ACC play
'Taro made Jiro play the piano in kimono.'

Similarly to Demonte (1987 1988) and Zabala (1993), Koizumi (1994: 73) argues that the dative marking in subject-like causees is a structural case marker instead of a P head. Koizumi (1994: 60) states that, at the level of argument structure, the depictive and its controller must satisfy the 'Principle of Predication': "predication relation between an NP and a predicate XP is licensed only if the following two conditions are satisfied at D-structure: the XP is c-governed by the NP (antecedent government: identification), and the XP is c-governed by a zero-level category". The syntactic

licensing of secondary predication is then formalized in different terms in Demonte (1987 1988) and Zabala (1993) on the one hand, and Koizumi (1994) on the other. However, for the purposes of the discussion, it is important to note that a structural relation is required in order to license secondary predication in the three of them. Such a relation happens to be blocked by the dative marker in indirect objects, but not in causees. Koizumi argues that in Japanese the *-ni* marker is a P head in the case of indirect objects, and a structural case marker in the case of the causee. Given that the structural case marker is not present when the ‘Principle of Predication’ takes place – i.e., at first merge, predication with causee datives is licensed under normal circumstances, as with the rest of DP arguments. By contrast, indirect objects are not able to license secondary predication at that moment of the derivation because the P head intervenes on the required structural relation with the secondary predicate.

Overall, in languages like Basque, Spanish and Japanese, the same structural condition that excludes indirect objects from controlling depictive secondary predication explains the fact that causees are able to control it. Indirect objects bear a P head that does not let them maintain the required c-command relation with the secondary predicate. On the contrary, being generated as DP subjects, causees do not have a P head blocking the structural relation with the secondary predicate, and as a consequence, predication is licensed in normal circumstances.

3.3. DOM OBJECTS AND DEPICTIVE SECONDARY PREDICATION

Let us now come back to our main concern in this chapter and see what the licensing of depictive secondary predication tells us about the nature of DOM objects. Taking into account that depictive secondary predicates are compatible with direct but not indirect objects, in 3.3.1 I point out that the availability to license depictive secondary predication has lead authors like Fernández & Rezac (2010 2016) and Odria (2012 2014) to group DOM objects with absolutive direct objects. In 3.3.2 the direct object nature of DOM objects is additionally strengthened by word order facts. Besides, in 3.3.3 I corroborate that the same secondary predication diagnostic points to an indirect

object configuration for the datives in bivalent unergatives, as has been already claimed by Fernández & Ortiz de Urbina (2009), Fernández & Rezac (2010 2016), Odria (2012) and Ortiz de Urbina & Fernández (2016). Ultimately, section 3.3.4 highlights the main results obtained in the section.

3.3.1. DOM objects license depictive secondary predication

Based on the assumption that dative marked indirect objects are not allowed to combine with depictive secondary predicates, Fernández & Rezac (2010: 133-134, 2016 117-112) and Odria (2012: 20-22, 2014: 294-297) examine the behavior of DOM objects in order to clarify whether these non-canonical objects are configurationally more akin to direct or indirect objects.

Their line of argumentation goes as follows. In general terms, DOM objects exhibit the same syntactic distribution as absolutive direct objects; they both occur in transitive constructions with ergative subjects, and no semantic nuance is attested when marking the object dative or absolutive. Thus, both Fernández & Rezac and Odria hypothesize that DOM objects are direct objects configurationally. However, given that their direct object nature may become blurred by the dative marking, these authors resort to the licensing of depictive secondary predication in order to check whether DOM objects are eventually direct objects. Considering that indirect objects are unable to license secondary predication, if DOM objects allow depictive secondary predication, they will be direct objects configurationally. Otherwise, an indirect object configuration will fit better with them.

The data in Fernández & Rezac (2010 2016) and Odria (2012 2014) clearly show that DOM objects are able to control depictive secondary predication. Let me illustrate this with examples from Larrabetzu Basque. The examples in (20) belong to a speaker with no DOM (in present tense) and those in (21) to a speaker with DOM (in both present and past tenses). What is important for the purpose of this chapter is that the dative objects in (21) can control depictive secondary predicates in the same way as the absolutive objects in (20).

- (20) a. (Zu-k) (ni)_i ostondute_i harrape nozu
you-E I.A hidden catch AUX
'You have caught me hidden.'
- b. (Ni-k) (zu)_i tontotute_i ikusi zaitut
I-E you.A silly see AUX
'I have seen you silly.'
- c. Lagun-ek Miren_i mozkortute_i grabe deure
friends-E Miren.A drunk record AUX
'Her friends have recorded Miren drunk.'
- (21) a. (Zu-k) (ni-ri)_i ostondute_i harrape dostezu
you-E I-D hidden catch AUX
'You have caught me hidden.'
- b. (Ni-k) (zu-ri)_i tontotute_i ikusi dotsut
I-E you-D silly see AUX
'I have seen you silly.'
- c. Lagun-ek Miren-eri_i mozkortute_i grabe dotsie
friends-E Miren-D drunk record AUX
'Her friends have recorded Miren drunk.'

Even though DOM exhibits a great deal of dialectal as well as idiolectal variation, the availability to control depictive secondary predication seems to be a persistent pattern. The results obtained in Larrabetzu are generalized among the rest of the consulted speakers from other Basque varieties (Arraztio 2010, Fernández & Rezac 2010 2016, Odria 2012 2014), and similar sentences are found in the spontaneous speech corpora too.⁴⁵ Consider, for instance, the examples in (22), gathered in Elgoibar Basque.

- (22) a. Ne-ri_i ez dia inoiz ino-k mozkortuta_i ikusi
I-D no AUX ever no one-E drunk see
'No one has ever seen me drunk.'
- b. Geldi_i ikusten diazu (ne-ri)_i?
still see AUX I-D
'Do you see me stil?'

⁴⁵ Arraztio (2010) tested the licensing of depictives by DOM objects in Araitz-Betelu, and Fernández & Rezac (2010 2016) in Lekeitio and Dima. I have tested the same diagnostic with speakers from Elgoibar, Errenteria, Hondarribia, Itsasondo, Oñati, Tolosa and Zumaia.

Spanish patterns again like Basque, as *a*-marked DOM objects are able to license depictive secondary predication. Even though Zabala (1993: 267) does not mention Basque DOM, this author points out that in Spanish, DOM objects can control depictive secondary predication. Following Gracia i Solé (1987: 61), Zabala shows that, in Spanish, contrary to indirect objects (23a), secondary predicates can be depicted of DOM objects (23b).

- (23) a. *Enrique le regaló un mecano a su hija; contenta;
 Enrique 3sgD gifted.3sg one erector to his daughter happy
'Enrique gifted an erector to her daughter happy.'
- b. Juan encontró a María; cansada;
 Juan found.3sg DOM María tired
'Juan found María tired.'

The *a*-marked argument *a su hija* 'to his daughter' is a goal indirect object in (23a), and is not able to control the depictive secondary predicate *contenta* 'happy'. Conversely, the *a*-marked DOM object *a María* in (23b) is able to control the depictive secondary predicate *cansada* 'tired'. As in Basque, this could lead us think that, in spite of the *a*-marking, Spanish DOM objects are also direct objects syntactically, and that the object in (23b) is configurationally equivalent to the one in (24).

- (24) Juan encontró el coche; destrozado;
 Juan found.3sg the car destroyed
'Juan found the car destroyed.'

The fact that in Spanish, contrary to indirect objects, DOM objects are able to license depictive secondary predication was first noticed by Demonte (1987: 148). This author shows that in (25a) the secondary predicate *borracha* 'drunk' cannot be controlled by *María*, the indirect object of the clause. Contrarily, in (25b) the same secondary predicate turns out to be controlled by the DOM object *a María*.

- (25) a. *Juan le_i habló a María_i borracha;
 Juan 3sgD talked.3sg to María drunk
'Juan talked to María drunk.'
- b. Juan la_i encontró a María_i borracha;
 Juan 3sgACC found.3sg DOM María drunk
'Juan found María drunk.'

In order to justify the possibility for DOM objects to license depictive secondary predication, Demonte (1987) claims that, as in causee datives, *a* is not a true preposition in DOM objects. Instead, this author takes *a* in examples like (25b) to be a dummy preposition, a preposition that does not project a PP maximal projection and does not therefore impede c-command relations. This way, Demonte states that the DOM object *a María* in (25b) can control the depictive *borracha* ‘drunk’ because there is no P head that blocks the structural c-command relation between them.

In line with Gracia Solé (1987) and Demonte (1987), I would like to add that, even being coded by the dative clitic *le(s)*, DOM objects can still be modified by secondary predication. This is in fact the situation we find in the *leísta* Spanish of the Basque Country, where DOM objects can be doubled by such clitic –see section 2.3.2 in chapter 2. Consider, for instance, the examples in (26), which are the correspondent Spanish examples of those in (21).⁴⁶ In (26a), the depictive secondary predicate *escondido* ‘hidden’ can be controlled by the *a*-marked object, which is in turn doubled by the dative clitic *le*. The same occurs in (26b) and (26c); the DOM object doubled by *le* can be the controller of the depictive *atontado* ‘silly’ and *borracha* ‘drunk’ respectively.

- (26)
- | | | | | | |
|----|------------------------------------|-----------------|--------------|----------------------|------------------------|
| a. | Juan | le _i | pilló | al niño _i | escondido _i |
| | Juan | 3sgD | caught.3sg | DOM child.M | hidden |
| | ‘Juan caught the child hidden.’ | | | | |
| | | | | | |
| b. | Juan | le _i | vio | a Pedro _i | atontado _i |
| | Juan | 3sgD | saw.3sg | DOM Pedro | silly |
| | ‘Juan saw Pedro silly.’ | | | | |
| | | | | | |
| c. | Su amiga | le _i | grabó | a María _i | borracha _i |
| | her friend | 3sgD | recorded.3sg | DOM María | drunk |
| | ‘Her friend recorded María drunk.’ | | | | |

As a consequence, assuming that dative marked indirect objects are not able to license depictive secondary predication, it seems reasonable to conclude that, both Basque and

⁴⁶ In order to avoid interferences, in the Spanish examples in (26) the object bears the same gender as well as number specification as the subject. Likewise, so as to test the behavior of the dative clitic *le(s)*, I have changed the objects in (21a) and (21b) to third person.

Spanish DOM objects are configurationally akin to absolutive and/or accusative direct objects.

3.3.2. The predicate does not need to be adjacent to the object controller

Having shown that DOM objects are akin to absolutive objects in being able to license depictive secondary predication, in this section I develop the similarity between DOM and absolutive objects by analyzing the adjacency between the object and the depictive.

Given that the canonical word order in Basque is SOV⁴⁷, and the depictive secondary predicate tends to be placed just before the main predicate, Zabala (1993: 270-271) explains that the predicate appears adjacent to its controller only when this is the direct object of the clause. Take, for instance, the examples in (27) provided by Zabala (1993: 270).

- (27) a. Aita-k_i semea-ri autoa lasai_i utzi zion
 father-E son-D car.A calm let AUX
 'The father let the car to his son calmly.'
- b. Semea-k aita-ri autoa_i apurtuta_i itzuli zion
 son-E father-D car.A broken return AUX
 'The son returned the car to his father broken.'

In (27a) the controller of the depictive secondary predicate *lasai* 'calm' is the subject *aita* 'father', and in (27b) the depictive *apurtuta* 'broken' is in turn controlled by the object *autoa* 'car'. Hence, concerning word order, the depictive and its subject are adjacent only when the latter is the direct object, as in (27b).

Nonetheless, as noted by Zabala (1993: 270-271), the direct object does not necessarily need to be adjacent to the secondary predicate, as the depictive can still be controlled by it when changing the canonical word order. This can happen when a given element of the clause is focalized by placing it just before the main verb. In the examples in (28),

⁴⁷ On the word order facts in Basque, see, among others, de Rijk (1969), Hualde (1988), Laka (1988 1993), Ortiz de Urbina (1989), Fernández (1997), Montoya (1998), Artiagoitia (2000), Elordieta (2001) and Oyharçabal (2010).

only (28a) is neutral semantically. (28b), and especially (28c) and (28d) involve marked (contrasted) focus. However, and even being structurally distant, the depictive secondary predicate *bero* ‘hot’ can still be controlled by the direct object *ardoa* ‘wine’ in all of them –specially when the direct object and the depictive are adjacent to the main predicate (Zabala 1993: 271).⁴⁸

(28)	a. Gu-ri we-D	taberna horr-etan bar that-INE	ardoa _i bero _i wine.A hot	atera serve	digute AUX	
	<i>‘In that bar they have served us the wine hot.’</i>					
	b. Gu-ri we-D	taberna horr-etan bar that-INE	bero _i hot	atera serve	digute AUX	ardoa _i wine.A
	c. ?Ardoa _i wine.A	taberna horr-etan bar that-INE	bero _i hot	gu-ri we-D	atera serve	digute AUX
	d. Ardoa _i wine.A	taberna horr-etan bar that-INE	atera serve	digute AUX	guri we-D	bero _i hot

In Basque, the focalized element in the clause occurs just before the main verb (Mixelena 1981, Ortiz de Urbina 1989, Osa 1990, Elordieta 2001, Etxepare & Ortiz de Urbina 2003, Irurtzun 2007). Thus, *bero* ‘hot’ is focalized in (28b), *guri* ‘to us’ in (28c) and *taberna horretan* ‘in that bar’ in (28d). The secondary predicate *bero* ‘hot’ and its subject *ardoa* ‘wine’ are then separated from each other and –even being semantically marked– the predication relation between *ardoa* ‘wine’ and *bero* ‘hot’ is obtained in the three of them.

Once again, DOM objects pattern like canonical absolutes in focalized contexts where the object and the depictive modifying it do not occur adjacent to each other. Even with a marked word order, the DOM object can still control the depictive secondary predicate. (29a) represents the unmarked word order, while the word order in (29b), (29c), (29d), (29e) and (29f) is semantically marked. What is important for us is that it is possible in all of them to obtain the interpretation where the depictive *ezkutauta*

⁴⁸ Note that even if the secondary predicate in (28) was *haserre* ‘angry’ instead of *bero* ‘hot’, although semantically understandable, the indirect object could neither be modified by it. The only possibility in that case would be to interpret that *haserre* ‘angry’ is controlled by the subject of the clause, which is third person plural.

‘hidden’ modifies the direct object *guri* ‘we’. The examples in (29) are provided by a DOM speaker from Elgoibar Basque.

- (29)
- | | | | | | | |
|----|------------------------------------|----------------------------------|----------------------------------|-------------------|----------------------------------|--|
| a. | Jon-ek
Jon-E | gu-ri _i
we-D | ezkutauta _i
hidden | harrapau
catch | zigun
AUX | |
| | <i>‘Jon has caught us hidden.’</i> | | | | | |
| b. | Jon-ek
Jon-E | gu-ri _i
we-D | harrapau
catch | zigun
AUX | ezkutauta _i
HIDDEN | |
| c. | Gu-ri _i
we-D | Jon-ek
Jon-E | harrapau
catch | zigun
AUX | ezkutauta _i
hidden | |
| d. | Gu-ri _i
we-D | Jon-ek
Jon-E | ezkutauta _i
hidden | harrapau
catch | zigun
AUX | |
| e. | Jon-ek
Jon-E | ezkutauta _i
hidden | harrapau
catch | zigun
AUX | gu-ri _i
we-D | |
| f. | Gu-ri _i
we-D | ezkutauta _i
hidden | harrapau
catch | zigun
AUX | Jon-ek
Jon-E | |

Hence, the following conclusion can be reached with the data in (28) and (29): be it absolutive or dative, there is no difference with respect to word order when interpreting that the depictive modifies the object of the clause. As with canonical objects (28), the non-canonical ones (29) can also occur phrase-structurally distant to the secondary predicate.

In addition, the results in this section indicate that depictive secondary predication holds in narrow syntax, before A'-movements take place at subsequent stages of the derivation. Otherwise, if secondary predication was licensed later in the derivation, different interpretations should be obtained contrasting examples with unmarked and marked word order. This is an important fact to consider for the analyses that aim to explain the restriction on the controller, as it implies that the restriction has to be at stake in syntax.

3.3.3. Datives in bivalent unergatives do not license depictive secondary predication

DOM objects pattern akin to dative objects in bivalent unergatives in that they both occur along with an ergative subject. Yet, as noted in chapter 2 (section 2.4.2), the dative marking in bivalent unergatives is not subject to factors like animacy or specificity and can emerge with objects of diverse nature (Etxepare 2003, Fernández & Ortiz de Urbina 2009 2010 2012, Ortiz de Urbina & Fernández 2016). As we will see, such a distinction is additionally supported by the fact that datives in bivalent unergatives of the *lagundu* ‘accompany, help’ type are unable to control depictive secondary predication (Fernández & Ortiz de Urbina 2009, Fernández & Rezac 2010 2016, Odria 2012, Ortiz de Urbina & Fernández 2016). In fact, the same Larrabetzu Basque speakers that allow depictive secondary predication with absolutive as well as DOM objects do not accept it with datives in bivalent unergatives. As illustrated in (30), in this case, the only possible interpretation is that the secondary predicate *mozkortute* ‘drunk’ modifies the subject *Jon* and not the dative object *Miren*.

- (30)
- | | | | | | |
|----|-----------------------------|------------------------|----------------------------|--------|--------|
| a. | Jon-ek _i | Miren-eri _j | mozkortute _{i/*j} | segidu | dotson |
| | Jon-E | Miren-D | drunk | follow | AUX |
| | ‘Jon followed Miren drunk.’ | | | | |
| | | | | | |
| b. | Jon-ek _i | Miren-eri _j | mozkortute _{i/*j} | bultze | dotson |
| | Jon-E | Miren-D | drunk | push | AUX |
| | ‘Jon pushed Miren drunk.’ | | | | |
| | | | | | |
| c. | Jon-ek _i | Miren-eri _j | mozkortute _{i/*j} | deitu | dotson |
| | Jon-E | Miren-D | drunk | call | AUX |
| | ‘Jon called Miren drunk.’ | | | | |

As we have done with DOM objects, let me briefly mention that Spanish behaves once again like Basque in not allowing depictive secondary predicates to depict of the dative object in verbs like *seguir* ‘follow’, *empujar* ‘push’ and *llamar* ‘call’. Consider now the

three examples in (31), where the secondary predicate *borracho* ‘drunk’ can only be controlled by the subject *Juan*.⁴⁹

- (31)
- | | | | | | |
|----|--|-----------------|--------------|----------------------|--------------------------|
| a. | Juan _i | le _j | siguió | a Pedro _j | borracho _{i/*j} |
| | Juan | 3sgD | followed.3sg | to Pedro | drunk |
| | ‘ <i>Juan followed drunk to Pedro.</i> ’ | | | | |
| | | | | | |
| b. | Juan _i | le _j | empujó | a Pedro _j | borracho _{i/*j} |
| | Juan | 3sgD | pushed.3sg | to Pedro | drunk |
| | ‘ <i>Juan pushed drunk to Pedro.</i> ’ | | | | |
| | | | | | |
| c. | Juan _i | le _j | llamó | a Pedro _j | borracho _{i/*j} |
| | Juan | 3sgD | called.3sg | to Pedro | drunk |
| | ‘ <i>Juan called drunk to Pedro.</i> ’ | | | | |

At this point, it is interesting to focus on the particular behavior of the dative object in *entzun* ‘hear, listen to’, a predicate grouped as a bivalent unergative by Etxepare (2003), Fernández & Ortiz de Urbina (2009 2010 2012) and Ortiz de Urbina & Fernández (2016). Fernández & Rezac (2010: 134) notice that according to the consulted speakers from Araitz-Betelu and Lekeitio, it is possible for the dative object of *this predicate* to control depictive secondary predicate *mozkortuta* ‘drunk’ (32).

- (32)
- | | | | | |
|---|----------------------|---------------------------|----------------|------|
| Ni-k _i | Mikel-i _j | mozkortuta _{i/j} | entzun | nion |
| I-E | Mikel-D | drunk | hear/listen to | AUX |
| ‘ <i>I heard/listened to Mikel drunk.</i> ’ | | | | |

The pattern found by these authors does not seem to be an isolated exception, since I have also found the same result among some of the interviewed speakers from Elgoibar, Larrabetzu and Tolosa. This is an unexpected pattern if *entzun* is in fact a typical bivalent unergative predicate, as dative objects of these predicates reject depictive predication. Nevertheless, I would tentatively suggest that the distinction between the two different meanings of *entzun* –i.e., ‘hear’ and ‘listen to’– might have an influence in this fact.

⁴⁹⁴⁹ In (31c), *borracho* ‘drunk’ can also be interpreted as a primary predicate referred to the dative *Pedro*. However, when behaving as a secondary predicate, *borracho* ‘drunk’ can only be controlled by the subject *Juan*.

Even though both the dative and absolutive may be used for both meanings, when *entzun* means ‘listen to’, dative marking is generally attested in southwestern dialects, while the absolutive is preferred in northeastern ones (Fernández & Ortiz de Urbina 2010: 129, 134). On the contrary, when *entzun* means ‘hear’, the object can also be absolutive in southwestern varieties. In fact, Ortiz de Urbina & Fernández (2016: 79-80) mention that in a sentence like *I heard the boss_i angry_i*, the object is usually marked absolutive, and that dative marking makes the sentence slightly worse. Taking this into account, one could then wonder whether the dative object in (32) is the object of ‘hear’ or ‘listen to’. If *entzun* in (32) meant ‘listen to’, its dative object would be more akin to the rest of the datives in bivalent unergatives and the fact that the object controls secondary predication would be unexpected. Conversely, if *entzun* in (32) meant ‘hear’ instead of ‘listen to’, its dative object would be closer to a DOM object, and in that case, it would pattern similar to other perception verbs like *ikusi* ‘see’. For this reason, it is possible to deduce that speakers allowing depictive modification with the object of *entzun* –all of them from southwestern Basque– consider such verb a pure transitive involving a theme object that, being dative, behaves as the rest of DOM objects. Be that as it may, determining whether *entzun* means ‘hear’ or ‘listen to’ in each specific context is not an easy task. Hence, the fact that ‘hear’ and not ‘listen to’ is involved in (32) is just a preliminary hypothesis that should be tested in further research.⁵⁰

⁵⁰ Apart from *entzun* ‘hear, listen to’, Fernández & Rezac (2010: 134) add that two DOM speakers from Araitz-Betelu do also allow the depictive secondary predicate modify the dative object with *jarraitu* ‘follow’, a bivalent unergative predicate. In addition, one of them can also do so with the dative object in *begiratu* ‘look at’. Nevertheless, this seems to be an exception taking into account that the rest of the consulted speakers by these authors and myself pattern alike in distinguishing DOM objects from datives in bivalent unergatives and allowing depictive secondary predication only with the former. Be that as it may, it is still important to notice that the dative object of bivalent unergatives like *lagundu* ‘help, accompany’ can also control secondary predication when pragmatics forces to do so. This is the case in (i), for instance, where along with the ergative subject, many speakers allow the depictive to modify the dative object.

- (i) (Haiek)_i (ni-ri)_j etxe-ra mozkortuta_{ij} lagundu zidaten
 they.E I-D house-ALL drunk help/accompany AUX
 ‘They helped/accompanied me home drunk.’

All in all, leaving aside the particular case of *entzun* ‘hear, listen to’, I conclude that, both in Basque and Spanish, the same depictive secondary predication test that points to a direct object configuration for DOM objects requires an indirect object one for those datives in bivalent unergatives.

3.3.4. Interim summary

In section 3.3, we have confirmed that DOM objects are able to license depictive secondary predication in the same way as canonical absolutes (Fernández & Rezac 2010 2016, Odria 2012 2014). Being an SOV language, in Basque the depictive is usually placed between the direct object and the main verb. However, as noted by Zabala (1993: 270-271), linear adjacency is not a required condition for the absolute object to control the depictive predicate, and we have obtained the same result with DOM objects. Therefore, assuming that depictives are ruled out with dative marked indirect objects, the fact that DOM objects license secondary predication has led us to the conclusion that these non-canonical objects are direct objects configurationally, a claim already made by Fernández & Rezac (2010 2016) and Odria (2012 2014).

Besides, we have also dealt with the behavior of dative objects in bivalent unergatives. Contrary to DOM objects, these are unable to license depictive secondary predication. Hence, we have corroborated that their syntactic configuration is more akin to true indirect objects (Fernández & Ortiz de Urbina 2009 2010 2012, Ortiz de Urbina & Fernández 2016).

Summing up, the literature on the topic has identified causees (Zabala 1993 2003) and DOM objects (Fernández & Rezac 2010 2016, Odria 2012 2014) as the only dative arguments allowing depictive secondary predication. The licensing of secondary predication has been explained configurationally in both of them. Causees are

Crucially, some of the consultants add that in (i) the possibility for the dative to control secondary predication is *logically* conditioned, because it is more common for the one who has been helped/accompanied to be drunk than the one who is actually helping/accompanying. Taking this into account, I believe that the facts in (i) do not necessarily bring into question the fact that (under normal circumstances) datives in bivalent unergatives are unable to control secondary predication.

considered to be able to control secondary predication, because they are configurationally subjects of the embedded predicate of the causative construction. Hence, instead of a P head, their dative marking corresponds to a structural case marker. Likewise, secondary predication with DOM objects has been supported by the fact that these objects share the same syntactic configuration with canonical absolutes. The licensing of secondary predication is thus justified by the subjecthood of the causee on the one hand, and the objecthood of the DOM object on the other. Having a syntactic configuration distinct to indirect objects, the licensing of secondary predication is straightforwardly accounted for in both of them.

Notwithstanding, the behavior of the causee and DOM objects may not exclusively be linked to their subject or direct object configuration, and a deeper distinction may lie behind the restriction on the controller. In Basque, dative arguments exhibit a dual DP vs. PP-like behavior. Goals behave like PPs, because under certain circumstances they can occur without dative markers in the finite verbal form. On the contrary, possessors and experiencers are not able to appear without dative markers and are thus considered to display a DP syntactic category. Given their behavior in PCC-affected ditransitives and double dative constructions, in this dissertation causees are regarded as DPs as well, although non-agreeing examples have also been found in northeastern Basque (Fernández, Ortiz de Urbina & Landa 2009:214-215).⁵¹ As I will further show in chapter 4, DOM objects are generally unable to occur without dative markers when combining with another dative, which indicates that these datives behave more akin to DPs than to PPs. On that account, one could wonder whether experiencers and possessors may also pattern like causee and DOM objects in licensing depictive secondary predication, as in the literature on secondary predication, most of the examples showing the restriction on the controller involve a goal indirect object. This is, in fact, the task we will undertake in the next section.

⁵¹ For non-agreeing datives in northeastern Basque, see Ortiz de Urbina (1995), Fernández (1997 2010 2014), Fernández & Landa (2009), Fernández, Ortiz de Urbina & Landa (2009), Fernández & Ortiz de Urbina (2010), Albizu (2001 2009), Etxepare & Oyharçabal (2008abc 2009ab 2013), Etxepare (2014) and Ormazabal & Romero (2017).

3.4. DEPICTIVE SECONDARY PREDICATION ALLOWS DP BUT NOT PP-LIKE DATIVSE

In this section, I consider the distinction between DP and PP-like datives and analyze how depictive secondary predication combines with each of them. The section is divided in two parts. In 3.4.1, I highlight that the dual DP vs. PP-like nature of dative arguments has gone unnoticed when addressing the restriction on the controller. Generally speaking, only PP-like datives like goals have been examined when analyzing the behavior of dative arguments with respect to secondary predication. As we will see, the data involving this kind of PP-like datives consistently prove that depictives are not allowed with them. In 3.4.2, I show that DP datives such as possessors and experiencers are indeed able to license depictive secondary predication (Odria 2015).

Therefore, the novel results in this section contrast with the standard assumption taking all sorts of dative indirect objects to be incompatible with secondary predication. Depictives are only excluded with those datives that can behave as PPs. Hence, I conclude that, instead of determining its syntactic configuration, depictive secondary predication determines the original syntactic category –i.e., DP vs. PP– of a given argument. As a consequence, this kind of predication should no longer be taken to distinguish between subjects/direct objects on the one hand, and indirect objects on the other, but rather between DP and PP(-like) arguments. This makes depictive secondary predication a useful tool when identifying the original syntactic category of DOM objects in particular and dative arguments in general. If depictives are only impossible with PP-like datives, the fact that DOM objects are possible controllers leads us to the conclusion that these non-canonical objects are DPs categorically.

3.4.1. PP-like datives are not able to license depictive secondary predication

Until now, the examples showing that datives are unable to license secondary predication have mostly involved PP-like goals. The dual DP vs. PP-like nature of dative arguments has been unconsidered in this regard and PP-like datives have represented the behavior of all dative arguments. Leaving aside the particular case of

the causee, datives have always been taken uniformly in this respect, as if all of them showed one and the same pattern concerning secondary predication. In Basque, the only possible exception has to do with the discussion on the syntactic nature of DOM objects and datives in bivalent unergatives. Under the assumption that indirect objects cannot license secondary predication, depictives have been used as a test to identify the syntactic configuration of these two datives (Fernández & Ortiz de Urbina 2009, Fernández & Rezac 2010 2016, Odría 2012 2014, Ortiz de Urbina & Fernández 2016). However, even in this case a single behavior has been attributed to the different types of dative arguments, and goals of verbs like *eman* ‘give’ have been taken to illustrate the behavior of all of them. For this reason, the distinct pattern of DOM objects has not been linked to the DP vs. PP-like categorical distinction of dative arguments, but to the direct vs. indirect object configurational distinction.

Let us then analyze one by one some of the examples that have been used to support the restriction on the controller of depictive secondary predication. Note that all the sentences in (33) (Zabala 1993 2003), and (34) (Arregi & Molina-Azaola 2004: 103) involve goal indirect objects.⁵²

- (33)
- | | | | | |
|---|--------------------|------------------------|------------------------------------|-----------------------|
| a. *Miren- <i>i</i> _i | liburu bat | urduri _i | oparitu | diogu |
| Miren-D | book one.A | nervous | gift | AUX |
| <i>‘We have gifted a book to Miren nervous.’</i> | | | | |
| | | | | |
| b. *Jon- <i>i</i> _i | multa bat | edan-tzat _i | jarri | zioten |
| Jon-D | fine one.A | drunk-PRO | put | AUX |
| <i>‘They fined Jon for drunk.’</i> | | | | |
| | | | | |
| c. *Haurra- <i>ri</i> _i | mila peseta | eman | zioten | sarituta _i |
| child-D | thousand pesetas.A | give | AUX | gifted |
| <i>‘They gave the child thousand pesetas gifted.’</i> | | | | |
| | | | | |
| d. *Peru- <i>k</i> | liburu bat | oparituzion | bere alaba- <i>ri</i> _i | gaixorik _i |
| Peru-E | book one.A | gift | AUX | his daughter-Dill |
| <i>‘Peru gifted his daughter a book ill.’</i> | | | | |

⁵² The reader can find the examples in (33) in: (33a) Zabala (1993: 258), (33b) in Zabala (1993: 265), (33c) in Zabala (1993: 265), (33d) in Zabala (2003: 445) and (33e) in Zabala (1993: 451).

e. *Liburu hau Mikel-_i sarituta_i eman diot
 this book.A Mikel-D gifted give AUX
 ‘They have given this book to Mikel gifted.’

(34) *Ni-k zu-ri_i umea mozkortuta_i emon dautsut
 I-E you-D child.A drunk give AUX
 ‘I have given you the child drunk.’

The goals in both (33) and (34) are unable to control depictives like *urduri* ‘nervous’ (33a), *edantzat* ‘drunk’ (33b), *sarituta* ‘gifted’ (33c, 33e), *gaixorik* ‘ill’ (33d) or *mozkortuta* ‘drunk’ (34). Most of the examples in (33) and (34) involve ditransitive constructions with a goal dative that behaves as the receiver of the transferred direct object. (33a) and (33d) contain the verb *oparitu* ‘gift’, (33b) *jarri* ‘put’ and (33c), (33e) and (34), *eman* ‘give’, all of them ditransitive predicates with a goal dative that behaves as a PP in other contexts.⁵³

Besides, taking into account the PP-like behavior of the datives in (33) and (34), it is important to highlight that the restriction on the controller does not only exclude dative marked indirect objects, but also PPs of different sort. Take, for instance, the example in (35). In (35a) the benefactive PP *haurrarentzat* cannot be depicted of the secondary predicate *gaixorik* ‘ill’ (Zabala 1993: 255), and the same occurs with allative and sociative PPs like *haurrarengana* (35b) or *haurrarekin* (35c). None of them is able to control depictive secondary predicate.

(35) a. *Jostailu bat erosi dugu haurra-rentzat_i gaixorik_i
 toy one.A buy AUX child-DEST ill
 ‘We have bought a toy for the child ill.’

b. *(Ni) pozik_i hurbildu naiz haurra-rengana_i
 I.A happy approach AUX child-ALL
 ‘I have approached to the child happy.’

c. *(Ni) pozik_i etorri naiz haurra-rekin_i
 I.A happy come AUX child-SOC
 ‘I have come with the child happy.’

⁵³ *Jarri* ‘put’ differs from *oparitu* ‘gift’ and *eman* ‘give’ in that it is not a ditransitive predicate *per se*, but a transitive predicate that can optionally take a dative marked indirect object.

Overall, considering the examples in (33), (34) and (35), we see that the same datives that behave as PPs with regards to the possibility to occur without dative markers in the finite verb pattern as the rest of PPs regarding the licensing of secondary predication. In (36), for instance, the benefactive PP in (35a) is realized as a goal dative, and the secondary predicate *gaixorik* ‘ill’ is equally unavailable to predict of it.

- (36) *Jostailu bat erosi diogu haurrari_i gaixorik_i
 toy one.A buy AUX child-D ill
‘We have bought a toy to the child ill.’

In addition to goals of ditransitive predicates, motion goals of unaccusative predicates have also been used to demonstrate that datives cannot license secondary predication. These predicates occur in a bivalent unaccusative configuration with an absolutive argument that is structurally higher than the PP-like goal (Etxepare 2003, Fernández & Ortiz de Urbina 2010). This is the case in (37a) (Zabala 1993: 266) and (37b) (Oyharçabal 2010: 253).

- (37) a. *Ehiztari-akbasurdea-ri_i zauriturik_i jarraiki zitzaizkion
 the hunters-A boar-D wound follow AUX
‘The hunters followed the boar wound.’
- b. *Jon-i_i mozkorrik_i hurbildu zitzaizkion lagunak
 Jon-D drunk approach AUX friends.A
‘His friends approached Jon drunk.’

In (37a), the secondary predicate *zauriturik* ‘wound’ cannot be controlled by the goal *basurdeari* ‘to the boar’, and the same thing happens in (37b); only the absolutive *lagunak* can control the secondary predicate *mozkorrik* ‘drunk’.

Synthesizing, the situation with PP-like datives seems to be rather clear: goals are not able to control secondary predicates. Therefore, the results in this section fit well with the widely held assumption excluding dative indirect objects from controlling depictive secondary predication. Nevertheless, given that goal datives behave as PPs under certain circumstances, I believe the data in this section are not conclusive enough to claim that depictives are ruled out with all kind of dative indirect objects. Rather, taking into account the PP-like behavior of those datives seriously, the examples analyzed in this section can only prove that depictive secondary predication is unavailable with PP-like

datives. In order for the restriction on the controller to be generalized to all type of datives, the same pattern should be found with the rest of DP datives too –i.e., possessor and experiencers. Only if these DP datives happen to be banned by depictives in the same way as the PP-like ones will the widely held assumption be definite and consistent with different kind of dative indirect objects.

3.4.2. DP datives are able to license depictive secondary predication

Actually, the assumption excluding dative indirect objects from licensing secondary predication seems to be challenged by possessor and experiencer datives. These datives pattern with causee and DOM objects, as for many speakers depictive secondary predication is allowed in both of them (Odria 2015).

3.4.2.1. Possessor datives

Let us start with possessor datives.⁵⁴ Possessor datives entail a possession relation between the dative and the absolutive argument, the former being the possessor and the latter the possessee. Such possession relation can be inalienable as in (38) or alienable as in (39) and, depictive secondary predication is in fact available in both of them.

(38) a. (Haiek) (ni-ri)_i udaleku-etan ilea lokartuta_i moztu zidaten
 (they.E) (I-D) summer camp-INE hair-A sleeping cut AUX
'In the summer camp, they have cut me the hair sleeping.'

b. (Haiek) Jon-i_i kistea anesthesiatuta_i kendu zioten
 (they.E) Jon-D cyst.A anesthetized remove AUX
'They have removed the cyst to John anesthetized.'

(39) (Haiek) umea-ri_i txupetea negarrez_i kendu diote
 (they.E) child-D pacifier.A crying remove AUX
'They have removed the pacifier to the child crying.'

The majority of the consulted speakers take the possessor dative to be the only argument controlling the secondary predicate *lokartuta* 'sleeping' in (38a) and *anesthesiatuta* 'anesthetized' in (38b). In (39), the secondary predicate *negarrez* 'crying' can be controlled either by the ergative or dative argument; although the former is not a

⁵⁴ For syntactic analyses of possessor datives in Basque, see Arregi (2003), Etxepare (2003), Albizu (2009), Fernández (2010) and Fernández & Ortiz de Urbina (2010).

logical or pragmatically probable situation. One could then wonder whether the possibility for the possessor to control the depictive predicate in examples like (38) and (39) is just pragmatically forced. As noted by many of the consultants, in (38), it is not possible for the one who is cutting someone's hair to be sleeping and the same occurs in (38b), as the one who is removing the cyst cannot be anesthetized. Something similar happens in (39) too, since it is more logical to consider the child to be crying when someone is removing him/her the pacifier, and not the other way around. Be that as it may, I would like to add that when it comes to goal datives, the possibility to control secondary predication is still untenable even in pragmatically forced contexts like those in (40).

- (40) a. *Jon-i_i medikua gaixorik_i bidali diote etxe-ra
 Jon-D doctor.A ill send AUX house-ALL
'They have sent the doctor ill to Jon.'
- b. *Medikua-k Jon-i_i botika gaixorik_i eman dio
 doctor-E Jon-D medicine.A ill give AUX
'The doctor has given Jon the medicine ill.'

Both in (40a) and (40b), the most logical reading would be that the secondary predicate was controlled by the goal dative *Jon*, as pragmatically speaking, the doctor is supposed not to be ill. Notwithstanding, even though some of the consultants admit that they could come to understand such interpretation in (40a), all of them agree in considering both (40a) and (40b) ungrammatical. As a consequence, I conclude that the possibility for possessors to control secondary prediction is not only due to pragmatic reasons, as goals are unable to do so under the same circumstances.

At this point, I would like to mention that, along with goal datives, Zabala (1993) also takes possessor datives in bivalent unaccusatives to be incompatible with secondary predication. Consider the examples provided by this author in (41a) (Zabala 1993: 266), (41b) (Zabala 1993: 394) and (41c) (Zabala 1993: 413)

- (41) a. *Mikel-i ilea gaixorik erori zitzaion
 Mikel-D hair.A ill fall AUX
'Mikel has his hair fallen out ill.'

- b. *Liburua Miren-i urduri erori zaio
 book.A Miren-D nervous fall AUX
'The book has fallen to Miren nervous.'
- c. *Ane-ri liburua nekatuta erori zaio
 Ane-D book.A tired fall AUX
'The book has fallen to Ane tired.'

At first glance, one could think that the examples in (41) bring into question the claim that possessor datives are able to allow depictive secondary predication, as none of the possessors in (41) allow it. Nevertheless, I consider that the impossibility for the possessors to control secondary predication in contexts like (41) does not necessarily come from its dative marking. Instead, I believe that the ungrammaticality in (41) is just related to the nature of the predicate *erori* 'fall', whose "subject-like" dative does not have control over the event described by the verb. In fact, as noted by Zabala (1993 2003), regardless of their case marking, depictives are unable to occur with stative verbs and non-controller subjects. This is what happens in the examples in (42) and (43) (Zabala 1993: 268, 2003: 254). In these examples, even being ergative marked, the subject is unable to control the depictive secondary predicate because it does not control over the event described by the verb

- (42) *Haur hon-ek musika atsegin du liluraturik
 child this-E music.A like AUX fascinated
'This child likes music fascinated.'

- (43) a. *Amaia-k ikasgaia pozik daki
 Amaia-E subject.A happy know
'Amaia knows the subject happy.'

- b. *Jon-ek lasai daki ikasgaia
 Jon-E calm know subject.A
'Jon knows calmly the subject.'

In (42) and (43), the impossibility to license depictive secondary predication does not arise as a consequence of the ergative marking of the subject, because apart from these contexts, ergative subjects are able to control secondary predication. The examples in (42) and (43) could instead be ungrammatical because, as pointed out by Zabala (1993: 258, 2003: 452), the ergative argument that is intended to control the depictive does not control over the event of 'liking' in (42) and 'knowing' in (43a) and (43b).

Consequently, I conclude that the same reasons lie behind the ungrammaticality in (42) too. In (42) the depictive is unable to modify the possessor because this does not control over the event of falling. These examples should then not be regarded as counter-evidence to the hypothesis that possessors can control secondary predication.

Once again, as it was the case with causee and DOM objects, we see that Spanish behaves like Basque in allowing possessor datives to be subjects of secondary predication. In spite of their restricted nature, the case of possessor datives has occasionally been regarded as an exceptional case considering examples like those in (44). (44a) and (44b) are provided by Demonte & Masullo (1999: 2466), (44c) by Hernanz (1988: 12) and (44d) by Bosque (2011: 728).

- (44) a. A María_i, le_i operaron el quiste dormida_i
to María, 3sgD operated.3pl the cyst sleeping
'María was operated the cyst sleeping.'
- b. Le_i extirparon el lunar a Consuelo_i anestesiada_i
3sgD removed.epl the mole to Consuelo anesthetized
'They removed the mole to Consuelo anesthetized.'
- c. A la enferma_i los cirujanos le_i extirparon el quiste anestesiada_i
to the patient, the surgeon 3sgD removed.3pl the cyst anesthetized
'The surgeons removed the cyst to the patient anesthetized.'
- d. Le_i registraron los bolsillos apoyado en una pared_i
3sgD registered.3pl the pockets supported in the wall
y con las manos atadas a la espalda_i
and with the hands tied to the back
'They registered him/her the pockets supported in the wall and with the hands tied to the back.'

In the examples in (44), the possessor bears the preposition *a*, and is in turn doubled by the dative clitic *le*. Despite of that, it is able to control secondary predication.

3.4.2.2. Experiencer datives

Giving further support to the contrast between DP and PP-like datives, in this section I additionally show that, for some speakers, experiencers of psychological predicates do also allow depictive secondary predication. This is illustrated in the examples in (45).

- (45) a. (?/??)Miren-_i mutil hori mozkortuta_i gustatzen zaio
Miren-D boy that.A drunk like AUX
‘Miren likes that boy drunk.’
- b. (?/??)Miren-_i mutil hori mozkortuta_i interesatzen hasi zaio
Miren-D boy that.A drunk interest begin AUX
‘Miren has begin to be interested in that boy drunk.’

The examples in (45) involve experiencer datives in bivalent unaccusative constructions and the depictive *mozkortuta* ‘drunk’ is able to modify such dative in both (45a) with the predicate *gustatu* ‘like’ and (45b) with *interesatu* ‘interest’.⁵⁵ Of course, both in (45a) and (45b), the depictive can also be controlled by the absolutive object *mutil hori* ‘that boy’.⁵⁶

Spanish patterns with Basque in allowing subject-like experiencer datives to control depictive secondary predication too. This is illustrated by the examples in (46) provided by Fernández-Soriano (1999: 124).⁵⁷ In (46), the secondary predicates *ausente* ‘absent’, *presente* ‘present’ and *borracho* ‘drunk’ are controlled by the elided first (46a, 46b) or third person (46c) experiencer datives.

⁵⁵ In order to obtain the reading where the depictive modifies the dative argument, one of the consultants says that the predicate should be placed adjacent to the dative experiencer. Besides, another one adds that the depictive should occur at the beginning of the sentence, followed by a comma or pause. Likewise, another speaker considers that the mentioned interpretation would sound more natural if the predicate *mozkortuta* ‘drunk’ was substituted by an embedded clause like *mozkortuta dagoenean* ‘when she is drunk’. These facts could be linked to specifications made by Demonte & Masullo (1999: 2466-2467) regarding the combination of secondary predication with possessor datives. These authors explain that the licensing of depictive secondary predication by possessor datives is quite restricted in Spanish and that the depictives allowed in these contexts tend to be replaceable with gerundive verbal periphrases, like *estando dormida* ‘being slept’ for *dormida* ‘slept’, or *estando anestesiada* ‘being anesthetized’ for *anestesiada* ‘anesthetized’.

⁵⁶ In fact, some of the consultants are doubtful about (45). Besides, others consider that the depictive in these examples is only able to control the absolutive argument. Taking this into account, I have marked the examples in (45) as (?/??).

⁵⁷ The example in (46a) was gathered by Fernández-Soriano (1999: 124) in *La Dorotea* by Lope de Vega.

- (46) a. Mal me_i fue ausente_i pero peor presente_i
 bad 1sgD went.1sg absent but worse present
'Things were bad for me while absent but worse when present.'
- b. Nos_i dieron las dos borrachos_i
 1plD gave.3pl two o'clock drunk
'It got as late as 2 o'clock on us and we were drunk.'
- c. Le_i ocurrió un accidente borracha_i
 3sgD happened.3sg an accident drunk
'An accident happened to her while being drunk.'

Overall, along with causees, DOM objects and possessors, experiencer datives are also able to control secondary predication both in Basque and Spanish. Considering the DP syntactic category of all the datives that are able to license this kind of predication, this supports the claim that depictive secondary predication is only rejected with datives that show a PP-like category –i.e., with goals.⁵⁸

3.4.3. Interim summary

In this section I have proved that depictives are only ruled out when combining with goal datives and PP arguments of different sort. The restriction on the controller is thus more limited than previously assumed. In contrast to what has been claimed in previous research (Zabala 1993 2003, Arregi & Molina-Azaola 2004, Oyharçabal 2010), I conclude that the restriction on the controller does not affect all kind of dative arguments, but only those that are PP-like. Hence, instead of determining the syntactic configuration of a given argument, depictive secondary predication should be considered to be a relevant tool to determine the original syntactic category of a given argument (Odria 2015).

Besides, in this section we have seen that Spanish behaves like Basque in this respect. As in Basque, in Spanish only goals can occur without being doubled by the dative clitic; possessors and experiencers are always clitic doubled (Masullo 1992, Demonte 1995, Romero 1997, Cuervo 2003) –and clitic doubling with DOM and causee datives

⁵⁸ As we have seen in the case of possessor datives, the possibility for DP datives to license secondary predication does not imply all instances of DP datives to license it. As happens with ergative subjects, depending on the nature of the verb, depictives are sometimes unable to be controlled by these datives.

is subject to dialectal variation. Crucially, the results in this section indicate that, in Spanish, depictives are only rejected by goal datives that can appear as PPs, without involving clitic doubling. In spite of its restricted nature, possessor and subject-like experiencers that appear doubled by a clitic are in turn able to control secondary predication.

Coming back to our main concern, the data in this section demonstrate that the fact that DOM objects are possible controllers of secondary predication does not necessarily entail that these non-canonical objects are direct objects syntactically –as we have argued in section 3.3 following Fernández & Rezac (2010 2016) and Odria (2012 2014). Instead, taking into account the behavior of causee, possessor and experiencer datives, the licensing of depictive secondary predication test indicates that DOM objects have a DP syntactic category. Obviously, this does not bring into question the direct object nature of DOM objects. As we have noted in chapter 1, DOM objects are direct objects configurationally, given that they display the same argumental as well as thematic relationship to canonical absolutes.

3.5. SOME CONSEQUENCES OF THE UPDATED RESTRICTION ON THE CONTROLLER

In this section, I develop certain implications that arise from the updated restriction on the controller. Section 3.5.1 argues that the restriction is syntactic in nature and that hence, it should be accounted for in structural –rather than functional-semantic– terms. In section 3.5.2, I deal with the syntactic origin as well as subsequent derivation of DP and PP-like datives. On the one hand, I propose that PP-like goals are introduced in syntax as PPs. Given that depictives are rejected by PPs and both agreeing and non-agreeing goals, this explains the impossibility for agreeing goals to license this kind of predication. Thus, I argue that agreeing goals are actually derived from an original PP argument. In particular, following the main tenets in Ormazabal & Romero (1998 2010 2017) and Albizu (2001 2009), I claim that goals are generated as PP complements of V and that agreement with the finite verb arises as a consequence of the incorporation of the P head into V. On the other hand, considering that depictives are instead allowed

with causee, experiencer and possessors, I put forth that these are indeed generated as DPs. To finish, section 3.5.3 closes the chapter by claiming that, once assuming a derivational analysis for PP-like datives, the structural analysis of the restriction on the controller favors the Complex Predicate approach of depictive secondary predication.

3.5.1. The restriction is syntactic in nature

In section 3.4, we have seen that in Basque –and Spanish– the asymmetry that lies behind the restriction on the controller does not have to do with configurational or functional notions like ‘direct objects vs. indirect objects’. In this section, I emphasize that such restriction is neither dependent on semantic notions like ‘themes vs. goals’. Instead, the different behavior displayed by DP and PP-like datives indicates that what is relevant for the licensing of secondary predication is in fact the original syntactic category of the controller argument. The updated restriction on the controller should then be accounted for structurally, attributing to the P head the blocking effect to impede the licensing of secondary predication.

As pointed out in section 3.2, a structural account of the restriction on the controller was already supported by Demonte (1987 1988) for Spanish, Zabala (1993) for Basque and Koizumi (1994) for Japanese, among others. Although the three of them assume that depictives reject all kind of dative indirect objects, I would like to point out that their main insight was to a great extent on the right track. These authors argue that the reason for dative arguments to be excluded from controlling secondary predication has to do with the pre/postpositional nature of the dative marker. The dative marker in indirect objects is considered to be equivalent to a P head, a head that intervenes in the structural relation that should be established between the controller and the depictive (Williams 1980, Rothstein 1983). For these authors, P is thus the trigger for preventing datives and PPs from licensing secondary predication. On that account, subjects and direct objects are the only arguments that are able to control secondary prediction because, contrary to dative indirect objects, these are not contained within a PP (Demonte 1987: 148-148).

In section 3.4, we have seen that in Basque only goals behave as PPs with regards to the licensing of secondary predication. For this reason, even though the structural approach assuming the blocking effect of the P head was originally put forth to account for the

behavior of all kind of datives, I believe that the gist of the analysis could still be maintained to explain the impossibility to combine depictives with goals and PPs of different sort. Before providing further evidence supporting the syntactic account for the restriction on the controller, I will briefly mention the main tenets of the functional-semantic point of view.

The functional-semantic approach was put forth by Bresnan (1982) and Zubizarreta (1985). As noted by Demonte (1987: 148), these authors capture the restriction on the controller by saying that subjects and direct objects are the only two functional positions in which various theta-roles can be assigned. On the one hand, Bresnan (1982: 377-378, 401) maintains that instead of the structural c-command requirement, it is the function of a given argument that determines the possibility to control depictive secondary predication. According to Bresnan, the restriction on the controller is thus conditioned by functional-semantic reasons. On the other hand, Zubizarreta (1985: 251) claims that secondary predicates are only licensed by subjects and direct objects because these arguments occur in semantically unrestricted grammatical positions.

Both Bresnan (1982) and Zubizarreta (1985) focus on the behavior of Spanish DOM in order to support their hypothesis. Consider again the contrast given in (23), repeated here in (47), where only the *a*-marked object in (47b) is able to license secondary predication.

- (47)
- | | | | | |
|--------------------------------------|-----------------|------------|----------------------|-----------------------|
| a. *Juan | le _i | habló | a María _i | borracha _i |
| Juan | 3sgD | talked.3sg | to María | drunk |
| <i>'Juan talked to María drunk.'</i> | | | | |
| | | | | |
| b. Juan | la _i | encontró | a María _i | borracha _i |
| Juan | 3sgACC | found.3sg | DOM María | drunk |
| <i>'Juan found María drunk.'</i> | | | | |

Bresnan (1982: 401) argues that the contrast between (47a) and (47b) is functional in nature. In (47a), the *a*-marked object cannot license secondary predication because it has the oblique function. Contrarily, in (47b) the *a*-marked object is able to license

secondary predication because it has the object function.⁵⁹ Likewise, Zubizarreta (1985) explains that secondary predication is banned in (47a) and not in (47b), because only the former is in a semantically restricted position.

As explained in section 3.3, Demonte (1987) accounts for the contrast in (47) in structural terms and claims that the structural analysis is superior to the functional-semantic. Based on evidence related to extraction of complements out of PPs and pseudo-PPs in Spanish, Demonte (1987: 150) argues that the preposition *a* in (47b) does not count as a true preposition that blocks c-command relations and behaves instead as a mere structural case marker. This author puts forth that the preposition *a* is a true preposition in (47a) and a dummy preposition that does not project a PP in (47b).

Following Bresnan (1982) and Zubizarreta (1985), one could still maintain that DOM objects are compatible with secondary predication because they have a direct object function. In the same vein, the behavior of the causee could equally be explained by assuming that these are subjects of the embedded predicate, and not oblique arguments. Nonetheless, although the subject-like behavior could also be extended to experiencer datives, possessors in ditransitive configurations could hardly be grouped with those arguments that pattern as subjects, and this would pose a problem for the functional point of view. Actually, the data in section 3.4 indicate that the fundamental problem for this approach is that depictives are excluded with some but not all oblique arguments. Note that if the restriction on the controller was functional in nature, the different kind of dative marked indirect objects should pattern uniformly, contrary to facts.

The semantic approach of the restriction on the controller is additionally challenged by certain theme-like datives in bivalent unergative predicates that are incompatible with depictive secondary predication. Fernández & Ortiz de Urbina (2010: 156-157) say that identifying whether the object of certain bivalent unergatives corresponds to a goal or to a theme is not an easy task. This is the case with predicates like *begiratu* ‘look at’, *bultzatu* ‘push’, *erreparatu* ‘repair’, *esetsi* ‘attack’, *iguriki* ‘wait’, *itxaron* ‘wait’,

⁵⁹ Bresnan adds that the accusative clitic *la* in (47b) supports the direct object nature of *a María* in that sentence. Nevertheless, recall that in the *leísta* Spanish of the Basque Country the accusative preposition *la* would be substituted by the dative *le* in the same example.

jarraiki ‘follow’, *jazarri* ‘persecute’, *oratu* ‘hold’, *segitu* ‘follow’ and *ukitu* ‘touch’. Even though the object of these predicates does not correspond to a canonical theme, attributing a goal theta-role is still doubtful in certain contexts. Discussing whether the object of each of these predicates bears a theme-like or a goal theta-role is out of the scope of this dissertation. Nonetheless, for the purposes of the discussion, it is worth pointing out that those PP-like objects that are not completely goals thematically are unable to control depictive secondary predication in the same way as the rest of goal datives in bivalent unergatives like *abisatu* ‘notify’, *barkatu* ‘forgive’, *entzun* ‘hear, listen to’, *erregutu* ‘pray’, *eskertu* ‘thank’, *kontseilatu* ‘give advice’, *manatu* ‘order’, *obeditu* ‘obey’, *laga* ‘let, leave’, *lagundu* ‘help, accompany’ and *utzi* ‘let, leave’ (Fernández & Ortiz de Urbina 2010: 132). An approach that takes the restriction on the controller to be semantic would then be in trouble to account for the fact that those theme-like datives are excluded from licensing secondary predication too. Such an approach would expect all kind of theme arguments to be able to control depictive secondary predication.

Ultimately, I would also like to point out that in Basque the licensing of secondary predication does neither depend on the relatively high or low configuration of the controller argument. Given the asymmetric configuration exhibited by DP and PP-like datives in bivalent unaccusatives, the distinction regarding the syntactic category has been linked by some authors to the high vs. low position of dative arguments. In bivalent unaccusatives, DP datives c-command the absolutive object, while PP-like datives are instead c-commanded by it (Oyharçabal 1992, Zabala 1995, Artiagoitia 2000, Albizu & Fernández 2006, Rezac 2008b 2009ab 2011, Albizu 2009, Fernández 2014). Based on these facts, DP and PP-like datives have accordingly been referred as high and low datives in studies like Fernández (2010 2014), Fernández & Landa (2009), Fernández, Ortiz de Urbina & Landa (2009), Fernández & Ortiz de Urbina (2010), Fernández & Sarasola (2010).

Regarding the correlation between the syntactic category and structural configuration, one could then think that the restriction on the controller is related to the high vs. low position of the dative arguments and assume that only the latter are ruled out with secondary predication. Such a distinction would be reminiscent of Pytkänen’s (2008)

analysis of high and low datives.⁶⁰ Pylkkänen argues that depictives are only licensed by high applicative arguments like benefactives, malefactives or instruments, among others. Low applicatives like sources and goals, on the other hand, are unable to do so.⁶¹ However, it is important to note that in Basque, the licensing of secondary predication is not contingent on the high vs. low position of the controller, but rather on its original syntactic category. This is evidenced by the behavior of DOM objects, which are generated in a low position –i.e., as complements of V– and are indeed able to license secondary predication as the rest of so-called high datives. If the restriction was contingent on the high vs. low position, DOM objects would neither be expected to control secondary predication. Therefore, I conclude that the restriction on the controller depends exclusively on the DP vs. PP original syntactic category, as the high vs. low configurational distinction is unable to capture the behavior of DOM objects.

⁶⁰ Pylkkänen's (2008) high and low applicatives are not distinguished by their c-command relation with regards to the internal object. In her analysis, both high and low applicatives c-command the direct object. This is not the case with Basque high and low datives. In Basque, high datives c-command the internal object and the low ones are indeed c-commanded by it. In this sense, the dual character of Basque high and low datives is more akin to McFadden's (2004) distinction between high and low datives in German (Fernández, Ortiz de Urbina & Landa 2009: 200, 202, Fernández & Ortiz de Urbina 2010: 31). McFadden distinguishes two kind of dative arguments in German: those that behave as DPs c-command the direct object, while those that behave as PPs are indeed c-commanded by the direct object. In this account, animate experiencers, benefactive recipients and possessor datives would belong to high datives, whereas the datives with directional or locational semantics would correspond to the low ones.

⁶¹ Contrary to those adhering to the high vs. low dative distinction, Oyharçabal (2010) claims that Basque datives in ditransitive constructions correspond to Pylkkänen's (2008) low applicatives. Pylkkänen (2008: 18-33) distinguishes high and low applicatives by claiming that only the former are compatible with unergative, stative, and depictive secondary predicates. Unfortunately, Oyharçabal tests the possibility to combine datives with unergative and stative predicates, but does not look at the possibility to combine the different types of datives with depictive secondary predication. Oyharçabal (2010: 253) takes for granted that datives are not allowed to license secondary predication in Basque and says that it is impossible to apply the depictive test to determine whether Basque datives in ditransitive constructions are high or low datives.

3.5.2. The restriction requires a derivational analysis for PP-like datives

As mentioned at the beginning of this section, the fact that depictives are restricted to DP arguments gives rise to certain implications that affect the general analysis of Basque datives.

First, as predicted by the PP-like behavior of goal datives, in this section I show that depictives are excluded both with agreeing as well as non-agreeing goals. This confirms that the impossibility for goal datives to control secondary predication is definitely related to their PP-like character. For this reason, I propose that goal datives generate with a PP syntactic category. A PP source should thus be posited not only for those goal datives that under certain circumstances occur actually as PPs –i.e., without dative markers in the finite verb, but also for those that, although triggering dative markers, are able to appear without them. Otherwise, if only non-agreeing goals were originated as PPs, agreeing goals should be able to license secondary predication, as the licensing is blocked by the P head (Odria 2015).

Second, if depictives are in fact blocked by P and goals are generated as PPs, I propose that those datives that license secondary prediction and behave as DPs in triggering obligatorily dative markers generate with a DP syntactic category. Hence, while the restriction on the controller points to a unique PP-source for both agreeing and non-agreeing goals, a DP original category is required for the rest of DP datives that can in fact license secondary predication, that is, for causee, experiencer and possessors.

In what follows, I present additional arguments supporting a unique PP source for both agreeing and non-agreeing goals and argue that the difference with respect to agreement with the finite verb is straightforwardly captured by the derivational analysis pursued for Basque datives by Ormazabal & Romero (1998 2003 2010 2017) and Albizu (2001 2009), among others.

In Basque, all dative arguments trigger dative markers in the finite verbal form. However, leaving aside the behavior of the causee in northeastern Basque, only goals can appear as PPs, that is, without triggering dative markers in the finite verbal form. In

section 3.4, we have seen that a similar situation is found with respect to the possibility to license secondary predication too; along with PPs, only those datives that can appear without dative markers –i.e., goals– are unable to license secondary predication. This favors a syntactic analysis where a unique PP origin is in fact assigned to all PP-like goal datives.

The unique PP source for goal datives is further justified by the fact that, in northeastern Basque, depictives are excluded both when the goal appears as agreeing and non-agreeing. Consider, for instance, the examples in (48). In (48) we see that the goal of a ditransitive predicate like *eman* ‘give’ can either appear as a PP without agreeing with the finite verb (48a), or as a DP that agrees with the finite verb (48b). As expected by their identical original category, the depictive is unable to modify the goal in both of them.⁶²

- (48) a. (ni-k) Miren-i_i oparia kontent*_i eman diot
 I-E Miren-D gift.A happy give AUX[3sgA-3sgD-1sgE]
 ‘I have given Miren the gift happy.’
- b. (ni-k) Miren-i_i oparia kontent*_i eman dut
 I-E Miren-D gift.A happy give AUX[3sgA-1sgE]
 ‘I have given the gift to Miren happy.’

The examples in (48) demonstrate that in Basque, agreeing and non-agreeing goals pattern in the same way in not allowing depictive secondary predication. Considering that depictives are neither allowed with the rest of PPs, this implies that the agreeing dative in (48a) is syntactically derived from the non-agreeing one in (48b).

Baker (1997: 86-88) reaches to the same conclusion by analyzing the licensing of secondary predication in English ditransitive constructions. In English, secondary predication is ruled out both when the ditransitive predicate is built up as a Double Object Construction as in (49a) and when it is constructed as a Prepositional Construction as in (49b).

⁶² The word order in both (48a) and (48b) is ‘indirect object > direct object’. However, it is important to note that, in northeastern Basque, non-agreeing datives tend to be placed after the direct object, in a post-verbal position (Etxepare 2014, Ormazabal & Romero 2017).

- (49) a. *I gave the meat to Mary_i hungry_i
 b. *I gave Mary_i the meat hungry_i

Baker observes that in English, the only DPs that are excluded from licensing secondary predication are the indirect objects in Double Object Constructions like (49b). Assuming a structural approach of the restriction on the controller, this author claims that such a restriction can only be explained if DPs like *Mary* in (49b) are derived from PPs like *to Mary* in (49a). Otherwise, it would be unexpected for the predication possibilities in Double Object Constructions like (49b) to be identical to those in Prepositional Constructions like (49a). In order to account for this and other syntactic similarities between the goals in Double Object Constructions and in Prepositional Constructions, Baker assumes a P-incorporation derivational analysis for goals in Double Object Constructions. This author argues that DPs like *Mary* in (49b) are generated as PPs like *to Mary* in (49a), and that when the P head of the latter incorporates into V, the nominal moves outside the inner VP to receive structural accusative Case. Hence, even though the DP nominal in (49b) c-commands the depictive secondary predicate from its derived position, the depictive is still not c-commanded by the base PP position of the argument in (49b). As a result, Baker concludes that goals are unable to license secondary predication because they are never in the configuration it needs to be in order to control secondary predication.

Similar to the accusative object in English Double Object Constructions, Ortiz de Urbina & Fernández (2016: 81-82) notice that the single goal object of bivalent unergatives like *segitu* ‘follow’ is typically marked absolutive in northeastern Basque, and in spite of that, depictives are incompatible with them. This is an unexpected fact if secondary predication is exclusively unavailable with PPs or PP-like datives, as the goal object is marked absolutive in this case.⁶³ Notwithstanding, it is important to note that, as happens with the accusative goal in English Double Object Constructions, in Basque, the absolutive goal of bivalent unergatives is the only case where depictive predication

⁶³ Note that, being an absolutive object, this fact would also be unpredictable for the assumption that depictives are incompatible with dative but not absolutive objects (Zabala 1993 2003, Arregi & Molina-Azaola 2004, Oyharçabal 2010).

is rejected with an absolutive DP. Hence, in line with Baker (1997), I assume that be it absolutive like in northeastern Basque (50a) or dative like in southwestern Basque (50b), depictives are unavailable with the object of bivalent unergatives like *segitu* ‘follow’ because this is generated as a PP in both cases.

- (50) a. (ni-k) (zu) biluzi segitu zaitut
 I-E you.A naked follow AUX
 ‘I have followed you naked.’
- b. (ni-k) (zu-ri) biluzi segitu dizut
 I-E you-D naked followl AUX
 ‘I have followed you naked.’

As explained in chapter 2 (section 2.4.2), Fernández & Ortiz de Urbina (2012), Ortiz de Urbina & Fernández (2016) and Pineda (2016) put forth a low applicative analysis to explain the dative Case assignment of the single object of bivalent unergative predicates. Interestingly, although Fernández & Ortiz de Urbina (2012) and Ortiz de Urbina & Fernández (2016) apply the low applicative analysis exclusively to dative objects, Pineda (2016: 385-387) extends the same analysis to absolutive objects as well. Given that the object remains being a goal regardless of its case marking, Pineda argues that the same low applicative analysis is tenable with absolutive objects too. In particular, this author explains the difference in case marking by assuming that Appl is defective when the object bears absolutive marking.⁶⁴ On that assumption, it seems possible to postulate that the goal of bivalent unergatives like *segitu* ‘follo’ originates as a PP complement of V and moves to [Spec, ApplP] when P incorporates into V. Once in that position, Appl assigns inherent dative Case to it under normal circumstances. However, when Appl is defective in its features, the goal receives absolutive rather than dative Case. This would explain the fact that, although absolutive, the goal object in (50b) rejects depictive modification because the apparently DP nominal is in fact generated as a PP. Therefore, the PP source would not only capture for the impossibility to license secondary predication in sentences like (50a), but also in those like (50b). Otherwise, if sentences like (50b) were analyzed as classical transitives (Fernández &

⁶⁴ See also Sáez (2009: 68) for a similar analysis for accusative objects in bivalent unergatives like *ayudar* ‘help’ in Spanish

Ortiz de Urbina 2012, Ortiz de Urbina & Fernández 2016), the impossibility to combine the secondary predicate with the absolutive object would remain surprising.

The PP source for goal datives is additionally supported by the cross-linguistic similarity that (goal) datives show with PPs when licensing secondary predication. Although the restriction on the controller is not universally persistent, Ormazabal & Romero (2010: 218-219) point out that, in general, datives behave with PPs with regards to the licensing of secondary predication. These authors emphasize that, generally speaking, languages that allow secondary predication with certain PPs, also allow it with the applied or dative argument. In Slovenian, for instance, PPs are able to control secondary predication, and (goal) datives license secondary predication too (Marušič, Marvin & Žauker 2003 2004). Along with Slovenian, (goal) datives and/or PPs are also possible controllers of secondary predication in Warlpiri (Simpson 2005: 96), and Icelandic (Maling 2001: 421, 457, Sigurdson 2002: 709-710). Based on these and other facts, Ormazabal & Romero pursue a derivational analysis of dative arguments and, in line with Baker (1997), claim that dative DPs are derived from a base generated PP.

Taking all these facts into account, it seems reasonable to argue that in Basque PP-like goal datives are in fact generated as PPs. By attributing a single origin for both agreeing and non-agreeing goals, we straightforwardly capture the identical predication possibilities exhibited by both of them. This asks for a derivational analysis for the goals that trigger dative markers in the finite verbal form, as in spite of their PP origin, behave as the rest of DPs in agreeing with the finite verbal form.

As in many other languages, two main approaches have been presented to account for the dual DP or agreeing vs. PP or non-agreeing behavior of dative arguments in Basque. These are the derivational analysis and the base-generated one.

The base-generated analysis assumes that the PP-like dative agreeing with the finite verb is not derived from a non-agreeing PP. Agreeing PP-like datives are considered to be low datives that coexist along with dative PPs that do not agree with the finite verbal form. This is the view adopted by Etxepare & Oyharçabal (2013) and Etxepare (2014), among others. However, if agreeing and non-agreeing goal datives were independent

from each other, the identical predication possibilities found in both of them would be purely coincidental, and it would be difficult to maintain the structural hypothesis of the restriction on the controller. In order to account for the fact that both agreeing and non-agreeing goals disallow depictive secondary predication, I argue that the same first merge syntactic category should be shared by both of them at the level of argument structure.

This is, in fact, the main point in the derivational analysis put forth by Ormazabal & Romero (1998 2010 2017) and Albizu (2001 2009), among others.⁶⁵ The derivational approach claims that dative arguments are generated as PP complements of V. Following Baker (1988), it assumes that the difference between agreeing and non-agreeing datives comes from the incorporation of the P head. Broadly speaking, if the P head incorporates into V, the nominal moves outside VP and it ends up establishing an Agree relation with *v*, triggering dative markers in the finite verbal form. On the contrary, if the P head does not incorporate into V, the nominal remains as a PP complement of V, no Agree relation is maintained with *v*, and consequently, no dative markers are shown by the finite verbal form. According to the most recent version of the derivational analysis (Ormazabal & Romero 2017), in this case the nominal within the PP would receive dative Case from P.⁶⁶ Thus, agreeing and non-agreeing datives maintain a unified category and configuration at the level of argument structure, and the structural and Case differences derive from P-incorporation. Once incorporated, P ceases to assign Case to its complement and the complex verbal head targets the complement of P –which is already a DP– to a higher position.

⁶⁵ See also Ormazabal (2000), Albizu & Fernández (2006), Arregi (2003) and Arregi & Ormazabal (2003) for derivational analyses of Basque datives.

⁶⁶ In this regard, Ormazabal & Romero (2017) depart from more classical versions of the derivational analysis, where the dative case marker in non-agreeing goals was supposed to correspond to the P head itself. Following Etxepare & Oyharçabal (2013) and Etxepare (2014), Ormazabal & Romero (2017) assume that the *-(r)i* dative case in non-agreeing datives is the reflex of the Case assigned by the P head. In line with Rezac (2011), the same assumption is made in chapter 4 concerning non-agreeing datives in PCC-affected contexts and ditransitive causative constructions.

Summing up, the gist of the derivational analysis is that agreeing and non-agreeing datives are syntactically introduced in the same structural position and, what is important for the purposes of the discussion, with the same syntactic category. In this approach, the different agreeing patterns arise as a result of P-incorporation.

The derivational approach accounts straightforwardly for the identical predication possibilities attested in PPs and agreeing as well as non-agreeing goal datives. Both agreeing and non-agreeing goals generate as PP complements of V and, as I will further argue in chapter 4, when the P head incorporates into V, the verbal complex attracts the already DP goal to [Spec, ApplP], the position where Appl assigns inherent dative Case to it. Once in [Spec, ApplP], the goal dative enters into an Agree relation with *v*, leading thereby to dative markers in the finite verbal form.⁶⁷ On the contrary, if P does not incorporate into V, the goal remains in its base position and P assigns dative Case to it. The derivation I assume for goal datives is depicted in the syntactic trees in (51) and (52). The tree in (51) shows the scenario of non-agreeing goals attested in examples like (48b) in northeastern Basque, while represents the derivation of agreeing goals found in sentences like (48a) in all varieties of Basque.

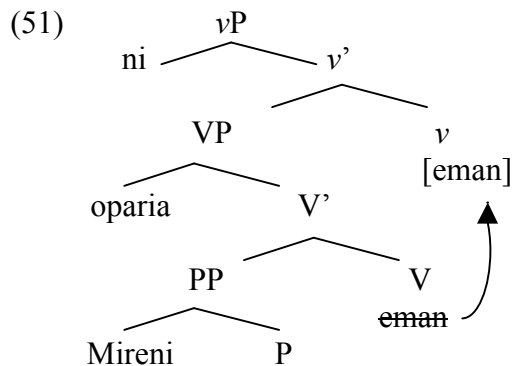

⁶⁷ Following Anagnostopoulou (2003), Béjar & Rezac (2003) Béjar & Rezac (2003) and Rezac (2007 2008ab 2009ab 2011), in chapter 4 I argue that the Agree relation held by inherent datives in [Spec, ApplP] is defective in nature.

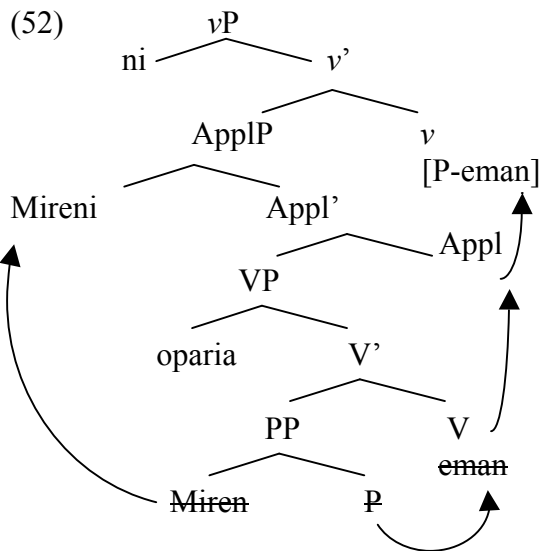

Crucially, the derivational analysis should only be applied to goal datives, and not to all datives. Otherwise, if, as argued by more classical derivational approaches, all kind of agreeing datives were derived from a PP, secondary predication would be incompatible with all of them. In line with the base-generated approach, in chapter 4, I argue that those datives that behave always as DPs are in fact generated in [Spec, ApplP], in the position where goals move in order to be Case licensed.⁶⁸

⁶⁸ In Ormazabal & Romero (2017), the high position reached by goal datives after P-incorporation is argued to be [Spec, vP/AgrOP]. However, in order to capture the unique behavior shown by all kind of agreeing datives when triggering the PCC, in chapter 4 I argue that such position should instead be [Spec, ApplP], the position where all agreeing datives –except for DOM objects– receive inherent Case from Appl. Ormazabal & Romero (2017) claim that both in agreeing and non-agreeing cases, dative Case is always assigned by P in the base position of the dative. These authors take case and agreement to be independent phenomena, and state that the structurally higher –i.e., derived– position is just responsible for agreement. Notwithstanding, note that this requires an additional dative Case assignment mechanism for DP datives, since Ormazabal & Romero (2017) also admit that experiencers and possessors are not derived from a PP complement of V. Hence, in absence of P, the Case assignment in these datives would remain unexplained in their approach. As a consequence, in line with Rezac (2011), I conclude that P should only assign dative Case to non-agreeing goals, providing this way a uniform Case assignment mechanism for all kind of agreeing datives, regardless of their first merge position. On the other hand, another difference between Ormazabal & Romero (2017) –but not Ormazabal & Romero (2010)– and the view taken in this dissertation is that, in the present account, only the goal is generated within the PP. According to Ormazabal & Romero (2017), the PP contains both the goal and the theme argument.

Hence, I conclude that the derivational analysis is only suitable for those datives showing a PP-like behavior, that is, for goal datives that, under certain circumstances, can occur without agreeing with the finite verb. Likewise, I claim that a base-generated approach should be assumed in order to explain the behavior of those datives that allow depictive secondary predication and behave always as DPs, that is, for causee, experiencer and possessor datives. Contrary to PP-like datives, I claim that these are generated as DPs in [Spec, ApplP] and receive inherent Case from Appl.⁶⁹

Moreover, assuming a derivational analysis for PP-like datives and a base-generated one for DP datives indicates that the licensing of secondary predication takes place at the level of argument structure. It is at first merge where all agreeing and non-agreeing goal datives share the same PP syntactic category. Once the derivation proceeds, agreeing goals show the same DP category as causee, experiencer and possessor datives; all of them bear dative marking both in the nominal and in the finite verbal form. Therefore, the licensing of depictive secondary predication should exclusively be aware of the first merge syntactic category of the nominal. If the nominal is generated as a DP, it will be able to control secondary predication. Conversely, if the nominal has a PP origin, it will not be able to do so. Otherwise, if secondary predication was licensed at a later stage of the derivation, the identical behavior displayed by all PPs and PP-like datives would be unexpected –and, regarding the results in section 3.3, different predication possibilities should be attested between unmarked and marked word order.

To sum up, apart from providing a novel diagnostic to distinguish DP and PP-like datives, I contend that depictive secondary predication brings relevant consequences with regards to the origin as well as derivation of Basque datives. On the one hand, it

However, being generated within a PP, in that case the theme would equally be prevented from licensing secondary predication, contrary to facts.

⁶⁹ Recall that, although DOM objects are categorically DPs too, these are generated as complements of V, as they bear the same argumental as well as thematic relationship as canonical absolutes. Besides, as has been recently pointed out by Ormazabal & Romero (2017), causee, experiencer and possessors could also be derived from other non-PP positions. Being generated as DPs, this would equally account for the possibility to license depictive secondary predication.

requires a base-generated analysis for those DPs that are able to license depictive secondary predication and a derivational one for those that are not able to do so.⁷⁰ On the other hand, it implies that the restriction on the controller arises at the first step of the syntactic derivation, once the lexical items are syntactically introduced at the level of argument structure.⁷¹

3.5.3. The restriction supports a Complex Predicate approach to depictive secondary predication

Proposing a new analysis for the syntax of Basque secondary predication is outside the scope of this dissertation. This chapter has focused on the restriction on the controller of secondary predication in order to gain a deeper understanding of the original syntactic category of DOM objects and the rest of the dative arguments. Nevertheless, at this point, it seems worthy to close the discussion on secondary predication by claiming that the Basque data may fit well with recent Complex Predicate analyses of secondary predication –recall from section 3.2 that two main theories prevail in the analysis of secondary predication, that is, the Small Clause theory and the Complex Predicate theory.

As noted by Pylkkänen (2008: 27), the control analysis assuming that the secondary predicate constitutes a Small Clause with its subject is problematic regarding the restriction on the controller. Although indirect objects are actually possible controllers in control constructions (53a), depictives are not allowed to modify them (53b).

- (53) a. I wrote him_i a letter to PRO_i show his mother.
b. I_i told him_j the news drunk_{i/*j}.

⁷⁰ See Ormazabal & Romero (2010 2017) for further argumentations in favour of a derivational analysis of (goal) datives in ditransitive constructions.

⁷¹ Concerning bivalent unaccusatives, Albizu (2009) also provides a base-generated analysis for experiencers and a derivational one for goals. Notwithstanding, contrary to the present account, this author extends the derivational analysis to possessor datives as well.

As a consequence, Pylkkänen (2008) assumes a Complex Predicate analysis of depictive secondary predication and explains the restriction on the controller in semantic terms.⁷²

Many of the recent studies on secondary predication have pursued a Complex Predicate analysis of secondary predication. Similarly to Pylkkänen (2008), a Complex Predicate hypothesis is also assumed by Rothstein (2000). Rothstein contends that secondary predicates are aspectual modifiers in the sense that they introduce a new event that is in turn related to the event described by the main predicate. This author analyzes secondary predication as a result of an operation that sums the denotation of the matrix verb with the secondary predicate. Such a summing relation requires the two events to share the same running time as well as a thematic participant. The event introduced by the matrix verb must be PART-OF –i.e., co-temporal to– the event introduced by depictive secondary predicates.

The details of each analysis assuming a Complex Predicate approach to secondary predication are not relevant in this chapter. What is important for us is that under a Complex Predicate analysis, the controller of the secondary predication is never originated in the complement position of V, but rather above the complex predicate formed by the main and the secondary predicate –see, among many others, Pylkkänen (2008) and Irimia (2012). This is a crucial point in order to understand the updated restriction on the controller, because the derivational account of PP-like datives assumes that these are generated as PP complements of V.

Let us take as an example, Irimia's (2012) Complex Predicate analysis on secondary predication. In a few words, Irimia claims that secondary predication is the result of a simultaneous Multiple Agree involving the controller as well as the primary and secondary predicates. The probe of such Multiple Agree relation is the functional head

⁷² Pylkkänen (2002: 26-31) claims that depictives are incompatible with low applicative indirect objects because the Depictive Phrase has to attach to Appl', and Appl' is too complex a predicate for the Depictive Phrase to modify. Pylkkänen explains that depictives are of the type <e,<st>> and that they are only able to combine with elements that are of type <e<st>>: transitive V when it modifies the internal argument and Voice' when it modifies the external argument. However, low applicatives cannot combine with depictive secondary predicates, because in this case the depictive would have to attach to Appl' and Appl' is of type <<e, st>, <st>>>.

v_{RESTRUCT} , and the two predicates behave as goals. v_{RESTRUCT} bears v -complex features that allow it to check the predicative features of more than one predicate. Such features become active when v_{RESTRUCT} establishes a matching relation with the controller of the secondary predicate. Hence, once identifying the controller argument, Agree applies to all matched goals at the same derivational point derivationally simultaneously. Now, coming back to our main concern, if Basque PP-like datives are generated as PPs and PPs cannot directly Agree with a functional head, v_{RESTRUCT} will never be able to identify the argument needed to activate its v -complex features. As a consequence, the v_{RESTRUCT} head will not find a proper probe to Agree with, and no Multiple Agree process will emerge with the primary and secondary predicates.

Moreover, since in the Complex Predicate analysis the controller is generated above VP, the P head of PP-like datives will not be able to incorporate into V as expected in the derivational analysis presented in section 3.5.2, where goals are generated as complements of V. Therefore, the nominal inside the PP will neither be able to Agree with v_{RESTRUCT} from a higher structural position, and depictive secondary predication will be incompatible with it. This is not the case of the rest of DP arguments, which are able to Agree with v_{RESTRUCT} from their original position. As a consequence, depictive secondary predication is allowed in all of them. Crucially, the fact that the controller argument is introduced higher than VP is not exclusive to Irimia's theory. PP-like datives would face the same challenge with the rest of analyses that take secondary predication to involve Complex Predicate formation.

In this sense, it is important to highlight that the combination of a derivational approach to PP-like datives with a Complex Predicate analysis of depictive secondary predication captures the main insight of previous structural analyses of secondary predication. In the Government & Binding framework, the structural analyses of depictive secondary predication argued that the predicate and its subject should c-command each other in order to license predication (Williams 1980, Rothstein 1983). Such a c-command relation was blocked when the possible controller was covered within a PP; the P head prevented the nominal from c-commanding the predicate and predication was not licensed in those cases (Demonte 1987 1988, Zabala 1993, Koizumi 1994). Similarly, in a Minimalist Complex Predicate account that licenses secondary predication based on

Multiple Agree (Irimia 2012), a structural relation is required between the nominal and the predicate in order to license secondary predication. In this case, the structural relation is defined in terms of Multiple Agree instead of c-command. In spite of that, be it realized by means of Multiple Agree or mutual c-command, the restriction on the controller is accounted for structurally; it is the P head which blocks the required structural relation in both approaches.

3.6. CONCLUSION AND INTERIM SUMMARY

In this chapter, I have examined the licensing of depictive secondary predication in order to determine the original syntactic category of DOM objects, as in Basque dative arguments show a dual DP vs. PP-like behavior. In contrast to the standard assumption claiming that depictives are excluded with PPs and all kind of dative indirect objects (Zabala 1993 2003, Arregi & Molina-Azaola 2004, Oyharçabal 2010), I have proved that secondary predication is only incompatible with PPs as well as PP-like goal datives. I demonstrate that depictive secondary predication distinguishes between DP and PP(-like) arguments, as DP datives like causee (Zabala 1993 2003), experiencer and possessors are in fact able to control it (Odría 2015) Along with Basque, I have shown that the same situation is found in Spanish as well (Demonte 1988 1988, Hernanz 1988, Demonte & Masullo 1999, Fernández-Soriano 1999).

Taking this into account, I have argued that the possibility for DOM objects to license secondary predication indicates that these datives are DPs categorically. Thus, considering the argumental and thematic identity to absolutive objects, I have concluded that DOM objects enter the derivation as DPs, in the complement position of V. Together with DOM objects, the dative objects of bivalent unergative predicates have also been analyzed in this chapter. These behave like the rest of PP-like goal datives in not being able to control secondary predication both in Basque (Fernández & Ortiz de Urbina 2009, Fernández & Rezac 2010 2016, Odría 2012 2014, Ortiz de Urbina & Fernández 2016) and Spanish.

In addition, the chapter has discussed certain implications that arise once we acknowledge that depictives are available with DP but not PP-like datives. On the one hand, I have stated that the restriction on the controller should be accounted for structurally, as depictives are exclusively aware of the categorical DP vs. PP nature of the controller. Therefore, considering that depictives are rejected both with agreeing and non-agreeing goal datives, I have put forth that, contrary to DP datives, PP-like goals enter the derivation as PPs, as the structural relation between the controller and the predicate is blocked by the presence of the P head. The unique PP origin shared by all agreeing and non-agreeing goal datives has led us to pursue a derivational account for those datives that, even showing a PP-like behavior, appear with dative markers in the finite verb (Ormazabal & Romero 1998 2010 2017, Albizu 2001 2009). Besides, I have claimed that the restriction on the controller argues in favor of a mixed analysis of Basque dative arguments, taking those DP datives to be base generated as DPs. Finally, the chapter has been closed by pointing out that the mixed analysis of Basque datives fits well with recent Complex Predicate analyses of secondary predication, as these are able to capture the fact that originally PP arguments are unable to license secondary predication.

4. THE PCC, DATIVES AND ν -AGREE IN DOM OBJECTS

4.1. INTRODUCTION

In chapter 1, I have assumed that DOM objects are first merged in syntax as complements of V, as they display the same argumental as well as thematic relationship as absolutive objects. Besides, based on the licensing of secondary predication, in chapter 3 I have put forth that DOM objects are originated with a DP syntactic category. In this chapter, I make a further step in the analysis of the syntactic nature of these non-canonical objects and argue that they are Case licensed by entering into an Agree relation with the ν head (Odria 2012 2014, Fernández & Rezac 2016).

By justifying the ν -Agree relation held by DOM objects, this chapter provides additional predictions regarding the behavior of causee, experiencer, goal and possessor datives. Concerning the licensing of depictive secondary predication, in chapter 3, I have posited two different external merge configurations for goals on the one hand, and for causee, experiencer and possessors on the other. PP-like goals are generated as PPs in the complement position of V, while DP datives like causee, experiencer and possessors enter the derivation as DPs in [Spec, ApplP] –i.e., in the position where all agreeing datives are Case licensed by Appl. Developing the Case licensing mechanism in agreeing datives, in this chapter I claim that apart from receiving inherent Case from Appl, agreeing datives enter into a defective [person] Agree relation with ν , which enables subsequent clitic doubling leading to dative markers in the finite verbal form (Rezac 2008a 2011).

With the aim at accounting for the Case licensing process carried out by DOM objects in particular and dative arguments in general, the present chapter deals with the *Person Case Constraint* (PCC) –also known as the *Me-Lui Constraint* (Perlmutter 1971, Bonet 1991 1994). The PCC refers to the incompatibility for first and second person objects to occur along with an agreeing dative. The constraint is syntactic in nature and arises in

the vP domain, when an inherent dative in [Spec, ApplP] c-commands a first or second person object and both of them are required to Agree with the same v head. Adhering to the Agree/Case approach of the constraint, in this chapter I argue that the PCC arises as a result of a failure of Case licensing on first and second person objects (Anagnostopoulou 2003, Béjar & Rezac 2003, Rezac 2007 2008ab 2009ab 2011).

In the spirit of Rezac (2011), I assume that when the PCC is caused by a goal dative, a phi-probe can be added to its originally defective P head in order to repair the effects of the constraint. This turns the non-phasal P head into a phasal head with its own active Agree/Case locus. As a consequence, no P-incorporation takes place, the goal stays in its base position by Agreeing with the phi-probe in P, and v Agrees entirely with the first or second person object. This leads to a construction where the agreement complex cross-references the first or second person object and the goal is realized as a non-agreeing PP dative (Albizu 1997a 2001 2009, Artiagoitia 2000, Etxepare & Oyharçabal 2008a, Rezac 2009b 2011, Fernández & Rezac 2010 2016, Oyharçabal & Etxepare 2012, Odria 2014). As expected by their DP categorical source, I corroborate that the PP repair strategy is generally untenable for causee, experiencer and possessor datives (Albizu 1997a 2001, Rezac 2009b 2011). Being generated as DPs, these datives bear no Agree/Case locus that can be activated by adding uninterpretable phi-features, and consequently, PCC effects remain unavoidable. This reinforces the different categorical as well as configurational origins put forth for DP and PP-like datives in chapter 3, as the constraint is only repairable when the dative is of the PP-like type.

Having established the syntactic processes lying behind the effects as well as repairs of the PCC, in this chapter I analyze how the constraint interacts with DOM objects. I demonstrate that first and second person DOM objects are targeted by the PCC in the same way as canonical absolutes, either when combining with a PP-like (Fernández & Rezac 2010 2016, Odria 2014) or a DP dative. Hence, assuming that the PCC is a constraint that arises when the two internal arguments in the vP domain are intended to Agree with v , I conclude that DOM objects Agree with the v head too.

When PCC effects are triggered by a goal, some DOM speakers are able to repair the constraint by adding a phi-probe to the defective P head of the goal, providing this way a separate Agree/Case locus for each of the internal arguments: P for the goal and v for

the DOM object. As a consequence, the resulting finite verbal form agrees only with the DOM object and the goal is left as a non-agreeing PP dative, leading thereby to a double dative construction (Fernández & Rezac 2010 2016, Odria 2014). Due to their DP syntactic category, I show that, generally speaking, the repair strategy adding uninterpretable phi-features is not feasible for DOM objects, as only the goal can be realized as a full PP. This is straightforwardly explained by the fact that, contrary to goals, DOM objects do not generate with a P head to which uninterpretable phi-features can be added. As we will see, the PP repair strategy is not available for all speakers and verbs, and other PCC repairs are also attested when the constraint is triggered by a goal dative. Besides, when the PCC targets first or second person objects combined with DP datives like causee, experiencer and possessors, the constraint is generally irreparable for DOM speakers, as being originally DPs, none of the datives is able to occur as a non-agreeing PP.

Departing from the double dative construction formed by a DOM and a goal dative, in this chapter I additionally analyze other combinations of different kind of datives. Reinforcing the separate categorial source for causee and goal datives, I show that in ditransitive causative constructions combining a goal and a causee dative, only the goal can occur as a non-agreeing PP (Deustuko Hizkuntzalaritza Mintegia 1989, Albizu 2001, Ortiz de Urbina 2003a, Duguine 2013, Odria 2014). As happens with DOM objects, causees are DPs originally, and thus, are unable to resort to the PP repair strategy. The possibility to have double dative constructions involving a causee and a goal dative leads us to two main conclusions. On the one hand, it means that, apart from PCC contexts, the PP repair strategy is independently available in ditransitive causative constructions where [Spec, AppP] is already filled by a DP dative. On the other hand, in addition to the categorial distinction, it proves that DP and PP-like datives should also be generated in a different syntactic position in order to account for the existence of double dative constructions.

Finally, and building on Rezac (2008a 2011), the last part of the chapter develops a clitic doubling analysis for the dative markers in the finite verbal form. Assuming that inherent datives Agree defectively with v , I claim that, before adjoining to v , the clitic coding these arguments moves to [Spec, v P] –as has been proposed, among others, by

Matushansky (2006), Nevins (2011), Harizanov (2014) and Kramer (2014). The movement of the clitic head to [Spec, ν P] is justified by two main pieces of evidence: (i) the intervention of the agreeing dative in restructuring unaccusative modal constructions (Albizu 2001, Albizu & Fernández 2002 2006, Ortiz de Urbina 2003b, Goenaga 2006, Rezac et al. 2014), and (ii) the intervention of the pro_{arb} causee in impersonal causative constructions (Albizu 2001, Ortiz de Urbina 2003a).

The chapter is structured as follows. In section 4.2, I present the basic background of the PCC. Section 4.3 reviews different pieces of evidence that have been given by Albizu (1997ab), Ormazabal & Romero (1998 2001 2003 2007), Ormazabal (2000) and Rezac (2008b) in favor of a syntactic approach of the PCC. I point out that the PCC is a constraint that arises when an inherent dative in [Spec, ApplP] c-commands a first or second person object and both of them are intended to Agree with the same ν head. The Agree/Case syntactic approach of the PCC is defined in section 4.4. Such an approach states that, due to the defective intervention of the inherent dative, PCC effects arise as a consequence of a failure of Case licensing on first and second person objects (Anagnostopoulou 2003, Béjar & Rezac 2003, Rezac 2007 2008ab 2009ab 2011). Section 4.5 analyzes the repair strategy that consists of turning the agreeing non-phasal dative into a non-agreeing phasal PP (Rezac 2011). In section 4.6, I explore the behavior of first and second person DOM objects with regards to the PCC and conclude that DOM objects Agree with the ν head, as the constraint affects their Case licensing in the same way as it does with canonical absolutes (Odría 2012 2014, Fernández & Rezac 2010 2016). In this section, I additionally show that, with verbs like *saldu* ‘sell’, the goal is able to repair the constraint by the PP repair strategy, leading thereby to a double dative construction formed by the goal and the DOM object. The section also deepens on the nature of double dative constructions that arise in ditransitive causative constructions. I show that, as happens in PCC-affected contexts, the combination of a causee and a goal allow only the goal to occur as a non-agreeing PP. Ultimately, having established the Case licensing mechanism in both inherent and DOM datives, section 4.7 lays out a clitic doubling analysis of the dative markers in the finite verbal form. To finish, section 4.8 closes the chapter by summing up its main conclusion.

4.2. PRELIMINARIES

The PCC refers to the incompatibility for first and second person objects to occur with an agreeing dative, a constraint that was first observed by Perlmutter (1971) and formalized by Bonet (1994: 36) as follows in (1).

(1) Person-Case Constraint: If DAT, then ACC/ABS = 3rd

The PCC states that dative agreement/clitics ban first and second person object's agreement/clitics. Although not universal, Albizu (1997ab) shows that the constraint is present in a heterogeneous group of languages, including Basque. As observed by Laka (1993: 27), in Basque, inflected forms agreeing with all ergative, dative and absolutive arguments can only cross-reference third person absolutive arguments. This is illustrated by Laka with the contrast in (2). Contrary to the well-formed sentence in (2a) –where the object is third person– the object in (2b) is first person. Thus, in (2b), along with the ergative and dative arguments, the finite verbal form agrees with the first person absolutive object, and this leads to a deviant result (Laka 1993: 27).

- (2) a. Zu-k ni-ri liburua saldu didazu
 you-E I-D book.A sell AUX[3sgA-1sgD-2sgE]
 'You have sold me the book.'
- b. *Zu-k harakina-ri ni saldu naiozu
 you-E butcher-D I.A sell AUX[1sgA-3sgD-2sgE]
 'You have sold me to the butcher.'

Laka (1993: 27) notes that the constraint attested in finite sentences like (2b) disappears in non-finite contexts involving the same ergative, dative and first person absolutive arguments –see also Albizu (1997a: 60 1997b: 5). Consider now the example in (3).

- (3) Gaizki iruditzen zait [zu-k ni harakina-ri saltzea]
 wrong seeming AUX[3SA-1SD] [you-E me.A butcher-D selling]
 'Your selling me to the butcher seems wrong to me.'

The example in (3) stands in contrast to (2b). The same phi-feature combination is displayed in both of them –second person ergative, third person dative and first person absolutive. Yet, such a combination is only allowed in the non-inflected context (3).

As in the rest of languages affected by the constraint, in Basque, PCC effects arise when the object is second person too. Hence, for the sake of completeness, it is worth mentioning that if the absolutive object in Laka's (2b) example were second person, the sentence would equally be ungrammatical, as in (4a). Likewise, the same sentence with a second person object would become grammatical in a non-finite context like (4b).

- (4) a. *Ni-k harakina-ri zu saldu zaitiot
 I-E butcher-D you.A sell AUX[2sgA-3sgD-1sgE]
 'I have sold you to the butcher.'
- b. Jon-I gaizki iruditu zaio [ni-k zu harakina-ri saltzea]
 Jon-D wrong seeming AUX[3sgA-3sgD] [I-E you.A butcher-D selling]
 'My selling you to the butcher seems wrong to Jon.'

The fact that in Basque the PCC targets inflected configurations but not non-inflected ones has been considered to be a relevant piece of evidence in favor of a morphological analysis of the constraint –see, among many others, Bonet (1991 1994) and Bobaljik (2008). Under this approach, the incompatibility for first and second person objects to co-occur with a dative argument derives from the combination of their corresponding morphological markers in the finite verbal form, as the constraint is not attested in non-finite forms lacking clitic/agreement markers.⁷³

Nevertheless, the possibility to address the PCC in purely morphological terms has been brought into question by many authors, as the constraint has been proved to be affected by syntax –see, among others, Albizu (1997ab), Ormazabal & Romero (1998 2001 2003 2007), Anagnostopoulou (2003), Béjar & Rezac (2003), Adger & Harbour (2007), Rezac (2007 2008ab 2009ab 2011) and Preminger (2014). Some of these authors have still kept the constraint in morphology and have analyzed it in a syntactic model of Inflectional Morphology, including syntactic notions like *locality domains* and *c-command*. This is the approach pursued by Albizu (1997ab). Based on some of the facts that will be described in section 4.3, others have rather claimed that the constraint takes place in narrow syntax. For them, the lack of PCC in non-inflected forms does not necessarily imply that the restriction holds in morphology. Instead, those who approach

⁷³ In particular, Bonet (1991) argues that the constraint targets combinations of specific heads associated to Infl by S-structure.

the PCC from a syntactic point of view argue that the absence of PCC effects in non-finite contexts follows from the lack of syntactic Agree relations involved in inflected ones.

In order to support that DOM objects Agree with the v head, in this chapter I analyze the PCC following the Agree/Case (Rezac 2008b 2011) syntactic approach lead by Anagnostopoulou (2003), Béjar & Rezac (2003) and Rezac (2007 2008ab 2009ab 2011). The Agree/Case approach maintains that the PCC arises when both the direct and indirect object are intended to Agree with the phi-probe in v , as the indirect object – which is closer to it– intervenes in the [person] v -Agree relation of first and second person objects. Such an approach straightforwardly explains that if DOM objects are affected by the constraint, these objects should also be required to Agree with the v head.

Before presenting the main insight of the Agree/Case approach, I will first of all discuss some of the arguments that have been given in the literature in favor of analyzing the PCC on syntactic grounds, linked to the Agree/Case locus in v .

4.3. IN FAVOR OF A SYNTACTIC ANALYSIS OF THE PCC

In what follows, five pieces of evidence will be reviewed in order to justify the syntactic Agree/Case approach of the PCC: the lack of PCC effects (i) in non-finite contexts in Basque (section 4.3.1), (ii) in non-argumental dative-like markers in Basque and Romance (section 4.3.2), (iii) in bivalent unaccusatives with PP-like datives c-commanded by the absolutive in Basque (section 4.3.3) and (iv) in external arguments in general (section 4.3.4). Besides, in this section I also mention that the syntactic analysis of the PCC is supported by the presence of PCC effects (v) in the dative clitic *le* in the *leísta* varieties of Spanish (section 4.3.5) as well as (vi) in agreement-less contexts in Haitian Creole (section 4.3.6). The first four pieces of data have already been addressed by Albizu (1997ab) and highlighted, among others, by Rezac (2008b). The fifth one has been frequently pointed out by Ormazabal (2000) and Ormazabal &

Romero (1998 2001 2003), and the sixth one is discussed both in Albizu (1997ab) and Ormazabal & Romero (2007).

4.3.1. Lack of PCC in non-finite contexts in Basque

In section 4.2, I have pointed out that in Basque no PCC effects arise in non-finite contexts –see examples (2), (3) and (4). This could at first glance imply that the constraint is morphological in nature. However, as noted by Rezac (2008b: 67), the absence of PCC effects in non-finite contexts does not necessarily call for a morphological explanation that locates the ungrammaticality in the clitic/agreement marker combination itself. Instead, the problematic aspect with finite contexts could be the syntactic process involved by the clitic/agreement markers, and not just their morphological clustering. Making Rezac’s claim more explicit, if clitic/agreement markers arise as a consequence of an Agree relation with a functional head, the lack of PCC effects in non-finite contexts could simply be the result of the lack of such a functional head including an Agree/Case locus.

4.3.2. Lack of PCC in non-argumental dative-like markers

The fact that the PCC is not a morphological constraint has also been justified by the possibility to combine dative-like and absolutive markers in the finite verbal form when the dative-like marker does not cross-reference an argument of V. This is what happens with Basque allocutives as well as Romance ethical datives.

Basque has allocutive markers that refer to the addressee in the discourse (Oyharçabal 1993). These markers are morphologically identical to the ones referring the dative. As shown by Albizu (1997a: 101 1997b: 7), dative-like allocutive markers that refer to the addressee in the discourse do not cause PCC effects when combining with a first or second person object. Compare the neutral (5a) and allocutive (5b) sentences provided by Albizu (1997a: 101 1997b: 7).

- (5) a. Peru-k ni kale-an ikusi nau
 Peru-E LA street-INE see AUX[1sgA-3sgE]
 ‘Peru has seen me in the street.’

b. Peru-k ni kale-an ikusi naik
 Peru-E I.A street-INE see AUX[1sgA-2sgD/ALLO-3sgE]
 ‘Peru has seen me in the street (male addressee).’

Peru and *ni* are the only arguments of the verb *ikusi* ‘see’ in both (5a) and (5b): the absolutive *ni* is cross-referenced by the finite verbal form by means of *n-*, and being third person singular, the ergative *Peru* does not show any markers. The only difference between (5a) and (5b) is that the latter displays an additional dative-like marker in the finite verbal form, a marker that refers to the allocutive (*-k*). Crucially, despite bearing both first person absolutive (*n-*) and dative-like (*-k*) markers, nothing is wrong with the example in (5b), which would be unexpected if PCC effects arose as a consequence of a morphological restriction.

By the same token, Romance ethical datives are also compatible with first and second person objects –see among others, Perlmutter (1971), Bonet (1991 1994), Laka (1993) and Albizu (1997ab). As Basque allocutives, ethical datives refer to discourse participants that are affected by the event described by the verb, but are not included in the argument structure of the verb. Consider now the Catalan examples in (6), where the ethical dative is able to occur with first and second person object clitics without triggering PCC effects (Bonet 1991: 179).

(6) a. Me li van dir que havia suspès l’examen
 2sgD 3sgD said that had failed the exam
 They told him (on me) that he had failed the exam.’

b. Te li vas declarar?
 2sgD 3sgD declared
 ‘*Did you declare your love to him/her?*’

Therefore, as shown by the allocutive marker in (5b) and the ethical datives in (6), the PCC cannot be due to the pairing of first or second person absolutive/accusative and dative clitic/agreement markers. Conversely, if the PCC is accounted for in syntactic terms, the data in (5b) and (6) should no longer be surprising at all. Albizu (1997b: 22, 24) points out that given the discursive character of both allocutive and ethical datives, it is reasonable to assume that the two occupy a very high position in the syntactic structure. In Basque, although the exact syntactic position of allocutives is still under debate (Oyharçabal 1993, Haddican 2015, Torrego & Fernández in prep.), their non-

argumental nature makes it clear that these should be placed at least outside the domain of the ν Agree/Case locus. As a result, if, as argued by the syntactic approach, the PCC is linked to the ν head, allocutives and ethical datives should not intervene in the ν -Agree relation of the object, and thus, should not trigger PCC effects –see also Ormazabal & Romero (2007: 331).

4.3.3. Lack of PCC in bivalent unaccusatives with PP-like datives

A morphological approach to the PCC would also be problematic regarding another fact mentioned first by Albizu (1997a: 85-86, 100-101; 1997b: 9-10) and emphasized subsequently by Rezac (2008b: 67-68). In Basque, no PCC effects arise in bivalent unaccusatives with PP-like goals when both arguments are cross-referenced by the finite verbal form. This is illustrated in the example provided by Albizu (1997a: 86) in (7).

- (7) Ni Peru-ri hurbildu natzaio
 I.A Peru-D approach AUX[1sgA-3sgD]
 ‘I have approached Peru.’

The finite verbal form in (7) bears both absolutive (*n-*) and dative (*-o-*) markers and the sentence is grammatical in Basque. Crucially, the well-formed example in (7) stands in contrast to that in (8) (Albizu 1997b: 9), where the very same finite verb combining a first person object with an experiencer DP dative yields a deviant result.⁷⁴

- (8) * Miren-i ni baldarra iruditu natzaio
 Miren-D I.A clumsy look like AUX[1sgA-3sgD]
 ‘I have looked clumsy to Miren.’

In bivalent unaccusatives, whereas experiencer datives like *Mireni* in (8) c-command the absolutive argument, goal datives like *Peruri* in (7) are indeed c-commanded by the absolutive (Oyharçabal 1992, Zabala 1995, Artiagoitia 2000, Albizu & Fernández 2006, Albizu 2009, Fernández 2014 Rezac 2008b 2009ab 2011). Hence, while the absolutive

⁷⁴ Albizu marks the example in (8) as ‘??/*’. However, I mark all the examples showing PCC effects as ‘*’, as they are generally considered to be ungrammatical in Basque.

c-commands the dative in (7), c-command relations are reversed in (8).⁷⁵ This implies that PCC effects arise only when the dative c-commands the absolutive in the same syntactic Agree/Case domain. Accordingly, morphological approaches to the PCC would be challenged by the fact that the constraint is affected by purely syntactic notions like c-command (Albizu 1997ab, Rezac 2008b: 67).

4.3.4. Lack of PCC in external arguments

The link of the PCC to the Agree/Case locus in v is also reinforced by the fact that external arguments are exempt from suffering PCC effects. This is illustrated in the examples in (9a) (Albizu 1997a: 86) and (9b) (Albizu 1997b: 8). The ergative external argument is first person in (9a) and second person in (9b). However, the combination with a dative argument does not affect the grammaticality of the sentence.

- (9) a. Ni-k Ander-ri kontzerturako sarrera bat oparitu nion
 I-E Ander-D a ticket for the concert.A present AUX[3sgA-3sgD-1sgE]
'I presented Ander with a concert ticket.'
- b. Zu-k Ander-ri kontzerturako sarrera bat oparitu zenion
 you-E Ander-D a ticket for the concert.A present AUX[3sgA-3sgD-2sgE]
'You presented Ander with a concert ticket.'

In order to understand the lack of PCC effects with external arguments, the constraint should be viewed linked to the Agree/Case locus in v . The ergative arguments *nik* (9a) and *zuk* (9b) are not within the Agree/Case domain of v , but within the domain of T. Hence, the dative *Anderri*, which is actually within vP , does not affect them. This strengthens the relation between the PCC and the v Agree/Case domain, which licenses the dative and the absolutive internal argument, but not the ergative external one. As highlighted by Rezac (2008b: 68), this difference is only perceptible from the point of view of Agree/Case domains, as in Basque, the morphological realization of all arguments is on the same inflected form.

⁷⁵ Albizu (1997b: 9) gives the example in (8) with the reverse word order, namely, with the dative argument following the absolutive one. However, contrary to what happens with goals, I consider that experiencers are more natural if they occur preceding the absolutive argument, as in (8).

4.3.5. PCC in the *leísta* varieties of Spanish

Another piece of evidence that favors a syntactic analysis of the PCC is the fact that in the *leísta* varieties of Spanish, the constraint affects the dative clitic *le* referring to (commonly masculine) animate direct objects. In these varieties, (masculine) animate objects are referred with the dative clitic *le*, while the accusative *lo* is commonly used for inanimate ones (Fernández-Ordóñez 1994: 7 1999: 1319). This is shown in (10) (Ormazabal & Romero 2007: 321).⁷⁶

- (10) a. Lo vi
 3sgA[-Animate] saw
 ‘I saw it.’
- b. Le vi
 3sgD[+Animate] saw
 ‘I saw him.’

As pointed out by Ormazabal & Romero (1998: 418 2001: 220-221 2003: 326 2007: 321 2013a: 224-225), if the PCC was morphological in nature, both the inanimate *lo* and animate *le* should be compatible with a dative clitic, since they both refer to third person objects. Nonetheless, as illustrated in (11) and (12), dative –but not accusative– clitics are ruled out in combination of an agreeing inherent dative.

- (11) Te lo di
 2sgD 3sgA give
 ‘I gave it to you.’
- (12) *Te le di
 2sgD 3sgD give
 ‘I gave him to you.’

Following Ormazabal & Romero (2013c), the pattern attested in the *leísta* dialects could also be accounted for by claiming that, contrary to the dative clitic *le*, the accusative *lo* is a determiner in nature and does not arise as a result of an Agree relation with *v*. Being

⁷⁶ Although in Spanish the most extended type of *leísmo* concerns masculine singular (usually personal) objects, recall from chapter 2 (section 2.3.2) that the *leísmo* in Basque Spanish employs the dative clitic *le(s)* for all kind of animate objects, regardless of their value for gender and number. Hence, in this variety the translation of (10b) would be ‘I saw him/her.’

independent from v , lo would not be affected by the PCC, and the *leista* speakers would resort to it in order to avoid the s-called constraint.

4.3.6. PCC in agreement-less contexts in Haitian Creole

Arguing against morphological analyses of the PCC, Ormazabal & Romero (2007: 330) ultimately point out that in languages like Haitian Creole, the PCC is attested with no overt agreement morphology –similar facts are mentioned by Albizu (1997ab) too. Ormazabal & Romero explain that in Haitian Creole the PCC is triggered when the object is a pronoun (13a) or a proper name (13b), but not if this involves other kinds of noun phrases (13c) (Ormazabal & Romero 2007: 330).

- (13)
- | | | | | | |
|--|------|------|-----|------|------------|
| a. *mwen | pral | bay | li | -l | |
| will | I | give | him | -her | |
| <i>'I will give her to him.'</i> | | | | | |
| | | | | | |
| b. *mwen | pral | bay | Jan | Mary | |
| Will | I | give | Jan | Mary | |
| <i>'I will give Mary to Jan.'</i> | | | | | |
| | | | | | |
| c. mwen | pral | bay | Jan | yon | menai |
| will | I | give | Jan | a | girlfriend |
| <i>'I will give Jan a girlfriend.'</i> | | | | | |

What is important for the purposes of the discussion is that Haitian Creole presents PCC effects in sentences like (13a) and (13b) despite the lack of agreement morphology, challenging once again the validity of morphological analyses of the constraint.

4.3.7. Interim summary

All in all, in this section we have seen that PCC effects ensue when a dative marked argument c-commands a first or second person object and both of them intend to Agree with the same v head. The facts above are straightforwardly derived from this assumption. First, in Basque no PCC effects arise in non-finite contexts because, in absence of Agree/Case loci, none of the arguments enters into an Agree relation with v . Second, the lack of PCC effects in Basque dative-like allocutive markers as well as Romance ethical datives follows from their syntactic position outside v Agree/Case domain. The same line of reasoning would account for the lack of PCC effects with

external arguments too. Third, in Basque no PCC effects yield in bivalent unaccusatives with PP-like goals because, being in a lower configuration, these datives do not intervene in the Agree relation between v and the direct object. Fourth, following Ormazabal & Romero (1998 2007 2010 2013abc), the pattern attested in the *leísta* Spanish dialects could also be explained by claiming that, contrary to the dative clitic *le*, the accusative *lo* is a determiner in nature and does not arise as a result of an Agree relation with v . Fifth, the fact that the PCC is active in agreement-less configurations in Haitian Creole confirms that the constraint should be accounted for on syntactic rather than morphological grounds, as in those cases there is no clitic cluster involved.

Having reviewed some of the pieces of evidence that Basque –and other languages– give us to analyze the PCC syntactically, we are now ready to analyze the constraint from an Agree/Case point of view.

4.4. THE AGREE/CASE APPROACH OF THE PCC

The Agree/Case approach of the PCC was put forth by Anagnostopoulou (2003) as well as Béjar & Rezac (2003) and developed, among others, by Rezac (2007 2008ab 2009ab 2011). Rezac (2011: 157) formalizes the Agree/Case approach of the PCC as follows in (14).

- (14) PCC (Agree/Case approach): a Goal g cannot Agree for [+person] phi-features if X intervenes between it and its Agree/Case locus, where X is a type to intervene in the Agree/Case system, to which belong applicative datives but not full PPs. If G has no other means of licensing its [+person], it fails the Case Filter.

In order to analyze the Case licensing of dative and absolutive arguments in constructions involving two internal arguments, in this section I examine the Agree/Case approach of the PCC step by step. In section 4.4.1, I show that the constraint is triggered by different kind of datives in [Spec, ApplP], corroborating the claim that the PCC targets constructions with agreeing datives c-commanding the absolutive object. In 4.4.2, the main tenets of the Agree/Case approach are presented. In a few words, I explain that the PCC corresponds to the failure of Case licensing on first

and second person objects because, due to the ν -Agree relation maintained by the inherent dative in [Spec, ApplP], these are unable to Agree with ν in both [person] and [number] phi-features. In line with Anagnostopoulou (2003), Béjar & Rezac (2003) and Rezac (2007 2008ab 2009ab 2011), I thus conclude that the constraint is reduced to a violation of the Case Filter by first and second person objects.

4.4.1. The PCC is triggered by all agreeing datives in [Spec, ApplP]

At the beginning of the chapter I have shown that in Basque the PCC targets ditransitive constructions combining goal datives with first and second person objects. This was illustrated by the examples in (2) (Laka 1993: 27) and (4), which are repeated here in (15). In (15a), we see that agreeing goal datives are compatible with third person objects. On the contrary, (15b) and (15c) show that the same agreeing goal is instead incompatible with a first or second person object.

- (15)
- | | | | | | | |
|----|---|-------------|---------|-------|---------------------|--|
| a. | Zu-k | ni-ri | liburua | saldu | didazu | |
| | you-E | I-D | book.A | sell | AUX[3sgA-1sgD-2sgE] | |
| | <i>'You have sold me the book.'</i> | | | | | |
| | | | | | | |
| b. | *Zu-k | harakina-ri | ni | saldu | naiozu | |
| | you-E | butcher-D | I.A | sell | AUX[1sgA-3sgD-2sgE] | |
| | <i>'You have sold me to the butcher.'</i> | | | | | |
| | | | | | | |
| c. | *Ni-k | harakina-ri | zu | saldu | zaitiot | |
| | I-E | butcher-D | you.A | sell | AUX[2sgA-3sgD-1sgE] | |
| | <i>'I have sold you to the butcher.'</i> | | | | | |

As in many other languages (Bonet 1991: 176-177 1994: 137), in Basque PCC effects have also been proved to be attested with causee, experiencer and possessor datives. This is illustrated in the examples in (16) (Albizu 1997b: 9), (17) (adapted from Albizu 1997a: 175) and (18) (Albizu 2001: 58). The examples in (16) exhibit PCC effects with experiencer datives, the ones in (17) with possessor datives and those in (18) with

causee datives.⁷⁷ All the examples show that agreeing causee, experiencer and possessors are only allowed to combine with third person objects.⁷⁸

- (16) a. Miren-i Pello baldarra iruditu zaio
Miren-D Pello.A clumsy look like AUX[3sgA-3sgD]
'Pello has looked clumsy to Miren.'
- b. *Miren-i ni baldarra iruditu natzaio
Miren-D I.A clumsy look like AUX[1sgA-3sgD]
'I have looked clumsy to Miren.'
- c. *Miren-i zu baldarra iruditu zatzaizkio
Miren-D you.A clumsy look like AUX[2sgA-3sgD]
'You have looked clumsy to Miren.'
- (17) a. Aita-k ama-ri umea beso-etatik kendu
father-E mother-D child.A arms-ABL take away
dio
AUX[3sgA-3sgD-3sgE]
'The father has taken the child away from the mother's arms.'
- b. *Aita-k ama-ri ni beso-etatik kendu
father-E mother-D I.A arms-ABL take away
naio
AUX[1sgA-3sgD-3sgE]
'My father has taken me away from my mother's arms.'
- c. *Aita-k ama-ri zu beso-etatik kendu
father-E mother-D YOU.A arms-ABL take away
zaitio
AUX[2sgA-3sgD-3sgE]
'Your father has taken me away from your mother's arms.'
- (18) a. Ama-k anaia-ri txakurra etxe-ra ekarr-arazi
mother-E brother-D dog.A house-ALL bring-CAUS
dio
AUX[3sgA-3sgD-3sgE]
'The mother has made the brother bring the dog home.'

⁷⁷ In order to give a complete picture of the paradigm, I have added to Albizu's examples those in (16c), (17a), (17c), (18a) and (18c).

⁷⁸ As in (8), I have changed the word order in Albizu's examples in (16), (17) and (18), as in these examples, the 'indirect object > direct object' word order seems more natural to me.

b. *Ama-k anaia-ri ni etxe-ra ekarr-arazi
 mother-E brother-D I.A house-ALL bring-CAUS
 naio
 AUX[1gA-3sgD-3sgE]
'The mother has made the brother bring me home.'

c. *Ama-k anaia-ri zu etxe-ra ekarr-arazi
 mother-E brother-D you.A house-ALL bring-CAUS
 zaitio
 AUX[2gA-3sgD-3sgE]
'The mother has made the brother bring you home.'

Hence, in Basque along with the goal in (15), experiencer (16), possessor (17) and causee (18) datives trigger PCC effects as well, as agreement with first and second person objects is banned by all of them. This indicates that the constraint is triggered by all inherent datives in [Spec, ApplP], be them generated as DPs in that position –as is the case of causee, experiencer and possessors– or derived to that position from a lower PP configuration –as happens with goals (see chapter 3 section 3.5.2).

4.4.2. Defective [person] ν -Agree of agreeing datives in [Spec, ApplP]

Having determined that in Basque PCC effects are triggered by all agreeing inherent datives in [Spec, ApplP], in what follows I give further details on the Case assignment mechanism carried out by these datives. This will help us understanding the syntactic restriction involved by the PCC.

In chapter 3 (section 3.5.2), I have proposed that regardless of their original syntactic configuration, causee, experiencer, goal and possessors receive inherent dative Case in [Spec, ApplP]. Hence, being already Case licensed, these datives turn out to be unable to Agree with the ν head by valuing its uninterpretable phi-features –otherwise, the Activity Condition (Chomsky 2000: 123 2001: 6) would be violated. These datives have their Case feature already valued by Appl, and are thus opaque for valuing a clausal phi-probe like ν under Agree.

In order to account for the Case opacity exhibited by inherent datives in [Spec, ApplP], Rezac (2008a) puts forth that a nominal that bears inherent or theta-related Case is a DP contained within a PP –or more generally, some XP that contains the DP. Such a PP involves an opaque domain –i.e., a phase– for the DP within it. I agree with Rezac in

assigning a bigger shell to DPs bearing inherent Case. However, I depart from his approach in not considering that bigger shell to correspond to a PP. Instead, I propose that the arguments bearing inherent Case are covered within a KP, being the K head itself the head containing the inherent dative Case value –as in Bittner & Hale (1996). Rezac derives Case opacity in inherent datives from the general opacity of PPs (Abels 2003). Notwithstanding, I believe this could equally be explained by the general opacity of KPs if both KPs and PPs are phases as claimed by Richards (2010: 4). Even though P is equivalent to case morphology in Rezac’s account, taking dative Case to involve a P rather than a K could be misleading for the discussion on the original syntactic category of the dative arguments, as both PP-like and non PP-like datives in [Spec, ApplP] would be regarded as PPs. Instead, by taking the inherent datives in [Spec, ApplP] to be KPs, we still keep the DP vs. PP original categorical distinction in the first merge position and yet account for the uniform DP behavior of all the datives in [Spec, ApplP]. For this reason, I claim that inherent datives in [Spec, ApplP] are characterized as KPs involving a K layer that makes the DP within it unable to Agree with clausal phi-probes like ν .⁷⁹

In spite of their Case opacity, Anagnostopoulou (2003), Béjar & Rezac (2003) and Rezac (2007 2008ab 2009ab 2011) argue that the [person] features of inherent datives in [Spec, ApplP] are visible to the phi-probe on ν , as these intervene in the ν -Agree relation of first and second person objects, which bear both [person] and [number] phi-features. Taking this into account, these authors state that the datives in [Spec, ApplP] participate in the ν Agree/Case system for [person] but not [number] features –the latter being covered by their additional PP (Rezac 2008a), or alternatively, KP shell. As the dative in [Spec, ApplP] is closer from ν than the direct object, the ν head will first see the [person] features in the inherent dative and then the [number] features in the direct object. Hence, this implies that, in contexts with two internal arguments, the uninterpretable phi-features in ν turn out to be checked separately: the [person] features being checked by the dative and the [number] features by the direct object (Taraldsen 1995: 310-312, Chomsky 2000: 128 130-131, Chomsky 2001: 149).

⁷⁹ The Activity Condition states that in order for a given nominal to Agree with a functional head, both the nominal and the functional head must be active, where being syntactically active consists of having uninterpretable features –i.e., [μ Case] in the case of the nominal.

Nevertheless, even being partially visible to the phi-probe on v , it should be noted that the inherent dative is not able to enter into a regular Agree relation by valuing the phi-probe on v with its own phi-features. Because of Case opacity, the dative is only able to Agree defectively in [person] with v , where Defective Agree implies an Agree relation involving the matching of phi-features without phi-valuation. The Agree relation between the dative and the v head is thus defective in the sense that the dative blocks [person], but it does not value [person] in v , which leads to a default value: third person. Accordingly, the Defective Agree relation leads to Defective Intervention: v cannot Agree with [person] across an intervening dative, and the dative itself cannot value the [person] probe.⁸⁰ On that assumption, the development of the derivation will converge or not depending on the phi-feature bundles displayed by the direct object, as this will have to Agree in all its phi-features in order to be Case licensed (Chomsky 2000 2001). If the object is third person, the derivation will converge as usual, as these are known to bear only [number] features. This is shown in the syntactic tree in (19). The tree in (19) illustrates the derivation of a construction involving an inherent dative in [Spec, ApplP] and a third person direct object.⁸¹

⁸⁰ The default third person value assigned to the phi-probe in v can be accounted for in different terms. Rezac (2008a: 112), for instance, maintains that the PP covering the dative argument in [Spec, ApplP] – i.e., our KP– has a [3 \rightarrow local] phi-specification on its P head, from restricted Agree between P and its DP complement. Rezac assumes that there is a phi-probe in P and that the visibility of the phi-features of a DP within a PP occurs through an Agree relation with the intervening P: P Agrees with the DP, and v can in turn Agree with P. This way no special primitive of defective Agree would be invoked. Similarly, Richards (2004: 154-171 2008) criticizes the notion of Defective Intervention itself and claims that the default third person value in Icelandic quirky subjects is the result of regular Agree with a default goal. In particular, this author states that inherently Case marked arguments are always inactive and that structural Case must be added to them in order to reactivate for probing a functional head. Assuming that Case features cannot simply be attached to the previously deactivated phi-set, Richards argues that structural Case is attached to its own phi-set, namely, to minimal phi-substrate involving a defective phi set –i.e., [*i* Person]– with a default specification: [third person]. Therefore, the nominal triggering Defective Intervention would be an inherently Case marked argument with an expletive-like [third person] Case, which would enter into regular Agree and give rise to the third person value on the Agreeing phi-probe.

⁸¹ The syntactic trees depicted in (19) and (20) abstract away from the configurationally lower PP origin of PP-like goals.

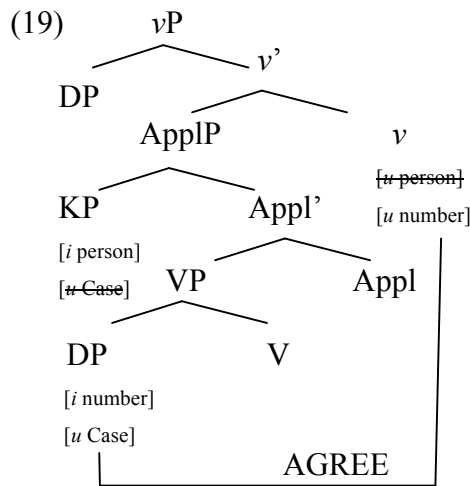

In (19), we see that, although the dative interferes with the [person] probe, v can still Agree for [number] with third person direct objects, assigning thereby structural absolutive Case. Given that third person objects bear [number] but not [person] phi-features, Agree in [number] suffices for these arguments to be Case licensed.⁸²

However, the situation will be rather different if the object is first or second person, as these bear both [number] and [person] features and v has already entered into Agree in [person] with the inherent dative. Considering that functional Case licensing involves Agreeing in all the phi-feature bundles of the nominal in question (Chomsky 2000 2001), first and second person objects fail to be Case licensed, because v is unable to Agree with it in [person]. As depicted by the syntactic tree in (20), this will lead to PCC effects. The tree in (20) represents a construction involving an inherent dative in [Spec, ApplP] and a first or second person object.

⁸² See also Adger & Harbour (2007: 25), who claim that contrary to indirect objects, third person direct objects are never specified for the [participant] –i.e., first and second person– features.

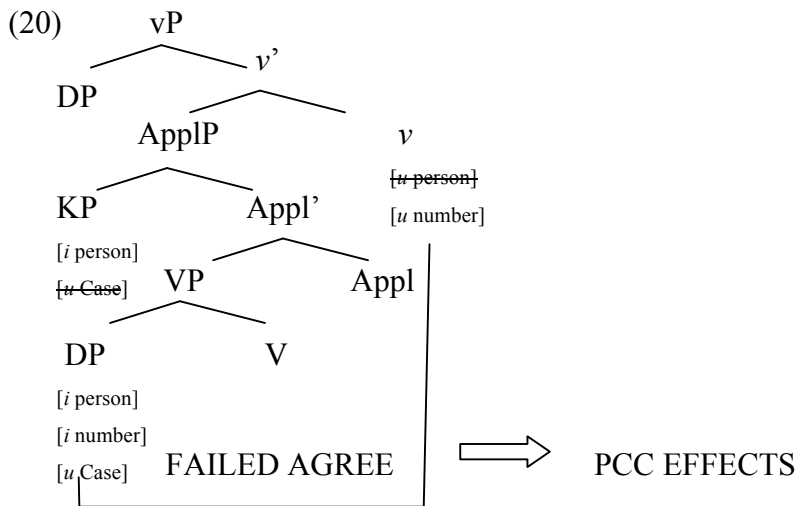

Following Taraldsen (1995: 311), Anagnostopoulou (2003: 265-271) notes that, for first and second person, the [number] features do not make interpretive sense without the [person] features, and that hence, first and second person objects fail to be Case licensed when they are unable to check their [person] features against *v*. Similarly, Béjar & Rezac (2003: 53) propose the *Person Licensing Condition* (PLC) to account for the requirement for first and second person arguments to Agree with a functional head to be Case licensed (21).

- (21) Person Licensing Condition (PLC) axiom: An interpretable first/second person feature must be licensed by entering into an Agree relation with a functional category.

Overall, both for Anagnostopoulou (2003) and Béjar & Rezac (2003), the failure of [person] Agree with a DP with [person] features leads to failure of Case assignment on it, and as a consequence, PCC effects arise.

4.4.3. Interim summary

To sum up, PCC effects in constructions involving two internal arguments are triggered by all agreeing datives in [Spec, ApplP], that is to say, by causee, experiencer, goal and possessor and datives. The first three reach that position by external merge, while the same position is reached by goals by internal merge from a lower PP configuration. Regardless of their origin, all the datives in [Spec ApplP] receive inherent Case from Appl. Inherent Case implies that the nominal is covered within a KP layer, which makes

the nominal within it unavailable to value the phi-features on *v* by undergoing a regular phi-valuing Agree relation. However, being partially visible to it, the dative KP can still defectively Agree in [person] with *v*, establishing a matching relation that will subsequently block the licensing of [person] features on the object. Thus, given that for third person direct objects [number] Agree suffices in order to get absolutive Case, the inherent dative will be compatible with third person direct objects. Conversely, as first and second person objects need to enter into a [person] phi-valuation with a clausal probe, the intervention of the inherent dative will leave first and second person objects unable to check Case, and triggering PCC effects, the derivation will consequently crash.⁸³

⁸³ The blocking effect of the dative argument is implemented differently by other authors. For instance, Baker (2008) proposes that the dative occupies the [Spec, *v*P] position and that the spec-head configuration is needed for [person] Agree with first and second person objects. This is formalized by his ‘Structural Condition on Person Agreement’ (SCOPA): F can agree with NP in +1 (first person) or +2 (second person) if NP is the specifier of FP, but it can also agree in this richer way if NP is the complement of F (Baker 2008: 52). On the other hand, Adger & Harbour (2007) argue that the dative blocks the licensing of the direct object because both the dative and the first or second person direct object compete for [participant] Agree with the same Appl head. Moreover, there are still other authors who take the PCC to be a syntactic constraint linked to Agree/Case, but analyze it more like a competition between two arguments rather than an intervention effect of one argument to another. This is the approach put forth by Ormazabal & Romero (1998 2001 2007 2013ab). These authors argue that some nominals – namely, those of third person (inanimates) objects– are able to remain without Case licensing. Hence, for them when an applied object triggers the PCC, the blocking effect is not partial as argued by the Case/Agree approach, but rather complete. The applied object enters into a regular Agree relation with the *v* head. This will only be problematic if the direct object is first and second person –and animate third person in the *leísta* varieties, as for them third person (inanimates) do not need to be Case licensed by Agreeing with a functional head. See also Preminger (2014) for a similar view. Preminger (2014: 159) argues that dative intervention in PCC contexts is an instance of failed agreement altogether. Preminger states that in these contexts third person singular agreement morphology is simply the spell-out of a phi-probe that lacks [plural] and [participant] values, whose result is morphologically indistinguishable from successful agreement with a third person singular goal. In line with Ormazabal & Romero, this author assumes that it is tolerated by the grammar that certain arguments do not enter into an Agree relation to satisfy their uninterpretable features.

4.5. THE PP REPAIR STRATEGY

Having concluded that PCC effects are syntactic in nature and that they arise as a failure of Case licensing on first and second person objects, in this section I explore a repair strategy that many –although not all– Basque speakers employ in order to avoid such a failure. The repair consists of leaving the dative argument as a full PP, without agreeing with the finite verbal form, and as we will see, not all datives triggering the PCC can resort to it. In accordance with the DP vs. PP distinct origin of the different types of datives, I show that the repair is available for PP-like goals (section 4.5.1), but not DP datives like causee, experiencer and possessors (section 4.5.2) (Albizu 1997a 2001, Rezac 2009b 2011).

Before analyzing the PP repair strategy employed in PCC contexts, it is first of all necessary to say a couple of words on the dative markers in the finite verbal form. The inherent Case assignment accounts for the *-(r)i* case marker in the dative nominal. Nevertheless, apart from bearing case marking, dative arguments trigger dative markers in the verbal complex too, and such markers cannot arise as a consequence of an inherent Case assignment, as both clitics and agreement markers are, on standard assumptions, associated to a structural Agree relation with a functional head. The dative markers in the verbal form could then arise as a by-product of the [person] Agree relation held between *v* and the dative argument. However, as noted by Rezac (2008a: 89-90), if the inherent dative is unable to value the phi-probe in *v* with its own [person] features, the markers in the finite verbal form will not reflect agreement markers. Agreement markers are the result of a regular valuing Agree relation that consists of copying the phi-features of the goal to the probe. Consequently, the dative markers in the agreement complex could only arise as a result of clitic doubling, by the movement of a head that brings the interpretable phi-feature bundle of the dative nominal to *v*.⁸⁴ This is indeed the approach put forth by Rezac (2008a 2011) –see also Rezac (2006

⁸⁴ I agree with Preminger (2014), in arguing that, when clitic doubling takes place, the nominal brings into the functional head all its interpretable features, and not only those that have been visible by the functional head.

2007 2008b), Rezac et al. (2014), Etxepare (2006 2014), Arregi & Nevins (2008 2012) and Preminger (2009 2014).

The exact mechanism involved in such clitic doubling process is set out in section 4.7. As for the following discussion on the PCC repairs, it is enough to recognize that the dative markers in the finite verbal form belong to clitics doubling the ν P internal dative argument.

4.5.1. A brief description of the repair

In order to understand how the repaired sentences differ from the deviant ones, consider first the PCC-affected ditransitive sentence in (22) (adapted from Laka 1993: 27).

- (22) *Traidore-ek etsaia-ri ni saldu naiote
 traitors-E enemy-D I.A sell AUX[1sgA-3sgD-3plE]
'The traitors have sold me to the enemy.'

In section 4.4, I have argued that in (22) the first person object fails to be Case licensed because [person] Agree with ν is blocked by the Defective Intervention of the dative *etsaiari* 'to the enemy'. Bearing both [person] and [number] features, the first person object needs to Agree with each of the two phi-feature bundles, and the blocking effect of the dative prevents it to do so with the [person] features. As a consequence, the object remains unlicensed for Case, and the derivation crashes.

As has been noted by Albizu (1997a: 38 2001: 50 2009: 7), Artiagoitia (2000: 405), Etxepare & Oyharçabal (2008a: 5, 28), Rezac (2009b: 774, 2011: 184, 246) Oyharçabal & Etxepare (2012: 152-153), Fernández & Rezac (2010: 137 2016: 122) and Odria (2014: 305-306), many Basque speakers are able to repair the deviant sentence in (22) by leaving the dative without agreeing with the finite verbal form, as in (23).

- (23) Traidore-ek ni etsaia-ri saldu naute
 traitors-E I.A enemy-D sell AUX[1sgA-3plE]
'The traitors have sold me to the enemy.'

In (23), the dative argument is realized as a non-agreeing PP, and the finite verb agrees only with the ergative and absolutive arguments. In absence of a defective [person] ν -Agree relation of the dative, the first person object Agrees in both [person] and

[number] with v and receives this way absolutive Case. This is realized as absolutive case (\emptyset) in the nominal and absolutive agreement marker (n -) in the agreement complex. PCC effects are thus vanished once the dative behaves as a non-agreeing full PP, because in absence of the dative's defective intervention, the object can Agree with v in both [person] and [number] features.

As expected, the same strategy is equally feasible if the object is second person. The contrast in (24) illustrates that, as happens with first person, v -Agree with second person objects is only possible if the dative argument ceases to do so.

- (24) a. *Traidore-ek etsaia-ri zu saldu zaitiote
 traitors-E enemy-D you.A sell AUX[2sgA-3SD-3plE]
 ‘The traitors have sold you to the enemy.’
- b. Traidore-ek zu etsaia-ri saldu zaituzte
 traitors-E you.A enemy-D sell AUX[2sgA-3plE]
 ‘The traitors have sold you to the enemy.’

Just as in (23), the well-formed sentence in (24b) solves the PCC effects in (24a) by realizing the dative argument as a non-agreeing PP. This allows the second person object to Agree both in [person] and [number] with v .^{85 86}

⁸⁵ Along with Basque, other languages like French (Rezac 2009b 2011) and Kiowa display similar repair strategies (Adger & Harbour 2007: 4-5). In Kiowa, when the verb *bring* takes an indirect object and a second person direct object, the verbal agreement prefix cannot encode all three arguments, and the indirect object occurs as a non-agreeing PP. This is exactly the same strategy found in (23) and (24b).

⁸⁶ Although in this dissertation only goal datives are analyzed among PP-like datives, the literature on Basque datives has shown that source datives pattern like goals with regards to the possibility to occur as non-agreeing in northeastern Basque –see, among others, Fernández, Ortiz de Urbina & Landa (2009). Interestingly, sources also pattern with goals in being able to occur without dative markers in order to avoid the PCC. The example in (i), for instance, was produced by a TV host.

- (i) Olentzero-ri eskatuko zaitut
 Olentzero-D ask AUX[2sgA-1sgE]
 ‘I will ask you to Olentzero.’
 [Olentzero is a collier that gives presents to the children at Christmas in the Basque Country]

In (i), a third person source dative combines with a second person absolutive object and only the latter is coed by the finite verbal form.

Descriptively speaking, we see that the repair attested in both (23) and (24b) consists of turning the agreeing dative into a non-agreeing full PP, which in turn implies a turning from the presence to the absence of dative markers in the finite verb. In this regard, it is important to note that the only marker that can be absent in the finite verbal form is that of the dative argument. As shown in (25), the first or second person absolutive must always be coupled with agreement markers in the finite verb.

- (25) *Traidore-ek ni/zu etsaia-ri saldu diote
 traitors-E I/you.A enemy-D sell AUX[3sgD-3plE]
 ‘The traitors have sold you to the enemy.’

In (25) the finite verbal form cross-references the ergative (-te) and the dative arguments (-o-), and the first/second person object is left without agreement markers, which leads to a deviant result.

4.5.2. The repair consists on adding an Agree/Case locus to P

Considering that non-agreeing datives like *etsaiari* ‘to the enemy’ in (23) and (24b) do not enter into Agree with v , it seems reasonable to postulate that these non-agreeing datives involve a richer internal structure than the DP datives in agreeing with the finite verbal form. As a result, the dative does not need to Agree defectively with v and this permits the first or second person object Agree both in [person] and [number] with v .

According to Rezac (2009b: 772-780 2011: 18-20, 240-249), the turning from the agreeing to the non-agreeing dative could be the consequence of strengthening the PP by adding to it its own internal Case licenser. This author accounts for the PP repair strategy by means of the interface algorithm in (26) (Rezac 2011: 219), which is a subcase of the more general one in (27) (Rezac 2011: 20).

- (26) \mathfrak{R} (for Agree/Case): a uninterpretable feature (probe) may enter the numeration on a potential Agree/Case locus if needed for Case licensing.

Besides, in this dissertation the PP repair strategy is exemplified with the verb *saldu* ‘sell’. Nevertheless, the same repair has also been reported with verbs like *aurkeztu* ‘introduce’ (Rezac 2009b: 774, Oyharçabal & Etxepare 2012: 151-152), *gomendatu* ‘recommend’ (Albizu 2009: 7) and *eraman* ‘carry’ (Rezac 2009b: 774, 2011: 184, 246).

- (27) \mathfrak{F} : an uninterpretable feature may enter the numeration only if needed for Full Interpretation of the syntactic structure built from it.

Rezac (2011: 18-20) argues that uninterpretable features are the mechanism by which syntax can dynamically respond to the needs of Full Interpretation. This author states that in order to avoid illegibility, the numeration can be modified by adding uninterpretable features that make it possible to form new syntactic dependencies.

As noted by Rezac (2011: 197-198), the PP repair strategy fits well with the derivational analysis put forth by Ormazabal & Romero (1998) for Basque datives, since this assumes that both agreeing and non-agreeing (goal) datives derive from the same PP complement of V, which is structurally lower than the direct object. In the derivational approach, an Agree/Move relation occurs between the non-agreeing and agreeing datives and the direct object lies on this path, as the movement from the non-agreeing to the agreeing dative depends on the [person] specification of the object.

Adhering to the main tenets in Ormazabal & Romero (1998 2010 2017) and Albizu (2001 2009), in chapter 3 (section 3.5.2) I have claimed that agreeing goal datives are derived from a PP complement of V, located lower than the direct object. Ormazabal & Romero argue that, under normal circumstances the P head incorporates into V, attracting the already DP nominal outside VP and allowing this way an Agree relation with *v*. This is illustrated in (29), which represents the most recent version of Ormazabal & Romero's analysis. The syntactic tree in (29) depicts the derivation of a sentence like (28) (Ormazabal & Romero 2017).

- (28) Ama-k semea-ri ogia igorri dio
 mother-E son-D bread.A send AUX[3sgA-3sgD-3sgE]
'The mother has sent bread to her son.'

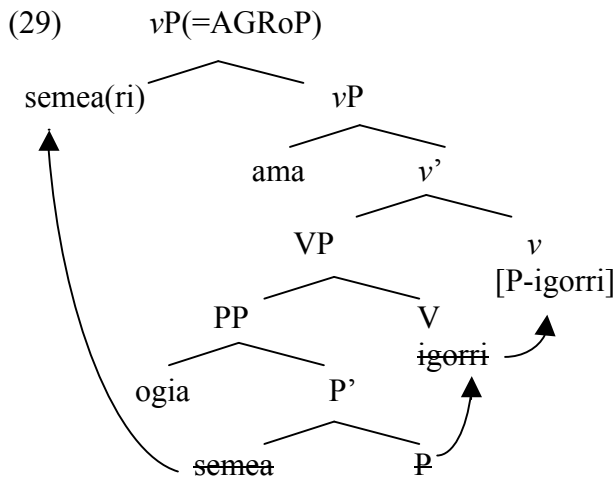

Slightly modifying Ormazabal & Romero’s (1998) approach, I assume that P-incorporation brings a [person] probe to ν , and that as a consequence, ν seeks to attract the [person] goal to [Spec, ApplP]. Once in [Spec, ApplP], the goal receives inherent dative Case from Appl and Agrees defectively in [person] with ν , allowing subsequent clitic doubling.⁸⁷ This is illustrated in (30).

⁸⁷ Ormazabal & Romero (1998) argue that V attracts the [animacy] feature and that the goal rises to [Spec, VP] triggered by such feature. However, in line with Rezac (2011:198), I take the feature attracting one of the internal arguments to be [person] instead of [animacy], making this way Ormazabal & Romero’s approach compatible with the [person] features attested in first and second person direct objects as well as all kind of indirect objects. Besides, instead of assuming that the goal ends up checking structural dative Case in [Spec, VP], I also modify Ormazabal & Romero’s (1998 2010 2017) claim and assume that the movement is to [Spec, ApplP]. This allows us to propose one and the same Case assignment for all datives with inherent Case.

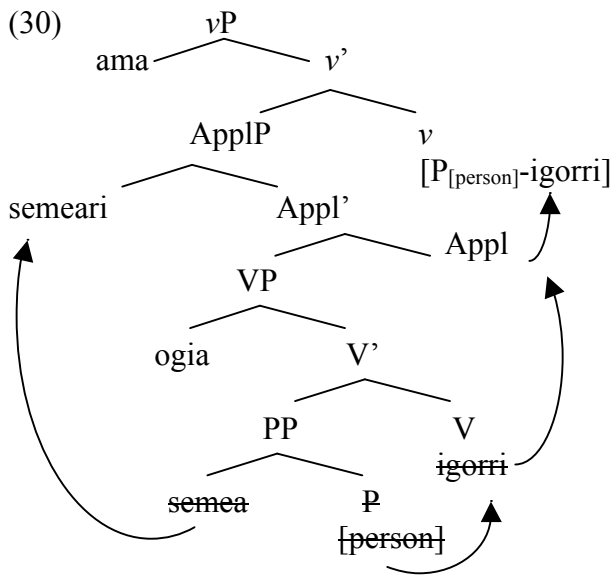

Crucially, assuming that P brings a [person] feature to v , the Agree/Case approach of the PCC predicts that the derivation of goal datives will crash if the direct object –which is in between the originally lower goal and v – is first or second person and thus bears [person] features too, as this will block the Agree/Move process of the goal. Therefore, the goal will have no other option but to remain in its PP base position. At this point of the derivation, the interface algorithm in (26) will be applied and the deviant structure will be repaired by adding uninterpretable phi-features to the previously inactive Agree/Case system of the defective P head (Rezac 2011: 240-247).⁸⁸ This fortifies the defective non-phase PP to a full phase PP, and as a consequence, the enriched P ends up being able to Agree with its complement without incorporating into V. This leads the nominal within PP receive inherent dative Case from P.⁸⁹ As the addition of

⁸⁸ Note that uninterpretable features can only be added to P, as the Agree/Case loci in T and v have been used up (Rezac 2011: 240).

⁸⁹ Contrary to Ormazabal & Romero (1998 2010) and Albizu (2001), I thus assume that the $-(r)i$ marker in non-agreeing datives does not correspond to the P head itself, but to the inherent Case assigned by such head. In spite of that, it is worth noting that the view taken in this dissertation is still compatible with the main insight in Albizu's (2001) study, the first work that makes it explicit the PP-like nature of (certain) Basque datives. The claim that $-(r)i$ in non-agreeing datives corresponds to the Case assigned by P is also assumed by Etxepare & Oyharçabal (2013), Etxepare (2014) and Ormazabal & Romero (2017)

uninterpretable features turns the defective non-phasal P to a full phasal P, the nominal inside it becomes invisible to external clausal Agree/Case loci, and as a result, no PCC effects arise, as the Agree/Case system in v is entirely available for the direct object. Thus, the addition of uninterpretable phi-features to P ensures that Full Interpretation is satisfied by providing a Case licenser to the first or second person object. Recall that this was the situation in sentences like (23) and (24b), depicted in the syntactic tree in (31).⁹⁰

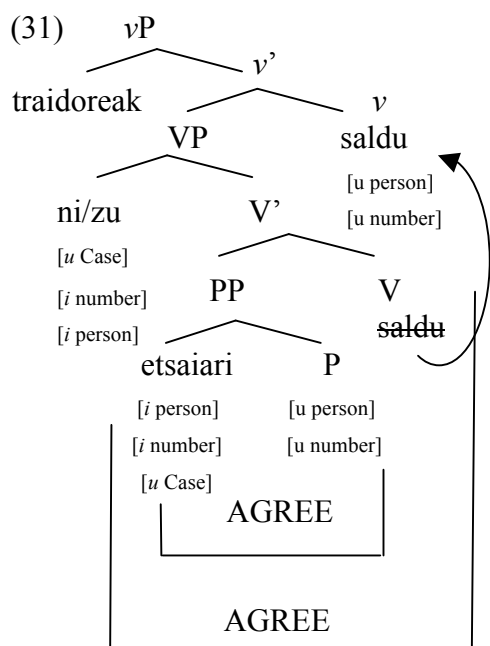

A clear consequence of the activation of the Agree/Case system in P is that the lack of movement to [Spec, AppIP] implies the lack of dative markers in the finite verbal form.

⁹⁰ The relation between the P head and its complement in a PCC-affected contexts like (31) is identical to that assumed in chapter 3 (section 3.5.2) for non-agreeing goal datives in northeastern Basque, as the $-(r)i$ case marker is assigned by the P head in both of them. Ormazabal & Romero (2017) point out that the difference between agreeing and non-agreeing datives in northeastern Basque lies in the optionality of the P head to incorporate into V –i.e., which is in turn dependent on the feature specification of the P head. I believe that the distinction between agreeing and non-agreeing goals is easily accounted for in Rezac’s (2011) terms, namely, by claiming that P can be phasal or not, and that only the former –which lacks an Agree/Case locus– needs to incorporate into V. This way, we would account not only for the agreeing vs. non-agreeing distinction *per se*, but also for other facts related to the PCC.

If clitic doubling is contingent on a previous Agree relation with a functional head and if the dative in the repair strategy does not Agree in [person] with v , no clitic doubling will arise in those contexts. As a matter of fact, this is what we have seen both in (23) and (24b): the dative occurs as a non-agreeing PP and the finite verb cross-references both the ergative and the first or second person direct object.⁹¹

In chapter 3, I have argued that not all datives are generated with a PP syntactic category, as some of them, namely causee, experiencer and possessors, are unable to behave as PPs. On that assumption, if the PP repair strategy consists of adding a phi-probe to the originally PP argument (Rezac 2011), we deduce that the strategy should be unavailable for DP datives, as these have no P head to which uninterpretable features can be added. As I show in section 4.5.2, this is in fact what we the situation in Basque, because as shown by Albizu (1997a 2001) and Rezac (2009b 2011), causee, experiencer and possessors cannot resort to the PP repair strategy.

4.5.3. The repair is unavailable for DP datives

As has been shown by Albizu (1997a 2001) and Rezac (2009b 2011), the PP repair strategy is in fact unavailable for causee, experiencer and possessor DP datives (Albizu 1997a 2001, Rezac 2008a 2011). Rezac (2011: 242) argues that the PP repair of the PCC is not available for causees, experiencers and possessors, because these datives hold a relation with something else in the clause –for instance, possessor-possessum binding, and this would be impossible within the full phasal PP. In contrast to Rezac, I believe that the PP repair is inaccessible for DP datives just because these datives do not bear a P head whose Agree/Case locus can be activated by adding uninterpretable phi-features. DOM objects do not bear any special relation with other elements in the clause and, as we will see in section 4.6, the repair is neither available for them. DOM objects are originated as DPs, and hence, the lack of the PP repair strategy is something

⁹¹ Rezac (2007: 119-124 2011: section 4) notices that the addition of uninterpretable phi-features can equally account for the repair strategies in languages like French. In French PCC effects are repaired by turning the dative clitic into a non-pronominal *à* PP (Kayne 1975: 175-175, Bonet 1991: 201-202), involving the strengthening of the weak clitic pronoun by the addition of richer internal structure in Rezac's terms.

expected for them. This suggests that the unavailability of the so-called repair with causee, experiencer and possessor datives is due to their DP syntactic category as well.

Let us then see one by one the behavior of causee, experiencer and possessor datives when these are combined with a first or second person object.

First, generally speaking, the causee dative cannot be left without dative markers in the finite verbal form (Albizu 2001: 58, Rezac 2009b: 776). This is illustrated in the examples in (32).⁹²

- (32) a. *Traidore-ek etsaia-ri ni saldu-arazi naute
 traitors-E enemy-D I.A sell-CAUS AUX[1sgA-3plE]
'The traitors have made the enemy sell me.'
- b. ??Traidore-ek etsaia-ri zu saldu-arazi zaituzte
 traitors-E enemy-D you.A sell-CAUS AUX[2sgA-3plE]
'The traitors have made the enemy sell you.'

Besides, it is generally impossible for the dative to agree with the finite verbal form while leaving the absolutive object without triggering agreement markers. Consider the ungrammaticality in (33).

- (33) *Traidore-ek etsaia-ri ni/zu saldu-arazi diote
 traitors-E enemy-D I.A/you.A sell-CAUS AUX[3sgD-3plE]
'The traitors have made the enemy sell me/you.'

Second, the possessor dative can neither avoid PCC effects by suspending the dative markers in the agreement complex (Albizu 1997a: 175, Rezac 2009b: 776). Take now the examples in (34) (adapted from Albizu 1997a: 175).⁹³

⁹² The judgements of the consulted speakers are not so robust with regards to (32b), as some speakers find it not completely unacceptable. For this reason, I have marked such sentence as ??.

⁹³ Rezac (2009b: 776) adds that with regards to possessor datives, there is some variation even within a speaker's grammar, as one of his consultants accepts the sentence in (i).

- (i) Aita-k ama-ri zu beso-etatik kendu zintuen
 Father-E mother-D you.A arms-ABL take away AUX[2sgA-3sgE]
'Your father took you away from your mother's arms.'

According to Rezac, this could be due to a purely ditransitive construal of these verbs, with a goal/source indirect object.

- (34) a. *Ama-ri ni esku-etatik kendu naute
 mother-D I.A arms-ABL take away AUX[1sgA-3plE]
'They have taken me away from my mother's arms.'
- b. *Ama-ri zu esku-etatik kendu zaituzte
 mother-D you.A arms-ABL take away AUX[2sgA-3plE]
'They have taken you away from your mother's arms.'

Again, as illustrated in (35), generally speaking, the first or second person absolutive object can neither be left without dative markers in the finite verbal form.

- (35) *Ama-ri ni/zu esku-etatik kendu diote
 mother-D I.A/you.A arms-ABL take away AUX[3sgD-3plE]
'They have taken me/you away from my mother's arms.'

Finally, experiencer datives are neither able to repair PCC effects by occurring without dative markers in the agreement complex (36). As expected, the absolutive object can neither be left without agreeing with the finite verbal form (35).

- (36) a. *Jon-i ni harroa iruditzen naiz
 Jon-D I.A arrogant look like AUX[1sgA]
'I look arrogant to Jon.'
- b. *Jon-i zu harroa iruditzen zara
 Jon-D you.A arrogant look like AUX[2sgA]
'You look arrogant to Jon.'
- (37) *Jon-i ni/zu harroa iruditzen zaio
 Jon-D I.A/you.A arrogant look like AUX[3sgA-3sgD]
'I/you look arrogant to Jon.'

All in all, as it is straightforwardly predicted by the DP vs. PP syntactic source, the repair strategy involving the addition of an Agree/Case locus to P is only accessible for those datives that are in fact generated as PPs, that is, for goals. Causee, experiencer and possessors are generally ruled out when occurring without dative markers in the finite verbal form.⁹⁴

⁹⁴ Although the judgments of most of the consulted speakers go in the opposite direction, one of the consultants is more tolerant with PCC effects when these are triggered by causee and possessor datives. This speaker admits the examples in (33) and (35). Be that as it may, it should be noted that the same speaker finds a difference between (35), where the direct object is first or second person, and the example in (i), where the direct object is third person. Contrary to (35), (i) is completely grammatical for her.

4.5.4. Interim summary

Summing up, the failure of Case licensing found in PCC contexts is repaired by adding Case licensing capacity to an otherwise inactive Agree/Case locus in the P head (Rezac 2011). By adding uninterpretable phi-features, the PP dative becomes a full phasal PP, and as a result, it ends up being invisible to clausal Agree/Case loci –i.e., P provides an Agree/Case locus in its functional structure to Agree with its complement nominal, and as a consequence, this receives inherent dative Case from P. Such a PP repair strategy gives rise to two main consequences in the derivation of goal datives. On the one hand, as the P does not incorporate into V, the dative does not move to [Spec, ApplP], and in absence of ν -Agree with [person] phi-features, no dative markers arise in the finite verbal form. On the other hand, as the full P head is a phasal head, the nominal within it remains invisible for external Agree/Case loci, and no PCC effects ensue, because the dative does not intervene in the ν -Agree relation required by the object.

The PP repair strategy is exclusive to PP-like goals, as the PCC is generally irreparable for the rest of causee, possessor and experiencer DP datives. This supports the DP vs. PP original categorical distinction set out in chapter 3. If, as assumed by the base-generated analysis of Basque datives (Etxepare & Oyharçabal 2013, Etxepare 2014), goals were neither generated as PPs, there would be no P head to host uninterpretable phi-features and the constraint would also be irreparable with them. Likewise, if –as in in classical derivational analyses like Ormazabal & Romero (1998) or Albizu (2001)– all datives were derived from an originally PP argument, causees, experiencers and possessors should also be able to occur as non-agreeing, contrary to facts.⁹⁵ Therefore,

(i)	Ama-ri	umea	esku-etatik	kendu	diote
	mother-D	child.A	arms-ABL	take away	AUX[3sgA-3sgD-3plE]
	<i>'They have taken the child away from his/her mother's arms.'</i>				

Thus, although the judgments of some speakers are not so robust in PCC-affected contexts, this does not mean that the constraint is unperceivable at all, as the contrast between first and second vs. third person objects is always clear for them.

⁹⁵ Albizu's (2009) analysis would also be overgenerating, because it assumes that P-incorporation does not only occur with goals, but also with possessor datives. As we have seen, possessors pattern with causees and experiencers in not being able to resort to the PP repair strategy –and they neither occur as

in addition to their distinct pattern with regards to the licensing of secondary predication, the distinct behavior attested between DP and PP-like datives is also justified by the availability or not to resort to the PP repair strategy. This provides additional support to the mixed analysis of Basque datives presented in chapter 3 (section 3.5.2): while causee, experiencer and possessors are base generated as DPs in [Spec, ApplP] (Etxepare & Oyharçabal 2013, Etxepare 2014), goal datives are first merged in syntax as PPs in the complement position of V (Ormazabal & Romero 1998 2010 2017, Albizu 2001 2009).

From a more general point of view, the PP repair strategy has additionally demonstrated that PCC effects are targeted at the v P domain, because the effects are irreparable when the two internal arguments are generated as DPs and thus need to Agree with v .

Having established the main theoretical aspects encompassed by the PCC, we are now ready to explore the behavior of DOM objects with respect to such constraint. On the one hand, analyzing whether the PCC affects the licensing of DOM objects will allow us to identify the process lying behind it. On the other hand, testing whether DOM objects resort to the PP repair strategy will let us verify the DP syntactic category posited for them in chapter 3.

4.6. THE PCC AND ITS REPAIRS IN DOM OBJECTS

In previous chapters we have reached to the conclusion that, in spite of their dative marking, DOM objects are merged in syntax as complements of V with a DP syntactic category. Hence, the default hypothesis concerning their Case licensing process would be that these non-canonical objects Agree with the v head too. In order to hold such hypothesis, this section focuses on the behavior of DOM objects in PCC contexts. In a few words, the line of argumentation goes as follows. The PCC affects the licensing of those objects that are intended to Agree with v both in [person] and [number]. Hence, if first and second person DOM objects happen to be affected by the constraint, this will

non-agreeing in northeastern Basque. Therefore, although in his view the derivational approach is not meant to account for all kind of datives, Albizu's (2009) approach is still overgenerating on this point.

imply that a ν -Agree relation is maintained by these objects too. Thus, we could conclude that, akin to canonical absolutes, DOM objects are equally Case licensed by ν . Otherwise, if they were licensed by an independent head, the presence of an agreeing dative in [Spec, ApplP] would be innocuous for them.

The section is structured as follows. In 4.6.1, I show that DOM objects are in fact affected by the PCC. In 4.6.2, I examine the repair strategies available for DOM speakers when first and second person objects occur along with goal datives. Focusing on the verb *saldu* ‘sell’, I demonstrate that, as happens with canonical absolutes, the goals combined with DOM objects are also able to resort to the PP repair strategy (Fernández & Rezac 2010 2016, Odria 2014). Besides, I show that the PP repair is unavailable for DOM objects, corroborating their DP syntactic category established in chapter 3. Other kinds of repairs are also presented in this section, since not all speakers and verbs allow the PP repair strategy that gives rise to a double dative construction. Section 4.6.3 deals with PCC effects triggered by causee, experiencer and possessor datives. It shows that the combination of first and second person DOM objects with DP datives yields usually a deviant result, as being categorically DPs, none of them is able to occur as a non-agreeing PP. The categorical contrast between PP-like goals and DP datives like causees is ultimately borne out in section 4.6.4. In this section I show that, in ditransitive causative constructions combining a causee and a goal dative, only the goal is able to occur as non-agreeing.⁹⁶

4.6.1. DOM objects are affected by the PCC

As happens with absolute objects, the combination of a first or second person DOM object with a goal dative is banned if both the goal and the DOM dative agree with the

⁹⁶ The examples provided in this section have been tested among speakers of different southwestern Basque varieties. However, for ease of exposition, I present all the data given by these speakers in Standard Basque. The only exceptions are the examples taken from other studies dealing with Basque DOM, such as Arraztio (2010) and Fernández & Rezac (2010 2016). The examples collected in these studies are given in the variety of the speaker, as in their original version.

finite verbal form. Consider the deviant examples in (38), which involve the combination of a first or second person DOM and a goal dative.⁹⁷

- (38) a. *Traidore-ek ni-ri etsaia-ri saldu didaote
 traitors-E I-D enemy-D sell AUX[1sgD-3sgD-3plE]
'The traitors have sold me to the enemy.'
- b. *Traidore-ek zu-ri etsaia-ri saldu dizuote
 traitors-E you-D enemy-D sell AUX[2sgD-3sgD-3plE]
'The traitors have sold you to the enemy.'

As with *saldu* 'sell', the same thing occurs with other verbs like *deskribatu* 'describe' (39), *gomendatu* 'recommend' (40) or *aurkeztu* 'introduce' (41) when these show a ditransitive configuration. The combination of an agreeing goal with a first or second person agreeing DOM object is ruled out with all of them.

- (39) a. *Lagun-ek ni-ri polizia-ri deskribatu didaote
 friends-E I-D police-D describe AUX[1sgD-3sgD-3plE]
'My friends have described me to the police.'
- b. *Lagun-ek zu-ri polizia-ri deskribatu dizuote
 friends-E you-D police-D describe AUX[2sgD-3sgD-3plE]
'Your friends have described you to the police.'
- (40) a. *Lankide-ek ni-ri zuzendaria-ri gomendatu didaote
 workmate-E I-D boss-D recommend AUX[1sgD-3sgD-3plE]
'My workmates have recommended me to the boss.'
- b. *Lankide-ek zu-ri zuzendaria-ri gomendatu dizuote
 workmate-E you-D boss-D recommend AUX[2sgD-3sgD-3plE]
'Your workmates have recommended you to the boss.'
- (41) a. *Lankide-ek ni-ri zuzendaria-ri aurkeztu didaote
 workmate-E I-D boss-D introduce AUX[1sgD-3sgD-3plE]
'My workmates have introduced me to the boss.'
- b. *Lankide-ek zu-ri zuzendaria-ri aurkeztu dizuote
 workmate-E you-D boss-D introduce AUX[2sgD-3sgD-3plE]
'Your workmates have introduced you to the boss.'

⁹⁷ As in the examples provided throughout the previous sections, the PCC-affected configurations analyzed in this section also involve a third person inherent dative.

At this point, one could think that the ungrammaticality in sentences like (38), (39), (40) and (41) is due to the combination of two datives in the same v P domain, given that in Basque, double dative constructions seem to be quite marked. However, in this section I show that this is not the fundamental reason for the ungrammaticality in those sentences, as at least in the case of *saldu* ‘sell’, double dative constructions are possible as long as one of the datives –namely, the goal– is realized as a non-agreeing full PP. Likewise, at first glance, the ungrammaticality in (39), (39), (40) and (41) could also be regarded to arise as a consequence of the double dative marking in the agreement complex, as in Basque it is impossible for two dative markers to co-occur in the same verbal form. Notwithstanding, apart from the double dative marking in the agreement complex, these sentences are additionally ungrammatical because both the first or second person DOM and the goal dative Agree at the same time with the v head. As we will see in section 4.6.3, when DOM objects are combined with a DP dative, double dative constructions are mostly ungrammatical even when the finite verbal form bears a single dative marker. Given that DOM, causee, experiencer and possessor datives are required to Agree with v , none of them can be left as a non-agreeing PP and it is mostly impossible for the finite verbal form to code only one of the two dative arguments. This makes it clear that the problematic aspect of (38), (39), (40) and (41) is not only the morphological combination of two dative markers in the finite verbal form, as this is just one of the consequence of the actual problem, that is, the simultaneous v -Agree relation maintained by two dative arguments. For the purposes of the discussion, this indicates that DOM objects maintain an Agree relation with the v head. Otherwise, if these objects did not Agree with v , it would be unexpected that the constraint –which is clearly linked to the v head– affected their Case licensing. It thus seems that our preliminary hypothesis suggesting a v -Agree relation for DOM objects was on the right track.

Before going through the PCC repair strategies used by DOM speakers, it is worth mentioning that in ditransitive constructions, some of them prefer –or at least admit– to mark the first and –very specially– second person object absolutive, as in Standard

Basque (Arraztio 2010, Fernández & Rezac 2010: 137, Odria 2014: 303-304).⁹⁸ ⁹⁹ For these speakers, the PCC affects the licensing of the object in the same way as for the rest of non-DOM speakers, and in some cases, the same PP repair strategy can be employed by the goal in order to avoid the constraint.

As pointed out by Fernández & Rezac (2010: 137), the tendency to mark the object absolutive in PCC-affected contexts could be linked to the optional character of the DOM phenomenon among those speakers. In relation to its optionality, it is also important to notice that the distribution of Basque DOM is altered by the nature of the verb too. As I have pointed out in chapter 2 (section 2.4), DOM is more extended with some verbs than with others (Mounole 2012, Rodríguez-Ordóñez 2016), and the preference for marking first and mostly second person objects absolutive in (certain) ditransitive predicates could also be linked to the preference for marking absolutive the same objects of these predicates when these occur in a transitive frame.

Apart from its optional nature, one could also think that the absolutive marking in first and second person objects emerges with the aim at avoiding the combination of two datives in the same clause, which –as I have already said– is quite marginal in Basque. An exhaustive examination of the reasons lying behind absolutive marking of first and second person objects in (certain) ditransitive predicates is left for further research. For the purposes of the discussion, it is important to emphasize that marking first and second person objects absolutive does not repair the PCC itself, as the finite verbal form can neither agree with an inherent dative and a first or second person absolutive at the same time (section 4.4).

⁹⁸This section deals exclusively with first and second person DOM objects, as third person objects are not targeted by the PCC. However, it is important to note that the consulted DOM speakers mark third person objects absolutive in ditransitive constructions. This is the case both when the inherent DP or PP-like dative is third person, and when it is first or second person. For a theoretical explanation of the absolutive marking of third person DOM objects in ditransitive contexts, see chapter 5 (section 5.4).

⁹⁹ Although in previous work (Odria 2014: 303, 306) I have mentioned that this is in general the first strategy among DOM speakers in ditransitive constructions, it should be noted that not all speakers prefer the absolutive marking for first and second person objects. Some of them prefer the first and second person object in ditransitive constructions to be marked dative rather than absolutive.

All in all, the absolutive marking of first and second person objects assimilates the pattern attested among these DOM speakers with that found among the rest of non-DOM speakers. Hence, the syntactic processes involved both by the effects as well as repairs of absolutive objects targeted by the PCC will not be discussed again in this section, given that these were already addressed in section 4.5. Therefore, in the next section, I turn to explore the strategies used by those DOM speakers that mark first and second person objects dative in constructions targeted by the PCC.

4.6.2. PCC repairs combining DOM objects with goal datives

In order to avoid the effects of the PCC triggered by goal datives, three main repair strategies have been gathered among the consulted DOM speakers. The first strategy consists of turning the goal dative into a non-agreeing PP. The second one consists of preventing first and second person arguments from appearing as direct objects by embedding them in a noun or nominalized clause. To finish, the third one substitutes the dative argument by a locative PP. The first strategy is discussed in section 4.6.2.1, the second in 4.6.2.2 and the third in 4.6.2.3.

4.6.2.1. The PP repair strategy

With the aim at avoiding the ungrammaticality in examples like (38) –built up with *sasldu* ‘sell’, many DOM speakers allow double dative construction where the agreement complex agrees with the DOM object and the goal is left as a non-agreeing PP –Arraztio 2010, Fernández & Rezac 2010 2106, Odria 2014).¹⁰⁰ Consider, for instance, the examples in (42). In (42), the only internal argument agreeing with the finite verbal form is the first (42a) or second (42b) person DOM object. Besides, as was the case with canonical absolutes (section 4.5), in (42) we see that the first or second person object is preferably placed before the goal dative.¹⁰¹

¹⁰⁰ Yet, although allowing the double dative construction with the first person DOM object, some speakers prefer the second person object to be marked absolutive instead of dative.

¹⁰¹ Albizu (1997a: 38) observes that some speakers can also have the repair strategy in (i), where the finite verbal form agrees with the direct object by means of dative markers, but the object is instead marked absolutive, as in Standard Basque.

- (42) a. Traidore-ek ni-ri etsaia-ri saldu didate
 traitors-E i-D enemy-D sell AUX[1sgD-3plE]
'The traitors have sold me to the enemy.'
- b. Traidore-ek zu-ri etsaia-ri saldu dizute
 traitors-E you-D enemy-D sell AUX[2sgD-3plE]
'The traitors have sold you to the enemy'

In double dative constructions like those in (42), some speakers prefer to have the DOM object elided, having a single pronounced dative argument in the clause, which is always the goal. Others prefer the goal dative to occur right after the verb, as in (43), gathered by Arraztio (2010) in Araitz-Betelu and analyzed by Fernández & Rezac (2010: 137 2016: 122).

- (43) Deabru-ak ne-i saldu diate etsia-i
 demon-E I-D sell AUX[1sgD-3plE] enemy-D
'The demons have sold me to the enemy.'

The preference for placing the goal after the verb may be due parsing difficulties, as having two datives close to each other may be hard to process for some speakers –see also Ortiz de Urbina (2003: 608) for similar facts in ditransitive causatives (section 4.6.4).

The DOM speakers allowing double dative constructions like those in (42) and (43) resort to the same PP repair strategy presented in the previous section. The only difference is that, contrary to the absolutive, first and second person objects bear dative marking in this case. In spite of that, the repair proceeds as depicted in section 4.5. Let us recapitulate its main aspects focusing first on non-PCC contexts and then on those affected by the PCC.

Building on Ormazabal & Romero's derivational analysis (1998), I argue that in normal –i.e., non-PCC– circumstances the P head of the originally PP goal incorporates into V,

-
- (i) Azpisapo-ek ni etsaia-ri saldu didate
 traitor-E I.A enemy-D sell AUX[1sgD-3plE]
'The traitors have sold me to the enemy.'

This is also the case for a consulted DOM speaker. Such a case-agreement mismatch is not very common among DOM speakers. Therefore, I leave the analysis of constructions like (i) for future investigations.

bringing thereby a [person] probe to v . As a result of the incorporation, v attracts the [person] bearing goal from the PP to [Spec, ApplP] and the goal ends up receiving inherent dative Case from Appl. Given that inherent datives have only their [person] features visible for clausal phi-probes, the goal Agrees defectively with v , and such an Agree relation enables the subsequent clitic doubling movement bringing the phi-features of the nominal to v . This would be the case if the object was third person and bore no more than [number] features like *liburua* ‘book’ in (44).

- (44) Miren-ek Jon-i liburua saldu dio
 Miren-E Jon-D book.A sell AUX[3sgA-3sgD-3sgE]
 ‘Miren has sold the book to Jon.’

Notwithstanding, as we have seen in sections 4.4 and 4.5, the derivation of goal datives in PCC contexts like (42) and (43) diverges in relevant aspects from that in neutral –i.e., non-PCC– ones. According to the Agree/Case approach, as first and second person DOM objects also bear [person] features, the derivation would crash if the goal moved to [Spec, ApplP] and thus Agreed with v in [person], because this would left the object unlicensed (Anagnostopoulou 2003, Béjar & Rezac 2003, Rezac 2007 2008ab 2009ab 2011). In line with the main insight in Ormazabal & Romeo (1998), I assume that in PCC contexts the movement from the P-construction to [Spec, ApplP] is in fact blocked by feature-relativized locality, as the first or second person object lying in between, bears [person] features too. For this reason, so as to repair the PCC effects that would arise by the transformation of the P-construction to the ApplP, the DOM speakers allowing sentences like (42) and (43) resort to the PP repair strategy (Rezac 2011). Such a strategy encompasses the addition of uninterpretable phi-features to the P head of the originally PP goal, activating its otherwise inactive Agree/Case locus. By doing so, the P head becomes a phasal head, and as a consequence, the nominal within it ends up being invisible for clausal Agree/Case loci. As this Agrees with the phi-probe in P, it receives inherent dative Case from P, and no P-incorporation takes place. As a consequence, without moving to [Spec, ApplP], no Agree relation holds between the goal and the v head. This allows the first and second person DOM object to Agree entirely with v , which results in a double dative construction bearing an agreement complex cross-referencing the DOM –and not the goal dative.

In section 4.5, we have seen that the PP repair strategy provides us additional evidence to corroborate the distinction between causee, experiencer and possessor DP datives from PP-like goals, since the so-called strategy is generally unavailable for the former. As I have already pointed out, this is straightforwardly explained by the presence or absence of the P head in their original syntactic configuration. Given that goals are generated as PPs, they already have a P head to which uninterpretable phi-features can be added. On the contrary, as causee, experiencer and possessors exhibit an original DP syntactic category, they bear no functional head able to host the added uninterpretable phi-features, and the PCC effects remain unsolvable.

Therefore, taking into account that the licensing of secondary predication has favored a DP syntactic category of DOM objects, these objects should neither be able to resort to the PP repair strategy, as they bear no P head whose inactive Agree/Case locus can be activated. Interestingly, this is in fact what we find in examples like (45). In (45), both the DOM and the goal are marked dative, but only the latter is coded by the finite verbal form. As expected, the result is ungrammatical for the consulted DOM speakers.

- (45) *Traidore-ek ni-ri/zu-ri etsaia-ri saldu diote
 traitors-E I-D/you-D enemy-D sell AUX[3sgD-3plE]
 ‘The traitors have sold me/you to the enemy.’

As in (42) and (43), (45) contains two dative arguments, the goal and the DOM object. However, contrary to (42) and (43), in this case it is the DOM object the one which is left as a non-agreeing PP and, as expected by its DP categorical source, this leads to a deviant result. As happens with the rest of DP datives, the DOM object bears no P head to which uninterpretable phi-features can be added, and as a result, there is no option for it to occur without triggering dative markers in the finite verbal form.

Double dative constructions are not very common in DOM varieties and Basque in general. As a matter of fact, with verbs like *deskribatu* ‘describe’, *gomendatu* ‘recommend’ or *aurkeztu* ‘introduce’, double dative constructions turn out to be rejected

by most of the consultants, and other strategies are employed in order to repair the so-called constarint.¹⁰²

4.6.2.2. Embedding first and second person objects within a noun or nominalized clause

PCC effects with verbs like *deskribatu* ‘describe’ and *gomendatu* ‘recommend’ can be avoided by resorting to independent paraphrases that maintain the meaning of the PCC-violating construction, yet without having direct objects of first or second person. This is what happens in (46), where first and second person objects are embedded within a nominalized clause.¹⁰³

- (46) a. Lagun-ek deskribatu diote polizia-ri
 friends-E describe AUX[3sgA-3sgD-3plE] póllice-D
 [nolakoa naizen/zaren]
 [how I/you am]
 ‘My/your friends have described to the police how I am/you are.’

Another way to avoid double dative constructions with *deskribatu* ‘describe’ is the one shown in (47), which substitutes the first or second person object by a noun like *nire/zure deskribapena* ‘my/your description’ using the verb *eman* ‘give’ instead of *deskribatu* ‘describe’.

- (47) Lagun-ek polizia-ri nire/zure deskribapena eman diote
 friends-E póllice-D my/your description give AUX[3sgA-3sgD-3plE]
 ‘Mt/your friends have given my/your description to the police.’

The tendency to prevent first or second person arguments from appearing as direct objects is also present with the verb *gomendatu* ‘recommend’, as another consultant

¹⁰² Only one of the consultants admits double dative constructions with *deskribatu* ‘describe’ and *gomendatu* ‘recommend’ and another one with *aurkeztu* ‘introduce’. As expected, the judgments of these two speaker are consistent with the DP vs. PP original category of DOM and goal objects, and double dative constructions are only allowed as long as the goal is left as a full PP and the agreement complex agrees only with the DOM object. When DOM speakers resort to the PP repair strategy, the repair is always applied to the goal dative, and not to the DOM object

¹⁰³ A consulted speaker adds that the sentence in (46) would be more natural if verbs like *esan* ‘say’ or *azaldu* ‘explain’ were used instead of *deskribatu* ‘describe’.

admits that a sentence like (48) would sound more natural than the double dative construction. In (48), the first person object is again embedded in a nominalized clause.

- (48) Lana ni-k egiteko gomendatu diote
 work.A I-E do.NOM recommend AUX[3sgA-3sgD-3plE]
 ‘They recommended (him/her) me to do the work.’

Embedding the first or second person object within a noun or nominalized clause is thus a valid strategy to avoid the PCC with verbs like *deskribatu* ‘describe’ and *gomendatu* ‘recommend’.

4.6.2.3. Substitution of the dative by a locative PP

Turning the goal into a locative PP is also a common strategy to avoid PCC effects with DOM objects. Depending on the meaning of the verb, the locative PP can mean either ‘in front of (someone)’ or ‘to (someone)’, the former involving an inesive postposition and the latter an allative one. As happens with the PP repair strategy turning the agreeing dative into non-agreeing, in these cases the first or second person object remains being dative, bearing dative case in the nominal and triggering dative markers in the finite verbal form. The inesive postposition is used to replace the dative goal of verbs like *deskribatu* ‘describe’ (49a), *aurkeztu* ‘introduce’ (49b), and as gathered by Beatriz Fernández (p.c.) in Dima Basque, *salatu* ‘report’ (49c).¹⁰⁴

- (49) a. Deskribatu didate/dizute poliziaren aurrean
 describe AUX[1sgD-3plE]/AUX[2sgD-3plE] in front of the police
 ‘They have described me/you in front of the police.’

¹⁰⁴ Other speakers find quite weird the present of a first or second person DOM object in the ditransitive configuration of *aurkeztu* ‘introduce’. In fact, if they heard an example like (i), they would understand that it is the director the one who is being presented, and not the first or second person. However, in that case they would commonly mark the director absolute instead of dative, as in (ii).

- (i) *Zuzendaria-ri aurkeztu didate/dizute
 boss-D introduce AUX[1sgD-3plE]/AUX[2sgD-3plE]
 ‘They have introduced me/you the boss.’
- (ii) Zuzendaria aurkeztu didate/dizute
 boss.A introduce AUX[3sgA-1sgD-3plE]/AUX[3sgA-2sgD-3plE]
 ‘They have introduced me/you the boss.’

b. Zuzendariaren aurrean aurkeztu didate/dizute
 in front of the boss introduce AUX[1sgD-3plE]/AUX[2sgD-3plE]
 ‘They have introduced me/you in front of the boss.’

c. Salatuoste poliziaren aurrean
 report.AUX[1sgD-3sgE] in front of the police
 ‘He/she has reported me in front of the police.’

Similar to (49), the goal can also be realized as an allative PP with verbs like *eroan/eraman* ‘carry’¹⁰⁵ (50), a verb that, generally speaking, does not allow double dative constructions.¹⁰⁶ The example in (50a) was provided by one of my consultants, (50b) and (50c) by a speaker from Araitz-Betelu (Arraztio 2010, Fernández & Rezac 2016: 122), and (50d) was gathered by Fernández & Rezac (2016: 122) in Dima Basque.

(50) a. Ni-k eraman-go dizut *irakaslea-ri/irakaslea-rengana
 I-E carry-FUT AUX[2sgD-1sgE] teacher-D/teacher-ALL
 ‘I will carry you to the teacher.’

b. Marta-k ne-i eaman dit zu-gana
 Marta-E I-D carry AUX[1sgD-3sgE] you-ALL
 ‘Marta has brought me to you.’

c. Marta-k eaman dizu zu-i ni-gana
 Marta-E carry AUX[2sgD-3sgE] you-D I-ALL
 ‘Marta has brought you to me.’

d. *Medikua-ri/mediku-gana eroan dotsu
 doctor-D/doctor-ALL carry AUX[2sgD-3sgE]
 ‘He/she has carried you to the doctor.’

¹⁰⁵ *Eroan* is used in western dialects, while *eraman* is preferred in central ones.

¹⁰⁶ A speaker from Araitz-Betelu is an exception in this regard (Arraztio 2010). This speaker allows the dative marking of the indirect object with a second person DOM object with the verb *eraman* ‘carry’ (i).

(i) Marta-k zu-i Ane-i eaman dizu
 Marta-E you-D Ane-D carry AUX[2sgD-3sgE]
 ‘Marta has carried you to Ane.’

As expected, in (i) it is the DOM object the one that is cross-referenced by the finite verbal form, and not the indirect object.

Of course, this is not only the situation of the repair using an allative PP for the goal (50). The same occurs with the PPs meaning ‘in front of’ in examples like (49), and nouns and nominalizations like those in (46), (47) and (48). All of them are common in non-PCC contexts too. Likewise, although –in spite of specific contexts– non-agreeing datives are exclusive of northeastern varieties, we see that when resorting to the PP repair strategy, DOM speakers employ a configuration that is independently attested in Basque.¹⁰⁷ Therefore, be it (i) by adding uninterpretable features to an inactive P head, (ii) by embedding the first or second person object in a noun or nominalized clause, or (iii) by simply merging the goal as a full locative PP, the PCC repairs give rise to constructions that are available in the language outside the environment affected by the constraint.

4.6.2.4. Interim summary

Overall, not all verbs in ditransitive constructions pattern always in the same way. For many speakers, the PP repair strategy leading to a double dative construction seems to be allowed only with the verb *saldu* ‘sell’. The PCC effects with other verbs like *deskribatu* ‘describe’, *gomendatu* ‘recommend’, *aurkeztu/presentatu* ‘introduce’, *salatu* ‘report’ and *eroan/eraman* ‘bring’ tend to be repaired by resorting to other strategies: either by embedding first and second person arguments in nouns or nominalized clauses, or by realizing the goal as a full locative PP. Be that as it may, all the repairs presented in this section involve constructions that are independently available in Basque (Rezac 2011).

4.6.3. No PCC repairs combining DOM objects with DP datives

As happens with goal datives, first and second person DOM objects are equally affected by the PCC when they occur along with a causee, experiencer or possessor DP dative. Moreover, as predicted by the DP vs. PP base-generated distinction, when PCC effects that target DOM objects are triggered by one of those DP datives, DOM speakers have generally no option to repair the derivation by leaving one of the datives without dative

¹⁰⁷ Outside northeastern Basque, non-agreeing datives are also found in ditransitive causative constructions as well. See section 4.7 for further details on this kind of configuration.

markers in the finite verb. Note that this was also the case for non-DOM speakers that mark first and second person objects absolutive; PCC effects were only avoidable when the dative triggering them was generated as a PP (section 4.5) (Albizu 1997a 2001, Rezac 2009b 2011). In what follows, I analyze one by one the combination of DOM objects with each of these DP datives.

First, as with goals, PCC effects ensue when combining a first or second person DOM object with a causee dative. This can be observed in (53).

- (53) a. *Traidore-ek etsaia-i ni-ri saldu-arazi didaote
 traitors-E enemy-D I-D sell-CAUS AUX[1sgD-3sgD-3plE]
 ‘The traitors have made the enemy sell me.’
- b. *Traidore-ek etsaia-i zu-ri saldu-arazi dizuote
 traitors-E enemy-D you-D sell-CAUS AUX[2sgD-3sgD-3plE]
 ‘The traitors have made the enemy sell you.’

Contrary to what happens with goals, in this case it is generally impossible for the causee to resort to the PP repair strategy. As illustrated by the examples in (54), the causee must trigger dative markers in the finite verbal form.¹⁰⁸

- (54) a. *Traidore-ek etsaia-i ni-ri saldu-arazi didate
 traitors-E enemy-D I-D sell-CAUS AUX[1sgD-3plE]
 ‘The traitors have made the enemy sell me.’

¹⁰⁸ One of the consultants is doubtful with the examples in (54), as he does not find them completely ungrammatical. However, it should be noted that this speaker admits that causative constructions are not productive in his informal speech, which makes it more difficult to test the behavior of DOM objects in these configurations –this is also the case for other speakers. These speakers prefer using non-restructuring sentences like ‘someone has ordered someone to do something.’

Besides, similar doubts are attested among some speakers in another causative construction involving the verb *busti* ‘wet’ (i). In this case, although some of the consultants consider the double dative construction to be ungrammatical, some others take it as just as quite marked.

- (i) ??/*Mikel-i ni-ri busti-arazi diote
 Mikel-D I-D wet-CAUS AUX[3sgD-3plE]
 ‘They have made Mikel wet me.’

Thus, in order to obtain a clearer picture of the PCC in causatives involving DOM objects, more examples should be tested in future research.

b. *Traidore-ek etsaia-i zu-ri saldu-arazi dizute
 traitors-E enemy-D you-D sell-CAUS AUX[2sgD-3plE]
'The traitors have made the enemy sell you.'

Likewise, as happens with absolutive objects, generally speaking, the DOM object can neither be left without agreeing with the finite verbal form. Consider now (55).

(55) *Traidore-ek etsaia-i ni-ri/zu-ri saldu-arazi diote
 traitors-E enemy-D I-D/you-D sell-CAUS AUX[3sgD-3plE]
'The traitors have made the enemy sell me.'

As I have already pointed out, the impossibility to repair the ungrammaticality in (55) is straightforwardly derived from the DP syntactic category of both DOM and causee datives. DOM and causee datives are generated as DPs, hence, they bear no functional head to which uninterpretable phi-features can be added in order to provide them an independent Agree/Case locus. As a consequence, none of the datives can occur as a PP, and given that both of them Agree with ν , the constraint happens to be irreparable. As expected, the same result is obtained with the combination of a DOM object with a possessor dative.

Possessor datives trigger PCC effects when they occur together with a first or second person DOM object, as in (56).

(56) a. *Ama-ri ni-ri esku-etatik kendu didaote
 mother-D I-D arms-ABL take away AUX[1sgD-3sgD-3plE]
'They have taken me away from my mother's arms.'
 b. *Ama-ri zu-ri esku-etatik kendu dizuote
 mother-D you-D arms-ABL take away AUX[2sgD-3sgD-3plE]
'They have taken you away from your mother's arms.'

Besides, as predicted by the DP character of both possessor and DOM objects, the constraint cannot be repaired: neither the possessor (57) nor the DOM object (58) can be left as a full PP without triggering dative markers.

(57) a. *Ama-ri ni-ri esku-etatik kendu didate
 mother-D I-D arms-ABL take away AUX[1sgD-3plE]
'They have taken me away from my mother's arms.'

- b. *Ama-ri zu-ri esku-etatik kendu dizute
 mother-D you-D arms-ABL take away AUX[2sgD-3plE]
'They have taken you away from your mother's arms.'
- (58) *Ama-ri ni-ri/zu-ri esku-etatik kendu diote
 mother-D I-D/ you-D arms-ABL take away AUX[3sgD-3plE]
'They have taken me/you away from my/your mother's arms.'

Ultimately, the examples in (59) illustrate that the combination of an experiencer with a first or second person DOM object is also affected by the PCC.

- (59) a. *Jon-i ni-ri harroa iruditzen zaiot
 Jon-D I-D arrogant look like AUX[3sgD-1sgD]
'I look arrogant to Jon.'
- b. *Jon-i zu-ri harroa iruditzen zaiozu
 Jon-D you-D arrogant look like AUX[3sgD-2sgD]
'You look arrogant to Jon.'

Again, as both the experiencer and the DOM object are first merged as DPs none of them can occur as a non-agreeing PP. Thus, given that both of them intend to Agree with *v*, the derivation crashes. Observe the ungrammatical examples in (60) and (61). In (60) the experiencer is left as a non-agreeing PP and the finite verbal form agrees with the DOM object. On the contrary, in (61) it is the DOM object the one which is left as a non-agreeing PP and the verbal form agrees with the experiencer dative.

- (60) a. *Jon-i ni-ri harroa iruditzen zait
 Jon-D I-D arrogant look like AUX[3sgA-1sgD]
'I look arrogant to Jon.'
- b. *Jon-i zu-ri harroa iruditzen zaizu
 Jon-D you-D arrogant look like AUX[3sgA-2sgD]
'You look arrogant to Jon.'
- (61) *Jon-i ni-ri/zu-ri harroa iruditzen zaio
 Jon-D I-D/ you-D arrogant look like AUX[3sgA-3sgD]
'I/you look arrogant to Jon.'

All in all, DOM objects are generally incompatible with causee, experiencer and possessor datives, as being originally DPs, none of them can occur as a PP, without triggering dative markers in the finite verbal form.

4.6.4. Interim summary

By analyzing the behavior of DOM objects with respect to PCC effects, in this section we have reached to two main conclusions. On the one hand, the fact that the PCC affects the Case licensing of DOM objects indicates that these objects enter into an Agree relation with the ν head. On the other hand, the PP repair avoiding PCC effects with DOM datives applies exclusively to the goal argument. DOM, causee, experiencer, and possessor datives are generated as DPs. As a result, the repair strategy turning a defective PP into a full PP is generally not tenable for them.

To finish, it is important to note that the data in this section have ultimately discarded the possibility to link the deviance of PCC-affected examples exclusively to the presence of two dative markers in the agreement complex. If this was so, such ungrammaticality should disappear once the finite verbal form bore a single dative marker. However, in section 4.6.3 we have seen that even though the finite verb agrees with one of the dative arguments, double dative constructions combining a DOM object with a causee, experiencer or possessor dative are still ungrammatical. This proves once again that the constraint is syntactic –rather than morphological– in nature. Thus, the deviance in PCC-affected examples must fundamentally be due to the need for first or second person DOM objects to Agree with ν in [person] and [number], as the DP dative is also required to Agree defectively with ν in [person].

4.6.5. A note on double dative constructions

In sections 4.6.3 and 4.6.4, I have demonstrated that with DOM objects double dative constructions are only possible if the object is combined with a PP-like goal that can resort to the PP repair strategy. In this section I focus on ditransitive causative constructions involving a causee and a goal dative. On the one hand, I show that the causee always appears triggering dative markers in the finite verbal form, and as expected, only the goal can occur as non-agreeing (Deustuko Hizkuntzalaritza Mintegia 1989, Albizu 2001, Ortiz de Urbina 2003a, Odria 2014). On the other hand, I point out that some speakers find ditransitive causatives with possessor datives less grammatical than those involving a goal dative, an intuition also shared by Duguine (2913). Considering the DP nature of causee datives, this implies that, at least for these

speakers, double dative constructions in causative configurations are preferable if the dative combining with the causee is originally a PP rather than a DP dative. Before examining the behavior of possessors in causative constructions, let us first focus on ditransitive causatives involving a goal dative.

As was first noted by Deustuko Hizkuntzalaritza Mintegia (1989: 106-107), causative constructions involving ditransitive predicates like *aitortu* ‘confess’, *saldu* ‘sell’ or *eman* ‘give lead to double dative constructions. This is illustrated in the examples in (62). (62a) and (62b) are due to Euskaltzaindia (1987: 62) and (62c) to Ortiz de Urbina (2003a: 608).

- (62) a. Apeza-ri aitor arazi didate bekatu handia
 priest-D confess CAUS AUX[3sgA-1sgD-3plE] the great sin.A
‘They have made me confess the great sin to the priest.’
- b. Salgai nuen landa Mikel-i sal-erazi
 on-salehad land land.A Mikel-D sell-CAUS
 didate guraso-ek [ni-ri]
 AUX[3sgA-1sgD-3plE] parents-E I-D
‘My parents have made me sell to Mikel that pot of land I had on sale.’
- c. Eliza-k pobre-ei dirua eman-erazten
 church-E poor-D money.A give-CAUS
 digu (gu-ri)
 AUX[3sgA-1plD-3sgE] we-D
‘The Church makes us give money to the poor.’

Along with ditransitive predicates, bivalent unergatives like *jarraitu* ‘follow’, *begiratu* ‘look at’ and *itxaron* ‘wait for’ result in a double dative construction too. This is illustrated in (63a) (Deustuko Hizkuntzalaritza Mintegia 1989: 107)), (63b) and (69c) (Ortiz de Urbina 2003a: 609).

- (63) a. Taxista-ri kotxe bat-i jarraitu-erazi diote
 taxi-D car one-D follow.CAUS AUX[3sgD-3plE]
‘They have made the taxi driver follow a car.’
- b. Aurpegia-ri begira-erazi zidan
 face-D look at-CAUS AUX[1sgD-3sgE]
‘He made me look at his face.’

c. Anaia-ri itxaron-erazi didate
 brother-D wait for-CAUS AUX[1sgD-3plE]
'They have made me wait for my brother.'

The examples in (62) and (63) contain two dative arguments: the causee and the goal. However, only the causee is cross-referenced by the finite verbal form; the goal appears as a non-agreeing PP dative. Recall that, as for bivalent unergative predicates, this supports the claim that their dative objects are generated as PPs, as predicated by the licensing of secondary predication in chapter 3 (section 3.3.3).

According to Deustuko Hizkuntzalaritza Mintegia (1989: 106), this kind of double dative construction is quite marginal in Basque, as when both the causee and the goal are third person, it may be difficult to distinguish which of them is the causee and which the goal. Such a parsing difficulty is illustrated in the examples in (64). (64a) is given by Euskaltzaindia (1987: 62) and (64b) by Ortiz de Urbina (2003a: 608).

- (64) a. ?Aita-ri liburua eman-arazi diote Joxe-ri
 fathr-D book.A give-CAUS AUX[3sgA-3sgD-3plE] Joxe-D
'They made father/Joxe give the book to father/Joxe.'
- b. ??Guraso-ek Mikel-i Jon-i etxea sal-erazi diote
 parents-E Mikel-D Jon-D house sell-CAUS AUX[3sgA-3sgD-3plE]
'His parents made Mikel/Jon sell the house to Mikel/Jon.'

Crucially, the potential ambiguity in examples like (64) disappears when the person specification of the causee and goal is different, as in the examples in (65) (Deustuko Hizkuntzalaritza Mintegia 1989: 107). The goal is third person in both (65a) and (65b), but the causee is first person in (65a) and second person in (65b). As the finite verb agrees with the causee, this allows distinguishing which of the dative arguments belongs to the causee and which to the goal.

- (65) a. Apaiza-k pobre-ei dirua eman-erazi
 priest-E poor-D money.A give-CAUS
 zidan
 AUX[3sgA-1sgD-3sgE]
'The priest made me give money to the poor.'
- b. Ogasuna-ri dirua eman-eraziko dizute
 tax office-D money.A give-CAUS AUX[3sgA-2sgD-3plE]
'They will made you give money to the tax office.'

Likewise, Ortiz de Urbina (2003a: 609) adds that the potential ambiguity in sentences like (64) can also be avoided by making certain changes in word order. Based on an example from Lekeitio Basque (Hualde et al. 1994: 176) (66), this author claims that the first dative to the left of the verb is interpreted as the goal.

- (66) Gorka-ri maixua-k Edurne-ri liburua emon eraiñ
 Gorka-D teacher-D Edurne-D book.A give CAUS
 eutzan
 AUX[3sgA-3sgD-3sgE]
 ‘The teacher made Gorka give the book to Edurne.’

In line with the description made by Deustuko Hizkuntzalaritza Mintegia (1989) and Ortiz de Urbina (2003a), the speakers consulted in this survey also allow double dative constructions in ditransitive causative constructions like (67).¹⁰⁹ The causee is first person in (67a), second person in (67b) and third person in (67c), while the goal is third person in the three examples. As expected by the DP vs. PP original distinction, the agreement complex cross-references the causee dative.

- (67) a. Miren-ek (ni-ri) 50 euroak Leire-ri itzuli-arazi
 Miren-E I-D 50 euros.A Leire-D give back-CAUS
 dizkit
 AUX[3plA-1sgD-3sgE]
 ‘Miren has made me give the 50 euros back to Leire.’
- b. Miren-ek (zu-ri) 50 euroak Leire-ri itzuli-arazi
 Miren-E I-D 50 euros.A Leire-D give back-CAUS
 dizkizu
 AUX[3plA-2sgD-3sgE]
 ‘Miren has made you give the 50 euros back to Jon.’
- c. Miren-ek Jon-i 50 euroak Leire-ri itzuli-arazi
 Miren-E Jon-D 50 euros.A Leire-D give back-CAUS
 dizkio
 AUX[3plA-3sgD-3sgE]
 ‘Miren has made Jon give the 50 euros back to Leire.’

¹⁰⁹ Although grammatical, the examples in (67) entail a quite complex processing for many of the consulted speakers. These speakers prefer to replace the causative construction by a nominalization (i).

- (i) Miren-ek Jon-i esan dio Leire-ri 50 euroak buelta-tzeko
 Miren-E Jon-D say AUX[3sgA-3sgD-3sgE] Leire-D 50 euros.A give back-NOM
 ‘Miren has said to Jon to give back the 50 euros to Leire.’

As illustrated by all the examples in this section, double dative constructions in ditransitive causatives bear a single dative marker in the finite verbal form and such a marker is always linked to the causee. As illustrated by (68), the finite verb in causative constructions can never code the goal (Deustuko Hizkuntzalaritza Mintegia 1989: 107)

- (68) *Ni-ri guraso-ek Mikel-i etxea saldu-erazi diote
 I-D parents-E Mikel-D house.A sell-CAUS AUX[3sgA-3sgD-3plE]
 'My parents have made me sell the house to Mikel.'

As it was the case with double dative constructions involving a DOM and a goal dative, the ungrammaticality in (68) is predicted by the DP syntactic nature of the causee, which contrasts with the PP character of the goal. In ditransitive causative constructions, the causee is generated as a DP in [Spec, ApplP] and receives inherent dative Case from Appl. Being covered within a KP, it Agrees defectively in [person] with *v* and this enables subsequent clitic doubling leading to dative markers in the finite verbal form. The goal dative is conversely generated as a PP in the complement position of V. In a ditransitive construction, the P head of the goal would incorporate into V, attracting the goal to [Spec, ApplP]. However, in this case the presence of the causee in [Spec, ApplP] blocks the movement of the goal, as it was the case with first or second person objects in PCC contexts. Therefore, in order to solve the ungrammaticality that would yield if the goal moved from its base position, the PP repair strategy (Rezac 2011) applies to the goal and the Agree/Case locus in P turns out to be activated with uninterpretable phi-features. Consequently, the defective PP dative turns into a full PP and, as it is invisible to clausal Agree/Case loci, the goal receives inherent Case from P and shows up without triggering dative markers in the agreement complex. This proves that the PP repair strategy involving the activation of an Agree/Case locus is not exclusive to the PCC and that the PCC groups with other problems of Agree/Case licensing (Rezac 2011: 244).

At this point, it is worth mentioning that some of the consulted speakers that allow double dative constructions in causatives with a goal dative find the same configuration a bit degraded when the causee combines with a possessor dative. Consider the

examples in (69) and (70), where the finite verbal form agrees with the causee and the possessor occurs as a non-agreeing PP.^{110 111}

- (69) a. (?/??) (Ni-ri) ama-ri umea esku-etatik kendu-arazi
 I-D mother-D child.A arms-ABL take away-
 CAUS
 didate
 AUX[3sgA-1sgD-3plE]
 Lit. 'They have made me take away the child to his/her mother from her arms.'
- b. (?/??) (Zu-ri) ama-ri umea esku-etatik kendu-arazi
 you-D mother-D child.A arms-ABL take away-CAUS
 dizute
 AUX[3sgA-2sgD-3plE]
 Lit. 'They have made you take away the child to his/her mother from her arms.'
- c. (?/??) Jon-i ama-ri umea esku-etatik kendu-arazi
 Jon-D mother-D child.A arms-ABL take away-CAUS
 diote
 AUX[3sgA-3sgD-3plE]
 Lit. 'They have made Jon take away the child to his/her mother from her arms.'
- (70) a. (?/??)(Ni-ri)Jon-i kotxea garbitu-arazi didate
 I-D Jon-D car.A wash-CAUS AUX[3sgA-1sgD-3plE]
 Lit. 'They have made me wash the car to Jon.'

¹¹⁰ One of the consulted speakers adds that sentences like (69) and (70) can be repaired by a genitive phrase, as in (i) or (ii).

- (i) Umea ama-ren esku-etatik kendu-arazi didate
 child.A mother-GEN arms-ABL take away-CAUS AUX[3sgA-1sgD-3plE]
 'They have made me take away the child from his/her mother's arms.'
- (ii) Jon-en kotxea garbitu-arazi didate
 Jon-GEN car.A wash-CAUS AUX[3sgA-1sgD-3plE]
 'They have made me wash Jon's car.'

¹¹¹ Some speakers accept sentences like (69), but not those in (70). This may be due to the fact that the dative in (69) is interpreted as a source that could behave akin to a goal in this regard. In contrast, in (70) the possessor dative cannot be considered a source. In this case, the dative is rather a possessor or an affected/interest dative, as being the owner of the car the cleaning of his car benefits him. This may be the reason for some speakers to allow (69) and not (70).

b. (?/??)(Zu-ri) Jon-i kotxea garbitu-arazi dizute
 you-D Jon-D car.A wash-CAUS AUX[3sgA-2sgD-3plE]
 Lit. 'They have made you wash the car to Jon.'

c. (?/??)Miren-i Jon-i kotxea garbitu-arazi diote
 Miren-D Jon-D car.A wash-CAUS AUX[3sgA-3sgD-3plE]
 Lit. 'They have made Miren wash the car to Jon.'

Therefore, for some speakers, double dative constructions are preferable if one of the datives is generated as a PP. Like DOM objects, possessors are generated as DPs. Hence, for these speakers, these datives are unable to be left as non-agreeing datives as the PP repair strategy is not accessible to them.

The contrast between goals and possessors in ditransitive causative constructions is observed by Duguine (32013) too. According to Duguine, while the combination of a causee with a goal dative is perfectly grammatical (71a), the combination of a causee with a possessor happens to be less acceptable. This is illustrated by the contrast in (71a) (Duguine 2013: 264) and (71b) (Duguine 2013: 271). Contrary to (71a), which involves a goal dative, the combination of a causee with a possessor dative in (71b) is considered by Duguine as grammatical or mildly ungrammatical.

- (71) a. Eliza-k fededun-ei dirua pobre-ei emana-razten
 church-E believers-D money.A poor-D give-CAUS
 die
 AUX[3sgA-3plD-3sgE]
 'the Church makes the believers give money to the poor.'
- b. ?(Generala-k) (ni-ri) Jon-i besoa hauts-arazi
 general-E I-D Jon-D arm.A break-CAUS
 dit
 AUX[3sgA-1sgD-3sgE]
 Lit. 'The general made me break the arm to Jon.'

In addition, Duguine (2013: 269, 271) adds that the contrast in (71) seems to be sharper in interrogative contexts like (72). This author explains that comparing to goals (72a), wh-movement of the possessor (72b) is highly deviant in causative constructions.

- (72) a. Nor-i eman-arazten dizu (zu-ri)
 who-D give-CAUS AUX[3sgA-2sgD-3sgE] You-D
 dirua eliza-k?
 money.A church-E
 Lit. 'Who does the Church make give money?'
- b. ??Nor-i hauts-arazi dizute besoa
 who-D break-CAUS AUX[3sgA-2sgD-3plE] arm.A
 (haiek) (zu-ri)?
 they.E you-D
 'Who did they make you break the arm (of)?'

All in all, Duguine's observation reinforces the intuition shared by some of my consultants, as it claims that goals and possessors are not equally allowed to occur along with causee datives. Again, this is straightforwardly explained by the DP syntactic category exhibited by causee and possessor datives on the one hand and goal datives on the other.

Outside causative constructions, other kind of double dative constructions that have been gathered in the literature on Basque datives also point into the same direction, as all involve the combination of an agreeing possessor with a non-agreeing goal –see also Fernández (2010: 10). Etxepare (2014: 230), for instance, provides the double dative constructions in (73) –see also Etxepare & Oyharçabal 2009a: 156).

- (73) a. Hurbildu nion urrikalmenduz-ko seinalea
 approach AUX[3sgA-3sgD-1sgE]repentance-GEN signal.A
 ezpaineri (Etc, O, 164)
 lips-D
 'I approached him the signal for repentance to his lips.'
- b. Barnea-ri farrasta bat egiten dautzu-n
 interior-D impression one.A do AUX[3sgA-2sgD-3sgE]
 manu auhenezkoa
 order painful.A
 'The painful orders that make you a big impression inside.'

The examples in (73) involve a PP spatial dative combined with a possessor dative – which could also be regarded as an interest or affected dative. As expected by the DP

vs. PP original categorical contrast, it is the spatial dative the one which occurs without dative markers in the finite verb in both cases.¹¹²

Fernández & Ortiz de Urbina (2010: 24) provide a similar double dative construction involving again a possessor and a spatial PP dative. This is illustrated in (74).¹¹³

- (74) Hanka harkaitz bat-i lotu zidaten
 leg.A rock-D tie AUX[3sgA-1sgD-3plE]
 Lit. 'They tied me the leg to a rock.'

The example in (74) contains two datives, a spatial PP dative and a possessor, and the dative triggering dative markers in the finite verb is once again the possessor.

To sum up, in this section we have seen that double dative constructions involving a causee and a goal dative corroborate the DP categorical status of the former and the PP-like nature of the latter. As expected by its PP categorical source, I have shown that only the goal occurs as non-agreeing, and that the causee always appears with dative markers in the finite verbal form. Likewise, I have pointed out that some speakers consider ditransitive causatives involving a possessor datives a bit degraded in comparison to ditransitive causatives containing a goal dative, an intuition also shared by Duguine (2013). This is easily captured by the distinct original category of goals and possessors. As only goals are generated as PPs, for these speakers it is more difficult to have a possessor that does not trigger dative markers in the finite verbal form.

In addition, the data in this section have proved that, apart from PCC contexts, the PP repair strategy is independently available in double dative constructions where [Spec, ApplP] is already filled by a DP dative. Besides, as for the dual analysis of dative

¹¹² Based on examples like (73), Etxepare (2014: 230) argues for a non-derivational analysis of Basque datives where agreeing and non-agreeing datives are first merged in different structural positions. Etxepare claims that if agreeing datives were derived from non-agreeing ones, it would be unexpected for both datives to co-occur in a single clause. Notwithstanding, this does not affect the validity of our analysis, as possessor and interest/affected datives like those in (73) are not derived from a lower P-construction. Instead, I argue that these datives enter the derivation directly in [Spec, ApplP] and that the derivational approach only accounts for agreeing goal datives.

¹¹³ The example in (74) belongs to a fragment of the lyrics of the song *Txori Tikia* by Benito Lertxundi.

arguments, double dative constructions indicate that datives should not only be distinguished by their original DP vs. PP syntactic category. In addition to the categorical distinction, each of them should also be generated in a different position in order to be compatible in double dative constructions. If both DP and PP-like datives were generated in the same syntactic configuration, double dative constructions should not be possible.

4.7. A CLITIC DOUBLING ANALYSIS FOR THE DATIVE MARKERS IN INHERENT DATIVES

In section 4.4, I have pursued the idea that, although being generated in different configurations, all agreeing datives end up in [Spec, ApplP]. PP datives reach that position by internal merge and DP datives by external merge. Once in [Spec, ApplP], Appl assigns dative Case to all of them, turning the DP nominal into a KP, an opaque domain for Agree/Case purposes (Rezac 2008a). The dative KP enters into a non-valuing –i.e., defective– [person] Agree relation with v , leading thereby to PCC effects if the direct object is first or second person.

Having explained the origin of the dative case marker in the nominal, the present section is devoted to explore the nature of the dative markers in the finite verbal form. As noted at the beginning of section 4.5, I take the dative markers in inherent datives to correspond to clitic markers, as agreement markers arise as a consequence of a valuing Agree relation. This section attempts to justify the hypothesis that dative markers in the finite verbal form reflect the movement of a clitic head bringing the phi-features of the nominal to v , as proposed in different terms by Rezac (2006 2007 2008b 2011), Rezac et al. (2014), Etxepare (2006 2014), Arregi & Nevins (2008 2012) and Preminger (2009 2014). In 4.7.1, I sketch out the main aspects of the clitic doubling analysis I propose for the dative markers, and 4.7.2 and 4.7.3 discuss two pieces of evidence that support such an analysis. The former concerns the intervention by the dative argument in restructuring unaccusative modal constructions (Albizu 2001, Albizu & Fernández 2002 2006, Ortiz de Urbina 2003b, Goenaga 2006, Rezac et al. 2014) and the latter the nature of the pro_{arb} causee in impersonal causative constructions (Albizu 2001, Ortiz de Urbina

2003a). As we will see, both of them hold a clitic doubling analysis involving the movement of a clitic head to [Spec, ν P] before attaching to ν .

The analysis I propose in this section is particularly similar to that proposed by Rezac (2008a 2011), who contends that Basque dative agreement may be analogous to Romance clitic doubling –i.e., *à la* Anagnostopoulou (2003). On the one hand, Rezac (2011: 246) assumes that (i) the clitic generates together with the doubled dative nominal, (ii) it moves to the neighborhood of ν /T through the clausal Agree/Case system and from there (iii) it adheres to the agreement complex. On the other hand, Rezac (2011: 107) claims that dative clitics can originate either in the applicative or prepositional construction and pass through a high A-position between VP and ν . Rezac’s A-position may correspond to our [Spec, ApplP], as agreeing datives merge externally or internally to that position before undergoing clitic movement to [Spec, ν P].

4.7.1. Main properties of the clitic doubling in inherent datives

As depicted in section 4.4, the DP nominal in [Spec, ApplP] receives inherent dative Case from Appl, turning the DP nominal into a KP. KP corresponds to a ‘big DP’ (Torrego 1992, Uriagereka 1995) with an adjoined D clitic head which can access the features of the DP –in this case, KP– it doubles. Given that clitics are morpho-syntactically and morpho-phonologically defective, I assume that the D head leaves its original position in the KP to search for a functional head bearing a phi-probe as a host (Rezac 2008a 2011, Nevins 2011). Partly based on Cardinaletti & Starke (1999), Rezac (2011: 155-159) regards clitic heads as being syntactically Case-deficient and prosodically Σ -deficient.¹¹⁴ Hence, as phases are complete domains for Case and Σ -licensing, deficient dative clitics attach into a phase-head –i.e., a functional head bearing a phi-probe– in order to satisfy their Case and Σ -licensing.

¹¹⁴ The fact that clitics are Case deficient is also claimed by Roberts (2010) and Nevins (2011).

As clitic doubling to a given head depends on previous Agree with that head, I consider ν to be the head that acts as a host for the defective D head.¹¹⁵ More concretely, assuming that clitic doubling involves the movement of a clitic head to the specifier of the functional head with which it Agrees (Matushansky 2006, Nevins 2011, Harizanov 2014, Kramer 2014), I argue that in Basque the D clitic head doubling inherent datives moves to [Spec, ν P]. Once in that position, the D head attaches to ν by means of Matushansky's (2006) m-merger, a mechanism that re-brackets a head and its specifier to constitute a new complex head (Nevins 2011, Rezac 2011, Harizanov 2014, Kramer 2014). Matushansky analyzes head movement decomposed into two main steps: (i) the movement to the specifier of the attracting head –which takes place in syntax; and (ii) the combination of the moved specifier and the attracting head –i.e. m-merger, held in morphology.¹¹⁶ M-merger is thus the morphological operation that combines a head with the moved head in its specifier, and in the specific case of cliticization, involves the post-syntactic morphological attachment of the moved pronoun to a functional head like ν or T. In particular, Matushansky (2006: 84-86) points out that cliticization involves m-merger with phrasal movement, as the moved element –i.e., the clitic– is simultaneously a head and a maximal projection; it moves as a maximal projection, but adjoins as a head.

¹¹⁵ For accounts claiming that clitic doubling is contingent on Agree, see Anagnostopoulou (2003), Béjar & Rezac (2003), Boeckx & Gallego (2008), Rezac (2008a 2011), Roberts (2010), Nevins (2011), Preminger (2014), Harizanov (2014) and Kramer (2014).

¹¹⁶ Matushansky (2006) adds that the movement to the specifier of the attracting head is identical for both head and phrasal movement, and the same claim is made by Roberts (2010) too. The difference between Matushansky's and Roberts's analysis is that Matushansky argues for an additional morphological operation adjoining the attracted and attracting heads –i.e., m-merger. On the contrary, Roberts proposes that cliticization is simply an Agree-based head movement that takes place in syntax, without resorting to additional morphological mechanisms. Roberts assumes that clitics are defective because they have just a subset of the features that are present on the probe they Agree with. Therefore, due to their defectiveness, incorporation –considered as regular movement– of the clitic goal into to the attracting phasal head probe takes place in order to value the uninterpretable features of the latter. As a result, the interpretable features on the defective goal end up being spelled-out on the probe.

The main steps of the clitic doubling analysis I propose are depicted in the syntactic trees in (75), (76) and (77). The tree in (75) illustrates that the pronoun-like D head is originated adjoined to the dative KP phrase, following partly Nevins' (2011) proposal, which is in turn a variant of the 'big DP' hypothesis (Torrego 1992, Uriagereka 1995). The tree in (76) shows that, after Agreeing in [person] with *v*, the D head moves to [Spec, *v*P], and (77) the m-merger operation that arises between D and *v*.¹¹⁷

¹¹⁷ The movement to [Spec, *v*P] could alternatively be analyzed as involving the whole DP dative, as has been argued by Harizanov (2014) and Kramer (2014) for the clitic doubling in Bulgarian and Amharic respectively. Contrary to the updated versions of the big DP hypothesis, these authors argue that no clitic head is adjoined to the doubled nominal in its original position and that it is the whole argument that moves to [Spec, *v*P] before undergoing m-merger with *v*. Hence, although in its original version Matushansky's (2006) m-merger is applied between a head and a non-branching maximal projection in its specifier, both Harizanov (2014) and Kramer (2014) consider it to be possible with branching nominals too. For them, no clitic is first merged as clitic, and the head that ends up being a clitic is generated as a full nominal. They claim that m-merger reduces the branching node in [Spec, *v*P] to its head, which is then adjoined to *v* forming a new complex head. The main motivation for their hypothesis comes from the fact that clitics expand the binding possibilities of doubled arguments by behaving as antecedents for binding purposes. Both in Bulgarian and Amharic the quantified object undergoing clitic doubling is able to bind into a pronoun that is structurally higher than the quantified object itself –see Harizanov (2014: 1052-1057) for indirect object pronouns Bulgarian and Kramer (2014: 605-606) for subject pronouns in Amharic. Therefore, these authors state that in order to affect the binding relations of a given DP, the clitic and the doubled DP should be linked by an A-chain involving the movement of the whole DP to [Spec, *v*P]. In Basque, when an inherent clitic doubled dative binds into an object pronoun the dative argument is always structurally higher than the bound object. This is illustrated in the contrast between (i) and (ii). Considering that the unmarked word order in ditransitive constructions is 'indirect object > direct object', (i) reflects the unmarked ordering and (ii) the marked one –see de Rijk (1969), Hualde (1988), Laka (1988 1993), Ortiz de Urbina (1989), Fernández (1997), Montoya (1998), Artiagoitia (2000), Elordieta (2001) and Oyharçabal (2010). The dative argument is doubled by a clitic in both (i) and (ii). However, the quantified element *bakoitza* 'each' in the dative indirect object can only bind into the pronoun *bere* in the direct object when the latter is in a structurally lower position, as in (i).

- | | | | | | |
|------|--|------------------------------------|------------------------------------|------|---------------------|
| (i) | Miren-ek _i | [emakume bakoitza-ri] _j | [bere] _{i/j} liburua | eman | dio |
| | Miren-E | women each-D | her book.A | give | AUX[3sgA-3sgD-3sgE] |
| | <i>'Miren has given each woman her book.'</i> | | | | |
| (ii) | Miren-ek _i | [bere] _{i/*j} liburua | [emakume bakoitza-ri] _j | eman | dio |
| | Miren-E | her book | woman each-D | give | AUX[3sgA-3sgD-3sgE] |
| | <i>'Miren has given her book to each woman.'</i> | | | | |

(75) The structure of the dative KP phrase (*à la* Nevins 2011: 952)

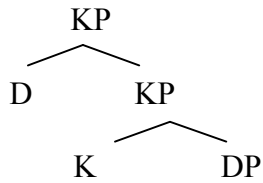

(76) The movement to [Spec, *v*P] of the D head (*à la* Matushansky 2006)

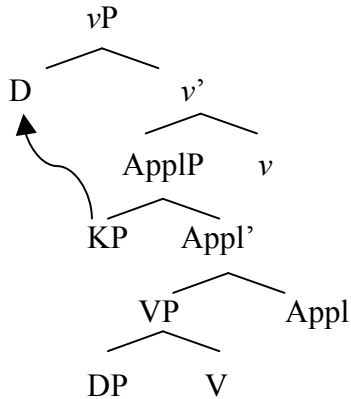

(77) M-merger of the D head with *v* (*à la* Matushansky 2006)

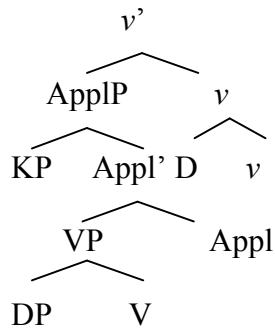

In the next two sections, I provide empirical evidence for the movement of the clitic D head to [Spec, *v*P], which will invariably point to a clitic doubling analysis of the Basque dative markers in the finite verbal form.

Therefore, in Basque it is impossible to test whether the quantified element in the dative argument binds the object from the position of the argument or the clitic doubling it. As a consequence, in absence of further evidence arguing for the movement of the whole argument, I analyze Basque dative clitic doubling as encompassing the movement of the clitic head, and not the whole doubled argument.

4.7.2. Dative intervention in restructuring unaccusative modal constructions

In this section, I analyze restructuring unaccusative modal constructions where agreeing datives intervene in the ergative marking of the unaccusative theme. In these constructions, the unaccusative theme that is generated within VP intends to Agree with T. However, as claimed by Rezac et al. (2014), the presence of a dative clitic in a position in between the theme and T impedes the Agree relation between them, and instead of the ergative, the theme ends up checking absolutive Case against *v*. Building on Rezac et al. (2014), in this section I develop the hypothesis claiming that it is the dative clitic in [Spec, *v*P] what impedes the unaccusative theme from receiving ergative Case. This will constitute the first piece of evidence in favor of an A-movement of the clitic head to [Spec, *v*P] in Basque agreeing datives.

Basque modal constructions are constituted with the verbs *behar* ‘need’ and *nahi* ‘want’. These verbs may take either a nominalized or a participial clause as complement (Ormazabal 1991, Albizu & Fernández 2002 2006, Etxepare 2003, Ortiz de Urbina 2003, Haddican 2005, Goenaga 2006). When the embedded clause is a nominalized clause, the modal construction behaves as bi-clausal and the reference of the main and embedded subjects happens to be different, as in (78).

- (78) a. Ni-k zu etxe-ra etor-tzea nahi dut
 I-E you.A house-ALL come-NOM want AUX[3sgA-1sgE]
‘I want you to come home.’
- b. Ni-k zuzendaria-k agiria lehenbailehen sina-tzea
 I-E boss-E document.A as soon as possible sign-NOM
 need
behar dut
 need AUX[3sgA-1sgE]
‘I need the boss to sign the document as soon as possible.’

On the contrary, when the embedded clause is a participial clause, the modal construction involves restructuring and exhibits a monoclausal pattern; all the arguments embedded by the modal satisfy their Agree/Case requirements within the main clause. When this is so, the modal verbs *behar* ‘need’ and *nahi* ‘want’ make the clause behaves as transitive. As a consequence, regardless of the transitivity of the

embedded predicate, the subject is marked ergative and the transitive auxiliary **edun* ‘have’ is selected.¹¹⁸ When the restructuring modal takes an unaccusative predicate as complement, a transitive configuration emerges. The theme bears ergative rather than absolutive marking and the transitive auxiliary **edun* ‘have’ is selected instead of the intransitive *izan* ‘be’. This is illustrated in the contrast between (79a) and (79b) (Rezac, et al. 2014: 1309). The example in (79a) involves a simple unaccusative construction: the subject is marked absolutive and the auxiliary selected is *izan* ‘be’. On the contrary,

¹¹⁸ Modal verbs taking a participial clause do not involve restructuring in all Basque varieties. Many dialects tend to mark the unaccusative subject absolutive and select the intransitive auxiliary *izan* ‘be’ (Albizu & Fernández 2002 2006, Ortiz de Urbina 2003b, Goenaga 2006). Ortiz de Urbina (2003b: 310) reports that this is particularly common with *behar* ‘need’, and less widespread with *nahi* ‘want’. Observe, for instance, the examples in (i) and (ii), where the embedded predicates *abiatu* ‘set out’ (i) and *mintzatu* ‘talk’ (ii) require an intransitive frame of the whole clause (Ortiz de Urbina 2003b: 310). The subject is marked absolutive and the intransitive auxiliary *izan* ‘be’ is selected in both of them.

- (i) Huna, beraz, nola behar zaren abiatu. (Duv. L.L.:52)
 here therefore how need AUX[3sgA].comp set out
 ‘This is, therefore, how you should proceed.’
- (ii) Mintzatu nahi natzaizu (Ax. 1)
 speak want AUX[1sgA-2sgD]
 ‘I want to talk to you’

Albizu & Fernández (2006) refer to examples like (i) and (ii) as *transparent modal constructions*, because the modal construction is transparent to the transitivity of the embedded predicate. When the embedded predicate is unaccusative as in (iii), the embedded subject is marked absolutive and the auxiliary *izan* ‘be’ is selected. Contrarily, when the embedded predicate is transitive as in (iv), the embedded subject is marked ergative and the auxiliary **edun* ‘have’ is chosen. The example in (iii) is taken from Goenaga (2006: 399) and (iv) from Albizu & Fernández (2006: 75).

- (iii) Gaur garaiz erretiratu behar naiz
 today in time leave need AUX[1sgA]
 ‘Today I must leave early.’
- (iv) Ni bihar goiz altxatu behar naiz
 I-A tomorrow in time wakeup need AUX[1sgA]
 ‘Tomorrow I must wake up early.’

Given that the dative intervention that will be analyzed in this section affects exclusively the ergative marking of the embedded subject, in this section I will leave aside this kind of transparent modal construction.

(79b) includes the same unaccusative predicate *joan* ‘go’, but being covered within a modal construction, its subject is marked ergative and the transitive auxiliary **edun* ‘have’ is chosen instead.

- (79) a. Bertsolaria hurbildu da
 poet.A approach AUX[3sgA]
‘The poet has come closer.’
- b. Bertsolari-ek gehiago hurbildu behar dute
 poet-E more approach need AUX[3plE]
‘The poets must come closer.’

Rezac et al. (2014) explain the contrast in (79) by arguing that modal verbs make unaccusative constructions behave as transitive by adding the T functional head to the structure, assuming that T is the head responsible for checking ergative Case. Hence, in restructuring modal constructions, the unaccusative subject originated in the domain of *v* enters into an Agree relation with T, leading thereby to ergative marking as well as the transitive auxiliary **edun* ‘have’.

Crucially, in restructuring modal constructions, the Agree/Case relations change if the modal verb embeds a bivalent unaccusative predicate that contains an agreeing dative, as the presence of the agreeing dative implies an intransitive configuration. Consequently, instead of the ergative pattern that emerges with monovalent unaccusatives, the theme of bivalent unaccusatives checks absolutive Case and the intransitive auxiliary *izan* ‘be’ is in turn selected (Albizu 2001, Albizu & Fernández 2002 2006, Ortiz de Urbina 2003b, Goenaga 2006, Rezac et al. 2014). This is what happens in (80) (Rezac et al. 2014: 1309), where agreeing goal datives with unaccusative predicates like *hurbildu* ‘approach’ are only compatible with an intransitive frame.

- (80) a. Bertsolariak Miren-i gehiago hurbildu behar zaizkio
 poets.A Miren-D more approach nneed AUX[3plA-3sgD]
‘The poets must come closer to Miren.’
- b. *Bertsolari-ek Miren-i gehiago hurbildu behar diote
 poets-E Miren-D more approach need AUX[3sgD-3plE]
‘The poets must come closer to Miren.’

For the purposes of the discussion, it is worth noting that in bivalent unaccusatives both DP and PP-like datives cause blocking effects for the T-Agree relation of the theme argument. Along with goal datives like those in (80), experiencer and possessor DP datives also prevent the theme from Agreeing with the T head. Consider the examples in (81) and (82) (Rezac et al. 2014: 1309). The examples in (81) involve an experiencer and those in (82) a possessor, and ergative marking of the theme is ruled out in both of them.

- (81) a. Bertsolariak Miren-i gehiago gustatubehar
 poets.A Miren-D more like need
 zaizkio
 AUX[3plA-3sgD]
 ‘*Miren must like the poets more (The poets must please more to Miren)*’
- b. *Bertsolari-ek Miren-i gehiago gustatu behar
 poets.-E Miren-D more like need
 diote
 AUX[3sgD-3plE]
 ‘*Miren must like the poets more (The poets must please more to Miren)*’
- (82) a. Bankaria-ri orain erori behar zaizkio giltzak
 banker-D now fall need AUX[3plA-3sgD] keys.A
 lur-rera
 ground-ALL
 ‘*Now the banker’s keys must fall to the ground (For the thief to succeed as desired).*’
- b. *Bankaria-ri orain erori behar diote
 banker-D now fall need AUX[3sgD-3plE]
 giltz-ek lur-rera
 keys-E ground-ALL
 ‘*Now the banker’s keys must fall to the ground (For the thief to succeed as desired).*’

Following Albizu (2001: 59-63), Albizu & Fernández (2002) and Rezac et al. (2014: 1309), I assume that in bivalent unaccusatives, the dative interferes on the Agree relation between the theme and T. As a consequence, the theme Agrees with *v* and receives absolutive rather than ergative Case. Rezac et al. (2014) contend that this could be due to Relativized Minimality. In fact, it seems that the intervention of the dative argument arises because the dative –or a head linked to it– is placed in a position in between the theme and the T head –see also Albizu (2001) and Albizu & Fernández

(2002). Developing this last point, Rezac et al. (2014) assume that in Basque dative markers reflect clitic doubling and propose that the T-Agree relation with unaccusative themes is indeed blocked by the clitic that doubles the dative argument. Besides, given that T but not *v* is blocked by the dative, these authors put forth that the intervening dative clitic should be at the periphery of the participial clause, at [Spec, *v*P]. In what follows, I will try to justify such a claim, as it fits straightforwardly with our hypothesis arguing for an A-movement of the clitic head to [Spec, *v*P].

One of the most important facts supporting the hypothesis that T-Agree with unaccusative themes is blocked by the dative clitic is that all agreeing datives –be them originally PPs as goals (80) or DPs as experiencers (81) and possessors (82)– behave in the same way. This suggests that the intervention may be linked to the dative markers in the finite verbal form. Non-agreeing PP datives provide a crucial piece of evidence in this regard, as no blocking effects are attested when suspending dative markers in the finite verb. This is illustrated in the examples in (83) (Ortiz de Urbina 2003b: 311). In (83a), the goal agrees with the finite verb and the ergative marking of the unaccusative subject is ruled out, as in the previous examples. In contrast, in (83b), the goal does not trigger dative markers and ergative Case is in turn licensed in the unaccusative subject.

- (83) a. *Bera-ri hurbildu behar diot
 he/she-D approach need AUX[3sgD-1sgE]
 ‘I must get closer to him/her.’
- b. Bera-ri hurbildu behar dut
 he/she-D approach need AUX[1sgE]
 ‘I must get closer to him/her.’

The contrast in (83) implies that the intervention in question is not linked to the position of the dative argument itself (Albizu 2001, Albizu & Fernández 2002), but to the derived position of the clitic that doubles it (Rezac et al. 2014). Note that otherwise both agreeing and non-agreeing datives should behave in the same way and no contrast should be expected between agreeing and non-agreeing ones.

As predicted by the DP vs. PP base-generated distinction, in modal constructions, the option of leaving the dative as a non-agreeing PP is only possible for goals. Experiencer and possessor DP datives are not allowed to do so. This is illustrated by (84), where

experiencer (84a) and possessors (84b) are left without agreeing with the finite verb and the result is still ungrammatical.

- (84) a. *Bertsolari-ek Miren-i gehiago gustatu behar dute
 poets.-E Miren-D more like need AUX[3pLE]
'Miren must like the poets more (The poets must please more to Mire
- b. *Bankaria-ri orain erori behar dute giltz-ek
 banker-D now fall need AUX[3pLE] keys
 lur-rera
 ground-ALL
'Now the banker's keys must fall to the ground (For the thief to succeed as desired, lapurreta nahi bezala ateratzeko).'

The contrast between (83) and (84) follows directly from the distinct DP vs. PP original syntactic category of goals on the one hand, and experiencers and possessors on the other. Goals like *berari* in (83) are generated as PPs and it is possible for them to resort to the PP repair strategy presented in section 4.5. On the contrary, experiencers like *Mireni* in (84a) or possessors like *bankariari* in (84b) enter the syntax as DPs, and the PP repair strategy is not available for them. As a consequence, being generated as DPs in [Spec, ApplP], these datives always receive inherent Case from Appl and enter into a defective Agree relation with *v*. Besides, as inherent datives involve a double D head, such a head is required to undergo clitic doubling to *v*. By doing so, the clitic head moves to [Spec, *v*P] and blocks the Agree relation between T and the theme argument. This leads us to the conclusion that the blocking position in restructuring modal constructions is linked to the derived position of the clitic head, as [Spec, *v*P] is the only position common to all agreeing datives that are able to block T-Agree –but not *v*-Agree. Observe that if the intervening position was [Spec, ApplP] –also common to all agreeing datives, the theme would not only be prevented from Agreeing with T, but also with *v* –at least in [person]. The intervening position should then be outside the domain of *v* and within the domain of T, so as to intervene in the Agree relation between the theme and T, but not *v*. This supports our approach claiming that, before attaching to *v*, clitic doubling in dative arguments involves the movement of the clitic head to [Spec, *v*P].

The hypothesis that [Spec, *v*P] is the position from which dative clitics attach to *v* is additionally strengthened by the fact that transitive subjects are exempt from the

blocking effect of the dative. The example in (85) (Ortiz de Urbina (2003: 311) illustrates that subjects of transitive predicates that are first merged in [Spec, ν P] are still marked ergative regardless of the presence of an agreeing dative. This makes it evident that the intervening position should be below the base generated position of the transitive subject, namely, an inner [Spec, ν P].

- (85) Bera-ri eman behar diot/*dut
 he/she-D give need AUX[3sgA-3sgD-1sgE]/AUX[3sgA-1sgE]
 ‘I must give it to him/her.’

As noted by Albizu & Fernández (2006: 81), the same intervention effect holds with other semantically unaccusative predicates that exhibit a transitive configuration in contexts outside modal constructions. This is the case of *urten* ‘leave’ in western Basque (86a) or *balio* ‘cost, be worth’ in all varieties of Basque (86b). Both *urten* ‘leave’ and *balio* ‘cost, be worth’ are employed transitively in non-modal contexts and a dative argument is compatible with the ergative marking of the subject in restructuring modal constructions too.

- (86) a. Horr-ek bide-ra urten dosku
 that-E way-ALL go out AUX[1plD-3sgE]
 ‘That has come to our way.’
- b. Ez dit balioko fotokopiak ekartzea(k)
 not AUX[1sgD-3sgE] worth photocopy bring.NOM.A(E)
 ‘It will not be valid for me if somebody brings photocopies.’

In order to explain the data in (86), Albizu & Fernández (2006: 83-87) point out that if a verb allows the combination of ergative and dative arguments, then the restructuring modal construction does it as well. In my view, the data in (86) simply imply that subjects of transitive predicates or transitively employed predicates are not affected by the blocking effect of the dative argument because these subjects are first merged higher than unaccusative subjects. Subjects in transitive configurations are generated in outer [Spec, ν P], above the inner [Spec, ν P] position of the dative clitic head. In contrast, themes in unaccusative configurations are introduced as complements of V, lower than the dative clitic position in [Spec, ν P].

Before closing the section on the intervention by dative clitics, I will briefly mention the discussion on Albizu & Fernández (2006), where the intervention analysis proposed in their previous paper –i.e., Albizu & Fernández (2002)– is considered to be invalid. Contrary to Rezac et al. (2014), Albizu & Fernández (2002) take the intervention in modal constructions to be caused by the dative arguments themselves. However, considering that not only “high” –i.e., originally DP– but also “low” –i.e., originally PP– datives induce blocking effects, these authors call into the validity their previous Agree-intervention approach and argue for a Distinctness Condition on the Case-values encoded in V. Such a condition states that the values of the two valued sets of Case-features on V must be distinct. Hence, taking into account that ergative and dative cases are morphologically alike, and assuming that both have a [+marked] feature (Albizu & Eguren 2000, Albizu 2002), these authors claim that pairings of ergative and dative Cases are ruled out due to a violation of the so-called Distinctness Condition. Nevertheless, it is important to recall that the fact that PP datives generated as complements of V cause blocking effects in the same way as DP datives originated in [Spec, ApplP] is no longer problematic once we assume the intervening position to be that of the displaced clitic, and not of the argument itself.

To sum up, the data in this section has strengthened the claim that the dative clitic moves to [Spec, vP]. This corroborates the claim that Basque dative markers are clitics instead of agreement markers. Otherwise, if the dative markers corresponded to agreement, no intervention should be expected in the Agree relation between the unaccusative theme and the T head.

Let us now address another piece of evidence pointing into the same direction: impersonal causative constructions.

4.7.3. Impersonal causative constructions

In section 4.6.4, we have seen that causative constructions embedding ditransitive predicates give rise to a double dative construction, as both the causee and the goal are marked dative. In those constructions, the finite verbal form bears a single dative marker agreeing with the causee dative, because being generated as a PP, the goal resorts to the PP repair strategy and occurs without agreeing with the finite verb.

Ditransitive causative constructions can be impersonal as well, with a causee argument that is interpreted arbitrarily. When this is so, the causee happens to be syntactically realized as an arbitrary pro (pro_{arb}) silent element, without triggering dative markers in the finite verbal form (Albizu 2001, Ortiz de Urbina 2003a). Consider the examples in (87). (87a) and (87b) contain the ditransitive predicate *eman* ‘give’ (Deustuko Hizkuntzalaritza Mintegia 1989: 107) and (87c) the bivalent unergative *jarraitu* ‘follow’ (Ortiz de Urbina 2003a: 611).

- (87) a. Eliza-k pobre-ei dirua eman-erazten du
church-E poor-D money.A give-CAUS AUX[3sgA-3sgE]
‘The Church forces to give money to the poor.’
- b. Hemen Ogasuna-ri dirua lehenbailehen
here tax office-D money.A as soon as possible
eman-erazten da
give-CAUS AUX[3sgA]
‘Here it is forced to give money to the tax office as soon as possible.’
- c. Epaile-ak droga saltzailea-ri jarraitu-erazi zuen
judge-E drug dealer-D follow-CAUS AUX[3sgE]
‘The judge forced to follow the drug dealer.’

In (87), what is crucial for the clitic doubling analysis of the dative markers is the fact that, although the pro_{arb} causee does not trigger dative markers, the goal does neither do so. What is even more, both Albizu (2001: 57) and Ortiz de Urbina (2003a: 611) point out that the goal is never able to trigger dative markers in impersonal causatives. Consider now the examples in (88).

- (88) a. *Eliza-k pobre-ei dirua eman-erazten die
church-E poor-D money.A give-CAUS AUX[3sgA-3plD-3sgE]
‘The Church forces to give money to the poor.’
- b. *Hemen Ogasuna-ri dirua lehenbailehen
here tax office-D money.A as soon as possible
eman-erazten dio
give-CAUS AUX[3sgA-3sgD-3sgE]
‘Here it is forced to give money to the tax office as soon as possible.’
- c. *Epaile-ak droga saltzailea-ri jarraitu-erazi zion
judge-E drug dealer-D follow-CAUS AUX[3sgD-3sgE]
‘The judge forced to follow the drug dealer.’

The sentences in (88) are only grammatical if the agreeing dative is understood to refer to the causee and not the goal. That is to say, although they do not have a natural reading, (88a) could only mean that the Church makes the poor give money, (88b) that the tax office is made give money, and (88c) that the judge made the drug dealer follow someone else.

For the purposes of the discussion, recall that the finite verbal forms in (87) do not bear any other dative marker, and as illustrated in the examples in (88), the goal is still unable to trigger dative markers. As noted by Albizu (2001: 57), this makes it evident that the impossibility for the goal to trigger dative markers in examples like (88) is not morphological, but rather syntactic. In line with Albizu, I further claim that in order to explain the examples in (87) and (88) pro_{arb} should be active in syntax. Assuming that agreement requires movement of the agreeing nominal, Albizu explains these facts by arguing that pro_{arb} is a possible candidate to Agree with the causative v and that, as a result, it has the capacity to block the movement of the goal that intends to Agree with v . Given that movement is a property of clitics and not agreement markers, I consider that Albizu's intuition fits in better with the clitic doubling analysis of the dative markers. Crucially, Albizu (2001: 58) reports that, although impeding clitic doubling of the goal, pro_{arb} lets the absolutive object Agree with v . Consider now the example in (89) (Ortiz de Urbina 2003: 610).

- (89) Herri-ra zerorr-ek eramán-arazi behar-ko nauzu
 village-ALL you-E carry-CAUS need-FUT AUX[1sgA-2sgE]
 '*You will have to make someone take me to the village yourself.*'

Moreover, it is important to recall that in (89) the pro_{arb} causee does not trigger PCC effects when combining with an agreeing first person absolutive. Hence, although the arbitrary causee blocks the dative markers of the goal, it allows absolutive markers to appear in the finite verbal form. This would be contradictory for an analysis that takes both dative and absolutive markers to refer to agreement markers. However, the alleged contradiction disappears if we take dative markers to correspond to clitics and absolutive markers to agreement markers –recall from section 4.4 that these arise from the v -Agree relation in both [person] and [number].

On the one hand, if the pro_{arb} causee is active in syntax, it seems reasonable to think that it is introduced in [Spec, ApplP], as the rest of causee arguments. This explains straightforwardly the unavailability for goal datives to trigger dative markers in the finite verb. Goal datives are generated as PPs in the complement position of V and when P incorporates into V, they move to [Spec, ApplP]. In that position, they receive dative Case from Appl and Agree defectively in [person] with v . Nonetheless, impersonal causatives block the incorporation and subsequent movement of the goal, as [Spec, ApplP] is filled by pro_{arb} . Consequently, the goal is required to resort to the PP repair strategy in order to be realized as a non-agreeing dative. Overall, impersonal causatives prevent the goal from moving to [Spec, ApplP] and undergoing clitic doubling in the same way as in the rest of causative constructions. [Spec, ApplP] is filled by the causee in all the cases and the goal has no option to Agree with v from that position.

On the other hand, if we assume that, although present in [Spec, ApplP], pro_{arb} does not Agree with v , we can additionally explain the fact that the object is able to Agree with v without pro_{arb} causing PCC effects. The main hint to argue for the lack of v -Agree with pro_{arb} comes from the lack of dative markers in the finite verbal form, as all the datives that Agree with v trigger subsequent clitic doubling. Throughout the chapter we have seen that in non-impersonal causative constructions, the combination of a causee in [Spec, ApplP] with a first or second person object yields PCC effects. This is what happens in the examples in (18) (Albizu 2001: 58), repeated here as (90).

- (90) a. *Ama-k anaia-ri ni etxe-ra ekarr-arazi naio
 mother-E brother-D I.A house-ALL bring-CAUS AUX[1sgA-3sgD-3sgE]
'The mother has made the brother bring me home.'
- b. *Ama-k anaia-ri zu etxe-ra ekarr-arazi zaitio
 mother-E brother-D you.A house-ALL bring-CAUS AUX[2sgA-3sgD-3sgE]
'The mother has made the brother bring you home.'

In (90), the first and second person objects are unable to Agree both in [person] and [number] with v , leading thereby to a Case licensing failure. The causee enters into a non-valuing [person] Agree relation with v . This allows the object to Agree only in [number] with v , which is problematic for first and second person objects. In order to satisfy their Case requirements, first and second person objects need to Agree both in

[person] and [number]. Contrary to non-impersonal causatives, in impersonal causatives the pro_{arb} causee does not Agree with v . Therefore, the object is able to Agree both in [person] and [number] with v and no PCC effects ensue if this is first or second person.

Synthesizing, the presence of pro_{arb} in [Spec, ApplP] blocks clitic doubling of the goal, as this would require movement to [Spec, ApplP]. In addition, the lack of v -Agree by pro_{arb} explains the fact that pro_{arb} blocks clitic doubling of the goal dative, but not absolutive agreement of the direct object. Although Albizu's intuition linking dative markers with movement is on the right track, it is necessary to distinguish those markers that arise by movement –i.e., by clitic doubling– from those that do not. Put it explicitly, in order to distinguish the different behavior of goals and themes in impersonal causatives, it is necessary to consider the markers triggered by the former to be doubled clitics and those triggered by the latter agreement markers that arise by means of v -Agree. If both dative as well as absolutive markers would be agreement markers, additional assumptions would be needed to explain the fact that only dative markers are blocked by the impersonal causee.

Moreover, the lack of PCC effects in impersonal causatives has independently corroborated that absolutive markers arise as a consequence of an Agree relation against v . If, as in causatives, v Agrees with another argument before the object, PCC effects arise if the object is first or second person. On the contrary, if, as in impersonal causatives, v does not Agree with any other argument prior to the object, no PCC yields. This can only be understood if absolutive Case is checked in a v -Agree relation.

4.8. CONCLUSION AND INTERIM SUMMARY

This chapter has reached to the conclusion that, as absolutive objects, DOM objects are licensed in syntax by Agreeing with v (Odria 2012 2014, Fernández & Rezac 2016) This is mainly supported by the fact that DOM objects are targeted by the PCC in the same way as canonical absolutes. Following the Agree/Case approach of the PCC (Anagnostopoulou 2003, Béjar & Rezac 2003, Rezac 2007 2008ab 2009ab 2011), I have argued that the so-called constraint corresponds to a failure of Case licensing on

first and second person objects when an inherent dative c-commanding the object from [Spec, ApplP] Agrees defectively in [person] with v . Being already Case licensed, inherent datives are involved in a bigger KP shell (Rezac 2008a), and this prevents them from entering into a regular Agree relation involving phi-valuation. As a consequence, inherent datives Agree defectively in [person], and v ends up being specified for third person. This allows v to Agree with the object in [number], but not [person]. For this reason, when the object is first or second person, this ends up being unlicensed for Case, because, in contrast to third person objects –which bear only [number] phi-features, first and second person objects are specified both for [person] and [number] (Taraldsen 1995, Anagnostopoulou 2003).

Contrary to what happens with agreeing inherent datives in [Spec, ApplP], non-agreeing PP datives do not trigger PCC effects. As no v -Agree relation holds with these objects, first and second person objects are allowed to Agree with v in both [person] and [number]. This is what happens when PP-like goals resort to the PP repair strategy. Building on Rezac (2011), I have stated that the PP repair strategy consists of adding uninterpretable phi-features to the previously inactive Agree/Case locus in P. This allows the originally PP goal to Agree with the P head and receive thereby dative Case from P. This ensures that each of the internal argument Agrees with a different functional head: the goal with P and the object with v . Consequently, the finite verbal form agrees only with the first or second person object, as the goal is realized as a non-agreeing PP.

As predicted by the DP vs. PP original categorical distinction, I have demonstrated that the PP repair strategy is exclusively available for PP-like goals (Albizu 1997a 2001, Rezac 2009b 2011). PCC effects with causee, experiencer and possessor datives are generally unsolvable, because in absence of a P head, these datives are unable to resort to the PP repair strategy. Besides, I have shown that the same occurs with DOM objects too, as these are also DPs with regards to their syntactic category. As a result, similarly to what happens with canonical absolutes, PCC effects targeting DOM objects happen to be repairable only with PP-like goals. The repair leads to a double dative construction, where both the goal and the DOM object are marked dative but only the DOM object is cross-referenced by the finite verbal form (Fernández & Rezac 2010 2016, Odria 2014).

Crucially, double dative constructions combining DOM objects with causee, experiencer and possessor datives have been proved to be commonly ungrammatical. Again, this is something expected by the DP categorial origin of both DOM and these inherent datives.

Apart from the double dative construction formed by a DOM and a goal dative, in this chapter I have additionally shown that in Basque double dative constructions are also found in ditransitive causatives involving a causee and a goal dative. As expected, in these constructions the causee appears always agreeing with the finite verbal form and the goal occurs as a non-agreeing PP (Deustuko Hizkuntzalaritza Mintegia 1989 Albizu 2001, Ortiz de Urbina 2003a, Duguine 2013, Odria 2014). Besides, some speakers find ditransitive causatives involving a possessor dative less grammatical than those involving a goal dative (Duguine 2013), which reinforces the claim that, contrary to goals, possessors generate with a DP syntactic category, and thus, are unable to resort to the PP repair strategy. The possibility to have double dative constructions in ditransitive causatives has ultimately proved that, apart from PCC contexts, the PP repair is independently available in constructions where [Spec, ApplP] is already filled by a DP dative. Besides, the possibility to combine DP and non-agreeing PP datives implies that, in addition to the categorial distinction, DP and PP-like datives should also be generated in different syntactic positions.

To finish, the chapter has proposed a clitic doubling analysis for the dative markers in the finite verbal form. Adhering to the main tenets in Rezac (2008a 2011), I have argued that the clitic head originated adjoined to the dative KP moves to [Spec, v P] before attaching to v (Matushansky 2006, Nevins 2011, Harizanov 2014, Kramer 2014). The movement of the clitic head to [Spec, v P] has been justified by two main pieces of evidence: (i) the intervention of the agreeing dative in restructuring unaccusative modal constructions (Albizu 2001, Albizu & Fernández 2002 2006, Ortiz de Urbina 2003b, Goenaga 2006, Rezac et al. 2014), and (ii) the intervention of the pro_{arb} causee in impersonal causative constructions (Albizu 2001, Ortiz de Urbina 2003a)

Coming back to the syntactic nature of DOM objects, this chapter has thus shown that, despite their dative marking, these non-canonical objects behave as canonical

absolutives up to the Agree relation with the v head. Sharing the same thematic as well as argumental relationship, both enter the derivation in the complement position of V, and being able to control depictive secondary predication, a single DP syntactic category should be attributed to them (chapter 3). Having determined the main similarities grouping DOM objects with canonical absolutives, the next chapter will be devoted to identify the process lying behind the dative Case assignment in DOM objects, in other words, the main aspect that makes DOM objects akin to the rest of agreeing inherent datives. The v -Agree relation held by human and definite objects does not account for the dative marking of these non-canonical objects. The case/agreement reflex of the v -Agree relation is not dative but rather absolutive. Hence, an additional mechanism to v -Agree is needed in order to capture the differential marking, because in absence of such a mechanism, human and definite objects should also show absolutive marking, contrary to facts.

5. DOM AND THE DERIVATIONAL DISTINCTNESS CONDITION

5.1. INTRODUCTION

In previous chapters, I have shown that DOM objects pattern like canonical absolutes up to the Agree relation with the ν head. In line with the general assumption in the literature on the topic, in chapter 1, I have taken for granted that DOM objects enter the derivation in the complement position of V, given that they display the same argumental as well as thematic relationship as absolute objects. Based on the licensing of depictive secondary predication, in chapter 3, we have seen that DOM objects are DPs categorically. In addition, chapter 4 has argued that, similar to canonical absolutes, DOM objects are Case licensed by entering into an Agree relation with the ν head. Both chapter 3 and 4 have then evidenced the syntactic similarities shared by DOM and absolute objects.

This chapter makes a further step in the examination of the syntactic derivation of DOM objects and focuses on the main aspect that makes DOM objects distinguish from absolutes and assimilate to the rest of agreeing inherent datives: the mechanism of dative Case assignment. In this chapter, I propose that dative Case in DOM objects is assigned configurationally, when the object coincides with another argument in the same local domain. Some of the conclusions we have reached in previous chapters already point into that direction. On the one hand, in chapter 4 I have argued that DOM objects check structural absolute Case against the ν head. Thus, their dative marking should not be structural as well. Otherwise, this would imply that a nominal that has already had its [u Case] feature valued by a given head may enter into another Agree relation with a different head and receive thereby an additional Case value. Such a situation would involve two case as well as agreement markers for the same nominal, and would be excluded by the Activity Condition (Chomsky 2000: 123, 2001: 6). The Activity Condition states that in order for a given nominal to Agree with a functional head, both the nominal and the functional head must be active, where being

syntactically active involves having uninterpretable features –i.e., [*u*Case] in the case of the nominal. Therefore, the fact that DOM objects have their [*u*Case] feature valued by *v* discards the possibility for the dative Case to be assigned structurally.

On the other hand, chapter 4 has also concluded that agreeing inherent datives in [Spec, ApplP] are like ‘big DPs’: KPs holding an adjoined D clitic head that ends up attached to the *v* head. Hence, dative Case assignment in DOM objects should involve a K head as well, turning the absolutive DP object into a dative KP. On this assumption, DOM objects’ dative markers should also correspond to clitic markers that arise when the adjoined defective D head m-merges with *v* after moving to [Spec, *v*P]. This would group DOM objects with the rest of agreeing inherent datives and would account for the obligatory nature of their dative markers in the finite verb.

Taking these two facts into account, the hypothesis I will argue for in this chapter is that, after Agreeing with *v*, DOM objects receive the differential marking configurationally, turning the DP object into a KP.

In general terms –and avoiding nuances among the different approaches, configurational Case is known to be assigned when two arguments coincide in the same local domain – see, among many others, Marantz (1991), Harley (1995), Bittner & Hale (1996), Richards (2010), Baker & Vinokurova (2010), Baker (2012 2015), Preminger (2014) and Levin & Preminger (2015). This kind of Case assignment is independent from selectional and/or structural relations established between the arguments and the functional heads, and emerges when two nominals co-occur in a given syntactic domain. The first hint suggesting that dative Case in Basque DOM objects is configurational comes from the contrast attested between transitive and unaccusative constructions. Being an ergative language, in Basque, absolutive Case is assigned both to objects of transitive predicates and to subjects of unaccusative predicates, as both of them are known to Agree with *v* (Rezac et al. (2014). This is illustrated in (1), where *ni* ‘I’ –unaccusative subject in (1a) and transitive object in (1b)– bears absolutive case (\emptyset) and triggers absolutive agreement in the finite verbal form (*n-*).

- (1) a. *Ni etorri naiz*
 I.A come AUX[1sgA]
 ‘I have come.’

b. Zu-k ni ikusi nauzu
 you-E I.A see AUX[1sgA-2sgE]
 ‘You have seen me.’

Despite their identical absolutive marking, unaccusative subjects and transitive objects differ in a non-trivial aspect: while the latter appears accompanied by another argument –i.e., the ergative subject *zuk* ‘you’– the former is the only argument in the clause. Such a distinction has a clear consequence in the possibility to assign the differential marking to the argument that has previously Agreed with *v*. As a matter of fact, dative marking with a ditransitive finite verbal form is only possible in (1b), where the absolutive argument occurs along with the ergative subject. This indicates that dative Case in DOM objects like (2b) is configurationally assigned, as dative marking is ruled out in unaccusative subjects like (2a), in which the argument Agreeing with *v* has no other argument around it.¹¹⁹

(2) a. *Ni-ri etorri dit
 I-D come AUX[1sgD]
 ‘I have come.’

b. Zu-k ni-ri ikusi didazu
 you-E I-D see AUX[1sgD-2sgE]
 ‘You have seen me.’

The different patterns in (2) suggest that in order for a given argument to be differentially marked, another argument has to be present in the same local domain. This is, in fact, the claim I will support throughout this chapter. DOM objects receive dative Case configurationally, depending on the presence of another argument –i.e., the transitive subject– in the same configuration. Note that otherwise no distinction should be expected between (2a) and (2b). If Case in DOM arose as a result of a selectional or structural relation with a given head, dative marking should be equally licensed in both of them, contrary to facts.

¹¹⁹ As in chapter 4, the examples provided in this section have been tested among speakers of different southwestern Basque varieties. However, for ease of exposition, I present all the data provided by these speakers in Standard Basque.

In this chapter, I propose that the dative marking in DOM objects arises as a consequence of the Distinctness Condition put forth by Richards (2010), which bans the linearization of identical elements in an asymmetric c-command relation. Crucially, instead of assuming that Distinctness effects are only visible at the last step of the syntactic derivation –i.e., when the complement of a given phase is transferred to Spell-Out, I argue that syntax is aware of the Distinctness Condition from the very beginning of the derivation, as suggested by Richards (2010: 86-87, 114, 117, 125-126). Hence, I propose that, in Basque DOM varieties, when the subject is merged in [Spec, ν P], the problematic $\langle \varphi P, \varphi P \rangle$ linearization statement –formed by the subject and the object– ends up being avoided by adding a K head to the human and definite object. Given the phasal nature of K, this turns the $\langle \varphi P, \varphi P \rangle$ linearization statement into two separate statements: $\langle \varphi P \rangle$ and $\langle KP \rangle$.

K corresponds to the differential marking in DOM objects and makes these objects morphologically identical to the rest of agreeing inherent datives in [Spec, ApplP], which are KPs as well –see chapter 4 (section 4.4). As happens with the datives in [Spec, ApplP], the KP in DOM objects bears an adjoined clitic head that m-merges with ν after moving to [Spec, ν P] (Matushansky 2006), explaining that the dative marking arises not only in the nominal but also in the finite verbal form. It is thus the addition of the K head the mechanism that makes DOM objects exhibit the same morphology as the rest of dative arguments.

In its original version, the Distinctness Condition is considered to apply at Spell-Out domains, when the complement of a given phase is sent to the PF interface. However, as I have already pointed out, I argue that Distinctness is instead active from the very beginning of the syntactic derivation. Therefore, the Distinctness effect leading to DOM does not yield when –after undergoing Object Shift– the object coincides with the subject in the TP Spell-Out domain, but in the ν P phase domain, as soon as the transitive subject enters the derivation in [Spec, ν P] (Richards (2010: 86-87, 114, 117, 125-126).

In Basque, the Derivational approach of the Distinctness Condition is motivated by three main pieces of evidence: (i) the lack of evidence arguing for Object Shift outside

VP, (ii) the possibility to have DOM in interrogative contexts where either the subject or the object is linearized higher than the TP Spell-Out domain, and (iii) the co-occurrence of DOM with the KP shell (Rezac et al. 2014) of the structural ergative subject in [Spec, TP]. These three pieces of evidence point to the fact that the Distinctness effects leading to DOM are avoided in the ν P phase domain. As we will see, the Derivational version of the Distinctness Condition happens to be superior to its original version, because it accounts not only for the Distinctness effects that arise at Spell-Out, but also for those that arise throughout the syntactic derivation, explaining this way both the DOM in accusative languages like Spanish and in ergative languages like Hindi or Basque.

In addition to explain its presence in transitive configurations, the Derivational Distinctness Condition accounts straightforwardly for the absence of DOM in (i) ditransitive configurations where the object coincides with an agreeing inherent dative in [Spec, ApplP], and (ii) in derived transitive constructions formed with the verb **edun* ‘have’, where the ergative subject is generated as an oblique argument. In the case of ditransitives, the ApplP placed in between VP and ν P prevents the object from coinciding with the transitive subject in the same phase domain. Due to the phasal nature of ApplP (McGinnis 2001ab 2004), the object will be Spelled-Out by the time the subject enters the derivation in [Spec, ν P], and hence, no Distinctness effect will arise between the subject and the object. This follows from the fact that the Spell-Out domain of a given phase is transferred to PF as soon as the phase is completed (Chomsky 2000 2001). As expected, the situation happens to be different when the ditransitive configuration involves a non-agreeing goal dative. As we have seen in chapter 4 (sections 4.5 and 4.6), (in southwestern Basque) this is only possible when the object is first or second person, because non-agreeing goals emerge with the aim at repairing PCC effects. In this case, as the dative is involved in a lower phasal PP, the object coincides as in the rest of transitive constructions with the subject in [Spec, ν P] and the K head is added in order to avoid a Distinctness effect. As pointed out in chapter 4 (section 4.6), this leads to a double dative construction with a finite verb agreeing with the DOM object. The availability to have DOM in ditransitive contexts is thus independent from the original DP vs. PP category of the dative argument, as it

depends exclusively on whether the dative projects an ApplP or not. Regardless of their original syntactic category, only those datives in [Spec, ApplP] ban the differential marking. Along with Basque, I show that the Derivational version of the Distinctness Condition captures the distribution of DOM in ditransitives involving agreeing as well as non-agreeing datives in Spanish too, since DOM and agreeing datives are also known to be in complementary distribution (Demonte 1994, Romero 1997, Ormazabal & Romero 2013abc).

The lack of DOM in derived transitives built up with **edun* ‘have’ is equally explained by the Derivational Distinctness Condition. Contrary to transitives, the ergative subject in this kind of derived transitives is generated as an oblique argument within a silent applicative head represented as P (Etxepare & Uribe-Etxebarria 2012), and becomes a KP as soon as it moves to [Spec, TP]. Thus, given that the object does not coincide with it in any phase domain of the syntactic derivation, there will be no need for it to receive the phasal K head.

The chapter is structured as follows. In section 5.2, I outline the main principles of the Distinctness Condition put forth by Richards (2010) and show that this accounts for the DOM in languages where animate and specific objects receive a differential marking. Section 5.3 applies the Distinctness Condition in Basque DOM varieties and argues that the condition must be satisfied derivationally, as soon as the object coincides with the transitive subject in [Spec, ν P]. In order to explain Basque data, this section discards both the original version of the Distinctness Condition as well as other kind of configurational Case assignments involving Dependent Case (Marantz 1991, Bittner & Hale 1996, Preminger 2014, Baker 2015), as both assume that the object co-occurs with the subject in the TP Spell-Out domain and the latter does not capture the role played by animacy in the marking of the object. Section 5.4 shows that the Derivational Distinctness Condition accounts for the lack of DOM in ditransitive constructions with an agreeing inherent dative in [Spec, ApplP]. Besides, the lack of DOM in derived transitives formed with **edun* ‘have’ is addressed in section 5.5. To finish, the chapter is closed in section 5.6 by summarizing the main conclusions reached throughout the chapter.

5.2. THE DISTINCTNESS CONDITION

In this section, I outline the main tenets of the Distinctness Condition put forth by Richards (2010). In section 5.2.1, I explain that such a condition bans the linearization of Spell-Out domains containing identical elements that are in an asymmetric c-command relation. Next, in 3.2.2, I review how the condition captures the fact that animate and specific objects receive the differential marking in DOM languages like Spanish, Hindi, Chaha and Miskitu (Richards 2010: 25-32). Richards argues that in those languages specific objects undergo Object Shift to the edge of the vP phase and, as a result, end up linearized in the same TP Spell-Out domain as the subject. Besides, taking into account that Basque DOM is basically conditioned by the animacy of the object, section 5.2.3 pays special attention to the way Richards implements the role played by animacy in DOM languages like Spanish. Following Harbour (2007), Richards (2010: 80-83) assumes that transitive subjects are always specified for the features reflecting animacy, and hence, bear the label ϕP instead of DP. This makes the subject and the object display identical labels when the latter is animate as well, leading to the linearization statement $\langle \phi P, \phi P \rangle$ in the TP Spell-Out domain. Being identical elements that are in an asymmetric c-command relation, the Distinctness Condition makes the object distinct from the subject by assigning it a K phase head, giving raise to DOM). Overall, this section lays out the main basis in order to explore in subsequent sections the implementation of the Distinctness Condition in Basque varieties showing DOM.

5.2.1. Preliminaries

In line with Chomsky (2000 2001) and subsequent work within the Minimalist Program, Richards (2010: 4) assumes that the nodes of a syntactic tree are transferred to the Conceptual-Intentional (CI) and Sensoriomotor (SM) interfaces cyclically, phase by phase.¹²⁰ The transfer or mapping between narrow syntax and the Sensoriomotor (SM)

¹²⁰ The conceptual-Intentional interface is analogous to the Logical Form (LF) interface mentioned in the 'Framework' section in chapter 1 (section 1.1), and the Sensoriomotor (SM) to the Phonetic Form (F) interface referred in the same section.

interface –i.e., phonology– is carried by Spell-Out, a mechanism that takes place at various stages throughout the syntactic derivation, namely, each time a strong phase has been completed (Chomsky 2001 2004 2007 2008). Spell-Out transfers cyclically the syntactic material within a strong phase to PF.

According to Richards, strong phases include not only CP and transitive v^*P as stated by Chomsky (2000: 106 2001: 12), but also PP and KP. The material sent to PF is referred by Richards as *Spell-Out domain* and includes all but the head and specifier of a given phase, namely, its complement domain. The head and specifier constitute the edge of the phase and are sent to Spell-Out along with the material in the next higher phase. Once being transferred, the material in a Spell-Out domain is linearized in the PF interface and becomes inaccessible for further syntactic operations. Thus, Spell-Out links the nodes of a given domain with a linearization statement, fixing the relative ordering of the words within it.

The process of Spell-Out is illustrated by Richards (2010: 5) with the tree and its correspondent linearization statement in (3). The syntactic tree in (3a) contains two DPs in an asymmetric c-command relation –*John* and *Mary*– and, once transferred to PF, such a tree turns into the linearization statement in (3b).

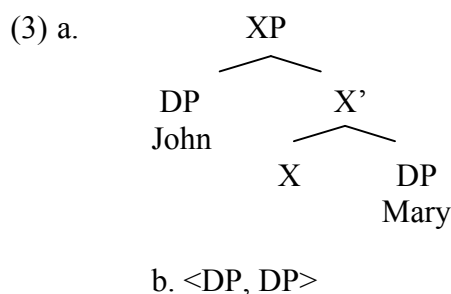

Richards (2010: 5) explains that the linearization statement in (3b) is uninterpretable for PF, because it implies either that a DP node precedes itself –i.e., a self-contradictory instruction– or that one DP precedes the other without specifying which comes first. Being uninterpretable, such a statement cannot be properly linearized at PF and the derivation crashes at Spell-Out. In order to allow the linearization of well-formed statements and ban the ones which, being self-contradictory or underspecified, are uninterpretable for PF, Richards proposes the following condition on linearization:

- (4) Distinctness: If a linearization statement $\langle \alpha, \alpha \rangle$ is generated, the derivation crashes (Richards 2010: 5).

The Distinctness Condition in (4) rules out the linearization of Spell-Out domains involving two nodes of the α type in an asymmetric c-command relation. Put it in other words, (4) states that in order to be linearized, the nodes in a given Spell-Out domain must be distinct from each other. Richards (2010: 6-7) points out that the values of non-distinctness may change from language to language. In some languages identical nodes involve those which display the same label. This would be the case of the English tree in (3a), where the two elements in an asymmetric c-command relation display the same DP label and are recognized as identical by the linearization algorithm. Other languages like Japanese make closer distinctions and nodes are considered to be non-distinct if they have the same value for features like case, animacy or gender (Richards 2010: 45-46). As explained by Richards (2010: 7), this means that in languages like English a head like D is represented only by the feature [D], while in languages like Japanese, linearization may refer to a wider range of features, including case, animacy or gender.

5.2.2. DOM and the Distinctness Condition

Once presented the main principles of the Distinctness Condition, in what follows I review how the Distinctness Condition accounts for the DOM in languages where the differential marking is conditioned by both animacy and specificity (Richards 2010: 25-32). Richards explains that in these languages the differential marking is added to the object in order to distinguish it from the subject, as both of them bear the same label and are linearized in an asymmetric c-command relation in the TP Spell-Out domain. In order to follow Richards' line of argumentation, two main assumptions are to be clarified.

On the one hand, as it is commonly assumed, Richards assumes that the subject is Spelled-Out in [Spec, TP], in the TP linearization domain of the CP phase. On the other hand, in line with the literature on the topic, this author maintains that specific objects undergo Object Shift to the edge of the vP –i.e. strong v^*P – phase, that is, to [Spec,

νP].¹²¹ This way, the shifted object ends up being Spelled-Out with the material in the higher CP phase, coinciding with the subject in the TP Spell-Out domain. This is depicted in the syntactic tree in (5). The tree in (5) shows that once the specific object shifts to the edge of νP , this is linearized with the subject in the TP Spell-Out domain.

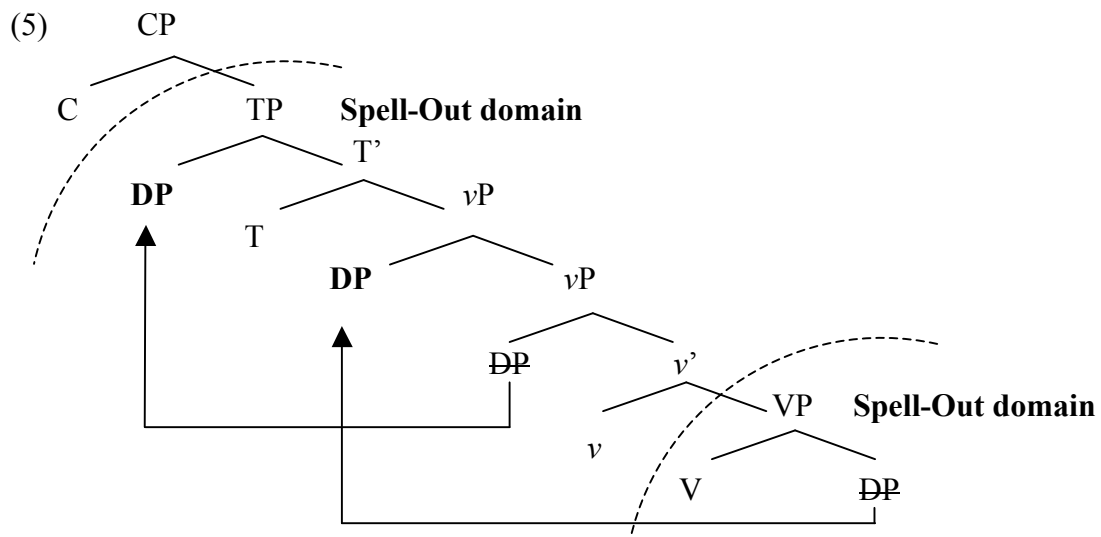

Due to the Object Shift of the specific object, in (5) both the subject and the object turn out to be linearized in the same TP Spell-Out domain. This gives rise to the problematic $\langle DP, DP \rangle$ linearization statement. As a consequence, the derivation in (5) does not satisfy the Distinctness Condition, and hence, it does not converge at Spell-Out. Recall that, according to the Distinctness Condition, the nodes in a Spell-Out

¹²¹ Richards (2010: 14) departs from Chomsky (2000 2001) with regards to the first merge position of the external argument, as he states that the transitive subject is not generated in the highest position of the νP phase. Richards divides Chomsky's ν^*P phase in two main projections: $\nu_C P$ –projected by the phase head ν_C – and νP . Accordingly, instead of being introduced in the specifier position of the phase head ν_C , he takes the external argument to be generated as specifier of νP . For Richards ν_C relates to ν in the same way as C relates to T. Parallel to the C-T as well as ν^*-V phi-feature inheritance (Chomsky 2007 2008), he assumes that ν inherits its ability to Agree and license objects from the phase head ν_C . Therefore, given that $\nu_C P$ takes νP as its complement, the Spell-Out domain in this phase does not involve only VP, but rather the whole νP , including the external argument in its specifier and the internal argument in its VP complement. Given that Basque does not seem to show any evidence for the presence of this ν_C head, following Chomsky (2000 2001), I will adhere to the standard $[_{\nu^*P} DP \nu^* [_{\nu P} V DP]]$ structure of the verbal phrase.

domain must be distinct enough for the derivation not to crash. As illustrated in (6), such a condition was violated in (5).

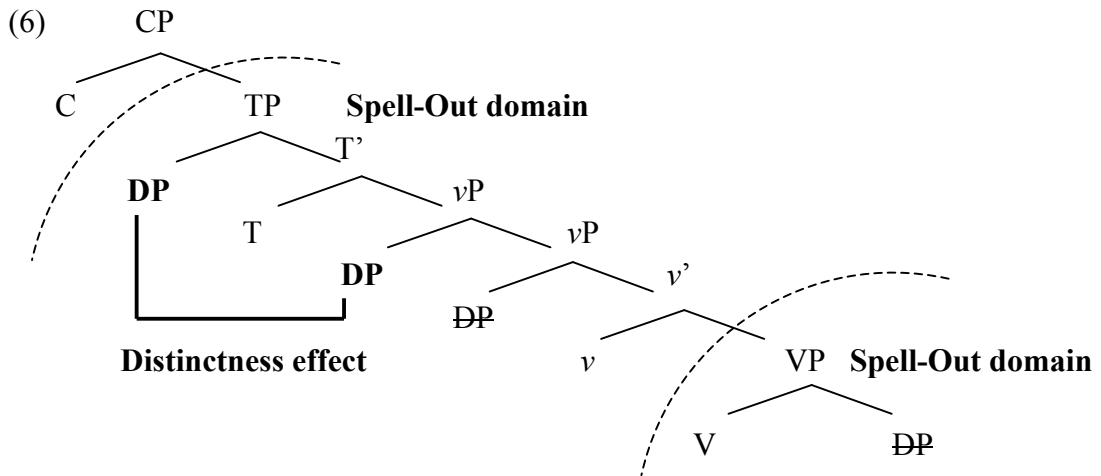

Richards (2010: 54-57) states that in derivations like (6), the Distinctness Condition avoids the problematic $\langle \text{DP}, \text{DP} \rangle$ linearization statement in the TP Spell-Out domain by adding an extra morpheme to the shifted object, which corresponds to the differential marking. The extra morpheme belongs to the phase head K and involves a separate Spell-Out domain for the argument bearing it. Given its phasal nature, the DP complement of KP ends up linearized in a separate Spell-Out domain and having two independent $\langle \text{DP} \rangle$ $\langle \text{DP} \rangle$ linearization statements the derivation converges as in (7).

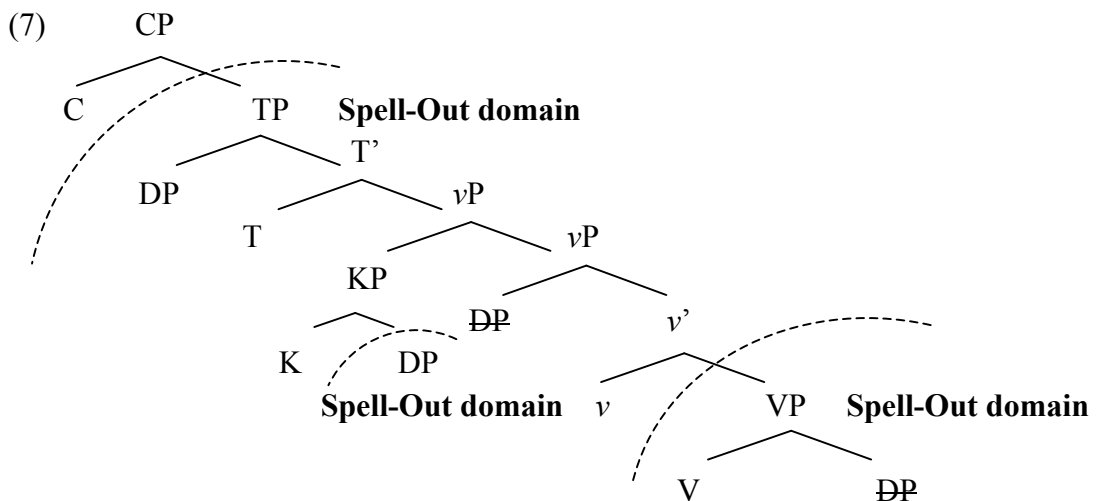

In a few words, according to Richards, the differential marking in DOM languages arises because specific objects undergo Objects Shift and are thus linearized in the same TP Spell-Out domain as the subject. As both the object and the subject display the same label, the differential marking –i.e., the phasal K head– is added to the object in order to avoid a violation of the Distinctness Condition, which states that the derivation crashes if a given linearization statement contains two identical nodes in an asymmetric c-command relation.

Having explained the influence of specificity in triggering the differential marking, in the next section I address the role played by animacy in Richards’ Distinctness Condition.

5.2.3. Accounting for animacy within the Distinctness Condition

As I have mentioned in chapter 2, animacy is a key factor triggering the differential marking in several DOM languages. Besides, cross-linguistically it is very common for animacy to interplay with specificity when triggering the differential marking (Bossong 1991: 160). As shown in chapter 2, along with Basque, this is also the case of the DOM found in languages like Spanish (section 2.3.1) or Hindi (section 2.3.2).

Taking this into account, Richards (2010: 80-83) implements the role played by animacy within the Distinctness Condition. This author argues that the animacy value of a given argument may be reflected in its label, distinguishing between ϕ P and DPs, the former being specified and the latter underspecified for animacy. In order to show how animacy affects the Distinctness Condition, Richards focuses on Spanish DOM.

According to Richards (2010: 81), the influence that animacy has in Spanish DOM is evidenced by two main facts. On the one hand, as illustrated by (8) (Torrego p.c. to Richards), it is impossible to have the differential marking with inanimate objects. On the other hand, irrespective of the animacy of the subject, animate –and specific– objects are always differentially marked, as in (9) (Torrego 1998: 30).

- (8) El coche aplastó (*a) una lata
 the car crushed.3sg DOM one can
 ‘The car crushed a can.’

(9) a. El soldado emborrachó *(a) varios colegas
 the soldier made drunk.3sg DOM several friends
 ‘The soldier got several friends drunk’

b. El vino emborrachó *(a) varios invitados
 the wine made drunk.3sg DOM several guests
 ‘The wine made several guests drunk.’

At first sight, one could think that if animacy is a relevant feature for the Distinctness Condition, Distinctness effects should not only appear in (9a), where both the subject and the object are animate, but also in (8), where both the subject and the object are inanimate. Given that the subject and the object display the same animacy value –i.e., animates in (9a) and inanimates in (8), the Distinctness Condition should be violated in both of them. By the same token, given that Distinctness avoids identical elements in the same Spell-Out domain, it could be reasonable to assume that no Distinctness effect –and hence, no DOM– should arise in (9b), because the subject and object show different values with respect to animacy. Be that as it may, this is not what happens in Spanish: inanimate objects that occur with inanimate subjects do not trigger Distinctness effects (8), and animate –and specific– objects trigger Distinctness effects either when combined with an animate (9a) or inanimate (9b) subject. As pointed out by Richards (2010: 81), these facts are at first glance unexpected if animacy counts as a distinguishable feature for the Distinctness Condition, because DOM does not emerge simply when the subject and the object have non-distinct values with regards to animacy. In order to give an explanation for these apparently puzzling facts, Richards resorts to Harbour’s (2007) theory of phi-features and argues that, regardless of their actual status for animacy, transitive subjects are always specified for the phi-features representing animacy.

Harbour (2007) states that not all arguments need to bear phi-specification, and that DPs may be specified or not for [person] phi-features. While first and second person arguments must be inherently specified for both [person] and [number] features, this author argues that third person arguments may be specified for number only.¹²² Given

¹²² Recall from chapter 4 (section 4.4) that this is also assumed by the Agree/Case approach of the PCC (Anagnostopoulou 2003, Béjar & Rezac 2003, Rezac 2007 2008ab 2009ab 2011).

that contrary to third person, first and second person are always animate, Richards (2010: 81) concludes that the [person] phi-specification of a given argument may give us information about its animacy value. If a nominal is specified for both [person] and [number] features, it will be interpreted as animate. On the contrary, if a nominal is specified only for number, it will be interpreted as third person, with no entailment regarding semantic animacy. On this assumption, in order to explain the syntactic distinction between third person animate and inanimates, Richards assumes that, contrary to the latter, the former are specified for [person] features –see also Anagnostopoulou (2005), Adger & Harbour (2007) and M. Richards (2008) for a similar view.

Besides, building on Adger & Harbour’s (2007) claim that any [+participant] nominal is animate, though an animate nominal need not bear a value for [±participant], Richards (2010: 81-82) proposes that the asymmetric relation between the [±participant] and the [±animate] feature can be captured in terms of a feature hierarchy –see also Harley & Ritter (2002) and Béjar (2003), among others. Such a hierarchy is shaped as a hierarchical syntactic structure, with the features [±author] and [±participant] being dependent on the feature [±animate], which is represented as part of the head ϕ –i.e., person– of a projection ϕ P. Observe the phi-feature structural hierarchies provided by Richards (2010: 82) for first person in (10a), third person animate in (10b) and third person inanimate in (10c).

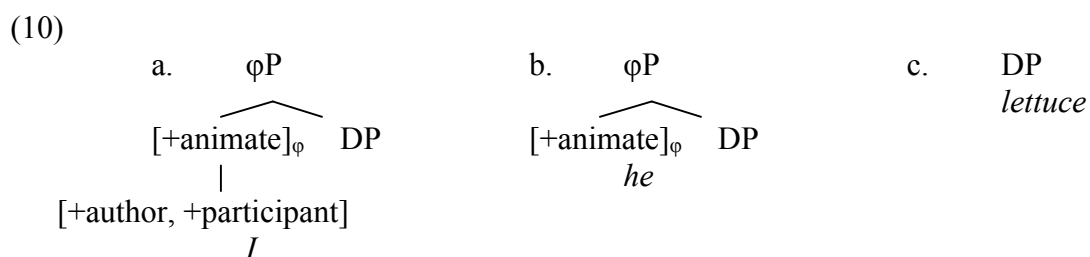

For the sake of completeness, although Richards does not exemplify the distinction in the feature structure of first and second person nominals, I deduce from the hierarchies in (10) that second person arguments bear the phi-feature specification in (11).

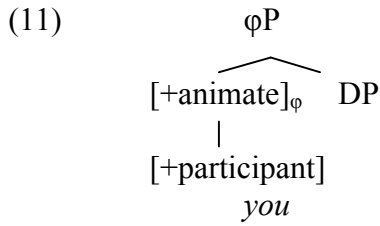

Overall, this kind of phi-feature structural hierarchy accounts for the distinction between:

- (i) Animate and inanimate nominals by the specification of the feature $[\pm animate]_{\varphi}$, which is projected as φP –see (10b) vs. (10c).
- (ii) First/second and third person animate nominals by the specification of the feature $[\pm participant]$ –see (10a) and (11) vs. (10b).
- (iii) First and second person nominals by the specification of the feature $[\pm author]$ –see (10a) vs. (11).

What is important for the present discussion is that, following Harbour (2007), Richards (2010: 82) asserts that every argument entering the derivation in $[\text{Spec}, \nu P]$ must be specified for the features $[\pm author, \pm participant]$, projecting thereby a φP –see also Adger & Harbour (2007). That is to say, regardless of their actual value for animacy, when the nominals in (10) and (11) appear in $[\text{Spec}, \nu P]$ their phi-feature structure will include the specification for the features $[\pm author, \pm participant]$, and thus $[animate]_{\varphi}$, as follows in (12a) for first person, in (12b) for second person, in (12c) for third person animate and in (12d) for third person inanimate. This is a natural assumption taking into account that agents are most frequently human beings.

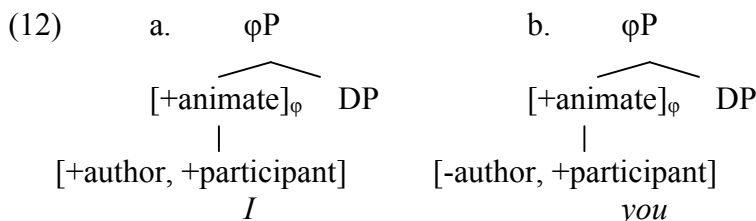

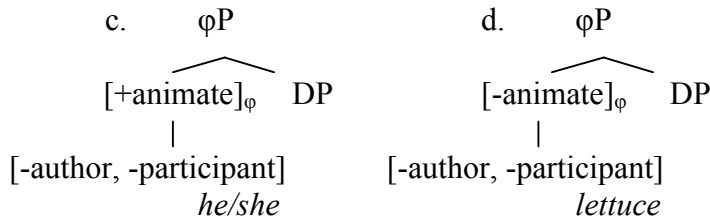

Overall, in order to understand the Spanish data in (8) and (10b), it is specially important to focus on the distinction in the phi-feature specification of inanimate nominals. The same inanimate DP that would have no specification for these features in an object position (10c) is indeed specified for the features [\pm author, \pm participant] –and hence [\pm animate] _{φ} – in [Spec, ν P] (10d), explaining the distribution of DOM in the allegedly problematic Spanish examples in (8) and (9b), repeated here as (13).

- (13)
- | | | | |
|--|--|----------------|------------------------|
| | a. El coche | aplastó | (*a) una lata |
| | the car | crushed.3sg | DOM one can |
| | <i>'The car crushed a can.'</i> | | |
| | | | |
| | b. El vino | emborrachó | * (a) varios invitados |
| | the wine | made drunk.3sg | DOM several guests |
| | <i>'The wine made several guests drunk.'</i> | | |

Given that the subject is always a φ P, a Distinctness effect arises whenever the object is a φ P too, as the linearization statement of the TP Spell-Out domain will be $\langle \varphi$ P, φ P \rangle , uninterpretable for PF. Such a linearization statement is precluded by adding a K phasal head to the object. The K head involves the differential marker and provides an independent Spell-Out domain for the object holding it. All in all, given that the label of the transitive subject is always of the φ P type, DOM emerges whenever the object is animate –and specific– and bears the same φ P label as the subject (Richards 2010: 83). This is exactly what happens in the example in (13b). Conversely, when the object is inanimate and bears the label DP, the linearization statement formed with the subject will be $\langle \varphi$ P, DP \rangle , and being well formed for the linearization algorithm, no Distinctness effect –and hence, no DOM– will arise. This is the case in (13a).

5.2.4. Interim summary

Summing up, Richards' (2010) Distinctness Condition accounts for the DOM in languages where specific objects are considered to undergo Object Shift to the edge of

the [Spec, ν P], ending up in the same linearization domain as the transitive subject, which is in turn in [Spec, TP]. As transitive subjects are always represented as ϕ P, a Distinctness effect arises when the object is a ϕ P –i.e., animate– too, because, being identical elements in an asymmetric c-command relation, the $\langle \phi$ P, ϕ P \rangle linearization statement in the TP Spell-Out domain happens to be uninterpretable for PF. Consequently, in order to avoid the derivation to crash, a K phasal head –i.e., the differential marking– is added to the object. Due to its phasal nature, this makes the object linearize in a separate Spell-Out domain, and the derivation proceeds as usual. On the contrary, no Distinctness effect emerges when the object is inanimate, and thus, bears the label DP instead of ϕ P. In this case, the linearization statement in the TP Spell-Out domain will be $\langle \phi$ P, DP \rangle , and involving distinct elements, the derivation converges. This is how Richards (2010: 25-32) accounts for the DOM in languages like Spanish, Hindi, Chaha and Miskitu, languages where the differential marking is governed both by animacy and specificity, as in Basque.

5.3. THE DERIVATIONAL DISTINCTNESS CONDITION

In the next section, I discuss the application of the Distinctness Condition to account for the DOM attested in Basque varieties. I argue that Basque DOM is in fact triggered by the Distinctness Condition. Notwithstanding, rather than taking it to be evaluated at Spell-Out domains, I pursue the idea that Distinctness is to be avoided derivationally, as soon as a complement of a phase is formed throughout the syntactic derivation –as already suggested by Richards (2010: 86-87, 114, 117, 125-126).

Richards (2010: 1, 7) notes that the Distinctness Condition in (4), repeated for convenience in (14), is a condition on the syntax-phonology interface, a PF constraint applied just when the material in a given Spell-Out domain is sent to phonology.

- (14) Distinctness: If a linearization statement $\langle \alpha, \alpha \rangle$ is generated, the derivation crashes (Richards 2010: 5)

In its original version, the Distinctness Condition is thus evaluated at the moment in which a given Spell-Out domain is transferred to the phonological interface. However,

the fact that the Distinctness Condition has a phonological justification does not necessarily imply that the condition holds exclusively at the syntax-phonology interface. In this section I propose that the Distinctness Condition can be active from the very beginning of the syntactic derivation, and that Basque DOM emerges as soon as the object and the subject coincide in the ν P phase domain. Therefore, I consider that the Distinctness Condition in (14) should be avoided as soon as possible throughout the syntactic derivation, adhering to the Derivational version of the Distinctness Condition depicted by Richards (2010: 114) as in (15).

- (15) Derivational Distinctness: given a choice between operations, prefer the operation (if any) that causes a Distinctness violation to appear as briefly as possible in the derivation (Richards 2010: 114).

As pointed out by Richards (2010: 117), the Derivational Distinctness requires the grammar to circumvent the Distinctness violation that was created most recently. Under this approach, Distinctness violations are to be avoided derivationally, starting from the first steps of the syntactic derivation. Hence, given that the object and the subject trigger a Distinctness effect as soon as the latter enters the derivation in [Spec, ν P], it follows from (15) that the K head providing a separate Spell-Out domain to the object should be added in the ν P domain.

Three main pieces of evidence hold the proposal that the Distinctness Condition applies derivationally, in the ν P phase domain. First, as I explain in section 5.3.1, the lack of evidence arguing for Object Shift leaves open the possibility that, instead of moving to the TP Spell-Out domain, DOM objects are linearized in their original position, within the VP linearization domain. Second, in 5.3.2, I claim that the availability of DOM to occur in interrogative contexts indicates that the Distinctness effect triggering the differential marking does not arise in the TP Spell-Out domain, because in *wh*-questions one of the two arguments is linearized in the CP domain –the same happens in Spanish, as noted by Richards (2010: 125). Third, in section 5.3.3, I point out that the fact that DOM co-occurs along with an ergative subject suggests that the differential marking yields in the ν P domain. Otherwise, taking into account the KP shell of the structural ergative subject in [Spec, TP] (Rezac et al. 2014), no Distinctness effect should arise in the TP Spell-Out domain. All these facts imply that in Basque the Distinctness effect

leading to DOM should be avoided in the ν P phase domain, which is the unique realm where both the subject and the object co-occur with the ϕ P label.

Once argued that Basque DOM emerges in order to avoid a Distinctness effect in the ν P phase domain, section 5.3.4 asserts that other approaches of configurational Case assignment involving Dependent Case (Marantz 1991, Bittner & Hale 1996, Preminger 2014, Baker 2015) face one main problem when accounting for the phenomenon under study. Apart from maintaining that the differential marking is assigned after the object shifts to the TP Spell-Out domain, these approaches assume that configurational –i.e., Dependent– Case is assigned to nominals that are unlicensed for Case. However, as demonstrated in chapter 4, DOM objects are in fact Case licensed by entering into Agree with ν . Hence, this poses a problem for those accounts involving Dependent Case to account for Basque DOM.

To finish, having discarded other kind of configurational Case assignments, section 5.3.5 presents the actual application of the Derivational Distinctness Condition in Basque varieties displaying DOM. The section is ultimately closed in section 5.3.6 by summing up the main claims made in it.

5.3.1. Lack of evidence for Object Shift

As explained in section 5.2, the original version of the Distinctness Condition takes Object Shift as a precondition for the differential marking to be assigned in the TP Spell-Out domain. If Distinctness effects are only avoided when Spell-Out domains are linearized in phonology, the object and the subject will only trigger a Distinctness violation under the condition that the former shifts to the edge of the ν P phase. Put it in other words, if DOM arises when the object is linearized in the same Spell-Out domain as the transitive subject, Object Shift to [Spec, ν P] must have taken place, because the subject is linearized in the TP Spell-Out domain, namely, in [Spec, TP]. This is in fact a problem for the implementation of the Distinctness Condition in Basque DOM varieties, as these show no evidence for Object Shift.

Cross-linguistically, DOM has frequently been related to the phenomenon of Object Shift, especially in languages where the differential marking is governed by specificity.

In these languages, definite objects can in general shift, but shifting an indefinite object is only possible if this is interpreted as specific (Aissen 2003: 474-475). Hence, as in these languages DOM is only attested with specific objects, the assignment of the differential marking has often been linked to the higher position of the object outside VP –see, among many others, Diesing & Jelinek (1993) and Jelinek & Carnie (2003). In this sense, it is not surprising at all that Richards (2010) assumes that DOM objects undergo Object Shift in languages where the differential marking is conditioned (among others) by specificity, as has been argued for languages like Spanish (Torrego 1998, Leonetti 2004, López 2012, Ormazabal & Romero 2013abc) or Hindi (Mahajan 1990, Butt 1993, Bhatt & Anagnostopoulou 1996).

This section explores two main pieces of evidence that have been used in the literature to test whether DOM objects shift from their base position or not. In 5.3.1.1, I focus on word order facts regarding DOM objects and VP-adverbs. Considering that VP-adverbs occur at the left edge of VP, Object Shift has commonly been demonstrated by the ‘DOM object > VP-adverb’ word order. As DOM objects generate as complements of V, their placement to the left of VP-adverbs indicates that these objects shift from their original position. In section 5.3.1.2, I deal with word order facts concerning DOM objects and indirect objects. Assuming the ‘direct object > indirect object’ base word order, the ‘DOM object > indirect object’ linear order has been used to support an Object Shift movement in many DOM languages. As we will see, neither of these pieces of evidence is able to determine whether Basque DOM objects shift to a higher position outside VP or not, leaving open the possibility that DOM objects remain in their base position.

5.3.1.1. Word order with respect to VP-adverbs

One of the main pieces of evidence arguing for Object Shift in DOM languages comes from the interaction of the differential marking and word order with regards to VP-adverbs. Baker & Vinokurova (2010: 602), for instance, demonstrate that in Sakha specific objects bearing the differential marking carry out Object Shift, because they appear before VP-adverbs like *türgennik* ‘quickly’. This is exemplified in the contrast between (16a) and (16b). In (16a) the specific object occurs just to the left of *türgennik*

‘quickly’ and accusative marking –i.e., the differential marking– is in turn obligatory. On the contrary, the non-specific object in (16b) is placed to the right of *türgennik* ‘quickly’, and in this case the differential marking is only allowed if the noun *salamaat* ‘porridge’ has contrastive focus, but not in neutral word order.

- (16) a. Masha salamaat-*(y) türgennik sie-te.
 Masha porridge-ACC quickly eat-PAST.3SS
 ‘Masha ate the porridge quickly.’
- b. Masha türgennik salamaat-(#y) sie-te.
 Masha quickly porridge- ACC eat- PAST.3SS
 ‘Masha ate porridge quickly.’

Considering that adverbs like *türgennik* ‘quickly’ are introduced at or close to the left edge of VP, Baker & Vinokurova (2010: 602) conclude that the contrast in word order exhibited by DOM and non-DOM objects reflects that only the former undergo Object Shift. Baker & Vinokurova (2010: 595) account for the correlation between Object Shift and accusative Case assignment by means of the Dependent Case. These authors argue that accusative Case is assigned when the object is c-commanded by another nominal that lacks a Case value within the same phase domain. Taking VP and CP to correspond to phase domains, they argue that the objects that remain in the VP phase do not receive Case, because VP does not contain any other nominal that c-commands the object and lacks a Case value. This would be the case in (16b). On the contrary, these authors state that when the object carries out Object Shift and moves to the CP phase, this happens to be c-commanded by the subject, which is also unmarked for Case. In this scenario, both the object and the subject enter into a Case competition, and the object ends up being assigned accusative –i.e., Dependent– Case, as in (16a).

Contrary to Sakha, in Basque VP-adverbs cannot be used to verify whether specific/definite objects undergo Object Shift or not, because these are not introduced to the left edge of VP, but rather at the complement position of V. Elordieta (2001: 192-297) reports that Basque VP-adverbs involve manner adverbs like *txarto* ‘badly’, *gogor* ‘hard’ and *ondo* ‘well’. This kind of adverbs modifies (part of) VP, as they occur adjacent to the finite verbal form (17a) (adapted from Elordieta 2001: 200), and are unable to precede the object (17b) (Elordieta 2001: 200) or the subject (17c) (Elordieta 2001: 200).

- (17) a. Jon-ek ipuinak ondo kontatzen ditu
 Jon-E stories.A well tell AUX[3plA-3sgE]
'Jon tells stories well.'
- b. *Jon-ek ondo ipuinak kontatzen ditu
 Jon.E well stories.A tell AUX[3plA-3sgE]
- c. *Ondo Jon-ek kontatzen ditu ipuinak
 well Jon-E tell AUX[3plA-3sgE] stories.A

Being the most deeply embedded element to the left of the finite verb, Elordieta (2001: 194-196) analyzes Basque VP-adverbs to be generated in the VP domain, as inner complements of V. This author argues that well-type adverbs like *txarto* 'badly' are not originated left adjoined to VP, because they occur not only to the right of DP complements as happens in (18a) (adapted from Elordieta 2001: 194), but also to the right of PP complements, as in (18b) (Elordieta (2001: 195).

- (18) a. Jon-ek azterketa txarto burutu du
 Jon-E exam.A badly finish AUX[3sgA-3sgE]
'Jon has made the exam badly.'
- b. Athletic Real Madrid-en aurka (oso) gogor lehiatu da
 Athletic Real Madrid-gen against(very) hard compete AUX[3sgA]
'Athletic has played/competed hard against Real Madrid.'

If these adverbs were adjoined to VP and DP complements underwent Object Shift, the adverb should appear to the right of DP complements, but to the left of PP ones, as Object Shift takes place with DPs, but not PPs. However, this is not what we find in Basque, because as illustrated in (19), manner-adverbs like *txarto* 'badly' can neither precede PP complements (Elordieta 2001: 195).

- (19) *Athletic (oso) gogor Real Madrid-en aurka lehiatu da
 Athletic (very) hard Real Madrid-gen against compete AUX[3sgA]
'Athletic has played/competed hard against Real Madrid.'

Therefore, I agree with Elordieta (2001), in claiming that manner adverbs are not generated adjoined to VP.¹²³ Otherwise, if these were generated to the left edge of VP,

¹²³ As observed by Elordieta (2001: 196), manner adverbs like *txarto* 'badly' can neither be generated as head adjoined to V, because they allow the degree modifier *oso* 'very'.

two different things should happen. First, as noted by Elordieta, the adverb should precede PPs but not DPs if DP objects underwent Object Shift. Second, the adverb should follow both PPs and DPs if DP objects did not undergo Object Shift. As shown in (17), (18) and (19), neither of these facts is true for Basque, as manner adverbs follow both DP as well as PP complements. This leads Elordieta (2001: 196) to the conclusion that VP-adverbs are introduced as inner complements of V.

On this assumption, Basque gives us no option to test whether specific/definite objects undergo Object Shift to the edge of the vP phase. Given that all kind of – specific/definite and non-specific/indefinite– objects are generated structurally higher than manner adverbs, a possible Object Shift triggered by specificity/definiteness would not make any contrast in the word order of the object with respect to the adverb. As a matter of fact, Elordieta (2001: 194) points out that the definiteness or specificity of the object does not lead to any distinction in the placement of the object with regards to manner adverbs like *txarto* ‘badly’. Consider, for instance, the examples in (20), where both the specific/definite object *azken azterketa* ‘last exam’ (20a) and the non-specific/indefinite *azterketa bat* ‘a exam’ (20b) are placed to the left of the adverb *txarto* ‘badly’ (Elordieta 2001: 194).

- (20) a. Jon-ek azken azterketa txarto burutu du
 Jon-E last exam.A badly finish AUX[3sgA-3sgE]
 ‘Jon has made the last exam badly.’
- b. Jon-ek azterketa bat txarto burutu du
 Jon-E exam one.A badly finish AUX[3sgA-3sgE]
 ‘Jon has made an exam badly.’

In this regard, note that the adjacency of the adverb with respect to the finite verb is equally attested both in specific/definite and non-specific/indefinite objects (Elordieta 2001: 194). *Txarto* ‘badly’-type manner adverbs are only allowed to occur immediately to the left of the finite verbal form. Consider now the examples in (21).

- (21) a. ??txarto azken azterketa / azterketa bat burutu du
 badly last exam.A / exam one.A finish AUX[3sgA-3sgE]
 ‘Jon has made the last exam / an exam badly.’
- b. *Txarto Jon-ek azken azterketa / azterketa bat burutu du
 badly Jon-E last exam.A / last exam.A finish AUX[3sgA-3sgE]

As pointed out by Elordieta (2001: 197-198), a potential movement of the object to a structurally higher position would not affect the word order with regards to the adverb, as the adverb is introduced lower than the base position of the object itself. As a consequence, I conclude that the ordering with respect to manner adverbs makes it impossible for Basque to demonstrate that the object moves to the edge of *vP*, a crucial condition if DOM is understood to emerge when the object linearizes in the same TP Spell-Out domain as the transitive subject.

5.3.1.2. Word order in ditransitive constructions

Along with the position regarding VP-adverbs, ditransitive constructions may give us another piece of evidence indicating an Object Shift movement. This has been done in languages like Hindi, where the differential marking is governed by both animacy and specificity (Mahajan 1990, Butt 1993, Bhatt & Anagnostopoulou 1996). Bhatt & Anagnostopoulou (1996), for instance, argue that in Hindi specificity makes DOM –i.e., *-ko* marked– objects move out of VP, a claim that is supported by the word order contrast in ditransitive constructions involving specific vs. non-specific objects –see also Bhatt (2006) and Linares (2012). As illustrated in (20a), in Hindi the base order for ditransitive constructions is ‘indirect object > direct object’ (Bhatt & Anagnostopoulou 1996: 13). Nonetheless, the ordering between the two internal arguments reverses when the direct object is specific and thus receives the differential marking. When this is so, the DOM object precedes the indirect object, as in (22b). The contrast between (22a) and (22b) then proves that DOM objects shift to a position structurally higher than the indirect object, and that the differential marking correlates with that higher position.

- (22) a. Ram-ne Anita-ko chitthii bhej-ii
 Ram-E Anita-D letter.F send- PERF.F
‘Ram sent the letter to Anita.’
- b. Ram-ne chitthii-ko Anita-ko bhej-aa
 Ram-E letter-DOM Anita-D send- PERF
‘Ram sent the letter to Anita.’

Similar facts are shown by Baker & Vinokurova (2010: 602-603) too. These authors report that the goal is always marked dative in Sakha, and that the theme can be unmarked or accusative marked depending on its value regarding

specificity/definiteness, which correlates with the word order with respect to the goal. When the theme is unmarked for case, it must be a non-specific indefinite and it must occur after the goal, as in (23a). On the contrary, when the theme is marked accusative, it is interpreted as specific or definite and it is placed before the goal, as in (23b) – unless additional, focus-driven movements take place.

- (23) a. Min Masha-qa kingie-(#ni) bier-di-m.
 I Masha-D book-ACC give-PAST-1SS
'I gave Masha books/a book.'
- b. Min kingie-*(ni) Masha-qa bier-di-m.
 I book-ACC Masha-D give-PAST-1SS
'I gave the book to Masha.'

The contrast in (23) thus proves that in Sakha, specific/definite objects undergo Object Shift to a position higher than the goal dative.

Persian is another language where DOM objects have been proved to undergo Object Shift (Karimi 2003). In Persian, specific objects bear the particle *-ra* –i.e., the differential marking– and can precede the indirect object, while non-specific objects bear no marking at all and occur adjacent to the verb. This is illustrated in the contrast between (24) and (25). In (24), the object is interpreted as non-specific and occurs after the indirect object. On the contrary, the object in (25) is interpreted as specific and appears before the indirect object. This happens both when the object is definite as in (24aa) and (24a), and when it is indefinite as in (25b) and (25b). Karimi (2003: 92) notes that in Persian, non-specific objects (24) occur adjacent to the verb in unmarked word order and that these objects can only separate from the verb in a very limited fashion, by representing contrastive focus –recall that this was also the case in Sakha (Baker & Vinokurova 2010: 602).

- (24) a. Kimea aghlab barâ mâ she'r mi-xun-e
 Kimea often for us poem HAB-read-3sg
'It is often the case that Kimea reads poetry for us.'
- b Kimea aghlab barâ mâ ye she'r az Hafez mi-xun-e
 Kimea often for us a poem from Hafez hab-read-3sg
'It is often the case that Kimea reads a poem by Hafez for us.'

(25) a. Kimea aghlab hame-ye she'r-â-ye tâza-sh-ro barâ mâ
 Kimea often all-Ez poem-pl-Ez fresh-her-DOM for us
 mi-xun-e
 hab-read-3sg

'It is often the case that Kimea reads all her new poems for us.'

b. Kimea aghlab ye she'r az Hafez-ro barâ mâ
 Kima often a poem by Hazef-DOM for us
 mi-sum-e
 hab-read-3sg

'It is often the case that Kimea reads a (particular) poem by Hafez for us.'

Let us now focus on the relation between DOM and word order in ditransitive constructions in Basque. In Basque, the neutral word order in ditransitive constructions with an agreeing indirect object is known to be 'indirect object > direct object' –see de Rijk (1969), Hualde (1988), Laka (1988 1993), Ortiz de Urbina (1989), Fernández (1997), Montoya (1998), Artiagoitia (2000), Elordieta (2001) and Oyharçabal (2010). This is illustrated in the example in (26), where the goal indirect object *Joni* 'to Jon' precedes the theme direct object *liburua* 'the book'.

(26) Miren-ek Jon-i liburua eman dio
 Miren-E Jon-D book.A give AUX[3sgA-3sgD-3sgE]
'Miren has given Jon the book.'

Hence, as in Hindi, Sakha and Persian, if DOM objects underwent Objects Shift in Basque, the linear ordering of the internal arguments should change to 'DOM object > indirect object'. Unfortunately, as happens with VP-adverbs, ditransitive constructions provide us no evidence to verify whether DOM objects carry out Object Shift or not.

In order to test whether in Basque the DOM object precedes the indirect object in ditransitive constructions, we need to analyze double dative constructions, that is to say, constructions involving both a DOM and a dative marked indirect object. In chapter 4 (section 4.6) we have seen that for some DOM speakers the verb *saldu* 'sell' allows a double dative construction when the object is first or second person. This is the case in (27).

(27) a. Traidore-ek ni-ri etsaia-ri saldu didate
 traitors-E i-D enemy-D sell AUX[1sgD-3plE]
'The traitors have sold me to the enemy.'

b. Traidore-ek zu-ri etsaia-ri saldu dizute
 traitors-E you-D enemy-D sell AUX[2sgD-3plE]
 ‘The traitors have sold you to the enemy.’

In (27) both the DOM and the goal indirect object are marked dative, but only the former is cross-referenced by the finite verbal form.¹²⁴ Besides, the DOM object occurs preceding the goal indirect object, coinciding with the data provided in other studies dealing with similar constructions (Albizu 1997a, Arraztio 2010, Fernández & Rezac 2010 2016, Odria 2014).¹²⁵ Therefore, based on the ‘DOM>indirect object’ word order, one could deduce that these examples involve Object Shift of the DOM object. This would be reinforced by the fact that the reverse word order in examples like (27) happens to be marked for some DOM speakers. This is illustrated in (28), where the non-agreeing goal indirect object precedes the first or second person DOM object.

¹²⁴ Recall from chapter 4 (section 4.6) that this is the only option in double dative constructions involving a DOM and a goal dative, as only the latter can occur as a non-agreeing PP.

¹²⁵ Similar to (27a), the double dative construction provided by Albizu (1997a: 38) bears a dative marked indirect object and a finite verbal form that agrees by means of a dative marker with the first person object. However, contrary to (27a), in Albizu’s example the object is marked absolutive instead of dative, as in (i).

(ii) Azpisapo-ek ni etsaia-ri saldu didate
 traitor-E I-A enemy-D sell AUX[3sgD-3plE]
 ‘The traitors have sold me to the enemy.’

In the rest of the examples gathered by Arraztio (2010) in Araitz-Betelu and analyzed by Fernández & Rezac (2010: 137 2016: 122) both the direct and indirect object are marked dative as in (27a) and the DOM object occurs to the right of the indirect object. Consider the example in (ii).

(iii) Deabruak ne-i saldu diate etsia-i
 demons.E I-D sell AUX[1sgD-3plE] enemy-D
 ‘The demons have sold me to the enemy.’

The only difference attested between (ii) and (27a) above is that the goal is placed after the finite verb in (ii). Examples like (ii) are also common among my consultants. In fact, one of them adds that placing the indirect object after the finite verb avoids parsing difficulties that could arise when having two dative phrases close to each other.

- (28) a. ??Traidore-ek etsaia-ri ni-ri saldu didate
 traitors-E enemy-D i-D sell AUX[1sgD-3plE]
 ‘The traitors have sold me to the enemy.’
- b. ??Traidore-ek etsaia-ri zu-ri saldu dizute
 traitors-E enemy-D you-D sell AUX[2sgD-3plE]
 ‘The traitors have sold you to the enemy.’

Be that as it may, recall from chapter 4 (section 4.6) that the examples in (27) involve a repair strategy used to avoid PCC effects, namely the PP repair strategy (Rezac 2011). Such a strategy adds uninterpretable phi-features to the P head of the goal indirect object, which is generated as complement of V, structurally lower than the direct object. As the addition of uninterpretable phi-features activates the Agree/Case locus of P, this lets the goal Agree with it, and as a consequence, remains in its base position, that is to say, lower than the first or second person object. Hence, instead of an Object Shift of first and second person DOM objects, in examples like (27) the ‘DOM object > indirect object’ word order could simply arise as a consequence of the activation of the Agree/Case locus in P. Actually, in chapter 4 (section 4.5) we have seen that the same word order is generally –although not invariably– attested when the first or second person object is absolutive instead of dative and –by resorting to the PP repair strategy– the goal is left as a non-agreeing PP. Consider the examples in (29), which show that some speakers prefer the first or second person object to be placed before the non-agreeing goal –similar examples with the same ‘direct object > indirect object’ word order with the verb *saldu* ‘sell’ are given by Albizu (1997a), Etxepare & Oyharçabal (2008a), Arraztio (2010) and Fernández & Rezac (2010 2016).^{126 127}

¹²⁶ The same ordering is also displayed by other PCC-affected examples provided by Oyharçabal & Etxepare (2012: 151-152) with the verb *aurkeztu* ‘introduce’.

- (i) Egun hartan zu ere Jon-i aurkeztu zintudan
 that day.INE you.A too Jon-D introduce AUX[2sgA-1sgE]
 ‘On that day, I introduced you too to Jon.’
- (ii) Egun hartan ni ere zu-ri aurkeztu ninduen Jon-ek
 that day.INE I.A too you-D introduce AUX[1sgA-3sgE] Jon-E
 ‘On that day, Jon introduced me too to you’

- (29) a. Traidore-ek ni etsaia-ri saldu naute
 traitors-E I.A enemy-D sell AUX[1sgA-3plE]
 ‘The traitors have sold me to the enemy.’
- b. Traidore-ek zu etsaia-ri saldu zaituzte
 traitors-E you.A enemy-D sell AUX[2sgA-3plE]
 ‘The traitors have sold you to the enemy.’

As stated by Etxepare & Oyharçabal (2008a: 28), “it is suggestive that at the same time that the mere possibility of agreement is eliminated from the clause, the dative shows up following the direct object”.

However, despite the preference for first and second person objects to occur before the non-agreeing goal dative, it should be noted that the ‘direct object > indirect object’ ordering with non-agreeing goals is not definitive at all, and that it should be tested by the same Barss & Lasnik’s (1986) tests used by Elordieta (2001) when proving that the neutral word order in ditransitive constructions is ‘indirect object > direct object’.¹²⁸ This should be done with ditransitives containing non-agreeing datives in northeastern Basque, as in these varieties, non-agreeing datives are attested regardless of the person specification of the object –for further details on the c-command relations in non-agreeing northeastern datives see Ormazabal & Romero (2017).

In absence of definite evidence showing the contrary, I thus adhere to the default hypothesis that in PCC-affected contexts non-agreeing goals that occur along with first and second person objects remain in their original position, that is, in the complement position of V. Consequently, in absence of P-incorporation, the goal does not move to [Spec, ApplP] and remains in its original position. This explains not only the ‘DOM object > indirect object’ linear order in (27), but also the ‘direct object > indirect object’ word order in (29). On that assumption, the fact that the DOM object precedes the

¹²⁷ Some of the consulted speakers admit that if the indirect object was placed to the left of the first or second person object the latter would be interpreted as focused, given that in Basque focalized elements occur just preceding the finite verbal form.

¹²⁸ In fact, Rezac (2009b: 774, 2011: 184, 246) provides a couple of PCC-affected examples with the predicate *eraman* ‘carry’ where the second person object appears after the goal indirect object.

indirect object in examples like (27) cannot be taken as an indication of an Object Shift movement placing DOM objects at the edge of the ν P phase.

Therefore, the possible Object Shift carried out by DOM objects could only be tested in ditransitive constructions involving a third person human and definite object and a goal Indirect object, because in this case the goal indirect object would correspond to an agreeing dative in [Spec, ApplP] –recall that third person objects do not trigger PCC effects and thus that the goal undergoes P-incorporation as usual. However, as far as I know, double dative constructions with third person DOM objects are not attested in Basque DOM varieties. As shown in (30), in this case, the object can only be marked absolutive, as in Standard Basque.

- (30) Traidore-ek Miren/-(*-i) etsaia-ri saldu diote
 traitors-E Miren.A/-D enemy-D sell AUX[3sgA-3sgD-3plE]
 ‘The traitors have sold Miren to the enemy.’

In (30), the third person human and definite object is placed to the left of the indirect object in order to demonstrate that the DOM object is in fact ruled out in a potential configuration involving Object Shift.¹²⁹

All in all, in Basque, ditransitive constructions are unable to show whether DOM objects undergo Object Shift or not, because: (i) when the object is first or second person, the goal seems to remain in its base position –i.e., structurally lower than the object, and (ii) when the object is third person, absolutive rather than dative marking is assigned to it.

5.3.1.3. Interim summary

Synthesizing, neither the placement with regards to VP-adverbs nor the ordering with respect to the indirect object allows us to check whether DOM objects undergo Object

¹²⁹ Although the unmarked word order in ditransitives is ‘indirect object > direct object’, Albizu (2001: 57) notices that the direct object can indeed precede the indirect object in the base word order of predicates like *aurkeztu* ‘introduce’ or *gomendatu* ‘recommend’. The same could happen for some of the consulted speakers with the verb *saldu* ‘sell’ as well, as with third person objects these allow both the ‘indirect object > direct object’ as well as the ‘direct object > indirect object’ word order.

Shift or not.¹³⁰ Yet the lack of evidence indicating Object Shift does not automatically imply that in Basque DOM objects do not undergo Object Shift. The data in this section simply leave open the possibility that DOM objects undergo Object Shift or not. Recall that this weakens the claim that in Basque DOM emerges when the object leaves the VP Spell-Out domain and linearizes in the TP domain along with the transitive subject. Object Shift is a precondition for this situation to hold, and in absence of positive evidence, it seems untenable to rely on it by arguing that the Distinctness effect leading to DOM arises in the TP Spell-Out domain. Nonetheless, this does not directly lead us to conclude that DOM in Basque does not arise as a byproduct of the Distinctness Condition. Basque DOM can still be explained with the Distinctness Condition if we assume that the condition is active from the very beginning of the syntactic derivation. Although the subject ends up linearizing in the TP Spell-Out domain, the object and the subject coincide in the *v*P phase domain. Thus, it is reasonable to think that a Distinctness effect may be visible in such a domain, and that possible Distinctness violations should be avoided as soon as possible, even before a given Spell-Out domain ends up being transferred to the PF interface (Richards 2010: 86-87, 114, 117, 125-126). As we will see in the next section, this is in fact supported by the behavior of DOM in interrogative contexts.

5.3.2. DOM in interrogative contexts

By analyzing the distribution of Spanish DOM, Richards (2010: 125) points out that DOM objects are attested both in declarative as well as interrogative contexts. That is to say, interrogative clauses like (31b) allow DOM objects in the same way as declarative clauses like (31a); the proper noun *Juan* is marked by the preposition *a* in both of them (Richards 2010: 125).

¹³⁰ Note that this discards other proposals independent from configurational Case assignment arguing that Object Shift is a precondition for DOM objects to check Case. This is the view taken by Torrego (1998), Rodríguez-Mondoñedo (2007), López (2009 2012) and Ormazabal & Romero (2013abc) for Spanish DOM, among others –see also Bhatt & Anagnostopoulou (1996) for Hindi. Although the need for movement is differently articulated in each account, they all coincide in arguing that highly referential objects move from their first merge position and check their [*u*Case] feature in a derived position.

- (31) a. Juan conoció a María en Buenos Aires
 Juan met.3sg DOM María in Buenos Aires
 ‘*Juan met María in Buenos Aires.*’
- b. ¿A quién conoció Juan en Buenos Aires?
 DOM who met.3sg Juan in Buenos Aires
 ‘*Who did Juan meet in Buenos Aires?*’

Richards highlights that in (31b) the object wh-phrase *a quién* ‘to whom’ must be headed by the phasal K head, even though the wh-movement makes it linearize in a separate Spell-Out domain. In (31b), the object *a quién* ‘to whom’ is linearized in the CP domain and the subject *Juan* in the TP domain. Note that this fact is unexpected if the K head providing a separate Spell-Out domain is added in the TP Spell-Out domain, that is, in a domain where –after undergoing Object Shift– the animate and specific object ends up being c-commanded by the transitive subject. Put it otherwise, if Distinctness effects are only visible at the syntax-phonology interface, no K head should be added in interrogative contexts like (31b), because there is no Spell-Out domain containing identical elements in an asymmetric c-command relation. Taking the facts in (31) into consideration, Richards (2010: 126) proposes that the Distinctness Condition is not simply met in the final PF representation, and that Distinctness violations must be avoided throughout the syntactic derivation. This way, if Distinctness effects are satisfied derivationally, there is nothing problematic with the example in (31b).

For the sake of completeness, it is worth pointing out that in Spanish DOM is also allowed in interrogative contexts when the subject is a wh-phrase Spelled-Out at the CP domain. This is what happens in (27) (adapted from Richards 2010: 125).

- (32) ¿Quién conoció a Juan en Buenos Aires?
 who met.3sg DOM Juan in Buenos Aires
 ‘*Who met Juan in Buenos Aires?*’

Similar to (31b), in (32), the subject *quién* ‘who’ and the object *a Juan* are linearized in separate Spell-Out domains: the former in the CP domain and the latter in the TP domain –under the condition that it undergoes Object Shift. Yet the object bears the K head –i.e., the preposition *a*– that emerges in order to avoid a Distinctness violation. Recall again that if Distinctness is to be satisfied just at the last step of the syntactic derivation, the *a*-marker of the object has no motivation to arise in contexts like (32).

On the contrary, if Distinctness is a PF constraint applied in syntax derivationally, DOM should be expected both in declarative as well as interrogative contexts. In a Derivational version of the Distinctness Condition, the object would cause a Distinctness effect as soon as the subject entered the derivation in [Spec, ν P], because ν P is the first domain where the subject and the object co-occur regardless of the final interrogative or declarative value of the clause.

Crucially, Basque varieties with DOM pattern like Spanish in allowing DOM to arise both in declarative as well as interrogative constructions. On the one hand, the examples in (33) show that DOM is attested when the subject is a wh-phrase linearized in the CP domain.

- (33)
- | | | | | | |
|----|--|-----------|----------------|-----------|----------|
| a. | Zein-ek | engainatu | dit | | (ni-ri)? |
| | who-E | deceive | AUX[1sgD-3sgE] | | I-D |
| | <i>'Who has deceived me?'</i> | | | | |
| b. | Zein-ek | bota | dit | ur-etara | (ni-ri)? |
| | who-E | throw | AUX[1sgA-3sgE] | water-ALL | I-D |
| | <i>'Who has thrown me to the water?'</i> | | | | |
| c. | Zein-ek | utzi | dit | kale-an | (niri)? |
| | who-E | leave | AUX[1sgD-3sgE] | sreet-INE | I-D |
| | <i>'Who has let me in the street?'</i> | | | | |

In the three examples in (33) the subject *zeinek* 'who' is Spelled-Out in the CP domain and the object *niri* 'I' in the ν P domain –or alternatively, in the TP domain if it carried out Object Shift. It thus seems that the grammar should be aware of the Distinctness Condition from the very beginning of the derivation. Otherwise, it would be unexpected that the object bore the differential marking when linearizing separately from the subject, as was also the case in (32). Thus, the availability of DOM to occur in interrogative contexts reinforces the claim suggested by the lack of evidence for Object Shift, namely, that the Distinctness effect leading to DOM should be repaired as soon as possible throughout the syntactic derivation. If Distinctness were exclusively visible at final PF representations, it would be in trouble to account for the presence of DOM in interrogative examples like (33). On the contrary, taking a Derivational approach of the Distinctness Condition allows us to capture the presence of DOM in contexts where the object and the subject are Spelled-Out separately in a straightforward way.

On the other hand, for some –although not all– speakers, Basque DOM can also occur when the object is a wh-phase Spelled-Out in the CP domain, as in (34) –parallel to Richards (2010: 125) Spanish example in (31b). Interrogative sentences like (34) are quite marginal for some DOM speakers, especially with the verbs *bota* ‘throw’ (34b) and *utzi* ‘leave’ (34c).¹³¹ For these speakers the object should bear absolutive rather than dative Case. This may be due to the fact that the wh-phase *zeini* ‘who’ is indefinite in nature and, in Basque DOM objects are commonly definite.¹³² In spite of this, the indefinite nature of the object does not seem to make these examples completely ungrammatical for all the consulted speakers, giving further support to the claim that the Distinctness Condition applies derivationally in Basque.

- (34) a. Zein-i engainatu diozu gezur horrekin?
 who-D deceive AUX[3sgD-1sgE] with that lie
 ‘Who have you deceived with that lie?’

¹³¹ As noted in chapter 2 (section 2.4.1.3), in Basque the distribution of DOM can also be determined by the nature of the verb. This is the case in (34), where dative marking of the wh-object seems to be more natural with *engainatu* ‘deceive’ (34a) than with *bota* ‘throw’ (34b) and *utzi* ‘leave’ (34c).

¹³² The possibility for the wh-phrase to bear the differential marking is also striking in Spanish, where DOM objects are known to be specific. As pointed out by Fábregas (2013: 22), this is not only the case with wh-phrases (i), but also with other personal pronouns that are non-specific in all possible interpretations. This is the case in (ii) and (iii) (Fábregas 2013: 22).

- (i) ¿*(A) quién viste en el parque?
 DOM who saw.3sg in the park
 ‘Who did you see in the park?’
- (ii) No vi *(a) nadie en el parque
 not saw.1sg DOM nobody in the park
 ‘I didn’t see anybody in the park.’
- (iii) Vi *(a) alguien en el parque
 saw.1sg DOM someone in the park
 ‘I saw someone in the park.’

Thus, the possible contradictory character of the examples in (34) is not exclusive to Basque, and other DOM languages seem to face the same problem. Be it as it may, explaining the existence of wh-phrases bearing the differential marking is outside the scope of the discussion and will be left to analyze in future research.

b. (?/??)Zein-i bota diozu ur-etara?
 who-D throw AUX[3sgD-2sgE] water-ALL
 ‘Who have you thrown to the water?’

c. (?/??)Zein-i utzi diote kale-an?
 who-D leave AUX[3sgD-3plE] street-INE
 ‘Who have they left in the street?’

In (34), the object is Spelled-Out in the CP domain and the subject in the TP domain. Despite this fact, the object is marked dative. These and the examples in (33) lead us to conclude that the differential marking should not be assigned at the last step of the syntactic derivation. Rather than being active just at the final PF representation, it seems that Distinctness violations must be avoided whenever possible throughout the syntactic derivation (Richards 2010: 87, 114). As pointed out by Richards (2010: 117) the grammar seems to be required to repair the Distinctness violation that was created most recently. This implies that the K head should be added within ν P, as soon as the transitive subject enters the derivation and creates a Distinctness effect if the object is also specified for animacy. Considering the distribution of DOM in interrogative contexts, in this chapter I thus pursue the Derivational approach of the Distinctness Condition, presented in (15) and repeated in (35) (Richards 2010: 114).

- (35) Derivational Distinctness: given a choice between operations, prefer the operation (if any) that causes a Distinctness violation to appear as briefly as possible in the derivation (Richards 2010: 114).

In Richards’ (2010: 114) words, “given a choice between a derivation in which a Distinctness violation appears and one in which it does not appear, the grammar prefers the derivation in which it does not appear (even if both derivations, in the end, yield representations that obey Distinctness)”. This is exactly what happens in interrogative contexts. In interrogative sentences, although a Distinctness effect is attested in the ν P domain, the final representation does never display a Distinctness violation, as the wh-phrase –be it the subject or the object– is always linearized alone in the highest Spell-Out domain.

One could still maintain the claim that Distinctness is evaluated at PF, assuming that wh-movement involves two chains: an A-chain to [Spec, TP] in the case of the subject and to [Spec, ν P] in the case of the object, and an A’-chain to [Spec, CP] in both of

them (Chomsky 2008). Considering that *wh*-phrases leave a copy in an A-position, this would imply that the Distinctness Condition is only aware of A-positions. However, I believe this is not a desired direction, because Richards (2010: 7) explicitly notes that the Distinctness Condition is not aware of unpronounced copies, as these do not count for the linearization algorithm –an expected result if the condition is phonologically motivated.

All in all, in Basque the Derivational approach of the Distinctness Condition is not only suggested by the lack of evidence arguing for Object Shift (section 5.3.1.), but required by the availability to have DOM in interrogative contexts. Thus, I assume that, instead of being only visible at Spell-Out domains, Distinctness effects are detectable from the very beginning of the syntactic derivation. Consequently, I state that the K phase head distinguishing the object from the subject is added in the *v*P phase domain, as early as the transitive subject enters the derivation in its specifier (Richards 2010: 86-87, 114, 117, 125-126). Let us now focus on the third and last piece of evidence pointing into the same direction: the co-occurrence of DOM objects with ergative subjects in [Spec, TP].

5.3.3. DOM with ergative subjects

Contrary to what happens in accusative languages, in ergative languages like Basque DOM co-occurs with an ergative subject, that is, an argument that is morphologically marked too. This seems to be contradictory if DOM arises as a result of the Distinctness Condition applied at Spell-Out domains, because the grammar would make a nominal marked even when the other nominal appearing in the same domain –i.e. the transitive subject– is marked as well. Following the line of argumentation in previous sections, in what follows I argue that such a contradiction disappears once we take the Distinctness Condition to apply derivationally, namely, in the *v*P phase domain where both the subject and the object bear the same ϕ P label.

Accusative languages such as Spanish mark both transitive and intransitive subjects with (unmarked) nominative Case and assign (marked) accusative Case to the object. In contrast, ergative languages like Basque distinguish between transitive and intransitive subjects and assign (marked) ergative Case to transitive subjects, while leaving both

intransitive subjects and transitive objects with (unmarked) absolutive Case.¹³³ This is exemplified in the Spanish (36) and Basque (37) sentences below.

- (36) a. Tú has despertado al niño
 you have.2sg wake up DOM the child.M
'You have woken up the child.'
- b. Tú has venido a casa
 you have.2sg come to house
'You have come at home.'
- (37) a. Zu-k umea esnatu duzu
 you-E child.A wake up AUX[3sgA-2sgE]
'You have woken up the child.'
- b. Zu etxe-ra etorri zara
 you.A house-ALL come AUX[2sgA]
'You have come at home.'

In Spanish (36), neither the transitive (36a) nor the intransitive (36b) subject bears marked Case and the accusative *a*-marker makes the object bear a marked Case. On the contrary, in Basque, the marking of the subject is different in transitive (37a) and intransitive constructions (37b), and only the transitive subject bears a marked Case, that is, the ergative *-k*. As illustrated by (37a), the object is left unmarked, with absolutive Case. Thus, in transitive constructions, Spanish assigns the marked Case to the object, while in Basque the argument receiving the marked Case happens to be the subject.

Contrary to the pattern attested in Standard Basque, non-Standard DOM varieties mark both the subject and the object of transitive constructions with a (marked) Case: ergative for the subject and dative for the object. This makes Basque more similar to accusative languages like Spanish. Consider the contrast between standard (37a) and non-tandard (38) Basque.

¹³³ As it is not relevant for the present discussion, I abstract away from the distinction between unaccusative and unergative constructions in Basque intransitives: unaccusative subjects bear absolutive Case and unergative subjects ergative Case. For an innovative analysis, see Berro (2015).

- (38) Zu-k umea-r-i esnatu diozu
 you-E child-D wake up AUX[3sgD-2sgE]
 ‘You have woken up the child.’

In the DOM Basque example in (38), both the subject and the object are morphologically marked: the former bears the ergative marker *-k* and the latter the dative *-ri*, both of them cross-referenced by the finite verbal form –the subject by the marker *-zu* and the object by *-o-*. This is again something unexpected if DOM arises in the TP Spell-Out domain assuming that ergative arguments are KPs receiving such K head when raising to [Spec, TP], as suggested by Rezac et al. (2014: 1313-1319). If the subject in [Spec, TP] involves a KP, no Distinctness effect will arise with the ϕ P object if the latter shifts to the TP Spell-Out domain and the addition of the differential marking will be unmotivated.

Based on Case alternations attested in modal constructions, Rezac et al. (2014) correlate the morphological markedness of ergative arguments with the marked nature of their Case assignment. These authors argue that subjects with absolutive Case are in a low position –i.e., in the complement position of V, because absolutive Case assignment derives directly from *v*-Agree. On the contrary, subjects with ergative Case are in a high position, in [Spec, TP], as ergative Case is assigned if and only if T-Agree is followed by movement to [Spec, TP]. The different positions of ergative and absolutive subjects are depicted in the syntactic trees in (39) and (40) respectively. (39) illustrates the derivation of the subject in a transitive construction like (37a) and (40) the derivation of the subject in an intransitive like (37b).

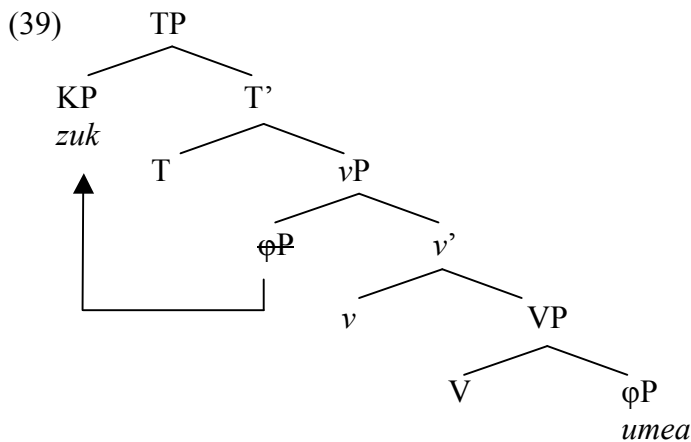

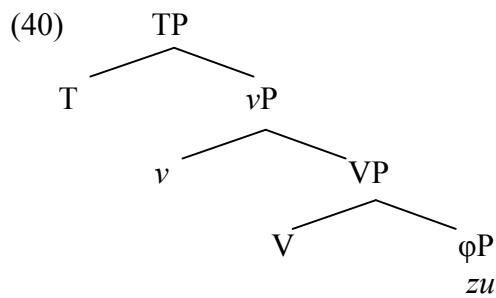

The way an argument receives ergative Case is thus more marked than the way it receives the absolutive. The ergative subject Agrees with T in its original [Spec, vP] position, but moves to [Spec, TP] in order to receive ergative Case. Hence, ergative agreement arises from the T-Agree relation carried out from [Spec, vP], but ergative Case requires movement apart from T-Agree. Conversely, absolutive subjects receive both Case and agreement by Agreeing with *v* from their base generated position. This is how Rezac et al. (2014) parallelize the marked syntactic derivation of ergative subjects with their morphologically marked nature, and the unmarked syntactic behaviour of absolutive subjects with their morphologically unmarked pattern.

Developing the marked syntax of ergative arguments, Rezac et al. (2014: 1316) state that ergative DPs involve an extra layer of structure –i.e., a KP above the DP– that needs to be licensed by movement or the resulting configuration: “merge of α to a probe/selector β can add structure to α determined by β , in contrast to Agree alone that only modifies the extra features of α and β ”. Hence, markedness in ergative arguments is reflected both in the need to move apart from Agree, and in the layers of the nominal –i.e., KP apart from DP. This contrasts with the unmarked nature of absolutive arguments: Case as a result of *v*-Agree and no K layer for the argument.

Therefore, and coming back to our main concern, if ergative subjects in [Spec, TP] are KPs that contrast with absolutive DPs, there will be no reason for the differential marking to arise in the TP Spell-Out domain, because being involved within a KP, the ergative subject will be linearized separately from the object. The ergative KP nature of the subject is then problematic if –under the condition that DOM objects undergo Object Shift– Distinctness effects are only visible at final Spell-Out domains. This is depicted in the syntactic tree in (41).

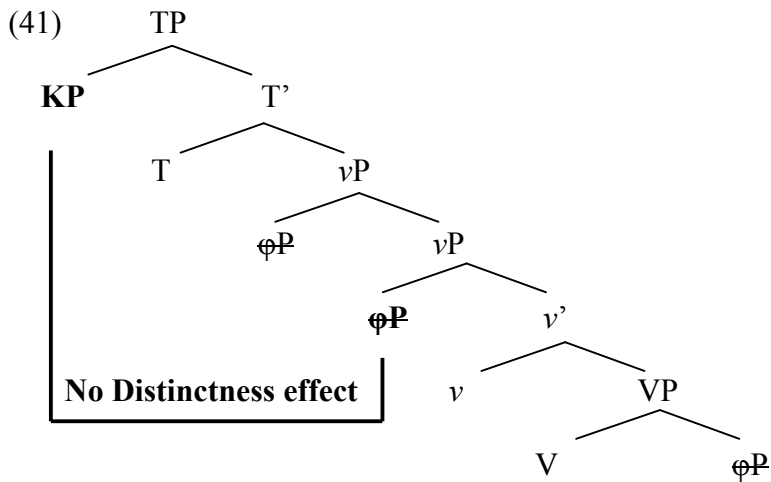

In (41), taking into account the KP phasal nature of the ergative subject in [Spec, TP], no Distinctness violation should arise with the object and the subject in the TP Spell-Out domain. The object is a ϕ P and the subject a KP. However, in Basque we do have DOM in the presence of an ergative KP subject; an unexpected pattern if Distinctness is to be evaluated only at Spell-Out domains.

For the purposes of the discussion, it is important to observe that such problem disappears once we assume that Distinctness effects are avoided in the v P domain, that is, before the subject raises to [Spec, TP] and becomes consequently a KP. It is only in the v P domain where both the subject and the animate object bear the same ϕ P label, which may trigger a Distinctness effect, and thus the addition of the K head. This follows naturally both from the lack of evidence arguing for Object Shift and the possibility to have DOM in interrogative contexts. If the Distinctness violation caused by the object and the subject yields in the v P domain, no Object Shift is required to account for DOM and nothing is unexpected with having DOM in interrogative contexts and with ergative subjects. Therefore, although triggered by the syntax-phonology interface, I argue that the Distinctness Condition should be satisfied as soon as possible, from the very beginning of the syntactic derivation.

Before closing the discussion on the Derivational nature of the Distinctness Condition, it is worth pointing out that other DOM languages with an ergative configuration show a similar situation too. As noted by Torrego (2012: 217-218), this is the case of Hindi.

In Hindi, the differential *-ko* marking of the object co-occurs along with the ergative *-ne* marking of the subject. Consider the example in (42) (Torrego 2012: 217).

- (42) Ila-ne ek bacce-ko ut^haayaa
 Ila-E one child-DOM lift/carry-PERF
 ‘Ila lifted a child.’

Torrego (2012) analyzes the ergative marking in Hindi as a P head involving inherent Case and follows Richards’ (2010) Distinctness Condition to account for the differential marking of the object: *-ko* is considered to be a K phase head that provides the object a separate Spell-Out domain. In order to reinforce the PP –rather than KP– nature of the subject, Torrego (2012: 218) regards to the KP nature of the object, and argues that if the DOM object is a KP that emerges as a consequence of the Distinctness Condition, the subject should not be a KP too. Otherwise, each of them would involve a separate Spell-Out domain and no Distinctness effect would arise between the subject and the object. Nonetheless, it is worth noting that such a deduction is only tenable if one assumes that the K head of the object can only be added in the final Spell-Out domain, that is to say, in the TP domain, once the object undergoes Object Shift. Instead, if the K head leading to DOM is assigned derivationally –i.e., in the *vP* domain, the subject can equally be a KP, receiving the K head at [Spec, TP]. In this case, a Distinctness effect would arise in the *vP* domain, because this would contain two ϕ P arguments: the object in the complement position of V and the subject in [Spec, *vP*].

Following Richards (2010: 214, fn. 61), Torrego (2012: 218, fn. 10) also considers that the Hindi ergative subject may also be analyzed as a KP (or a PP) if the K (or P) is not a phase head. In a short discussion on DOM in ergative languages, Richards (2010: 214, fn. 61) suggests that the ergative KP could be non-phasal, because the DP object dominated by the KP subject would always be safe from being c-commanded by the former, leading to a linearizable statement. That is to say, as the subject is covered in a KP (or PP), be it phasal or not, the K (or P) head will always prevent the DP within it from c-commanding the lower object, and the Distinctness Condition will not be violated in the TP domain. Again, note that this would be a problem if the Distinctness Condition were understood to apply simply at Spell-Out domains, because DOM would emerge in absence of a Distinctness effect in the TP domain. Hence, it seems that the

DOM in Hindi could be accounted for more easily by taking the Distinctness Condition to hold derivationally. As in Basque, DOM in Hindi could then arise in the vP Spell-Out domain, as soon as the subject enters the derivation in $[Spec, vP]$. Notwithstanding, this requires that the ergative subject enters the derivation as a ϕP too, and not as a PP, as argued by Torrego (2012). Otherwise, the P head would impede the subject from c-commanding the object, regardless of its phasal/non-phasal nature. As a consequence, the PP inherent subject would never trigger a Distinctness effect with the object, and there would be no reason for the differential marking –i.e., the K head– to arise –neither at syntax nor at Spell-Out domains. This is depicted in (43). Taking this into account, I tentatively suggest that a structural analysis of the ergative Case seems to be more suitable if DOM in Hindi is analyzed as a device to avoid a Derivational Distinctness effect.

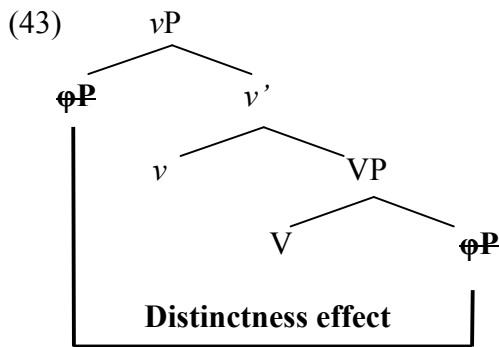

Finally, I would like to highlight that taking the Distinctness Condition to be Derivational leads us to another consequence regarding the discussion on Object Shift. If the K head is added in the vP domain, the differential marking will not depend on the object undergoing Object Shift. That is, if the differential marking is assigned as soon as the subject enters in $[Spec, vP]$, the Object Shift movement attested in many DOM languages should be taken to be independent from the addition of the K head, an operation taking place after the assignment of the differential marking. This is a desired result, as it implies that the Derivational Distinctness Condition accounts not only for the DOM in languages with Objects Shift, but also for languages without it. Therefore, the Distinctness Condition happens to be superior to other configurational approaches where Case assignment is determined at the last step of the syntactic derivation, for

instance, the Dependent Case approach. As I will explain in the next section, the Dependent Case approach can only account for the DOM in languages with Object Shift, because it requires the object to move to the edge of the vP phase in order to be able to receive the differential marking.

5.3.4. Against the Dependent Case approach

Along with the Distinctness Condition, the configurational Case assignment in DOM objects has also been analyzed from a Dependent Case approach. Before definitely concluding that Basque DOM is triggered by the Derivational Distinctness Condition, in what follows I briefly review the analyses arguing for a Dependent Case in DOM objects and point out some of the drawbacks these proposals have when applying to Basque.

The Dependent Case was originally proposed by Marantz (1991) as one of the ways a nominal can receive Case without relating to a functional head. Marantz (1991: 24) presented the Dependent Case as in (44), which was meant to account for accusative Case by applying it downward to the object and ergative Case by applying it upward to the subject.

- (44) Dependent Case is assigned by V+I to a position governed by V+I when a distinct position governed by V+I is: (i) not “marked” (does not have lexically governed case), (ii) distinct from the chain being assigned dependent case.

Adapting Marantz’s leading idea, recent research on Case assignment has incorporated the –originally morphological– Dependent Case assignment into narrow syntax, implying that structural Case is not only assigned functionally, but also configurationally –see, among many others, Baker & Vinokurova (2010), Baker (2012 2015), Preminger (2014) or Levin & Preminger (2015). In line with Marantz (1991), these authors consider the Dependent Case as an alternative to the functional Case assignment. As stated in chapter 4, the functional –i.e., structural– Case assignment follows exclusively from an Agree relation between an argument and a functional head, no matter whether any other argument is present in the same local domain. The Agree relation between the argument –i.e., goal or controller– and the functional head –i.e., probe or target– consists of valuing each other’s uninterpretable features and, as a

consequence, it requires that both of them bear the same bundle of features, that is, interpretable in one of them and uninterpretable in the other. Such a relation is structurally determined within a phase domain, and in order for the two elements to enter into Agree, the nominal must be c-commanded by the head with which it Agrees (Chomsky 2000 2001).

Contrary to the functional or structural Case assignment, the Dependent Case assignment is based on the configuration itself. Instead of the functional head, in this case the only relevant aspect is the presence of another non Case-valued argument in the same Spell-Out domain –similar to Richards’ (2010) Distinctness Condition in this respect. Although Marantz (1991 2000) –and subsequent work by McFadden (2004) and Bobaljik (2008)– took the Dependent Case to be assigned at morphology, other authors like Baker & Vinokurova (2010: 638-640), Preminger (2014: chapter 9) and Baker (2015: 74) have claimed that it should take place in narrow syntax, as it employs purely syntactic mechanisms like c-command or syntactic domain. This way, they replace Marantz’s (1991) notion of “governed by the same V+I” by Spell-Out domain, that is, complement domain of a given phase that is transferred to the interfaces (Chomsky 2000 2001). As pointed out by Baker (2015: 47-50), other modifications from Marantz’s (1991) first definition of Dependent Case are the following: (i) notions like “assignment up” and “assignment down” reduce to the relative position of the two nominals, defined in terms of c-command, and (ii) instead of abstract “positions”, the participants in the Dependent Case assignment are nominals that occupy these positions. Modifying Marantz’s (1991) statement in (44), Baker & Vinokurova (2010: 595), for instance, claim that the distinction between ergative-absolutive and accusative-nominative languages derives from (45).

- (45) a. If there are two distinct NPs in the same spell out domain such that NP1 c-commands NP2, then value the case feature of NP2 as accusative unless NP1 has already been marked for case.
- b. If there are two distinct NPs in the same spell out domain such that NP1 c-commands NP2, then value the case feature of NP1 as ergative unless NP2 has already been marked for case.

For the purposes of the discussion it is important to highlight that the Dependent Case is known to be assigned once each phase is reached and its complement is sent to Spell-

Out. This implies that it faces the same problems faced by the Distinctness Condition when applied exclusively at Spell-Out domains. Let us focus on Sakha (Baker & Vinokurova 2010) in order to see how the Case assignment rule in (45a) applies in a language with DOM.

As we have seen in section 5.3.1, in Sakha, definite or specific objects undergo Object Shift and are marked accusative Case. On the contrary, indefinite or non-specific ones remain in situ and are left unmarked. Baker & Vinokurova (2010) correlate the Object Shift movement with accusative Case assignment by arguing that when an object shifts to the edge of the vP phase, it ends up being Spelled-Out in the same TP domain as the subject, leading to the application of Dependent Case rule in (45a). Hence, Object Shift plays a crucial role in the accusative Case assignment, because the object has to be in the same Spell-Out domain as the subject –which is in [Spec, TP]– in order to employ the rule in (45a). Object Shift is thus a precondition for the Dependent accusative Case to be assigned, as it is for the original Distinctness Condition applied exclusively at Spell-Out domains. The application of (45a) is invariantly dependent on previous Object Shift of the object, given that the subject and the object interact in Case assignment only if the latter undergoes Object Shift. If the object remains in its original position, the subject and the object will be sent to Spell-Out in different domains and the Dependent Case will not be assigned, leaving the object unmarked. Therefore, accusative Case arises when the object is c-commanded by the subject in the same TP Spell-Out domain, and nominative Case ensues otherwise.

Although the Dependent Case seems to be suitable for DOM languages like Sakha (Baker & Vinokurova 2010, Baker 2012 2015, Levin & Preminger 2015), three main problems arise when applying it to Basque DOM varieties. As I have already pointed out, the first drawback is that it requires the object to undergo Object Shift in order to receive Dependent Case, and –as concluded in section 5.3.1– this cannot be evidenced in Basque. In this respect, the empirical coverage of the Dependent Case is thus identical to the original version of the Distinctness Condition (Richards 2010), which assumes that the condition is only visible at the syntax-phonology interface.

The second problem has to do with the fact that the object and the subject are required to enter into a Case competition in order to assign the Dependent Case to the object. In this approach, the two nominals in a given configuration are considered to be Case competitors, as explicitly stated in the Case assignment rule in (45a): “unless NP1 has already been marked for case.” This is again a problem for Basque DOM varieties, since both the object and the subject would already be Case marked by the time they entered into the Case competition resulting in the differential marking being assigned to the object. As claimed in chapter 4, the object Agrees with *v* and has its [*u*Case] feature valued as absolutive. Likewise, the ergative marking of the subject arises by means of T-Agree followed by movement to [Spec, TP]. Consequently, in the Basque varieties under study, there would be no reason for the subject and the object to enter into a Case competition. An argument that has already received a Case value has no necessity to receive another Case value by entering into a Case competition with another nominal. Taking this into account, the Dependent Case assignment would then be unmotivated in Basque DOM varieties.

The third disadvantage displayed by the Dependent Case approach is that it is over-generating in the sense that it predicts inanimate objects that are definite or specific to bear the differential marking. The assignment of the Dependent Case is expected with all definite or specific objects undergoing an Object Shift movement. Hence, the only relevant factor determining the presence of the differential marking seems to be specificity, and not animacy. In order to accommodate the role played by animacy in this approach, Object Shift should not only be sensitive to specificity, but also to animacy –or even person, as Basque DOM is sensitive to both of them –see chapter 2 (section 2.4). However, as noted by Aissen (2003: 475), animacy and person alone are never associated to Object Shift. On this assumption, I conclude that the Dependent Case assignment has difficulties to account for the fact that Basque DOM is always governed by the animacy of the object.

The problems displayed by the Dependent Case approach are straightforwardly circumvented by the Derivational Distinctness Condition (Richards 2010: 86-87, 114, 117, 125-126). The Derivational Distinctness Condition explains the presence of DOM configurationally, but (i) without assuming a Case competition between the object and

the subject, (ii) without taking Object Shift to be a precondition for the differential marking, and (iii) by accounting for the animacy or person factor triggering the differential marking. On the one hand, the Derivational Distinctness Condition does not assume a Case competition between the two arguments that occur in the same configuration, and the K head is assigned due to a requirement of the configuration itself, not because of the need of a given argument to receive Case. On the other hand, if the Distinctness Condition is taken to apply derivationally, no Object Shift is required for the object to trigger a Distinctness effect with the subject, as the differential marking can arise in situ, within the ν P phase domain. Finally, as shown in section 5.2.3, the Distinctness Condition provides a way to explain the impact that features like person or animacy may have in the marking of the object.

5.3.5. The Derivational Distinctness Condition in Basque DOM varieties

Having laid out the main tenets of the Derivational Distinctness Condition, let us now examine how human and definite objects end up receiving the differential marking in Basque DOM varieties.

In chapter 3, we have concluded that DOM objects enter the derivation as DPs, in the same structural position as canonical absolutes, namely, as complements of V. Likewise, chapter 4 has demonstrated that DOM objects do also Agree with the ν head, receiving thereby absolutive Case. In this chapter, I propose that dative Case in DOM objects is triggered by a Distinctness effect attested in the ν P phase domain, when the subject enters the derivation in [Spec, ν P] (Richards (2010: 86-87, 114, 117, 125-126). This is the case of a sentence like (46), depicted in the syntactic tree in (47). As in Spanish, the examples in (46) show that Basque DOM is only dependent on the animacy of the object and that the subject in a DOM construction can be either animate as in (46a) or inanimate as in (46b). This reinforces the claim that subjects enter the derivation specified for animacy –i.e., as ϕ Ps– regardless of their exact value for animacy.

- (46) a. Lagun-ek ur ertz-era eramán zidaten
 friends-E seashore-ALL carry AUX[1sgD-3plE]
 ‘My friends carried me to the seashore.’
- b. Olatu-ek ur ertz-era eramán zidaten
 waves-E seashore-ALL carry AUX[1sgD-3plE]
 ‘The waves carried me to the seashore.’

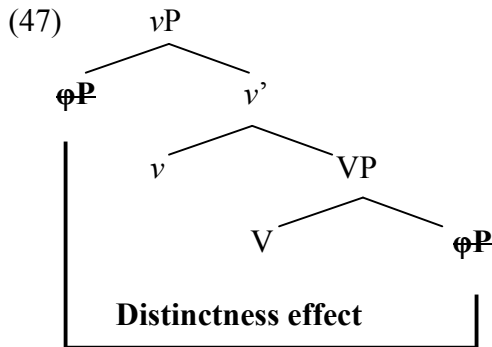

In (47), the human and definite object *ni* ‘I’ enters the derivation in the complement position of V and receives absolutive Case by Agreeing with the *v* head. When the *vP* phase is completed by introducing the subject *–lagunek* ‘the friends’ in (46a) or *olatuek* ‘the waves’ in (46b)– in [Spec, *vP*], the subject and the object trigger a Distinctness effect, because both bear the same ϕ P label. Bearing non-distinct elements, the Distinctness effect in examples like (46) are thus circumvented by adding the phasal K head to the object. This provides a separate Spell-Out domain to the object. As a result, the nominal within it ends up being linearized separately from the ϕ P subject, as illustrated in (48).

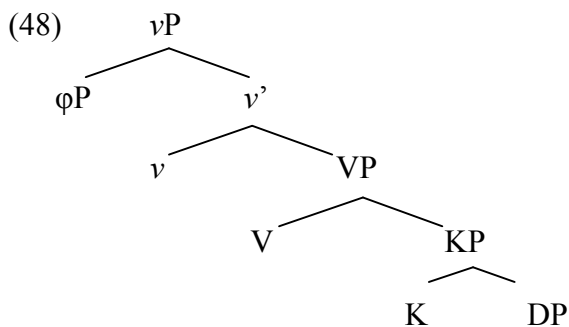

On the contrary, if the object is instead non-human as *txalupa* ‘boat’ in (49), no Distinctness effect arises in the *vP* domain. In this case, the subject displays the ϕ P label

both when animate (49a) and when inanimate (49b), but the object corresponds to a DP. Hence, displaying distinct labels, the Distinctness Condition happens to be directly satisfied. This is depicted in the tree in (50).

- (49) a. Lagun-ek txalupa ur ertz-era eramán zuten
 friends-E boat.A seashore-ALL carry AUX[3sgA-3plE]
 ‘My friends carried the boat to the seashore.’
- b. Olatu-ek txalupa ur ertz-era eramán zuten
 waves-E boat.A seashore-ALL carry AUX[3sgA-3plE]
 ‘The waves carried the boat to the seashore.’

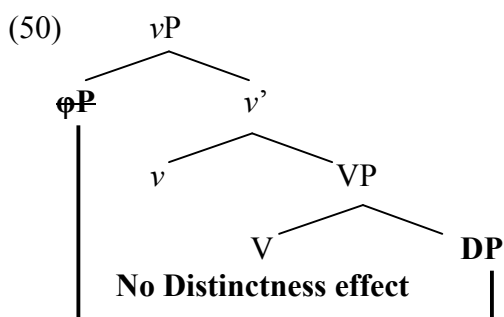

5.3.5.1. [\pm Person] subsumes both animacy and specificity

At this point, it is important to realize that Basque DOM requires modifying the hierarchical phi-feature theory presented in section 5.2.3. With the aim at capturing that third person objects can only be dative marked when the object is human and definite, I substitute Richards’ [\pm animate] feature by the [\pm Person] feature presented by M. Richards (2008). As [\pm animate], [\pm Person] is a single, discrete, binary property, a privative formal feature. M. Richards (2008) argues that, contrary to inanimate and indefinite nominals, animate and definites are specified for the [\pm Person] feature. Thus, [\pm Person] represents not only animacy, but also definiteness. Similar to Harbour (2007) and Adger & Harbour (2007), this author explains that the motivation for using the [\pm Person] feature to express these properties is that first and second person pronouns are always human –and then, animate– and definite.

M. Richards (2008) explains that the semantic content grammaticalized by the [\pm Person] feature may vary from language to language and that languages may differ as to whether they relate the presence of the syntactic [\pm Person] specification with

animacy, definiteness or both –see also Bárany (2015) in this regard. Broadly speaking, the presence of [\pm Person] implies high prominence interpretation, and its absence low prominence interpretation. Developing M. Richards’s (2008) line of reasoning, and assuming that the formal distinction between human and definite vs. non-human and indefinite third person objects is attested in some but not all speakers/varieties –or even verbs, I tentatively propose that only those speakers/varieties with third person DOM distinguish formally between human and definite vs. non-human and indefinite objects. That is to say, for speakers/varieties allowing DOM with third person human and definite objects the feature [\pm Person] would not only be present in first and second person objects, but also in third person objects that are human and definite. In contrast, for speakers/varieties allowing DOM with first and second person objects, the feature [\pm Person] would only be displayed in first and second person objects. For those speakers/varieties, third person arguments would be specified for number only, while those of first and second person would bear phi-specification for both number and [person] features –see chapter 4 (section 4.4) in this regard.

Following Richards’ (2010) phi-feature structural hierarchies presented in section 5.2.3, first (51a) and second (51b) person objects would display the structure in (51). The structure for third person human and definite would be (52a) for speakers/varieties with no third person DOM and (52b) for speakers/varieties with third person DOM.¹³⁴ Finally, (52c) represents the structural hierarchy of third person non-human and indefinite objects in all Basque varieties.

¹³⁴ Crucially, taking third person human and definite objects to bear the [\pm Person] feature requires modifying the Agree/Case approach of the PCC in those speakers/varieties that allow DOM with human and definite objects. Recall from chapter 4 (section 4.4) that third person objects are never targeted by the PCC. Following the Agree/Case approach, this implies that third person objects are not specified for [person] features, and this could be contradictory if human and definite objects bear the [\pm Person] feature in the case of those speakers/varieties with third person DOM. Providing a modified version of the Agree/Case approach of the PCC is outside the scope of this dissertation and I thus leave this issue for future research.

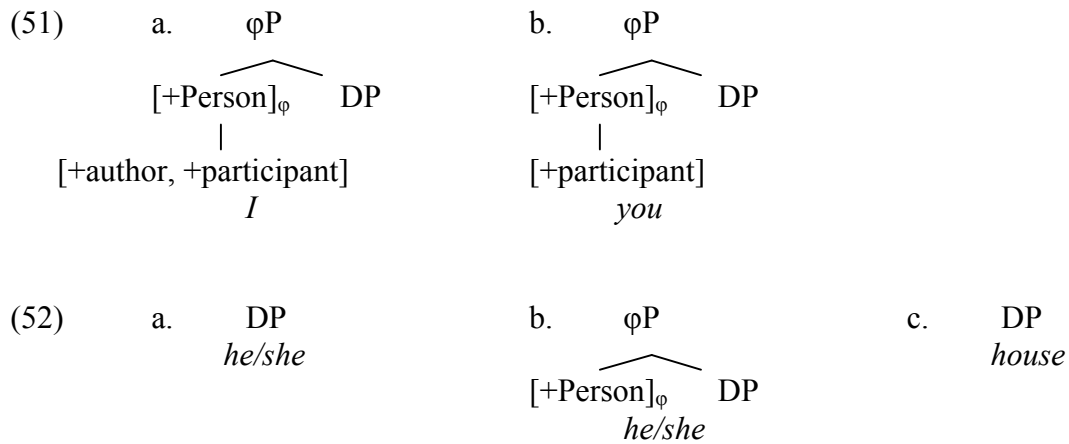

Note that the only differences between the phi-feature hierarchies in (10) and (11) – proposed for Spanish DOM – and those in (51) and (52) below are that in the latter (i) the feature [\pm Person] substitutes that of [\pm animacy], and that (ii) not all speakers/varieties provide a φP label for third person human and definite objects.

Summarizing, and abstracting away from the variation attested among Basque DOM speakers/varieties, table 2 gathers the possible subject-object combinations that trigger or not a Distinctness effect, and thus, DOM.

Subject	Object	Linearization	DOM
φP [+Person] _{φ}	φP [+Person] _{φ}	$\langle \varphi\text{P}, \varphi\text{P} \rangle$	✓
φP [+Person] _{φ}	DP	$\langle \varphi\text{P}, \text{DP} \rangle$	✗
φP [-Person] _{φ}	φP [+Person] _{φ}	$\langle \varphi\text{P}, \varphi\text{P} \rangle$	✓
φP [-Person] _{φ}	DP	$\langle \varphi\text{P}, \text{DP} \rangle$	✗

Table 2: The distribution of DOM within the Derivational Distinctness Condition

At this point of the discussion, it is important to note that linking factors like definiteness to the [\pm Person] feature allows us to account for the referential properties of DOM objects without resorting to an Object Shift movement. By taking Object Shift to be a precondition for the assignment of the differential marking, Richards (2010) limits the feature [\pm animate] to animacy. In his view, specificity is accounted for by

means of Object Shift, which is exclusive to objects showing a positive value for definiteness/specificity. Nonetheless, if Basque DOM lacks evidence arguing for an Object Shift movement and the Distinctness Condition is applied derivationally, it seems more sensible to dissociate definiteness from such movement and link it to the formal feature responsible for triggering a Distinctness effect with the subject, namely, to [\pm Person].

Unifying animacy and specificity within the same formal feature does also make the Derivational Distinctness Condition simpler in languages showing Object Shift. Taking animacy and specificity to be independent from each other and associating animacy to the label ϕ P and specificity to Object Shift, the Derivational version of the Distinctness Condition requires a more complex derivation than the Spell-Out –i.e., original– version. As explained in section 5.2, the Spell-Out version of the Distinctness Condition states that animate objects bearing the label ϕ P trigger a Distinctness effect in the TP domain if these are specific and have previously undergone Object Shift. This is how Richards (2010: 25-32) accounts for the fact that in languages like Spanish DOM is subject to both animacy and specificity. If the object is non-specific and does not undergo Object Shift, animate objects bearing the ϕ P label will not end up in the TP Spell-Out domain, and as a consequence, will not trigger a Distinctness effect. This would explain the lack of DOM in animate and non-specific objects. By the same way, if the object is inanimate and bears the label DP, no Distinctness effect will arise if the object is specific and moves to the TP Spell-Out domain. In this case, the subject will be a ϕ P and the object a DP, and being distinct elements, no DOM will emerge. This would be the situation of inanimate and specific objects.

Notwithstanding, the derivation of DOM objects requires additional assumptions if we take the Distinctness Condition to apply derivationally, in the v P phase domain. According to Richards (2010: 87), in this case the object can only receive the K head if it is specific, and thus semantically able of carrying out Object Shift: “we might think of it as a requirement that the relevant K enter into an Agree relation with a higher probe (perhaps v_C) that triggers shift of the object into a higher phase”. Hence, by considering specificity to be linked to Object Shift, Richards (2010: 87) is forced to assume that Distinctness violations within the v P domain must simply be tolerated until the subject

can exit the vP phase. Note that this makes the Derivational Distinctness more ad hoc than the Spell-Out Distinctness, because the addition of the K head depends on an operation –i.e., Object Shift– that takes place later in the derivation. It requires the mechanism assigning the K head to be aware of operations that will next occur, giving rise to a look-ahead pattern. I believe this is not a desired result. On the contrary, if we take specificity to be subsumed by the feature that makes the object bear the label φP , the addition of the K head is no longer dependent on the Object Shift movement, and the look-ahead behavior happens to be avoided. For this reason, I conclude that, both in languages with and without Object Shift; the Derivational Distinctness Condition fits better with an approach that takes the feature represented by the φP label to include both animacy and specificity.

5.3.5.2. The addition of the K head makes DOM objects morphologically identical to the rest of dative arguments

Once the Distinctness effect triggered by the subject and the object is bypassed by the addition of the phasal K head, the φP object becomes a dative KP; a ‘big DP’ bearing an adjoined D clitic head that –licensed by previous v -Agree– moves to [Spec, vP] in order to m-merge with the v head –recall that, being syntactically and prosodically deficient, the D head is required to move to the agreement complex. It is thus the addition of the K head what makes DOM objects diverge from canonical absolutes and converge with the rest of inherent datives. Hence, from the movement in which the object receives the K head, DOM objects become more akin to the rest of agreeing inherent datives in [Spec, ApplP]. The only difference between them is that dative Case in agreeing datives in [Spec, ApplP] is assigned inherently by the Appl head, and configurationally by the Distinctness Condition in the Case of DOM objects.

In spite of their dative marking, in chapter 4 we have posited that DOM objects have their [u Case] feature valued as absolutive by the Agree relation they maintain with the v head. As a consequence, the assignment of dative Case –i.e., which arises due to the addition of the K head– leads to Case stacking (Richards 2007, Pesetsky 2010). Even though having two structural Cases may at first glance seem problematic from a Case Theoretic point of view, this would not be the case of DOM objects. These objects

would not cause any trouble to the Activity Condition, since the argument checks its [μ Case] feature only once in the derivation and each Case value would be located in a separate layer of the nominal. The functional absolute would be assigned in the DP layer by means of ν -Agree and the configurational dative in the KP layer by the Distinctness Condition.

The syntactic tree in (53) depicts the movement of the D clitic head that originates adjoined to the KP object to [Spec, ν P]. Besides, (54) illustrates the m-merger (Matushansky 2006) operation carried out by the D clitic head in [Spec, ν P] with the ν head, which results in the finite verbal form bearing datives markers cross-referencing the DOM object. Recall that when m-merger (Matushansky 2006) takes place, the clitic forms a complex head with the functional head it has previously Agreed with.

The cliticization process of DOM objects is then identical to that we have put forth for the rest of inherent datives in [Spec, ApplP] in chapter 4 (section 4.7). The same steps are followed in both of them: (i) ν -Agree –defective in [person] for inherent datives and regular in both [person] and [number] for DOM objects, (ii) movement of the clitic head to [Spec, ν P] (53) and (iii) m-merger (Matushansky 2006) of the clitic head with ν (54).

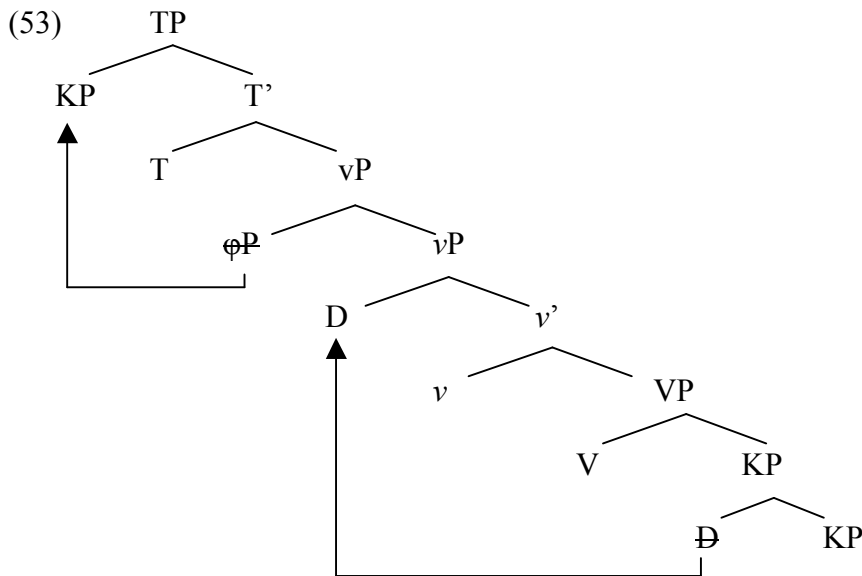

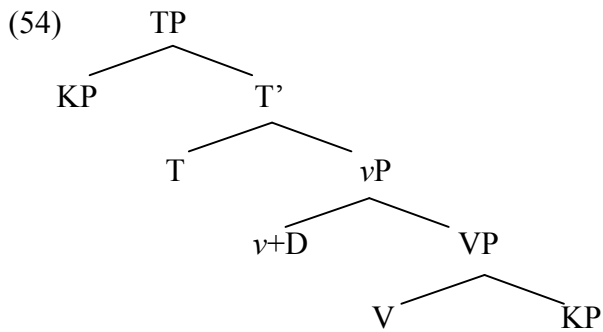

Although DOM objects Agree with v , the finite verbal form cross-referencing a DOM object does only display the dative marker that arises by means of m-merger (Matushansky 2006), and not the absolutive agreement markers that should surface as a result of previous v -Agree. Apart from the morphophonological tendency to realize a given phi-feature once per agreement complex (Rezac 2008b: 85), cross-linguistically it is more common for the verbal form to show no more than clitic markers when a given argument triggers both agreement and clitic markers (Rezac 2008a: 90, Preminger 2014: 59, Kramer 2014: 618-619). This may be due to a Morphological Economy Condition as proposed in Kinyalolo (1991) –see also Cartens (2003: 407-48 2005: 252-255). Taking this into account, the fact that the verbal form agreeing with DOM objects displays dative and not absolutive markers should not be surprising at all.¹³⁵

5.3.6. Interim summary

In this section I have claimed that in Basque DOM arises as a consequence of a Distinctness effect emerging in the vP phase domain. The Distinctness violation holds

¹³⁵ As far as I know, the only exception to this generalization concerns the Basque variety from Oñati, which apart from displaying DOM has also the phenomenon known as Dative Displacement –i.e., the use of absolutive agreement to agree with a dative argument (Rezac & Fernández 2012). In varieties with Dative Displacement, dative arguments are only coded by the finite verbal form by means of absolutive agreement markers. However, Oñati Basque is particular in having both dative as well as absolutive markers when cross-referencing a dative argument in ditransitive finite verbal forms, which affects not only ditransitive configurations, but also transitive ones involving DOM. Therefore, in this case the possibility to have a double bundle of phi-features in the agreement complex is correlated to Dative Displacement, as the rest of DOM varieties lacking this phenomenon can only have a single phi-feature bundle per finite verbal form.

when the transitive subject bearing a ϕ P label enters the derivation in [Spec, ν P] and coincides with an object displaying a ϕ P label too. Therefore, following Richards (2010: 86-87, 114, 117, 125-126) suggestion, I assume that the Distinctness Condition is a PF constraint that is active in syntax from the very beginning of the derivation. Three main pieces of evidence have been presented to support the claim that, instead of arising at the final Spell-Out domain, Basque DOM emerges in the ν P phase domain: (i) the lack of evidence for Object Shift, (ii) the possibility to have DOM in interrogative contexts, and (iii) the co-occurrence of DOM objects with ergative KP subjects. First, the lack of evidence indicating Object Shift leaves open the possibility that, instead of moving to the edge of ν P, Basque DOM objects may stay in situ, linearizing in the VP Spell-Out domain. Second, the availability of DOM to occur in interrogative contexts implies that the differential marking should arise in the ν P phase domain, as in interrogative clauses the arguments triggering the Distinctness effect end up being linearized in separate Spell-Out domains. Third, the fact that DOM objects co-occur with ergative subjects displaying a KP label implies that the Distinctness effect should be visible in the ν P domain. Contrarily, the KP nature of the ergative subject in [Spec, TP] (Rezac et al. 2014) would be problematic to justify a Distinctness violation in the TP Spell-Out domain. These facts have led us to conclude that the Distinctness effect triggering DOM should be avoided in the ν P phase domain, which is the unique realm where both the subject and the object coincide with a ϕ P label.

As I have already pointed out, the Derivational version of the Distinctness Condition is superior to its original version, because it accounts not only for the Distinctness effects that arise at Spell-Out, but also for those that arise throughout the syntactic derivation. The Distinctness Condition is able to capture not only the DOM in accusative languages like Spanish, but also the DOM in ergative languages like Basque. In accusative languages, DOM can be assigned either before or after Object Shift, because the subject bears the ϕ P label both in the ν P as well as CP phase domain. On the contrary, if the ergative subject in [Spec, TP] is a KP, in ergative languages DOM can only be assigned before any possible Object Shift movement, given that the subject and the object only bear the same ϕ P label in the ν P phase domain.

By arguing that Basque DOM is the result of a Derivational Distinctness effect, in this section I have also reviewed the drawbacks that other configurational Case assignment theories involving Dependent Case face when dealing with Basque DOM. The approaches taking the differential marking to correspond to the Dependent Case make two main assumptions that are problematic for its application in Basque. On the one hand, they assume that the object and the subject enter into a Case competition in order to assign the differential marking to the former, which implies that neither of them is previously licensed for Case. On the other hand, they take for granted that the differential marking is assigned in the TP domain and that the object leaves its base position by undergoing Object Shift. Moreover, contrary to the Distinctness Condition (Richards 2010), those approaches involving Dependent Case do not account for the impact made by animacy in marking the object differently, because Object Shift captures only the influence of specificity.

The Derivational Distinctness Condition solves these and other aspects related to the referential factors linked to DOM, as it explains the presence of DOM in configurational terms, though (i) without assuming that the subject and the object are Case competitors, (ii) without assuming that DOM objects necessarily undergo Object Shift, and (iii) by taking into account the role played by animacy in triggering the differential marking.

Overall, in this section I have claimed that the dative Case assignment in DOM objects is the consequence of a Derivational Distinctness effect that takes place in the ν P phase domain. In order to circumvent it, the phasal K head is added to the object, providing the object an independent Spell-Out domain. This makes DOM objects morphologically identical to agreeing inherent datives in [Spec, ApplP]. When the object becomes a KP, a clitic D head is also adjoined to the argument. As with the rest of inherent datives, this moves to [Spec, ν P] in order to undergo m-merger with ν (Matushansky 2006), explaining not only the presence of dative case in the nominal, but also dative markers in the finite verbal form.

In order to support the Derivational Distinctness approach of Basque DOM objects, the following two sections will focus on ditransitive (section 5.4) and derived transitive

(section 5.5) constructions. As we will see, the distribution of DOM in each of these contexts is straightforwardly explained by the approach taken in this section.

5.4. THE DERIVATIONAL DISTINCTNESS CONDITION IN DITRANSITIVE CONSTRUCTIONS

This section addresses the distribution of DOM objects in Basque (section 5.4.1) and Spanish (section 5.4.2) ditransitives following the Derivational Distinctness Condition (Richards 2010). It shows that, in ditransitive contexts, DOM is only possible when combining with a goal dative that is realized as a non-agreeing PP. Agreeing inherent datives that occur in [Spec, ApplP] block the presence of the differential marking, because due to its phasal nature (McGinnis 2001ab 2004), ApplP prevents the object from coinciding with the subject in the ν P phase domain. This gives further support to the Derivational version of the Distinctness Condition, as it accounts not only for the presence but also for the absence of DOM in ditransitive constructions.

5.4.1. DOM depends on the lack of ApplP: the case of Basque

In chapter 4, we have seen that in PCC-affected contexts goals are able occur as PPs, that is, bearing the *-ri* marker in the nominal, but without being cross-referenced by the finite verbal form. This lets first and second person objects Agree with ν both in [person] and [number], and repairs the Case licensing failure that would otherwise occur if the goal appeared in [Spec, ApplP]. The structure involving a PP goal is thus one of the repair strategies attested in PCC-affected contexts: the PP repair strategy (Rezac 2009b 2011). Considering that goals are generated as PP complements of V, following Rezac (2011: 240-247), in chapter 4 (section 4.5), I have assumed that the PP repair strategy consists of adding uninterpretable phi-features to the previously inactive Agree/Case system of the defective P head. In line with Rezac, I have claimed that this fortifies the defective non-phase PP to a full phase PP, giving P the opportunity to Agree with its complement, and making the PP itself invisible to external clausal Agree/Case loci. It is the addition of uninterpretable phi-features to P what avoids PCC effects in ditransitives with first and second person objects.

Besides, in chapter 4 (section 4.6), I have also explained that, at least with the verb *saldu* ‘sell’, when the goal is realized as a PP, first and second person objects are able to be marked dative in DOM varieties, causing thereby a double dative construction. This is what happens in the examples in (55), where along with the PP goal; the first (55a) or second (55b) person object is marked dative both in the nominal and in the verbal auxiliary.

- (55) a. Traidore-ek ni-ri etsaia-ri saldu didate
 traitors-E I-D enemy-D sell AUX[1sgD-3plE]
‘The traitors have sold me to the enemy.’
- b. Traidore-ek zu-ri etsaia-ri saldu dizute
 traitors-E you-D enemy-D sell AUX[2sgD-3plE]
‘The traitors have sold you to the enemy.’

Crucially, double dative constructions like those in (55) are only possible when the object is first or second person. Ditransitives with third person objects are marked absolutive, regardless of their value for animacy and specificity –see section 5.3.1.2. In this section I argue that the contrast between first and second vs. third person objects is straightforwardly explained by the Derivational Distinctness Condition (Richards 2010) and the phasal nature of ApplP (McGinnis 2001ab 2004). The distribution of DOM is dictated by the Derivational Distinctness Condition and depends on the presence or absence of ApplP. When the object is first or second person, goal datives are realized as PPs in their first merge position, and no ApplP is present in the construction. Hence, in those cases, the object will coincide with the subject in the ν P phase domain, as happens in transitive contexts. Contrarily, when the object is third person, no PCC effects arise and the goal moves to [Spec, ApplP] by incorporating the P head to V, which attracts the goal to [Spec, ApplP]. As a consequence, when the object is third person, an ApplP will be placed in between VP and ν P, and this will impede a potential Distinctness effect triggered by the subject and the object.

Let us start examining the behavior of third person human and definite objects in ditransitives bearing a goal dative. As illustrated by (56), third person objects with verbs

like *sell* ‘saldu’ (56a), *deskribatu* ‘describe’ (56b), *gomendatu* ‘recommend’ (56c) or *aurkeztu* ‘introduce’ (56d) are marked absolutive.¹³⁶

- (56) a. Traidore-ek Miren/>(*-i) etsaia-ri saldu diote
 traitors-E Miren.A/-D enemy-D sell AUX[3sgA-3sgD-3plE]
 ‘The traitors have sold Miren to the enemy.’
- b. Lagun-ek Miren/>(*-i) polizia-ri deskribatu diote
 friends-E Miren.A/-D pólíce-D describe AUX[3sgA-3sgD-3plE]
 ‘Her friends have described Miren to the police.’
- c. Lankide-ek Miren/>(*-i) zuzendaria-ri gomendatu
 workmate-E Miren.A/-D boss-D recommend
 diote
 AUX[3sgA-3sgD-3plE]
 ‘Her workmates have recommended Miren to the boss.’
- d. Lankide-ek Miren/>(*-i) zuzendaria-ri aurkeztu
 workmate-E Miren.A/-D boss-D introduce
 diote
 AUX[3sgA-3sgD-3plE]
 ‘Her workmates have introduced Miren to the boss.’

In addition, the same pattern is attested with the same verbs when the goal is first (57) or second (58) person. The human and definite object that combines with a goal dative is always marked absolutive.¹³⁷

¹³⁶ Some speakers say that even in a transitive configuration, third person DOM with *saldu* ‘sell’ and *aurkeztu* ‘introduce’ does not sound very natural to them. In spite of that, these speakers see a clear contrast between the transitive and ditransitive configuration; contrary to the former –where third person DOM would just be marked, DOM with a third person object is completely ungrammatical in the latter.

The verb *gomendatu* ‘recommend’ is different to the rest, as when using it in a transitive frame, the third person object is commonly absolutive marked. *Gomendatu* ‘recommned’ is usually employed ditransitively, with a benefactive dative meaning ‘to recommend someone somebody or something’. Hence, this could lead the consulted speakers to interpret that in this case the single dative object should belong to a benefactive/goal dative, and not to a DOM object.

¹³⁷ The impossibility to have DOM with third person objects in ditransitive contexts is a prevalent pattern among the consulted speakers. With regards to the examples in (57) and (58), the only nuance that could be mentioned is that, although preferring the absolutive marking, one of the consultants admits that marking the object dative would not be completely ungrammatical with *deskribatu* ‘describe’ and

- (57) a. Traidore-ek Miren/*-i) ni-ri saldu didate
 traitors-E Miren.A/-D I-D sell AUX[1sgD-3plE]
'The traitors have sold Miren to me.'
- b. Lagun-ek Miren/*-i) ni-ri deskribatu didate
 friends-E Miren.A/-D I-D describe AUX[1sgD-3plE]
'Her friends have described Miren to me.'
- c. Lankide-ek Miren/*-i) ni-ri gomendatu didate
 workmates-E Miren.A/-D I-D recommend AUX[1sgD-3plE]
'Her workmates have recommended Miren to me.'
- d. Lankide-ek Miren(*-i) ni-ri aurkeztu didate
 workmate-E Miren.a/-D I-D introduce AUX[1sgD-3plE]
'Her workmates have introduced Miren to me.'
- (58) a. Traidore-ek Miren/*-i) zu-ri saldu dizute
 traitors-E Miren.A/-D you-D sell AUX[2sgD-3plE]
'The traitors have sold Miren to you.'
- b. Lagun-ek Miren/*-i) zu-ri deskribatu dizute
 friends-E Miren.A/-D you-D describe AUX[2sgD-3plE]
'Her friends have described Miren to you.'
- c. Lankide-ek Miren/*-i) zu-ri gomendatu dizute
 workmates-E Miren.A/-D you-D recommend AUX[2sgD-3plE]
'Her workmates have recommended Miren to you.'
- d. Lankide-ek Miren(*-i) zu-ri aurkeztu dizute
 workmate-E Miren.a/-D you-D introduce AUX[2sgD-3plE]
'Her workmates have introduced Miren to you.'

The examples in (56), (57) and (58) display the 'direct object > indirect object' word order so as to maintain the parallelism with double dative constructions involving first and second person DOM objects (55), which commonly precede the non-agreeing goal dative. However, it is important to note that the dative marking of the object would equally be ruled out if the ordering of the internal arguments was 'indirect object > direct object'.

gomendatu 'recommend', and a similar judgment is given by another speaker with regards to *aurkeztu* 'introduce'.

As expected, the same thing happens when combining third person human and definite objects with the rest of inherent datives that generate in [Spec, ApplP]. Consider the following examples that combine a third person human and definite object with a causee (59a), an experiencer (59b) or a possessor (59c) DP dative. Again, in (59), the agreeing inherent dative is placed before the third person direct object. However, as was the case with the examples in (56), (57) and (58), the ordering is insignificant in this case too, as the same result would arise if the direct object preceded the causee, experiencer or possessor dative. Besides, although the rest of examples combining a third person human and definite object with an inherent dative involve a ditransitive configuration, note that when the object is combined with an experiencer dative, the resulting construction belongs to a bivalent unaccusative. This is what happens in (59b). As a consequence, the finite verb in examples like (59b) is formed by the intransitive auxiliary verb *izan* 'be' rather than the transitive **edun* 'have'.¹³⁸

- (59) a. Ni-k Jon-i Miren(*-i) esnatu-arazi diot
 I-E Jon-D Miren.A/-D wake up-CAUSAUX[3sgA-3sgD-1sgE]
'I have made Jon wake up Miren.'
- b. Jon-i Mikel(*-i) harroa iruditzen zaio
 Jon-D Mikel.A/-D arrogant seem AAUX[3sgA-3sgD]
'Mikel seems arrogant to Jon.'
- c. Ama-ri umea(*-ri) esku-etatik kendu diote
 mother-D child.A/-D arms-ABL take away AUX[3sgA-3sgD-3plE]
'They have taken away the child from his&her mother's arms.'

Therefore, the examples in (56), (57), (58) and (59) demonstrate that the differential marking is ruled out when the third person object combines with a dative that occurs in [Spec, ApplP] rather than within a PP in the complement position of V.¹³⁹

¹³⁸ Some consultants admit that causative constructions are not very common in informal speech and add that instead of (59a), a sentence like (i) would be more natural for them.

- (i) Jon-i esan diot Miren-i esnatzeko
 Jon-D tell AUX[3sgA-3sgD-1sgE] Miren-D wake up.NOM
'I have told Jon to wake up Miren.'

¹³⁹ The only exception in this regard is that one of the consulted speakers prefers the object to be absolutive marked in causative constructions like (59a), but admits that marking the object dative would

When the object is third person and the combination with an inherent dative does not lead to PCC effects, the latter is always placed in [Spec, ApplP]. This is the case both with goals that enter the derivation as complements of V, and with causee, experiencer and possessors that originate in that position –as argued in chapters 3 and 4, the former reach the position in [Spec, ApplP] by internal Merge and the latter by external Merge. Therefore, if ApplP is a phase, and if the Spell-Out domain of each phase is sent to PF as soon as the phase is completed (Chomsky 2000 2001), by the time the subject enters the derivation in [Spec, ν P] the object will already be transferred to PF. As a consequence, contrary to ditransitives involving a non-agreeing PP goal, in ditransitives bearing an ApplP the Distinctness Condition will first be evaluated at the ApplP phase domain. ApplP includes the inherent KP dative in its specifier and the ϕ P direct object in its VP complement domain. Hence, no Distinctness effect will be caused by the dative and the ϕ P object, because, being phasal, the KP of the inherent dative involves a separate Spell-Out domain. On this assumption, there will be no need for the object to

not be completely ungrammatical for her. In this regard, it is important to notice that *esnatu* ‘wake up’ is a predicate that requires an animate object, which could favor the dative marking of the object in (59a) –as happens in (34) with *engainatu* ‘decive’ comparing to *bota* ‘throw’ and *utzi* ‘leave’. In spite of that, it is important to note that none of the consulted speakers accepts DOM when the object appears along with an agreeing inherent dative in [Spec, ApplP].

Fernández & Rezac (2016: 122) provide an exception to this generalization. These authors point out that one of the consultants from Araitz-Betelu (Arraztio 2010) provides the example in (i), where the object combines with an agreeing possessor or interest dative that instead of bearing dative marking bears the allative postposition –*gana*.

- (ii) Marta-k Ane-i ekarri dizu zu-gana
 Marta-E Ane-D bring AUX[2sgD-3sgE] you-ALL
 ‘Marta has brought Ane to you.’

Double dative constructions with third person objects are unacceptable by the consulted speakers in this dissertation. Likewise, I have found no example of this sort in the spontaneous speech corpora. Therefore, despite the counter-example in (i), I maintain the claim that third person human and definite objects combined with inherent datives receive no dative marking in Basque.

receive the K head, and third person human and definite objects will display absolutive marking, as in (56), (57), (58) and (59). Consider the syntactic tree in (60).¹⁴⁰

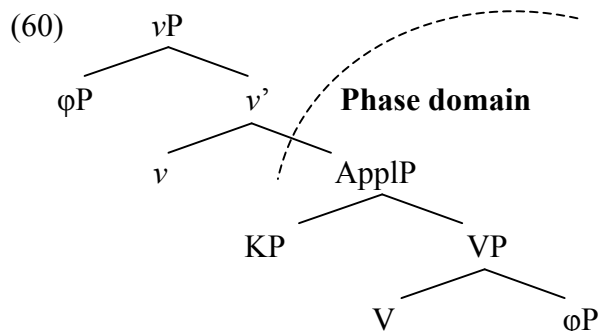

Conversely, when the object is first or second person, combining it with an inherent dative leads to PCC effects, which are repairable if the inherent dative is a goal generated as a PP –recall that causee, experiencer and possessor datives enter the syntax as DPs and are thus unable to resort to the PP repair strategy.¹⁴¹ As we have already pointed out, PCC effects triggered by a goal dative can be repaired by fortifying the Agree/Case locus of the originally PP dative, making it a full and phasal PP. In these constructions, the first phase domain dominating the object will be the *v*P, as the goal does not project an ApplP. Hence, as illustrated by the tree in (61), the object will coincide with the subject in the same phase domain and the Distinctness effect triggered by the two of them will be repaired by adding a K head to the object, as in (62).

¹⁴⁰ As depicted by the tree in (60), in these cases the object does neither cause a Distinctness effect with the agreeing inherent dative in [spec, ApplP], because as we have stated in chapter 4 (section 4.4), this is covered by a KP shell, which involves a phase domain as well.

¹⁴¹ As explained in chapter 4 (section 4.5), when the inherent dative is a causee, experiencer or a possessor that is generated in [Spec, ApplP], the first or second person object cannot co-occur with it: either with absolutive or with dative Case. In this case, the PCC effects remain irreparable, because the first or second person object needs to Agree with *v* both in [person] and [number], and the inherent dative prevents it from Agreeing in [person]. Thus, the derivation crashes due to the Case failure in the object.

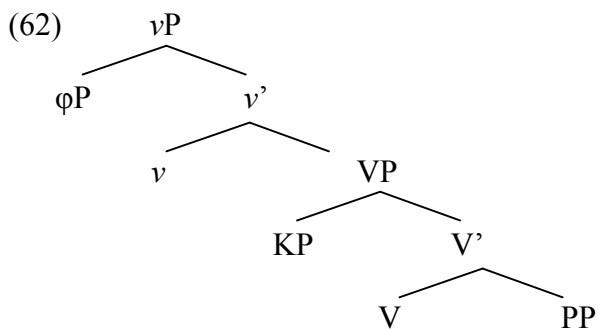
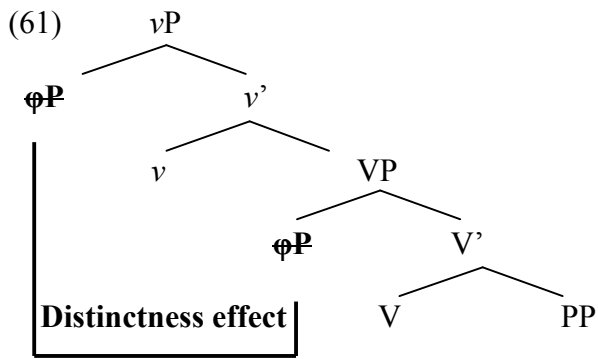

This would be the case in examples like (55), repeated here in (63). In these examples, both the goal and the object bear the *-ri* dative marking. However, the finite verbal form agrees only with the first (63a) or second (63b) person DOM object. The goal is left as a PP, without being cross-referenced by the finite verb.¹⁴²

¹⁴² Similar to (63), in ditransitive contexts, third person objects can only bear the differential marking if the goal indirect object is realized as a full locative dative –recall from chapter 4 (section 4.6.2.2) that this was also the case of first and second person objects. Although preferably with absolutive marking, some of the consulted speakers allow examples like (i), where dative marking is assigned to the object in clauses involving an allative PP.

- (i) Miren-i amona-rengana eraman-go diot
 Miren-D grandmother-ALL bring-FUT AUX[3sgD-1sgE]
 'I will carry Miren to her grandmother.'

Examples like (i) are also gathered by Arraztio (2010) in Araitz-Betelu Basque. As expected, in absence of an ApplP, the object in (i) coincides with the transitive subject in the same vP phase domain, and thus, the differential marking is assigned to it.

- (63) a. Traidore-ek ni-ri etsaia-ri saldu didate
 traitors-E I-D enemy-D sell AUX[1sgD-3plE]
'The traitors have sold me to the enemy.'
- b. Traidore-ek zu-ri etsaia-ri saldu dizute
 traitors-E you-D enemy-D sell AUX[2sgD-3plE]
'The traitors have sold you to the enemy.'

Therefore, the contrast between the derivations in (60) and (61) demonstrates that, in ditransitive contexts, the distinction when triggering a Distinctness effect does not depend on the original DP vs. PP nature of the inherent dative, but on the actual position of this inherent dative. In (60), the inherent dative is placed in [Spec, ApplP]. On the contrary, in (61) the originally PP goal remains in its original position, because the object is first or second person and PCC effects would arise if it moved to [Spec, ApplP].

Overall, the Derivational Distinctness Condition does not only explain the presence of DOM when combining a first or second person object with a PP goal, but also the absence of DOM when combining a third person human and definite object with an inherent dative in [Spec, ApplP]. This reinforces the claim that, in ditransitives, the impossibility to have the differential marking with third person objects is not due to an Agree/Case competition between the object and the inherent dative, but to the lack of a Distinctness effect triggered by the object and the subject. Thus, the absolutive marking of third person human and definite objects cannot be taken to be a repair strategy to an Agree/Case licensing failure. The absolutive is just the underlying marking of both DOM and non-DOM objects, and ditransitive contexts with ApplP simply show the underlying Case assignment of those objects.

The claim that DOM objects but not the rest of inherent datives receive absolutive by Agreeing with ν is additionally strengthened by the fact that, in ditransitives, only DOM objects are allowed to occur with absolutive Case. Goal (64), causee (65a), experiencer (65b) and possessor (65c) datives are always marked dative. This reinforces the claim that dative Case is inherently assigned in these arguments and that the Agree relation they hold with ν is defective in nature. Otherwise, if these datives received Case

structurally from *v*, absolutive Case should also be available for them, contrary to facts.¹⁴³

- (64) a. *Traidore-ek Miren-i[DO] etsaia[IO] saldu diote
 traitors-E Miren-D enemy.A sell AUX[3sgA-3sgD-3plE]
'The traitors have sold Miren to the enemy.'
- b. *Lagun-ek Mireni[DO] polizia[IO] deskribatu diote
 friends-E Miren-D pólice.A describe AUX[3sgA-3sgD-3plE]
'Her friends have described Miren to the police.'
- c. *Lankide-ek Miren-i[DO] zuzendaria[IO] gomendatu
 workmate-E Miren-D boss.A recommend
 diote
 AUX[3sgA-3sgD-3plE]
'Her workmates have recommended Miren to the boss.'
- d. *Lankide-ek Miren-i[DO] zuzendaria[IO] aurkeztu
 workmate-E Miren-D boss.A introduce
 diote
 AUX[3sgA-3sgD-3plE]
'Her workmates have introduced Miren to the boss.'
- (65) a. *Ni-k Jon[CAUSEE] Miren*-i[DO] esnatu -arazi diot
 I-E Jon.A Miren-D wake up-CAUS AUX[3sgA-3sgD-3sgE]
'I have made Jon wake up Miren.'
- b. *Jon[EXPERIENCER] Mikel-i[DO] harroa iruditzen zaio
 Jon.A Mikel-D arrogant seem AUX[3sgA-3sgD]
'Mikel seems arrogant to Jon.'
- c. *Ama[POSSESSOR] umea-ri[DO] esku-etatik kendu
 mother.A child-D arms-ABL take away
 diote
 AUX[3sgA-3sgD-3plE]
'They have taken away the child from his&her mother's arms.'

¹⁴³ The word order in (64) is identical to that in (56), (57) and (58), that is, the object occurs preceding the goal in order to maintain the linear ordering of double dative constructions involving a non-agreeing goal. Likewise, (65) maintains the same ordering as (59) and the object is placed after the causee, experiencer and possessor dative. Again, the impossibility to mark goals, causees, experiencers and possessors absolutive would remain if the ordering of the internal arguments was reversed to 'goal > object' in the case of (64) and 'object > causee/experiencer/possessor' in (65).

All in all, the data in this section have corroborated the claim that Basque DOM is the consequence of a Derivational Distinctness Condition. Even being a ϕ P, the object appears with absolutive Case when an ApplP is present in the clause, evidencing the previous Agree relation with the ν head. Given that ApplP is the first phase dominating the object, this is sent to Spell-Out by the time the subject enters the derivation in the next ν P phase domain. As a result, even being human and definite, the object in ditransitives involving an ApplP happens to be realized as canonical absolutes.

The lack of DOM in ditransitive contexts is also attested in other languages where DOM objects display the same marking as indirect objects. This is the case in Chaha (Richards 2010: 29) and Hindi (Bhatt & Anagnostopoulou 1996: 15, 21, Linares 2012: 36) –the same happens in Spanish too, as we will see in section 5.4.2. In Chaha, animate and specific objects bear the prefix $y\text{-}$, (66), but such a marker is impossible in ditransitive contexts (67). In ditransitives, only the indirect object can bear the prefix $y\text{-}$. Observe the contrast between the transitive sentence in (66) (Richards 2010: 26) and the ditransitive in (67) (Richards 2010: 29).

- (66) a. $G\text{iy}\text{ə}$ $y\text{-f}\text{ə}\text{r}\text{ə}\text{z}$ $n\text{ək}^w\text{əs}\text{ə}\text{n}\text{im}$
 dog DOM-horse bit
'A dog bit a (specific) horse.'
- b. $G\text{iy}\text{ə}$ $f\text{ə}\text{r}\text{ə}\text{z}$ $n\text{ək}\text{əs}\text{əm}$
 dog horse bit
'A dog bit a (non-specific) horse.'
- (67) a. $\check{C}'\text{am}^w\text{it}$ $y\text{-tk}\text{ə}$ $x^w\text{it}\text{a}$ $g\text{iy}\text{ə}$ $aw\text{ə}\check{c}\text{n}\text{im}$
 $\check{C}'\text{am}^w\text{it}$ $y\text{-}$ child the dog gave
' $\check{C}'\text{am}^w\text{it}$ gave the child a/the dog.'
- b. $*\check{C}'\text{am}^w\text{it}$ $y\text{-tk}\text{ə}$ $x^w\text{it}\text{a}$ $y\text{-g}\text{iy}\text{ə}$ $aw\text{ə}\check{c}\text{n}\text{im}$
 $\check{C}'\text{am}^w\text{it}$ $y\text{-}$ child the DOM-dog gave
' $\check{C}'\text{am}^w\text{it}$ gave the child a/the dog.'

Similarly, Bhatt & Anagnostopoulou (1996: 15, 21) and Linares (2012: 36) note that, in Hindi, proper nouns that are obligatorily differentially marked in transitive constructions take the $-ko$ preposition optionally in ditransitive constructions. Such marking correlates with the position of the direct object to the left or right of the indirect object –see section 5.3.1.2. Consider the examples in (68) given by Linares (2012: 36).

In (68a), the indirect object precedes the direct object and the latter is not able to bear the differential marking. Contrarily, in (68b), the indirect object follows the direct object and the latter is marked differentially.¹⁴⁴

- (68) a. John-ne Mary-ko Bill(*-ko) diyaa
 John-E Mary-DOM Bill give.PERF
 ‘John gave Bill to Mary.’
- b. John-ne Bill-ko Mary-ko diyaa
 John-E Bill-DOM Mary-D give.PERF
 ‘John gave Bill to Mary.’

As in Basque, in Hindi, the internal argument that appears without the differential marking in ditransitive contexts is always the direct object. As pointed out to me by Rajesh Bhatt (p.c.), it is impossible for the goal to occur without the *-ko* marking. This is illustrated in (69).¹⁴⁵

- (69) *John-ne Mary Bill-ko dii
 John-E Mary Bill-DOM give.PERF.F
 ‘John gave Bill to Mary.’

All in all, the examples in Chaha and Hindi could also be accounted for by the Derivational Distinctness Condition. As in Basque, indirect objects in ditransitives could also project an ApplP in these languages, which would account for the lack of DOM in those contexts. The ‘indirect object > direct object’ ordering points into that

¹⁴⁴ This is not the case with personal pronouns. In Hindi, first, second and third person pronouns are obligatorily differentially marked in ditransitive contexts. Consider, for instance, the examples in (i) and (ii) provided by Linares (2012: 42) –see also Bhatt (2006: 18).

- (i) John-ne mujh-ko Mary-ko diyaa
 John-E me-DOM Mary-D give.PERF
 ‘John gave me to Mary.’
- (ii) *John-ne Mary-ko maĩ / mujh-ko diyaa
 John-E Mary-D me-NOM me-DOM give.PERF
 ‘John gave me to Mary.’

¹⁴⁵ I have not found negative data for Chaha. Nevertheless, Richards (2010: 30) explicitly says that in ditransitive sentences, the marker must appear on the indirect object and typically does not appear on the direct object.

direction. Obviously, this is a preliminary hypothesis, as more details should be taken into account to state that indirect objects of these languages involve an ApplP.

Considering the parallelism to Basque clitic doubling in ApplPs, in the following section I turn to examine the distribution of DOM in Spanish ditransitive constructions. As in Basque, Spanish is known to allow DOM as long as the indirect object is realized as a non-agreeing PP, that is, without being doubled by the dative clitic *le(s)*. When the indirect object is doubled by the dative clitic, DOM turns out to be ruled out.

5.4.2. DOM depends on the lack of ApplP: the case of Spanish

In Spanish, when the indirect object is a full DP with a doubled clitic, the presence of the differential marking in the direct object decreases the grammaticality of the sentence. This fact has been reported, among others, by Brugé & Brugger (1994: 26), Demonte (1994: 460-461), Romero (1997: 205-210), Rodríguez-Mondoñedo (2007: 213, 216), Zdrojewski (2008: 40-41), Saab & Zdrojewski (2012: 181), Ormazabal & Romero (2013a: 224 2013b: 157 2013c: 321, 331) and Fábregas (2013: 32).

Parallelizing Spanish ditransitives with the analysis I propose for Basque, I suggest that in Spanish the indirect object occurs as an ApplP when it is doubled by a clitic and as a PP when it is not –recall from chapter 3 (section 3.4.3) that, as in Basque, only goals can occur as non-agreeing datives in Spanish too. In line with Demonte (1995), Romero (1997) and Cuervo (2003), among others, I thus assume that clitic doubled datives in ApplP form a Double Object Construction (70a), while non-clitic doubled PP datives a P-construction (70b).

- (70) a. Le enviaron el paquete a María
 3sgD sent.3pl the package to María
 'They sent the package to María.'
- b. Enviaron el paquete a María
 sent.3pl the package to María
 'They sent the package to María.'

Spanish could also be akin to Basque in distinguishing the nature of the *a*-marker in the two ApplP vs. PP constructions. Following Cuervo (2003), I thus assume that the *a*-marker in clitic doubled indirect objects like (70a) is a K –i.e., Case marker, and that the

same marker corresponds to a P –i.e., preposition– when the indirect object is not clitic doubled, as in (70b).¹⁴⁶ Note that in this sense DOM objects group with the datives in ApplP, as their *a*-marker also corresponds to K (Richards 2010: 25-32).

On this assumption, if Spanish DOM is caused by the Derivational Distinctness Condition, DOM should only be expected when the indirect object is a goal and can thus be realized as a non-agreeing PP –i.e., without being doubled by the dative clitic *le(s)*. By the same token, the differential marking should be impeded with indirect objects projecting an ApplP. As pointed out in the literature on the topic, this is in fact what happens in Spanish. Let us start *a*-marking ditransitives with possessor datives.

As in Basque, possessor datives seem to project an ApplP in Spanish too, as they are always clitic doubled. Therefore, as expected by the presence of ApplP, DOM is not allowed when combining an animate and specific object with a possessor dative. Consider the examples in (71) provided by Brugé & Brugger (1994: 26).¹⁴⁷

- (71) a. El portero le violó (*a) la hija / la hermana a María
 the doorman 3sgD raped.3sg DOM the daughter / the sister to María
 ‘The doorman raped the daughter/sister to María.’
- b. Juan le robó (*a) la novia / el hijo a Paco
 Juan 3sgD stole.3sg DOM the girlfriend / son to Paco
 ‘Juan stole the girlfriend/son to Paco.’

According to Brugé & Brugger (1994), In (71a), the possessor dative *a María* is doubled by the dative clitic *le* and the object *la hija* ‘the daughter’ / *la hermana* ‘the sister’ is unable to bear the *a*-marker. The same occurs in (71b). The possessor dative *a Paco* is doubled by the dative clitic *le* and the object *la novia* ‘the girlfriend’ / *el hijo* ‘the son’ cannot display the differential marking. Interestingly, as shown by Bruggç & Brugger (1994: 27), the examples in (71) contrast with those in (72) below.

¹⁴⁶ The different syntactic nature of the same *a*-marker in agreeing and non-agreeing datives is also pointed out by Ormazabal & Romero (2013ab).

¹⁴⁷ A consulted speaker considers the example in (71a) ungrammatical. For this speaker, the animate object of *violar* ‘rape’ requires always *a*-marking.

- (72) a. El portero violó *(a) la hija de María
 the doorman raped.3sg DOM the daughter of María
 ‘The doorman raped María’s daughter.’
- b. Juan robó *(a) el hijo de Paco
 Juan stole.3sg DOM the son of Paco
 ‘Juan stole Paco’s son.’

In (72), the possessor is realized as a genitive and the animate and specific objects *la hija* ‘the daughter’ and *el hijo* ‘the son’ need to bear the differential marking. In these examples, the possessor does not project an ApplP and DOM arises due to a Distinctness effect triggered by the object and the subject, as both bear the ϕ P label. The contrast between (71) and (72) is thus clear evidence showing that the impossibility to combine a DOM object with a possessor dative has a syntactic motivation. It is the presence of ApplP what prevents the object from receiving the differential marking.

Along with possessor datives, the same pattern is attested with goal datives that are doubled by a clitic. Consider the examples in (73) provided by Romero (1997: 209).¹⁴⁸

¹⁴⁸ It has been reported by some authors that proper nouns should always bear DOM in ditransitive constructions with clitic doubled indirect objects (Demonte 1994: 460-461, Romero 1997: 210, Fábregas 2013: 32, Ormazabal & Romero 2013a: 224-225 2013b: 157). Demonte’s (1994: 461) example in (i) shows that the proper name *Juana* cannot appear without the differential marking.

- (i) *Le presenté Juana a Pedro
 3sgD introduced.3sg Juana to Pedro
 ‘I introduced Juana to Pedro.’

Notwithstanding, the grammaticality of sentences like (i) does not improve when adding the differential marking to the object, because the indirect object is clitic doubled. As illustrated by (ii) (Ormazabal & Romero 2013a: 224) and (iii) (Ormazabal & Romero 2013b: 157), the combination of a proper name with a clitic doubled indirect object yields an ungrammatical result.

- (ii) *Les enviaron Mateo a los doctores
 3plD sent.3pl DOM Mateo to the doctors
 ‘They sent Mateo to the doctors.’
- (iii) *Les mandaron (a)l Sr. Lobo a los mafiosos
 3plD sent.3pl DOM Sr. Lobo to the gangsters
 ‘They sent Sr. Lobo to the gangsters.’

Ormazabal & Romero (2013a: 224-225 2013b: 157) add that along with proper nouns, regular animate definite objects must always show up with the differential marking and that the combination of such

- (73) a. Les entregó toda su familia a los fascistas
 3plD entrusted.3sg all his/her family to the fascists
'He/she entrusted all his/her family to the fascist.'
- b. Le presenté la mayoría de los periodistas al nuevo director
 3sgD introduced.1sg the majority of the journalists to the new boss
'I introduced most of the journalists to the new boss.'
- c. Le prometí tu hija a la bruja Piruja
 3sgD promised.1sg your daughter to the witch Piruja
'I promised your daughter to the witch Piruja.'

In (73) the goals *a los fascistas* 'to the fascists' (73a), *al nuevo director* 'the new director' (73b) and *a la bruja Piruja* 'witch Piruja' (73c) are all clitic doubled, and even being animate and specific, the objects *toda su familia* 'his/her whole family' (73a), *la mayoría de los periodistas* 'the majority of the journalists' (73b) and *tu hija* 'your daughter' (73c) do not bear *a*-marking. Crucially, when the same goals are not clitic doubled, the same animate and specific objects in (73) receive the differential marking. Take now the examples in (74).

objects with a clitic doubled indirect object happens to be ungrammatical, as in (iv) (Ormazabal & Romero 2013a: 224) and (v) (Ormazabal & Romero 2013b: 157).

- (iv) *Les enviaron(a) tu hijo a los doctores
 3plD sent.3pl DOM your son to the doctors
'They sent your son to the doctors.'
- (v) *Le propusieron (a) las candidatas al presidente
 3sgD proposed.3pl DOM the candidates to the president
'They proposed the candidates to the president.'

Ormazabal & Romero (2013a: 224 2013c: 321, 331) explain that the lack of DOM involves some de-animation of the NP, and that it is only allowed with nouns such as sick people, soldiers, slaves, kids, etc; nouns whose referents are regularly treated as entities lacking free will and that can be contextually subject to such de-animation process, as in (vi) and (vii).

- (vi) Enviaron *(a) todos los enfermos a la doctora Aranzabal
 sent.3pl DOM all the sick people to the doctor Aranzabal
'They sent all the sick people to the doctor Aranzabal.'
- (vii) *Le enviaron (*a) todos los enfermos a la doctora Aranzabal
 3sgD sent.3pl DOM all the sick people to the doctor Aranzabal
'They sent all the sick people to the doctor Aranzabal.'

- (74) a. Entregó a toda su familia a los fascistas
 entrusted.3sg DOM all his/her family to the fascists
'He/she entrusted all his/her family to the fascist.'
- b. Presenté a la mayoría de los periodistas al nuevo director
 introduced.1sg DOM the majority of the journalists to the new boss
'I introduced most of the journalists to the new boss.'
- c. Prometí a tu hija a la bruja Piruja
 promised.1sg DOM your daughter to the witch Piruja
'I promised your daughter to the witch Piruja.'

Besides, as it is the case in Basque and Hindi (section 5.4.1), in Spanish only the direct object can occur without the *a*-marker. The same marker is obligatory in the indirect object, evidencing its inherent nature. This is illustrated in the examples in (75), provided by Rodriguez-Mondoñedo (2007: 215). In (75a) we see that the object can appear without *a*-marking and (75b) shows that the same marker can never be absent in the indirect object.

- (75) a. El jefe le presentó el empleado[DO] a Pedro[IO]
 the boss 3sgD introduced.3sg the employee to Pedro
'The boss introduced the employee to Pedro.'
- b. *El jefe le presentó al empleado[DO] Pedro[IO]
 the boss 3sgD introduced.3sg DOM the employee Pedro
'The boss introduced the employee to Pedro.'

Therefore, the contrast between (73) and (74) clearly shows that in ditransitive constructions, DOM depends on the presence of an inherent dative in [Spec, ApplP]. When –in spite of its PP source– the goal is a clitic doubled DP in [Spec, ApplP], the object cannot bear the differential marking.¹⁴⁹

¹⁴⁹ As noted by Rodriguez-Mondoñedo (2007: 245) and Fábregas (2013: 32), the combination of a DOM object with a PP-like goal is thus the same as when combining a DOM object with a full PP, as in (i) (Rodriguez-Mondoñedo 2007: 245) and (ii) (Fábregas 2013: 32)

- (i) Juan le presentó a María a las tres
 Juan 3sgD introduced.3sg DOM María at three o'clock
'Juan introduced María at three o'clock.'
- (ii) Enviaron a la cautiva Zenobia al castillo
 sent.3pl DOM the captive Zenobia to the castle
'they sent the captive Zenobia to the castle.'

As happens in Basque, it thus seems that in Spanish the availability to have DOM in ditransitive contexts is not contingent on the original DP vs. PP category of the dative argument. If this was so, goals and possessors should behave differently, as the former generate as PPs and the latter as DPs. Instead, the availability to have DOM in ditransitives depends exclusively on whether the dative projects an ApplP or not. Regardless of their original syntactic category, only those datives in [Spec, ApplP] ban the differential marking in the object, and this is directly explained by the Derivational Distinctness Condition. If an ApplP is present in between the object and the subject, by the time the subject enters the derivation in [Spec, *v*P] the object will already be sent to Spell-Out, because ApplP is phasal in nature (McGinnis 2001ab 2004) and the object generates in its complement domain, within VP. This follows from the fact that the Spell-Out domain of a given phase is transferred to PF as soon as the phase is completed (Chomsky 2000 2001). As a consequence, in ditransitives with an ApplP no Distinctness effect arises, and there is no need for the K head to be added to the object. This is illustrated in the syntactic tree in (76).

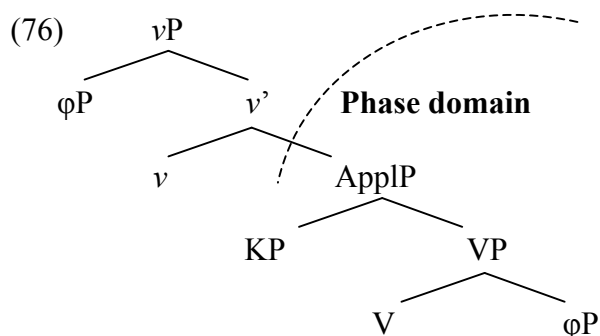

On the contrary, if no ApplP is present in the construction and the inherent dative is a PP complement of V, the subject and the object will coincide in the same *v*P phase domain, and a Distinctness effect will arise if both bear the label ϕ P. This is depicted in (77). When this is so, the object receives the K phasal head and happens to be linearized separately from the subject, as in (78). This is the case of the ditransitives with non-clitic doubled goals like (74).¹⁵⁰

¹⁵⁰ Apart from clitic doubled or non-clitic doubled full indirect objects, Spanish ditransitives can also display a dative clitic without doubling a full DP. When this is so, animate and specific objects are

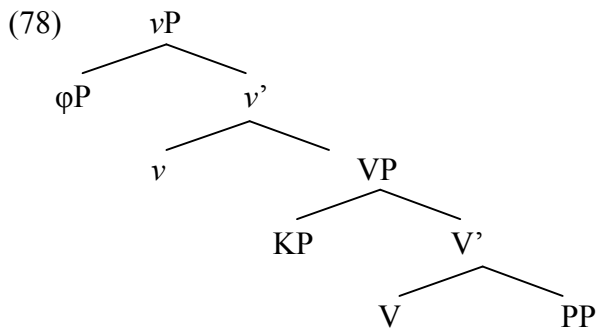
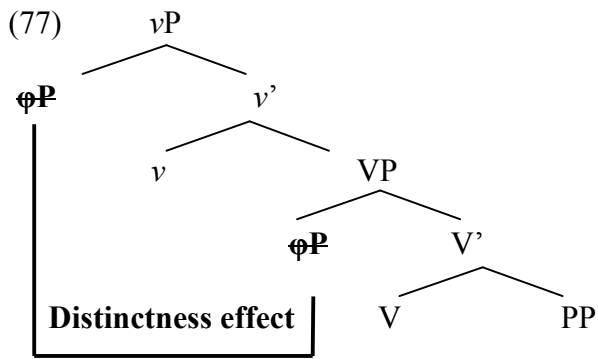

The distribution of Spanish DOM in ditransitive contexts has also been analyzed from a Distinctness-based approach by other authors like Rodríguez-Mondoñedo (2007: 224-228). Rodríguez-Mondoñedo claims that Spanish DOM objects receive *a*-marking structurally, by Agreeing with a functional head that enters the derivation after *v*. This author argues that animate objects are phi-complete and that, as a result, they can only Agree with a functional head that is phi-complete too. Stipulating that *v* is defective in

required to bear the differential marking (Romero 1997: 209, Rodríguez-Mondoñedo 2007: 212, Ormazabal & Romero 2013a: 237). Consider the examples in (i) and (ii) provided by Ormazabal & Romero (2013a: 237).

- (i) Les enviaron*(a) Mateo/tu hijo
 3plD sent.3pl DOM Mateo/your son
 'They sent Mateo/your son to them.'
- (ii) Nos enviaron *(a) Mateo/tu hijo
 1plD sent.3pl DOM Mateo/your son
 'They sent Mateo/your son to us.'

The analysis of examples like (i) and (ii) is outside the scope of this dissertation, and is thus left for future research.

the sense that it lacks uninterpretable phi-features, Rodríguez-Mondoñedo claims that the matching and subsequent Agree relation between phi-complete objects and the phi-incomplete v head is not feasible. For this reason, he argues that whenever an animate object is present in the derivation, an additional dative Case licenser is added in order to Agree with such object. This makes the object move to the edge of its original vP phase domain so as to check its [u Case] feature with the structurally higher dative Case licenser.¹⁵¹

Rodríguez-Mondoñedo (2007: 224-228) contends that the role played by the Distinctness Condition in Spanish DOM is exclusive to ditransitive contexts. That is to say, instead of avoiding the potential $\langle \varphi P, \varphi P \rangle$ linearization statement created by the subject and the object, the Distinctness Condition bans the $\langle KP, KP \rangle$ final linearization involving the DOM and the indirect object. Assuming that the condition applies just at the PF branch of the derivation, Rodríguez-Mondoñedo claims that the differential marking is assigned in syntax both in transitive and ditransitive construction, and deleted post-syntactically in ditransitives, when the object occurs along with an indirect object bearing inherent dative Case. Hence, contrary to the view taken in this dissertation, this author claims that Distinctness is a filter responsible for repairing at the syntax-phonology interface the Distinctness effects created by syntax –see also Saab & Zdrojewski (2012: 181) for a similar view.

Three main pieces of evidence are given by Rodríguez-Mondoñedo (2007) to justify the fact that the lack of DOM in ditransitive contexts is due to the Distinctness Condition. In order to understand each of them, it is important to recall that Richards (2010) argues that a Distinctness violation can be saved either by making one of the nominals in a given linearization domain different to the other, or by putting it in a different linearization domain. Concerning Rodríguez-Mondoñedo, the first option would involve the drop of the a -marker. The second one would include heavy NP shift, dislocation of

¹⁵¹ Other authors assuming that in Spanish DOM objects check Case in a structurally higher position are Torrego (1998), López (2012) and Ormazabal & Romero (2013ab). Besides, similar to Rodríguez-Mondoñedo (2007), both Torrego (1998) and Ormazabal & Romero (2013ab) assume that in ditransitive contexts double dative constructions are banned under certain conditions because the two internal arguments compete for the same Case checking position.

one of the nominals or the use of pauses between the two nominals; all of them making the direct and indirect object linearize in different domains. In fact, Rodríguez-Mondoñedo (2007: 224) notes that in ditransitives including heavy objects (79), a dislocated object (80) or a pause between the two objects (81), animate and specific objects are indeed able to bear the differential marking –this is also noted by Fábregas (2013: 31-32).

- (79) a. Juan le presentó a María de las Nieves
 Juan 3sgD introduced.3sg DOM María de las Nieves
 a Pedro Vargas Prada
 to Pedro Vargas Prada
 ‘Juan introduced María to Pedro Vargas Prada.’
- b. *Juan le presentó María de las Nieves
 Juan 3sgD introduced.3sg María de las Nieves
 a Pedro Vargas Prada
 to Pedro Vargas Prada
 ‘Juan introduced María to Pedro Vargas Prada.’
- (80) a. Juan le presentó a María, a Pedro
 Juan 3sgD introduced.3sg DOM María to Pedro
 ‘Juan introduced María, to Pedro.’
- b. *Juan le presentó María, a Pedro
 Juan 3sgD introduced.3sg María to Pedro
 ‘Juan introduced María, to Pedro.’
- (81) a. A Pedro, Juan le presentó a María
 to Pedro Juan 3sgD introduced DOM María
 ‘To Pedro, Juan introduced María.’
- b. *A Pedro, Juan le presentó María
 to Pedro Juan 3sgD introduced María
 ‘To Pedro, Juan introduced María.’

Rodríguez-Mondoñedo explains that, as the direct object *María* in (79)-(81) is linearized in an independent Spell-Out domain to the indirect object, it is not necessary for the direct object to remove its *a*-marker.

In contrast to Rodríguez-Mondoñedo (2007), I assume that the Distinctness Condition does not only account for the absence but also for the presence of DOM. I argue that the differential marking arises because the object coincides with the subject in the same ν P

phase domain. Likewise, I state that the lack of differential marking in objects of ditransitive constructions with clitic doubled datives arises because the object does not coincide with the transitive subject in the same phase domain. Contrary to transitive constructions, ditransitives involving a clitic doubled inherent dative involve an ApplP, a phase domain for the purposes of linearization. This impedes the co-occurrence of the object and the subject in the v P phase domain. Besides, as the inherent KP dative in [Spec, ApplP] is itself a phase, it will also be linearized independently from the direct object and no Distinctness effect will arise between the two of them. Adopting a Derivational approach for the Distinctness Condition allows us to explain both the presence and absence of DOM with a single mechanism: without resorting to the defectiveness of the v head to explain its presence or to the morphological drop of the a -marker to explain its absence. This makes the proposal in this dissertation simpler than that in Rodríguez-Mondoñedo (2007), which accounts for the presence and absence of DOM by means of different mechanisms.¹⁵² In my view, the absence of differential marking in ditransitive constructions does not entail that the differential marker is morphologically deleted, but rather that it is simply not assigned throughout the syntactic derivation.

This is also the view adopted by Ormazabal & Romero (2013abc 2014) for the lack of a -marker in Spanish ditransitives. These authors argue that, instead of being removed, the a -marker is just not assigned to animate and specific objects in certain ditransitive contexts. However, contrary to the present proposal, Ormazabal & Romero (2013abc 2014) claim that not all objects receive Case. Assuming a single formal relation for the licensing of all internal arguments, these authors claim that the objects that do not bear the a -marker in ditransitive contexts are neither Case licensed.

Given that third person animate and specific objects in ditransitive contexts bear unmarked Case, one could agree with Ormazabal & Romero (2013abc) and state that

¹⁵² Moreover, although admitting that the lack of a -marking is more common in clitic doubled rather than non-clitic doubled contexts, Rodríguez-Mondoñedo (2007: 216-217) does not account for such contrast. This author says that clitic doubling with indirect objects is more usual than non-doubling, and focuses exclusively on ditransitives involving clitic doubling, without explaining the role played by clitic doubling in not allowing the differential marking.

these objects are left unlicensed for Case. Notwithstanding, the next section will focus on derived transitive constructions formed with **edun* ‘have’, where human and definite objects bear absolutive rather than dative Case, triggering absolutive agreement markers in the finite verbal form. Note that this would be problematic if ϕ P objects without the differential marking are considered to be unlicensed for Case.

5.4.3. Interim summary

In this section I have proved that the Derivational Distinctness Condition accounts for the distribution of DOM in ditransitive configurations both in Basque and Spanish. I have shown that in ditransitive contexts only agreeing inherent datives that project an ApplP avoid the assignment of the differential marking. Due to its phasal nature (McGinnis 2001ab 2004), ApplP prevents the object in VP to co-occur along with the transitive subject in [Spec, ν P], because by the time the subject enters the derivation the object will already be transferred to the Spell-Out. As a result, in absence of a Distinctness effect, the object does not receive the differential marking. Contrary to agreeing inherent datives in [Spec, ApplP], I have also demonstrated that the Distinctness effect leading to DOM does actually occur when the dative is a goal realized as a non-agreeing PP. In (southwestern) Basque, this is only possible if the object is first or second person, as in this case the goal resorts to the PP repair strategy (Rezac 2011) by activating its Agree/Case locus in P. This leads the goal Agree with the phasal P head in its original position and lets the object coincide with the transitive subject in the ν P phase domain, which causes a Distinctness effect as this bears the ϕ P label too. In Spanish, non-agreeing PP goals are equally found outside PCC environments, and DOM is consequently attested whenever the goal is realized as a PP, regardless of the [person] specification of the object.

5.5. THE DERIVATIONAL DISTINCTNESS CONDITION IN DERIVED TRANSITIVE CONSTRUCTION

5.5.1. Introduction

So far, we have seen that, in Basque, DOM is possible with all kind of sentences involving a transitive configuration with an ergative subject. In this section, I specify such statement and argue that DOM is available in transitive contexts as long as the subject is first merged in [Spec, ν P], in the same ν P phase as the object. If the transitive configuration is instead derived from an intransitive one, and the argument bearing ergative marking enters the derivation in a different position, DOM is actually ruled out. This is what happens in the derived transitive predication constructed with the verb **edun* ‘have’, where the ergative subject in [Spec, TP] is generated within a silent Applicative head represented by Etxepare & Uribe-Etxebarria (2012: section 6) as P, which in turn holds the intransitive predicate. The lack of DOM in such construction follows straightforwardly from the Derivational Distinctness Condition, because the differential marking is only motivated when the ν P domain contains two arguments with the same ϕ P label.

5.5.2. Transitive predication with **edun* ‘have’

Basque has a construction known as transitive predication (Zabala 2003: 435-436, Etxepare 2003: 414, de Rijk 2008: 675-677, Etxepare & Uribe-Etxebarria 2012: section 6, Fernández & Rezac 2016). Such a construction displays a transitive configuration with ergative and absolutive arguments, and is special in allowing not only stage-level predicates, but also individual-level predicates that typically occur with copulative verbs like *izan* ‘be’. In (82) we see that the transitive predication can combine with stage-level predicates like *txarto* ‘badly’, *oihuka* ‘shouting’, *Mirenekin* ‘with Miren’, *langabezian* ‘in unemployment’ and *etxean* ‘at home’ (Zabala 2003: 436). Likewise, (83) illustrates that the same construction can also contain individual-level predicates like *mutil azkarra* ‘clever boy’ or *lagun handia* ‘great friend’.

- (82) a. Jon txarto duzu
 Jon.A badly AUX[3sgA-2sgE]
'Jon feels bad, which benefits/interests you.'
- b. Jon oihuka duzu
 Jon.A shouting AUX[3sgA-2sgE]
'Jon is shouting, which benefits/interests you.'
- c. Jon Miren-ekin duzu
 Jon.A Miren-SOC AUX[3sgA-2sgE]
'Jon is with Miren, which benefits/interests you.'
- d. Jon langabezian duzu
 Jon.A unemployment AUX[3sgA-2sgE]
'Jon is unemployed, which benefits/interests you.'
- e. Jon etxe-an duzu
 Jon.A house-INES AUX[3sgA-2sgE]
'Jon is at home, which benefits/interests you.'
- (83) a. Jon mutil azkarra dugu
 Jon.A boy clever AUX[3sgA-1plE]
'Jon is a clever boy, which benefits/interests us.'
- b. Jon lagun handia dut
 Jon.A friend great AUX[3sgA-1sgE]
'Jon is a great friend, which benefits/interests me.'

Although formed with the verb **edun* 'have', the transitive predication exemplified in (83) and (84) is also exceptional in not involving necessarily a possession relation between the ergative and absolutive argument, as happens with the same lexical verb **edun* 'have' in (84). Contrary to the examples in (83), those in (84) represent a possession relation between the ergative and absolutive argument.

- (84) a. Jon-ek bi alaba ditu
 Jon-E two daughter.A AUX[3plA-3sgE]
'Jon has two daughters.'
- b. Jon-ek ume bat du
 Jon-E child one.A AUX[3sgA-3sgE]
'Jon has a child.'

In fact, Etxepare & Uribe-Etxebarria (2012: section 6) report that, in sentences like (83) the transitive auxiliary **edun* 'have' cannot alternate with the lexical possessive verb

eduki, which also means ‘have’ (85), as would occur if in the transitive predication **edun* ‘have’ entailed an ordinary possession relation, as in (86). In (86) we see that the same possession relation can be entailed either with **edun* ‘have’ (86a) or with *eduki*.

- (85) a. *Jon mutil azkarra daukagu
 Jon.A boy clever AUX[3sgA-1plE]
 ‘Jon is a clever boy, which benefits/interests us.’
- b. *Jon lagun handia daukat
 Jon.A friend great AUX[3sgA-1sgE]
 ‘Jon is a great friend, which benefits/interests me.’
- (86) a. Jon.ek bi alaba ditu
 Jon-E two daughter.A AUX[3plA-3sgE]
 ‘Jon has two daughters.’
- b. Jon.ek bi alaba dauzka
 Jon-E two daughter.A AUX[3plA-3sgE]
 ‘Jon has two daughters.’

In this respect, De Rijk (2008: 675) notes that the ergative argument of the transitive predication is interpreted as an additional argument connected with the predication, a connection that is sometimes emotional. Similarly, Zabala (2003: 436) notes that in examples like (87), the ergative marker (-zu) of the finite verb is not an argument of the verb or the nominal predicate, but an allocutive morpheme corresponding to the listener (Zabala 2003: 436).

- (87) a. Hau Mikel duzu
 this Mikel.A AUX[3sgA-2sgE]
 ‘This is Mikel, which benefits/interests you.’
- b. Miren bilbotarra/gaztea duzu
 Miren.A Bilbaoan/young AUX[3sgA-2sgE]
 ‘Miren is from Bilbao/young.’

Overall, the transitive predication formed with **edun* ‘have’ is exceptional because, although apparently transitive, it is able to combine with individual-level predicates and does not necessarily entail a possession relation between the ergative and absolutive arguments.

5.5.3. The transitive predication with **edun* ‘have’ is derived from *izan* ‘be’

Taking this into account, Etxepare & Uribe-Etxebarria (2012: section 6) propose that the transitive predication in examples like (83) is derived from an intransitive predication like (88), which contains the copulative verb *izan* ‘be’ and takes a subject-predicate Small Clause as its complement.

- (88) a. Jon_i [t_i mutil azkarra] da
 Jon.A boy clever AUX[3sgA]
 ‘Jon is a clever boy.’
- b. Jon_i [t_i lagun handia] da
 Jon.A great friend AUX[3sgA]
 ‘Jon is a great friend.’

Even though they assume that the transitive predication in (83) is the counterpart of the intransitive predication in (88), Etxepare & Uribe-Etxebarria claim that the base structure of the transitive predication is slightly different to the one in (88). These authors propose that, instead of merging directly with the copulative verb *izan* ‘be’, the Small Clause *Jon mutil azkarra* ‘Jon a clever boy’ is merged with a silent Applicative head represented as P. Such a head introduces an experiencer oblique argument, which shows ergative marking in the final transitive configuration.¹⁵³ This is depicted in the syntactic tree in (89).

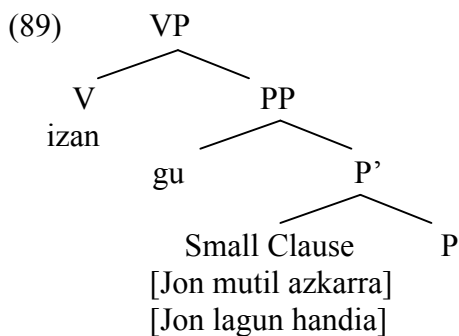

¹⁵³ Etxepare & Uribe-Etxebarria’s PP would do be equivalent to our ApplP that introduces experiencers to the derivation.

On the one hand, the structure in (89) correctly predicts that the ergative argument in the transitive predication is an argument that is external to the relation between the Small Clause subject –i.e., *Jon*– and the adjectival or nominal predicate –i.e., *mutil azkarra* ‘clever boy’ or *lagun handia* ‘great friend’. On the other hand, given that in the transitive predication **edun* ‘have’ is not a lexical verb, the final ergative argument is not originated in [Spec, *v*P]. This way, the structure also captures the lack of possession involved over the subject of the Small Clause. In this approach, the experiencer subject is an independent argument to the Small Clause that receives the oblique experiencer theta-role from a functional head –i.e., *P*– external to the Small Clause itself.

Departing from the base structure in (89), Etxepare & Uribe-Etxebarria propose that in the transitive predication the auxiliary **edun* ‘have’ is derived from the incorporation of the *P* head into the *V izan* ‘be’ (Kayne 1993), which extends the Agree/Case locus of the sentence. On the one hand, although originated as an oblique argument, the experiencer raises to the subject position of the main clause –i.e., to [Spec, TP]– and checks ergative Case, behaving this way as a transitive subject regarding case and agreement (Rezac et al. 2014). On the other hand, the subject of the Small Clause Agrees with *v*, and receives thereby absolutive Case. This leads to a transitive configuration, with ergative and absolutive arguments.

For the purposes of the discussion, it is important to highlight that the basic difference between the transitive predication built up with **edun* ‘have’ and the rest of predicates in transitive configurations is that in the former the subject does not generate together with the object in the *v*P phase. This is a relevant aspect when testing the availability of DOM in sentences involving transitive predication with **edun* ‘have’, because, if the differential marking is the result of a Distinctness effect triggered by the subject and the object in the *v*P domain, no DOM should be expected in those contexts.

5.5.4. DOM and the transitive predication with **edun* ‘have’

As predicted by the Derivational Distinctness Condition, the differential marking happens to be banned in the transitive predication formed with **edun* ‘have’ in Basque varieties displaying DOM –see also Fernández & Rezac (2016) in this regard. On the one hand, some of the consulted speakers find natural the sentences involving transitive

predication with **edun* ‘have’ and say that in this case the object can only be marked absolutive. Consider the following examples from Elgoibar (90) and Zumaia (91) Basque.

- (90) a. Ni-k hori lagun haundixa dot
 I-E that.A friend great AUX[3sgA-1sgE]
‘This is a great friend, which benefits/interests me.’
- b. *Ni-k horr-i lagun haundixa diot
 I-E that-D friend great AUX[3sgD-1sgE]
‘This is a great friend, which benefits/interests me.’
- (91) a. Beñat arraunlariya degu
 Beñat.A oarsman AUX[3sgA-1plE]
‘Beñat is a oarsman, which benefits/interests us.’
- b. *Beñat-i arraunlariya diyogu
 Beñat-D oarsman AUX[3sgD-1plE]
‘Beñat is a oarsman, which benefits/interests us.’

On the other hand, other speakers admit that the transitive predication formed with **edun* ‘have’ is not very common in their informal speech, and instead of the transitive predication (92a), these speakers employ sentences like (92b).¹⁵⁴ Be it as it may, it is important to note that all of them take examples like (92a) to be grammatical in Basque and consider that the dative marking of the object would make such construction completely ungrammatical, as illustrated in (92c).

- (92) a. Neska azkarra nauzue
 girl clever AUX[1sgA-2plE]
‘I am a clever girl, which benefits/interests you.’
- b. Neska azkarra naiz
 girl clever AUX[1sgA]
‘I am a clever girl.’
- c. *Neska azkarra didazue
 girl clever AUX[1sgD-2plE]
‘I am a clever girl, which benefits/interests ou.’

¹⁵⁴ This may be due to a generational split. As noted by a speaker from Larrabetzu, the transitive predication is common for elderly people but not for younger ones speaking the same variety.

All in all, DOM is never accepted in the transitive predication with **edun* ‘have’. Following the line of argumentation in this chapter, this is something expected taking into account that the argument Agreeing with *v* –*lagun hori* ‘that friend’ in (90), *Beñat* in (91) and *ni* ‘I’ in (92)– does not coincide with a ϕ P subject in its phase domain. If Etxepare & Uribe-Etxebarria’s (2012: section 6) claim is on the right track, by the time P incorporates into V and the experiencer moves to [Spec, TP], the subject of the Small Clause will already be sent to Spell-Out after entering into *v*-Agree. That is to say, as the experiencer within the PP rises directly to [Spec, TP], the absolutive argument will never coincide with it in the same *v*P phase domain and there will be no need for the K head to be assigned to it. It is thus the lack of Distinctness effect what accounts for the lack of DOM in these contexts.¹⁵⁵

¹⁵⁵ Fernández & Rezac (2016: 112-119) report that, in the variety of Dima, the verb *eduki* ‘have’ can appear in the same transitive predication structure showing the same properties as that exhibited by the transitive predication with **edun* ‘have’ in the rest of Basque varieties –i.e., possibility to combine with individual-level predicates and entailing no possession relation. Therefore, these authors extend Etxepare & Uribe-Etxebarria’s (2012: section 6) derivational analysis of the transitive predication formed with **edun* ‘have’ to that formed with *eduki* ‘have’ in Dima Basque and argue that, as the object of the final transitive configuration checks Case in an Exceptional Case Marking (ECM) context, the availability to have DOM in such construction implies that DOM is structurally assigned. Outside Dima, *eduki* ‘have’ appears in other kind of construction that could also show a similar derivation. This is illustrated in (i).

- (i) *Beti eduki-ko didazu alboan*
 always have-FUT AUX[1sgD-2sgE] beside
 ‘I will always be beside you, which benefits/interests you.’

Although Fernández & Rezac identify the differences attested between the transitive predication built up with **edun* ‘have’ and that formed with *eduki* ‘have’ in sentences like (i), the exact derivation of the latter is left open in their study –one of the options these authors entertain is that *eduki* ‘have’ may also involve a Small Clause complement similar (but not identical) to that involved in the transitive predication with **edun* ‘have’. Arguing for a structural Case assignment in DOM objects, Odria (2014: 309-310) does not distinguish the different analyses proposed by Fernández & Rezac (2016) for the transitive predication with *eduki* ‘have’ found in Dima Basque –which allows individual-level predicates– and in the rest of Basque varieties –which does not allow individual-level predicate, and assumes the same analysis put forth by Etxepare & Uribe-Etxebarria (2012) for the transitive predication with **edun* ‘have’ for constructions like (i) too. Notwithstanding, considering that in examples like (i) *eduki* ‘have’ can only appear with stage-level predicates, I believe that constructions like (i) cannot be analyzed as being

Note that the present analysis could equally account for the lack of DOM if an Object Shift movement of the argument Agreeing with v was proved to be justified. In that case, the object would first find itself alone in the vP phase and no DOM would be expected in that domain. Besides, the differential marking would neither be motivated in the next CP phase domain. If the object shifted to the edge of the vP phase, the differential marking would neither appear in that domain, because the ergative experiencer would already be involved within a KP in [Spec, TP]. This makes the analysis of DOM in terms of the Derivational Distinctness Condition even stronger, because, as noted in section 5.3, it is able to capture the lack of DOM with and without Object Shift.

5.6. CONCLUSION AND INTERIM SUMMARY

In this chapter I have focused on the main aspect that makes DOM objects morphologically identical to the rest of agreeing inherent datives: the dative Case assignment. I have proposed that DOM objects receive dative Case configurationally, when bearing the ϕP label coincide with the transitive subject –which is also represented as ϕiP – in the same vP phase domain. This is in fact predicted by the Derivational Distinctness Condition put forth by Richards (2010: 86-87, 114, 117, 125-126), which bans the linearization of identical elements in an asymmetric c-command relation. Instead of assuming that Distinctness effects are only visible at the last step of the syntactic derivation –i.e., when the complement of a given phase is sent to Spell-Out, I have posited that syntax is aware of such condition from the very beginning of the derivation. Therefore, I have claimed that, in Basque DOM varieties, the phasal K head is assigned to the object when the subject enters the derivation in [Spec, vP], as this causes the problematic linearization statement $\langle \phi P, \phi P \rangle$. The K head makes the object linearize in a separate Spell-Out domain and solves the Distinctness violation that would otherwise arise. In line with the KP nature of agreeing inherent datives in [Spec, ApplP], I have assumed that K represents dative Case in DOM object too. Given that

derived from an intransitive predication formed with the verb *izan* ‘be’. Otherwise these should also be possible with individual-level predicates that occur typically with *izan* ‘be’, contrary to facts.

the dative KP shell bears an adjoined clitic head that needs to attach to v , the addition of K accounts not only for the dative marking in the nominal but also in the finite verbal form. It is thus the addition of the K head the mechanism that makes DOM objects exhibit the same morphology as the rest of dative arguments.

Although the original version of the Distinctness Condition contends that the condition is exclusively visible at the syntax-PF interface, three main pieces of evidence have been provided supporting the claim that Basque DOM arises in order to solve a Distinctness effect in the v P phase domain. The first one concerns the lack of evidence arguing for Object Shift to the TP Spell-Out domain. The second one has to do with the possibility to have DOM in interrogative contexts where either the object or the subject ends up being linearized higher than the TP Spell-Out domain. The third one comes from the co-occurrence of DOM objects with ergative subjects in [Spec, TP], which are also considered to be KPs (Rezac et al. 2014) and thus make it unnecessary the addition of K in the TP Spell-Out domain. These three pieces of evidence support the idea that, undergoing or not Object Shift, the Derivational version of the Distinctness Condition is superior to its original version, because it accounts not only for the Distinctness effects that arise at Spell-Out, but also for those that arise throughout the syntactic derivation, explaining this way both the DOM in accusative languages like Spanish and in ergative languages like Hindi or Basque.

With the aim at giving further support to the claim that in Basque DOM yields due to the Derivational Distinctness Condition, the chapter has discussed the distribution of DOM in ditransitive contexts as well as in the derived transitive predication formed with **edun* ‘have’. The distribution of DOM in ditransitive contexts depends on the presence of ApplP in between VP and v P. If the dative appears in [Spec, ApplP], the object will not coincide with the subject in the v P phase domain, because due to the phasal nature of ApplP (McGinnis 2001ab 2004), the object will be transferred to Spell-Out by the time the subject first merges in [Spec, v P]. As a result, human and definite objects appear with absolutive –rather than dative– Case in ditransitives involving agreeing inherent datives, be them causees, experiencers, goals or possessors. On the contrary, if the dative combining with the human and definite object is instead realized as a non-agreeing PP, the object will receive the differential marking, because, in

absence of ApplP, it will coincide with the subject in the ν P phase domain, as happens in transitive constructions. Along with Basque, I have shown that the distribution of DOM in Spanish ditransitive constructions is also accounted for by means of the Derivational Distinctness Condition. As in Basque, in Spanish ditransitives the assignment of the differential marking depends on whether the inherent dative projects an ApplP or not (Demonte 1994, Romero 1997, Ormazabal & Romero 2013abc).

The absence of DOM in derived transitives built up with **edun* ‘have’ has equally been explained by the Derivational Distinctness Condition. Contrary to transitives, the ergative subject in this kind of derived transitives is generated as an oblique argument, and becomes a KP as soon as it moves to [Spec, TP]. Thus, given that the object does not coincide with it in any phase domain of the syntactic derivation, the assignment of the K head happens to be unnecessary in this context.

Summing up, the Derivational Distinctness Condition is thus able to capture not only for the absence but also for the presence of DOM. On the one hand, it accounts for the presence of DOM when the object is human and definite and coincides with the external argument in the ν P phase domain, as this causes a Distinctness effect. On the other hand, it explains the absence of DOM in contexts with no Distinctness effects. This happens (i) when the object is not human and definite and does not bear the ϕ P label and (ii) when the ϕ P object does not coincide with another ϕ P argument in the same ν P phase. This is the case of ditransitives with an agreeing inherent dative projecting an ApplP and of the derived transitive predication formed with **edun* ‘have’, which lacks an external argument in its base –i.e., non-derived– structure.

6. CONCLUSIONS

In this dissertation, I have analyzed the syntax of Basque DOM considering the general scenario of dative arguments. The dissertation has thus contributed not only to the global understanding of the DOM phenomenon –and to its implications for Case Theory, but also to certain aspects related to the syntactic nature of dative phrases that are still under debate.

This chapter summarizes the general conclusions reached in previous chapters and discusses some of the issues that are left open for future investigations. Section 6.1 highlights the main claims and conclusions of the dissertation, which are in turn divided in two main sections. The ones concerning the syntax of DOM objects are presented in section 6.1.1, and those related to the syntax of the rest of dative arguments are given in 6.1.2. In addition, section 6.2 considers some of the aspects that are left open to analyze in further research.

6.1. SUMMARY AND GENERAL CONCLUSIONS

6.1.1. The syntax of DOM objects

This section outlines the main results obtained in the present research on Basque DOM, focusing on its distribution (section 6.1.1.1), original syntactic category (6.1.1.2), Case licensing mechanism (6.1.1.3) and dative Case assignment (section 6.1.1.4).

6.1.1.1. The distribution

Basque DOM objects involve gdative marked human and definite objects –especially those of first and second person– of transitive predicates (Fernández & Rezac 2010 2016, Mounole 2012, Odria 2012 2014, Rodríguez-Ordóñez 2013 2016). As happens in many other languages (Bossong 1985 1991, Aissen 2003), Basque DOM is thus determined by both animacy and specificity, and displays the same morphology as

dative marked indirect objects. Besides, even though their influence is not as systematic as that caused by the referential properties of the object, clausal properties like tense and finiteness affect the distribution –or frequency– of Basque DOM as well, as the differential marking is sometimes reduced in present tense as well as non-finite contexts (Fernández & Rezac 2010 2016).

In Basque, the DOM objects that appear with transitive predicates of the *ikusi* ‘see’ type exhibit the same ergative-dative configuration as bivalent unergative predicates of the *lagundu* ‘accompany, help’ type. However, the dative object in bivalent unergatives differs from DOM objects in not being conditioned by referential or clausal properties and in showing mostly a goal –rather than a theme– theta-role (Fernández & Ortiz de Urbina 2010 2012, Ortiz de Urbina & Fernández 2016).

6.1.1.2. The original syntactic category

Basque DOM objects are generated with a DP syntactic category. This is justified by two main pieces of evidence. First, they are able to license depictive secondary predication (Fernández & Rezac 2010 2016, Odria 2012 2014), which is allowed with DP datives like causees (Zabala 1993 2003), experiencers and possessors, but not with PP-like datives like goals. Second, in contexts affected by the PCC, they are generally unable to occur as non-agreeing by resorting to the PP repair strategy. The PP repair strategy consists of adding uninterpretable phi-features to P, activating thereby its previously inactive Agree/Case locus (Rezac 2011). Due to their DP categorical status, DOM objects have no P head to which uninterpretable phi-features can be added, and thus, are unable to appear without agreeing with the finite verbal form. For this reason, generally speaking, DOM objects are only compatible with goal datives that –by resorting to the PP repair strategy– appear as non-agreeing PPs. The rest of the datives analyzed in this dissertation –i.e., causees, experiencers and possessors– are DPs originally, and as such, they are equally required to Agree with *v*. Consequently, DOM objects are commonly ruled out when combining with them.

6.1.1.3. The Case licensing mechanism

In Basque, DOM objects are Case licensed by Agreeing with the ν head, given that they are affected by the PCC in the same way as canonical absolutes. The PCC is a syntactic constraint located in the ν Agree/Case locus. It affects first and second person objects that are intended to Agree with ν in combination of an agreeing inherent dative c-commanding them (Anagnostopoulou 2003, Béjar & Rezac 2003, Rezac 2007 2008ab 2009ab 2011).

Further support for the ν -Agree relation held by DOM objects comes from the absolute case and agreement marking that these objects show (i) in ditransitive constructions combining a third person object with an agreeing inherent dative in [Spec, ApplP] and (ii) in the derived transitive predication built up with **edun* ‘have’. As predicted by the Derivational Distinctness Condition (Richards 2010), the differential marking is unaccepted –or more precisely, not needed– in these two contexts and, even being human and definite, the object appears with absolute marking. This evidences that, be them dative or not, human and definite objects should first receive absolute Case by Agreeing with ν . Otherwise, it would be unexpected that these objects appeared absolute marked in the mentioned configurations.

6.1.1.4. The dative Case assignment

DOM objects receive dative Case configurationally, when bearing the ϕ P label coincide with the transitive ϕ P subject in the same ν P phase domain. This is in fact predicted by the Derivational Distinctness Condition (Richards 2010), which bans the linearization of identical elements in an asymmetric c-command relation.

In its original version, the Distinctness Condition (Richards 2010) is supposed to hold just at the final step of the syntactic derivation, namely, at Spell-Out domains. Nonetheless, in Basque DOM varieties, syntax seems to be aware of the so-called condition from the very beginning of the derivation, as Distinctness effects leading to DOM are visible in previous stages of the syntactic derivation (and not at final Spell-Out domains).

As happens with agreeing inherent datives in [Spec, ApplP], dative Case in DOM objects is syntactically realized as K –i.e., a phasal head that makes them linearize in a separate Spell-Out domain in order to satisfy the Derivational Distinctness Condition. It is thus the addition of the K head the mechanism that makes DOM objects exhibit the same morphology as the rest of dative arguments, as DOM objects pattern with canonical absolutes up to the Agree relation with *v*. Besides, as K holds an adjoined clitic head, its assignment accounts not only for the dative case marker in the nominal, but also for the dative marker in the finite verbal form. As occurs with agreeing inherent datives in [Spec, ApplP], K involves an adjoined clitic head that, after passing through [Spec, *v*P], ends up being attached to *v* (Matushansky 2006, Rezac 2008a 2011, Nevins 2011, Harizanov 2014, Kramer 2014).

Given that dative Case in DOM objects is the result of the Derivational Distinctness Condition, its distribution in ditransitive constructions depends on the presence of ApplP, which is phasal in nature (McGinnis 2000 2001 2004). If a third person object is combined with an agreeing inherent dative in [Spec, ApplP] and thus ApplP is present in between VP and *v*P, the object will not coincide with the subject in the *v*P phase domain and –even being human and definite– there will be no need for it to receive the K head. As a consequence, the object will appear with the absolute Case assigned previously by *v*. Conversely, if the object is first or second person and the inherent dative is instead a goal realized as a non-agreeing PP, the object will receive the differential marking, because, in absence of ApplP, it will coincide with the subject in the *v*P phase domain. This leads to a double dative construction involving an agreeing DOM object and a goal dative realized as a PP. In addition to Basque, the Derivational Distinctness Condition is likewise able to capture the distribution of DOM in Spanish ditransitives, where agreeing inherent datives and DOM objects are known to be in complementary distribution –see, among many others, Demonte (1994), Romero (1997) and Ormazabal & Romero (2013abc).

As happens in constructions involving an agreeing inherent dative, in the derived transitive predication formed with **edun* ‘have’ the ϕ P object does not coincide with the ϕ P subject in the *v*P phase domain, and as a result, DOM is neither found in it. Contrary to transitives, in this case the ergative subject is generated as an oblique argument

within a silent Applicative head (Etxepare & Uribe-Etxebarria 2012), and becomes a KP as soon as it moves to [Spec, TP]. Therefore, given that the object does not concur with it in any phase domain of the syntactic derivation, the assignment of the K head – equivalent to dative Case– happens to be unnecessary.

Overall, dative Case in Basque DOM objects is neither assigned by means of Agree (Chomsky 2000 2001) –i.e., functionally– nor by means of the Dependent Case –i.e., configurationally– (Baker & Vinokurova 2010, Baker 2012 2015, Levin & Preminger 2015). In spite of being Case licensed by v , in Basque, DOM objects receive dative Case configurationally, by satisfying the Derivational Distinctness Condition (Richards 2010) that –although phonologically motivated– takes place in narrow syntax. This implies that the differential marking is syntactic in nature and that DOM objects involve two kind of structural Cases, each assigned in a different layer of the nominal: the functional absolutive in the DP layer and the configurational dative in the KP layer.

Given that the differential marking is assigned in the v P phase domain, the Derivational version of the Distinctness Condition is able to explain that the DOM object may combine with an ergative subject, because –contrary to the Dependent Case approach– the dative Case assignment does not depend on the subject and object being unlicensed for Case in the final linearization or Spell-Out domain. Hence, although typologically unexpected, the ergative-dative configuration is straightforwardly captured by the Derivational Distinctness Condition. As the condition does not necessarily hold at the final step of the syntactic derivation, it accounts not only for the DOM in accusative languages like Spanish but also in ergative ones like Hindi or Basque.

6.1.2. The syntax of dative arguments

Having summed up the general syntactic aspects of DOM objects, in what follows I turn to recapitulate the syntactic analysis developed for the rest of datives examined in this dissertation, including causees, experiencers, goals and possessors. The syntax of these datives is two-fold concerning their original category and configuration, yet the same Case licensing mechanism is carried out by all of them. Likewise, the clitic doubling process lying behind the dative markers in the finite verb is also unique for all of them. Accordingly, in this section I first review the dual analysis put forth for the categorical

as well as configurational origin of these datives (section 6.1.2.1) and then the uniform analysis proposed for their Case licensing and subsequent process of clitic doubling (section 6.1.2.2).

6.1.2.1. A dual analysis for the categorical as well as configurational origin

Even though a DP –i.e., agreeing– character is commonly shown by all the datives examined in this study, a dual distinction has been established with respect to their categorical and configurational source. Causee, experiencer and possessor datives are generated as DPs in [Spec, ApplP]. On the contrary, goal datives are introduced as PP complements of V –these datives acquire DP-like properties by undergoing P-incorporation and further movement to [Spec, ApplP]

The main criterion distinguishing PP-like goals from the rest of DP datives is the possibility to occur as non-agreeing –i.e., as PPs. In northeastern Basque, contrary to experiencers and possessors, goals are able to appear without dative markers in the finite verbal form. Causees can also do so, but as noted by Fernández, Ortiz de Urbina & Landa (2009), in this case the non-agreeing pattern is not as extended as with goals. In southwestern Basque, only goals can occur as non-agreeing in (i) contexts affected by the PCC and in (ii) double dative constructions in ditransitive causatives involving a causee and a goal. This suggests that, contrary to causees, experiencers and possessors, goals –although actually able to pattern as DPs– are originated as PPs, explaining thereby their mixed DP/PP behavior (Albizu 2001). Such a dual categorical source is additionally evidenced by the (im)possibility to license depictive secondary predication.

The licensing of depictive secondary predication proves that goals are PPs originally. This is mainly supported by the fact that, along with goals, this kind of predication is only excluded with the rest of PP arguments. Taking into account that both agreeing and non-agreeing goals reject the licensing of secondary predication, this implies that agreeing goals that end up the derivation with a DP syntactic category should be originated as PPs, accounting this way for the similar behavior exhibited by these and the rest of PPs. By the same token, as depictive secondary predication is indeed allowed with causee (Zabala 1993 2003), experiencer and possessor datives, these should be originated as DPs, as the rest of ergative and absolutive arguments.

The two-fold categorical origin of dative arguments is also validated by the possibility to appear as non-agreeing by resorting to the PP repair strategy. The PP repair strategy consists of activating the Agree/Case locus in P (Rezac 2011), and thus, should only be available for those datives that, being generated as PPs, in fact project such head. The repair is employed in (i) ditransitives targeted by the PCC and (ii) in double dative constructions involving a ditransitive causative configuration with a causee and a goal dative. As predicted by the dual categorical origin, such a strategy is generally unavailable for DP datives like causees, experiencers and possessors, but available for PP-like goals that are indeed originated as PPs.

When goals resort to the PP repair strategy, the previously inactive Agree/Case locus in P gets activated by the addition of uninterpretable phi-features. In PCC contexts, this provides a separate Agree/Case locus for the Case licensing of each of the internal arguments affected by the constraint: the goal Agrees with P and gets inherent dative Case, and the theme Agrees with v and gets structural absolutive Case. In some cases, such a theme will additionally receive configurational dative Case in DOM varieties, and thus, the PP repair strategy will lead to a double dative construction combining a goal and a DOM object. Similarly, in double dative constructions including a goal and causee dative, the PP repair strategy allows the goal –but not the causee– occur as non-agreeing. In this case, as the goal Agrees with P, v is able to Agree with the causee dative in [Spec, ApplP], and the derivation converges as usual, given that the causee receives inherent Case from Appl and then Agrees defectively in [person] with v . This explains that, both in contexts involving PCC repairs and double dative constructions, the finite verbal form shows no dative marker agreeing with the goal dative.

As happens with DOM objects, DP datives like causees, experiencers and possessors are commonly unable to resort to the PP repair strategy, because, being generated as DPs, they bear no P head to which uninterpretable phi-features can be added in order to provide them a separate Agree/Case locus. As a consequence, PCC effects are generally irreparable when the dative triggering it is of the DP type.

Crucially, the dual categorical distinction is lined up with a dual distinction in the original syntactic configuration of goal datives on the one hand, and causee, experiencer

and possessor datives on the other. While the latter are externally merged in [Spec, ApplP], the former reach that position by internal merge, after undergoing P-incorporation from their original complement position of V.

A mixed analysis is then required for agreeing inherent datives (ending up) in [Spec, ApplP]: a base-generated one for causee, experiencer and possessors, and a derivational one for goals, as –when agreeing– these derive from a configurationally lower position. In the literature on Basque datives, a derivational approach has been pursued, among others, by Ormazabal & Romero (1998 2010 2017) and Albizu (2001 2009), and a base-generated one by Etxepare & Oyharçabal (2013) and Etxepare (2014).

Broadly speaking, the base-generated approach states that agreeing datives enter the derivation directly in [Spec, ApplP], assuming that this position is reached by all of them by means of external merge. In this view, agreeing and non-agreeing goals are syntactically unrelated and, instead of distinguishing them from the rest of DP datives, their main distinction concerns the actual agreeing vs. non-agreeing character of the dative. Hence, grouping agreeing goals with the rest of agreeing DP datives, this approach turns out to be unable to account for the fact that (i) only goals occur as non-agreeing in PCC-affected contexts and double dative constructions in ditransitive causatives involving a causee and a goal, and that (ii) regardless of their actual agreeing or non-agreeing status, only goals reject the licensing of secondary predication.

These facts are only explained if a unique PP syntactic source distinct to that of DP datives is assumed for both agreeing and non-agreeing goals. Crucially, such a common origin should only be shared by goal datives. Otherwise, if all kind of agreeing datives were derived from an original PP construction, all kind of datives should be (i) able to occur as non-agreeing, and (ii) able to license depictive secondary predication, contrary to facts. Moreover, as a single categorical and configurational source would be conceived for all kind of datives, such an approach would show important drawbacks in explaining that agreeing and non-agreeing datives are able co-occur in double dative constructions.

Instead of viewing all kind of agreeing datives as sharing the same base-generated or derivational syntax, this dissertation has specially focused on the difference between

PP-like –i.e., derived– and DP –i.e., base-generated– datives –see also Ormazabal & Romero (2017) and Albizu (2009). As I have already pointed out, the distinction is not only based on the possibility to occur as non-agreeing, but also on the possibility to control depictive secondary predication. As in the base-generated approach, I state that some datives are base generated in the position they actually appear, without relating them to a structurally lower non-agreeing PP counterpart. This is the case of causee, experiencer and possessor datives, which are characterized as DPs occupying a structurally higher position than the direct object. However, it contends that agreeing goals are indeed derived from a structurally lower non-agreeing PP, assuming that these datives acquire DP-like properties by undergoing P-incorporation and subsequent movement to [Spec, ApplP]. This way, the analysis developed in this thesis explains the syntactic similarities shared by agreeing and non-agreeing goals, yet without extending such relation to other kind of datives lacking a non-agreeing counterpart.

6.1.2.2. A uniform analysis for the Case licensing and subsequent clitic doubling

Despite their distinct origin, once in [Spec, ApplP], causee, experiencer, goal and possessor datives pattern uniformly and show –by the end of the derivation– a DP syntactic category by agreeing with the finite verbal form.

Following mainly Rezac’s (2008a 2011) insight, I have argued that they receive inherent dative Case from Appl, which is syntactically realized as K. This implies that the dative nominal is covered within a KP shell that prevents it from undergoing regular Agree with a clausal Agree/Case locus, reducing the ν -Agree relation established by these inherent datives to a defective [person] Agree, blocking thereby further ν -Agree operations involving [person] phi-features. Such an Agree operation ensures that the clitic head adjoined to the KP nominal attaches –i.e., m-merges (Matushansky 2006)– to ν by passing through [Spec, ν P]. The movement of the clitic head to [Spec, ν P] is held by two main facts: (i) the intervention of the agreeing dative in restructuring unaccusative modal constructions (Albizu & Fernández 2002 2006, Ortiz de Urbina 2003b, Goenaga 2006, Rezac et al. 2014), and (ii) the intervention of the pro_{arb} causee in impersonal causative constructions (Albizu 2001, Ortiz de Urbina 2003a).

All in all, from a more general Case Theoretic view, the results in this research imply that dative Case in Basque is not only assigned inherently, but also configurationally. If the hypothesis put forth in this dissertation is on the right track, Basque would then have two dative syntactic or abstract Cases: (i) the inherent one that is assigned phrase-structurally local by an Appl or P head, and (ii) the configurational one that is assigned when another argument is also present in the same phase domain. The present study has thus corroborated that different syntactic or abstract Cases may lay behind a single morphological case –see, among others, Legate (2008) in this regard.

6.2. OPEN ISSUES FOR FURTHER RESEARCH

This dissertation has addressed some of the syntactic aspects of Basque DOM as well as other dative arguments, including causees, experiencers, goals and possessors. With the aim at bringing some light into their syntactic nature, the dissertation has particularly focused on their distribution, their categorical and configurational origin, their Case licensing mechanism and their process of clitic doubling leading to dative markers in the finite verbal form. The present study has then provided a quite general –though not complete– picture of the syntax of DOM objects on the one hand, and causee, experiencer, goal and possessor datives on the other. Notwithstanding, future investigations on the topic should still cover several questions that have been left outside the scope of this dissertation. These include, among many others, the implementation of (i) the variation in the distribution of DOM and (ii) the distinct behavior of both DOM and non-DOM varieties –and languages– within a uniform syntactic account. Each of them is briefly considered in sections 6.2.1 and 6.2.2.

6.2.1. Variation in the distribution of Basque DOM

The characterization of Basque DOM presented in this study is subject to further specifications, as the behavior of DOM in different syntactic environments is fundamentally affected by the actual distribution of the phenomenon, which is in turn determined by different patterns of variation. Consequently, the influence of each of

these patterns should be considered in future investigations, since this may even require modifying certain results obtained in this piece of work,

As I have shown in chapter 2, the distribution of Basque DOM is clearly delimited by referential properties like animacy and specificity, since generally speaking, DOM objects are human and definite. Besides, although humanness seems to be the main cutting point distinguishing those objects that are allowed or not to bear the differential marking, person is a relevant factor as well, given that among human beings first and second person objects show a preference when displaying dative marking. Likewise, tense and finiteness are also influential in Basque DOM, as the phenomenon is sometimes reduced in present as well as non-finite contexts.

Be that as it may, the research carried out in this dissertation has evidenced that Basque DOM is subject to dialectal and –especially– idiolectal variation –see the appendix on this point. Although delimited by animacy and specificity, the DOM found in Basque is a rather unstable phenomenon, as the variation it exhibits does not only affect the frequency –i.e., the optional or obligatory nature– of the phenomenon, but also its actual distribution. For example, as for animacy, DOM (with certain verbs) may be limited to first or second person objects in the case of some speakers, but others may allow it with third person human and definites as well.

The actual distribution of Basque DOM is conditioned by the kind of verb as well, as not all speakers allow the differential marking with all kind of transitive predicates. Concerning specificity, for instance, some verbs may only allow the differential marking with definite objects, while others may even admit it with indefinites as well. Something similar happens with animacy too, since all kind of human beings may be dative marked with certain verbs, but not with others.

As a consequence, although the distribution of the phenomenon has been delimited in general terms, future research on Basque DOM should examine the influence of the verb with further details, and should likewise pay special attention to the dialectal and idiolectal variation. On the one hand, this will give us a more complete and thorough characterization of the distribution of the phenomenon, and will help us understanding its limits in a more accurate way. On the other hand, as the distribution of the

phenomenon directly affects its syntactic behavior in different syntactic environments, a more exhaustive examination of the factors influencing the distribution of Basque DOM will determine whether further nuances should be added to the account presented in this dissertation.

6.2.2. The distinct behavior of DOM and non-DOM varieties/languages

This dissertation has analyzed the syntax of those varieties of Basque showing DOM. However, not all Basque varieties allow the differential marking, and thus, an extension of the present analysis is still required to account for their object Case assignment. Although implementing the behavior of non-DOM varieties in the account proposed for DOM varieties is outside the scope of this dissertation, in what follows I briefly discuss one of the ways to do it in further research.

As DOM is argued to arise with the aim at satisfying the Distinctness Condition, the lack of DOM in non-DOM varieties should be captured by means of the same condition as well. This could be done along the lines of Richards (2010: 80-82), who captures the distinction between DOM and non-DOM languages by claiming that languages may vary in which features they take into account for purposes of linearization, and that hence, the featural representation of nominal structures may vary from language to language. According to Richards (2010: 45-46), in languages like English, two DPs always trigger a Distinctness violation, while in languages like Japanese Distinctness effects only arise if the two DPs bear the same value for Case and animacy. Such a distinction is captured by Richards assuming that the linearization statement in Japanese-type languages involves a more precise featural specification, including Case and animacy features. As noted by Richards (2010: 46), *the fact is not that Japanese is simply immune to Distinctness; rather, its DPs apparently come in more varieties than their English counterparts.*

A similar view could then be adopted when accounting for the intra-linguistic variation attested in Basque DOM and non-DOM varieties. Contrary to what happens in those varieties displaying DOM, the referential properties of the object are not relevant for non-DOM varieties, as these mark all kind of objects absolute regardless of their value for animacy and specificity. Hence, it could be possible to postulate that the

reason for non-DOM varieties to be exempt from assigning the differential marking is simply that DPs involve a richer featural specification in them. Contrary to DOM varieties, in non-DOM varieties, DPs could possibly be distinguished from each other depending on their value for Case, considering this way identical only those DPs bearing an identical Case value. As the object will always bear absolutive Case by the time the subject enters the derivation in [Spec, ν P], non-DOM varieties will always regard the two of them as distinct from each other and there will be no need for the differential marking –i.e., the K head– to be assigned. If the object is human and definite, the linearization statement will be $\langle \phi P[\text{ABS}], \phi P \rangle$ and its Spell-Out will converge as usual. This is of course a preliminary and tentative hypothesis that should be exhaustively developed in further research.

To conclude, and leaving aside the behavior of non-DOM varieties, in this dissertation I have proposed that, in Basque, DOM objects originate with the same configuration as well as category as canonical absolutes. DOM objects enter into an Agree relation with the ν head, which explains –apart from the PCC effects– the absolutive case and agreement marking shown by human and definite objects under certain circumstances. The differential marking arises as a consequence of the Derivational Distinctness Condition (Richards 2010). This is the syntactic mechanism that makes DOM objects morphologically identical to the rest of dative arguments, differing at the same time from canonical absolutes.

Appendix

SOME SOCIO-LINGUISTIC NOTES ON BASQUE DOM

i. The contact situation with Spanish

Due to the contact situation with Spanish, Basque DOM has usually been regarded as a contact-induced phenomenon. Mounole (2012), for instance, attributes the spread of DOM in Basque varieties to Spanish contact. This author examines the diachronic evolution of Basque DOM and argues that Spanish has at least reinforced its incremental use. Other authors like Austin (2006 2015) or Rodríguez-Ordóñez (2013 2016) approach the phenomenon from a socio-linguistic point of view and conclude that Basque DOM is not only reinforced but even induced by the contact with Spanish.

The assumption that Basque DOM arises as a consequence of language contact is evident in dialectological grammars of local varieties as well. These studies generally take the DOM pattern attested in the described variety to be the effect of Spanish interference.¹⁵⁶ The same intuition is also shared by dialectological grammars mentioning that DOM is more extended in those areas where Spanish is more influential than Basque –see, for instance, Ibarra (1995: 429).¹⁵⁷ Notwithstanding, it is important to recall that Zuazo (2000: 206) points out that DOM is spread throughout all southwestern Basque dialects. This author adds that the phenomenon is quite extended not only in Spanish-speaking areas, but also in those places exhibiting a high use of Basque.

¹⁵⁶ See, for instance, Aurrekoetxea & Txillardegi (1983: 52), Hualde, Elordieta & Elordieta (1994: 126), Ibarra (1995: 428 2000: 155-156), Elordui (1996: 732-733), Camino (1997: 365, 463-464), Garmendia & Etxabe (2004: 78) and Apalauza (2010: 408).

¹⁵⁷ Similarly, Makazaga (2009: 17) explains that one of his interviewers from Elgoibar asserts that DOM is more common in urban rather than rural areas where Basque remains stronger. This speaker says that farmers from rural areas show a preference for using absolutive rather than dative objects.

Therefore, the fact that its neighboring language has induced –or at least enhanced– the use of Basque DOM does not necessarily imply that the non-canonical configuration is exclusively attested in those areas where Spanish prevails over the autochthonous language.

i. The academic and social stigmatization

Cross-linguistically, it is frequent for a given linguistic phenomenon that is considered to arise as an effect of language contact to be stigmatized by the speakers of that language. This is in fact the case of Basque DOM, as the Spanish interference hypothesis has led to a high socio-linguistic stigmatization of the phenomenon –see especially Rodríguez-Ordóñez (2016: chapter 6) on this topic.

Assuming its contact-induced nature, prescriptive grammars take DOM as an incorrect use of the language. Besides, the stigmatization of DOM is not only present in prescriptive works dealing with Standard Basque, but also in those which are directed to dialects or local varieties. In an essay on the use of Standard as well as non-Standard Basque, Zuazo (2000: 206), for example, suggests avoiding DOM when speaking in the local variety. The stigmatization of Basque DOM prevails also in dialectological investigations that examine its distribution across Basque varieties. Yrizar (1981-II: 359), for instance, mentions that the appearing of dative marked objects in Basque varieties is an unfortunate fact, a perception that is evident in the title of his section dealing with DOM: “Observaciones referentes al empleo incorrecto de algunas flexiones”, that is, ‘Some observations on the *incorrect* use of certain auxiliary verbs’ (italics are mine).

In addition, it is worth noting that the negative perspective of Basque DOM is not limited to academic studies. The stigmatization is also perceivable socially, among native speakers. DOM has been and is one of the most common *errors* corrected at school and Basque academies, and many parents tend to correct their children when these employ the differential marking. The speakers I have interviewed are also aware of this, and some of them say that although they use it, DOM is a pattern that should be corrected.

ii. The spread of DOM in southwestern Basque

In spite of the mentioned socio-linguistic stigmatization, it is important to recall that Basque DOM is a phenomenon that has been spreading during the last centuries.¹⁵⁸ Mounole (2012) reports that, although an example of DOM was attested in the 16th century, the use of dative marked objects did not spread until the 19th century. This author compares the presence of DOM in Bonaparte's ([1869] 1991) and Yrizar's (1981) collections of verbal paradigms across Basque dialects and asserts that during the 19th and 20th centuries the phenomenon underwent a general spreading in southwestern Basque.¹⁵⁹ The expansion of Basque DOM is also evidenced by some of dialectological grammars already mentioned. Apalauza (2010: 408), for example, explains that only canonical absolutes were attested in the Navarrese varieties from Ultzama and Sakana in the 19th century, while both absolute and dative objects were collected a century later by Yrizar (1981). Similar results are mentioned in Zuazo (2010) in his study on Sakana Basque, since in 1920 dative objects only appeared in the past tense, while from 1960 onwards the dative prevailed over the absolute.¹⁶⁰

iii. The dialectal as well as idiolectal variation

Even being clearly delimited by animacy and specificity, Basque DOM cannot be regarded as a uniform and invariable phenomenon, as it exhibits great dialectal as well as idiolectal variation. In some varieties, DOM is used very frequently and can even be

¹⁵⁸ Basque is not the only language that has gone through a spread of DOM. According to Aissen (2003: 471-472), a similar expansion has been documented in the DOM of other languages such as Persian and Spanish.

¹⁵⁹ The spread of DOM is observed by Mounole (2012) in High Navarrese, Bizkaian and Gipuzkoan dialects. With respect to High Navarrese, Bonaparte ([1869] 1991) found DOM with first and second person in Meridional High Navarrese, while Yrizar (1981) gathered DOM examples not only in Meridional Southern? but also in Western High Navarrese. As for Bizkaian, no DOM was found in Bonaparte's collection, but the phenomenon was already present in many varieties in Yrizar's survey. Finally, in Gipuzkoan no DOM was gathered in neither Bonaparte's nor Yrizar's investigations –yet the phenomenon is nowadays extended in this dialect as well.

¹⁶⁰ See section 2.3.1 (chapter 2) for further details on the influence that tense has in Basque DOM.

the only option in certain configurations. This is the case of the valley of Arratia, where DOM is known to be generalized for first and second person objects (Mounole 2012, Fernández & Rezac 2016). In others, the differential marking is less extended, and occurs just optionally, together with the canonical configuration, as happens in Elgoibar or Zumaia Basque. The realization of DOM is then variable depending on the dialect or variety.

Irrespective of that, the different extension of DOM in the different varieties of Basque does not automatically imply that all the speakers of a given variety share a unified behavior with respect to DOM. As it is pointed out by Fernández & Rezac (2010: 119, fn. 21), idiolectal variation plays an important role in Basque DOM. This is something I have noticed when dealing with my consultants, since not all the speakers from the same variety show the same predisposition to DOM –see also Mounole (2012). Some speakers allow the differential marking just with certain verbs or a given set of human and definite objects, while others allow it in more contexts. The same result can be obtained by analyzing the spontaneous speech of different speakers of the same variety; DOM is more common in the speech of some speakers and less frequent in others. Likewise, variation is attested within the different types of verbs too. DOM appears to be more natural with some verbs than with others –this fact is also reported by Mounole (2012) and Rodríguez-Ordóñez (2016). As a consequence, it is important to notice that, although representing the most general patterns, the data in this dissertation is subject to both dialectal/idiolectal as well as verbal variation, and thus, could vary either depending on the verb or variety/speaker.¹⁶¹

¹⁶¹ DOM has sometimes been considered to show generational variation too. When dealing with DOM in Gipuzkoan Basque, Mounole (2012: 368) notices that DOM is more frequently used by the younger generations. Similar claims are also made concerning the varieties from Bermeo (Gaminde, Romero & Legarra 2012: 142-143), Tolosa and Goierri (Hurtado 2001: 104), Oiratzun (Fraile & Fraile 1996: 11) and Araitz-Betelu (Apalauza 2008: 93). Nevertheless, it is worth highlighting that dialectal grammars mentioning the presence of the phenomenon are generally based on the data provided by elderly speakers. Hence, even though in some cases the use of DOM could be more extended among young speakers, we should bear in mind that, as noted by Zuazo (2000: 206), DOM is equally found in the speech of older generations too, a result corroborated by Rodríguez-Ordóñez (2016) in her analysis of the production of DOM in Gernika Basque.

In relation to the dialectal and idiolectal variation, the cut-off point between grammatical and ungrammatical DOM constructions seems to be quite flexible in Basque. Speakers may accept or not a given sentence when asking for their judgment and show the opposite pattern when speaking spontaneously. As noted by Bossong (1991: 152), this is also a common situation cross-linguistically. Consider the following words taken from Bossong (1991: 152):

“Differential object marking, on the other hand, is a living category; this implies that it is meaningful, and that it is used with a certain degree of variation, i.e. of liberty of choice left to the speaker in the moment of his utterance. The rules are not strict, or more precisely: even if it were possible to formulate the rules in a strict way their applications still would show a more or less great margin of variability”

Apart from its living character, I believe that in the particular case of Basque, the socio-linguistic stigmatization of the phenomenon may also have an influence on this.

References

- bels, K. 2003. *Successive cyclicity, anti-locality, and adposition stranding*. Doctoral dissertation, University of Connecticut.
- Adger, D. & D. Harbour. 2007. Syntax and syncretism of the Person Case Constraint. *Syntax* 10: 2-37.
- Aissen, J. 2003. Differential object marking: iconicity vs. economy. *Natural Language and Linguistic Theory* 21: 435-483.
- Alberdi, X. 1995. The development of the Basque system of terms of address and the allocutive conjugation. In J.I. Hualde, J.A. Lakarra & R.L. Trask (eds.), *Towards a history of the Basque language*. Philadelphia/Amsterdam: John Benjamins. 275-294.
- Albizu, P. 1997a. *The Syntax of Person Agreement*. Doctoral dissertation, University of Southern California.
- Albizu, P. 1997b. Generalized person-case constraint: a case for a syntax-driven inflectional morphology. *Supplements of ASJU* 40: 1-33.
- Albizu, P. 2001. Datibo sintagmaren izaera sintaktikoaren inguruan: eztabaidarako oinarrizko zenbait datu. In B. Fernández & P. Albizu (eds.), *Kasu eta komunztaduraren gainean. On Case and Agreement*. Bilbo: UPV/EHU Editorial Services. 49-69.
- Albizu, P. 2009. Construcciones inacusativas con dativos posesivos y dativos de interés en vasco: un análisis derivacionalista. *Seminario de Lingüística Teórica*, CSIC, Madrid, May 11.
- Albizu, P. & L. Eguren. 2000. An optimality theoretic account for 'Ergative Displacement' in Basque. In W.U. Dressler, O.E. Pfeiffer, M.A. Pöchtrager & J.R. Rennison (eds.), *Morphological Analysis in Comparison*. Amsterdam: John Benjamins. 1-23.
- Albizu, P. & B. Fernández. 2002. Datives' intervention effect on Ergativity in Basque. Paper presented at the *XII Coloquio de Gramática Generativa*, Universidad Nova de Lisboa, Lisboa. (April 15-17, 2002).
- Albizu, P. & B. Fernández. 2006. Licit and illicit ERG-DAT pairings. In B. Fernández & I. Laka (eds.), *Andolin gogoan. Essays in honour of Professor Eguzkitza*. Bilbo: UPV/EHU Editorial Services. 69-96.
- Anagnostopoulou, E. 2003. *The syntax of ditransitives. Evidence from clitics*. Berlin / New York: Mouton de Gruyter.
- Anagnostopoulou, E. 2005. Strong and weak person restrictions. In L. Heggie & F. Ordóñez (eds.), *Clitic and affix combinations: theoretical perspectives*. Amsterdam/Philadelphia: John Benjamins. 199-235.

- Apalauza, A. 2008. Nafarroako Ipar-mendebaldeko euskara: Imotz, Basaburua Nagusia, Larraun, eta Araitz-Betelu. *FLV* 107: 63-104.
- Apalauza, A. 2010. *Nafarroako ipar-mendebaleko hizkeren egitura geolinguistikoa*. Doctoral dissertation, UPV/EHU.
- Arraztio, K. 2010. Datibo osagarri bitxiak Araitz-Beteluko hizkeran. In B. Fernández, P. Albizu & R. Etxepare (eds.), *Euskara eta euskarak: aldakortasun sintaktikoa aztergai. Supplements of ASJU* 52. Bilbo: UPV/EHU. 113-149.
- Arregi, K. & G. Molina-Azaola. 2004. Reestructuring in Basque and the Theory of Agreement. In G. Garding & M. Tsujimura (eds.), *Proceedings of WCFFL* 23. 101-114. Somerville, MA: Cascadilla Press.
- Arregi, E. 2003. On Dative Alternations in Basque. Manuscript, UPV/EHU.
- Arregi, E. & J. Ormazabal. 2003. Aditz ditransitiboaren barne-egitura. In J. M. Makazaga & B. Oyharçabal (eds.) *Euskal gramatikari buruzko eta literaturari buruzko ikerketak XXI. mendearen atarian. Gramatika gaiak*. Iker-14 (I). Bilbo: Euskaltzaindia. 119-136.
- Arregi, K. & A. Nevins. 2008. A principled order to postsyntactic operations. Ms., University of Illinois at Urbana-Champaign & Harvard University.
- Arregi, K. & A. Nevins. 2012. *Morphotactics: Basque auxiliaries and the structure of spellout*. Dordrecht: Springer.
- Artiagoitia, X. 1992. Why Basque doesn't relativize everything. *Supplements of ASJU* 27: 11-35.
- Artiagoitia, X. 1997. DP Predicates in Basque. In A. Taff (ed.), *Washington Working Papers in Linguistics* 15: 161-198.
- Artiagoitia, X. 2000. *Hatsarreak eta Parametroak Lantzen*. UPV-EHU.
- Aurrekoetxea, G. & Txillardegi. 1983. *Euskal dialektologiaren hastapenak*. Bilbo: UEU.
- Austin, J. 2006. Dative overmarking in Basque. *Euskalingua* 9: 136-145.
- Austin, J. 2015. Transfer and contact-induced variation in child Basque. *Frontiers in Psychology* 5: 1-11.
- Baker, M. C. 1988. *Incorporation: A theory of grammatical function changing*. Chicago: University of Chicago Press.
- Baker, M. 1997. Thematic Roles and Syntactic Structure. In L. Haegeman (ed.), *Elements of Grammar*. Kluwer: Dordrecht. 73-137.
- Baker, M. 2008. *The syntax of agreement and concord*. Cambridge: Cambridge University Press.
- Baker, M. 2010. Types of crosslinguistic variation in case assignment. In C. Piccolo (ed.), *Linguistic variation in the Minimalist framework*. Oxford: Oxford University Press.
- Baker, M. 2012. On the relationship of object agreement and accusative case: Evidence from Amharic. *Linguistic Inquiry* 43: 255-274. (pre-publication version).

- Baker, M. 2015. *Case. Its principles and its parameters*. *Cambridge Studies in Linguistics* 146. Cambridge: Cambridge University Press.
- Baker, M. & N. Vinokurova. 2010. Two modalities of case assignment in Sakha. *Natural Language & Linguistic Theory* 28: 593-642.
- Bárány, A. 2015. *Differential object marking in Hungarian and the morphosyntax of case and agreement*. Doctoral dissertation, University of Cambridge.
- Barss, A. & H. Lasnik. 1986. A note on anaphora and double objects. *Linguistic Inquiry* 17: 347-354.
- Béjar, S. 2003. *Phi-syntax: a theory of agreement*. Doctoral dissertation, University of Toronto.
- Béjar, S. & M. Rezac. 2003. Person licensing and the derivation of PCC effects. In A. T. Pérez-Leroux & Y. Roberge (eds.), *Romance linguistics: Theory and acquisition*. Amsterdam: John Benjamins. 49-62.
- Berro, A. 2015. *Breaking verbs. From event structure to syntactic categories in Basque*. Doctoral dissertation, UPV/EHU, Université Bordeaux Montaigne.
- Bhatt, R. 2006. Unaccusativity and Case Licensing. *LFG06 Conference. Workshop on Case and Aspect in South Asian Languages*. Universität Konstanz.
- Bhatt, R. & E. Anagnostopoulou. 1996. Object Shift and Specificity: Evidence from *ko*-phrases in Hindi. In L. Dobrin et al. (eds.), *Proceedings of CLS 32*. Chicago: Chicago Linguistics Society.
- Bittner, M. & K. Hale. 1996. The structural determination of Case and agreement. *Linguistic Inquiry* 27: 1-68.
- Bobaljik, J.D. 2008. Where is phi? Agreement as a post-syntactic operation. In D. Harbour, D. Adger, & S. Béjar (eds.), *Phi theory: Phi- features across modules and interfaces*. Oxford: Oxford University Press. 295-328.
- Boeckx, C. & A. Gallego. 2008. Clitic climbing by (long distance) agree. Meeting clitics. Workshop on explanatory proposals of clitics. Universitat Pompeu Fabra, Barcelona, 18-29 August 2008.
- Bonaparte. 1869. *Le verbe basque en tableaux*. Reprinted in: *Opera omnia vasconice*, vol. 1.1991. Bilbo: Euskaltzaindia. 221-242.
- Bonet, E. 1991. *Morphology after Syntax: Pronominal Clitics in Romance*. Doctoral dissertation, MIT.
- Bonet, E. 1994. The Person-Case constraint: A morphological approach. In H. Harley & C. Phillips (eds.), *MIT Working Papers in Linguistics 22: The morphology-syntax connection*. Cambridge, MA: MITWPL.
- Bosque, I. 2011. *Nueva gramática de la lengua española*. Madrid: Espasa.
- Bossong, G. 1985. *Empirische Universalienforschung. Differentielle Objekt Markierung in der neuiranischen Sphären*. Tübingen: Narr.

- Bossong, G. 1991. Differential Object Marking in Romance and beyond. In D. Wanner & D. A. Kibee (eds.), *New Analyses in Romance Linguistics*. Amsterdam / Philadelphia: John Benjamins. 143-170.
- Bresnan, J. 1982. Control and complementation. *Linguistic Inquiry* 13: 343-434.
- Brugè, L. & G. Brugger. 1996. On the Accusative *a* in Spanish. *Probus* 8. 1-51.
- Butt, M. 1993. Object specificity and agreement in Hindi/Urdu. In K. Beals et al. (eds.), *Papers from the 29th Regional Meeting of the Chicago Linguistic Society*. Chicago: Chicago Linguistic Society. 89-103.
- Camino, I. 1997. *Aezkoako euskararen azterketa dialektologikoa*. Iruñea: Nafarroako Gobernu.
- Cardinaletti, A. & M. Starke. 1999. The typology of structural deficiency. In H. Van Riemsdijk (ed.), *Clitics in the languages of Europe*. Berlin: Mouton de Gruyter. 145-233.
- Carstens, V. 2003. Rethinking complementizer agreement: agree with a case-checked goal. *Linguistic Inquiry* 34-3: 393-412.
- Carstens, V. 2005. Agree and EPP in Bantu. *Natural Language & Linguistic Theory* 23: 219-279.
- Chomsky, N. 1981. *Lectures on government and binding*. Dordrecht: Foris.
- Chomsky, N. 1986. *Knowledge of language: Its Nature, Origins and Use*. New York: Praeger.
- Chomsky, N. 2000. Minimalist inquiries: the framework. In R. Martin, D. Michaels & J. Uriagereka (eds.), *Step by step: essays on minimalist syntax in honor of Howard Lasnik*. Cambridge, Mass.: MIT Press. 89-155.
- Chomsky, N. 2001. Derivation by Phase. M. Kenstowicz (ed.), *Ken Hale: A Life in Language*. Cambridge, Mass.: MIT Press. 1-52.
- Chomsky, N. 2004. Beyond explanatory adequacy. In A. Belletti (ed.), *Structures and beyond*. Oxford/New York: Oxford University Press.
- Chomsky, N. 2007. Approaching UG from below. In U. Sauerland & H.-M. (eds.), *Interfaces + Recursion = Language*. New York: Mouton.
- Chomsky, N. 2008. On phases. In R. Freiding, C.P. Otero & M.L. Zubizarreta (eds.), *Foundational issues in linguistic theory. Essays in honor of Jean-Roger Vergnaud*. Cambridge, MA: MIT. 291-321.
- Comrie, B. (1989). *Language universals and linguistic typology*. 2nd edition. Chicago: University of Chicago Press.
- Cuervo, M.C. 2003. *Datives at Large*. Doctoral dissertation, MIT.
- Danon, G. 2006. Caseless nominals and the projection of DP. *Natural Language & Linguistic Theory* 24-4: 977-1008.
- Demonte, Violeta. 1987. C-command, Preposition and Predication. *Linguistic Inquiry* 18: 147-157.

- Demonte, V. 1988. Remarks on secondary predicates. C-command, extraction and reanalysis. *The Linguistic Review* 6-1. 1-39.
- Demonte, V. 1994. Datives in Spanish. *University of Venice Working Papers in Linguistics* 4: 71-96.
- Demonte, V. 1995. Dative Alternation in Spanish. *Probus* 7-. 5-30.
- Demonte, V. & P. Masullo. 1999. La predicación. Los complementos predicativos. In I. Bosque & V. Demonte (eds.), *Gramática descriptiva de la lengua española*. Madrid: Espasa Calpe, RAE. 2461-2524.
- Deustuko Hizkuntzalaritza Mintegia. 1989. Inkorporazioa perpaus kausatiboetan. In P. Salaburu (ed.), *Sintaxi teoria eta euskara*. VII. Udako Ikastaroak. Donostia, UPVEHU. 87-119.
- Diesing, M. & E. Jalinec. 1993. Distributing arguments. *Natural Language Semantics* 3: 123-176.
- Duguine, M. 2013. *Null arguments and linguistic variation: a minimalist analysis of pro-drop*. Doctoral dissertation, UPV/EHU & Université de Nantes.
- Eguren, L. 2006. Marcas de predicación en vasco. In B. Fernández & I. Laka (eds.), *Andolingogoan. Essays in honor of Professor Eguzkitza*. Euskal Herriko Unibertsitateko Argitalpen Zerbitzua.
- Eguren, L. 2012. Predication Markers in Basque. In U.Etxeberria, R.Etxepare & M.Uribe-Etxebarria (eds.), *Noun Phrases and Nominalization in Basque: Syntax and Semantics*. John Benjamins Publishing Company. 243-266.
- Elordieta, A. 2001. Double Object Constructions and Neutral Order in Basque. *Verb Movement and Constituent Permutation in Basque*. Utrecht: LOT. 49-107.
- Elordui, A. 1996. Hegomendebaldeko bizkieraren aditz egituraren aldaketa-bilakabidea eta hizkuntz desagerpena. *ASJU* 30-3: 713-751.
- Enç, M. 1991. The semantics of specificity. *Linguistic Inquiry* 22, 1: 1-25.
- Etxepare, R. 2003. Valency and Argument Structure in the Verb. In J. I. Hualde & J. Ortiz de Urbina (eds.), *A grammar of Basque*. Berlin: Mouton de Gruyter. 369- 465.
- Etxepare, R. 2006. Number long distance agreement in (substandard) Basque. In J. A. Lakarra & J. I. Hualde (eds), *Studies in Basque and historical linguistics in memory of R. L. Trask*. *ASJU* 40. Bilbo: UPV/EHU. 303-350.
- Etxepare, R. 2014. Contact and Change in a restrictive theory of parameters. In C. Picallo (ed.), *Linguistic Variation in the Minimalist Framework*. Oxford: Oxford University Press. 108-139.
- Etxepare, R. & J. Ortiz de Urbina. 2003. Focalization. In J.I. Hualde & J. Ortiz de Urbina (eds.), *A grammar of Basque*. Berlin: Mouton de Gruyter. 465-522.
- Etxepare, R. & B. Oyharçabal. 2008a. Dative structures in standard and north-eastern Basque. *Licensing conditions at the interface. International Encounter at the Summer Courses of the University of the Basque Country*. XXVI. Donostia, June 23-24.

- Etxepare, R. & B. Oyharçabal. 2008b. Locational datives and dative agreement in the Eastern Dialects of Basque. *European Dialect Syntax Meeting III*, Venice, September 18-21.
- Etxepare, R. & B. Oyharçabal. 2008c. Leku-datiboa ekialdeko zenbait hizkeratan. *Aldaketak, aldaerak, bariazioak euskarari eta euskal testugintzan*. IKER, December 12-13.
- Etxepare, R. & B. Oyharçabal. 2009a. Bi datibo egitura ipar-ekialdeko zenbait hizkeratan. *Lapurdum XIII*: 145-158.
- Etxepare, R. & B. Oihartzabal. 2009b. Datiboa ipar-ekialdeko zenbait hizkeratan. IKER, April 25.
- Etxepare, R. & B. Oyharçabal. 2013. Datives and adpositions in northeastern Basque. In B. Fernández & R. Etxepare (eds.), *Variation in datives: a micro-comparative perspective*. Oxford: Oxford University Press. 50-95.
- Etxepare, R. & M. Uribe-Etxebarria. 2012. Denominal necessity modals in Basque. In U. Etxebarria, R. Etxepare & M. Uribe-Etxebarria (eds.), *Noun phrases and nominalization in Basque*. Amsterdam: John Benjamins. 283-330.
- Euskaltzaindia. 1987. *Euskal Gramatikaren Lehen Urratsak II*. Iruñea: Nafarroako Foru Elkargoa eta Euskaltzaindia.
- Fábregas, A. 2013. Differential Object Marking in Spanish. *Borealis. An International Journal of Spanish Linguistics* 2-2: 1-80.
- Fernández, B. 1997. *Egiturazko kasuaren erkaketa euskaraz*. Bilbo: UPV/EHU Editorial Services.
- Fernández, B. 2010. Goi datiboak eta are goragokoak euskaraz: jabe datiboak eta datibo hunkituak vs. datibo etikoak. *Gogoa*, 10: 1-2: 1-20.
- Fernández, B. 2012. *-(K)i eta -ra*. *ASJU* 15-2: 257-270.
- Fernández, B. 2013. *-(K)i* hiztegiaren, eta hiztegiaren harantzago. *ASJU* 47-2: 1-26.
- Fernández, B. 2014. Goi- eta behe-datiboak eta Datibo-komunztaduraren murriztapena: ipar-ekialdeko hizkerak eta euskara estandarra. I. Epelde (ed.), *Euskal dialektologia: lehena eta oraina. Supplements of ASJU* 69. UPV/EHU. 37-63.
- Fernández, B. 2015a. The syntax of *-(k)i*, a Basque preposition. In X. Sousa, C. de Benito & V. Lara (eds.), *Dialectologia. Special Issue. Syntactic variation in Western European Languages. From the noun phrase to clause structure V*: 81-107.
- Fernández, B. 2015b. *-(K)i*. In B. Fernández & P. Salaburu (eds.), *Ibon Sarasola, Gorazarre. Homenatge, Homenaje*. Bilbo: UPV/EHU. 213-228.
- Fernández, B. & P. Albizu. 2006. Agreement doubling in Basque dialects: Identical and non-identical twins. *Syntactic Doubling conference*. Amsterdam, 15-18 March.
- Fernández, B., A. Berro, I. Orbegozo, A. Arriortua & J. Landa. 2016. *Euskara Bariatioan. Basque in Variation (BiV)*. UPV/EHU [Available on line at <http://basdisyn.net/Bas&Be/biv/>. Accessed on 2016-12-21]

- Fernández, B. & J. Landa. 2009. Datibo komunztadura beti zaindu, inoiz zaindu ez eta batzuetan baino zaintzen ez demean. Hiru ahoko aldagaia, datu iturri bi, eta erreminta bat: Corsintax. *Lapurdum* 13. 159-181.
- Fernández, B. & J. Ortiz de Urbina. 2009. Datibo alternatiboak hizkeretan eta hiztegiatan. *XXVIII Donostiako Uda Ikastaroak/XXI Europar ikastaroak*. July 2-3, Donostia.
- Fernández, B. & J. Ortiz de Urbina. 2010. *Datiboa hiztegian*. Bilbo: UPV/EHU Editorial Services.
- Fernández, B. & J. Ortiz de Urbina, J. 2012. Dative (First) Complements in Basque. In E. Carrilho & B. Fernández (eds.), *Syntactic microvariation in Westmost European Languages. Journal of Portuguese Linguistics (Special Issue)*, 11-1. Edições Colibri - Universidade de Lisboa. 83-98.
- Fernández, B., J. Ortiz de Urbina & J. Landa. 2009. Komunztadurarik gabeko datiboen gakoetz. In R. Etxepare, R. Gómez & J. A. Lakarra (eds.), *Beñat Oihartzabali gorazarre. ASJU* 43: 352-380.
- Fernández, B. & M. Rezac. 2010. Datibo osagarri bitxiak eta Datiboaren Lekualdatzea: *ari nai diyot* eta *kanta egin nazu* bidegurutzean. In B. Fernández, P. Albizu, & R. Etxepare (eds.), *Euskara eta euskarak: aldakortasun sintaktikoa aztergai. Supplements of ASJU* 52. Bilbo: UPV/EHU. 113-149.
- Fernández, B. & M. Rezac. 2016. Differential Object Marking in Basque varieties. In B. Fernández & J. Ortiz de Urbina (eds.), *Microparameters in the grammar of Basque*. Amsterdam: John Benjamins. 93-139.
- Fernández, B. & I. Sarasola. 2010. *Marinelei abisua*: izen ondoko datibo sintagmak izenburuen sintaxian. *Lapurdum* XIV: 55-75.
- Fernández-Ordóñez, I. 1994. Isoglosas internas del castellano. El sistema referencial del pronombre átono de tercera persona. *Revista de Filología Española* 74-1/2: 71-125.
- Fernández-Ordóñez, I. 1999. Leísmo, laísmo y loísmo. In I. Bosque & V. Demonte (eds.), *Gramática descriptiva de la lengua española I*. Madrid: Espasa Calpe. 1317-1394.
- Fernández-Soriano, O. 1999. Two types of impersonal sentences in Spanish: locative and dative subjects. *Syntax* 2-2: 101-140.
- Fraile, I. & A. Fraile. 1996. *Oiartzungo hizkera*. Oiartzun: Oiartzungo Udala.
- Franco, J.A. 1993. Conditions on clitic doubling: the agreement hypothesis. *ASJU* 27: 285-298.
- Gaminde, I., A. Romero & H. Legarra. 2012. *Gramatika eta hizkuntza bariazioa Bermeon*. Bermeoko Udala & Campos Hegaluzea.
- Garmendia, L. & K. Etxabe. 2004. *Ordiziako euskara: garai bateko bizimodua eta gaurko hizkuntza-egoera*. Odrizia: Ordiziako Udala.
- Goenaga, P. 2006. *Behar-en lekua euskal hiztegiatan eta gramatikan*. In B. Fernández & I. Laka (eds.), *Andolin gogoan. Essays in honor of Professor Eguzkitza*. Bilbo: UPV/EHU. 397-416.

- Gracia i Solé, Ll. 1987. *La Teoría Temática*. Doctoral dissertation. Bellaterra: Publicaciones de la Universidad Autònoma de Barcelona.
- Haddican, B. 2005. Two kinds of infinitives in Basque. In J. Alderete, C. Han & A. Kochetov (eds.), *Proceedings of the 24th West Coast Conference on Formal Linguistics*. Somerville, MA: Cascadilla Proceedings Project. 182-190.
- Haddican, B. 2015. A note on Basque vocative clitics. In B. Fernández & P. Salaburu (eds.), *Ibon Sarasola, gorazarre. Homenatge, homenaje*. Euskal Herriko Unibertsitateko Argitalpen Zerbitzua.
- Halliday, M.A.K. 1967. Notes on Transitivity and, Theme in English (Part I), *Journal of Linguistics* 3: 37-81.
- Harbour, D. 2007. A feature calculus for Silverstein hierarchies. *Workshop on Morphology and Argument Encoding*, Harvard University, September 8.
- Harizanov, B. 2014. Clitic doubling at the syntax-morphophonology interface. *Natural Language & Linguistic Theory* 32: 1033-1088.
- Harley, H. 1995. *Subjects, Events and Licensing*. Doctoral dissertation, MIT.
- Harley, H. & E. Ritter. 2002. Person and number in pronouns: a feature-geometric analysis. *Language* 78-3: 482-526.
- Hernanz, M^a Ll. 1988. En torno a la sintaxis y la semántica de los complementos predicativos en español. *Estudis de Sintaxis, Estudi General*, 8 (Colegi universitari de Girona) 7-29.
- Hualde, J. I. 1988. Case-assignment in Basque. *ASJU* 22: 313-330.
- Hualde, J. I. 2003. Verbs. Finite forms. In J. I. Hualde & J. Ortiz de Urbina (eds.), *A grammar of Basque*. Berlin / New York: Mouton de Gruyter. 205-246.
- Hualde, J. I., G. Elordieta & A. Elordieta. 1994. *The Basque dialect of Lequeitio. Supplements of ASJU* 34. Bilbo & Donostia: UPV/EHU & Gipuzkoako Foru Aldundia.
- Hurtado, I. 2001. *Goierriko eta Tolosalde hegoaldeko hizkerak*. Tolosa: Goierriko Euskal Eskola Kultur Elkarte, Maizpide Euskaltegia eta Lazkaoko Udala.
- Ibarra, O. 1995. *Ultzamako hizkera. Inguruko euskalkiekiko harremanak*. Iruñea: Nafarroako Gobernu.
- Ibarra, O. 2000. *Erroibarko eta Esteribarko hizkera*. Iruñea: Nafarroako Unibertsitate Publikoa.
- Irimia, M.-A. 2012. *Secondary predicates*. Doctoral dissertation, University of Toronto.
- Irurtzun, A. 2007. *Spell Out, Focus and Ph(r)ases in the Architecture of the Grammar*. Doctoral dissertation, UPV/EHU.
- Jelinek, E. & A. Carnie. 2003. Argument hierarchies and the mapping principle. In A. Carnie, H. Harley & M. Willie. *Formal approaches to function in grammar: in honor of Eloise Jelinek*. John Benjamins.
- Karimi, S. 2003. On object positions, specificity, and scrambling in Persian. In S. Karimi (ed.), *Word order and scrambling*. Malden/Oxford/Victoria: Blackwell Publishing. 91-124.

- Kayne, R. 1975. *French syntax. The transformational cycle*. Cambridge, MA: the MIT Press.
- Kayne, R. 1993. Toward a modular theory of auxiliary selection. *Studia Linguistica* 47-1: 3-31.
- Kinyalolo, K. K. W. 1991. *Syntactic dependencies and the spec-head agreement hypothesis in Kilega*. Doctoral dissertation, UCLA.
- Klein, U. & P. de Swart. 2011. Case and referential properties. *Lingua* 121: 3-19.
- Koizumi, M. 1994. Secondary predicates. *Journal of East Asian Linguistics* 3: 25-79.
- Kramer, R. 2014. Clitic doubling or object agreement: the view from Amharic. *Natural Language & Linguistic Theory*. 32. 593-634.
- Kratzer, A. 1989. Stage-Level and Individual-Level Predicates. In E. Bach, A. Kratzer & B. Partee (eds.), *Papers on Quantification*, NSF Report. University of Massachusetts at Amherst.
- Laka, I. 1988. Configurational heads in inflectional morphology: The structure of the inflected forms in Basque. *ASJU* 22-2: 343-366.
- Laka, I. 1993. The structure of inflection: A case study in X^o syntax. In J. I. Hualde & J. Ortiz de Urbina (eds.), *Generative studies in Basque linguistics*. Amsterdam: John Benjamins. 21-70.
- Landa, A. 1995. *Conditions on Null Objects in Basque Spanish and their relation to Leísmo and Clitic Doubling*. University of Southern California.
- Lazard, G. 2001. Le marquage différentiel de l'object. In M. Haspelmath, E. Köning W. Oesterreicher & W. Raible (eds.), *Language Typology and Language Universals. An International Handbook*. 2 vol. Berlin / New York: Mouton de Gruyter. 873-885.
- Leonetti, M. 2004. Specificity and differential object marking in Spanish. *Catalan Journal of Linguistics* 3: 75-114.
- Levin, T. & O. Preminger. 2015. Case in Sakha: are two modalities really necessary? *Natural Language & Linguistic Theory* 31: 231-250.
- Linares, C. 2012. *The Dependency Axiom and the Relation between Agreement and Movement*. Unpublished Doctoral dissertation, Rutgers University.
- López, L. 2009. *A derivational syntax for information structure*. *Oxford Studies in Theoretical Linguistics* 23. Oxford: Oxford University Press.
- López, L. 2012. *Indefinite objects*. Cambridge, Mass.: MIT Press.
- Mahajan, A. 1990. *The A/A-bar distinction and movement theory*. Doctoral dissertation, MIT.
- Makazaga, J. M. 2009. *Elgoibarko hizkera*. Doctoral dissertation, UPV/EHU.
- Maling, J. 2001. Dative: the heterogeneity of the mapping among morphological case, grammatical functions, and thematic roles. *Lingua* 111: 419-464.
- Marantz, A. 1991. Case and licensing. Paper presented at *The 8th Eastern States Conference on Linguistics*, University of Maryland.

- Marantz, A. 2000. Case and Licensing. In E.J. Reuland (ed.), *Arguments and case: explaining Burzio's generalization*. John Benjamins. 11-30.
- Marušič, F., T. Marvin & R. Žaucer. 2003. Secondary Predication in Slovenian. In W. Browne *et al.* (eds), *FASL 11 (The Amherst Meeting, 2002)*. Ann Arbor: Michigan Slavic Publications.
- Marušič, F., T. Marvin & R. Žaucer. 2004. Depictive Secondary Predication with no PRO. Manuscript, Stony Brook Univ., Univ of Ljubljana & Univ. of Ottawa.
- Masullo, P. J. 1992. *Incorporation and case theory in Spanish. A crosslinguistic perspective*. Doctoral dissertation, University of Washington.
- Matushansky, O. 2006. On head movement in linguistic theory. *Linguistic Inquiry* 37: 69-109.
- McFadden, T. 2004. *The position of morphological case in the derivation: a study on the syntax-morphology interface*. Doctoral dissertation, University of Pennsylvania.
- McGinnis, M. 2001a. Phases and the syntax of applicatives. *NELS* 31:1-17.
- McGinnis, M. 2001b. Variation in the phase structure of applicatives. In P. Pica & J. Rooryck (eds.), *Linguistic Variation Yearbook*. Amsterdam/Philadelphia: John Benjamins.
- McGinnis, M. 2004. Lethal ambiguity. *Linguistic Inquiry* 35-1: 47-95.
- Mitxelena, K. 1981[2011]. Lengua común y dialectos vascos. In J.A. Lakarra & I. Ruiz Arzallus (eds.), *Luis Michelena. Obras Completas VII. Fonética y Fonología, Morfosintaxis y Dialectología*. University of the Basque Country (UPV/EHU) and Gipuzkoako Foru Aldundia. 517-543.
- Mitxelena, K. & I. Sarasola. 1989-2005. *General Basque Dictionary (Orotariko Euskal Hiztegia)*. Bilbo: Euskaltzaindia. [http://www.euskaltzaindia.eus/index.php?option=com_content&view=article&id=276&Itemid=413&lang=eu]
- Mohanan, T. 1994. *Argument Structure in Hindi*. Stanford: CSLI Publications.
- Montoya, E. 1998. Objektu bikoitzeko egiturak euskaraz. Manuscript, UPV/EHU.
- Mounole, C. 2012. Evolution of the transitive verbs in Basque and apparition of datively marked patients. In G. Authier & K. Haude (eds.), *Ergativity, Transitivity, and Voice*. Berlin / New York: Mouton de Gruyter. 355-379.
- Nevins, A. 2011. Multiple agree with clitics: person complementarity vs. omnivorous number. *Natural Language & Linguistic theory* 29. 939-971.
- Odria, A. 2012. *What lies behind differential Object Marking: a Basque dialect survey*. Master Thesis, UPV/EHU. In P. Salaburu, P. Goenaga & I. Sarasola (eds.), *Sareko Euskal Gramatika*.
- Odria, A. 2014. Differential Object Marking and the nature of dative case in Basque varieties. *Linguistic Variation*, 14-2. Amsterdam/Philadelphia: John Benjamins. 289-317.

- Odria, A. 2015. Euskarazko bigarren mailako predikazioaren murriztapen sintaktikoez. In B. Fernández & P. Salaburu (ed.), *Ibon Sarasola gorazarre. Homenatge. Homenaje*. Bilbo: UPV/EHU. 449-515.
- Ormazabal, J. 1991. Modal verbs in Basque and head-movement. In J.A. Lakarra (ed.), *Memoriae L. Mitxelena magistri sacrum, Supplements of ASJU 14*. Donostia: Gipuzkoako Foru Aldundia. 835-845.
- Ormazabal, J. 2000. A conspiracy theory of case and agreement. In R. Martin et al. (eds.), *Step by step: Essays on Minimalist Syntax in Honor of Howard Lasnik*. Cambridge, Mass.: MIT Press. 235-260.
- Ormazabal, J. & J. Romero. 1998. On the syntactic nature of the Me-lui and the Person Case Constraint. *ASJU* 32-2: 415-433.
- Ormazabal, J. & J. Romero. 2001. A brief description of some agreement restrictions. In B. Fernández & P. Albizu (eds.), *Kasu eta komunztaduraren gainean. On case and agreement*. Bilbo: UPV/EHU Editorial Services. 215-241.
- Ormazabal, J. & J. Romero. 2003. Komunztadura eta Kasua (II): hirugarren komunztadurarik eza. *Basque and (Paleo)Hispanic Studies. In the Wake of Michelena's Work*. Bilbo: UPV/EHU Seminario Julio de Urquijo & Gipuzkoako Foru Aldundia. 315-332.
- Ormazabal, J. & J. Romero. 2007. Object agreement restrictions. *Natural Language & Linguistic Theory* 25: 315-347.
- Ormazabal, J. & J. Romero. 2010. The derivation of dative alternations. In M. Duguine, S. Huidobro & N. Madariaga (eds.), *Argument Structure and Syntactic Relations from a Crosslinguistic Perspective*. Amsterdam / Philadelphia: John Benjamins. 203-232.
- Ormazabal, J. & J. Romero. 2013a. Differential Object Marking, Case and Agreement. *Borealis. An International Journal of Hispanic Linguistics* 2-2: 221-239.
- Ormazabal, J. & J. Romero. 2013b. Non Accusative Objects. *Catalan Journal of Linguistics* 12. 155-173.
- Ormazabal, J. & J. Romero. 2013c. Object clitics, agreement and dialectal variation. *Probus* 20: 33-66.
- Ormazabal, J. & J. Romero. 2017. Historical Changes in Basque Dative Alternations: evidence for a P-based (neo)derivational analysis. Ms., UPV/EHU & University of Extremadura.
- Ortiz de Urbina, J. 1989. *Parameters in the grammar of Basque*. Dordrecht: Foris.
- Ortiz de Urbina, J. 1995. Datibo komunztaduraren gainean. In R. Gómez & J.A. Lakarra (eds.), *Euskal Dialektologiako Kongresua (Donostia, 1991ko Irailak 2-6), Supplements of ASJU* 28. Donostia: Gipuzkoako Foru Aldundia. 579-588.
- Ortiz de Urbina, J. 2003a. Causatives. In J. I. Hualde & J. Ortiz de Urbina (eds.), *A grammar of Basque*. Berlin: Mouton de Gruyter. 592-607.
- Ortiz de Urbina, J. 2003b. Semiauxiliary verbs. In J. I. Hualde & J. Ortiz de Urbina (eds.), *A grammar of Basque*. Berlin: Mouton de Gruyter. 300-312.

- Ortiz de Urbina, J. & B. Fernández. 2016. Datives in Basque bivalent unergatives. In B. Fernández & J. Ortiz de Urbina (eds.), *Microparameters in the grammar of Basque*. Amsterdam: John Benjamins. 67-93.
- Osa, E. 1990. *Euskararen Hitzordena Komunikazio zereginen arauera*. UPV/EHU Printing services. Doctoral dissertation, UPV/EHU.
- Oyhaçabal, B. 1992. Structural Case and inherent case marking: ergaccusativity in Basque. In J. A. Lakarra & J. Ortiz de Urbina (eds), *Syntactic theory and Basque syntax. Supplements of ASJU 27*. Donostia: Gipuzkoako Foru Aldundia. 309-342.
- Oyharçabal, B. 1993. Verb Agreement with Non Arguments: On Allocutive Agreement». In Jose Ignacio Hualde & Jon Ortiz de Urbina (eds.), *Generative Studies in Basque Syntax*. Amsterdam: John Benjamins. 89-114.
- Oyharçabal, B. 2010. Basque ditransitives. In M. Duguine, S. Huidobro & N. Madariaga (eds.), *Argument structure and syntactic relations: A cross-linguistic perspective*. Amsterdam: John Benjamins. 233-260.
- Oyharçabal, B. & R. Etxepare. 2012. The absence of Person/Case constraints in Early Lapurdian Basque. In J. Lakarra, J. Gorrotxategi & B. Urgell (eds.), *Proceedings of the 2nd Conference of the Luis Michelena Chair*. Vitoria-Gasteiz : University of the Basque Country. 149-169.
- Pensado, C. 1995. El complemento directo preposicional: estado de la cuestión y bibliografía comentada. In C. Pensado (ed.), *El complemento directo preposicional*. Madrid: Visor. 11-59.
- Pesetsky, D. 2010. Russian case morphology and syntactic categories. Ms., MIT.
- Perlmutter, D. 1971. *Deep and surface constraints in syntax*. New York: Rinehart & Winston Inc.
- Preminger, O. 2009. Breaking agreements: Distinguishing agreement and clitic doubling by their failures. *Linguistic Inquiry* 40: 619-666.
- Preminger, O. 2014. *Agreement and its failures*. Cambridge, MA: MIT Press.
- Pineda, A. 2016. *Les fronteres de la (in)transitivitat. Estudi dels aplicatius en llengües romàniques i basc*. Barcelona: Institut d'Estudis Món Juïc (Col·lecció Cum Laude, 6).
- Pylkkänen, L. 2008. *Introducing arguments*. Cambridge / London: MIT Press.
- Rezac, M. 2006. *Agreement displacement in Basque: Derivational principles and lexical parameters*. Ms., UPV/EHU.
- Rezac, M. 2007. Escaping the Person Case Constraint: referential computation in the phi system. *Linguistic Variation Yearbook* 6: 97-138.
- Rezac, M. 2008a. Phi-Agree and theta-related Case. In D. Harbour, D. Adger & S. Béjar (eds.), *Phi-theory: phi-features across interfaces and modules*. Oxford: Oxford University Press. 83-130.
- Rezac, M. 2008b. The syntax of eccentric agreement: The Person Case Constraint and Absolutive Displacement in Basque. *Natural Language & Linguistic Theory* 26: 61-106.

- Rezac, M. 2009a. Person restrictions in Basque intransitives. *Lapurdum* 13: 305-322.
- Rezac, M. 2009b. On the unifiability of repairs of the Person Case Constraint: French, Basque, Georgian, and Chinook. In R. Etxepare, R. Gómez & J. A. Lakarra (eds.), *Beñat Oihartzabali gorazarre. ASJU* 43: 1-2. 769-790.
- Rezac, M. 2011. *Phi-features and the modular architecture of language*. Springer: Dordrecht.
- Rezac, M., P. Albizu & R. Etxepare. 2014. The structural ergative of Basque and the theory of Case. *Natural Language & Linguistic Theory* 32-4: 1273-1330.
- Rezac, M. & B. Fernández. 2012. Dative displacement in Basque. In B. Fernández & R. Etxepare (eds.), *Variation in datives*. Oxford: Oxford University Press. 256-282.
- Richards, M. 2004. *Object shift and scrambling in North and West Germanic: A case study in symmetrical syntax*. Doctoral dissertation, University of Cambridge.
- Richards, M. 2008. Defective Agree, case alternations, and the prominence of person. In M. Richards, & A. L. Malchukov (eds.), *Linguistische Arbeits Berichte* 86: 137-162.
- Richards, N. 2007. Lardil “case stacking” and the structural/inherent Case distinction. Manuscript, MIT.
- Richards, N. 2010. *Uttering trees*. Cambridge (Mass.): MIT Press.
- de Rijk, R.P. 1969. Is Basque an SOV language? *FLV* I-3: 319-352.
- de Rijk, R.P. 2008. *Standard Basque. A Progressive Grammar*. Cambridge/London: The MIT Press.
- Roberts, I. 2010. *Agreement and head movement*. Cambridge: MIT Press.
- Rodriguez-Mondoñedo, M. 2007. *The Syntax of Objects: Agree and Differential Object Marking*. Doctoral dissertation, University of Connecticut.
- Rodriguez-Ordoñez, I. 2013. Contact-induced phenomena in gernika basque: the case of dative over-marking. *Selected Proceedings of the 15th Hispanic Linguistics Symposium*, Athens, Georgia. 236-251.
- Rodriguez-Ordoñez, I. 2016. *DOM in Basque: grammaticalization, attitudes and ideological representations*. Doctoral dissertation, University of Illinois at Urbana-Champaign.
- Romero, J. 1997. *Construcciones de doble objeto y gramática universal*. Doctoral dissertation, Universidad Autónoma de Madrid.
- Rothstein, S. 1983. *The syntactic forms of predication*. Doctoral dissertation, MIT.
- Rothstein, S. 1995. Pleonastics and the interpretation of pronouns. *Linguistic Inquiry* 36: 499-529.
- Rothstein, S. 2000. Secondary Predication and Aspectual Structure. *ZAS Papers in Linguistics* 17: 241-264.
- Rothstein, S. 2001. *Predicates and their subjects*. Dordrecht: Kluwer.
- Rothstein, S. 2006. Predication. *Encyclopedia of Language & Linguistics* 10: 73-76.

- Saab, A. & P. Zdrojewski. 2012. Anti-repair effects under ellipsis. Diagnosing (post-) syntactic clitics in Spanish. *Romance Language and Linguistic Theory* 2010: 177-202.
- Sáez, L. 2009. Applicative phrases hosting accusative clitics. In R.P. Leow, H. Campos & D. Lardiere (eds.), *Little words: Their history, phonology, syntax, semantics, pragmatics, and acquisition*. Washington: Georgetown University Press. 61-73.
- Sigurðson, H. Á. 2002. To be an oblique subject: Russian vs. Icelandic. *Natural Language & Linguistic Theory* 20: 691-724.
- Simpson, J. 1983. Resultatives. In L. Levin, M. Rapaport & A. Zaenen (eds.), *Papers in Lexical-functional Grammar*. Bloomington: IULC. 143-157.
- Simpson, J. 2005. Depictives in English and Warlpiri. In N. P. Himmelmann & E. Schultze-Berndt (eds.), *Secondary Predication and Adverbial Modification: the Typology of Depictives*. Oxford: Oxford University Press. 69-106.
- Stowell, T. 1981. *Origins of Phrase Structure*. Doctoral dissertation, MIT.
- Stowell, T. 1983. Subjects Across Categories. *The Linguistic Review* 2: 285-312.
- de Swart, P. 2007. *Cross-linguistic variation in object marking*. Doctoral dissertation, Utrecht: Netherlands Graduate School of Linguistics.
- Taraldsen, K. T. 1995. On agreement and nominative objects in Icelandic. In H. Haider, S. Olsen & S. Vikner (eds.), *Studies in comparative Germanic syntax*. Dordrecht: Kluwer. 207-237.
- Tenny, C. 1987. *Grammaticalizing aspect and affectedness*. Doctoral dissertation, MIT.
- Torrego, E. 1992. Case and agreement structure. Manuscript. University of Massachusetts, Boston.
- Torrego, E. 1998. *The dependencies of objects*. Cambridge, Mass.: MIT Press.
- Torrego, E. 2010. Variability in the case pattern of causative formation in Romance and its implications. *Linguistic Inquiry* 41: 445-470.
- Torrego, E. 2012. The Unaccusative Case Pattern of Hindi and Auxiliary *be*. *Lingua* 122-3: 215-224.
- Torrego, E. & B. Fernández. 2017. Comp-connections: then and now. Manuscript. UPV/EHU.
- Trask, L. 1997. *The history of Basque*. New York: Routledge.
- Uriagereka, J. 1995. Aspects of the syntax of clitic placement in Western Romance. *Linguistic Inquiry* 25: 79-123.
- Urrutia-Cárdenas, H. 1995. Morphosyntactic features in the Spanish of the Basque Country. In C. Silva-Corvalán (ed.), *Spanish in four continents*. Washington, D.C.: Georgetown University Press. 243-259.
- Urrutia-Cárdenas, H. 2003. Los clíticos de tercera persona en el español en el país vasco. *Revista de Filología y su Didáctica* 26: 517-538.
- Williams, E.S. 1980. Predication. *Linguistic Inquiry* 11: 203-237.

- Williams, E.S. 1983. Against Small Clauses. *Linguistic Inquiry* 14-2: 287-308.
- Williams, E.S. 1987. NP trace and theta-theory. *Linguistics and Philosophy* 10: 203-238.
- Yrizar, P. 1981. *Contribución a la dialectología de la lengua vasca* (2 vols.). Donostia: Gipuzkoako Kutxa.
- Yrizar, P. 1997. *Morfología del verbo auxiliar labortano*. Iruñea: Euskaltzaindia/UPV/EHU.
- Yrizar, P. 1999. *Morfología del verbo auxiliar bajo navarro occidental*. Iruñea: Euskaltzaindia/UPV/EHU.
- Zabala, I. 1993. *Predikazioaren teoriak Gramatika Sortzailean (Euskararen kasua)*. Doctoral dissertation, UPV/EHU.
- Zabala, I. 1995. Infinitivos, tiempo y ergatividad. V. Colóquio de Gramática Generativa. A Coruña.
- Zabala, I. 2003. Nominal Predication: copulative sentences and secondary predication. In J. I. Hualde & J. Ortiz de Urbina (eds.), *A Grammar of Basque*. Berlin: Mouton de Gruyter. 426-446.
- Zdrojewski, P. 2008. *¿Por quién doblan los clíticos? Restricciones morfosintácticas sobre la duplicación pronominal en el español rioplatense*, MA Dissertation, Universidad Nacional de Comahue, General Roca.
- Zuazo, K. 2000. *Euskararen sendabelarrak*. Irun: Alberdania.
- Zuazo, K. 2010. *Sakanako euskara. Burundako hizkera*. Nafarroako Gobernua & Euskaltzaindia.
- Zubizarreta, M.L. 1985. Romance accusatives. *Linguistic Inquiry* 16: 247-289.

Abbreviations

1	First person
2	Second Person
2(fam)	Second person familiar
3	Third Person
A	Absolutive
ABL	Ablative
ACC	Accusative
ALL	Allative
AUX	Auxiliary verb
CAUS	Causative
COMP	Complementizer
D	Dative
DF	Dative flag
DEST	Destinative
DOM	Differential Object Marking
E	Ergative
F	Feminine
FUT	Future tense
GEN	Genitive
HAB	Habitual
INE	Inesive
INSTR	Instrumental
M	Masculine
N	Nominative

NOM	Nominalization
pl	Plural
past	Past tense
PERF	Perfective
PRES	Present tense
PRO	Prolative
PROG	Progressive
sg	Singular
SOC	Sociative
TM	Tense/mood

