

Available online at www.sciencedirect.com

SciVerse ScienceDirect

Energy Procedia 00 (2013) 000–000

Energy

Procedia

www.elsevier.com/locate/procedia

69th Conference of the Italian Thermal Machines Engineering Association, ATI2014

Vegetable oils as fuels in Diesel engine. Engine performance and emissions

A. Corsini, A. Marchegiani, F. Rispoli, F. Sciulli, P. Venturini

Dipartimento di Ingegneria Meccanica e Aerospaziale, Sapienza Università di Roma, Rome, Italy

Abstract

The EU new energy strategy represents a challenge and a boost for industries and researchers pushing them to find new solutions to supply the energy demand complying with new environmental requests. The transport sector is one of the most addicted to oil product and then pollutant. A new bio-fuels generation is being studied, but the use of the ones already available should be increased. The use of vegetable oils (VO) and waste cooking oils (WCO) could represent interesting alternative fuels for Diesel engines in some specific applications (i.e., public transportation, hybrid or marine propulsion, etc.). Moreover, VO can be produced almost everywhere in the world in relatively small plants, and WCO would represent the use of a waste material which otherwise should be disposed. However, operating a Diesel engine (DE) with a different fuel might results in some problems. Indeed VO and WCO have different characteristics compared to Diesel fuel (i.e., a smaller heating value, a larger density and viscosity), and this can affect the operation of a DE. In particular the DE is expected to have some problem at the injection system and power loss.

In this work different vegetable oils (both straight and waste) are used to fuel a DE in automotive configuration and study its behavior. Tests are performed using a turbocharged, four stroke, four cylinders, water cooled, common-rail multijet DE. The influence of fuel used on engine power, specific consumption, efficiency, and exhaust opacity, are compared with those obtained fueling with Diesel fuel.

© 2014 The Authors. Published by Elsevier Ltd.

Selection and peer-review under responsibility of ATI NAZIONALE.

Keywords: Straight vegetable oil; waste cooking oil; common-rail Diesel engine; bio-fuels.

1. Background

The new energy strategy adopted by EU (see the Directive 2009/28/EC [1]) represents a challenge for scientists and industry. As a matter of fact it fixes three main objectives which should be accomplished by 2020: to reduce the greenhouse gas (GHG) emissions by 20 %; to reduce the final energy consumption by 20 % (improving energy effi-

1876-6102 © 2013 The Authors. Published by Elsevier Ltd.

Selection and peer-review under responsibility of ATI NAZIONALE.

Nomenclature

BD	Bio-diesel
DE	Diesel engine
DF	Diesel fuel
RO	Rapeseed oil
SVO	Straight vegetable oil

ciency); to provide 20 % of European energy consumption using renewables. The same Directive also fixes at 10 % the minimum consumption of renewable fuel in transports by 2020. This is pushing the development of a new generation of bio-fuels. However, in the meanwhile, the use of the already available biofuels should be widened and efficiently increased in order to achieve the 2020 targets. Nowadays Diesel fuel (DF) can be replaced by bio-diesel (BD), which can be used alone or in blend with DF ([2]-[6]), however its production requires big plants and large energy consumption. For this reason in the last years there is a growing interest on other bio-fuels such as straight vegetable oils (SVO) in order to widen the available alternatives to DF. Actually, the land requested to oilseed crops does not allow to look at SVO as a global alternative to DF. However it can be used in blend with gasoil, bio-diesel (BD) or also alone in some niche applications, such as public transport, hybrid and marine propulsion, electricity generation units, etc. The situation may change with the use of oil from algae which seems to be very promising ([7]-[10]). Notwithstanding the several advantages in using SVO as fuel, some technical problems (i.e., power and engine efficiency losses, feeding system malfunctions, etc.) should be faced.

The present work aims at studying the behavior of a common-rail DE in automotive configuration when fuelled with SVO in comparison with DF and BD.

The interest in using SVO as fuels in automotive applications is growing day by day and there are several small companies producing kits to switch from DF to vegetable oils. Some of them propose their products also for common-rail engine, but so far the number of studies on this kind of engines are not very common. Good reviews can be found in [11] and [12]. Labeckas and Slavinskas [13] reported on the experiments performed on a direct-injection off-road DE fuelled with RO, but it was a low speed, naturally aspired, not common-rail engine. Rakopoulos and coworkers [14] studied the performance of a bus engine operating with several vegetable oils in blend with DF. Fontaras et al. [15] used a Renault Laguna 1.9 dCi passenger car for their tests, but it was fuelled with a RO-DF blend (10% of RO). In a previous work the authors studied the use of RO and waste cooking oil in a common-rail DE [16]. To better understand the effects of the use of SVO in DE more experiments and studies have to be done.

2. Materials and methods

2.1. Fuel properties

In the present work three different fuels are used to feed the DE: rapeseed oils (RO), BD produced from waste cooking oils, and a standard DF. BD and DF have very similar characteristics, conversely vegetable oils are quite different from them ([11], [12]). In the present work, the main characteristics of the fuels used to feed the DE are reported in Table 1. As reported RO has a net heating value smaller than that of DF and a bit larger than that of BD. Density of BD is similar to that of DF, and both are smaller than RO. The viscosity is the physical properties which more affects the engine operation, since a larger fuel viscosity may provoke failures in the feeding system, and deposit formation within the combustion chamber, the feeding channels, the filters, etc.

Viscosity may remarkably vary with temperature, hence in order to avoid problems with the pumping system, its variation with temperature has been measured. It is found that to have a viscosity comparable to that of DF, RO has to be heated up to about 90 °C, as can be found in literature ([11]-[19]), thus this is the temperature we adopted in our tests.

2.2. Experimental setup

The engine used in the test is a FIAT 1.9 JTD, a 4 strokes, common-rail, multijet, turbocharged DE (

Figure 1), and Table 2 summarizes its main characteristics. The engine is taken from a real van and installed, together with its own electronic units, to the bench test at the laboratory of the Engineering Faculty of Sapienza Università di Roma. In order to adapt the engine to the bench test few changes have been done, only involving the supports, the throttle control, the gear box, the flywheel, the exhaust and the fuel tank. In particular a new support structure was built according to the bench test geometry; the throttle control was modified in order to maintain a given position, and its maximum extent was divided into six parts; the gear box and the flywheel were removed since they are not needed for the present tests; the exhaust line was shortened to fit de bench test room. The fuel tank was replaced by a specifically designed bi-fuel system. The system is composed of two fuel tanks (for DE and RO or BD), and a small tank housing the original fuel pump and a thermocouple to measure the actual temperature of pumped fuel. The small tank is connected to a switching valve to fuel the engine alternatively with DF or RO and BD. Each of the two fuel tanks are equipped with a fuel filter, which in the case of DF is a paper micro-fiber filter commonly used in cars, whilst in order to avoid problems due to the high viscosity of the vegetable oils, the second tank is equipped with a plastic filter commonly used in trucks and tractors. Temperature within the vegetable oil tank is controlled by an electronic unit Gefran 1000, which in turn activates/deactivates four RTDs immersed in the fuel. Figure 2 shows the whole bi-fuel system.

The bench test is equipped with a Schenck hydraulic brake, and a Bosch unit (BEA 350) to analyze the exhaust gas opacity. Moreover, two thermocouples within the fuel pump tank and the engine oil pan measure the temperature of the fuel fed and engine lubrication oil respectively.

The engine crankshaft is connected to the brake through a cardan joint. The engine rotating speed is computed by the engine sensor and also by the brake system.

A sketch of the whole measurement system is shown in Figure 3.

Table 1. Main characteristics of the fuels used in the tests.

Oil	Net heating value (MJ/kg)	Density at 20°C (kg/m ³)	Viscosity at 20°C (mm ² /s)
DF	43.3 [19]	868.88	4.15
RO	37.6 [19]	914.50	74.19
BD	36.8 [17]	878.23	4.44



Figure 1. The FIAT 1.9 JTD Multijet engine used for the tests campaign.

Table 2. Main characteristics of the engine used for the tests.

Type	1.9 MultiJet
Charge	Turbocharge (with intercooler)
Fuel	Diesel fuel
Displacement	1910 cc
Power	89.5 kW (120 hp)
Maximum torque	200 Nm

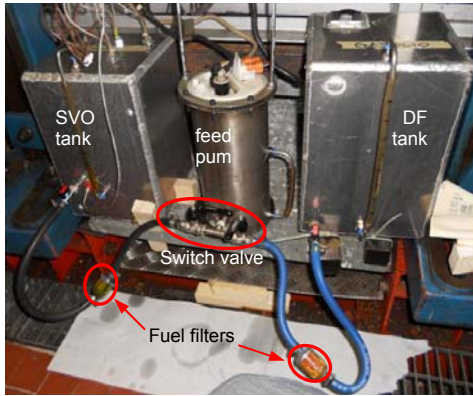

Figure 2. Bi-fuel system.

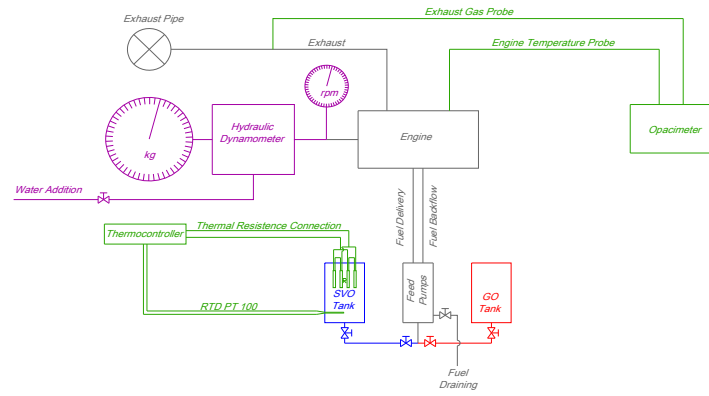

Figure 3. Sketch of the measurement system.

3. Results and discussions

The aim of the test performed was to measure the engine power and pollutant emissions.

During the tests performed with vegetable oil, start phase (about 10') was done fuelling with DF in order to warm up the engine; DF was also used during the stop phase (about 10') in order to remove the vegetable oil from the feeding systems, injectors and cylinders.

In order to track the power curves at different operative conditions, engine power is measured at each of the six throttle positions, and at several engine rpm, starting from 4200 rpm, down to 1250 rpm, with about 500 rpm step.

Pollutant emissions are expressed in terms of exhaust opacity and concentration of unburnt hydrocarbons (C_xH_y), CO, CO₂, and NO_x.

3.1. Power curves

Figure 4 shows the power curves at each of the six throttle positions, and for the three fuels tested. It is evident that there is a difference in engine power using different fuels. In particular the difference is larger at throttle position equal to 1/6, at which it is clear that engine power is larger using DF at almost all the rpm range. At 2500 rpm the engine power measured using RO and BD is 16% and 22% (respectively) smaller than that using DF. The power loss in the case of BD is due to the smaller heating value comparing with DF. In the case of RO instead, the effect of a smaller heating value is partly recovered by its larger density, thus at constant volume of fuel injected within the cylinder, the mass is larger as well as its energy content. This could explain the smaller difference in power output between RO and BD. Comparing RO with DF, the power loss can be ascribed to the larger viscosity of RO, even if injected at 90°C. A larger viscosity results in a poor nebulization of the fuel, especially at low regimes and low throttle position. In these operative conditions indeed, the amount of fuel injected within the cylinder is small, then the injection time plays an important role. Injection time can be divided into three phases: a first phase in which injectors open, a second one in which they stay in a steady position (which is the main injection phase), and then the closing phase. When the total injection time is small, the first and last phases, which are the ones during which nebulization is worst, become relevant resulting in a bad nebulization and thus a bad combustion, which in turn results in a power loss.

The power loss decreases as throttle position increases (Figure 4). From 3/6 up to full throttle, all the tested fuels give a comparable power in a regime up to about 2800 rpm, then there are some differences. At 3/6 throttle position, DF gives larger power, with RO giving the smallest. From 4/6 up to full throttle, BD gives the larger power, RO follows the DF curves up to 3800 rpm and then gives a larger power. This trend, which in some cases is not very coherent, can be ascribed to the electronic unit control. It can check several parameters, such as the number of fuel jets, the fuel temperature, the exhaust temperature and composition, etc., and on the basis of their values the electronic

unit tries to best fit the engine map recorded in it. Working with different fuels may then provoke an unpredictable behavior of the electronic unit, hence engine operates irregularly.

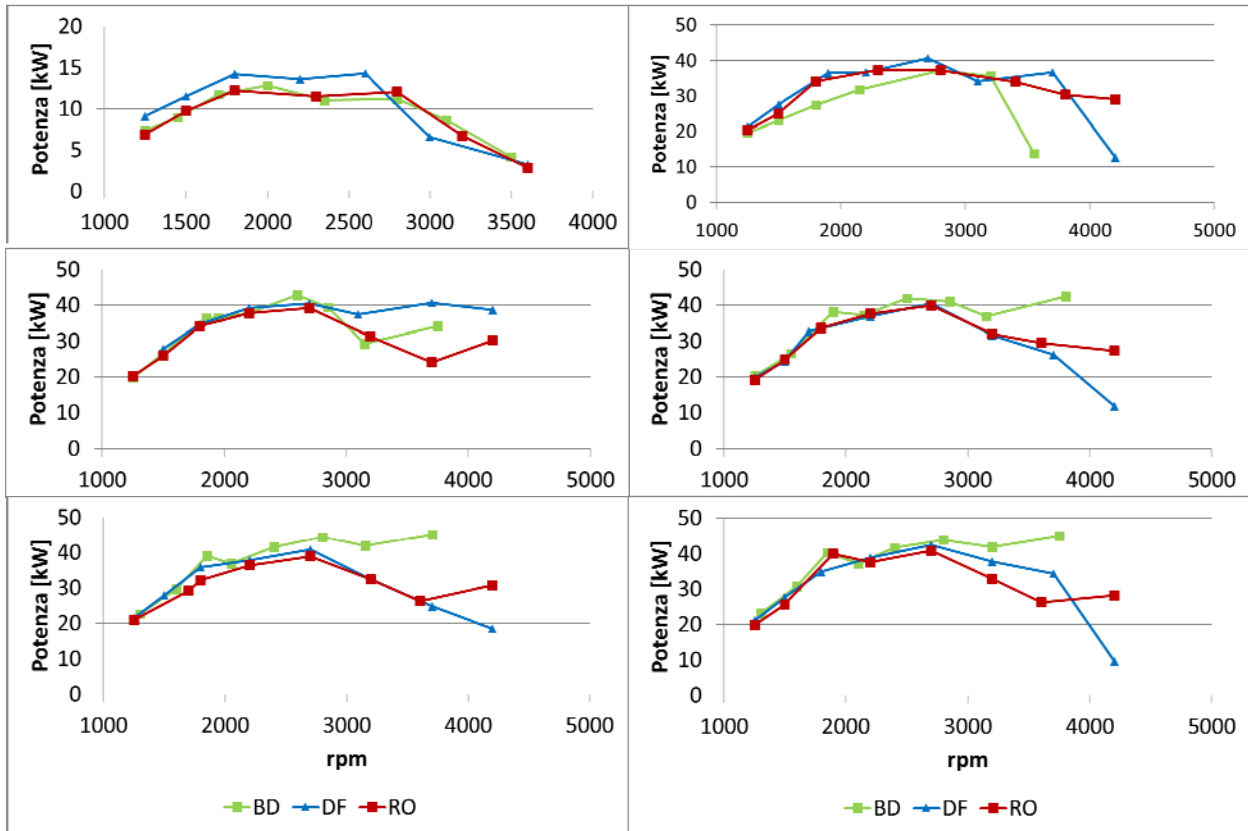

Figure 4. Power curves at different throttle positions for BD, RO and DF: 1/6 throttle (top left), 2/6 throttle (top right), 3/6 throttle (centre left), 4/6 throttle (centre right), 5/6 throttle (bottom left), 6/6 throttle (bottom right).

3.2. Exhaust opacity and Pollutant emissions

Exhaust opacity is shown in Figure 5. All the tests were repeated 11 times to have significant measurements. It is clear that opacity of exhaust from DF is the largest, whilst RO and BD show similar values. Opacity of exhausts measures soot emissions. Soot forms during combustion of organic fuels in case of oxygen scarcity and large presence of carbon. All the tested fuels contains C, but DF does not contain oxygen at all, thus soot formation is more difficult in the case of RO and BD combustion. This phenomenon is enhanced by the fact that the electronic control unit is set to work with DF, thus the air aspired is larger than those actually required to optimize the combustion of RO or DF. The results is a larger availability of oxygen in the case of RO and BD which does not favor the soot formation.

Figure 6-Figure 8 show the main pollutants measured during tests (namely HC, CO₂, and NO_x; CO was null in all the tests). The larger concentration of unburnt hydrocarbons (HC, Figure 6) comes from RO combustion, whilst the smaller from BD. The large HC content in exhaust of RO is due to the molecular structure of this oil. Vegetable oil is composed of long C- chains which are broken during pre-combustion reactions. Since the combustion phase in a internal combustion engine is very fast, probably these chains do not have time to be broken and burn before exiting the cylinder. On the contrary, BD is very similar to DF composition, but having a smaller content of C, thus its behavior, in terms of HC content in the exhaust, is lower but comparable with that of DF.

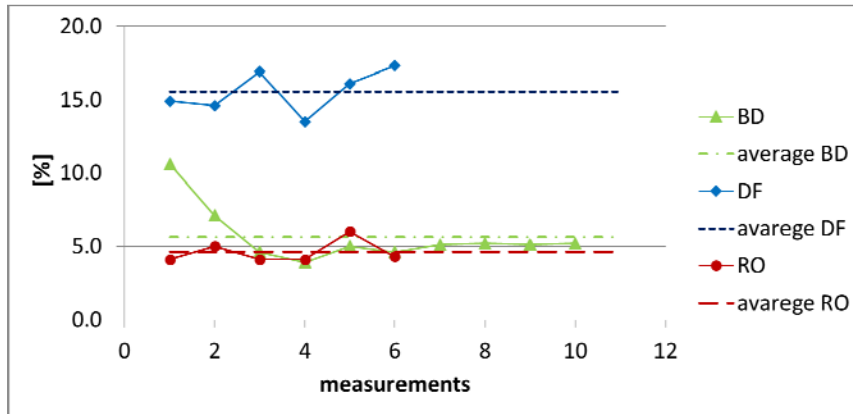

Figure 5. Exhaust opacity.

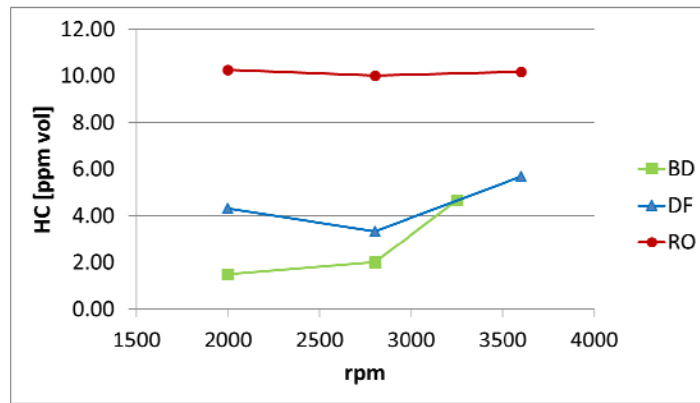

Figure 6. HC concentration in exhaust.

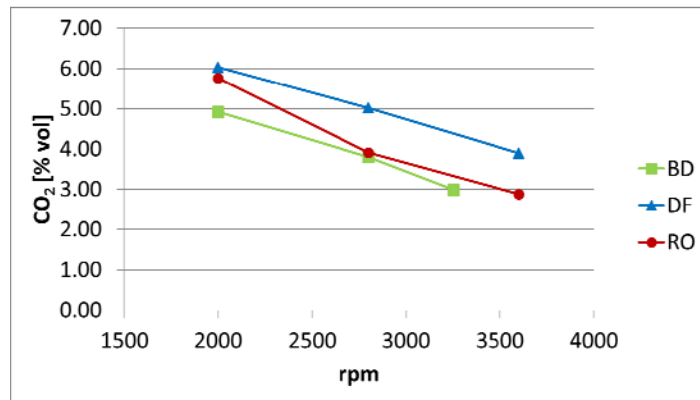

Figure 7. CO₂ concentration in exhaust.

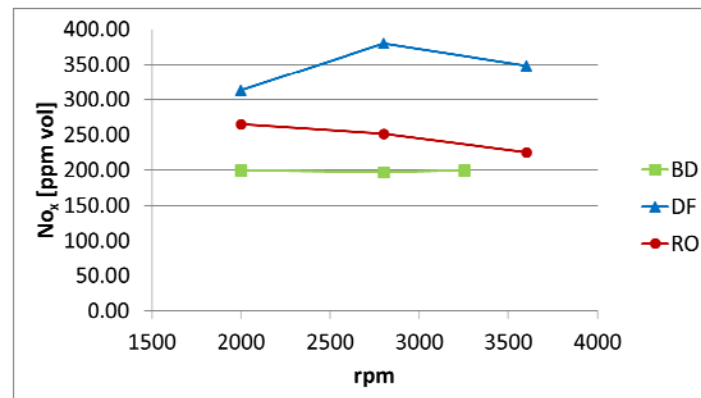

Figure 8. NO_x concentration in exhaust.

Figure 7 shows the concentration of CO₂ in the exhaust. As shown in the figure, RO, BD and DF produces a similar content of CO₂, with BD and RO giving the smaller values. However, it is worth noting that biofuels do not give a relevant contribution to CO₂ concentration in the atmosphere, since during combustion (or any energy conversion process) the amount of CO₂ emitted is not larger than that absorbed during the life of the plants.

The NO_x content is shown in Figure 8. Both RO and BD produce a substantially smaller amount of this compound. As reported in literature (see for instance [12]) this is due to the lower heating values of RO and BD comparing with DF. Indeed a smaller heating value results in a smaller peak temperature reached during combustion, which reduces the activity of the thermal-NO_x production mechanism which is the main one acting in an internal combustion engine.

4. Conclusions

Bench tests on a FIAT 1.9 JTD, a 4 strokes, common-rail, multijet, turbocharged Diesel engine, fuelled with RO, BD and DF are performed. The engine is in real automotive configuration, equipped with its original electronic unit.

Bench tests shows that power loss due to the use of RO and BD is relevant mainly at low loads (ranging from 18 to 22 %). At higher loads the three fuels show a similar behavior up to about 2800 rpm, than BD gives a larger power output. This behavior may be ascribed to the combined effects of different density and viscosity of vegetable oils, electronic unit intervention, and the injection time which is varied according to load.

Opacity tests demonstrated the effectiveness of the tested biofuels in reduce soot formation, and then particulate emissions. Pollutant emissions are comparable to or less than those of DF, apart from HC emission from RO which reaches the highest level.

Besides these results, during the tests emerged that for DE in automotive configuration, fuel characteristics and the electronic control unit play a paramount role. The former can be manipulated, within certain limits, heating up the fuel (namely the SVO) before it enters the feeding system. The latter aspect requires a different tuning of the electronic unit for different fuels, and a switch system which allows the engine to work always at its optimal operating point.

5. Acknowledgements

The authors would like to acknowledge Eng. Stefano Nardecchia and Eng. Fabrizio Valentinetti for the help they gave in preparing engine and performing the tests.

References

- [1] Directive 2009/28/EC of the European Parliament and of the Council of 23 April 2009 on the promotion of the use of energy from renewable sources and amending and subsequently repealing Directives 2001/77/EC and 2003/30/EC. Available at: eur-lex.europa.eu.
- [2] Canacki M., Combustion characteristics of a turbocharged DI compression ignition engine fueled with petroleum diesel fuels and biodiesel. *Bioresource Technology* 2007;98(6):1167-1175.
- [3] Kalligeros S., Zannikos F., Stourmas S., Lois E., Anastopoulos G., Teas Ch, Sakellaropoulos F., An investigation of using biodiesel/marine diesel blends on the performance of a stationary diesel engine. *Biomass and Bioenergy* 2003;24(2):141-149.
- [4] Wang G.W., Lyons D.W., Clark N.N., Gautam M., Norton P.M., Emissions from nine heavy trucks fuelled by diesel and biodiesel blend without engine modification. *Environmental Science & Technology* 2000;34(6):933-939.
- [5] Lapuerta M., Armas O., Rodríguez-Fernández J., Effect of biodiesel fuels on diesel engine emissions. *Progress in Energy and Combustion and Science* 2008;34(2):198:223.
- [6] Ramadhas A.S., Muraleedharan C., Jayaraj S., Performance and emission evaluation of a diesel engine fuelled with methyl esters of rubber seed oil. *Renewable Energy* 2005;30(12):1789-1800.
- [7] Vijayaraghavan K., Hemanathan K., Biodiesel production from freshwater algae. *Energy & Fuels* 2009;23:5448-5453.
- [8] Demirbas A., Fatih Demirbas M., Importance of algae oil as a source of biodiesel. *Energy Conversion and Management* 2011;52:163-170.
- [9] Scott S.A., Davey M.P., Dennis J.S., Horst I., Howe C.J., Lea-Smith D., Smith A.G., Biodiesel from algae: challenges and prospects. *Current Option in Biotechnology* 2010;21:277-286.
- [10] Demirbas A., Biodiesel from algae, biofixation of carbon dioxide by microalgae: a solution to pollution problems. *Applied Energy* 2011;88:3541-3547.
- [11] Misra R.D., Murthy M.S., Straight vegetable oil usage in a compression ignition engine – A review. *Renewable and Sustainable Energy Reviews* 2010;14:3005-3013.
- [12] Sidibé S.S., Blin J., Vaitilingom G., Azoumah Y., Use of crude filtered vegetable oil as a fuel in Diesel engines state of the art: literature review. *Renewable and Sustainable Energy Reviews* 2010;14:2748-2759.
- [13] Labeckas G., Slavinskas S., Performance of direct-injection off-road diesel engine on rapeseed oil. *Renewable Energy* 2006;31:849-863.
- [14] Rakopoulos D.C., Rakopoulos C.D., Giakoumis E.G., Dimaratos A.M., Founti M.A., Comparative environmental behaviour of bus engine operating on blends of diesel fuel with four straight vegetable oils of Greek origin: Sunflower, cottonseed, corn and olive. *Fuel*, 2011;90(11): 3439-3446.
- [15] Fontaras G., Kousoulidou M., Karavalakis G., Bakeas E., Samaras Z., Impact of straight vegetable oil-diesel blends application on vehicle regulated and non-regulated emissions over legislated and real world driving cycles. *Biomass and Bioenergy* 2011;35:3188-3198.
- [16] Corsini A., Giovannoni V., Nardecchia S., Rispoli F., Sciulli F., Venturini P., Performance of a common-rail Diesel engine fuelled with rapeseed and waste cooking oils. In *Proceedings of ECOS 2012 – The 25th International Conference on Efficiency, Cost, Optimization, Simulation of Environmental Impact of Energy Systems*, June 26-29, Perugia, Italy.
- [17] Esteban B., Riba J-R., Baquero G., Rius A., Puig R., Temperature dependence of density and viscosity of vegetable oils. *Biomass and Bioenergy*, 2012(42): 164-171.
- [18] Hossain A.K., Davies P.A., Plant oils as fuels for compression ignition engines: A technical review and life-cycle analysis. *Renewable Energy* 2010;35:1-13.
- [19] Altin R., Cetinkaya S., Husein S.Y., The potential of using vegetable oil fuels as fuel for diesel engine. *Energy Conversion and Management* 2001;42:529-538.
- [20] Briant J., Denis J., Parc G., *Propriétéè rhéologiques des lubrifiants*. Paris, France: Editions Technip et Institut Francais du Petrole; 1985.