

Smart energy meter based on a long-range wide-area network for a stand-alone photovoltaic system

Waheb A. Jabbar^{a,b,*}, Sanmathy Annathurai^a, Tajul Ariffin A. Rahim^a, M. Fitri Mohd Fauzi^a

^a Faculty of Electrical and Electronics Engineering Technology, Universiti Malaysia Pahang, 26600 Pekan, Pahang, Malaysia

^b School of Engineering and Built Environment, Birmingham City University, Birmingham B4 7XG, UK

ARTICLE INFO

Keywords:

AllThingsTalkMaker
LoRa, LoRaWAN
PV System
Smart Energy Meter
TTN

ABSTRACT

Long-range wide-area network (LoRaWAN) has emerged as a key technology for Internet of Things (IoT) applications worldwide owing to its cost-effectiveness, robustness to interference, low power, licensed-free frequency band, and long-range connectivity, thanks to the adaptive data rate. In this contribution, an IoT-enabled smart energy meter based on LoRaWAN technology (SEM-LoRaWAN) is developed to measure the energy consumption for a photovoltaic (PV) system and send real-time data to the utility/consumers over the Internet for billing/monitoring purposes. The proposed SEM-LoRaWAN is implemented in a PV system to monitor related parameters (i.e., voltage, current, power, energy, light intensity, temperature, and humidity) and update this information to the cloud. A LoRa shield is attached to an Arduino microcontroller with several sensors to gather the required information and send it to a LoRaWAN gateway. We also propose an algorithm to compose data from multiple sensors as payloads and upload these data using the gateway to The Things Network (TTN). The AllThingsTalkMaker IoT server is integrated into the TTN to be accessed using Web/mobile application interfaces. System-level tests are conducted using a fabricated testbed and connected to a solar panel to prove the SEM-LoRaWAN effectiveness in terms of functionality, simplicity, reliability, and cost. The connectivity between the system and users is achieved using smartphones/laptops. Results demonstrate a smooth system operation with detailed and accurate measurements of electrical usage and PV environmental conditions in real-time.

1. Introduction

In this globalization era, the usage of renewable energy, particularly solar energy, is growing rapidly and becoming more popular either in the residential or industrial sectors (Kobylnski, Wierzbowski, & Piotrowski, 2020). Malaysia also takes an opportunity in this field by utilizing the free sources from solar energy to give benefits to citizens because the solar photovoltaic (PV) systems have accomplished a strong market growth over the last decade (Jabbar, Saad, Hashim, Zaharudin, & Abidin, 2018; Lorente, Liu, & Morrow, 2020). Solar energy is still not implanted widely throughout Malaysia; only several solar farms are deployed in certain areas, such as the Ayer Keroh, Sepang, and Gambang. The PV system can work as a stand-alone (off-grid) or grid-connected power system to convert sunlight into direct current (DC) electricity using PVs. The produced DC electricity will be used during the daytime to charge the battery using a voltage regulator to ensure the proper and safe charging of the battery (Al-Ali, et al., 2020). DC appliances can be supplied directly from the system, but alternating current

(AC) appliances can be powered via a DC-AC inverter. During the nighttime, loads will be fed directly from the battery. The produced energy using PV has been increased as the total energy demand shows an increment; thus, PV is rapidly being an integral part of the generation systems globally (Ismail, Aleem, Abdelaziz, & Zobaa, 2019). In the case of the grid-connected PV system operation mode, the electricity is converted to AC and fed to the grid; thus, AC energy meters are sufficient to measure the supplied/consumed energy. However, in the case of the stand-alone off-grid system operation mode, which serves the substantial rural population or telecommunication service providers, AC/DC energy meters may be necessary based on the connected utilities (Uebel et al., 2020).

The global smart metering system market will grow owing to the regulatory inclination toward the expansion of the smart grid network along with the flourishing renewable industry. Its size was valued at USD 16.39 Billion in 2018 and is projected to reach USD 30.19 Billion by 2026. A smart energy meter (SEM) measures energy consumption and provides crucial and accurate analytics on electrical usage in real-time

* Corresponding author.

E-mail address: waheb@ieee.org (W.A. Jabbar).

<https://doi.org/10.1016/j.eswa.2022.116703>

Received 23 May 2021; Received in revised form 27 January 2022; Accepted 19 February 2022

Available online 24 February 2022

0957-4174/© 2022 The Authors. Published by Elsevier Ltd. This is an open access article under the CC BY license (<http://creativecommons.org/licenses/by/4.0/>).

or at least daily back to the utility for monitoring and billing to overcome issues caused by conventional energy meters (Pawar & TarunKumar, 2020). The SEM comes with an embedded microcontroller for data processing and sending over wired/wireless links to the utility company (Balfaqih, Balfaqih, Shepelev, Alharbi, & Jabbar, 2020; Narmadha, Rajkumar, Sumithra, & Steffi, 2020). Moreover, the SEM is a key player in the emerged smart grid concept and has considerable potential to enabling consumers' awareness and controllability over their electricity usage to track their energy consumption, reduce electricity bills, and improve the interaction between consumers and utilities (Saleem, Crespi, Rehmani, & Copeland, 2019; Siano, De Marco, Rolán, & Loia, 2019). The SEM also allows utilities to read daily energy usage and prepare accurate bills for a more energy-efficient, smarter, and greener environment. Furthermore, the SEM encourages utilities to manage manual operations remotely, thereby reducing operational costs and workforce (Kumar, et al., 2019; Patttanayak, Pattnaik, & Panda, 2014).

A smart meter is a device able to monitor in real-time the consumer's energy consumption. Smart meters are one of the primary sources of real-time monitoring data and help the utility to improve the power quality and network efficiency. A smart meter enables the technology of a smart grid as it can produce a new planned billing system, encourage productive force circulation, and others. Table 1 shows a comparison between conventional energy meters and SEMs. Both types of meters are compared in terms of display, measuring, and recording ability, including communication capability.

In other words, SEMs can deliver smarter control, smarter information, smarter payments, and safer integration of renewable energy sources, including PV cells into the grid. In the current era and given the emergence of new wireless technologies, SEMs are gaining momentum and significant interest from households and electricity suppliers. However, utility companies are still applying the manual method to read and collect data of energy consumption using conventional energy meters, which causes a delay and inaccuracy in the billing system. Furthermore, the conventional energy meter is not user-friendly as the consumers do not know their energy usage, unlike the smart meter that uses two-way communication between the consumers and the utility provider. This smart meter has the concept of Graphical User Interface (GUI) and Internet of Things (IoT) that provides information to both parties.

The existing energy meters exploit various wireless technologies and protocols for data communication and transmission, such as ZigBee, Wi-Fi, Bluetooth, GSM, 3G, and 4G (Chettri & Bera, 2019). These technologies have many limitations in terms of connectivity range, interference, data rate, cost, or energy consumption. This case may affect the reliability and robustness of the SEM operation. Recently, the IoT has become an enabler for a set of new context monitoring and control applications in the deployment scenarios of the smart grid. The advancement of low-power wide-area network (LPWAN) has facilitated the realization of such ubiquitous applications including smart metering (Chaudhari, Zennaro, & Borkar, 2020; Gaber, et al., 2019; Salam, 2020). The LPWAN has typically star-of-star network topology, and each network connects thousands of IoT end-devices to a faraway gateway. Long range (LoRa) as a physical layer and long-range wide-area network (LoRaWAN) as a MAC Layer protocol are key enablers and representative standards of the LPWAN applications. LoRa can provide reliable, low-power, and long-range communication up to a 15-km range. LoRaWAN is an emerging wireless technology for IoT applications

worldwide and is gaining wider popularity owing to its flexibility and ease of deployment (Jabbar, Wei, Azmi, & Haironnazli, 2021; Magrin, Capuzzo, & Zanella, 2019). In this sense, LoRaWAN networks have great potential to solve the aforementioned problems faced by other wireless technologies. Owing to the features of stand-alone PV system deployments in uninhabited places either in rural areas or near telecommunication towers, the LoRaWAN platform is a potential candidate to enable smart metering and interactive PV systems monitoring.

Despite these attractive features of LoRaWAN, this technology has not yet been fully utilized in the smart energy metering of PV systems to monitor electricity parameters and the surrounding environmental conditions of PV cells. Therefore, this study provides a detailed design and implementation of a cost-effective SEM known as SEM-LoRaWAN for PV systems as an IoT solution. The SEM-LoRaWAN will measure various electricity and environmental parameters including voltage, current, power, energy, light intensity, temperature, and humidity. Our study focuses on the DC load energy meter rather than the AC, which is already available in the market. The developed SEM-LoRaWAN passes detailed information remotely to the users/utilities over the Internet in real-time regardless of the place of PV system deployment. This information will be used for estimating electricity bills and monitoring solar cell conditions, thereby increasing operational efficiency and encouraging consumers to integrate more solar cells into the grid.

Several commercially available SEMs exist in the market in addition to many studies on smart energy metering (Avancini, et al., 2020; Faisal, Karim, Pavel, Hossen, & Lipu, 2019; Fan, Zhou, Sun, Du, & Zhao, 2019; Hameed & Barnouti, 2019; Narmadha, et al., 2020; Nitnaware, 2019; Patel & Upadhyaya, 2020; Pawar & TarunKumar, 2020; Prathik, Anitha, & Anitha, 2018; Uebel, et al., 2020). However, they have many limitations, such as the lack of utilizing the new IoT concept, wireless interfaces constraints, unfriendly user interface, high cost, and AC-based. In addition, studies on real deployments and experimental validation in the area of smart energy metering systems based on IoT, in general, are limited. Furthermore, as the LoRaWAN technology is rather new, its implementation in smart metering has not received adequate attention from the academic community yet. To the best of our knowledge, none of the related studies investigated the utilization of LoRaWAN technology in the smart energy metering of PV systems. To tackle these issues and alleviate the limitations of the existing SEMs in the context of PV systems, we design and fabricate SEM-LoRaWAN using the Arduino Uno microcontroller with a Cytron RFM LoRa shield and FOUR sensors to measure the considered parameters (voltage, current, light, temperature, and humidity). LoRa is exploited for communication with a LoRaWAN gateway. Users can track their energy consumption in real-time and expect their bills based on the accumulated energy using smartphones. The smart meter system will increase awareness among the consumers, and energy wastage will be reduced. Fig. 1 depicts the main

Table 1
Conventional energy meter vs. smart energy meter.

Criteria	Conventional Meter	Smart Meter
Display	Analog	Digital
Measure	Consumed energy per month.	Realtme energy consumption
Recording	Manually reading collection.	Remote data acquisition.
Communication	No communication capability	communication

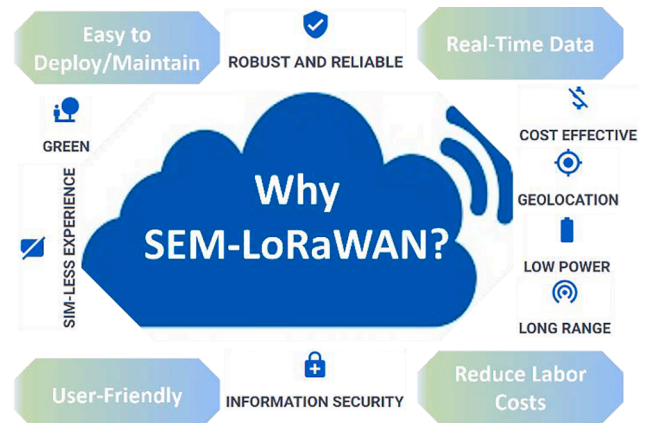

Fig. 1. Research motivations.

benefits and key features of our smart meter.

The key contribution of this study is fourfold:

- (i) We have designed and developed an IoT SEM based on LoRa/LoRaWAN technology for real-time tracking of DC energy consumption together with environmental conditions for the PV system.
- (ii) We have proposed a new algorithm for gathering data from multi-sensors LoRa Node and send it periodically as payloads of data packets to The Things Network (TTN) cloud over the LoRaWAN gateway.
- (iii) We have integrated the TTN to the AllThingsTalkMaker (ATTM) IoT web and mobile app dashboards to facilitate access to the monitored parameters by utilities/users on their devices (PCs/tablets/smartphones).
- (iv) We have implemented the developed SEM in a fabricated portable solar panel and carried out practical experiments to validate its functionality and effectiveness.

The rest of this paper is organized as follows. Section 2 reviews the background and related works. Section 3 introduces the design and modeling of the LoRaWAN-based SEM. Section 4 presents the system development and implementation. Section 5 explains the results and validation. Finally, Section 6 concludes the study by summarizing its main findings.

2. Related works

An energy meter or also known as electricity or electric meter is a device that measures the electricity consumed by a residence, business, or even a device, which is electrically powered. The conventional energy meter has been in widespread usage for several decades. This meter displays kilowatt-hour by continuously measuring the voltage and current to obtain the energy used in joules. Most of the traditional energy meters are used in AC systems, either single- or three-phase energy meters according to the number of AC wires are connected to the meter. Such meters are electromechanical-based analog devices that display the consumed energy using a copper or aluminum made rotating disk with a clock mechanism via a gear mechanism. By contrast, the modern energy meters are digitally operated, but they still have several limitations including the following: (i) manual reading processing, (ii) inaccurate measurements, (iii) not real-time (monthly electricity bill), (iv) lacks communication interface, and (v) electromechanical nature making it complicated.

Nowadays, where wireless-based system applications have become a trend owing to advanced technology, smart energy metering is in demand. An SEM is an electric device that is equipped with a chip or mode of operation to update data wirelessly to the server. The energy meter can usually be incorporated with the embedded controllers to transmit the data over the wireless network. In a smart grid, such SEMs are capable of handling the data exchange among various electronic equipment and can be involved in power generation and distribution. Therefore, many countries have started switching and deploying SEMs. SEM plays significant roles in the residential, industrial, and commercial sectors because these meters measure the consumed energy by the consumers. The industry of electric power continues to transition toward renewable energy by modernizing their grids to smart meters. This transition will enable electric suppliers to improve the energy grid's resilience and operations and help more gain real-time monitoring into the system operations and thereby avoid outages. Almost 60% of the 281 million electricity customers in the European Union had a smart meter at the end of 2021. Overall, the SEMs aim to decrease operational costs and increase the accessibility of consumers to their electricity bills in real-time with online payment support in addition to increasing awareness about energy consumption.

Huge efforts in the literature have been carried out to realize the

transformation from conventional energy meters to IoT-based SEMs that enable real-time monitoring of energy consumption at the end nodes. The data acquisition process via multiple sensors, utilization of micro-controllers with wireless interfaces, and development of algorithms for data processing and optimization are among the interest of previous studies. A few of these studies focused on energy meters for PV systems. (Bansal & Singh, 2016) conducted a review on smart metering in the smart grid network. They discussed and analyzed the smart grid and exposed the need for it. They concluded that the smart grid system is reliable, sustainable, and efficient to handle the rise of energy demand. Moreover, they stated that the smart grid is the primary source in the hierarchy of the smart industry. They also noted that smart meters are the direct components to contribute to smart city development. Smart meters are considered to have a high advantage as they are being used worldwide. They claimed that an energy metering system must be able to reduce the power consumption and billing and commercial energy consumption.

Han et al., (2014) developed a power line communication (PLC)-based PV system management for managing energy consumption in a Smart Home. The PLC is adopted to monitor each PV module. The system is divided into three components, namely, PLC modem, renewable energy gateway (REG), and smart device application. The PLC modems are placed on each PV module to monitor it. The REG stores the monitored data from the PLC modems and the inverter. The smart device application retrieves the stored data from the REG to inform consumers of the status of the PV system. However, the system is wire-based and does not support wireless communication and IoT concept. (Subhash & Rajagopal, 2014) conducted energy management, including the PV panel and the energy storage for a smart grid through a mobile application. The study proposed an analysis method of energy consumption with storage energy control. By using an Android application, they proposed an idea of giving the consumers a visual of their energy usage and to see their tariff. The proposed architecture of the system development for residence consists of a smart meter, smart plugs, a PV system, and a storage system based on batteries. Such a system is mainly developed for Android-based smartphones and has a limitation in the communication range as it depends on short-range wireless.

Rahman, Islam, and Salakin (2015) proposed an SEM for advanced metering and billing system using Arduino and GSM modules. They stated that the manual labor attempt causes many errors, and they want to rectify the energy meter by using IoT implemented with GSM and Arduino. They proposed a system whereby the energy meter communicates directly with the wireless network to have a more accurate meter reading. Moreover, they proposed a system consisting of a digital energy meter, Arduino as its controller, and a GSM modem with a relay, and the output is in the form of SMS. However, such a system needs a subscription to the GSM operator and monthly payment of SMS charges. (Ali, Saad, Razali, & Vitee, 2012) used an opt coupler sensor to automate an energy meter and track energy consumption. The concept is based on detecting the generated optical pulses of the LED that is attached to the energy meter. The microcontroller uses these pulses to determine energy consumption.

Adhya, Saha, Das, Jana, and Saha (2016) proposed an IoT-based smart solar PV remote monitoring and control unit. They discussed implementing a new cost-effective method for the performance evaluation of the IoT to monitor a solar PV plant remotely. This method includes preventive maintenance, fault detection, historical analysis of the plant, and real-time monitoring over IoT. The sensors' information is transmitted through a mobile radio network using a Global Packet for Radio Service (GPRS) module to the remote server. The automation and intellectual of solar power monitoring will enhance the future in this industry. In addition to the GPRS limitations in terms of the bandwidth and data rate, this study only focused on PV system condition monitoring rather than energy consumption monitoring. In addition, (Alahakoon & Yu, 2015) proposed algorithms for processing and analyzing the collected data from the smart meter. They also discussed the benefits of

implementing SEMs toward a smart city. Challenges and research directions related to energy meters and IoT also are explored focusing on analyzing data transmission reliability in wired and wireless energy meters' operation. (Asghar, Dán, Miorandi, Chlamtac, & Tutorials, 2017) also conducted another survey on smart meter data privacy. Different uses of metering data and the related privacy were reviewed based on three areas: billing, operations, and demand response. They concluded that the data control and privacy issue are a subset of the issues related to the smart meter. Moreover, communication technology varies based on the country and the population. The common communication technologies used in smart metering include PLC, ZigBee, Wi-Fi, and cellular networks, and the data are usually delivered in a hierarchy.

Gu, Zhang, and Chen (2014) used the current and voltage transformers to estimate energy consumption and suggest the usage of an integrated circuit (IC) for measuring the power factor and rate. A PLC with a radio frequency and a hybrid fiber-coaxial are utilized for the communication interface. (Prathik, et al., 2018) proposed an SEM for surveillance based on IoT to create awareness on energy consumption and energy savings. The system updates information on meter reading and power cut-off and also sends a notification alarm if the energy consumption exceeds the specified limit using the IoT. They claimed that this particular idea is implemented to reduce the human dependency on the data collection and billing process and minimize technical issues. An Arduino microcontroller with a GSM module was utilized. The system is composed of energy consumption daily, billing, and payment through the Internet. (Li, Hu, & Zhang, 2009) proposed an ARM-based energy meter with the management of power quality support. The proposed scheme is composed of hardware and software development and discussed security issues related to the utilized Wi-Fi communication module (Ahmed, Jabbar, Sadiq, & Patel, 2020). (Barman, Yadav, Kumar, & Gope, 2018) stated that the lack of full-duplex communication is among the limitations of the existing SEMs without IoT support. They proposed a cost-effective and compact energy meter where the data are uploaded into the "Thinks speak" IoT server whereby the consumer and utility can be monitored. The proposed energy meter is based on Wi-Fi supports both ways of communication.

In addition to the above-related studies in academia, some market-available SEM also exists. However, all are mainly developed for the conventional AC grid and are not suitable for stand-alone PV systems. Among them is a Narrowband IoT-based SEM by June (June Smart Energy Module, 2021). This SEM enables various features of LPWAN-based SEM including IoT support, LoRa, cloud-data storage, and analysis with GUI. Furthermore, the Narrowband IoT-based SEM can trigger notifications to the user if it is configured for a particular event. However, this SEM is based on NB-IoT, which is a licensed band frequency and requires a SIM card and subscription for each meter, making it a not cost-effective solution. Another commercially available solution is wireless energy metering smart outlet known as Smartenit's ZBMSKT1 ("Smartenit Wireless Energy Metering Smart Outlet ZBMSKT1", 2021). This outlet offers energy monitoring and remote home automation through a Smartenit application. Smartenit's ZBMSKT1 is based on ZigBee to transmit the data measurements of the connected appliances to the management system. However, the communication interface has many limitations in terms of range, data rate, and speed. Similarly, the smart meter plug for a wall socket by (Larsen, 2021) has the same limitations as it is Bluetooth-based and even provides several features including automation and control of the connected appliances. This smart meter also lacks IoT utilization for controlling over the Internet.

Overall, the aforementioned studies implemented various stand-alone SEMs to monitor energy consumption either locally or remotely. Some systems utilized IoT technologies to monitor the traditional AC grid, whereas a few others focused on PV systems. However, none of them utilized LPWAN technologies, in particular, LoRa/LoRaWAN to monitor energy consumption in real-time and update the collected data to the IoT cloud. Most of the systems in the reviewed papers are not cost-effective with complex architecture and high demand for operational

power: no user-friendly interface and no long-range data transmission with low power and low data rates. Moreover, the major drawback lies in the fact that they are AC-based energy meters. None of them was used to measure the DC energy produced by PV systems and utilized in DC-based appliances. The inference based on the above review is the real demand for SEMs that can be easily incorporated into the PV system for monitoring energy and stand-alone PV system surrounding conditions (temperature, humidity, light intensity). The motivations behind this study are to utilize low-power and wide-area wireless technologies, such as LoRa/LoRaWAN, to create awareness about energy consumption and energy conservation by consumers in a smart grid of multi-renewable energy sources. This case can be achieved by updating the energy consumption readings to the users in real-time through a Mobile App and Web-based dashboard. Table 2 summarizes some key features of the reviewed studies on SEMs and the proposed SEM-LoRaWAN. The novelty of our work comes from the consideration of multiple constraints at once. Thus, our system is portable, compactable, with multiple sensors, solar-powered, with long-range communication technology. In addition to the real implementation and validation with LAB instruments. Our research scope in this study focuses on fabrication and functionality testing with validation of the proposed smart energy meter. The term "SMART" comes for the enabling of IoT system connectivity to the Internet. The system is able to gather all the electrical parameters of the PV system in addition to some surrounding conditions and update the IoT servers in real-time. Comparing to the existing energy meter, our system is cost-effective with a user-friendly interface. It supports the DC energy monitoring of DC loads that are directly fed from the stand-alone PV system. Our system supports the reporting of energy consumption and expected bill estimation based on a fixed tariff. The reported information can be accessed by the consumers and utilities as well via both the web-based dashboard and mobile-based applications simultaneously at anytime anywhere. For readability and the clarity of presentation, we also define the useful terms and notations used in this study in Table 3.

3. Design and modeling of SEM-LoRaWAN

3.1. Methods and materials

Several campaigns were conducted to accomplish this research as shown in Fig. 2. Initially, limitations of the existing systems were recognized through an extensive literature review related to SEM in general. Followed by a review on SEMs that combines the concept of IoT with PV systems, the material selection phase was conducted to survey the available components (hardware and software). This phase was also to compare their features and suitability to be used for the proposed smart meter. Next, the modeling phase is started and divided into two sub-phases, namely, the testing of sensors with microcontroller and LoRa individually and the design of the SEM. Then, hardware installation and software implementation were performed to satisfy the proposed objectives. After that, the design enhancement and optimization phase was performed through several tests to achieve the expected outcomes. If the testing is failed because of some errors related to connection or coding, this phase was repeated until the successful implementation. Finally, the fabrication and implementation of the developed smart meter in a portable solar panel were carried out for the testing functionalities before performance analysis.

The proposed SEM consists of several hardware and software components. This section briefly describes the utilized components to build our system. Therefore, the hardware components for the smart meter include Arduino Uno R3, SX1278-LoRa shield, ACS712 current sensors, voltage sensor B25, LDR sensor, DHT11 temperature and humidity sensor, and SX1301 LoRaWAN gateway. The components of the portable PV system include a 50-Watt Polycrystalline DC solar panel, battery, and charge controller. The software components comprise Fritzing software, Proteus software, Arduino Integrated Development Environment (IDE), TTN platform, and ATTM dashboard.

Table 2
Summary of related studies

Ref.	PV Support	PV Conditions	DC Support	IoT-Enabled	Micro-controller	Communication Interface	Local Readings	Remote Readings	Support Tariff	IoT Cloud
Han, et al. (2014)	✓	×	×	×	PLC modem	Wired	×	×	×	×
Subhash and Rajagopal (2014)	✓	×	×	×	PC	Bluetooth	✓	✓	✓	×
Rahman, et al. (2015)	×	×	×	×	Arduino	GSM Module	×	✓	×	×
Ali, et al. (2012)	×	×	×	×	PIC16F887A	RF Module	×	✓	×	×
Adhya, et al. (2016)	✓	×	×	✓	PIC18F46K22	GPRS	×	✓	×	×
Gu, et al. (2014)	×	×	×	×	PLC modem	RF Module	✓	×	×	×
Prathik, et al. (2018)	×	×	×	×	Arduino	GSM Module	×	✓	✓	×
Li, et al. (2009)	×	×	×	×	ARM	Wi-Fi	✓	×	×	×
Barman, et al. (2018)	×	×	×	✓	Arduino	Wi-Fi	×	✓	×	✓
“June Smart Energy Module” (2021)	×	×	×	✓	N/A	NB-IoT	✓	✓	×	✓
Smart Outlet ZBMSKT1 (2021)	×	×	×	×	N/A	ZigBee	✓	×	×	×
SEM-LoRaWAN (This study)	✓	✓	✓	✓	Arduino	LoRa/LoRaWAN	✓	✓	✓	✓

Table 3
Summary of notations and terminology.

Term/ Symbol	Description	Term/ Symbol	Description
SEM	Smart Energy Meter & Internet of Things	PV	Photovoltaic
IoT	Internet of Things	LoRa	Long Range
GUI	Graphical User Interface	LoRaWAN	Long Range Wide Area Network
AC	Alternate Current	DC	Direct Current
TTN	The Things Network	GSM	Global System for Mobile Communications
LPWAN	Low Power Wide Area Networks	MAC	Media Access Control
ATTM	AllThingsTalkMaker	LDR	Light Dependent Resistor
DHT	Digital Temperature and Humidity	USB	Universal Serial Bus
ISM	Industrial, Scientific and Medical	IP	Internet Protocol
PCB	Printable Circuit Boards	IDE	Integrated Development Environment
ABCL	AllThingsTalk Binary Conversion Language	LCD	Liquid Crystal Display
LED	Light Emitting Diode	GND	Ground
DDM	Digital Multi Meter	API	Application Programming Interface
REG	Renewable Energy Gateway	PLC	Power Line Communication
SMS	Short Message Service	GPRS	Global Packet for Radio Services

The Arduino Uno R3 microcontroller is used as the smart node energy meter and attached with the LoRa shield module as a transceiver. Arduino is an open-source platform for prototyping based on flexible, easy-to-use hardware, and software. Among the main reasons for Arduino’s popularity is the ecosystem of companies and individuals that contribute to the project. The Arduino Uno board is based on the ATmega328. This board contains everything needed for our smart meter, such as several input/output pins (analog/digital) that allow connecting multiple sensors to the same node. The Arduino Uno board is also simply connected to a computer with a USB cable and powered on via 5 V DC voltage from an adapter or battery to get started.

The RFM Cytron LoRa is a long-range module that offers ultra-long-range spread spectrum communication and high interference immunity

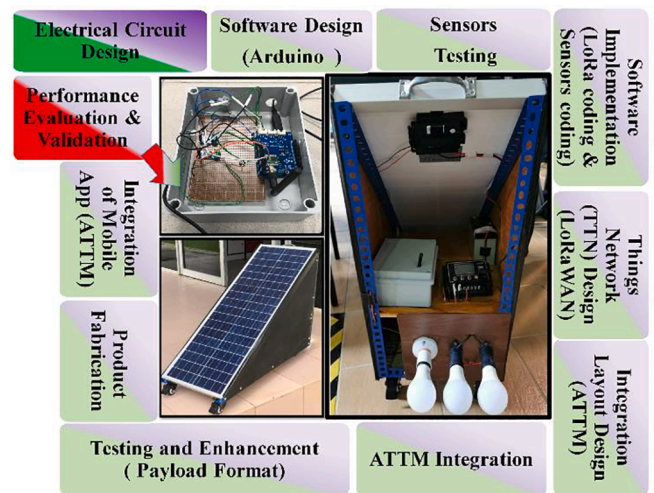

Fig. 2. Adopted methodology for system development.

while minimizing energy consumption. LoRa provides significant gains in selectivity and blocking compared with conventional modulation techniques, solving the traditional design by tradeoff among coverage, robustness to interference, and energy efficiency. The exploited LoRa shield is simply attached to the Arduino to form a smart node to gather data from multiple sensors and send it to the LoRaWAN gateway. Hence, the Dragino LoRaWAN gateway is used in our system to collect the data from the network of smart meters deployed in different PV systems. This gateway is a digital baseband chip having a massive digital signal with a processing engine specifically designed to offer a breakthrough gateway in the ISM bands worldwide. The Dragino LoRaWAN gateway integrates the LoRa concentrator IP. Dragino LPS8 is suitable for indoor LoRaWAN macro gateways. The amount of data handled and the density of data exchange traffic can affect the performance of the gateway and the energy consumption used (Rizal & Ilham, 2018).

Four sensors are used to build the multi-sensing capabilities of our meter. The ACS712 sensor provides economical and precise solutions for AC/DC sensing in industrial, commercial, and communications systems that functioned to sense the current flow into electrical appliances. The

ACS712 has three types for the ampere range, that is, 5, 20, and 30 A. In this study, the ACS712 20 A current sensor is used because of its appropriate range making it an idealistic sensor. The B25 sensor is a proper sensor to incorporate with the Arduino. The sensor is made up of two resistors in a voltage divider form and then packet to resemble a sensor chip to make it last longer and not easily movable compared with the normal resistors wired directly on the breadboard. The B25 comprises 7.5 and 30 k Ω with a divider value of 1:5, making it a more precise sensor. The maximum voltage of the controller is 5 V. Furthermore, the sensor has screw terminals that ensure a secure connection. To measure the surrounding temperature and humidity at the PV system, a DHT11 sensor is used. This sensor can measure the temperature and relative humidity simultaneously. The DHT11 is used because it is more accurate than other sensors and easy to implement. The DHT11 output voltage is supposedly proportional to Celsius temperature and humidity as a percentage. LDR is also known as a photoresistor, which is used to convert light energy (photons) whether visible or infrared light into an electrical (electrons) signal. The LDR is used here to determine the light intensity on the solar panel, thus can be used for further control.

Software tools selection depends on the phase of system development. In the beginning, the Fritzing open-source tool is used for a design campaign to concoct the components in a circuit before constructing them on a real breadboard. The program displays a collection of pre-loaded circuit boards from various companies, and users can use the given libraries of the boards and plan out the project accurately. The reason is that the boards in Fritzing made the full scale of the physical board. This tool is often used to create circuits in a schematic view or the Printable Circuit Boards (PCB) view. Proteus Design is also exploited to simulate the designed circuit before the hardware installation and is a Windows-based application for design the electronic circuit. Proteus Design has schematic capture with the PCB layout design, making it easy to design the prototype and ensure it is working. Stimulation can also be done to test Arduino coding by inserting the coding to the virtual Arduino used in Proteus. The Proteus is a combination of SPICE, circuit simulation, and microprocessor models to accelerate co-simulations of a complete microcontroller-based design. The most involved software is Arduino IDE, which is an open-source platform for coding development based on Java and C compilers. This software allows the user to write a program in a conducive text editor and compile them into the machine code. Then, the Arduino board is connected to the computer by using a USB, where it connects to the Arduino development environment. This software was utilized since the early stage of system development to testing system components either separately or as one node.

After we accomplished the circuit design and hardware implementation in the Physical Layer, another phase of software development is started in the Application Layer. This phase is carried out using two different IoT cloud servers. The first is TTN, which is a non-proprietary infrastructure platform providing a free LoRaWAN platform network coverage. TTN is developed by growing communities globally based on voluntary contributed projects. Moreover, TTN has reliable end-end encryption and a safe and collective IoT network that is built and span across the board globally. Several steps are involved during TTN configuration including the LoRaWAN gateway and definition of related parameters in our TTN console and followed by the defining application and sensor nodes to send the data to the console. After that, multiple configuration steps were conducted to receive data payloads and display them on the TTN dashboard or forward it to the ATTM platform, which is integrated with TTN. TTN is used to rapidly connect to things and collect, visualize, and use the data instantly. The ATTM supports the user's custom binary data format, which the users can decode using the AllThingsTalk Binary Conversion Language (ABCL) payload decoder, and free prototyping software.

3.2. System model

Fig. 3 presents the overall system architecture of the developed SEM-

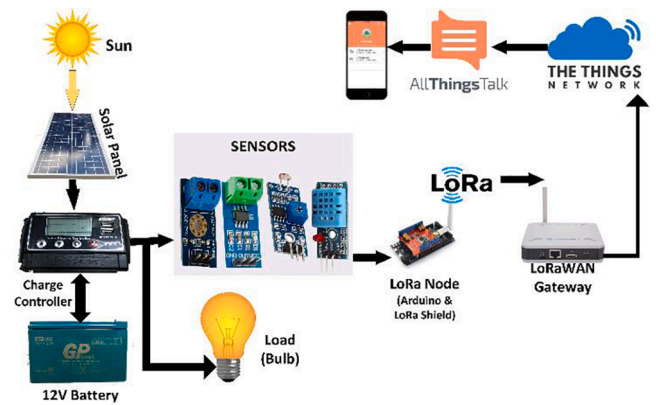

Fig. 3. System architecture of the smart energy meter.

LoRaWAN. The system's architecture consists of the SEM and the portable solar panel as the renewable energy source. A 50-watt polycrystalline solar panel represents the PV system, which is one of the most popular choices for grid-connected/off-grid solar power systems. The polycrystalline solar panel costs less and is resistant to heat and is widely available. When light shines on a PV cell, the light may be reflected, absorbed, or passed right through owing to the materials of the cells. Thus, the absorbed light generates electricity, which is mostly known as solar power. The produced energy is used to supply loads and charge the battery using a charge controller. Sensors measure various stimuli (voltage, current, light, temperature, and humidity), and the Arduino attached with LoRa collects data from sensors and transmits it to the LoRaWAN gateway, which in turn uploads the data to the TTN server. TTN is the platform used to integrate the data payloads to the AllThingsTalkMaker.io. The TTN is used as it is the only MAC protocol that supports LoRa and LoRaWAN networks. Through the ATTM mobile dashboard, the users can easily monitor the energy consumption and the considered parameters. The utilities/residences can observe the recorded data shown on the energy meter layout on the ATTM server cloud either using mobile apps or Web-based apps using smartphones/tablets/PCs

3.3. System design

The design is one of the key phases in any project before it can be fabricated to ensure that the product can be produced successfully. Twofold parallel design stages are performed, the first for the PV system and the second for the SEM. Hence, a few criteria are considered in our design procedure. For the PV system, we design a fixed stand that has an angle of 35° because of a suitable angle for Malaysia irradiation sunlight rays. The orientation and tilt angle of solar panel frame collectors play an important role in minimizing shading and consequently in increasing solar collector's efficiency. The amount of solar energy collected by a solar panel is a function of local solar radiation, ground reflection property, and collecting a panel's tilt and orientation. The orientation and the tilt of a solar panel strongly affect the amount of the collected yield. Therefore, solar panels must be slanted and oriented at optimum angles to collect the maximum solar energy available in a specific region.

The major step in designing any physical object is the selection of the materials, which should be appropriate materials that will lead to success. The slotted angle bar is the most suitable material to be used as a frame of the solar panel. The slotted angle shelving systems are exceptionally efficient and economical for commercial, light-duty storage of products and materials that have a high flow rate, which eases the process of building the prototype. The solar panel stand has a fixed angle because the best angle to install the solar panel and obtain a better light intensity from the sunlight is approximately 30 to 40° slope. At the same

time, we also plan to assemble the wall at both sides of the solar panel stand by using a piece of plywood and tighten it by bolt and nut. In addition, the design of the solar panel is provided by four rollers to make it easy to move and find a suitable angle for light intensity.

The second design focuses on the smart meter circuit. The circuit design was done using Fritzing sketching, which is software that helps to visualize the overall circuit system and design of the SEM. The general circuit design was sketched using Fritzing software to visualize the circuit connections among the Arduino Uno R3, ACH712, DHT11, B25, with the solar panel, charge controller, and the battery. For the aim of sketch clarity, the battery and voltage charger were omitted in the Fritzing circuit design of the SEM, as shown in Fig. 4.

After Fritzing was completed, a Proteus simulation was conducted to simulate the circuit to obtain the simulation results. Proteus runs and shows us the simulation results when incorporated with the Arduino coding as depicted in Fig. 5. The current sensor ACS712 20A and the voltage sensor were first combined to make the circuit design without including the liquid crystal (LCD). A voltage divider with two resistors of 30 and 7.5 Ω k is used to replace voltage sensor B25, which is not available in Proteus. DHT11 and LDR are also represented in the simulated circuit.

4. System development and implementation

4.1. PV system fabrication

The fabrication process focuses on portable PV system development. In this section, we explain the manufacturing process of a solar panel stand. The fabrication concept always involved the process of assembly and started with shop drawings, including precise measurements of the product that we want until the finishing of the manufacturing process of the product. The components that we used during the fabrication process include a slotted angle bar, thin and thick plywood, rollers, holder, screw, bolt, and nut. These components were used throughout the manufacturing phase processes, such as cutting, grinding, and assembling to combine it being a complete solar panel stand as designed in the previous phase. However, the solar panel stand was improved from the original design based on the requirement in this project. The cutting process of the slotted angle bar was performed by using a cutter machine in the workshop. All dimensions of cutting were followed based on the specification of the solar panel, which has 1010 mm length, 350 mm width, and 25 mm height. An accurate dimension is important to ensure that the solar panel has high stability and is strong enough to withstand the solar panel module. The cutting process of plywood also has been done by using a handsaw, and this plywood is acted as a base and wall to the solar panel stand. Using plywood has several advantages, such as

high stability, high impact resistance, high strength to weight ratio, and chemical resistance. In addition, in the grinding process, a grinder machine is used, and in the cutting process, the excess slotted angle steel is cut and trimmed to ensure that the work will be cleaner with a precise dimension. Fig. 6 shows a part of the fabrication process at the faculty workshops.

Then, the assembling process was conducted using a screw, bolt, and nut, which hold all parts of the solar panel stand including its legs and angle. Every part had to be secured by a screw to ensure the strength and durability of the stand. Four rotating wheels with locks on each wheel were used in the solar panel stand prototype to allow it to move easily. The rotating wheels are installed in the four corners below the prototype. Whenever the solar panel is placed at a certain place that received suitable and optimum sunlight, the user must lock the wheels of the solar panel to prevent it from moving. The wheels could be unlocked or locked based on the user's preference.

For the next step, the base and wall were assembled by using plywood. The thick plywood was screwed as a base and thin plywood as a wall at both sides of the solar panel. The partition or upper layer also provided increased space for component storage. The base and second layers are slightly thicker than the wall of the solar panel to ensure safety and consideration of the weight of electronic components, such as battery, charge controller, and junction box. In addition, by using plywood that is an insulator electric, an electrical component is secured and does not affect the system or structure of solar panel if circuit shortage occurs. Then, the installation of the PV system was conducted by connecting the solar panel to the charge controller and the battery. The DC bulbs were wired to the charge controller as a DC load. Finally, the PV system was placed in an open space to test solar panel output capability to supply the load and charge the battery. The energy efficiency of the battery and the solar panel was also evaluated.

4.2. SEM-LoRaWAN implementation

This campaign focuses on hardware installation and software implementation. This section explains in detail SEM implementation including its electronic circuit and software development. As stated earlier, several components were used in the development of the SEM-LoRaWAN. The LoRa node and LoRaWAN gateway are connected in this phase for testing. A breadboard is used first to build the meter circuit from the selected components: Arduino Uno, LoRa, 12 V battery, sensors, resistors, potentiometer, LCD, LED, bulbs, and jumper wires. In addition, we used Arduino IDE software to write code and upload it to the board. First, the wiring installation between different components was performed on a breadboard according to the finalized Fritzing design and Proteus simulation. The sensors are connected to predefined

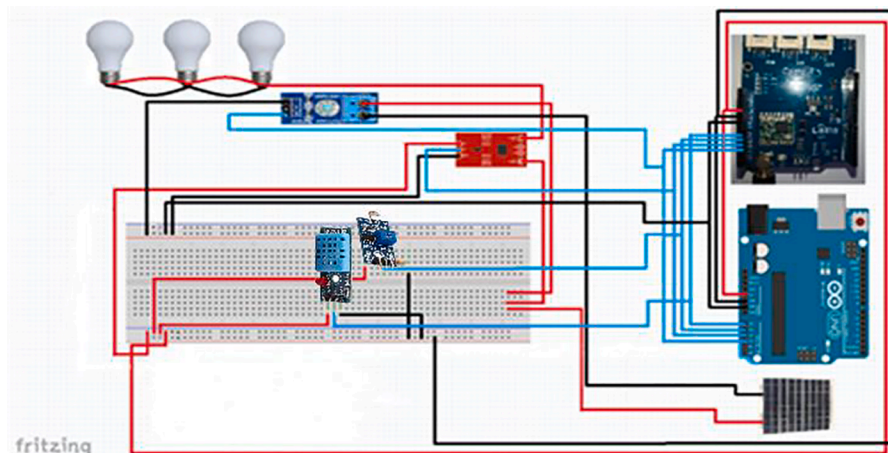

Fig. 4. System circuit diagram using Fritzing.

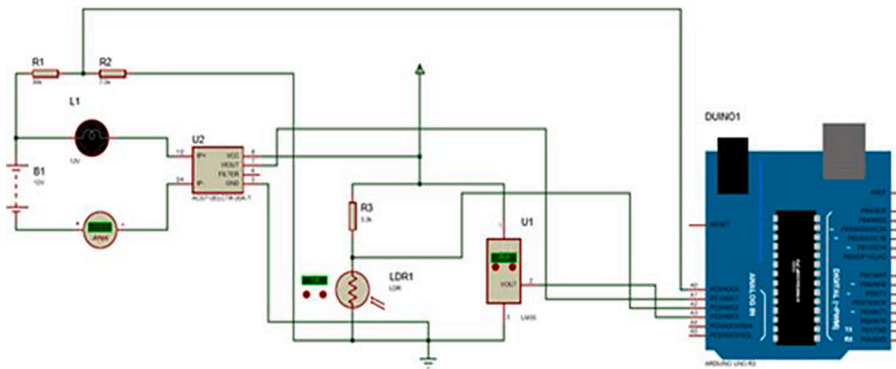

Fig. 5. Circuit simulation using Proteus.



Fig. 6. PV system fabrication.

pins of Arduino, and LoRa sends the collected data to the Internet over the gateway. A 12-V battery has been used as a source for the electrical connection during initial testing. Sensors were tested individually with the LoRa node first using the Arduino serial monitor; then, all sensors are combined as a multi-sensor smart node. For the sensors, the main sensors to calculate energy are the voltage and current sensors. The voltage sensor has quite an influence on the whole circuit to bring the desired system output, and the current sensor senses the load current reading to calculate the power. Based on load instantaneous power and time, the energy of the PV system can be calculated according to the basic formula of energy which is $E = P \times t$. The temperature sensor DHT11 detects the changes of the surrounding temperature particularly the temperature around the solar panel and the air relative humidity. The LDR sensor acts as a resistance to the circuit and can detect the light intensity from the sunlight toward the solar panel.

The controller and sensor testing phase was performed by integrating sensors with the Arduino. The B25 voltage sensor was first tested on the breadboard with an LED bulb 6-W DC load and a DC power supply. The sensor signal terminal is connected to the Arduino analog input pin, whereas the Vcc and GND pins of the sensor are connected to the load in parallel. In this test, the DC power supply acts as a solar panel. Then, the coding was sketched in the IDE and was uploaded to the Arduino, and the results were displayed on the serial monitor. The sensor works properly for varying voltage ranges from 9 to 24 V. Similarly, the ACS712 20A current sensor also is tested separately by connecting the sensor in series with a 6-W DC motor load. As usual, the coding was

sketched into IDE, and the output of the current sensor was viewed using the serial monitor. Then, the load was changed to a 6-W DC bulb, and the sensor can maintain accurate current readings. Furthermore, the obtained voltage and current values from the implemented sensors are validated using a digital multimeter (DMM), which shows an agreement with the obtained readings in the serial print. Therefore, both of the sensors were then combined and tested with the load. The connection remained the same using the DC LED bulb in series with ACS712 and parallel with the B25. The coding was then uploaded into the Arduino, and the output was viewed using the serial monitor.

Next, the LDR sensor was tested by making a series connection using a 3.3-k Ω resistor and the analog input pin of Arduino. The sensor was tested by flashing a light on the LDR to see the changes in the value, which was monitored in the serial monitor. The LDR sensor was then placed in an electroplate. Once the solar panel was placed in an open space, the photo-resistor was moved from left to right while the reading was observed in the serial monitor of the IDE. Then, this process is followed by the temperature reading of the solar panel. The temperature, which is one of the important parameters of a solar panel, was measured using the DHT11 by taping its base on the solar panel. The same sensor also is used to measure the humidity level, which has a direct impact on the communication between the LoRa node and the gateway. The sensor pins were then soldered and connected to the Arduino through the analog input. The DC power supply was only used for convenience testing and was later replaced by the PV system. The result was monitored in the Arduino serial monitor and comparison of results for various

panel conditions.

After completing the individual testing of all sensors, the sensors are combined in a multi-sensor node. In the beginning, even after compiling sensors together, the DC power supply is used because of its flexibility to supply varying voltages. This process was done to ensure if the code is compiled properly and the values obtained are accurate. Once this testing part is completed, the power supply was then changed to the fabricated PV system with an LED bulb load. The values were then compiled to be displayed in the LCD for local monitoring. All these testing were conducted locally using the Arduino and sensors without any wireless interface. Fig. 7 shows a part of hardware and software testing of the developed system.

Next, the LoRa is attached to the microcontroller as shown in Fig. 8, and its required coding was integrated into the Arduino sketch. Thus, the related coding of the sensors was altered to enable data forwarding over the LoRa transceiver to the gateway and then uploaded to TTN/ATTM IoT platforms. The Cytron RFM LoRa node was first registered to the TTN to set up the pathway of sending data into the cloud. The node was registered in the TTN console under the term “applications.” The node is registered with a unique application ID, the description of the device, application EUI, and handler registration. The application ID has to be a unique identifier to identify the LoRa node. The description is a short version to explain the function of the device. The application EUI will be generated automatically by TTN, and the handler reception is given based on the region that the device is located. Once the device is added to TTN, the device will generate an application overview of the particular device. Fig. 9 shows the procedure of registering a LoRa node and an overview of the LoRa device. Using this information in TTN, a LoRa coding is sketched in Arduino IDE to send the sensors data from the LoRa node to the IoT Platform. The Network key, Application key, and device ID must be changed in the format of hex-digit payload to the specific LoRa node key, which is obtained in TTN. This coding ensures that information passes from the device to TTN securely.

The headings of the TTN and all the sensors were then incorporated into the Arduino sketch using specific libraries of sensors. The declaration of the analog input for each sensor was done, followed by the pin mapping of the LoRa node, including sensor libraries into the Arduino sketch. The voltage sensor does not have its library; thus, we have developed the required coding to extract the voltage readings based on the voltage divider used. For power and energy, the values were obtained from two different sensors; thus, the values were called to estimate the power of load and then calculate the energy according to operation interval. For the sake of simplicity, we assume that our load is

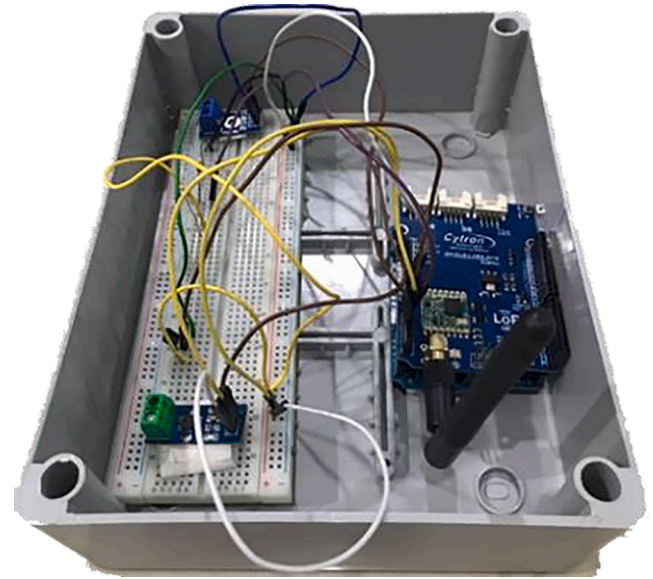

Fig. 8. System testing box on breadboard.

fixed all the time. After the calculations are completed and the values of the sensors were called using, the values are then sent in a packet of payload format with a preset delay interval between send tasks. The values of the packet sent were also monitored in the serial monitor to ensure that the correct value is transferred into TTN. The coding is compiled and finalized and then uploaded into the microcontroller, and data are sent continuously to TTN. The data will be displayed instantaneously on the TTN application data as encoded bits that are not readable. We have developed our payloads decoder according to the encoding process developed at the sensor node using the Arduino IDE. Thus, the uplink data received by TTN can be traced easily and are suitable for identifying various measurements of the developed meter.

For the sake of developing a user-friendly interface, we have integrated TTN to ATTM Web-based dashboard and the ATTM mobile app. As shown in Fig. 10, the ATTM is first integrated with TTN to ensure the data sent by the LoRa node to TTN are also received by the ATTM. The ATTM is used for this project because of its easy and convenient configuration. To integrate TTN and ATTM, only a unique process ID is required, whereas the access key is a default key generated by TTN. The webserver of ATTM is then registered with a username and password. In



Fig. 7. Hardware and software implementation and testing.

ADD APPLICATION

Application ID
The unique identifier of your application on the network

Description
A human readable description of your new app
Eg. My sensor network application

Application EUI
An application EUI will be issued for The Things Network block for convenience, you can add your own in the application settings page.
EUI Issued by The Things Network

Handler registration
Select the handler you want to register this application to
ttn-handler-asia-se

REGISTER DEVICE bulk import devices

Device ID
This is the unique identifier for the device in this app. The device ID will be immutable.

Device EUI
The device EUI is the unique identifier for this device on the network. You can change the EUI later.
0 bytes

App Key
The App Key will be used to secure the communication between you device and the network.
this field will be generated

App EUI
70 B3 D5 7E D0 02 33 D9

Fig. 9. Application and device registration in The Things Network.

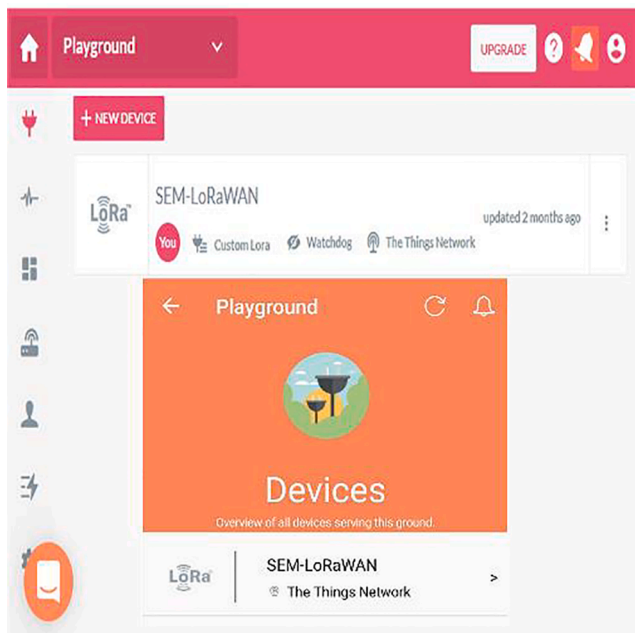

Fig. 10. AllThingsTalkMaker integration with TTN.

the ATTM web server, the device is incorporated by using the custom LoRa option and connected with the LoRaWAN provider, which is the TTN. Then, the device name, device EUI, and the application ID from the TTN are used to activate the device in ATTM. After creating the device,

the assets were created. Assets are the values of the sensors, which are displayed in the ATTM and the mobile app for the users to view. An asset is created by naming the sensor and displaying the value in a numerical format. The GUI is a layout to display the various readings on the ATTM. Fig. 10 shows the device connected to the ATTM webserver

4.3. System enhancement and optimization

To optimize the design and deployment of the developed system, the enhancement and optimization phase was conducted. This phase is important to improve the prototype system performance by detecting the errors obtained during the testing phase. In this phase, the problems in the previous phases were identified and resolved. Corrections were repeated until a successful implementation was achieved. For example, in the previous phase, the reading of the current is at the lower range of approximately 0 to 0.5 A. Therefore, to increase the value of current, the number of LED bulbs was increased to three bulbs; thus, the value of the current increased to 1.5 A after the improvement. In addition, the connection of the solar panel with the bulb was changed from a series circuit to a parallel circuit to ensure that we got correct and reasonable data.

Another optimization task was performed in terms of coding and formulation to obtain the reading from various sensors. These readings are compared with the practical measurements using the DMM. When the results from the system and the real measurements are not identical, we keep modifying the sensor libraries until we got accurate results, similar to the real measurements of all sensors. These values then are sent to TTN, compared with the local readings using the Arduino serial monitor to confirm its accuracy and correctness. This procedure was applied to all sensors individually and as a multi-sensor node. Once the

voltage and current readings were accurate, the power and energy calculations and measurements were also checked and compared. This phase was applied and repeated until we confirmed that all sensor readings and calculations are accurate and transmitted correctly to the IoT cloud. The finalization of the developed SEM is carried out by moving the components from the breadboard to be soldered on the donut board. The B25 and ACS712 sensors are fixed on the board and connected to the microcontroller. The LDR and the DHT11 have to be used outside; thus, the wires were also extended. The wires were tested with the DMM to ensure continuity and no short circuit exists between each pin. Clear wire connectors are also used to connect the wires of sensors, such as ACS712 and B25, with the solar panel wires. After we had finished the soldering process, the whole system was tested once again to ensure that all the circuit connections, sensors, and charge controller connections are properly installed. Fig. 11 shows the soldered components on the donut board. The outcomes of the testing phase are displayed in the TTN as shown in Fig. 12. For the last stage, the result from the TTN network is integrated with ATTM that was chosen by this project based on their API mobile apps, which also works very well with LoRa devices. Moreover, data from Arduino can be transferred to the TTN and then to the ATTM dashboards. The details of the designed parts and their features are listed in TABLE IV in the Appendix.

4.4. System operational procedure

In this section, the operational procedure of the developed SEM is described. The prototype of the SEM with the fabricated PV system has been implemented. The soldered electronic components of the smart meter are placed in an electrical box and placed inside the PV system. Fig. 13 shows the portable PV system prototype along with the implemented SEM. Algorithm 1 illustrates the sequential steps to monitor the considered parameters of the PV system using SEM-LoRaWAN. The algorithm is developed and implemented in Arduino IDE to gather data from multiple sensors simultaneously and encoding to be sent as a Payload of 14 bytes, with 2 bytes each value. The developed algorithm also defines the required configuration parameters of the LoRa node and the required setup to establish a connection between the LoRa node and the LoRaWAN gateway. The gateway is switched on and connected to the Internet. The portable solar panel is placed outdoor to face sun rays. The loads are switching ON to draw current from the PV system. The PV battery is used to power the LoRa node. Sensors collect data regarding

voltage, current, temperature, humidity, and light intensity

Algorithm 1. Smart energy meter algorithm

Require: Monitor PV System energy and related-conditions
Ensure Real-time monitoring (voltage, current, power, energy, tariff, light, temperature, and humidity)
 1: **Install** LoRaWAN Gateway & connect to the Internet
 2: **Register** the Gateway in the TTN Console (GW ID, Frequency Plan, router, GW key)
 3: **Create** SEM-LoRaWAN Application in the TTN Console (App. ID, App. EUI, TTN-Handler)
 4: **Register** LoRa Node under SEM-LoRaWAN Application (Dev. IDDev. EUI, App Key, App EUI)
 5: **Define** Device Activation Method (ABP)
 6: **Get** Network Session Key & App Session Key & Device Address
 7: **Define** Libraries for multi-sensor smart LoRa node & TTN
 8: **Define** LoRa-Node pin mapping → For sensors & LoRa connection
 9: **Set** LoRa configuration parameters
 10: $V \leftarrow$ Voltage value → B25 sensor
 11: $I \leftarrow$ Current value → ACS712 Sensor
 12: $P \leftarrow$ Power value → $P = V \times I$
 13: $E \leftarrow$ Energy value → $E = P \times t$
 14: $T \leftarrow$ Temperature value → DHT11 sensor
 15: $H \leftarrow$ Humidity value → DHT11 sensor
 16: $L \leftarrow$ Light intensity value → LDR sensor
 17: Initialize PV System and SEM-LoRaWAN → System ON at $t = 0$
 18: **for** each round **do**
 19: Get V, I, T, L
 20: **Estimate** P, E
 21: **Multiply** each reading by 100 → Represent each sensor by 2 words
 22: **Split** both words (16 bits) into 2 bytes of 8 bits
 23: **Encode** all bytes into ONE Payload of 14 bytes
 24: **Establish** a connection between LoRa Node & LoRaWAN GW
 25: **Update** status of the node in TTN Server (online)
 26: **Send** data to LoRaWAN GW
 27: **Upload** data to TTN Server over the Internet
 28: **Decode** the received Payloads to retrieve original sensors readings
 29: **Integrate** data into ATTM Web-based dashboard
 30: **Synchronize** data with ATTM mobile App. using Smartphone
 31: **end for**
 32: User monitors all sensors data in realtime using their devices
 33: **END**

The system starts working by checking the detection of the load current through the current sensor and the voltage value from the voltage sensor. The measured readings might fluctuate because of light intensity. Once the LoRa node has established a connection with the gateway, the values will be sent in packets as a stream of bytes periodically to the TTN where it is displayed after being decoded to hexadecimal representations. TTN will then integrate these readings into the ATTM platform, and results will be displayed on mobile/tablet/laptop through the ATTM dashboard. The user must access the Internet using their devices to monitor the SEM in real-time. In the ATTM, a payload decoder is proposed to display the received data from the system in a human-readable form by splitting the received payload based on bytes numbering during the encoding process at the LoRa node. In addition to voltage, current, power, and energy, the electricity bill also can be estimated based on a predefined tariff.

5. Results and validation

In the measurement campaign, system functionality is tested, and system performance is validated. The tests are repeated many times in different weather conditions that may affect the solar panel output voltage, thereby producing changes in the measured energy. The system portability helps us to move the PV system and perform experiments under various conditions. In this section, we present the test bench in terms of overall system functionality and sensor operation of all parameters related to electricity and PV surrounding conditions. The experiments have been performed in a real environment. The spreading factor (SF) of the LoRa node was set $SF = 12$ to meet the scenario with the longest coverage. SF decides on how many chirps, the carrier of the

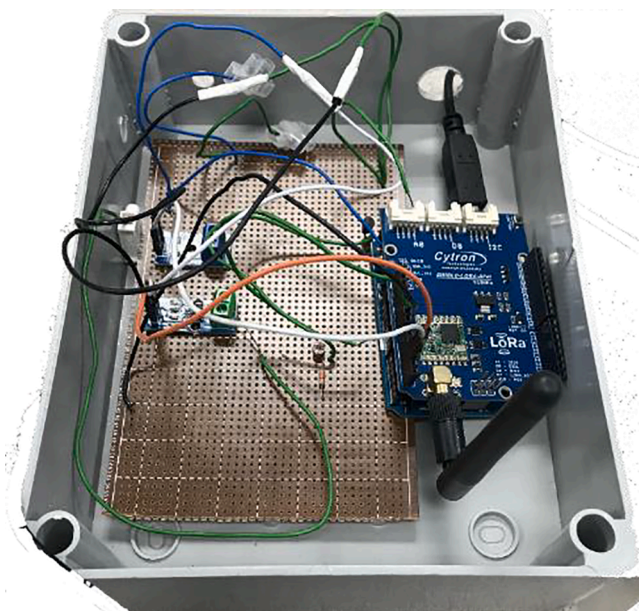

Fig. 11. LoRa node connections on donut board.

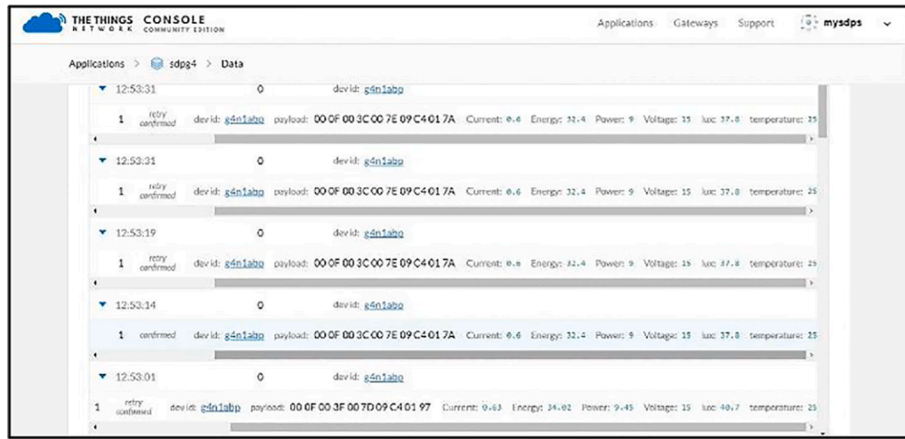

Fig. 12. The displayed output in TTN.



Fig. 13. Prototype of smart energy meter for the photovoltaic system.

data, are sent per second. Usually, SF is selected from SF7 to SF12 depending on the environmental conditions between the LoRa node and LoRaWAN gateway. The Adaptive Data Rate (ADR) functionality is switched off because it is recommended for mobile devices while the PV system is stationary. A lower SF allows more chirps to be sent per second; thus, more data can be encoded per second. Moreover, higher SF needs longer airtime and more energy to send the data to the gateway. Several tests were carried out, where the LoRaWAN gateway is placed in the office area of our faculty. Moreover, the SEM-LoRaWAN with the PV system is located in different areas inside the university campus within a diameter of 2 km from the gateway. In this study, we focus more on the successful implementation of our smart meter to provide accurate readings uploaded to the TTN and ATTM in real-time.

The results of a selected scenario are reported in this study, where the gateway is placed indoors “inside the office,” whereas the PV system with the smart meter is placed outdoor within a 500-m distance. The obtained results are averaged every 10 min for 12 h (17:30 to 5:30) of continuous operation of the system in the TTN and the ATTM dashboards (Web-based and Mobile apps.). Several metrics were considered, namely, voltage, current, power, energy, temperature, humidity, light intensity, SNR, and RSSI. TTN is a LoRaWAN network for the IoT, which

offers data connectivity, so users can create their applications on top of it. In our study, the SEM sends LoRa data through TTN to AllThingsTalk. Fig. 14 shows the instantaneous data of the considered parameters in the main dashboard of TTN in our console. The figure also shows various configuration parameters at the gateway traffic and payload stream of the LoRa node. The TTN dashboard displays the time, counter, port, and payload packet with hex digits representing each value. During the initial testing phase, we have added our decoder in the payload format of TTN to show readable values of sensors. These values are obtained after integrating a decoder to interpret the received data and convert it from hexadecimal to decimal value with a definition from which the sensor is received. However, this decoder was removed after the integration with the ATTM, and the values in the TTN are displayed again in the

time	frequency	mod.	CR	data rate	airtime(ms)	cat
01:06:07	921.2	loro	4/5	SF 10 BW 125	288.8	38012 dev sdr: 26 04 11 E3 payload size: 12 bytes
01:06:07	921.2	loro	4/5	SF 12 BW 125	1646.6	660 dev sdr: 26 04 11 E3 payload size: 27 bytes
01:06:03	923.2	loro	4/5	SF 10 BW 125	288.8	38011 dev sdr: 26 04 11 E3 payload size: 12 bytes
01:06:02	921	loro	4/5	SF 12 BW 125	1646.6	660 dev sdr: 26 04 11 E3 payload size: 27 bytes
01:05:58	923.2	loro	4/5	SF 10 BW 125	288.8	38010 dev sdr: 26 04 11 E3 payload size: 12 bytes
01:05:57	920.8	loro	4/5	SF 12 BW 125	1646.6	660 dev sdr: 26 04 11 E3 payload size: 27 bytes
01:05:44	923.2	loro	4/5	SF 10 BW 125	288.8	38009 dev sdr: 26 04 11 E3 payload size: 12 bytes
01:05:43	920.6	loro	4/5	SF 12 BW 125	1646.6	659 dev sdr: 26 04 11 E3 payload size: 27 bytes
01:05:40	920.4	loro	4/5	SF 10 BW 125	288.8	38008 dev sdr: 26 04 11 E3 payload size: 12 bytes
01:05:40	920.4	loro	4/5	SF 12 BW 125	1646.6	659 dev sdr: 26 04 11 E3 payload size: 27 bytes
01:05:33	920.2	loro	4/5	SF 10 BW 125	288.8	38007 dev sdr: 26 04 11 E3 payload size: 12 bytes
01:05:31	920.2	loro	4/5	SF 12 BW 125	1646.6	659 dev sdr: 26 04 11 E3 payload size: 27 bytes

(a) LoRaWAN Gateway

time	counter	port	status	payload
23:33:25	0			
23:33:25	546	1	rety confirmed	payload: 09 B6 21 34 00 03 04 BE 00 A2 07 4D 26 2A
23:33:00	0			
23:33:29	546	1	rety confirmed	payload: 09 B6 21 34 00 03 04 BE 00 A2 07 4D 26 2A
23:33:24	0			
23:33:23	544	1	confirmed	payload: 08 B8 21 34 03 03 04 BE 00 A2 07 4D 26 2A
23:33:09	0			
23:33:09	545	1	rety confirmed	payload: 09 B6 21 34 00 04 04 BC 00 9B 07 13 26 17
23:33:05	0			
23:33:05	545	1	rety confirmed	payload: 09 B6 21 34 00 04 04 BC 00 9B 07 13 26 17
23:33:01	0			
23:33:00	545	1	rety confirmed	payload: 09 B6 21 34 00 04 04 BC 00 9B 07 13 26 17
23:29:55	0			

(b) LoRa Node

Fig. 14. Gateway data traffic and LoRa configuration parameters in TTN.

hexadecimal form.

The LoRa packet structure consists of: (i) Preamble (Min 4.25 Symbols, (ii) Header (2-bytes), (iii) Header CRC 2-bytes), (iv) Data Payload (Max 255-bytes and (v) Payload CRC (2-bytes). A packet starts with the preamble, programmable from 6 to 65,535 symbols, to which the radio adds 4.25 symbols for the sync word. After that, it follows an optional header that describes the length and Forward Error Correction (FEC) rate of the payload and indicates the presence of an optional 16-bit Cyclic Redundancy Check (CRC) for the payload. The header is always transmitted with a 4/8 FEC rate and has its own CRC. After the optional header, there is the payload, which can contain 1 to 255 bytes. At the end of the payload, an optional 16-bit CRC may be included. In our system, the gathered data from the four sensors (voltage, current, DHT11, LDR) is combined into data packets of 14 payloads to be transmitted to the gateway. This combination represents the Data Payload in the LoRa Phy Packet Format. As shown in Fig. 15, the developed code is used to compose 14 payloads in one packet to be sent to the TTN every ten seconds. The received data by TTN will be decrypted and displayed as hexadecimal representations of the decrypted “binary data,” every two digits being one “byte”, just like sent by the sensor node. The bytes could be anything: for example, numbers, text, and some special encoding of the states of certain switches.

Usually, the LoRaWAN gateway can receive the data from hand-guards and sometimes thousands of LoRa nodes. Each of these nodes has its unique device ID that must be predefined in its microcontroller. Thus, it allows secure end-to-end communication in a star-of-star topology. Among the parameters that we need to configure when creating our TTN application, are the Application ID, Application Type (ABP or OTAA), Device ID, Device EUI, Device Address, Application EUI, Network Session Key, and Application Session Key. These parameters have to be defined in our program, thus allowing us to identify the received information based on the sender node. With the setting of these parameters to the connected devices with the gateway, the TTN will display the ID of each device with the received information and time of receiving data. In the TTN platform, we have used Payload Decoder to change bytes sent (hexadecimal) characters to human-readable fields, as shown in Fig. 16.

The received uplink payload, which consists of 14 bytes (2 bytes each sensor reading), will be decoded into seven sensor readings for the considered quality parameters (voltage, current, power, energy, temperature, humidity, and light intensity) to display the obtained readings from the implemented sensors. However, the TTN dashboard is not user-friendly and does not have any features for data visualization. Accordingly, we have developed two GUIs for monitoring PV system as part of the software implementation. The first GUI is a web-based dashboard

```
// Split both words (16 bits) into 2 bytes of 8
byte payload[14];
payload[0] = highByte(temperature);
payload[1] = lowByte(temperature);
payload[2] = highByte(humidity);
payload[3] = lowByte(humidity);
payload[4] = highByte(lux);
payload[5] = lowByte(lux);
payload[6] = highByte(Voltage);
payload[7] = lowByte(Voltage);
payload[8] = highByte(Current);
payload[9] = lowByte(Current);
payload[10] = highByte(Power);
payload[11] = lowByte(Power);
payload[12] = highByte(Energy);
payload[13] = lowByte(Energy);
```

Fig. 15. LoRa packet payloads structure.

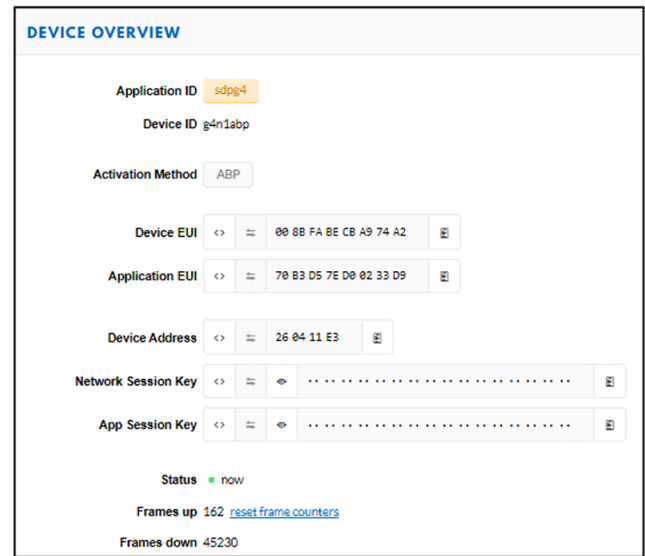

Fig. 16. Device overview and its data in TTN.

integrated into the TTN webservice (AllThingsTalk Maker). In ATTM, we have created our channel and connected it to the TTN by using a channel ID, a write API key, and a read API key to allow the channel to acquire data from TTN and display it in the predefined visualize gauge chart or widgets. The ATTM cloud can view the information through the graph, numeric display, or comparing the data of different periods in a graph. Ten visualization widgets were created to display the considered measurements. The developed channel supports developer and user modes to control channel privacy. API keys can be used to forward data to other devices and share data accessibility.

5.1. System functionality evaluation

Owing to the limitation of the TTN platform to develop a user-friendly interface, the integration with the ATTM is used to display the data in a better readable layout. Another payload decoder using ABCL is built in the ATTM to convert the received values to be readable under each asset. Once the payload is received from the TTN, the ATTM web server and the mobile app display the decimal values for each parameter together with its receiving time. Fig. 17 shows the values represented in the ATTM webservice, mobile application developer, and user view respectively. However, more options to view and analyze data are available in the Web-based dashboard of ATTM. In the mobile application, users will be able to view the latest data values only. As the value of the energy keeps increasing, the mobile app keeps updating the latest value to be shown.

Furthermore, the ATTM can display the results in the form of live digital values with charts to show historical trends of the considered sensor as shown in Fig. 18, which represents selected charts for some sensors for specific periods. This feature enables the user to keep track of the energy usage, including other sensor values. Fig. 18 (a) represents the variation of SNR and RSSI for the selected time interval with a good signal condition. The SNR is approximately 10, whereas RSSI is varying between (-60 and -40 dB). On the second graph, the live updates of the current, voltage, and power are depicted. The values are mostly constant because of the fixed load. Fig. 18 (c) describes how energy consumption and its cost based on a fixed tariff of (RM 0.25) are increased in a cumulative form with time. The calculation of the expected energy bill is carried out in the ATTM decoder. This is to avoid the extra traffic in the network and reduce the size of the transmitted packets from LoRa nodes. Since the load is small, we consider the energy in Joule instead of kWh to show a clear variation of energy with a short period. Energy is equivalent to the amount of power usage within a specific time interval. In this

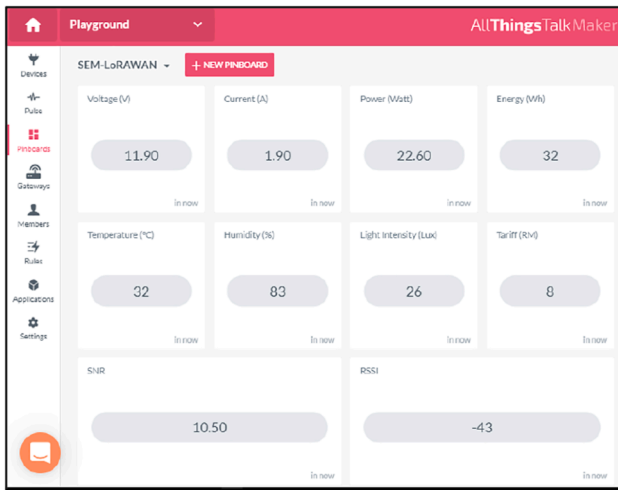

(a) Web-based Pinboards

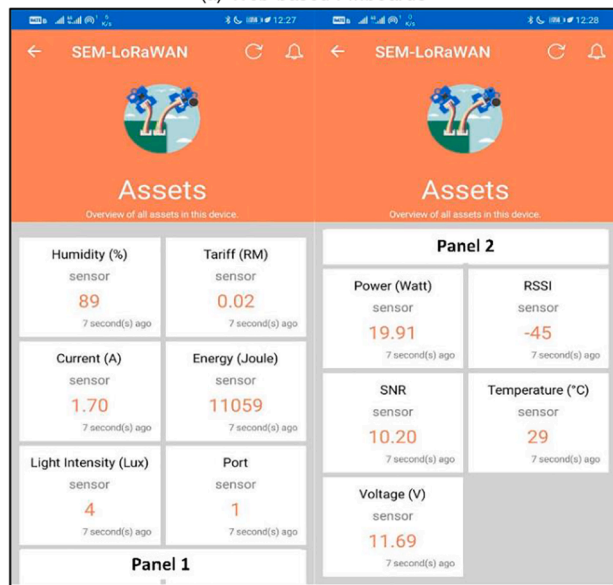

(b) Mobile App. developer view

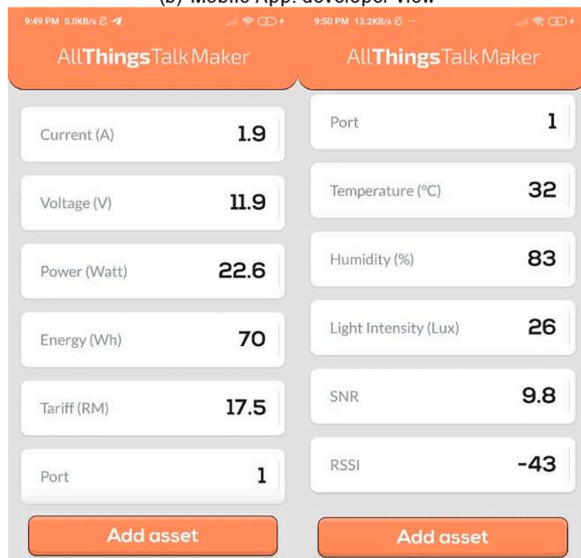

(c) Mobile App. user view

Fig. 17. Instantaneous results are displayed in the ATTM.



(a) SNR and RSSI

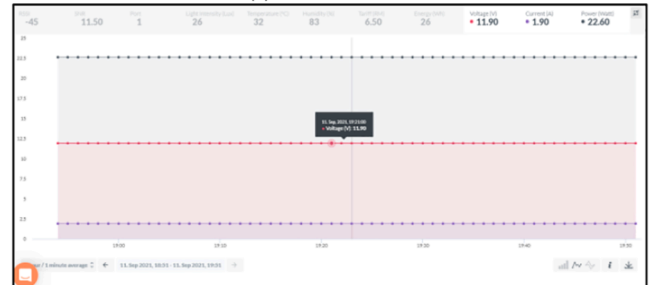

(b) Voltage, Current, and Power



(c) Energy and electricity tariff



(d) Light Intensity, Temperature, and Humidity

Fig. 18. Results as displayed in the ATTM dashboard as a live chart.

scenario, the time interval is 12 h, which is equivalent to 43,200 s. This energy can be easily converted into kWh, and its cost is estimated and displayed in the “Tariff” field based on the predefined cost per kWh. The last graph illustrates the changes in the environmental condition near the PV system in terms of temperature, humidity, and light intensity.

These parameters can be monitored in a multi-option dashboard on the web-based ATTM cloud. The data which are shown in the graph are the live data received periodically from the LoRa node. A slight delay is observed from one payload to another to show a more distinctive value of energy according to the delay defined in the Arduino code. As the live data graphs move continuously and only represent a short time, the recorded data during the period test (12 h) were collected and analyzed. The ATTM can store the data in the server cloud, and such data can be downloaded for further analysis. We can extract data for a period of time (hour, day, week, and month). In this experiment, the data of 12 h of operation were extracted and averaged per 10 min; thus, each graph in the following figures represents “73” points that are enough to prove the

smooth operation of the developed smart meter. According to the practical implementation, data of SNR and RSSI are collected from the ATTM for the test period to understand the LoRa network coverage and the received signal quality. As our scenario is mixed between the indoor gateway and outdoor node, SNR and RSSI need to be analyzed.

Fig. 19 shows the RSSI and SNR values with respect to the time of the scenario under study. As we mentioned earlier, many tests were carried out for different locations and distances between the system and the gateway. However, to examine the real use case of our smart meter, a fixed location of the PV system was tested in this scenario. RSSI results showed stability with time, which changed between -60 dB, as a minimum value, and -43 dB as a maximum value. Thus, the worst RSSI value was -60 dB, which is a strong signal when considering obstacles between the node and the gateway and the None Line of Sight environment. The relative humidity levels could also degrade the LoRa signal. Moreover, we can observe that the SNR achieved acceptable values between 10.9 and 11.7 for the entire period regardless of time and interference level. In our case, we can confirm that no other LoRa nodes are transmitting nearby; thus, less interference occurs. Under these conditions, the coverage range of our gateway can be extended to reach outside the university campus. From previous tests, we investigated the impact of the buildings that decrease the obtained SNR and RSSI level, when our system moved far from the office where the gateway was placed.

Fig. 20 shows electricity-related metrics, including current, voltage, power, and energy. Similarly, these values represent a 10 min-based average of system operation for 12 h continuously. Our load is fixed for three DC bulbs with a current of 1.5 to 2 A. The system output voltage slightly varies between 11.5 and 11.7 V and results in changing load power from 17.3 to 23 W. We can observe that voltage and current almost remain constant during the experiment time. Only energy is increased with time as it is accumulatively estimated based on the power and the time. The maximum value of the energy counter reading reaches 18 kJ. As stated earlier, the joule unit can be converted to kWh for higher energy readings and electricity billing purposes. Moreover, our SEM-LoRaWAN was tested with different locations to investigate and identify the strength of the LoRaWAN gateway in terms of exchange data with TTN and ATTM server. The system was also tested in cloudy weather and different time (day/night) to observe how far the energy meter can be working without sunlight irradiation. These processes were supported by a battery that reacts as the energy storage for the solar panel and a temporary power when no sunlight is generated from the solar panel.

Fig. 21 demonstrates the values of temperature, humidity, and light

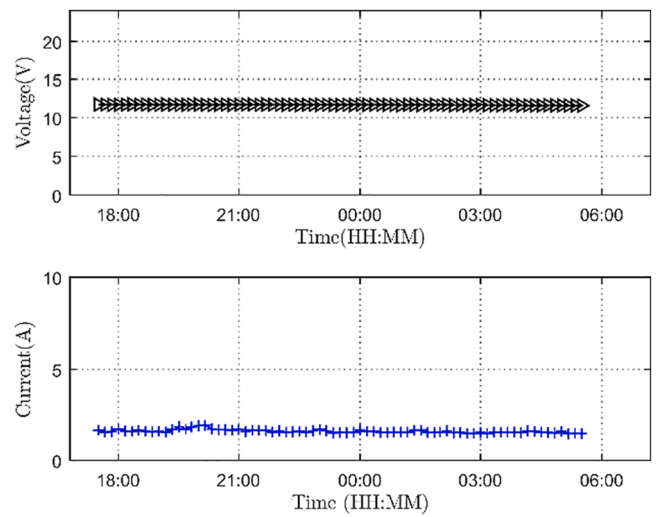

(a) Voltage and Current

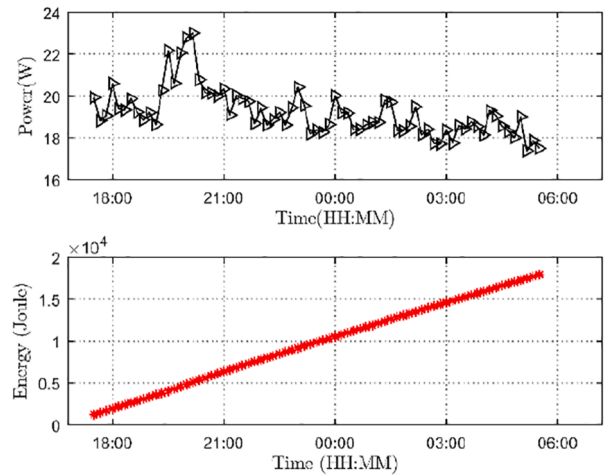

(b) Power and Energy

Fig. 20. Electricity-related metrics of SEM-LoRaWAN as a function of time.

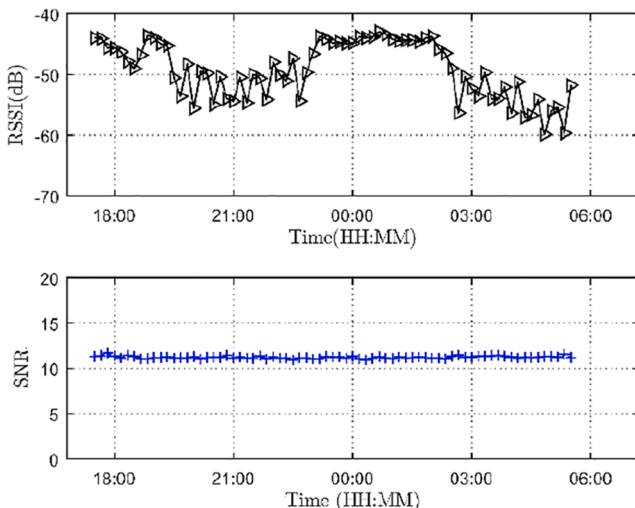

Fig. 19. LoRa signal characteristics as a function of time: RSSI and SNR.

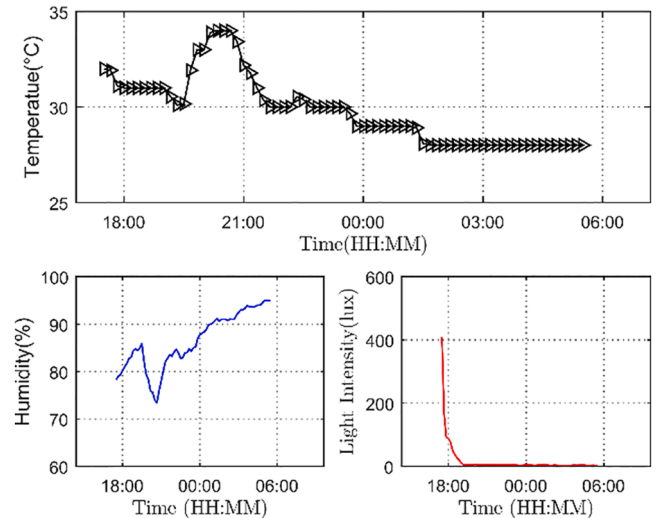

Fig. 21. Environmental conditions at PV System as a function of time: Temperature, Humidity, and Light.

intensity measured during the experiment. We can see that the highest temperature (34 °C) is registered at 20:20 and it decreases to reach 28 °C from 1:30 am until the test ended at 5:30 am. During the daytime, these values are higher as we observed in other tests, particularly on sunny days. The temperature values can help in understanding the weather conditions at the PV system. Similarly, the relative humidity in the second graph of the same figure changes from 73% at 20:40 to 95% at the end of the test. That is, the humidity rises gradually because of the dew and air condensation that happens in the early mornings. This high humidity weather causes degradation in the signal strength as we can observe in the values of RSSI that reached - 60 dB at early morning times compared with night times. Finally, the third graph in the figure shows the recorded light intensity values at the PV system by the LoRa node using the LDR sensor. Since most of the test time was at the night, light intensity values were small and close to zero. We can notice higher light intensity values only at the beginning of the test from 17:30 to 19:00. As the darkness level increased, the system depends on the battery to supply the load and power on the SEM instead of the solar panel. As can be noticed, all sensors can detect the various weather conditions at the PV system and successfully update real-time data to the IoT servers. These sensor readings represent add-on functions for the developed SEM to monitor the environmental conditions that might affect the PV system efficiency.

5.2. Results validation

The comparison of readings between real-time monitoring and practical testing was also carried out. The validation test for voltage and current readings was carried out first. These two values are very important to calculate the power and energy consumption in the PV

system. During the practical test scenario, a digital multimeter was used to measure the load voltage and current. Fig. 22 (a) compares the obtained results from SEM-LoRaWAN and the utilized multimeter for the considered time period. The results from our system were slightly lower than the measurements since it represents the average of hundred readings compared to one reading using the multimeter at each point. Accordingly, a small diversity is observed between real-time monitoring and practical test; however, it does not mean the inaccuracy of our system. The reading of voltage in real-time monitoring varied between 11.68 and 11.73 V comparing with 11.71 to 11.75 V using the multimeter. On the other hand, the current varies between 1.6 and 1.76 A which are too close to the obtained readings using the digital meter. Overall, the trends of both graphs are in an agreement. Through this analysis, the voltage and current readings accuracy were validated, and the proposed energy meter can be used to monitor the electrical parameters of the stand-alone PV system in real-time.

Fig. 22 (b) depicts a comparison of the collected data using our system and the theoretical calculations of the power and energy. The load power represents the instantaneous consumed energy and can be calculated by the direct multiplication of the dc voltage and current. The accumulative consumed energy can be found by considering the instantaneous power and the time period for load feeding with the electrical power. There are slight differences in the power readings from SEM-LoRaWAN and theoretical values. This is because the readings of our system are averaged while the theoretical calculation only considers one value at each point. Overall, the trend of both graphs was almost the same. On the other hand, the observed readings of energy which is accumulative readings are almost identical and consistent in most cases regardless of time and all still in the. The electrical parameters of the proposed system are validated and work efficiently.

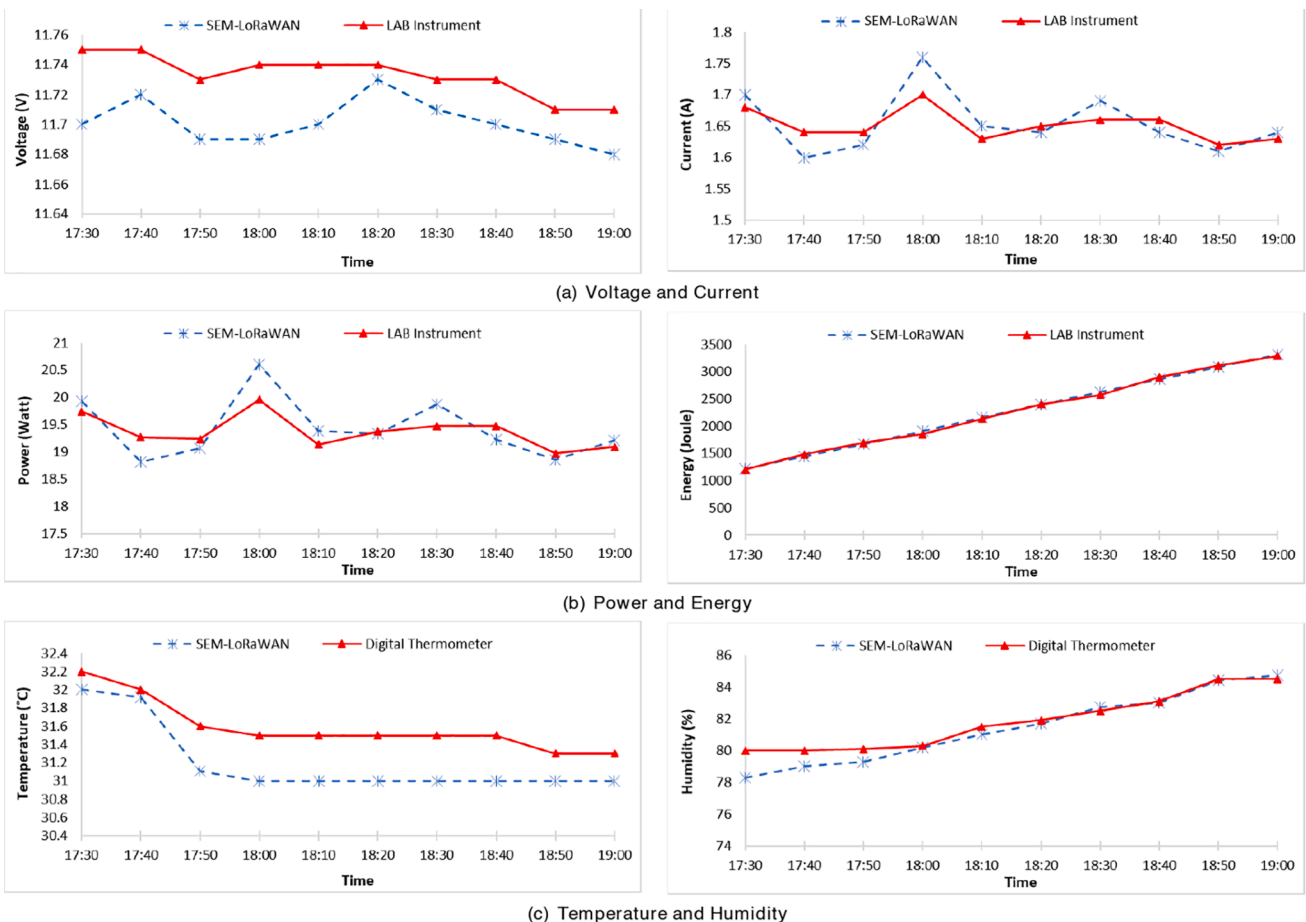

Fig. 22. Comparison of SEM-LoRaWAN and LAB instrumentation measurements.

Similarly, a digital thermometer is used to measure the temperature and humidity at the PV system to validate the DHT11 sensor measurements. The readings measurements were taken every 10 min and compared with the averaged readings from the developed IoT energy meter system. The temperature has slightly differed within the range of less than one degree. The validation of the surroundings measurements was carried out for the defined period, as shown in Fig. 22 (c). The graph compares the temperature using both systems. Generally, the trend of both graphs was consistent irrespective of the time. The measured temperature by our system was slightly lower and the system manages to measure the temperature continuously for the considered period. The data is updated in real-time to the TTN and ATTM IoT servers. In contrast, the collected results from the SEM-LoRaWAN during the real test of the humidity are almost the same as the measured values. These surroundings parameters give a good indicator of the PV system efficiency which is affected by the sunlight and light intensity.

Therefore, the system's effectiveness and accuracy have been proven during the validation process. The system managed to steadily update the gateway with accurate data and the parameters read by the sensors were also precise compared with the measured values using LAB instruments during this study. This finding proves that the system is reliable and can be implemented in real scenarios of stand-alone PV systems. In addition, the SEM-LoRaWAN is a standalone device and can run and update data continuously with no human intervention. The PV solar panel supplies the required energy for the sustainable operation of the system. The PV solar panel harnesses energy from the sunlight, and the energy was utilized to feed the DC loads and the system components. By exploiting renewable energy resources, an external power source is not needed, which benefits the environment.

6. Conclusion

A SEM based on LoRaWAN for monitoring PV systems over IoT has been designed and fabricated. Several electrical and environmental parameters, namely, voltage, current, power, energy, light intensity, temperature, and humidity, can be monitored in real-time using the TTN platform and ATTM IoT server. The electricity billing data based on the predefined fixed tariff were manipulated as an add-on option to be monitored. Arduino attached with the LoRa shield is used as the main controller to collect the data from sensors and send them to the LoRaWAN gateway, which uploads the data to the IoT cloud. A portable PV system is fabricated and provided with the SEM. According to the practical tests under various conditions, the developed SEM-LoRaWAN for the PV system is proven to work effectively in monitoring the DC energy consumption of the PV system and related parameters. The monitored data can be displayed in TTN and ATTM dashboards using computing devices connected with the Internet. The obtained electrical-related results including current, voltage, and power, were validated using DMM. A deterministic wireless channel evaluation in terms of RSSI and SNR was conducted to consider network coverage and signal quality during practical deployment. Real-time measurements show the viability of the SEM-LoRaWAN in terms of successful data reception and reliable communication links. Future work is foreseen in more tests with larger loads, including longer times with multiple systems instead of a single PV system. More investigation will be carried out in higher levels of system integration as an AC energy meter to monitor the energy consumption of loads are connected to the DC/AC converter of the PV system.

CRedit authorship contribution statement

Waheb A. Jabbar: Supervision, Funding acquisition, Project administration, Writing – review & editing, Conceptualization, Methodology, Writing – original draft, Investigation, Visualization, Resources, Software, Validation. **Sanmathy Annathurai:** Conceptualization, Methodology, Writing – original draft, Investigation,

Visualization, Resources. **Tajul Ariffin A. Rahim:** Investigation, Visualization, Resources, Data curation. **M. Fitri Mohd Fauzi:** Conceptualization, Methodology, Formal analysis.

Declaration of Competing Interest

The authors declare that they have no known competing financial interests or personal relationships that could have appeared to influence the work reported in this paper.

Acknowledgment

This research was supported by Universiti Malaysia Pahang under the grant scheme number PDU203229.

References

- Adhya, S., Saha, D., Das, A., Jana, J., & Saha, H. (2016). In *An IoT based smart solar photovoltaic remote monitoring and control unit* (pp. 432–436). IEEE.
- Ahmed, A. A., Jabbar, W. A., Sadiq, A. S., & Patel, H. (2020). Deep learning-based classification model for botnet attack detection. *Journal of Ambient Intelligence and Humanized Computing*, 1–10.
- Al-Ali, A., Al Nabulsi, A., Mukhopadhyay, S., Awal, M. S., Fernandes, S., & Ailabouni, K. (2020). IoT-solar energy powered smart farm irrigation system. *Journal of Electronic Science and Technology*, 100017.
- Alahakoon, D., & Yu, X. (2015). Smart electricity meter data intelligence for future energy systems: A survey. *IEEE Transactions on Industrial Informatics*, 12, 425–436.
- Ali, A., Saad, N. H., Razali, N., & Vitee, N. (2012). In *Implementation of Automatic Meter Reading (AMR) using radio frequency (RF) module* (pp. 876–879). IEEE.
- Asghar, M. R., Dán, G., Miorandi, D., & Chlamtac, I. J. I. C. S. (2017). & Tutorials. *Smart meter data privacy: A survey*, 19, 2820–2835.
- Avancini, D. B., Rodrigues, J. J., Rabêlo, R. A., Das, A. K., Kozlov, S., & Solic, P. (2020). A new IoT-based smart energy meter for smart grids. *International Journal of Energy Research*.
- Balfaqih, M., Balfaqih, Z., Shepelev, V., Alharbi, S. A., & Jabbar, W. A. (2020). An analytical framework for distributed and centralized mobility management protocols. *Journal of Ambient Intelligence and Humanized Computing*, 1–13.
- Bansal, P., & Singh, A. (2016). In *Smart metering in smart grid framework: A review* (pp. 174–176). IEEE.
- Barman, B. K., Yadav, S. N., Kumar, S., & Gope, S. (2018). In *IOT Based Smart Energy Meter for Efficient Energy Utilization in Smart Grid* (pp. 1–5). IEEE.
- Chaudhari, B. S., Zennaro, M., & Borkar, S. (2020). LPWAN Technologies: Emerging Application Characteristics, Requirements, and Design Considerations. *Future Internet*, 12, 46.
- Chettri, L., & Bera, R. (2019). A Comprehensive Survey on Internet of Things (IoT) Towards 5G Wireless Systems. *IEEE Internet of Things Journal*.
- Faisal, M., Karim, T. F., Pavel, A. R., Hossen, M. S., & Lipu, M. H. (2019). In *Development of Smart Energy Meter for Energy Cost Analysis of Conventional Grid and Solar Energy* (pp. 91–95). IEEE.
- Fan, X., Zhou, C., Sun, Y., Du, J., & Zhao, Y. (2019). Research on Remote Meter Reading Scheme and IoT Smart Energy Meter Based on NB-IoT Technology. In *Journal of Physics: Conference Series* (Vol. 1187, pp. 022064): IOP Publishing.
- Gaber, M. M., Aneiba, A., Basurra, S., Batty, O., Elmisery, A. M., Kovalchuk, Y., & Rehman, M. H. U. (2019). Internet of Things and data mining: From applications to techniques and systems. *Wiley Interdisciplinary Reviews: Data Mining and Knowledge Discovery*, 9, Article e1292.
- Gu, C., Zhang, H., & Chen, Q. (2014). In *Design and implementation of energy data collection system using wireless fidelity (WiFi) module and current transformer* (pp. 133–137). IEEE.
- Hameed, K. L., & Barnouti, N. H. (2019). In *Electricity Monitoring and Controlling IoT Smart System* (pp. 182–187). IEEE.
- Han, J., Choi, C.-S., Park, W.-K., Lee, I., & Kim, S.-H. J. I. T. o. C. E. (2014). PLC-based photovoltaic system management for smart home energy management system. 60, 184–189.
- Ismael, S. M., Aleem, S. H. A., Abdelaziz, A. Y., & Zobaa, A. F. (2019). State-of-the-art of hosting capacity in modern power systems with distributed generation. *Renewable energy*, 130, 1002–1020.
- Jabbar, W. A., Saad, W. K., Hashim, Y., Zaharudin, N. B., & Abidin, M. F. B. Z. (2018). In *Arduino-based Buck Boost Converter for PV Solar System* (pp. 1–6). IEEE.
- Jabbar, W. A., Wei, C. W., Azmi, N. A. A. M., & Haironnazli, N. A. (2021). An IoT Raspberry Pi-based Parking Management System For Smart Campus. *Internet of Things*, 100387.
- June Smart Energy Module. In. (2021) (Vol. 2021).
- Kobylinski, P., Wierzbowski, M., & Piotrowski, K. (2020). High-resolution net load forecasting for micro-neighbourhoods with high penetration of renewable energy sources. *International Journal of Electrical Power & Energy Systems*, 117, Article 105635.
- Kumar, P., Lin, Y., Bai, G., Paverd, A., Dong, J. S., & Martin, A. (2019). Smart grid metering networks: A survey on security, privacy and open research issues. *IEEE Communications Surveys & Tutorials*, 21, 2886–2927.
- Larsen & Toubro Single Phase Smart Meter – Aurora. In. (2021) (Vol. 2021).

- Li, L., Hu, X., & Zhang, W. (2009). In *Design of an ARM-based power meter having WIFI wireless communication module* (pp. 403–407). Ieee.
- Lorente, J. L., Liu, X., & Morrow, D. J. (2020). Spatial Aggregation of Small-scale Photovoltaic Generation Using Voronoi Decomposition. *IEEE Transactions on Sustainable Energy*.
- Magrin, D., Capuzzo, M., & Zanella, A. (2019). A Thorough Study of LoRaWAN Performance Under Different Parameter Settings. *IEEE Internet of Things Journal*.
- Narmadha, R., Rajkumar, I., Sumithra, R., & Steffi, R. (2020). In *Continuous Monitoring of Electricity Energy Meter Using IoT* (pp. 731–738). Springer.
- Nitnaware, D. J. A. a. S. (2019). Smart Energy Meter: Application of WSN for Electricity Management.
- Patel, H., & Upadhyaya, T. K. (2020). Printed Multiband Monopole Antenna for Smart Energy Meter/WLAN/WiMAX Applications. *Progress In Electromagnetics Research*, 89, 43–51.
- Pattanayak, A. S., Pattnaik, B. S., & Panda, B. N. (2014). In *Implementation of a smart grid system to remotely monitor, control and schedule energy sources using Android based mobile devices* (pp. 1–5). IEEE.
- Pawar, P., & TarunKumar, M. (2020). An IoT based Intelligent Smart Energy Management System with accurate forecasting and load strategy for renewable generation. *Measurement*, 152, Article 107187.
- Prathik, M., Anitha, K., & Anitha, V. (2018). In *Smart Energy Meter Surveillance Using IoT* (pp. 186–189). IEEE.
- Rahman, M. M., Islam, M. O., & Salakin, M. S. (2015). In *Arduino and GSM based smart energy meter for advanced metering and billing system* (pp. 1–6). IEEE.
- Rizal, M., & Ilham, A. A. (2018). In *Performance of LoRa Gateway based Energy Consumption and Different Frame Sizes* (pp. 159–162). IEEE.
- Salam, A. (2020). Internet of Things for Sustainable Community Development: Introduction and Overview. In *Internet of Things for Sustainable Community Development* (pp. 1–31). Springer.
- Saleem, Y., Crespi, N., Rehmani, M. H., & Copeland, R. (2019). Internet of things-aided smart grid: Technologies, architectures, applications, prototypes, and future research directions. *IEEE Access*, 7, 62962–63003.
- Siano, P., De Marco, G., Rolán, A., & Loia, V. (2019). A survey and evaluation of the potentials of distributed ledger technology for peer-to-peer transactive energy exchanges in local energy markets. *IEEE Systems Journal*, 13, 3454–3466.
- Smartenit Wireless Energy Metering Smart Outlet ZBMSKT1. (2021). In, (Vol. 2021).
- Subhash, B., & Rajagopal, V. (2014). In *Overview of smart metering system in Smart Grid scenario* (pp. 1–6). IEEE.
- Uebel, U., Kavaiya, G., Fischer, K. C., Lenox, C., & Scrutchfield, D. H. (2020). Solar energy metering, communications, and control system. In: Google Patents.