

**Simplified Environment Control System  
For Prototype Vertical Farm**

By

Ling Bok Chee

14815

Dissertation submitted in partial fulfillment of  
the requirement for the  
Bachelor of Technology (Hons)  
Business Information System

AUGUST 2014

Universiti Teknologi PETRONAS  
Bandar Seri Iskandar  
31750 Tronoh  
Perak Darul Ridzuan

# CERTIFICATION OF APPROVAL

## Simplified Environment Control System For Prototype Vertical Farm

by

Ling Bok Chee

14815

A project dissertation submitted to the

Business Information System Programme

Universiti Teknologi PETRONAS

in partial fulfilment of the requirement for the

BACHELOR OF TECHNOLOGY (Hons)

(INFORMATION SYSTE)

Approved by,

---

Main Supervisor,  
(Dr. Helmi Bin Md Rais)

Approved by,

---

Co-supervisor  
(Mr. Amzairi Bin Amar)

UNIVERSITI TEKNOLOGI PETRONAS  
TRONOH, PERAK

## **Certification of Originality**

This is to certify that I am responsible for the work submitted in this project, that the original work is mine except as specified in the references and acknowledgements, and that the original work contained herein has not been undertaken or done by unspecified sources or person.

---

LING BOK CHEE

## **Abstract**

Farming is one of the fundamental inventions that promoted the flourishing of human species on planet earth. Since many centuries have past, this fundamental invention namely the conventional way of it has become reverse which is promoting extinction. Conventional farming has led to many unsustainable acts such as deforestation, heavy use of pesticides and insecticides, feces as fertilizers, open burning and creation of cities. These acts in turn backfired resulting in global warming, extreme climate change (drought, flood, hurricanes etc), exponential rise in human population resulting in consumption of resources over the replenishing rate, pollution of water sources, diseases spreading such as typhoid and cholera. The very main reason such occurrence is because of direct interaction of farming with nature. Farming is not a natural behavior of an ecosystem (Despommier, 2009). It is a creation of human beings to increase its survival rate. Hence in a simple mathematical equation, if we remove farming from nature and put it in a closed system which resembles the nature ecosystem, we can remove the potential unsustainable acts of farming. The concept of vertical farming is to remove the factor of farming from nature to undo the bad deeds before it is too late. This simplistic solution might seem like a dreamer's solution and appear to be impractical due to its high costs. To prove that argument wrong, this research will show the latest breakthrough in the agriculture industry in growing plants in a building and too how far is a vertical farm concept farfetched? Thus, this research will be proposing to construct simplified miniature 3 storeys vertical farm system that uses hydroponic system and govern by an expert system using the methodology proposed by CLAES

## **Acknowledgement**

First and foremost, I would like to thank Dr. Helmi and Mr. Amzairi for giving guidance and advice throughout this final year project period. I would also like to extend my gratitude to officers of RISDA Mr. Abdul Razak and Mr. Bakhtiar Riduan for spending time and effort to assist me in this research. Thank you to Madam Norshuhani Binti Zamin for the motivational sharing session that started this research and Mr. Vincent Wong for his assistance to assemble, control and program Arduino Uno microcontroller and its electrical components. Last but not least, I would like to thank all my family and friends for supporting me especially my roommate, Chasith for tolerance and technical support

# Table of Contents

CERTIFICATION OF APPROVAL .....	1
Certification of Originality.....	2
Abstract .....	3
Acknowledgement.....	4
Table of Contents .....	5
List of Figures .....	8
List of Tables.....	8
Abbreviations and Nomenclatures .....	9
CHAPTER 1: INTRODUCTION .....	10
1.1 Background of Study .....	10
1.1.1 Global Issues .....	11
1.1.2 Social Trend to Modern Farming .....	12
1.1.3 Vertical Farming Concept .....	13
1.1.4 Controversies of Vertical Farming Concept.....	15
1.2 Problem Statement.....	17
1.2.1 Changing of Climate and Unpredictable Weather Patterns.....	17

1.2.2	Rising of Human Population by 2050 .....	19
1.2.3	Resource Consumption Rate > Resource Replenishing Rate.....	20
1.2.4	Lack of Commercial ES in the Market.....	21
1.3	Objectives and Scope of Study .....	22
CHAPTER 2: LITERATURE REVIEW .....		24
2.1	Terminologies Definition.....	24
2.2	Previous Work .....	27
2.3	Research Gap .....	35
CHAPTER 3: METHODOLOGY .....		37
3.1	ES Development Life Cycle .....	38
3.2	Knowledge Engineering Methodology .....	39
3.3	Software Engineering Methodology.....	40
3.4	ES Evaluation .....	42
CHAPTER 4: RESULTS AND DISCUSSIONS .....		44
4.1	Phase 1: Collection and Categorizing.....	44
4.1.1	Interview with RISDA Officers (Tacit).....	44
4.1.2	Billy's Hydroponic (Explicit).....	46

4.2 Phase 2: Constructing and Testing of the Overall Vertical Farm System .....46

4.2.1 Electrical Circuit Board Design.....46

4.2.2 Vertical Farm Structure .....48

4.2.3 Expert System.....48

CHAPTER 5: CONCLUSION & RECOMMENDATIONS .....50

REFERENCES.....51

APPENDICES .....56



## **List of Figures**

Figure 1: Farming Categories.....	13
Figure 2: Maximum and Minimum Temperature Trending in Malaysia (1969 until 2014) .....	18
Figure 3: World’s Ecological Footprint by 2050 based on scenario.....	20
Figure 4: Adopted Expert System Development Life Cycle from CLAES .....	38
Figure 5: Vertical Farm System Electrical Circuit Board Design Draft .....	47
Figure 6: Vertical Farm Structure (ONE Level) .....	48
Figure 7: Interfaces of Vertical Farm Expert System .....	49

## **List of Tables**

Table 1: Market Price of Various Vegetables, Fruits and Tilapia Fish.....	15
Table 2: Comparison of Purgro (Grobot Evolution) and Grohaus (HydroidTM).....	22
Table 3: Comparison of Hydroponic, Aeroponic and Geoponic .....	25
Table 4: Review of Related Literature in Setting up and Improving Greenhouse Application.....	28

## **Abbreviations and Nomenclatures**

SPA : Speaking Plant Approach

ES : Expert System

MIMO : Multi-input, Multi-output

CLAES : Central Laboratory for Agricultural Expert Systems

## **CHAPTER 1:**

### **INTRODUCTION**

#### **1. Introduction**

The world is going on a transition phase primarily due to involvement of human activities. Current practices are shaping the world in a manner that is unfavorable to live in. One of the biggest contributors to this unfavorable transition process is conventional agriculture practices. Agriculture originates from two Latin words combined; '*ager*' which means field and '*cultura*' which means culture (Collins English Dictionary). The activities involve in agriculture consists of growing of crops and rearing of livestock (Random House Kenerman Webster's College Dictionary). In Chapter 1, a short reviewed is done on the evolution of agriculture since 10,000 years ago until now. A concise problem of where exactly conventional agriculture has gone wrong and it is aimed to be corrected.

#### **1.1 Background of Study**

According to The Genographic Project 2.0 Beta by National Geographic. It was summarized that farming appeared mainly because traditional way of hunting and gathering food in the wild was no longer life-sustaining. Between 5000 to 10,000 years ago, crops such as cereals, rice, squash, maize and potato were once considered wild plants. As these plants were favored by the human population in the local area, they were domesticated for homegrown and that has led to plant domestication. Earliest animal domestication was dated back all the way up to 13,000 years ago. It is discovered that farming has led mutation in the human genome to be lactose tolerant in some point of history. These practices were spread and evolved until what we see around these days.

### 1.1.1 Global Issues

It is undoubted that farming was the sole factor that allows human population rocketed as of this year 2014 to 7.2 billion (United Nations, Department of Economic and Social Affairs Population Division, 2012). In spite of being a magnificent discovery, agriculture is beginning to haunt human being with the side effects from its practices.

The current state of agriculture is largely done in thousands of hectares of lands where large tractors cultivate, plant seed, water and harvest crops. These large scale farming are mostly done in outdoors and are extremely sensitive to the environment changes such as climate, natural predator, diseases and soil quality. For example, it is highly likely that one out of ten of the crops that are grown would be lost in account for every 1 degree increase of atmospheric temperature (Despommier, 2010). If drought were to occur constantly, crop harvesting would have plummeted and cause serious food security to the planet. Soil quality degrades after constant farming activities hence methods such as crop rotation and fertilizers are used to maintain soil quality. It is common knowledge to all that high usage of fertilizers on farm lands would result in water pollution such as eutrophication. Even so, a more disturbing fact was realized where an estimation of 50% of the world population still uses human excretory waste as fertilizer, especially in developing countries (Knudsen, L. G., Phuc, P. D., Hiep, N. T., Samuelsen, H., Jensen, P. K., Dalsgaard, A., Konradsen, F, 2008). Contamination of human excretory waste to food is a serious issue as diseases such as cholera and typhoid fever can be easily transmitted via feces and urine. As for natural predator, Australia would be the best example. Every year without fail, Australia would be plague with swarm of locusts which in serious cases can destroy over 500,000 hectares (size of the entire country of Brunei) of agricultural zone (Australian Government, Department of Agriculture, 2012). In latest attempt to rectify the situation, humans have resort into GMO (Genetically Modified Organism) to increase harvest yield, improve plants resistance towards the environment and on top of that enabling encapsulation of medical purpose in them (Edwards T., Faerber J., Goenawan A. & Osawa S., 2005). GMO too has led to many controversies such as being deemed as defy nature's doing, unpredictable long-term effects, genetic pollution where GMO genetics are blended into organic farms through wind transmission, lack of

labeling to distinguish GMO and non-GMO, safety for consumption is questionable and enabling higher usage of pesticides (Edwards T. et al, 2005).

In lights of these events, it can be conclude that conventional farming is becoming much more difficult to carry out due to rapid changes in the environment (soil quality, climate, disease, fertilizers, natural predators and etc). Even though GMO has proven to be a possible solution, it would only be temporary as natural predator would eventually catch up with evolution (Despommier, 2010) or succumb under the many controversies.

### **1.1.2 Social Trend to Modern Farming**

Looking at the global issues that surround farming, we can see that all the above problems occur were because of interaction between farming and the natural environment. What if farmers were able to dictate the environment, I believed that all the problems and conspiracy above will no longer be valid. Despommier (2010) shows agreement that the trend to *protective cultivation* is increasing, credit to the constant problems posed by conventional farming.

Protected cultivation is a method to grow plants in an artificial environment where water, temperature, humidity, CO<sup>2</sup> concentration, nutrient concentration and factors that affect plants growth or behavior are all taken care of (Wittwer, S. H., & Castilla, N., 1995). Protected cultivation involved using both conventional and unconventional methods. Conventional techniques are basically soil-based planting– geponic. Unconventional technique involved soilless-based planting such as hydroponic and aeroponic methods (Shrestha A. & Dunn B., n.d).

In lights of recent research, ZFarming (Zero-acreage Farming) category was introduced where protected cultivation method is fully recognized in it (K Specht, R Siebert, I Hartmann, UB Freisinger, Magdalena S., Armin W., Sussane T., Dietrich H., Heike W., & Dierich A., 2014). Diagram 1 shows where ZFarming stands in the farming categories.

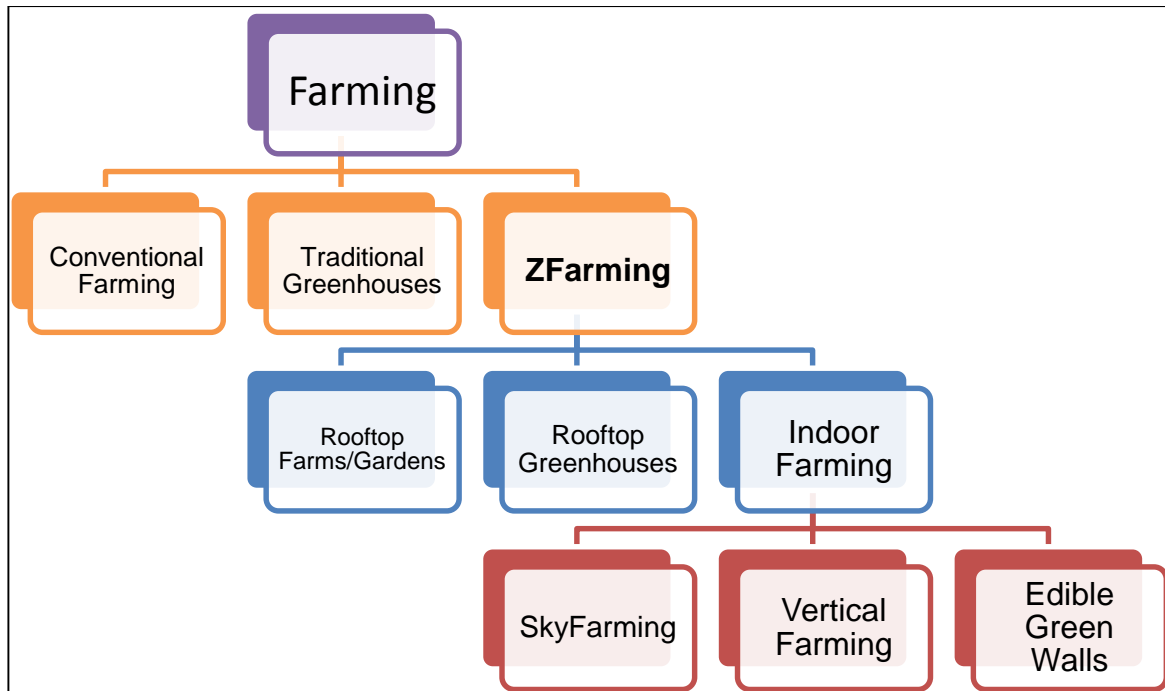

**Figure 1: Farming Categories**

On the other hand, the trend of urban farming is becoming common practice in large cities such as New York, London, Rotterdam, Detroit, Tokyo, Brooklyn, Montreal and Berlin (Boer J.D, 2013). In Brooklyn Grange, a rooftop farm operation, has sold over 18,143kg of vegetables to restaurants around it. Small paddy fields are cultivated on rooftops farms in Tokyo. Urban farming is more of a hype term couple with the ZFarming category where farmers who practice urban farming utilize concepts within the ZFarming category.

### **1.1.3 Vertical Farming Concept**

In a regular classroom activity, Professor Despommier asked his students in an attempt to feed the entire population of Manhattan by just farming within Manhattan itself back in 1999. When the usage of rooftop gardening failed to feed the entire population, the idea of ‘Vertical Farming’ was coined and was improvised and made into a concept until today. Vertical farm is a concept of constructing a skyscraper specifically for agricultural purposes with a closed-controlled environment where the building itself is a separate ecosystem just for farming and is detached from the outside ecosystem entirely (Despommier, 2010). Retro-fitting existing building with farming capabilities is not a

vertical farm concept. Despite that, vertical farming still adopts from modern farming techniques such as hydroponic, aeroponic and aquaculture with an exception that the entire building structure is tailored for such purpose.

The purpose of a vertical farm is to end the vicious process external sourcing for a city to thrive. The very reason for large scale farming operations all around the world is to be able to feed these jam-packed places full with human beings (Despommier, 2009). Although farming has brought humans to where they are now, things are already falling apart as we speak. A city such as Kuala Lumpur which house population of 1.6million as of 2012 (World Capital Institute, 2013) would need to consumed over *900 million kg* worth of food per year (Statistic Brain, 2013) where 60% of it comprises of carbohydrate (Malaysia Ministry of Health, 2013). Using conventional farming methods, only 20% in average of the optimal production yield rice can be achieved which is roughly 2343 kg of rice per 1 hectare of land depending on the species of the rice (Principal Statistics of Paddy and Rice by All Seasons Malaysia, 2010) In order to feed the entire population of Kuala Lumpur, we need about 9.5 times the size of Kuala Lumpur just to produce enough rice that is about 230, 473 hectares worth of land.

That is only a portion of the food production process where already tons of resources are required; the waste produced as a result of production and consumption has yet to be taken into account to. In recent news report, a total of 33,000 metric tons of rubbish is generated daily in Malaysia (Urban Wellbeing, Housing and Local Government, 2014) and about 6% of it is generated from Kuala Lumpur. This adds up to a yearly 730,000 metric tons of rubbish disposal just from Kuala Lumpur alone and with 90% of these waste dumped onto landfills (Urban Wellbeing, Housing and Local Government, 2014). In a general statement, cities are places which consumed a great amount of natural resources and do not know what to do with their waste appropriately. Vertical farming concept is aimed to correct this and make cities more like natural ecosystem where everything is can be recycle (Despommier, 2010).

The design of vertical farming concept came from the aims to achieve zero ecological footprints, power itself with renewable source of energy, achieving year round-crop

production, zero pesticides and herbicide usage, giving cities the ability to feed itself and on top of all that being sustainable for many years to come (Despommier, 2009). The design of an actual vertical farm is serious business where professional from all arenas are needed. Practical architectural designs with intelligent expert system (ES) are needed to maintain the conditions and environment within the vertical farm to be optimal for plant growth. A viable recycling system and renewable energy source is required to power the massive building to maintain its surrounding (The Economist, 2010). This concept is going to renovate the entire food industry as well as the world conventional farming practices.

#### **1.1.4 Controversies of Vertical Farming Concept**

While many embraced the idea, there were also many skeptics questioning the feasibility of the vertical farm economically and environmentally.

In terms of economic viability, can the production of a skyscraper worth of plants produce better or enough profit margin as compared to conventional farming methods (The Economist, 2010)? This question is resolved by a recent simulation of a 0.25 hectare wide at a height of 31 floors with 25 floors of plantation of various vegetables and fruits, 2 floors of fish production and others for climate control and germination areas (Banerjee C. & Adenaueer L., 2014). Under conventional assumptions, the vertical farm managed to produce food (fruits, vegetables and tilapia fish) per kg between €3.5 and €4.5 (between RM15.97 and RM18.25) (TheMoneyConverter.com, 23 May 2014). In a local market price analysis of Tesco food products shows an average market price of RM 17.78 per kg of similar food produced by the simulated vertical farm – assuming equivalent proportion of all production. This simple comparison shows that the current state of technology is capable of creating a small profit margin out from vertical farm products. In addition, due to weakening of Malaysia ringgit throughout 2013, the exchange rate resulted in an unfair judging value of comparison. Table 1 below show the current market prices of the food produced in the vertical farm (eshop.tesco.com.my, 23 May 2014).

**Table 1: Market Price of Various Vegetables, Fruits and Tilapia Fish**



<b>Food</b>	<b>Market Price per kg (RM/kg) – Not including promotional prices</b>
<b>Carrots T &amp; F Australia Carrots</b>	4.99
<b>Radish Green Radish</b>	6.99
<b>Potatoes Ubi Kentang (US Potatoes)</b>	3.19
<b>Tomatoes Grape Cherry Tomato (RM4.99/350g)</b>	14.26
<b>Pepper Yellow Capsicum</b>	16.99
<b>Strawberry Korean Strawberry (RM9.99/250g)</b>	39.96
<b>Peas Wattie’s Pick of the Crop Broad Beans (RM8.99/500g)</b>	17.98
<b>Cabbage Siew Pak Choy</b>	3.68
<b>Lettuce Genting Garden Baby Romaine (RM4.48/250g)</b>	17.92
<b>Spinach Green Spinach</b>	2.99
<b>Tilapia Fillet (RM9.99/150g)</b>	66.60
<b>Average Price Per Kg</b>	<b>RM 17.78 per kg</b>

\*Adopted from Tesco Eshop, 23 May 2014

In terms of environmental sustainability and zero ecological footprint, can a vertical farm only rely on renewable source of energy to power itself and not using conventional power as the electricity needed for a vertical farm is forecasted to be 100 times more than the conventional (Kanyama A.K. & Faist M., 2000)? There are many breakthroughs in better renewable energy performance. For example, in the wind energy scenario, the company Sheerwind’s INVELOX has shown promising ability to generate 280% or more electricity than traditional wind turbine generators could, with lesser cost, no noise pollution, zero disturbance to birds migration and able to work with low speed winds (<http://sheerwind.com/technology/faq-technology>, 2014) The simulated vertical farm by DLR Bremen requires a yearly energy of 3.5GWh in total to function properly Banerjee

C. & Adenaueer L., 2014). Traditionally one would need two 1.5MW turbines functioning at capacity factor of 22.5% (National Wind Watch, 2014) to power up the simulated vertical farm. Given the similar scenario, one INVELOX of 1.0MW turbine at 63% capacity factor (22.5% X 280%), can generate almost equivalent amount of electricity as the two traditional wind turbines. In terms of solar energy, the concentrated solar power technology seems very promising in its future prospect in electricity generation (Center For American Progress, 2013). At any rate, the power transmission lost due to transportation of electricity was not taken into account in this calculation. Nevertheless, the important point here is to highlight, significance improvement in the energy sector is progressing much faster than anticipated which is increasing the environmental feasibility of vertical farm.

## **1.2 Problem Statement**

Due to changing climate which result in unpredictable weather patterns, the exponential rise of human population and consumption of earth resources rate surpasses the replenishing rate has resulted that the world needs to dispose unsustainable conventional farming methods and turn to modern farming concepts such as vertical farming. Despite that, to manage an ecosystem inside a building would require many expert or at least an expert system which is lacking in the current market. The following of this section describes how severe each problem is.

### **1.2.1 Changing of Climate and Unpredictable Weather Patterns**

In the past few years, it can be observed that the climate pattern is becoming less and less predictable. Major cities are amongst the one taking the major beating from these occurrences. Back in June 2013, The Star once reported hazy and hot conditions have led to higher sales of air-conditioners and purifiers in Malaysia. This is a simple observable example of alteration in human behavior as a direct consequence of climate change. According to Hunt and Watkiss (2011), they have identified 5 major climate risks that cities are exposed to: which are sea-level rise, extreme events, health, energy use, and water availability. Out of five of these risks, extreme events and water availability are

major challenges to conventional farming methods. Extreme events such as droughts, heat-wave, wind-storms, and flood events make farming outdoor increasingly difficult, impairing food security in major cities (Hunt and Watkiss, 2011). Water availability risk includes decreasing source of water from underground and surface as result from reduced precipitation and increase usage of water as temperature increase further pushes the need to conserve water supplies (Hunt and Watkiss, 2011). These problems highlight the need of farming indoor with control and sustainable environment: as complete indoor farming use only 21% of world’s freshwater rather than 70% in conventional farming (Molden D. 2007).

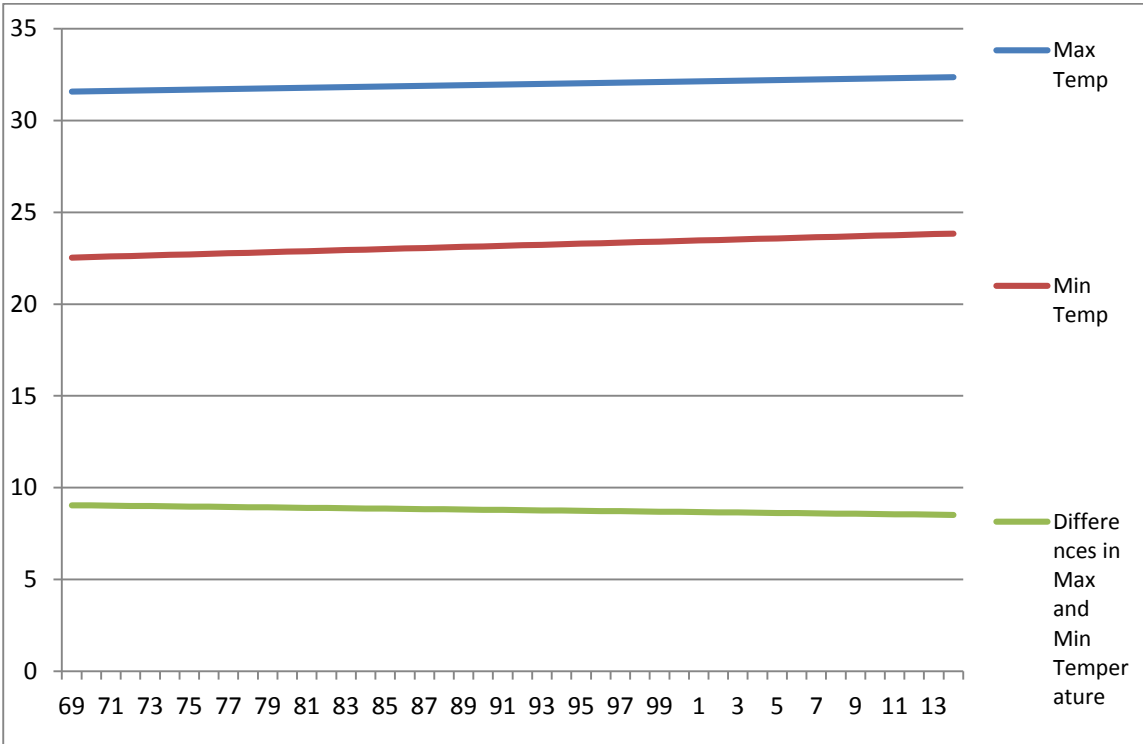

**Figure 2: Maximum and Minimum Temperature Trending in Malaysia (1969 until 2014)**

\*Adopted from: <http://www.met.gov.my/>

Aggregation of data between 1969 until 2011 from the Meteorological Department of Ministry of Science, Technology and Innovation (MOSTI) Malaysia, has shown a trend of rising of minimum and maximum temperature reached annually in the overall country

of Malaysia including Sabah and Sarawak. In terms of maximum temperature, a rise of close to 0.8 degree Celsius and as for minimum temperature the value is almost double with a rise of 1.3 degree Celsius. The gap between maximum and minimum temperature can be seen as closing together. The aggregation of data has diluted some effects of the imminent global warming trend in Malaysia but it has shown the overall warming trend of the country is going on a hike for temperature.

### **1.2.2 Rising of Human Population by 2050**

According to the UN, Department of Economic and Social Affairs Population Division, the human population is projected to rise to 9.6billion – 2050 from 7.2billion as of April, 2014 (<http://www.worldometers.info/world-population/>) given a medium fertility rate. Using conservative farming methods, new land equivalent to the size of Brazil is needed to be converted to agricultural land to feed the rising population not including the already 80% in used land for raising crops where 15% of it has been laid waste due to poor management practices (Despommier, 2009). This stresses the need of modern farming such as vertical farming concept to be in place in reducing land usage while ensuring food security and proper management.

### 1.2.3 Resource Consumption Rate > Resource Replenishing Rate

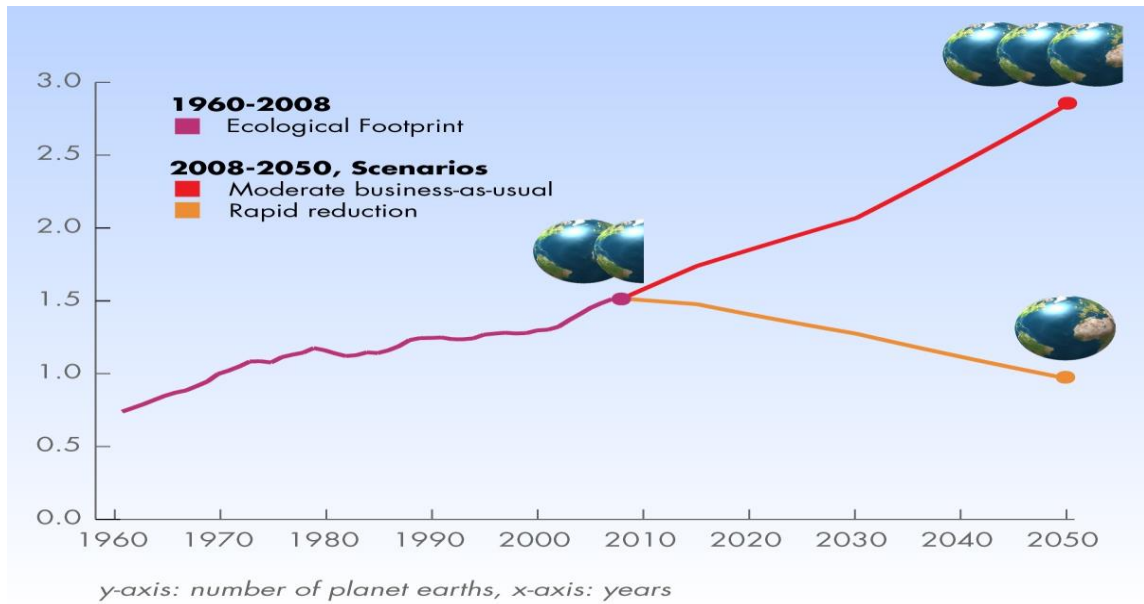

**Figure 3: World's Ecological Footprint by 2050 based on scenario**

\*Adopted from: [http://www.footprintnetwork.org/en/index.php/GFN/page/world\\_footprint/](http://www.footprintnetwork.org/en/index.php/GFN/page/world_footprint/)

It is forecasted by Global Footprint Network that given the case scenario that no change in course of our practices will lead us to consuming three times faster Earth's resources than Earth could ever replenish. In short, we will need at least 3 Earths to continue our practices. This is attributable to the unsustainable practices where resources used are not replaced – e.g. petroleum, land and waste generated are not recycle – e.g. rubbish, carbon emission from cities. There is no cyclic behavior observable from these conventional practices as seen in natural ecosystem, where nothing goes to waste and everything serve its purpose to maintain the ecosystem in a closed cycle system (Despommier, 2009).

Realizing the fact that global warming is no longer a debated issue and the world needs to take green initiative, Malaysia is not far behind. In the 10<sup>th</sup> Malaysian Plan, the government has emphasized through various platforms such as Green Technology Financing Scheme to facilitate, support and finance green projects. This is to support conservation of the natural environment of Malaysia, substantially reducing greenhouse

gas emissions, improve living conditions for all forms of life and promoting the usage of renewable source of energy.

#### **1.2.4 Lack of Commercial ES in the Market**

In order for a vertical farming system to work, it needs an ES to guide all its asset to provide optimum conditions for plants to thrive in. Based on initial observation of market, there are many systems on the market used to assist greenhouse operations and urban farming, but there is not one ES sold commercially in the market. According to Concise Oxford English Dictionary, ES is software that utilizes databases of expert knowledge to make decisions. Small scale modern farming automation products such as Purgro (Grobot Evolution) and Grohause Automation (Hydroid™) offers a great variety of features as shown in Table 2 but yet it is not an ES as it relies on the expertise of the user. Greenhouse companies such as Westvroom Greenhouse Systems Ltd and Netafim which specialized in building large-scale greenhouses are still relying on expert or user themselves in determining the optimal conditions for their plants to grow. To further illustrate the lacking trait of an ES, let's say if a user wants to grow a tomato plant in a conventional greenhouse, the user need to search online or find an expert to determine the best conditions that he/she has to set for the system. If it was an ES, the user merely has to click on the system for 'tomato option' and the system will automatically configure itself to the required conditions to grow the plant without the need of consulting an expert in the first place.

**Table 2: Comparison of Purgro (Grobot Evolution) and Grohaus (Hydroid™)**

<b>Purgro (Grobot Evolution)</b>	<b>Features</b>	<b>Grohaus (Hydroid™)</b>
<b>Yes</b>	Nutrients Concentration	Yes
<b>Yes</b>	Nutrient pH	Yes
<b>Yes</b>	Water Temperature	Yes
<b>Yes</b>	Water Level	Yes
<b>Yes</b>	Air Temperature	Yes
<b>Yes</b>	Humidity	Yes
<b>Yes</b>	CO2 concentration	Yes
<b>Yes</b>	Lighting	Yes
<b>Yes</b>	Alarm	Yes
<b>Yes</b>	Text Message/ Email	Yes
<b>Yes</b>	Webcam	No
<b>Yes</b>	Real-Time Monitoring	Yes
<b>No</b>	Real-Time Adjustment	Yes

\*Adapted from: Combination of <http://www.purgro.com/grobot.html> and <http://www.grohaus-automation.com/>

Lack of Commercial ES in the Market – justify that ES is vital to control plants as not everyone is an expert in growing plants; an adaptable and learning system can make farming much easier, hence becoming the primary objective of this research project.

### **1.3 Objectives and Scope of Study**

This scope of this project is project is confined in producing an ES to imitate experts' knowledge in handling one type of plant in a simplified 3 storeys vertical farm utilizing the hydroponic system. This project aims to create a guide of a working system for people with limited budget and experience. A significance of this research is to becoming a stepping stone to codified collection of expert knowledge about plants and converts it into ES for the world to use. The scope of the study does not only limit itself to the concept of vertical farming but open as well to other modern farming such as greenhouses and skyfarming. However, vertical farming concept would be the main influencer of the comings of this research. The concerned of this project will be applying the speaking plant approach and fuzzy logic to perform the validation.

There are two phases in this project and several objectives for this project as listed as the following:

1. Phase 1 – Collection and categorizing experts’ knowledge
  - a. To identify and interview the experts in the field of modern agricultural methods such as hydroponics.
  - b. Identifying the set of facts, rules and principles of experts applied in growing a specific plant. In the events that expert is unavailable, secondary data from various sources will be compiled and compared to form expert aggregate.
  - c. Converting these facts, rules and principles into a set of fuzzy logic to be read by an ES.
2. Phase 2 – Construction and testing of the overall feasibility and functionality of the vertical farm system.
  - a. Vertical Farm Structure: Construct 3 storey simplified version of vertical farm that uses hydroponic system with pH, temperature, humidity and water level control.
  - b. Expert System:
    - i. Manual Configuration: Manually configure living conditions variable for plants
    - ii. Auto Configuration: Automatically configure living conditions variable for plants through minimal knowledge of the plant itself.
  - c. Electrical Circuit Board Design: Modifying and testing different sensors & tools to achieve accurate reading and functionalities



## **CHAPTER 2:**

### **LITERATURE REVIEW**

#### **2. Literature Review**

Chapter 2 features a narrow focus on the scope of previous researches done in ES using fuzzy logic. This chapter is inclusive of terminology definition, previous work and identifies the gap between current research and vertical farm concept.

##### **2.1 Terminologies Definition**

**Hydroponic system** is simply growing plants in a liquid nutrient solution with or without the use of artificial media such as clay balls, perlite or coconut coir (Shrestha A. & Dunn B., n.d). Aeroponics is a type of hydroponic system where roots of the plant is fully exposed in air – without clinging on any artificial media and water is sprayed to these roots in an enclosed area (Oxford Dictionaries). Geoponic on the other hand, is the typical soil-based planting that is commonly used in traditional farming (Merriam-Webster). Table 3 shows the comparison between the three systems used in farming.

**Table 3: Comparison of Hydroponic, Aeroponic and Geoponic**

Soil vs Hydroponic vs Aeroponic	Geoponic	Hydroponic	Aeroponic
Uses soil	Yes	No	No
Uses other medium to hold plants (coconut husk, rock wool, gravels)	No	Yes	No
Expose to soil disease (crown gall, take-all disease of wheat, etc)	Yes	No	No
Crop Yield	Fair	High	High
Weeding or cultivation	Yes	No	No
Lifting crops from ground (Lettuce, Strawberries)	Hard	Easy	Easy
Crop Rotation (Maintain fertility)	Yes	No	No
Control in PH, nutrient and growing environment	Difficult	Easy	Easy
Growth Rate of Plant	Slow	Fast	Fastest
Recycling of nutrient	X	Possible	Possible
Initial & Operational Cost	Low	High	Highest
Skill and Expertise	Low	Moderate	High

\*Adapted from: <http://osufacts.okstate.edu/docushare/dsweb/Get/Document-6839/HLA-6442web.pdf>, <http://jpkc.scau.edu.cn/soilless/papers/upload/2012102820544066367.pdf>, <http://www.soilhealth.com/soils-are-alive/how-do-soil-organisms-affect-plants/p-04.htm>

**Expert System (ES)** as previously defined in background of study is software that utilizes database of expert knowledge to make decisions. In this research, the ES is referring to the software that controls growth environment of the simplified hydroponic system using codified experts' knowledge.

Meriam-Webster defined **fuzzy logic** in which statements are not just true or false but rather any continuum of values in between 0 to 1. For example, it is hard to determine hot or cold given the linguistic context. This is because hot or cold is very different in the

minds of different people. A person from the North Pole may regard weather in Mediterranean areas as hot while a person from Malaysia would regard it as cold. Fuzzy logic enables scientist to uncover the range of values that a plant would regard as optimum while other as either too much or too little. The flexibility that fuzzy set theory provides as opposed to ‘classical set theory’ is that fuzzy logic allows partial membership where a set can simultaneously belong to two set (Chen, G., & Pham, T. T., 2000). In a conventional classical set theory there can be only two categories (cases) in which for example a person can only be old or young, while in fuzzy set logic more than two categories can exist between both extreme ends that is between 0 to 120 years old. In an attempt to reducing the fuzziness of the logic, one can make multiple categories of age such as ‘infant’, ‘child’, ‘teenager’, ‘young adult’, ‘adult’ and ‘elderly’ which resembles more of an extended version of a classical set theory. The importance of the logic is enabling one to measure the degrees of a certain trait such as oldness and hotness without compromising the ability to categorize logic accurately – which highly depends on experience, research and knowledge the person has.

It takes years of experience and intuition from skilled growers to realize what is best for their plants and these information is used to communicate to their future crops to enable the best productivity. **Speaking Plant Approach (SPA)** is an approach to use sensors to monitor the plants and in return, these input variables are used to control the output variables such as the growth and fruit yield of the plants (Hashimoto, Y., Morimoto, T., & De Baerdemaeker, J., 2006). SPA is highly coupled with fuzzy logic as the identified variables are often in the form of range and belonging to more than one group.

## 2.2 Previous Work

There are a total of 11 different methodologies in constructing an ES which are rule-based systems, knowledge based-systems, neural networks, fuzzy ESs, object-oriented methodology, case-based reasoning, system architecture, intelligent agent systems, database methodology, modeling and ontology applied different disciplinary and their problem domain (Shu-Hsien, L. , 2005). Shu made a good point regarding development of ES was much triggered by the need of problem solving of experts within their field. This aligns with the trigger of this research in using Fuzzy Logic methodology in ES as an attempt to enable possibility of vertical farms and ultimately overcome food security issues. Fuzzy Logic ES is one of the most commonly applied systems to control greenhouse operations such as disease control, crop management, seedling management and disease identification. (Kolokotsa, D., Saridakis, G., Dalamagkidis, K., Dolianitis, S., & Kaliakatsos, I. , 2010)( Ke, S.-k., Ding, M., Li, L., Niu, Q.-l., & Huang, D.-f. , 2012)( He, H., & Xue, H. ,2012)( Sørensen, J., Jørgensen, B., Klein, M., & Demazeau, Y., 2011)( Wang, F., Mei, L., Feng, W., Wang, L., Wang, L., & Ruan, H., 2013)( Sharma, J. S., & Makwana, G. D. , 2013).

**Table 4: Review of Related Literature in Setting up and Improving Greenhouse Application**

No. (Year)	Problem(s) to Solve	Program ming Language + Platform	Methodology & Approach	Usefulness of Research	Drawback/ Suggestion for Research
1 (2010)	Indoor Environment and Energy Management System for Greenhouses (Kolokotsa, D., et al. , 2010)	Neuron C + TRNSYS environme nt, LonWorks network	Fuzzy Logic Controllers	System is intelligent enough to optimize environment despite insufficient equipment in greenhouses.	Involves complex network and programming

<p><b>2 (2014)</b></p>	<p>Simplify integrated control for protected cultivation (Iliev, O. L., Sazdov, P., &amp; Zakeri, A., 2014)</p>	<p>Not mentioned</p>	<p>Fuzzy Control</p>	<p>Linguistically identified 5 important variables for optimal plant climate growth control (temperature, air relative humidity, lighting, Irrigation + nutrient solution and CO2) through percentage (0-100%) division of those attributes. Proved that fuzzy-based control system is much more advantage than traditional control system in terms of accuracy in measuring)</p>	<p>Did not take into account different stages of crop growth and crop variation.</p>
----------------------------	---	----------------------	----------------------	---	--

<p><b>3</b> <b>(1996)</b></p>	<p>Nutrient concentration controller for a plant through the entire growth stage. (Morimoto, T., Hatou, K., &amp; Hashimoto, Y., 1996)</p>	<p>Not mentioned</p>	<p>SPA, growth optimization (genetic algorithm and neural networks)</p>	<p>Able to prove through measuring of total leaf length and stem diameter is maximized during initial seedling growth stage. The ES was performing better than a skilled grower monitoring the nutrient himself/herself.</p>	<p>Dated back since 1996, some information could be irrelevant especially in terms of technological advancement where CPU processor speed and memory is much better than in the past.</p>
<p><b>4</b> <b>(2012)</b></p>	<p>Difficulty in establishing an accurate mathematical model hinders the accuracy of greenhouse ES in controlling greenhouse environment which result in increasing energy consumption. (He, H., &amp; Xue, H. ,2012)</p>	<p>Not mentioned</p>	<p>Fuzzy Control, variable universe, BP neural network</p>	<p>Maintaining greenhouses required enormous amount of energy and inefficiency would double or triple the energy requirement. The BP neural network acts as a filter for the fuzzy controller as to not get overloaded from data of sensor – that most probably is delayed or in a different universe (sensitivity)</p>	<p>The proposed idea maintains the rules practice in ES and introducing the filter to overcome issue of changing universe (sensitivity) of data. Despite that, it did not take into account to identify the</p>

					real-time needed in changing of universe (which can further increase the system accuracy).
<b>5 (2011)</b>	Disregarding conflict between two or more different greenhouses climate control system to enable cohesion in making control decisions through negotiations. (Sørensen, J., et al., 2011)	Not mentioned	Multi-agent approach	Treating each climate control feature as a separate agent. By appointing a trusted negotiator for all climate control features (agents), the negotiator can act as an evaluator of each proposed solution from different agents and forming a best solution using values between (weighted outcomes between value 0-1) within certain amount of time. The approach demonstrates an ability of the negotiator trying to reach a win-win situation for all sensors objectives as	This research addressed mostly problems arise in four seasons countries which is not too much of an issue for countries around the equator. On the other hand, accurate and able to be evaluate characteristics should be identified, defined, properly structured and given appropriate weightage to make this



				contrast to the overall mission of the system.	negotiator work. The negotiator is not an optimizer but rather a satisfier of available information given by agents.
<b>6 (2013)</b>	Slow down and delay multi-input/multi-output of system and sensors due to non-linear and difficult in creating mathematical model for greenhouses making it difficult to create classical control methods. (Wang, F., et al., 2013)	Wave, KeilC7.01, Labtool 48 + W77E58 environment	MPT algorithm, Fuzzy Logic	Shows that by adding MPT intelligence, a regular PID algorithm can be enhance with new abilities (self-adapting, fuzzy control, expert self-tuning etc). Actual results shows that greenhouse become better at saving energy through optimizing usage of external environment to match with internal needs of greenhouses.	Potentially merge with negotiator as mentioned in research No.5 to detect the delay from MIMO of system, thus increasing the accuracy.

<p><b>7</b> <b>(2013)</b></p>	<p>Reducing the reliance of physical presence of experts in configuring different greenhouses setting such as temperature, humidity, CO2 concentration, nutrient etc. (Sharma, J. S., &amp; Makwana, G. D. , 2013)</p>	<p>Not mentioned</p>	<p>Not applicable</p>	<p>Provided a generic architecture that allows people to further work on it in the development of reconfiguring greenhouses from long range using GSM.</p>	<p>Results are merely simulated, actual testing in the field is required to further identified and tackle obstacles and issues that would surfaced.</p>
<p><b>8</b> <b>(2004)</b></p>	<p>Making a learning robot that can explore and identify new obstacle and overcoming them using multi-objective Self-Exploration process based Intelligent Control</p>	<p>Not mentioned</p>	<p>Fuzzy neural network, multi-objective genetic algorithm</p>	<p>mSEICS allows robots to learn and improvise without the need to hard-code solution for them. Although the field are robotics appear irrelevant to the expert system field of agriculture, such learning capability is vital to help learn the optimal growing</p>	<p>Can extend mSEICS in expert system in the field of agriculture such as greenhouses and vertical farming.</p>

	System—mSEICS (Chen, L.-H., & Chiang, C.-H., 2004)			conditions for a plant without relying solely on experts where the system will improvise and optimizing growth condition better than before.	
--	--	--	--	--	--

## 2.3 Research Gap

Much research has been done to optimized and improved greenhouses operations but none applied for vertical farm concept. Even though, vertical farm concept closely resembles much of the greenhouse concept, the main distinction between them is the architectural design of multiple storeys. In simple words, vertical farm can be seen as multiple greenhouses stacking up in a tall building. Even so, managing multiple storeys would also mean stacking up the complexity of the system (Despommier, 2010).

To create an optimum environment for plants to thrive there are many variables that need to be factored in for example temperature, air relative humidity, lighting, the content of nutrient solution (pH and concentration) and CO<sub>2</sub>. In an attempt to compare between traditional greenhouse control system and a fuzzy based control system, the fuzzy based control system outperform by able to give more accurate output (decisions) from relative non-linear sensor data (Iliev, O. L., Sazdov, P., & Zakeri, A., 2014). Fuzzy logic can be considered as the best, famous and current method to optimized climate in greenhouses. Often these information from sensors come together at real-time and decision has to make for several equipment to take place making it a multi-input and multi-output (MIMO) situation. In a breakthrough experimental analysis, Wang F., et al (2013) has identified that by adding MPT intelligence in traditional PID algorithm (which is the formula to make decision for greenhouses to change or maintain its climate) can improve the speed of fuzzy control, expert self-tuning and self adapting control functions of the overall system. Often as well, a greenhouse may not have all the equipment it needs for environment control, climate control system have to be smart enough to make decisions on its own in seeking out other methods such as using external factors to its advantage to maintain the greenhouse environment (Kolokotsa, D., et al. , 2010). As a vertical farm concept involves multiple levels, to maintain equilibrium benefits in term of energy consumption against growth rate of the plant for all the levels, it is necessary for different climate control systems to interact with each other to make optimum environment control decisions on all floors. Conflict can easily arise from such matter and to remedy such

situation a negotiator can be introduced to ‘negotiate’ win-win situation through numbers by evaluating each solution proposed by each agent (Sorenson, J., et al, 2013).

A good greenhouse expert system should be able to:

- Detect 5 important variables that dictate optimum environment for crop growth (temperature, air relative humidity, lighting, the content of nutrient solution (pH and concentration) and CO<sub>2</sub>).
- Minimal overshooting or undershooting from decision made from data collected from sensors by making quick decisions (the lesser the delay, the more accurate it is)
- Able to handle conflicting scenarios
- Minimal reliance to expert
- Able to optimize environment despite incomplete equipment through compensation from external environment factor
- Intelligently optimize energy control for all five variables with minimal wastage.

All these criteria should be included in the development of a vertical farm as the only obstacle preventing the construction of a vertical farm is money resulted from huge energy consumption. All these improvement seen in research of greenhouses is tipping of the money obstacle of vertical farm concept brick by brick as the passage of time flows.

## **CHAPTER 3:**

### **METHODOLOGY**

#### **3. Methodology**

As developing an expert system requires development of two different aspects: the knowledge engineering – system hardware and software engineering, there is a need to have a proper work flow to synchronize these two approaches (Abdelhamid, Y., Hassan, H., & Rafea, A., 1997). This research will be adapting the methodology developed by the Central Laboratory for Agricultural Expert Systems (CLAES) through many years of practical development experiences in building expert systems. The following will highlight the knowledge engineering methodology, software engineering methodology, ES evaluation, overall ES development life cycle and key project activities.

### 3.1 ES Development Life Cycle

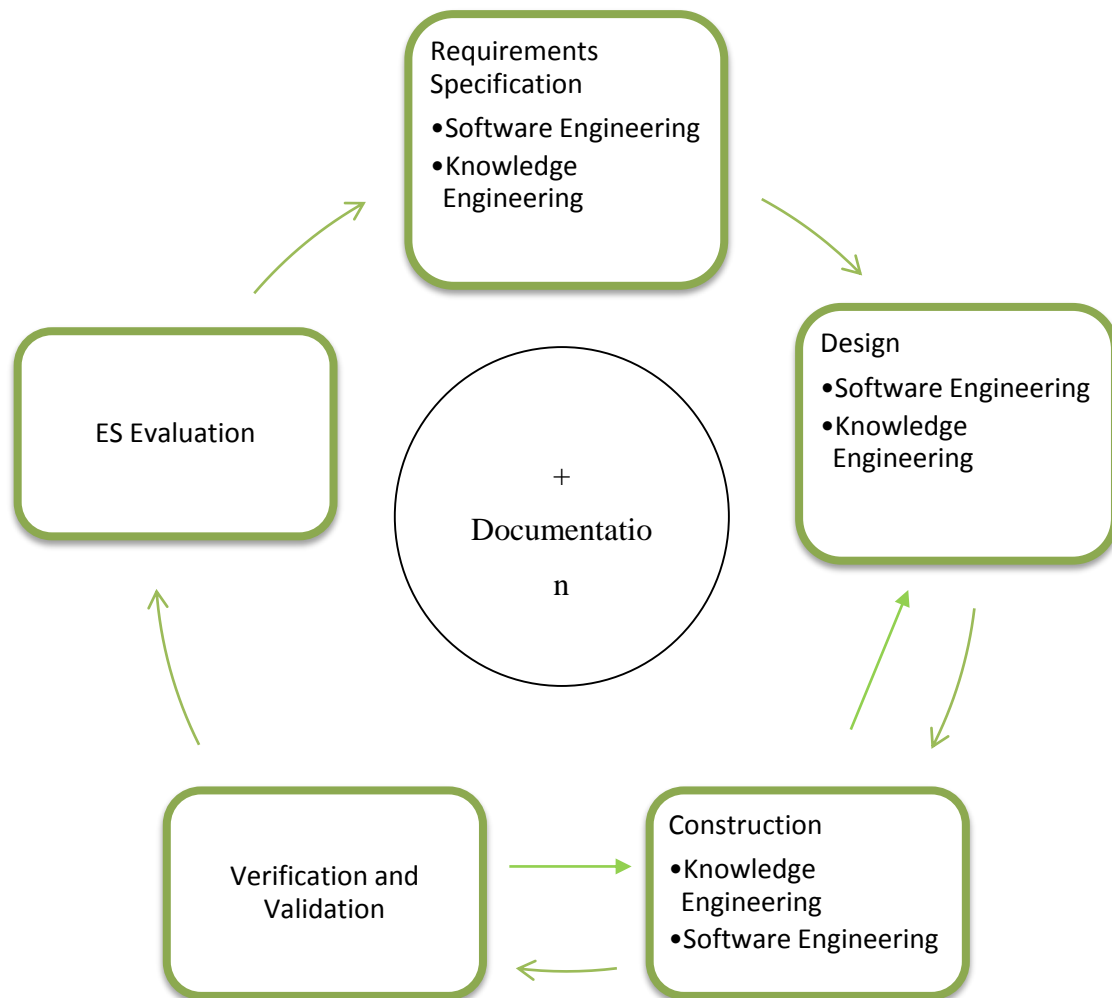

**Figure 4: Adopted Expert System Development Life Cycle from CLAES**

The development of ES will begin with requirement specification which would adopt the techniques from **requirements engineering** by **Pohl K. & Rupp C. (2011)**. As the requirements are finalized, development – design hardware and the software part would take place simultaneously. As both designs are completed, the construction of hardware (knowledge engineering) would begin first until a functional prototype is achieved (readily to be installed with software system). Upon completion, a rapid prototyping of the software would take place until at least a laboratory prototype is achieved which is the second stage of software completion before actual field testing

**can be done** (Abdelhamid, Y., Hassan, H., & Rafea, A., 1997). During that period, the construction and design phase would go back and forth until verification and validation reports are showing satisfactory results. When both components reach satisfactory stage, we moved on to ES evaluation, where the prototype expert system can now be tested as a whole by verification of its functionality and validation through specific cases. The last part of the project would involve evaluation of ES by actual expert through quantitative and qualitative criteria that are described in detailed in the subsequent project activities.

In addition, as the system potential relies heavily from what is extracted from experts, the criteria selection of expert is very important. Despite so, there is only one identified criteria to be an expertise that the person would have at least 5 years of experience working in the field of agriculture (specifically managing greenhouses, technician of a hydroponic system facility, researcher who did such experiment etc). If the system is successfully deployed, ES maintenance must be carried out to discover and solve bugs and problems that may arise and add in latest update for the system to keep its functionality to the most current.

As the system has more than five variables to observe and manipulate, the development life cycle will be applied to one variable at one time. In other words, Steps 3.2 to 3.4 will be repeated for each variable at one time. Due to time constraint, completion of temperature will be given priority above other variables (lighting, water, CO<sub>2</sub> concentration and relative humidity).

## 3.2 Knowledge Engineering Methodology

In this section, the activities mentioned are aligned to the mentioned ES Development Life Cycle.

### 1. Requirement Specification: Knowledge Acquisition

- Requirements are extracted from experts, and other means as defined in requirements engineering by Pohl and Rupp (2011). Please refer appendix



on 'Interview Questions' for better understanding what knowledge is extracted from experts.

## 2. Design + Construction: Knowledge Modeling Steps

- Due to limited knowledge in the field of electrical and electronic as well as time limit, a predefined and tested model is selected. The design of the hardware would be adapted from an online Arduino hydroponic system design called Billie's Hydroponic Controller. Please refer this link <http://forum.arduino.cc/index.php?topic=130344.0>, for the base of the ES electronic board design.
- However, the architectural of the project design would be a simplistic miniature 3 storeys building that resembles vertical farm. Please refer appendix for 'ES architectural design'.

## 3. Verification and Validation: Knowledge Verification

- To ensure safety, validation and verification, students from the Electrical and Electronic faculty would be invited to review the procedure done. As several people are doing review, there will bound to be some disagreement, any conflict arise would be treated as more reliable knowledge (Abdelhamid, Y., Hassan, H., & Rafea, A., 1997) and if no agreement can be reach, the argument of the more credible in his/her given field is given higher priority.

### 3.3 Software Engineering Methodology

In the software engineering methodology, the rapid prototyping is adopted. As the hardware is fully design, the software prototype would be immediately put on trial with the constructed hardware. However, before doing the trial, the following shows the flow of activities in software engineering in parallel with ES Development Life Cycle.

#### 1. Requirement Specification: Requirement Engineering

- Requirements are extracted from experts, and other means as defined in requirements engineering by Pohl and Rupp (2011). Please refer appendix

on 'Interview Questions' for better understanding what knowledge is extracted from experts. Unclear requirements would be resolved by attempting to communicate with interviewed experts for clarification.

2. Design: Design (Abdelhamid, Y., Hassan, H., & Rafea, A., 1997)

- The design of the system encapsulates the UML, outlook of the interfaces, and functionality of each module. Please refer appendix for the UML diagrams, interface designs and identified functionality of each module.

3. Construction: Rapid Prototypes

- As Rapid Prototyping is adopted, the design of the software is divided into three stages
  - i. Initial stage – throw away prototype is design to outline the skeletal frame of the to be built system
  - ii. Interim stage – laboratory prototype is design after receiving knowledge from prospective users and experts.
  - iii. Final Stage – field prototype is constructed as a result from laboratory prototype feedback. (This stage is most likely not carried out due to lack of time, the project would be using the laboratory prototype as the final design for this research)
- However, the architectural of the project design would be a simplistic miniature 3 storeys building that resembles vertical farm. Please refer appendix for architectural design.

4. Verification and Validation: Verification and Validation

- Verification: Each software module would have its functionality tested and check whether it is functioning the way it is supposed to.
- Validation: Each software module is tested with a certain case and check the response of the software module is appropriate or not with it.
- Please refer appendix for the concise explanation 'verification and validation process for module stage'.

### 3.4 ES Evaluation

As the final phase of the research, the completed ES in both hardware and software components would be again go through verification and validation by the developer before final evaluation by experts.

1. Verification - The whole system would be tested as a whole and whether the functionality developed has fulfilled all the objectives of this project. A **verification report** would be generated at this stage.
2. Validation - The system would be given a full case and run its full course. For example, growing an actual plant in the system and measure the outcome (such as total leaf length and diameter of stem) and compared it with poor, regular, and best results. The following table shows an example of how **validation report** would look like.

Results	Size	Quality	Total Score
Poor			
Regular			
Best			
Prototype ES			

3. Evaluation – The final process of the ES Development Life Cycle. To consider an appropriate evaluation both qualitative and quantitative scores must be taken into consideration. As the main idea of evaluation is to compare experts’ behavior against the expert system’s behavior. To do this, a collection of carefully selected test cases are given to a group of experts. The experts will then generate solution of their own and in turn discuss it openly and rank it. Justification is made during the discussion and final ranking may change subject to degree of evaluation criteria is modified based on the discussion made. The following step by step evaluation process is adopted from Abdelhamid, Y., Hassan, H., & Rafea, A. (1997).
  - i. Prepare Case Description Forms
  - ii. Prepare comparison criteria
  - iii. Generate test cases (covering normal, difficult and rare cases)

- iv. Solving test cases (Let expert system and expert try solving)
- v. Evaluation of test cases (Done blindly where one cannot distinguish the difference between decision made by expert system and the expert themselves)
- vi. Ranking of results from comparison criteria scores
- vii. Observation and Remarks (Discussion of the ranking results and arriving final conclusion for the expert system)
- viii. Updating knowledge and implementation (remarks and improvements are added to the expert system)
- ix. Documentation (clear and detailed report for each evaluation process for future reference)

## **CHAPTER 4:**

### **RESULTS AND DISCUSSIONS**

#### **4. Results and Discussions**

The results of this project were collected in two phases. The first phase is collection and categorizing expert's knowledge. In this phase, both tacit (experience) and explicit (written) knowledge were extracted. Tacit knowledge were extracted through a form of interview with two officers of RISDA (Rubber Industry Smallholders' Development Authority). Explicit knowledge were in the form of software and programming knowledge harness from the internet: Billy's hydroponic. The second phase which is the constructing and testing of the overall vertical farm system of the project is further divided into three sections the electrical circuit board design, the vertical farm structure and expert system.

#### **4.1 Phase 1: Collection and Categorizing**

##### **4.1.1 Interview with RISDA Officers (Tacit)**

The objective of the interview was to collect information about how small farmers are performing in the current economy of Malaysia. Two different interviews were conducted with officers of RISDA, Encik Abdul Razak – Pegawai Stesen Bota RISDA and Encik Bakhtiar Riduan – Pegawai RISDA Daerah Perak Tengah/ Kinta.

Based on the interview done, the two primary concerns of the smallholder's plantation were old age factor and low commodity prices – particularly rubber. In the country wide census data collected in 2013 by Bahagian Dasar dan Perancangan Strategik (Corporate Policy and Strategic Planning Division, 9 June 2014) regarding smallholder of plantation type rubber and oil palm, the average age of plantation owners was close to 57 years old

which is beyond the average retirement age of a normal Malaysian. On top of that, more than 89% of the small plantation owners have salary below RM 2500. This was arguably due to the extreme low prices of commodities like rubber. Rubber commodity is sold in two forms, dry mass (latex) and the wet mass (Cuplump). A tree could roughly produce 35g to 45g of dry mass per day or 56g at minimal of wet mass. The commodity prices of today's masses are RM1.70 to RM2.20 per Kg for wet mass and RM4.80 to RM5.30 per Kg for dry mass. These commodity used to fetch three times the current price a few years back, where rubber deemed as a profitable business. Mr. Abdul Razak stress that the sharp drop of rubber price is because of increasing rubber supplies from other countries and dropping price of synthetic rubber comparable to real rubber. Consequently, this less profitable industry has force younger generation to search for better pay alternative by working in cities or taking up several part-time jobs besides farming. Evidently, the low commodity prices lead to increasing age of work force in the smallholder plantation society.

As the one of the mission of RISDA is to improve the earnings of rubber plantation smallholders per family to RM 2,500. To achieve this, RISDA provides free fertilizers, new seedlings to replace old rubber trees, tree planting aid and optimum rubber tree cutting methods to help rubber plantation smallholders to maximize their rubber extraction yield. Besides that, rubber plantation smallholders are encourage to conduct “ekonomi tambahan”, added value economy activities such as growing vegetables, mushrooms expensive herbs (e.g. Misai Kuching), practicing modern agriculture techniques (e.g. fertigation) to help reaching the goal of RM 2,500 per household. To make value economy activities deem more feasible and achievable, RISDA through government allocation is able to provide some one-off RM 500 monetary aid for all and a handful of potential farmers per district to get sponsor of RM 10,000. These allocation and aids from the government reduces the financial burden of smallholders in exchange hoping they become self-sustaining and becoming less reliance to the government.

Based on the overall interview it is established that there is a need for advance agriculture system such as vertical farming to help play a role in assisting rubber plantation smallholders to increase their earnings possibly through “ekonomi tambahan” activities.

### **4.1.2 Billy's Hydroponic (Explicit)**

Given the concept of vertical farming is still very much at its infant stage, documentation of a working and feasible vertical farming system was not vastly available, mostly restricted and those that are available much of it is limited to concepts rather than actual practices. On top of that, real-life experts were difficult to locate and the difference in language makes it incomprehensible for all. On the other hand, documentation of greenhouses and modern farming techniques such as hydroponic and aeroponic were friendlier and easily available on the internet. One such is Billy's Hydroponic where an entire working home-made hydroponic system was developed and documented in an internet forum. In the forum itself, full running codes and circuit designs were available at hand for reference. These explicit knowledge were extracted and modified into a prototype vertical farm system. Detailed results of this adaptation is explain in Phase 2.

## **4.2 Phase 2: Constructing and Testing of the Overall Vertical Farm System**

Due to complexity of the project and limited amount of time, phase 2 results are only laboratory tested and yet to be field tested. The performance of the vertical farm system are done in controlled circumstances and may differ when in actual usage. This section has three different development frontier and three different results.

### **4.2.1 Electrical Circuit Board Design**

The circuit board is design following the Speaking Plant Approach, where the plants living environment is monitored near to real-time to enable immediate actions to rectify any problems. The circuit board is capable of sensing temperature, humidity and light intensity (lux). Yet to developed: sensors for water level, CO<sub>2</sub> concentration, pH, and nutrient concentration, and controller for temperature, humidity, light intensity, CO<sub>2</sub> concentration, pH, water level and nutrient concentration. The following figure shows the arrangement of the circuit board:

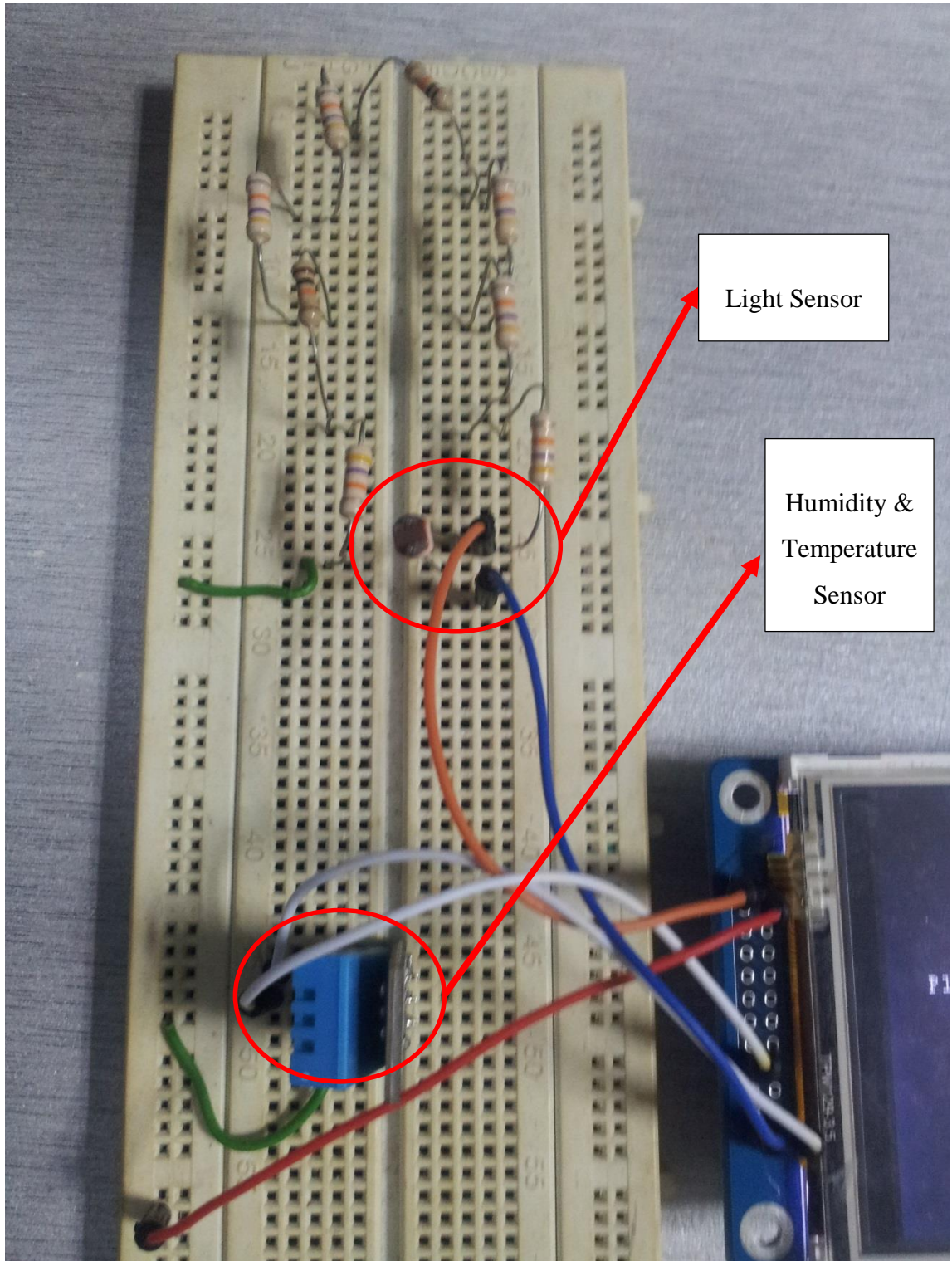
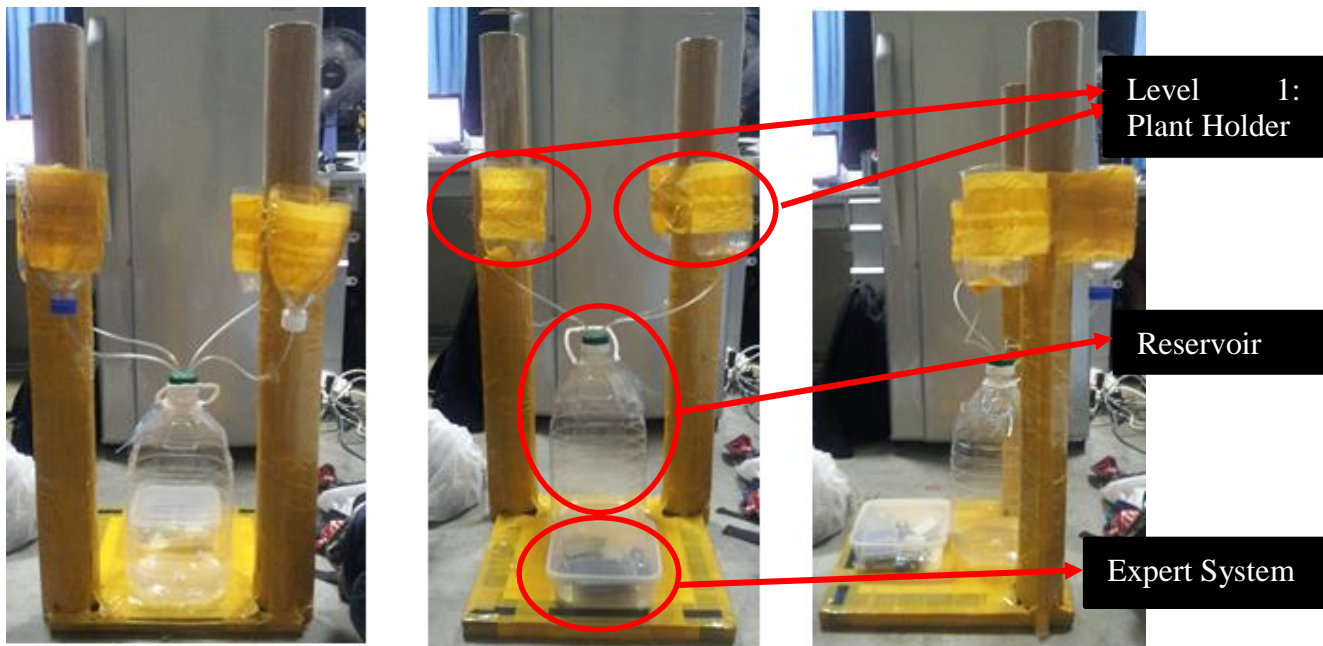

**Figure 5: Vertical Farm System Electrical Circuit Board Design Draft**



## 4.2.2 Vertical Farm Structure

The figure below is showing the constructed vertical farm structure with only ONE level. The vertical farm structure has a capacity of catering four plants at one time. In future extension, the farm should be able to handle twelve plants at one time.



**Figure 6: Vertical Farm Structure (ONE Level)**

## 4.2.3 Expert System

The expert system which is the core intelligence that operates the vertical farm system is constructed using C++ and applying the theory of fuzzy logic. The expert system is programmed into a microcontroller, Arduino Uno. The system is divided into two operating processes: manual or automatic configuration. Manual configuration is only able to perform display for now. Codes of this display can be seen in No actual actuators are being developed. [For future development] In the automatic configuration, the system will prompt user the type of plants, the growing phase and when the plant started growing. Given these input the system would go through its expert's knowledge database (yet to be developed) and identify the optimum temperature, CO<sub>2</sub> concentration, nutrients

concentration, moisture level, pH range and amount of light (measure in lux) needed for the plants to grow optimally. In the manual configuration, user are able to overwrite the system to set the environment conditions. The system has an external timer to keep track of time even in the events where there is loss of electricity occur to allow the system come back and trace back to how much time it has lost in an attempt to remedy the situation. The system is also capable of alerting users when abnormally occurs such as pH range is not within range for more than 5 minutes, CO2 concentration unable to reach its level, empty water tank and etc. Below are some images of how the overall system looks like:



Main Page

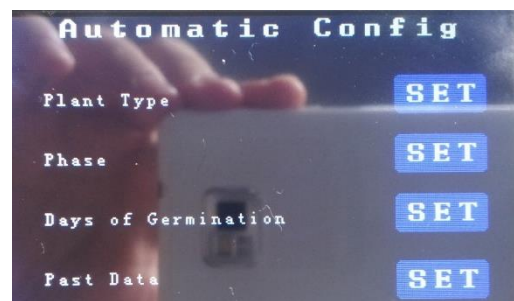

Automatic Configuration (Yet to be developed)

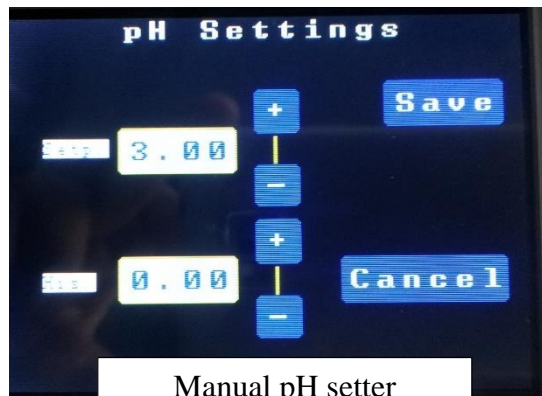

Manual pH setter

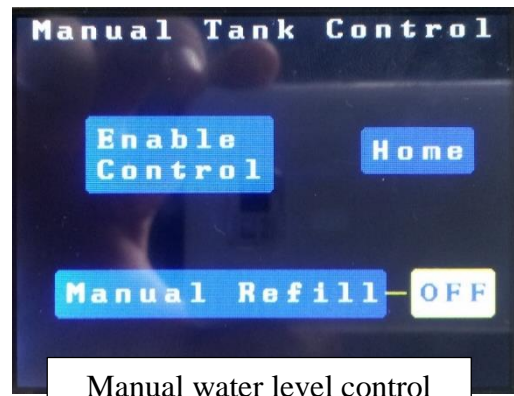

Manual water level control

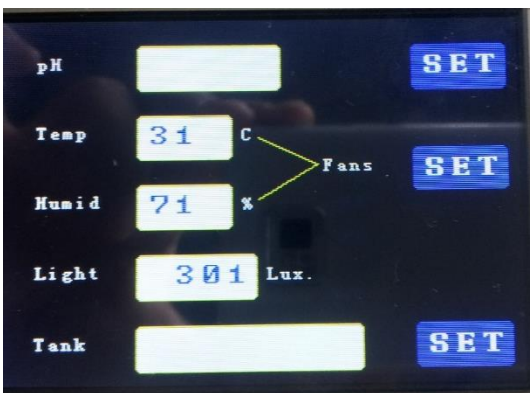

Overall Monitoring Interface

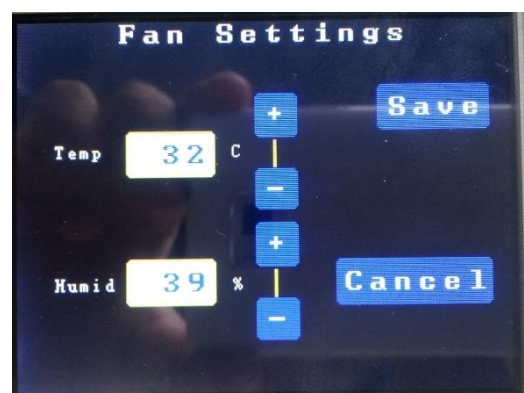

Manual water level control

Figure 7: Interfaces of Vertical Farm Expert System

## **CHAPTER 5:**

### **CONCLUSION & RECOMMENDATIONS**

#### **5. Conclusion & Future Work**

Vertical farming concept is still at its infant stage given the number of paper published is minimal. The near related work which is greenhouses resembles much with vertical farming concept is widely research and applied. This paper would be one of the pioneer papers of making vertical farming concept as a main research focus. On top of that, the research has summarized the two basic components to develop a vertical farm which include an ES and SPA building. Using expert system has become increasingly complex due to many new improvements made and the need of experts is becoming demanding. This research aims to lower these issues by introducing a feature called 'Expert Recommendation Option' which simplify and auto-configure many variables setting for beginner and intermediate users. The current work has its limitation namely only a single plant is used, simple miniature vertical farm was built with limited sensors functionality and changing season environment factor was not taken in. The future work for this research would be building a more sophisticated model (perhaps actual 3 storeys vertical farm with adequate sensors and equipment), factor in many more types of commonly consumed plants and taking into factor of changing season. All in all, the significant of this work is to simplify approach to construct expert system for vertical farms which in turn make the concept much more attractive to investors which ultimately lead to construction of actual vertical farms.

## REFERENCES

- Abdelhamid, Y., Hassan, H., & Rafea, A. (1997). *A proposed methodology for expert system engineering*. Paper presented at the 5th International conference on artificial intelligence applications. Egyptians Computer Society, Cairo, Egypt.
- American Heritage Dictionary. (2009, 2009). Agriculture. Fourth. from <http://www.thefreedictionary.com/agriculture>
- Banerjee, C., & Adenaueer, L. (2014). Up, Up and Away! The Economics of Vertical Farming. *Journal of Agricultural Studies*, 2(1), 40-60.
- Boer, J. D. (2013). 10 Trends for 2013. *Urban Farming Becomes Serious Business*. Retrieved March 14, 2014, from <http://popupcity.net/trend-8-urban-farming-becomes-serious-business/>
- Bulkeley, H. (2013). *Cities and climate change*: Routledge.
- Carlsson-Kanyama, A., & Faist, M. (2000). *Energy use in the food sector: a data survey*: Swedish Environmental Protection Agency Stockholm, Sweden.
- Center for Disease Control. (December, 2013). Human Body Statistics. Retrieved March 20, 2014, from <http://www.statisticbrain.com/human-body-statistics/>
- Chen, G., & Pham, T. T. (2000). *Introduction to fuzzy sets, fuzzy logic, and fuzzy control systems*: CRC press.
- Chen, L.-H., & Chiang, C.-H. (2004). An intelligent control system with a multi-objective self-exploration process. *Fuzzy Sets and Systems*, 143(2), 275-294. doi: [http://dx.doi.org/10.1016/S0165-0114\(03\)00183-0](http://dx.doi.org/10.1016/S0165-0114(03)00183-0)
- Department of Agriculture. (2012). *History of Locust and Grasshopper Outbreaks in Australia*. Australia: Australian Government Retrieved from <http://www.daff.gov.au/animal-plant-health/locusts/about/history#australian>.
- Department of Economic and Social Affairs. (2012). Total Population - Both Sexes. Retrieved March 20, 2014, from <http://esa.un.org/wpp/Excel-Data/population.htm>
- Despommier, D. (2009). The Vertical Farm. Retrieved August, 20, 2010, from <http://www.youtube.com/watch?v=XIdP00u2KRA>
- Despommier, D. (2011). The vertical farm: controlled environment agriculture carried out

in tall buildings would create greater food safety and security for large urban populations. *Journal für Verbraucherschutz und Lebensmittelsicherheit*, 6(2), 233-236. doi: 10.1007/s00003-010-0654-3

Dietrich, J. P., Schmitz, C., Lotze-Campen, H., Popp, A., & Müller, C. (2014). Forecasting technological change in agriculture—An endogenous implementation in a global land use model. *Technological Forecasting and Social Change*, 81(0), 236-249. doi: <http://dx.doi.org/10.1016/j.techfore.2013.02.003>

Edwards, T., Faerber, J., Goenawan, A., & Osawa, S. (2005). Genetically Modified Foods. Retrieved February 12, 2014, from <http://classes.soe.ucsc.edu/cmpe080e/Spring05/projects/gmo/index.htm>

European Market Observatory for Fisheries and Aquaculture Products. (2013). *Monthly Highlights*. Europe: European Commission Retrieved from [http://ec.europa.eu/fisheries/documentation/eumofa/pdf/eu-markets-highlights-2013-09\\_en.pdf](http://ec.europa.eu/fisheries/documentation/eumofa/pdf/eu-markets-highlights-2013-09_en.pdf).

Global Footprint Network. (2008). World Footprint. Do we fit on the planet? Retrieved March 2, 2014, from [http://www.footprintnetwork.org/en/index.php/GFN/page/world\\_footprint/](http://www.footprintnetwork.org/en/index.php/GFN/page/world_footprint/)

Grohaus Automation. (n.d). Why Hydroid? Retrieved February 2, 2014, from <http://www.grohaus-automation.com/learn-more/>

Halimah. (2014). 30,00 metric tonnes of rubbish discarded daily, *New Straits Times*. Retrieved from <http://www.nst.com.my/latest/30-000-metric-tonnes-of-rubbish-discarded-daily-halimah-1.466002>

Hashimoto, Y., Morimoto, T., & De Baerdemaeker, J. (2006). Speaking plant/speaking fruit approaches. *Munack, (Ed.), CIGR Handbook of Agricultural Engineering (ASABE, Michigan, USA)*, 244-259.

He, H., & Xue, H. (2012). The Design of Greenhouse Environment Control System Based on Variable Universe Fuzzy Control Algorithm. In D. Li & Y. Chen (Eds.), *Computer and Computing Technologies in Agriculture V* (Vol. 368, pp. 72-78): Springer Berlin Heidelberg.

Hunt, A., & Watkiss, P. (2011). Climate change impacts and adaptation in cities: a review of the literature. *Climatic Change*, 104(1), 13-49.

Iliev, O. L., Sazdov, P., & Zakeri, A. (2014). A fuzzy logic-based controller for integrated control of protected cultivation. *Management of Environmental Quality: An International Journal*, 25(1), 75-85.

- Jabatan Pertanian Malaysia. (2010). *Paddy*. Malaysia: Malaysian Government Retrieved from [http://www.statistics.gov.my/portal/download\\_Economics/files/DATA\\_SERIES/2011/pdf/08Padi.pdf](http://www.statistics.gov.my/portal/download_Economics/files/DATA_SERIES/2011/pdf/08Padi.pdf).
- Ke, S.-k., Ding, M., Li, L., Niu, Q.-l., & Huang, D.-f. (2012). Grafting watermelon seedling production management system based on process control strategy. *Journal of Shanghai Jiaotong University (Science)*, 17(2), 129-134. doi: 10.1007/s12204-012-1241-9
- Knudsen, L. G., Phuc, P. D., Hiep, N. T., Samuelsen, H., Jensen, P. K., Dalsgaard, A., . . . Konradsen, F. (2008). The fear of awful smell: risk perceptions among farmers in Vietnam using wastewater and human excreta in agriculture.
- Kolokotsa, D., Saridakis, G., Dalamagkidis, K., Dolianitis, S., & Kaliakatsos, I. (2010). Development of an intelligent indoor environment and energy management system for greenhouses. *Energy Conversion and Management*, 51(1), 155-168. doi: <http://dx.doi.org/10.1016/j.enconman.2009.09.007>
- Ministry of Health. (2012). *Garis Panduan Makan*. Malaysia: Ministry of Health Retrieved from <http://www.moh.gov.my/images/gallery/GarisPanduan/diet/KM1.pdf>.
- Ministry of Science Technology and Innovation (MOSTI) Malaysia. (1969 - 2011). *Maximum and Minimum temperature of Malaysia*. Malaysia: Retrieved from <http://www.met.gov.my/>
- Morimoto, T., & Hashimoto, Y. (2000). AI approaches to identification and control of total plant production systems. *Control Engineering Practice*, 8(5), 555-567. doi: [http://dx.doi.org/10.1016/S0967-0661\(99\)00176-8](http://dx.doi.org/10.1016/S0967-0661(99)00176-8)
- Morimoto, T., & Hashimoto, Y. (2000). An intelligent control for greenhouse automation, oriented by the concepts of SPA and SFA — an application to a post-harvest process. *Computers and Electronics in Agriculture*, 29(1-2), 3-20. doi: [http://dx.doi.org/10.1016/S0168-1699\(00\)00133-2](http://dx.doi.org/10.1016/S0168-1699(00)00133-2)
- National Wind Watch. (n.d). FAQ-Output. Retrieved March 10, 2014, from <https://www.wind-watch.org/faq-output.php>
- Netafim. (n.d). Greenhouse Solutions. Retrieved February 12,, 2014, from <http://www.netafim.com/greenhouse>
- Purgro. (2012). Grobot Evolution. from <http://www.purgro.com/grobot.html>

- Razak, N. A. (2010). *Tenth Malaysia Plan 2011-2015*. Retrieved from [http://www.pmo.gov.my/dokumenattached/speech/files/RMK10\\_Speech.pdf](http://www.pmo.gov.my/dokumenattached/speech/files/RMK10_Speech.pdf)
- Sharma, J. S., & Makwana, G. D. (2013). Intelligent crop management system for greenhouse environment. *International Journal of Science and Research*, 2(4), 205-208.
- Sheerwind. (2012). Sheerwind FAQ. Retrieved March, 20, 2014, from <http://sheerwind.com/technology/faq-technology>
- Shrestha, A., & Dunn, B. (n.d). Hydroponics. United States: Oklahoma Cooperative Extension Service.
- Shu-Hsien, L. (2005). Expert system methodologies and applications—a decade review from 1995 to 2004. *Expert Systems with Applications*, 28(1), 93-103. doi: <http://dx.doi.org/10.1016/j.eswa.2004.08.003>
- Soilhealth.com. (n.d). Soil-borne plant pathogens. Retrieved February 12, 2014, from <http://www.soilhealth.com/soils-are-alive/how-do-soil-organisms-affect-plants/p-04.htm>
- Sørensen, J., Jørgensen, B., Klein, M., & Demazeau, Y. (2011). An Agent-Based Extensible Climate Control System for Sustainable Greenhouse Production. In D. Kinny, J.-j. Hsu, G. Governatori & A. Ghose (Eds.), *Agents in Principle, Agents in Practice* (Vol. 7047, pp. 218-233): Springer Berlin Heidelberg.
- Specht, K., Siebert, R., Hartmann, I., Freisinger, U. B., Sawicka, M., Werner, A., . . . Dierich, A. (2013). Urban agriculture of the future: an overview of sustainability aspects of food production in and on buildings. *Agriculture and Human Values*, 1-19.
- Technology Quarterly. (2010). Does it really stack up? Retrieved August, 12, 2012, from <http://www.economist.com/node/17647627>
- The Genographic Project 2.0 Beta. The Farming Revolution. Retrieved March 19, 2014, from <https://genographic.nationalgeographic.com/development-of-agriculture/>
- The Star Online. (2013). Air conditioners and purifiers selling like hot cakes, *The Star Online*. Retrieved from <http://www.thestar.com.my/News/Nation/2013/06/26/Air-conditioners-and-purifiers-selling-like-hot-cakes/>
- Wang, F., Mei, L., Feng, W., Wang, L., Wang, L., & Ruan, H. (2013). A Greenhouse

Control with Sectional-Control Strategy Based on MPT Intelligent Algorithm. In D. Li & Y. Chen (Eds.), *Computer and Computing Technologies in Agriculture VI* (Vol. 392, pp. 43-50): Springer Berlin Heidelberg.

Westbrook Greenhouse Systems. (2012). Greenhouses Grow Your Way. Retrieved March 31, 2014, from <http://westbrooksystems.com/>

Wittwer, S. H., & Castilla, N. (1995). Protected cultivation of horticultural crops worldwide. *HortTechnology*, 5(1), 6-23.

World Capital Institute. (2013). 2013 Kuala Lumpur, Malaysia. Retrieved March, 20, 2014, from <http://www.worldcapitalinstitute.org/makciplatform/2013-kuala-lumpur-malaysia>

Worldometers. (2014). Current World Population. Retrieved February 27, 2014, from <http://www.worldometers.info/world-population/>



# APPENDICES

## Gantt Chart & Milestones

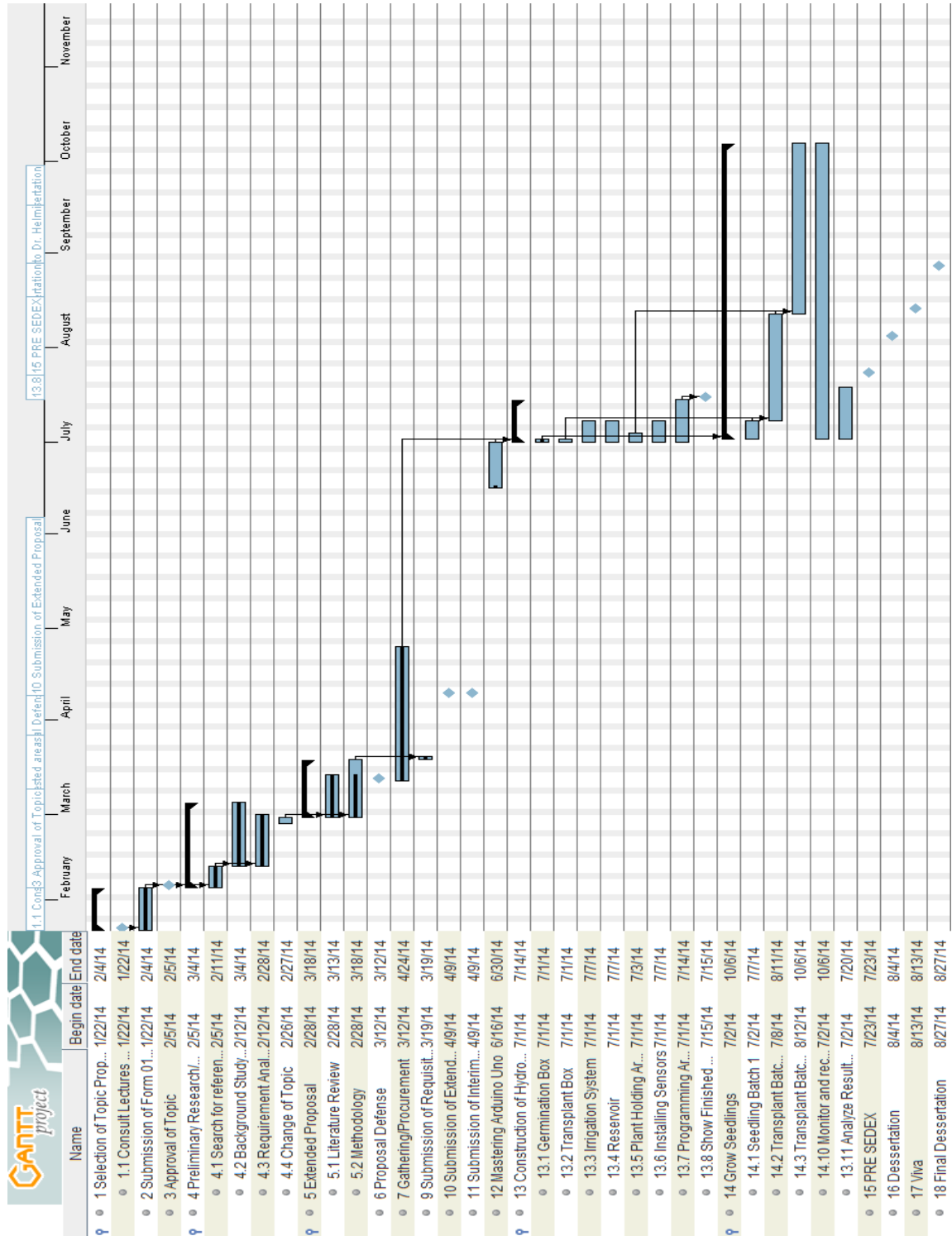

## Interview Questions

1. What is the definition of small farmers?
2. What are their common characteristics – size of farm, earnings and etc?
3. Is there any statistics, data and information regarding percentage of small farmers, their outputs, costing per hectare of land and maintenance cost?
4. What are the problems local small farmers are facing nowadays?
5. Have you heard of vertical farming concept?
6. Do you think this concept (vertical farm) can help local small farmers?
7. What are the future insights for local small farmers, what is their greatest need for now?

## System Architectural Design

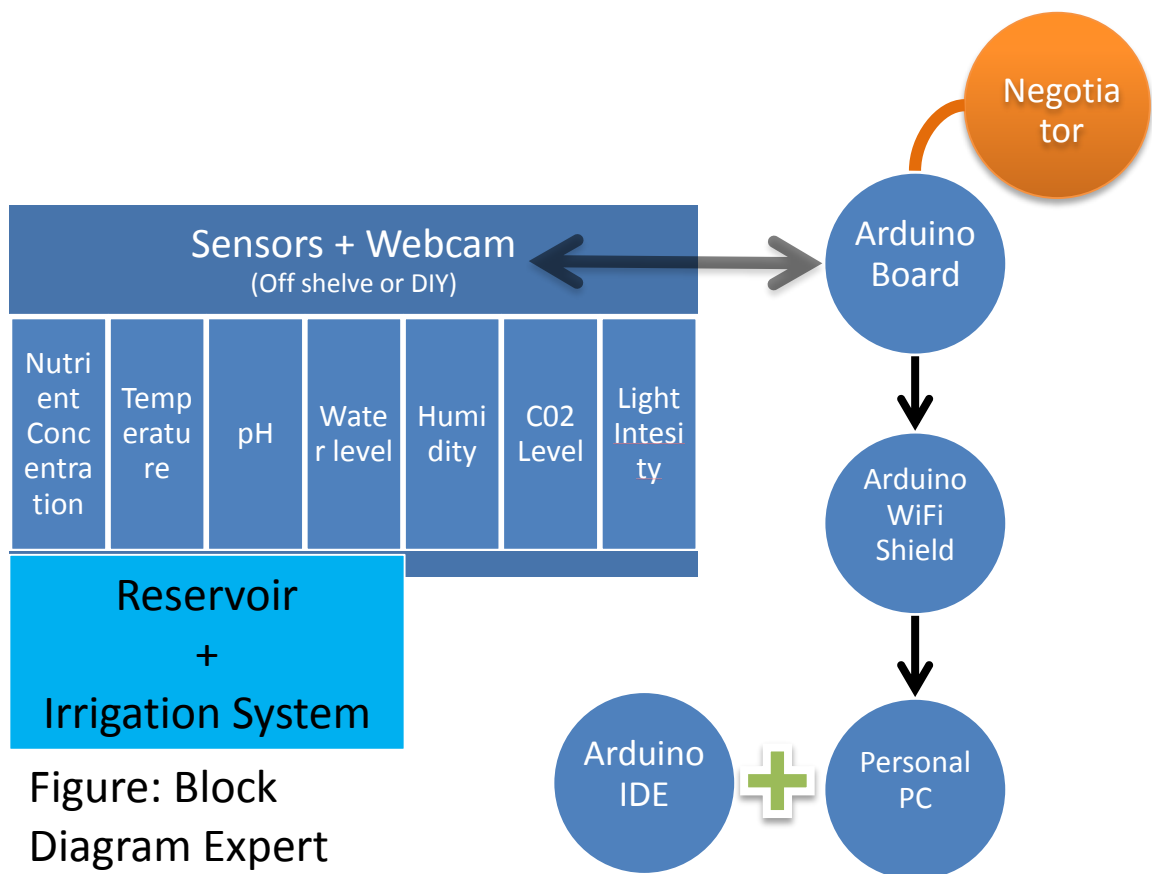
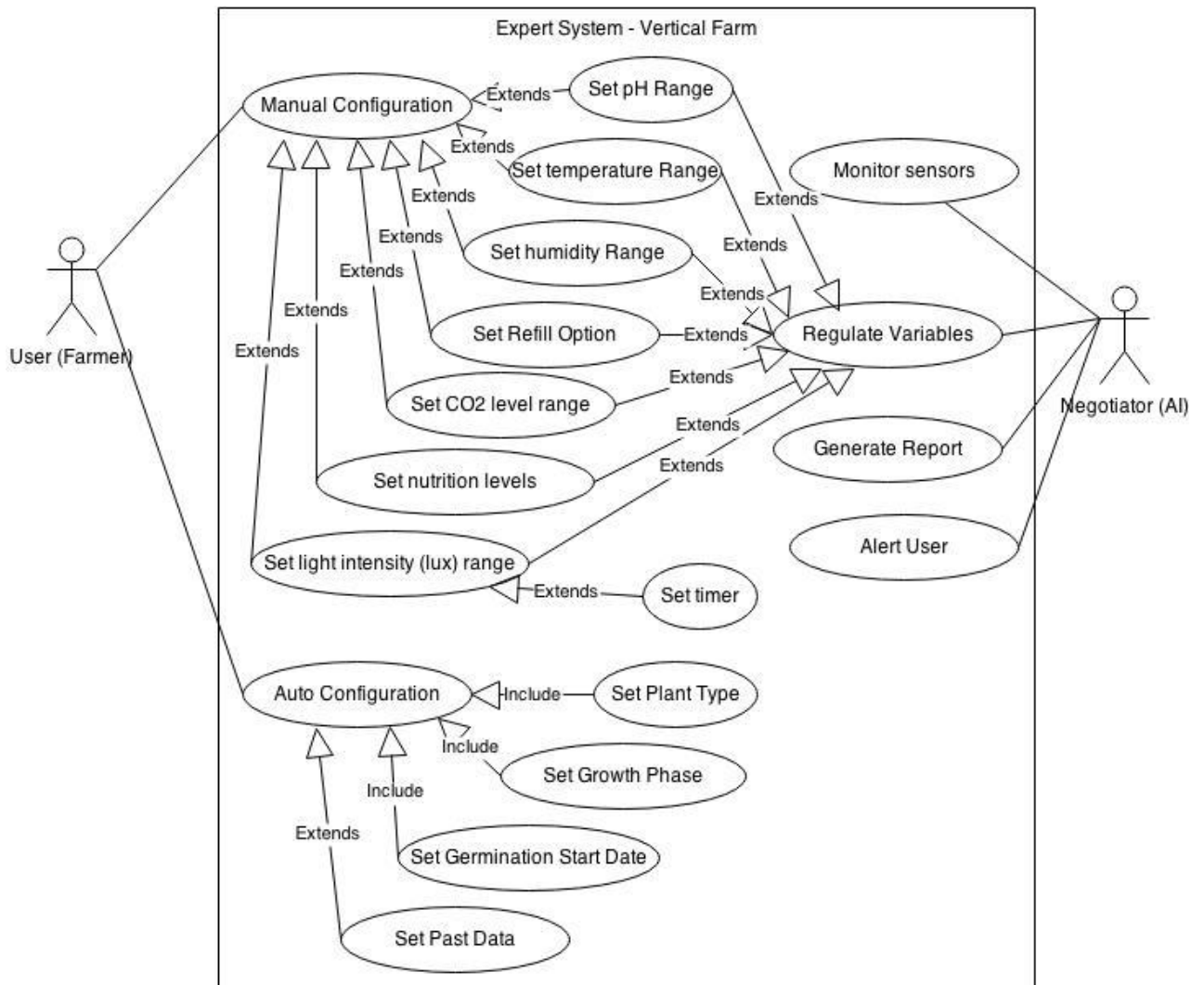

Figure: Block Diagram Expert System of Vertical Farm

\*Light Tubes – Fluorescent Based – Direct sunlight to any part within the building (any color)

## UML Diagrams – USE CASE Diagram



## Comparison Criteria List + Mark distribution scheme

Grade	Short Form (Abbr.)	Points
Excellent	E	3
Good	G	2
Acceptable	A	1
Unacceptable	U	0

- $P_i = 3*NE_i + 2*NG_i + 1*NA_i + 0*Nu_i$ , where:
  - $P_i$  the performance score for expert #  $i$
  - $NE_i$  number of cases evaluated as excellent

- NGi number of cases evaluated as good
- NAI number of cases evaluated as acceptable
- NUi number of cases evaluated as unacceptable

## Vertical Farm Concept

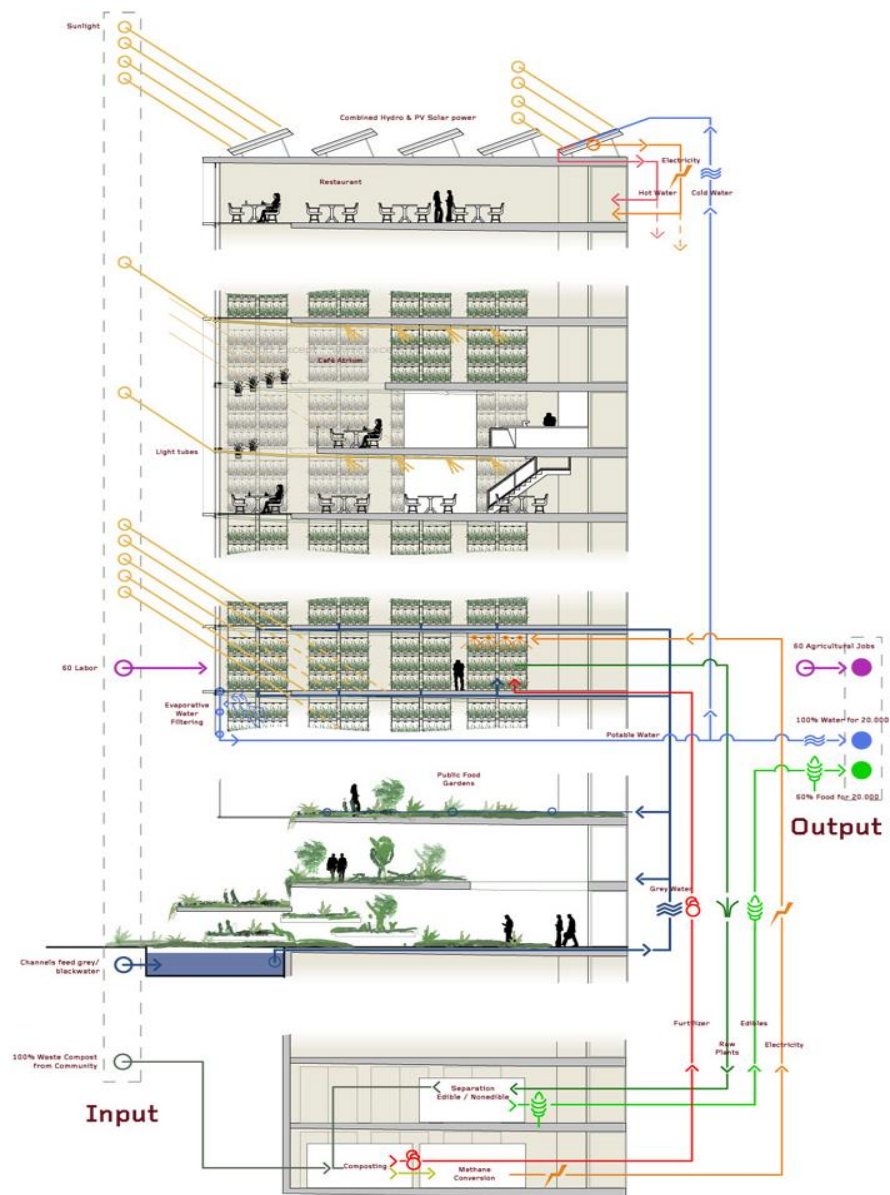

Shanghai Urban Master Plan: Vertical Farming

## Expert System Codes (Display Codes)

\*Display codes and Libraries are inside the CDs.

```
// UTFT_Touch_Calibration (C)2012 uCtronics
// web: http://www.uctronics.com
// UTFT_Touch_Calibration is derived from
// ITDB02_Touch_Calibration (C)2010 Henning Karlsen
// web: http://www.henningkarlsen.com/electronics
// to fit for our 3.2 inch TFT LCD shield for Arduino/Maple/Chipkit
// This program can be used to calibrate the touchscreen
// of the 3.2 inch TFT LCD shield.
//
// This program requires the UTFT library (8bit mode)
// and the code is compatible with both UNO and Mega board.
// No code modification required.
//
// Instructions will be given on the display.
//

#include <UTFT.h>
#include <ArduCAM_Touch.h>
#include <SD.h>

// Declare which fonts we will be using
extern uint8_t SmallFont[];
extern uint8_t BigFont[];

//
//UTFT(byte model, int RS, int WR,int CS,int RD)
UTFT myGLCD(ITDB32S,A1,A2,A0,A3);
//myTouch(TCS,IRQ);
ArduCAM_Touch myTouch(10,9);

int cx, cy;
int rx[10], ry[10];
float px, py;
int ox, oy;
int FanTemp = 30;
int FanHumid = 28;
void setup()
{
  myGLCD.InitLCD(PORTRAIT);
  myGLCD.clrScr();
  myGLCD.setFont(SmallFont);

  myTouch.InitTouch();
  myTouch.setPrecision(PREC_LOW);
  //Serial.begin(9600);
}

void drawCrossHair(int x, int y)
{
  myGLCD.drawRect(x-10, y-10, x+10, y+10);
  myGLCD.drawLine(x-5, y, x+5, y);
  myGLCD.drawLine(x, y-5, x, y+5);
}

void readCoordinates()
{
  int iter = 2000;
  int cnt = 0;
  unsigned long tx=0;
  unsigned long ty=0;
  boolean OK = false;
```

```

while (OK == false)
{
  while (myTouch.dataAvailable() == false) {}
  while ((myTouch.dataAvailable() == true) && (cnt<iter))
  {
    myTouch.read();
    tx += myTouch.TP_X;
    ty += myTouch.TP_Y;

    cnt++;
  }
  if (cnt>=iter)
  {
    OK = true;
  }
  else
  {
    tx = 0;
    ty = 0;
    cnt = 0;
  }
}

cx = tx / iter;
cy = ty / iter;

}

void calibrate(int x, int y, int i)
{
  myGLCD.setColor(255, 255, 255);
  drawCrossHair(x,y);
  readCoordinates();
  myGLCD.setColor(80, 80, 80);
  drawCrossHair(x,y);

  rx[i]=cx;
  ry[i]=cy;
  while (myTouch.dataAvailable() == true)
  {
    myTouch.read();
  }
}

void waitForTouch()
{
  while (myTouch.dataAvailable() == true)
  {
    myTouch.read();
  }
  while (myTouch.dataAvailable() == false) {}
  while (myTouch.dataAvailable() == true)
  {
    myTouch.read();
  }
}

void startup()
{
  myGLCD.setColor(255, 0, 0);
  myGLCD.fillRect(0, 0, 239, 13);
  myGLCD.setColor(255, 255, 255);
  myGLCD.setBackColor(255, 0, 0);
  myGLCD.drawLine(0, 14, 239, 14);
  myGLCD.print("ITDB02 TOUCH CALIBRATION", CENTER, 1);
  myGLCD.setBackColor(0, 0, 0);

  myGLCD.print("INSTRUCTIONS", CENTER, 30);
  myGLCD.print("Use a stylus or something", LEFT, 50);
  myGLCD.print("similar to touch as close to", LEFT, 62);
}

```

```

myGLCD.print("the center of the highlighted", LEFT, 74);
myGLCD.print("crosshair as possible. Keep as", LEFT, 86);
myGLCD.print("still as possible and keep", LEFT, 98);
myGLCD.print("holding until the highlight is", LEFT, 110);
myGLCD.print("removed. Repeat for all", LEFT, 122);
myGLCD.print("crosshairs in sequence.", LEFT, 134);
myGLCD.print("Further instructions will be", LEFT, 158);
myGLCD.print("displayed when the calibration", LEFT, 170);
myGLCD.print("is complete.", LEFT, 182);
myGLCD.print("Do NOT use your finger as a", LEFT, 206);
myGLCD.print("calibration stylus or the", LEFT, 218);
myGLCD.print("result WILL BE very imprecise.", LEFT, 230);
myGLCD.print("Touch screen to continue", CENTER, 305);

waitForTouch();
myGLCD.clrScr();
}

void done()
{
myGLCD.clrScr();
myGLCD.setColor(255, 0, 0);
myGLCD.fillRect(0, 0, 239, 13);
myGLCD.setColor(255, 255, 255);
myGLCD.setBackColor(255, 0, 0);
myGLCD.drawLine(0, 14, 239, 14);
myGLCD.print("ITDB02 TOUCH CALIBRATION", CENTER, 1);
myGLCD.setBackColor(0, 0, 0);

myGLCD.print("CALIBRATION COMPLETE", CENTER, 30);
myGLCD.print("To use the new calibration", LEFT, 50);
myGLCD.print("settings you must edit the", LEFT, 62);
myGLCD.setColor(160, 160, 255);
myGLCD.print("ITDB02_Touch.cpp", LEFT, 74);
myGLCD.setColor(255, 255, 255);
myGLCD.print("file and", 136, 74);
myGLCD.print("change the following values.", LEFT, 86);
myGLCD.print("The values are located right", LEFT, 98);
myGLCD.print("below the opening comment in", LEFT, 110);
myGLCD.print("the file.", LEFT, 122);
myGLCD.print("PixSizeX", LEFT, 158);
myGLCD.print("PixOffsX", LEFT, 170);
myGLCD.print("PixSizeY", LEFT, 182);
myGLCD.print("PixOffsY", LEFT, 194);
myGLCD.print("Connected module:", LEFT, 250);
myGLCD.drawLine(0, 155, 239, 155);
myGLCD.drawLine(0, 209, 239, 209);

myGLCD.printNumF(px, 2, 100, 158);
myGLCD.printNumI(ox, 100, 170);
myGLCD.printNumF(py, 2, 100, 182);
myGLCD.printNumI(oy, 100, 194);
if (px>=0)
myGLCD.print("2.4\"", 144, 250);
else
{
if (py>=0)
{
myGLCD.print("3.2\"", 144, 250);
myGLCD.print("Negative numbers for PixSizeX", LEFT, 270);
myGLCD.print("is expected :)", LEFT, 282);
}
else
{
myGLCD.print("3.2\" Wide", 144, 250);
myGLCD.print("Negative numbers for PixSizeX", LEFT, 270);
myGLCD.print("and PixSizeY are expected :)", LEFT, 282);
}
}
}
}
}

```

```

void mainscr()
{
  myGLCD.fillScr(0, 0, 0);
  myGLCD.setBackgroundColor (0, 0, 0);

  myGLCD.setFont(SmallFont);
  myGLCD.setColor(255, 255, 255);
  myGLCD.setBackgroundColor (0, 0, 0);
  myGLCD.print("pH", 25, 23);
  myGLCD.print("Temp", 25, 69);
  myGLCD.print("Humid", 25, 115);
  myGLCD.print("Light", 25, 161);
  myGLCD.print("Tank", 25, 207);
  myGLCD.print("Fans", 200, 92);
  myGLCD.print("C", 150, 71); //degree celcius
  myGLCD.print("%", 150, 117); //Percent
  myGLCD.print("Lux.", 165, 163); //Lux
  myGLCD.setColor(255, 255, 0);
  myGLCD.drawLine(160, 79, 196, 97);
  myGLCD.drawLine(160, 120, 196, 97);

  myGLCD.setFont(BigFont);
  myGLCD.setColor(255, 255, 255);
  myGLCD.setBackgroundColor(0, 0, 255);
  myGLCD.setColor(0, 0, 255);
  myGLCD.fillRoundRect (255, 17, 312, 47);
  myGLCD.setColor(255, 255, 255);
  myGLCD.print("SET", 260, 23); //set pH
  myGLCD.setColor(0, 0, 255);
  myGLCD.fillRoundRect (255, 86, 312, 114);
  myGLCD.setColor(255, 255, 255);
  myGLCD.print("SET", 260, 92); //set Fans
  myGLCD.setColor(0, 0, 255);
  myGLCD.fillRoundRect (255, 201, 312, 229);
  myGLCD.setColor(255, 255, 255);
  myGLCD.print("SET", 260, 207); //set Tank

  myGLCD.setFont(BigFont);
  myGLCD.setColor(0, 0, 255);
  myGLCD.setBackgroundColor(255, 255, 255);
  myGLCD.setColor(255, 255, 255);
  myGLCD.fillRoundRect (86, 17, 173, 47);
  myGLCD.setColor(255, 255, 0);
  myGLCD.drawRoundRect (86, 17, 173, 47);
  myGLCD.setColor(0, 0, 255);
  //myGLCD.print("5.0", 91, 23); //location value pH
  myGLCD.setColor(255, 255, 255);
  myGLCD.fillRoundRect (86, 64, 143, 93);
  myGLCD.setColor(255, 255, 0);
  myGLCD.drawRoundRect (86, 64, 143, 93);
  myGLCD.setColor(0, 0, 255);
  //myGLCD.print("25", 91, 69); //location value Temp
  myGLCD.setColor(255, 255, 255);
  myGLCD.fillRoundRect (86, 110, 143, 139);
  myGLCD.setColor(255, 255, 0);
  myGLCD.drawRoundRect (86, 110, 143, 139);
  myGLCD.setColor(0, 0, 255);
  //myGLCD.print("100", 91, 115); //location value Humid
  myGLCD.setColor(255, 255, 255);
  myGLCD.fillRoundRect (86, 156, 158, 185);
  myGLCD.setColor(255, 255, 0);
  myGLCD.drawRoundRect (86, 156, 158, 185);
  myGLCD.setColor(0, 0, 255);
  //myGLCD.print("2200", 91, 161); //location value Light
  myGLCD.setColor(255, 255, 255);
  myGLCD.fillRoundRect (86, 202, 222, 231);
  myGLCD.setColor(255, 255, 0);
  myGLCD.drawRoundRect (86, 202, 222, 231);
  myGLCD.setColor(0, 0, 255);
}

```



```

//myGLCD.print("disabled", 91, 207); //location value Tank

waitForTouch();
myGLCD.clrScr();
}

void FanSetting()
{
myGLCD.fillScr(0, 0, 0);
myGLCD.setBackgroundColor (0, 0, 0);

myGLCD.setFont(SmallFont);
myGLCD.setColor(255, 255, 255);
myGLCD.setBackgroundColor (0, 0, 0);
myGLCD.print("Temp", 25, 79);
myGLCD.print("Humid", 25, 165);
myGLCD.print("C", 140, 79);
myGLCD.print("%", 140, 165);

myGLCD.setFont(BigFont);
myGLCD.setColor(255, 255, 255);
myGLCD.setBackgroundColor (0, 0, 0);
myGLCD.print("Fan Settings", CENTER, 0);

myGLCD.setFont(BigFont);
myGLCD.setColor(255, 255, 255);
myGLCD.setBackgroundColor (255, 255, 255);
myGLCD.setColor(255, 255, 255);
myGLCD.fillRoundRect (71, 72, 128, 101);
myGLCD.setColor(255, 255, 0);
myGLCD.drawRoundRect (71, 72, 128, 101);
myGLCD.setColor(0, 0, 255);
myGLCD.printNumI(FanTemp, 76, 79); //value Temp
myGLCD.setColor(255, 255, 255);
myGLCD.fillRoundRect (71, 155, 128, 184);
myGLCD.setColor(255, 255, 0);
myGLCD.drawRoundRect (71, 155, 128, 184);
myGLCD.setColor(0, 0, 255);
myGLCD.printNumI(FanHumid, 76, 162); //value Humid

myGLCD.setFont(BigFont);
myGLCD.setColor(255, 255, 255);
myGLCD.setBackgroundColor(0, 0, 255);
myGLCD.setColor(0, 0, 255);
myGLCD.fillRoundRect (155, 47, 182, 75);
myGLCD.setColor(255, 255, 255);
myGLCD.print("+", 160, 53);
myGLCD.setColor(0, 0, 255);
myGLCD.fillRoundRect (155, 96, 182, 122);
myGLCD.setColor(255, 255, 255);
myGLCD.print("-", 160, 102);

myGLCD.setColor(0, 0, 255);
myGLCD.fillRoundRect (155, 131, 182, 159);
myGLCD.setColor(255, 255, 255);
myGLCD.print("+", 160, 137);
myGLCD.setColor(0, 0, 255);
myGLCD.fillRoundRect (155, 180, 182, 206);
myGLCD.setColor(255, 255, 255);
myGLCD.print("-", 160, 186);
myGLCD.setColor(255, 255, 0);
myGLCD.drawLine(167, 78, 167, 95);
myGLCD.drawLine(168, 78, 168, 95);
myGLCD.drawLine(167, 162, 167, 179);
myGLCD.drawLine(168, 162, 168, 179);
myGLCD.setColor(0, 0, 255);
myGLCD.fillRoundRect (235, 42, 307, 71);
myGLCD.setColor(255, 255, 255);
myGLCD.print("Save", 240, 49);
myGLCD.setColor(0, 0, 255);

```

```
myGLCD.fillRoundRect (207, 155, 307, 184);  
myGLCD.setColor(255, 255, 255);  
myGLCD.print("Cancel", 210, 162);  
  
}
```

```
void loop()  
{  
  startup();  
  mainscr();  
  FanSetting();  
  done();  
  while(true) {}  
}
```