

STATUS OF THESIS

Title of thesis:

DESIGN OF MOBILE DATA COLLECTOR BASED
CLUSTERING ROUTING PROTOCOL FOR
WIRELESS SENSOR NETWORKS

I MUHAMMAD ARSHAD

hereby allow my thesis to be placed at the Information Resource Center (IRC) of Universiti Teknologi PETRONAS (UTP) with the following conditions:

1. The thesis becomes the property of UTP
2. The IRC of UTP may make copies of the thesis for academic purposes only.
3. This thesis is classified as

Confidential

Non-confidential

If this thesis is confidential, please state the reason:

The contents of the thesis will remain confidential for _____ years.

Remarks on disclosure:

Endorsed by

M. ARSHAD

Signature of Author

Permanent address:

A-430 Block "H" North
Nazimabad, Karachi, Pakistan

Date : 27/02/2013

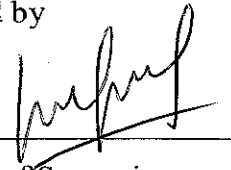

Signature of Supervisor

Dr. Mohamad Naufal Bin Mohamad Saad
Department of Electrical and Electronic
Engineering
Universiti Teknologi PETRONAS

Date : 27/02/2013

DESIGN OF MOBILE DATA COLLECTOR BASED CLUSTERING
ROUTING PROTOCOL FOR WIRELESS SENSOR NETWORKS

by

MUHAMMAD ARSHAD

The undersigned certify that they have read, and recommend to the Postgraduate Studies Programme for acceptance of this thesis for the fullfilment of the requirements for the degree stated.

Signature:

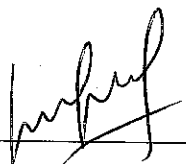

Main Supervisor:

Dr. Mohamad Naufal Bin Mohamad Saad

Signature:

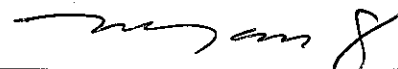

Head of Department:

Dr. Rosdiazli Bin Ibrahim

DR. ROSDIAZLI B. IBRAHIM
Head of Department
Electrical & Electronic Engineering Department
Universiti Teknologi PETRONAS

Date:

28/02/2013

DESIGN OF MOBILE DATA COLLECTOR BASED CLUSTERING
ROUTING PROTOCOL FOR WIRELESS SENSOR NETWORKS

By

MUHAMMAD ARSHAD

A Thesis

Submitted to the Postgraduate Studies Programme
as a requirement for the degree of

DOCTOR OF PHILOSOPHY
ELECTRICAL AND ELECTRONIC ENGINEERING
UNIVERSITI TEKNOLOGI PETRONAS
BANDAR SERI ISKANDAR
PERAK, MALAYSIA

AUGUST 2012

DECLARATION OF THESIS

Title of thesis

DESIGN OF MOBILE DATA COLLECTOR BASED
CLUSTERING ROUTING PROTOCOL FOR
WIRELESS SENSOR NETWORKS

I, MUHAMMAD ARSHAD
hereby declare that the thesis is based on my original work except for quotations and citations, which have been duly acknowledged. I also declare that it has not been previously or concurrently submitted for any other degree at UTP or other institutions.

M. ARSHAD

Signature of Author

Permanent address:

A-430 Block "H" North
Nazimabad, Karachi, Pakistan

Date: 27/02/2013

Witnessed by

[Signature]

Signature of Supervisor

Dr. Mohamad Naufal Bin Mohamad Saad

Date: 27/02/2013

DEDICATION

To my beloved family members, specially to my father Syed Sabir Hussain (Late)

ACKNOWLEDGEMENT

All praise is due to ALLAH (SWT), who created a man and taught him what he knew not “Who has taught (the writing) by pen”, and taught man which was not possible without ALLAH’s guidance. May ALLAH grant peace and honor to messenger of Islam Muhammad (PBUH) and his family. First of all, I am very thankful to the Almighty ALLAH, for enhancing my courage in order to complete this research work diligently.

Secondly, I am most grateful to my supervisor, Dr. Mohamad Naufal Bin Mohamad Saad who has guided me throughout this research work and indebted to him for his unceasing encouragement, support and advice. His knowledge, experience and commitment have benefited me tremendously during this research. It is my great pleasure to have had such an opportunity to do research work with him.

My deep appreciation goes to Dr. Nidal Kamel, and Dr. Mohamad Yahya Alsalem my co-supervisor and field supervisor accordingly to support and help me in this research work. His interest for research and devotion to work has been constant sources of inspiration and encouragement for my advancement.

My thanks should also go to my colleagues at the Department of Electrical and Electronic Engineering, Universiti Teknologi PETRONAS. The memories I shared with Firas, Shuja uddin, Atif, Safdar, Asif Aziz, Nasrullah Armi, Usman and Abbas will always remain with me. Words cannot express my deepest gratitude and appreciation to my parents, my brothers and sisters, specially my lovely wife and daughter for their encouragement and support throughout the period of this work. Without them, this work would never have come into existence. There are no words, which can express my love and appreciation for my family whose hands always rise in prayer for my success; it is their moral support that makes me feel my entity at this stage. Finally, I apologize if I have annoyed or offended anybody during my studies in this great institution.

ABSTRACT

Wireless Sensor Networks (WSNs) consisting of hundreds or even thousands of nodes, can be used for a multitude of applications such as warfare intelligence or to monitor the environment. A typical WSN node has a limited and usually an irreplaceable power source and the efficient use of the available power is of utmost importance to ensure maximum lifetime of each WSN application. Each of the nodes needs to transmit and communicate sensed data to an aggregation point for use by higher layer systems. Data and message transmission among nodes collectively consume the largest amount of energy available in WSNs. The network routing protocols ensure that every message reaches the destination and has a direct impact on the amount of transmissions to deliver messages successfully. To this end, the transmission protocol within the WSNs should be scalable, adaptable and optimized to consume the least possible amount of energy to suite different network architectures and application domains. The inclusion of mobile nodes in the WSNs deployment proves to be detrimental to protocol performance in terms of nodes energy efficiency and reliable message delivery. This thesis which proposes a novel Mobile Data Collector based clustering routing protocol for WSNs is designed that combines cluster based hierarchical architecture and utilizes three-tier multi-hop routing strategy between cluster heads to base station by the help of Mobile Data Collector (MDC) for inter-cluster communication. In addition, a Mobile Data Collector based routing protocol is compared with Low Energy Adaptive Clustering Hierarchy and A Novel Application Specific Network Protocol for Wireless Sensor Networks routing protocol. The protocol is designed with the following in mind: minimize the energy consumption of sensor nodes, resolve communication holes issues, maintain data reliability, finally reach tradeoff between energy efficiency and latency in terms of End-to-End, and channel access delays. Simulation results have shown that the Mobile Data Collector based clustering routing protocol for WSNs could be easily implemented in environmental applications where energy efficiency of sensor nodes, network lifetime and data reliability are major concerns.

ABSTRAK

Rangkaian Sensor Tanpa Wayar (RSTW) yang terdiri daripada beratus-ratus atau beribu-ribu nod, boleh digunakan untuk pelbagai aplikasi seperti perisikan peperangan atau pemantauan persekitaran. Satu nod RSTW tipikal mempunyai sumber tenaga terhad dan biasanya tidak boleh bertukar ganti. Penggunaan sumber tenaga secara berkesan adalah penting untuk memastikan jangka hayat maksimum setiap aplikasi RSTW. Setiap nod perlu berkomunikasi dengan titik terpilih dan menghantar data yang dikesan kepada titik tersebut, untuk membolehkan data berkenaan digunakan oleh sistem lapisan yang lebih tinggi. Penghantaran data dan mesej antara nod secara kolektifnya menggunakan jumlah terbesar tenaga yang wujud dalam RSTW. Protokol rangkaian laluan baru diperlukan untuk memastikan bahawa setiap mesej sampai ke destinasi dengan selamat; protokol ini juga akan mempunyai kesan langsung kepada jumlah penghantaran untuk menyampaikan mesej dengan jayanya. Untuk tujuan ini, protokol penghantaran dalam RSTW seharusnya berskala, boleh disesuaikan dengan pelbagai keadaan, dan dioptimumkan penggunaan jumlah tenaganya selari dengan seni bina rangkaian dan domain aplikasi yang berbeza-beza. Kemasukan nod-nod mudah alih dalam RSTW terbukti memudaratkan prestasi protokol dari segi kecekapan penggunaan tenaga nod-nod RSTW berkenaan dan keberkesanan penghantaran mesej. Tesis ini mencadangkan protokol laluan baru berasaskan Pemungut Data Mudah Alih (PDMA); rekaan RSTW menggabungkan seni bina hierarki berkelompok. Komunikasi antara kelompok (kluster) yang disokong oleh PDMA melibatkan strategi tiga peringkat lompatan pelbagai laluan di antara ketua-ketua kluster dengan stesen pangkalan. Di samping itu, protokol laluan berasaskan PDMA dibandingkan dengan protokol-protokol terkini seperti Hierarki Kluster Adaptasi Tenaga Rendah dan Protokol Rangkaian Aplikasi Khusus untuk Rangkaian Sensor Tanpa Wayar. Protokol berasaskan PDMA ini direka dengan mengambil kira perkara-perkara berikut: pengurangan penggunaan tenaga bagi nod-nod sensor; penyelesaian isu-isu lohong-lohong komunikasi; pengekalan kebolehpercayaan data; akhirnya, persekataan di antara kecekapan penggunaan tenaga dan kepantasan

komunikasi pangkal-ke-pangkal serta kelewatan akses saluran. Keputusan simulasi telah menunjukkan bahawa RSTW yang menggunakan protokol laluan berkelompok berasaskan PDMA boleh dilaksanakan dengan berkesan dalam aplikasi-aplikasi alam sekitar yang menitikberatkan aspek kecekapan tenaga nod-nod sensor, jangka hayat rangkaian dan kebolehpercayaan data.

In compliance with the terms of the Copyright Act 1987 and the IP Policy of the university, the copyright of this thesis has been reassigned by the author to the legal entity of the university,

Institute of Technology PETRONAS Sdn Bhd.

Due acknowledgement shall always be made of the use of any material contained in, or derived from, this thesis.

© Muhammad Arshad, 2012
Institute of Technology PETRONAS Sdn Bhd
All rights reserved.

TABLE OF CONTENTS

STATUS OF THESIS	i
DECLARATION OF THESIS	iv
DEDICATION.....	v
ACKNOWLEDGEMENT.....	vi
ABSTRACT	vii
ABSTRAK.....	viii
LIST OF FIGURES	xvi
LIST OF TABLES.....	xix
LIST OF ABBREVIATIONS	xx
CHAPTER 1	1
INTRODUCTION	1
1.1 Background	1
1.2 Research Motivation.....	3
1.3 Research Questions, Aims and Objectives.....	5
1.4 Scope of Work.....	6
1.5 Study Modules.....	7
1.6 Research Contributions	8
1.7 Dissertation Outline.....	9
1.8 Chapter Summary.....	10
CHAPTER 2	11
LITERATURE SURVEY.....	11
2.1 Wireless Sensor Networks (WSNs)	11
2.1.1 Introduction.....	11
2.1.2 Node hardware architecture for WSNs	12
2.1.3 WSN Open System Interconnection model	15
2.1.4 WSNs protocol stack.....	16
2.1.5 Applications of WSNs	18
2.2 Mobile Wireless Sensor Networks (mobile WSNs).....	20
2.2.1 Overview	20
2.2.2 Hierarchical architectures	21

2.2.3 Types of mobile WSNs	25
2.2.4 Benefits of mobile WSNs	26
2.3 Data Collection Techniques with Mobile Elements.....	26
2.3.1 Overview of mobile elements in WSNs	26
2.3.2 Classification of mobile elements	27
2.3.3 Data Collection Mechanism.....	31
2.3.4 Mobility impact in WSNs	32
2.4 Study of Routing Protocols	33
2.5 Design Consideration for WSNs Routing Protocol.....	34
2.6 Data Centric Routing Protocol	37
2.6.1 Flooding and Gossiping	37
2.6.2 Simple Energy Efficient Routing (SEER)	39
2.6.3 A generalized energy-aware data centric routing for Wireless Sensor Networks	41
2.6.4 Data-centric cooperative storage in Wireless Sensor Networks	42
2.6.5 A modified SPIN for Wireless Sensor Networks.....	43
2.6.6 Advantages of data centric routing protocols	44
2.6.7 Disadvantages of data centric routing protocols	45
2.7 Hierarchical Cluster Based Routing Protocols.....	45
2.7.1 Low Energy Adaptive Clustering Hierarchy (LEACH)	46
2.7.2 Threshold sensitive Energy Efficient sensor Network protocol (TEEN).....	48
2.7.3 A novel application specific network protocol for Wireless Sensor Networks	49
2.7.4 On hierarchical routing in wireless sensor networks	51
2.7.5 Cluster based routing protocol for mobile nodes in Wireless Sensor Network.....	52
2.7.6 Advantages of hierarchical routing protocol.....	54
2.7.7 Disadvantages of hierarchical routing protocol	55
2.8 Mobility Aware Routing Protocol.....	56
2.8.1 Mobility principles	56
2.8.2 Data collection in Wireless Sensor Networks by utilizing multiple mobile nodes	57

2.8.3 Mobile data collector strategy for delay sensitive applications	58
2.8.4 Routing to a Mobile Data Collector (MDC) on a predefined trajectory	60
2.8.5 ROME: Routing Over Mobile Elements in Wireless Sensor Networks	60
2.8.6 Prolonging Network Lifetime via a Controlled Mobile Sink in Wireless Sensor Networks	62
2.8.7 Advantages of mobility aware routing protocol	62
2.8.8 Disadvantages of mobility aware routing protocol	63
2.9 Critical Evaluation of LEACH and Hybrid Multi-hop LEACH	63
2.9.1 Energy dissipation due to displacement.....	63
2.9.2 Communication holes	67
2.9.3 Energy and routing hole in hybrid multi-hop LEACH protocol.....	67
2.10 Chapter Summary.....	69
CHAPTER 3	71
DESIGN OF MOBILE DATA COLLECTOR BASED HIERARCHICAL CLUSTERING ROUTING PROTOCOL.....	71
3.1 Introduction	71
3.2 Design Consideration of Proposed Protocol	71
3.2.1 Energy efficiency	72
3.2.2 Data reliability.....	73
3.2.3 Scalability.....	73
3.2.4 Node mobility	73
3.3 System Model.....	74
3.3.1 Proposed framework and topological architecture.....	75
3.3.2 Description of proposed protocol.....	76
3.3.3 Setup phase	78
3.3.4 Steady state phase	79
3.4 Simulation of Proposed Routing Protocol.....	81
3.4.1 Application layer.....	82
3.4.2 Medium access control layer.....	82
3.4.3 Physical layer	82
3.4.4 Channel model	83
3.4.5 Radio model	84
3.4.6 Node hardware and mobility.....	86

3.5 Mathematical Models.....	86
3.5.1 Energy dissipation calculation	86
3.5.2 Power received calculation	87
3.5.3 Displacement calculation between two nodes	87
3.5.4 Cluster head selection based on residual energy.....	87
3.5.5 Free space propagation model.....	88
3.5.6 Log-Normal shadowing model	88
3.6 Mobile Data Collector Based Routing with Minimum Distance	88
3.6.1 Flowchart of MDC minimum distance LEACH.....	90
3.7 Mobile Data Collector Based Routing with Maximum Residual Energy... 90	
3.7.1 Algorithm of MDC maximum residual energy LEACH	92
3.8 Simulation Tool.....	93
3.8.1 Introduction of OPNET.....	94
3.8.2 Hierarchical editors of OPNET.....	94
3.8.3 Wireless module in OPNET.....	96
3.8.4 Network model.....	97
3.8.5 Node model.....	98
3.8.6 Process model	100
3.8.7 Packet format	105
3.9 Chapter Summary.....	107
CHAPTER 4.....	109
RESULTS AND DISCUSSIONS	109
4.1 Introduction	109
4.2 Simulation Parameters.....	109
4.3 Simulation Metrics	111
4.3.1 Energy consumption of sensor nodes and network lifetime	111
4.3.2 Traffic received, packet loss ratio and packet inter-arrival time.....	111
4.3.3 Channel access and End-to-End delay	113
4.3.4 Time until first and last node dies.....	113
4.3.5 Node density vs. total energy consumption and total traffic received	114
4.3.6 Energy dissipation of MDC and number of live MDC's.....	114
4.4 Simulation Results of MDC minimum distance LEACH	114

4.4.1 Energy consumption of sensor nodes, energy per packet and number of live nodes	115
4.4.2 Traffic received, packet loss ratio and packet inter-arrival time.....	117
4.4.3 Channel access and End-to-End delay	118
4.5 Simulation Results of MDC maximum residual energy LEACH	120
4.5.1 Energy consumption of sensor nodes, energy per packet and number of live nodes	120
4.5.2 Traffic received, packet loss ratio and packet inter-arrival time.....	123
4.5.3 Channel access and End-to-End delay	124
4.6 Simulation Results of other performance metrics	126
4.6.1 Time until first and last node dies	126
4.6.2 Node density vs. total energy consumption and vs. total traffic received.....	128
4.6.3 Energy consumption of MDC and number of live MDC's.....	130
4.7 Factors Influencing Simulation Results	131
4.8 Protocol Evaluation and Comparison.....	132
4.9 Chapter Summary.....	134
CHAPTER 5	135
CONCLUSION AND FUTURE WORK.....	135
5.1 Introduction	135
5.2 Summary of Protocol Design	135
5.3 Summary of Results	136
5.4 Future Work	137
5.5 Chapter Summary.....	138
REFERENCES	139
PUBLICATIONS	161
APPENDIX A.....	162
CODE FOR MOBILE DATA COLLECTOR BASED ROUTING PROTOCOL ...	162
APPENDIX B.....	200
CODE FOR MOBILE DATA COLLECTOR BASED ROUTING PROTOCOL ...	200
APPENDIX C.....	203
CODE FOR MOBILE DATA COLLECTOR BASED ROUTING PROTOCOL ...	203

LIST OF FIGURES

Figure 1.1 Study modules.....	7
Figure 2.1 Chip architecture of a sensor node [19]	14
Figure 2.2 Chip architecture of a node developed by UCB.....	14
Figure 2.3 OSI model layers.....	15
Figure 2.4 Sensor networks protocol stacks	17
Figure 2.5 Typical planar wireless sensor networks.....	22
Figure 2.6 Ad hoc configuration of Two-Tiered sensor network.....	23
Figure 2.7 Non ad hoc overlay configuration of Two-Tiered sensor network.....	23
Figure 2.8 A planar illustration of Three-Tiered sensor network architecture.....	25
Figure 2.9 Architectures of WSN-MEs with MDCs: (a) mobile sinks and (b) mobile relays.....	29
Figure 2.10 WSN-ME architecture with relocatable nodes.....	30
Figure 2.11 WSN-ME architecture with mobile peers.....	31
Figure 2.12 Taxonomy of the approaches for data collection in WSN-MEs	33
Figure 2.13 Typical sensor nodes architecture	36
Figure 2.14 Message receiving process flow for Flooding	38
Figure 2.15 SEER neighbor selection process.....	40
Figure 2.16 A Sample Network with its Tiers.....	41
Figure 2.17 Join operations in VCP.....	42
Figure 2.18 The M-SPIN Protocol	44
Figure 2.19 LEACH cluster configuration and transmission	47
Figure 2.20 Typical hierarchical clustering network topology.....	48
Figure 2.21 Architectural View of Hybrid multi-hop LEACH protocol.....	50
Figure 2.22 Hierarchical Routing [130]	52
Figure 2.23 CBR Mobile-WSN Time Line: (a) Node's Time Line, and..... (b) Cluster Head's Time Line [131]	53
Figure 2.24 Data collection by using multiple mobile nodes [143]	58
Figure 2.25 Sensor network with Mobile Data Collector [144]	59
Figure 2.26 ROME: Forwarding region of x [146]	61
Figure 2.27 Data transmission in LEACH protocol	65

Figure 2.28 Data transmission in Hybrid multi-hop LEACH protocol	66
Figure 2.29 Energy hole in Hybrid multi-hop LEACH protocol	68
Figure 2.30 Routing Hole in Hybrid multi-hop LEACH protocol	69
Figure 3.1 Proposed framework	75
Figure 3.2 Topology of MDC based LEACH hierarchy	76
Figure 3.3 MDC based LEACH operation time line	77
Figure 3.4 Set-up message process flow of MDC based LEACH.....	80
Figure 3.5 MDC Beacon Message.....	81
Figure 3.6 First order radio model.....	85
Figure 3.7 MDC minimum distance LEACH.....	89
Figure 3.8 Cluster head to MDC flowchart	90
Figure 3.9 MDC Beacon Message.....	91
Figure 3.10 MDC maximum residual energy.....	92
Figure 3.11 The network model	98
Figure 3.12 Node model of sensors	99
Figure 3.13 Node model of base station	99
Figure 3.14 Model attributes of sensor nodes.....	100
Figure 3.15 Process model of mobility.....	101
Figure 3.16 Process model of base station	102
Figure 3.17 Process model of Mobile Data Collector	102
Figure 3.18 Process model of Mobile Data Collector based LEACH routing protocol	104
Figure 3.19 Process model of Carrier Sense Multiple Access (CSMA) protocol	105
Figure 4.1 (a) and (b) Energy Consumption of Node 17 and 36	115
Figure 4.2 (a) Energy Per Packet (b) Number of Live Nodes	116
Figure 4.3 (a) Traffic Received (b) Packet Loss Ratio.....	117
Figure 4.4 Packet Inter-Arrival Time	118
Figure 4.5 (a) Channel Access Delay (b) End-to-End Delay	119
Figure 4.6 (a) and (b) Energy Consumption of Node 11 and 33	121
Figure 4.7 (a) Energy Per Packet (b) Number of Live Nodes	122
Figure 4.8 (a) Traffic Received (b) Packet Loss Ratio.....	123
Figure 4.9 Packet Inter-Arrival Time	124
Figure 4.10 (a) Channel Access Delay (b) End-to-End Delay	125

Figure 4.11 (a) and (b) First and Last Node Dies.....	127
Figure 4.12 (a) and (b) Node Density vs. Total Energy Consumption and.....	128
Total Traffic Received.....	128
Figure 4.13 Total Energy Consumption	129
Figure 4.14 (a) and (b) Energy Consumption and Number of Live MDC's	130

LIST OF TABLES

Table 2.1 Comparison chart of data centric routing protocol.....	44
Table 2.2 Comparison chart of hierarchical routing protocol	54
Table 3.1 Definition of short message.....	106
Table 3.2 Definition of information message.....	106
Table 4.1 Simulation setup	110
Table 4.2 Comparison of simulated protocols.....	133
Table 4.3 Comparison with Existing Protocols.....	133

LIST OF ABBREVIATIONS

ACK	Acknowledge Message
ADV	Advertisement Message
AMPS	Amplifiers
ANNOU	Announcement
APTEEN	Adaptive Threshold Sensitive Energy Efficient Network
ASIC	Application-Specific Integrated Circuit
A/D	Analog to Digital Conversion
BATR	Balanced Aggregation Tree Routing
BS	Base Station
CDMA	Code Division Multiple Access
CHs	Cluster Heads
CPU	Central Processing Unit
CSMA	Carrier Sense Multiple Access
DC	Direct Current
DSDV	Destination-Sequence Distance Vector
DSR	Dynamic Source Routing
DSP	Digital Signal Processors
EDC	Event-Driven Cluster
ESDs	External System Definitions
FPGA	Field-Programmable Gate Array
GBR	Gradient Based Routing
GPS	Global Positioning System
GSM	Global System for Mobile Communication

HEAR-SN	Hierarchical Energy-Aware Routing for Sensor Networks
HEER	Hybrid Energy Efficient Routing Protocol
ICI	Interface Control Information
IEEE	Institute of Electrical and Electronic Engineers, Inc.
ISO	International Standardization Organization
IT	Information Technology
JOIN-REQ	Join Request Message
LAN	Local Area Networks
LEACH	Low Energy Adaptive Clustering Hierarchy
MAC	Medium Access Control
MANET	Mobile Ad Hoc Networks
MDC	Mobile Data Collector
MEs	Mobile Elements
MSs	Mobile Sinks
MRs	Mobile Relays
MECH	Maximum Energy Cluster-Head
MEMS	Micro Electro-Mechanical Systems
MCFA	Minimum Cost Forwarding Algorithm
MIT	Massachusetts Institute of Technology
MTE	Minimum Energy Transmission
MWSNs	Mobile Wireless Sensor Networks
OPNET	Optimized Network Engineering Tools
OS	Operating System
OSI	Open System Interconnection
PC	Personal Computer
PDA	Personal Digital Assistant

PDF	Probability Density Function
PEGASIS	Power-Efficient GATHERing in Sensor Information System
PEQ	Periodic, Event-Driven and Query-Based Routing Protocol
QoS	Quality of Service
REQ	Request Message
RF	Radio Frequency
ROM	Read Only Memory
SEER	Simple Energy Efficient Routing Protocol
SPIN	Sensor Protocols for Information via Negotiation
STDs	State Transition Diagrams
TDMA	Time Division Multiple Access
TEEN	Threshold sensitive Energy Efficient sensor Network protocol
TTL	Time-to-Live
UCB	University of California, Berkeley
WSNs	Wireless Sensor Networks

CHAPTER 1

INTRODUCTION

1.1 Background

Technological developments during the last few years in the field of micro electro-mechanical systems (MEMS) and wireless communications have realized the idea of small nodes network; these small wireless nodes are capable of “sensing” any measurable phenomena in its immediate vicinity [1, 2]. The electronics of sensing can measure ambient conditions of the environment surrounding the sensor and transform them to an electronic signal message. The concept is to have a huge, collaborative network of entities being able to sense and wirelessly convey messages containing the sensed data to higher-level systems for analysis and reactive measures. These entities (or sensor nodes) form a wireless connected network to meet the intended application domain’s requirements. Industry accepts this network of nodes as Wireless Sensor Networks (WSNs). The network of nodes may consist of hundreds or even thousands of nodes, which implies that it should be very cheap to produce in large quantities and be adaptable to different application areas. The implementation and usage of WSNs may vary from environmental monitoring to biological applications and military applications concerned with surveillance, reconnaissance and targeting [1, 3, 4].

Every node is in restraint as a limited power supply comes to be essential concern in a consideration of the size and construction of a WSNs node. The functional lifetime of each node directly affects the performance of the WSNs as a whole. Collectively all the nodes within the WSNs should consume the least possible quantity of energy to prolong the lifetime of the total network.

The term “Sink” accepted as a base station that will collect and possibly store all the sensed information from each of the sensing nodes. The WSNs paradigm dictates

that there always be at least one base station, but need not be limited to one. Base stations typically do not have the same energy constraints as the majority of sensing nodes and should be the only interfaces to higher-level systems that will consume the sensed data. The sensing nodes are generally accepted as “source nodes” that will gather information from its sensors. The sensed information in the format of a message that will be transmitted wirelessly across multiple source nodes in an attempt to deliver the original sensed information towards the base station. The decision to create messages from sensed information is based on the WSNs applications, and may be requested from or initiated by a source node. A routing protocol is the mechanism implemented and utilized to determine the path a message should take to traverse the source nodes in an attempt to eventually reach the base station. The design of a routing protocol determines the amount of message transmissions and directly affects the energy efficiency of WSNs [4, 5].

Mobility in the mobility environment should be handled by WSNs protocols; these protocols recreate the topology of network by responding upon the sensor nodes mobility and rapidly elude accumulative packet loss. This research addresses the sensor nodes mobility in WSNs that collaborates with cluster based routing and Mobile Data Collector (MDC) nodes act as a relay node to forward the data towards base station. This protocol enables mobile sensor nodes to create clusters. After the formation of cluster, the cluster head receive the sensed data from sensor nodes and immediately forward the data towards the base station by the help of MDC, which is moving within the network. This protocol reduces the energy consumption of sensor nodes, resolve communication holes and provide reliable data message delivery from source to destination.

The succeeding subsections of this chapter are organized as follows: 1.2 describes the research motivation. Section 1.3 outlines the research questions, aims and objectives. The research thesis scope is demonstrated in section 1.4, while Section 1.5 illustrates the study modules in the form of a block diagram. Contributions of this research are discussed in Section 1.6. Section 1.7 provides thesis organization of remaining chapters. Finally, section 1.8 is summarizing the chapter.

1.2 Research Motivation

Mobility has been presented in WSNs architecture and becoming significantly suitable in a wide range of applications such as civil and military applications, disaster recovery, environmental monitoring, traffic control, structural monitoring, wildlife tracking, inventory management in industrial environments, robotic surveillance and medical care.

More and more portable digital computing devices has been taken into application in our lives such as mobile phones, laptops, Personal Digital Assistants (PDAs), mp3 and mp4 players, as technologies of digital integrated circuit and microelectronics develop. Thus, mobile wireless communication networks for connecting portable devices to make them interactive have drawn more and more attention. For example, wireless cellular networks used widely with fixed and wired base stations have been deployed all over the world for mobile phones in the Global System for Mobile Communication (GSM).

The other category in mobile wireless networks is ad hoc networks, often referred as a loose definition of wireless networks, which consist of a variety of devices and allow them to establish communication anytime and anywhere without any central infrastructure [6]. For the perspective of wide application, MANETs have a certain place for many researchers' interest [7]. Specialties of WSNs lead to special challenges; energy efficiency is one of the most critical considerations on design of WSNs, because sensor nodes are often inaccessible and hence their battery is not renewable in most cases. Moreover, different kinds of holes occur during communication in these networks like energy, routing and jamming holes, etc., that creates geographically correlated problem areas. In fixed infrastructure, all nodes need to cooperate to maintain connectivity because some of the nodes are chosen as intermediate nodes to forward data packets toward destination. Therefore, routing of data packets between a pair of nodes in an efficient way is an important issue of WSNs. The metrics used to evaluate protocols for WSNs are usually as follows:

- *Ease of deployment:* WSNs may contain numerous nodes that need to be installed in distant or risky conditions, enabling users to extract details in different methods. This involves that the protocol must be highly self-

organizing to deploy nodes autonomously and enable them to complete sensing tasks cooperatively.

- *Energy efficiency:* As described above, energy is quite precious in WSNs. Therefore, how to reduce energy consumption should be taken into account in every aspect of designing protocols for WSNs.
- *Prolong Network Lifetime:* Of course, lifetime of single node can be prolonged once the energy dissipation is reduced, but the term “lifetime” here is referred to as a metric of the whole network. The lifetime of the whole network is defined usually at the time while most of the nodes are in operation within the network, because end users interested in whole network information not only part of specific nodes. Thus, in addition to reduce energy dissipation of each node as much as possible, keeping balance energy consumption among all nodes must be considered in design of protocols to ensure that the network stays alive as a whole as long as possible.
- *Communication Holes:* Numerous irregularities can arise in the wireless sensor networks due to energy, routing, coverage, sink/black and jamming holes that can impair their functionality. In the designing of routing protocol must be considered to avoid these holes to maintain the performance of the network in an efficient manner.
- *Quality:* This definition in WSNs is different from that in MANET, users care for high-level description of monitored events in certain region, not all data packets. Therefore, the quality of WSNs referred as the quality of data information required by end users.

There are two ways to enhance Energy performance; a good hardware and software design. The hardware viewpoint might contain hardware platforms which are low power in nature, for example, a low power wake-up radio, or energy efficient transceivers and a low power Central Processing Unit (CPU). The software perspective comprises making energy efficient software for the overall system [8, 9, 10]. The emphasis of this research dissertation is to improve network lifetime with data message reliability from the software perspective by the help of efficient routing.

1.3 Research Questions, Aims and Objectives

The overall quest of the research project can be formulated as follows:

- How to minimize the energy depletion of communication by reducing the transmission distance operation?
- How to balance network performance that adequately maintains latency while at the same time improving data reliability in the context of energy efficiency?
- What is the optimal sensor nodes deployment architecture for effective nodes collaboration in data collection based on sensed environment?
- Finally, what are the energy and data reliability benefits in such a design?

This research dissertation investigates the existing routing protocols for both traditional WSNs and Mobility Aware routing protocol and develops Mobile Data Collector (MDC) based clustering routing protocol namely referred in this research dissertation as MDC based LEACH. The proposed protocol compares with Low Energy Adaptive Clustering Hierarchy (LEACH) Protocol and A Novel Application Specific Network Protocol for Wireless Sensor Networks (Hybrid multi-hop LEACH) routing protocol. The MDC based LEACH combines three-tier hierarchical architecture, cluster based design, multi-path and multiple-hop routing strategy to improve energy efficiency of sensor nodes, prolong network lifetime, avoid communication holes and data transport reliability.

Many protocols proposed for WSNs adopt cluster based hierarchical network architectures due to high correlation of the data from surrounding nodes. The main idea of hierarchical protocols is to break the network into a number of clusters; each cluster makes a cluster head that takes the tasks of control, data fusion and communication with other clusters and terminal. While in traditional communication, many routing protocols adopted a multi-hop routing strategy that requires forwarded data packets to take several hops among nodes before they reach the final destination. MDC based LEACH utilizes a multi-hop routing strategy for inter-cluster communication instead of a direct transmission in order to minimize transmission energy between cluster heads to the base station by the help of MDC. This proposed routing protocol also resolves the issues of communication holes in the form of

energy and routing holes, and provides higher data traffic rate than other cluster based routing protocol. In order to achieve this, the following objective ought to be accomplished:

- Develop a Rendezvous-Based solution for Energy optimization and data transport reliability in hierarchical cluster based routing for Mobile WSNs.

Analytical and simulation results validate that MDC based LEACH can attain better performance in terms of energy efficiency of sensor nodes, overall network lifetime and data transport reliability.

1.4 Scope of Work

In mobility environment, the major source of packet loss is the mobility of sensor nodes. This research work focus on MDC based clustering routing protocol to support mobility in WSNs and avoid the inconsistency that may take place when network layer protocols are designed completely separated from transport layer protocols. Clustering approach employs three-tier mobile WSNs architecture and mobile data collector act as relay agent to making efficient routing protocol. This protocol assumes a single hop between sensor nodes and the cluster head. Clustering hierarchy with multi-hop routing among the sensor node and the cluster head is beyond the scope of this work, since multi-hop routing causes high route breaks and needs more route maintenance to keep network connectivity.

Mobile Data Collector based cluster routing protocol propose, simulate and authenticate with different approaches for environmental applications, which is based on multi-hop routing strategy. MDC based LEACH utilizes self-organized sensor nodes with distributed cluster formation technique, randomly selection of cluster heads to equally balance the energy consumption among the sensor nodes and finally forward the data towards the base station by the support of Mobile Data Collector (MDC).

1.5 Study Modules

Figure 1.1 explained the flow of our research project. The bold lines characterize the route followed in this thesis to accomplish our goal and objectives.

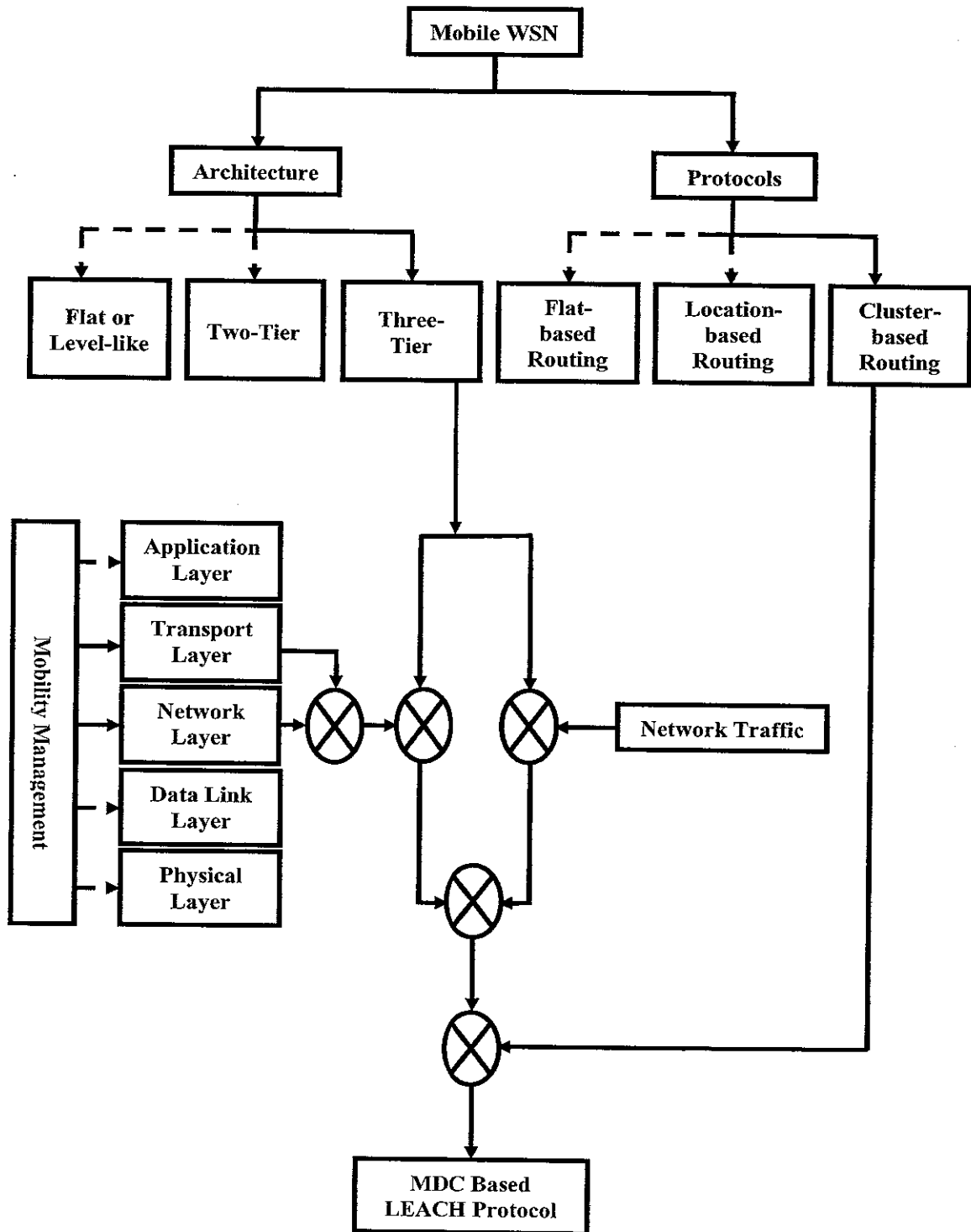

Figure 1.1 Study modules

However, the scattered lines are denoting to other research areas that are beyond

the scope of this research work. According to the figure, the sensors mobility can be handled in all of the layers structure. This research handles the mobility of sensor nodes in MAC and routing layers; cluster based architecture and mobile data collector is chosen as the routing protocol.

1.6 Research Contributions

This research work has made a significant contribution in Wireless Sensor Networks particularly mobility environment. As identified and discussed earlier during the transmission from the source node to the base station the data packets take single or multi hop routing strategies. Existing protocols utilizes both routing strategies but still in these protocols has ample gap between energy efficiency and data reliability in mobile WSNs.

The proposed and developed mobile data collector based routing protocol (MDC based LEACH) succeeds in providing tolerance to mobile nodes and mobile data collector in WSNs. This tolerance is evident in the protocol's ability to ensure energy efficient and higher successful message delivery towards the base station with the support of mobile data collector, as compared to other protocols. The mechanism providing the tolerance to mobile data collector does though consume more End-to-End delay in these scenarios, this elevated End-to-End delay however still maintains the acceptable limits and is justified maintaining a high message delivery in the network. The main contributions of this research dissertation are described as follows:

- Development of three-tier Mobile WSNs architecture with mobile data collector in hierarchical cluster based routing protocol, to utilize network resources efficiently.
- Cluster head selection based on randomized selection and residual energy of node.
- Sensor nodes are mobile, using multi-hop and multi-path routing strategy.

- The increase of energy efficiency of sensor nodes through designed protocol, subsequently enhancing the overall network lifetime and improving data gathering towards the base station.
- Finally, introduced a new flavour of LEACH cluster based routing protocol.

The higher stability of the designed protocol is reflected in WSNs application, once compare with LEACH and Hybrid multi-hop LEACH existing protocols.

1.7 Dissertation Outline

This research dissertation is categorized in five chapters, with the summary of each chapter being described below:

Chapter 1 – Introduction

This introduction provides background information on the subject area and presents the specific problem that motivated this research work. The chapter introduces research aims, objectives and highlights the main contributions of the research. Finally, the study model is introduced at the end of this chapter.

Chapter 2 – Literature Survey

Literature survey presents a brief overview and summary of the body of knowledge covering WSNs network principles, mobile wireless sensor networks and data collection techniques with mobile element. In addition, WSNs protocol stack, hierarchical architecture of mobile WSNs and its types, aims and challenges of mobility in WSNs, mobile elements and its classifications, data collection mechanism and mobility impact in WSNs are explained.

Review of existing routing protocols summaries the seminal contributions to WSNs routing protocols. This chapter also study on design consideration in WSNs routing protocol and review of data centric, hierarchical-cluster and mobility based routing protocols are discuss in detail.

Chapter 3 – Design of Mobile Data Collector based Hierarchical Clustering Routing Protocol

The design consideration of proposed mobile data collector based routing

protocol, proposed framework and topological architecture including critical evaluation of benchmark protocols are explained in this chapter. Moreover, this chapter also provides some background on the simulation environment and assumptions that are kept constant during simulations, simulation tool and its different models are discussed in detail.

Chapter 4 – Results and Discussion

Results and discussion presents the experimental principles and procedures used to produce a set of simulation results. The presented results are objectively analyzed, discussed and continues with the explanation of factors influencing simulation results.

Chapter 5 – Conclusion and Future Work

Finally, last chapter concludes the whole research work and recommendations for future work are provided as well.

1.8 Chapter Summary

This research investigates, defines and proposes a mobile WSNs routing protocol that is energy aware, scalable and tolerant to topological changes due to mobile nodes and Mobile Data Collector by following the described research methodology.

CHAPTER 2

LITERATURE SURVEY

2.1 Wireless Sensor Networks (WSNs)

Wireless communication technology and accessibility of micro-sensors that are compact, lightweight and portable computing devices in nature to construct distributed sensing and computing into a possible and practical way.

2.1.1 Introduction

The fashion of MANET is applied to these distributed sensing system networks leading to a special kind of MANET, Wireless Sensor Networks (WSNs). It can achieve collection, aggregation and communication of data from inaccessible terrains over many distributed separate sensor nodes called micro-sensors, which are linked by radio links [11, 12]. Sensor networks have been widely envisioned to enable long-term, near-real-time observations at unprecedented fine spatiotemporal resolution, which makes it possible for domain scientists to measure properties that have not been observed previously [13].

Although WSNs is a kind of MANET, it has some specialties different from MANET. The main task of general MANET is communication and their data rates are quite high usually, having strict time delay and synchronized constraints. On the other side, WSNs focus on collecting data and have more energy and simplicity constraints without very high data rates. Main challenges in WSNs are wise usage of battery power, extending the lifetime of the network, safe and accurate transmission of data through channel with small energy consumption. To address these challenges, it is very important to have network that can detect any kind of disconnection of wireless

link or message loss to have good routing mechanism. Sensor networks are a distributed small sensing devices provided with short-range wireless communications, memory and processors. This kind of network differs from conventional ad-hoc networks [14, 15]. The specialties of WSNs are recognized as follows:

- The amount of sensor nodes in WSNs could be very large and the density of nodes can be very high.
- Sensor nodes should be very small, light and low bit rate usually less than one hertz.
- WSNs must have ultra-low energy consumption, because sensor nodes are battery driven and it is impossible to replace batteries on thousands of nodes.
- WSNs should be firmly self-organizing and the communication range of every sensor node should be flexible.
- Sensor nodes must be very cheap so that thousands of them could be easily deployed.

2.1.2 Node hardware architecture for WSNs

The prospective for cooperative, scalable WSNs has concerned a new and emerging area of research consideration. Wireless Sensor Networks (WSNs) play an important role in Smart Grid that is developed for the monitoring of critical military or civilian infrastructures are endowed with many unique features that are not available in conventional wireless networks. Many of the land infrastructures such as bridges, tunnels and buildings have extremely long life cycle in the order of years or decades, with very slow changing rates [16, 17].

Wireless sensor nodes are supplied either by batteries or by some kind of energy harvesting system, which provides the necessary power. These energy-harvesting systems can be vibration or thermal based or they can convert energy from the electromagnetic field. Wireless sensor node is to collect, process and distribute physical data, it should be positioned as close as possible to the object. This means that it may be placed in a harsh environment where it is inconvenient or even dangerous to replace the battery or the sensor node may not be accessible at all, making maintenance operations impossible. Therefore, it is mandatory to keep the

power consumption of wireless sensor nodes as low as possible in order to ensure a long lifetime in case of battery-powered systems or to make the use of an energy harvesting system possible. Hence, considerable effort has to be spent to design an energy-efficient power management unit [18].

The Smart Dust project [19] worked on minimum-size solution for distributed sensing and selects coin-sized motes with optical communication. The research group at the Massachusetts Institute of Technology (MIT) developed AMPS sensor node architecture as shown in Figure 2.1 in the project of WSNs. According to Figure, the general hardware architecture of sensor nodes in WSNs can be obtained, the power is provided by a battery through suitable voltages DC-DC transformation that is essential for whole system. Data collected by the integrated sensors from environment are digitized firstly through an A/D convertor, and then are processed by an embedded microprocessor (Strong ARM 1100) and uses Application-Specific Integrated Circuit (ASIC) or Digital Signal Processors (DSP) that is optional. The node communicates with adjacent nodes through a radio transceiver, and node itself contains TinyOS operating system, sensor algorithms and network protocols are stored in ROM. The computation and the upper communication protocols are implemented by the microprocessor; The University of California, Berkley researchers has built sensor node architecture as shown in Figure 2.2 [20].

More consideration on the tradeoff between energy efficiency and flexibility is taken in this model. Some configurable processing modules are added for example, some parts of processing and computation tasks are allocated to Field-Programmable Gate Array (FPGA), reconfigurable finite-state-machine and dedicated DSP. The system also has a reconfigurable data path; all these designs allow the system to emulate tasks that are assigned to configurable or custom logic on a chip. In other words, most existing sensor nodes prototypes are traditional circuit boards with standard modules, which are generally available in market.

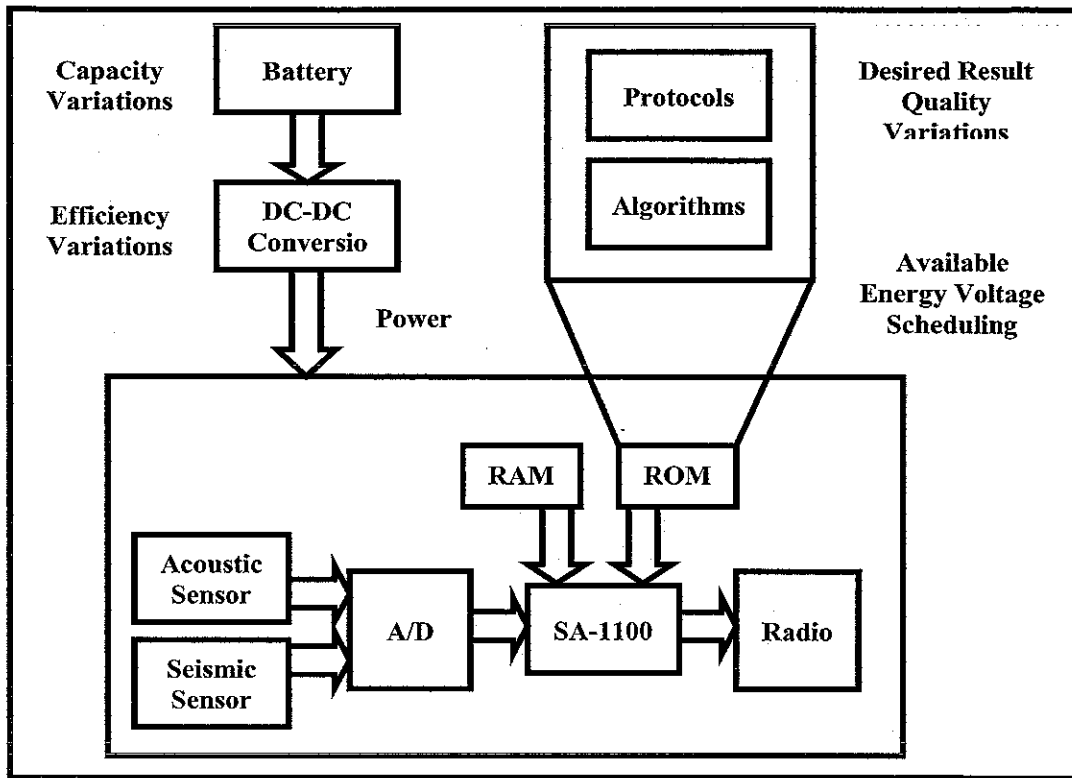

Figure 2.1 Chip architecture of a sensor node [19]

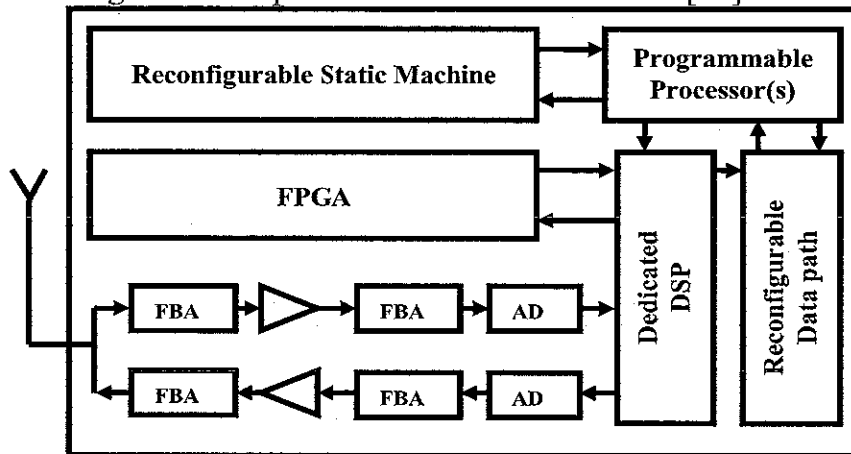

Figure 2.2 Chip architecture of a node developed by UCB

The Pico Radio group in UCB developed a Pico Radio test bed [21], a general-purpose emulation platform, which contains of a power board, a digital board, a sensor board and a radio board.

2.1.3 WSN Open System Interconnection model

Rising generations of wireless telecommunication networks vary increasingly in term of topologies, applicabilities, data volume forwarding as well as dependence on the nature of exchanged information. The International Standardization Organization (ISO) specified a layered model for Open System Interconnection (OSI), named ISO/OSI Reference Model in 1984, generally accepted for almost all communication systems in use nowadays. The OSI model divided the entire system into seven individual well-defined layers; each layer carries out one or several functions and offers services to the layer directly above it, with the exception of the top layer and each layer represent a new level of abstraction from the layer below it. This hierarchical architecture makes it easier for developers, providers and users of communication systems to understand, develop and standardize protocols. If one layer is updated, it will not affect others [22, 23]. Figure 2.3 shows brief description of the OSI seven layers are described below.

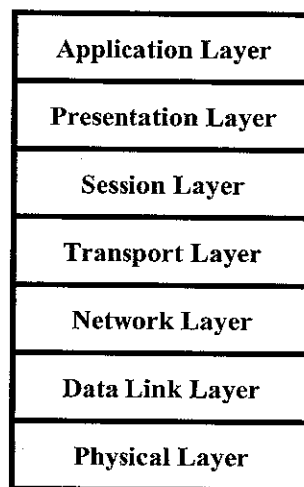

Figure 2.3 OSI model layers

- *Physical layer:* The primary layer of the OSI model is physical layer, which describes the signal, and mechanical characteristics, e.g. synchronizing techniques, modulating techniques, signal coding and standardizing plugs. It addresses the transmission and reception of data on a carrier signal through radio channel.
- *Data link layer:* The data link layer is responsible to interpret the data stream from the physical layer and forward them to the network layer. It contains errors detection/correction and encoding/decoding mechanisms to eliminate

bit errors in data packets. This layer includes a sub layer, Media Access Control (MAC) layer. It controls permission regulation of access to the medium that can interfere with each other.

- *Network layer:* The network layer is responsible for the operation of data transfer between nodes within network. It includes routing algorithm and address interpretation to select an optimal path when a data packet is ready to be transmitted. This layer also has tasks of multiplexing connection, congestion control and packet sequencing. Network layer, data link layer and physical layer are three infrastructure layers in communication networks and network-dependent, they are closely related to the service provider.
- *Transport layer:* The transport layer controls End-to-End data transport. Besides error handling, data security is also assigned to the tasks of this layer. The transport layer is the mediate layer between lower-ranking layers and higher-ranking layers and provides a service to higher-ranking layers of communication application processes.
- *Session layer:* The session layer controls the data exchange between terminals in network.
- *Presentation layer:* The presentation layer is responsible for data format transformation, data encryption and compression.
- *Application layer:* The application layer is an application process and acts as the interface to end user.

Session layer, presentation layer, and application layer are network-independent layers and related to the service user closely.

2.1.4 WSNs protocol stack

The traditional TCP/IP protocol suite is not suitable to be used in a WSNs environment. Some of the protocol modules have to be removed due to the resource limitation of sensor nodes [24, 25]. The commonly accepted model for the WSNs protocol stack is adapted from the established Open Systems Interconnection (OSI) reference protocol stack that is used in IT and Telecommunication. The WSNs protocol stack enables integration between application and routing layer, power

awareness, routing capability and efficient wireless transmission within the nodes. The layers within the protocol stack are represented in Figure 2.4 [26].

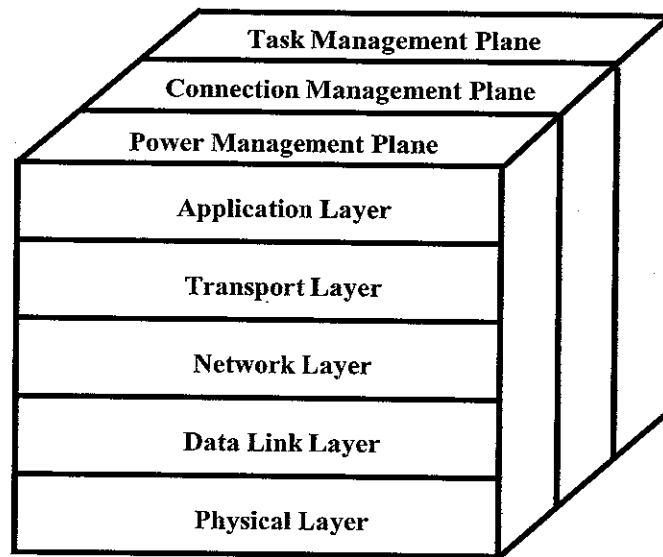

Figure 2.4 Sensor networks protocol stacks

The responsibilities of each layer can briefly be explained as:

- The physical layer provides the wireless communication radio interface and ensures successful transmission of data by implementing robust signal modulation and transmission techniques (sending/receiving messages).
- The protocol implemented on the data link layer is typically known as the MAC protocol. MAC protocols are typically expected to be power aware, perform noise filtration and minimize message collision with neighbouring nodes transmissions.
- The network layer implements the routing protocol that is the research area of this thesis.
- The transport and application layers are commonly used to form a single layer; this layer ensures the flow of data and is responsible for hosting the application software depending on the sensor requirements.
- Continued academic research has shown an interest in breaking down the boundaries between the layers in the protocol stack. This research work would produce a “cross-layered” approach to bridge the boundaries among any of the currently accepted layers or even merge some of these layers. It is however not the focus of this dissertation and will not be elaborated further. The interested reader

may consult sources such as [27] and to a lesser extent [28] for more information see on “cross-layered” protocol designs.

There it is mentioned in [26] of additional functional planes, to support responsibilities at each layers of the protocol stack to improve energy efficiency in WSNs, these planes are responsible for power, mobility and task management. The power management plane dictates how power is managed within a node, such as sending out notifications when the available power reaches a predefined limit. The mobility plane is responsible for knowing neighbor nodes and the nodes' mobility status to base decisions on neighbor status and routing on. The task management plane takes care of sharing tasks between nodes to ensure that some nodes are not over utilized and shortly become unavailable.

2.1.5 Applications of WSNs

Unlike traditional networks, WSNs has its own design and resource constraints. Resource constraints include a limited amount of energy, short communication range, low bandwidth and limited processing and storage in each node. Design constraints are application dependent and based on the monitored environment. The environment plays a key role in determining the size of the network, the deployment scheme and the network topology. The size of the network varies with the monitored environment. For indoor environments, fewer nodes are required to form a network in a limited space whereas outdoor environments may require more nodes to cover a larger area [29].

Researchers in UCB consider typical applications scenario, where WSNs were called Pico Radio networks [30]. In large office buildings, environment control systems are deployed to adapt the microclimates such as temperature and airflow to the preferences of occupants that improve the living conditions and reduce the energy budget. As mentioned above, WSNs can achieve data collection from some remote or inaccessible terrains. This application can be found widely in astronautic field and environment pollution monitoring. In [30] a kind of wireless integrated network sensors are presented that are applied in sensing for mission and flight systems. WSNs with miniature sensor nodes are implementing in some medical examinations to help

doctors get correct diagnosis.

Environmental monitoring applications of WSNs are accepted in literature: In [31] proposed a system could monitor several environmental parameters such as underground water level, barometric pressure, ambient temperature, atmospheric humidity, wind direction, wind speed and rainfall and provide various convenient services for end users who can manage the data via a website from long-distance or applications in console terminal. The authors of [32] propose a novel framework that can be used to guide the design of future WSNs that provide environmental monitoring services. The focuses of the framework are 1) the future WSN shall be heterogeneous, 2) the network layer design will better meet the requirements of applications and services, 3) the network layer design shall be able to utilize advanced wireless communication technologies, and 4) the network layer can provide the monitoring functionality.

The technical objective of [33] REALnet is to monitor physical parameters from the air (atmospheric temperature, humidity, pressure and ambient light), ground (humidity, temperature) and water (level, temperature, conductivity). The main contributions of [34] are twofold firstly; the identification of scenarios where single hop communication, between multiple sensors and a base station is both feasible and offers benefits with respect to power preservation. Secondly, the design implementation and evaluation of the Power and Reliability Aware Protocol (PoRAP) which can minimize energy consumption whilst preserving reliability is presented. The author of [35] is to design, implement and performance evaluation of sparse WSNs that has been working maintenance free for a long period. The network has been designed for environmental monitoring purposes and several nodes attached to lampposts, accurately measures the Temperature and Relative Humidity at various locations in a local street. In [36] propose of implementing a wireless sensor network (WSN) system is to remotely monitor the water quality.

2.2 Mobile Wireless Sensor Networks (mobile WSNs)

One of WSN types where mobility comes to be a core part in executing application.

2.2.1 Overview

Mobile Wireless Sensor Networks (mobile WSNs) is another kind of WSNs where mobility is utilized as a major part of application execution. Nowadays, scientists and companies are completely motivated to preserve mobility within WSNs. In recent years the awareness of mobile WSNs in the perspective of ubiquitous networks has been developed, Marc Weiser is the first innovator of this idea in 1991 [37]. The presence of mobile sink or agents is a new and emerging concept in the field of Wireless Sensor Networks (WSNs), now mobility in WSNs is regarded as an advantage versus problem. Scientists have already performed some preliminary work to improve the overall performance in WSNs with the presence of mobility. The outcomes validate that the mobility increases the network lifetime and further enhance the data reliability as well. Delay and latency problems are also dealt in specific situations in mobile WSNs; most of the essential features of mobile WSN are the same as that of regular fixed WSNs [38 - 44]. Major mobile WSNs parameters over WSNs are:

- *Localization:* In static WSNs, the position of node is able to determine during initialization, but in mobile WSNs nodes move frequently change their position within the sensing region. This demands supplemental time, power and quick localization service accessibility as well.
- *Power consumption:* WSNs and mobile WSNs have different power consumption models. In both communication networks major achievement in energy cost, is used efficiently. However, mobile communications are demanding more mobility power and self-charging that can connect to the mains to recharge the battery and repeatedly much higher energy storage [45].
- *Network Sink:* The sensor data is communicated to the base station in centralized WSNs applications, where they can be treated with an appropriate resource. Routing and aggregation of sensor data may acquire significant

costs. A number of base stations of mobile WSNs, passing through the territory of sensors to collect data or positioned that will decrease the number of transmission hops connecting the sensor node and the base station.

- *Mobility*: The enriched mobility in mobile WSNs enforces certain limitations on the previously recommended MAC and routing level WSNs protocols. Furthermost effective protocols in fixed WSNs are performed badly in situation of mobile WSNs.
- *Dynamic Topology of Network*: Existing routing protocols of WSNs that explain how the messages travel or data then they probably arrive at destination, usually based on routing tables or up to date path records. In dynamic topologies data array becomes obsolete quickly and the discovery of the route should be done several times at considerable cost in terms of time, bandwidth and power [46 – 49].

2.2.2 Hierarchical architectures

The multi-tier architecture uses old-fashioned WSNs in literature; this section provided the information of planar or flat and multi-tier architecture of WSNs in detail [50, 51].

2.2.2.1 Planar or Flat network architecture

Generally, WSNs is consisting large amount of fixed nodes spread through a certain regional area and multi-hop ad hoc fashion utilizes from source sensor to base station. These homogeneous sensor nodes have estimated energy efficiency, communication, sensing and storing abilities. Figure 2.5 explains an example of planar or flat wireless sensor systems [52].

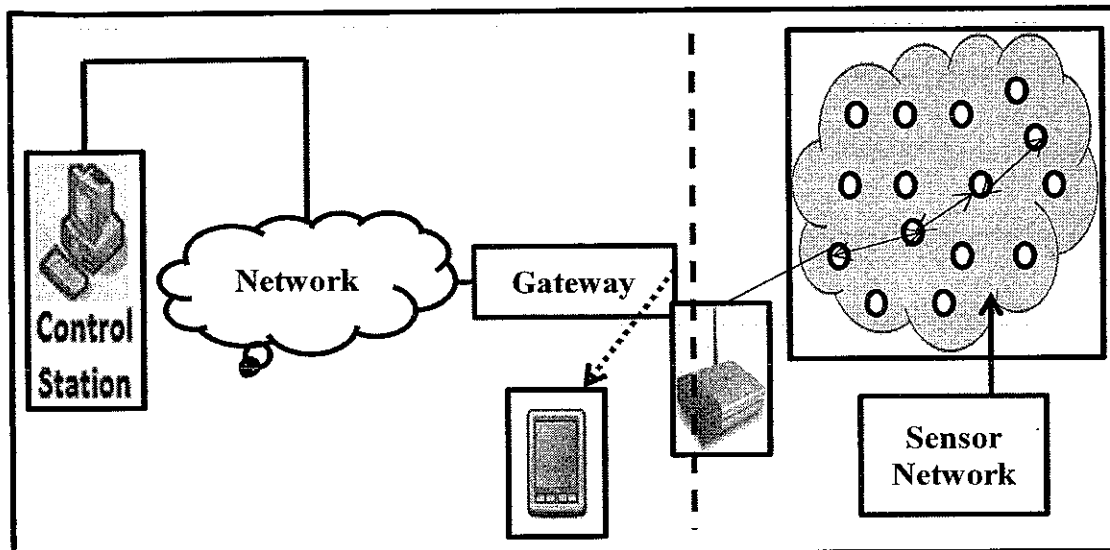

Figure 2.5 Typical planar wireless sensor networks

Planar or flat WSNs usually present some disadvantages on system performance while using ad hoc model. The efficiency per node falls asymptotically while increasing the nodes there is possibility that a specific data might be lost when data is travelling from source to destination in multi-hop fashion and the situation going more worst when the network size increases. Energy of nodes is falling down rapidly due to communication between adjacent nodes, because adjacent nodes forward the data to another neighboring node. The overall network is bigger, more nodes essential to forward data that consumes more energy so the result is network grows but performance destroys [52].

2.2.2.2 Two-Tiered network architecture

Mobile devices perform as a relay agent in upper overlay two-tiered mobility assisted wireless sensor networks. Cellular phone, PDA and table PC are the real example of mobile agents by the advancement of wireless technologies and microelectronics. Furthermore, majority of these devices have extra ability to process complex computing, storing and communicating in large amount of data packets. Heterogeneous WSNs are used these features which acts as overlay structure elements, Figure 2.6 and 2.7 as brief illustration of two-tiered architecture.

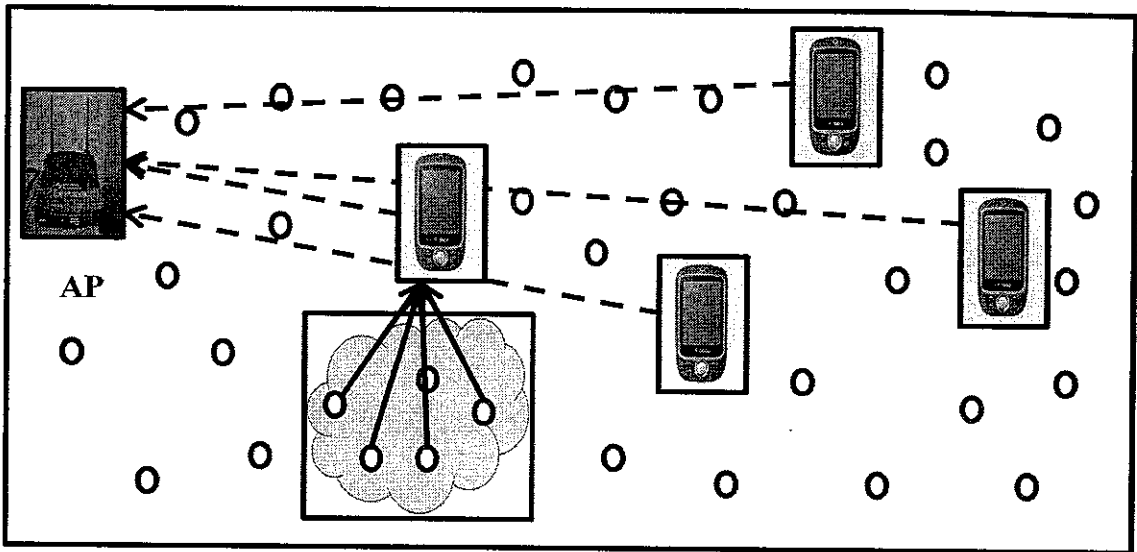

Figure 2.6 Ad hoc configuration of Two-Tiered sensor network

The main difference between these two architectures is overlay-networking topology. Mobile devices are self-organized in an ad hoc fashion characterized as mobile agents. Meanwhile the mobile overlay topology is temporary and random dependent on the mobile agent's position.

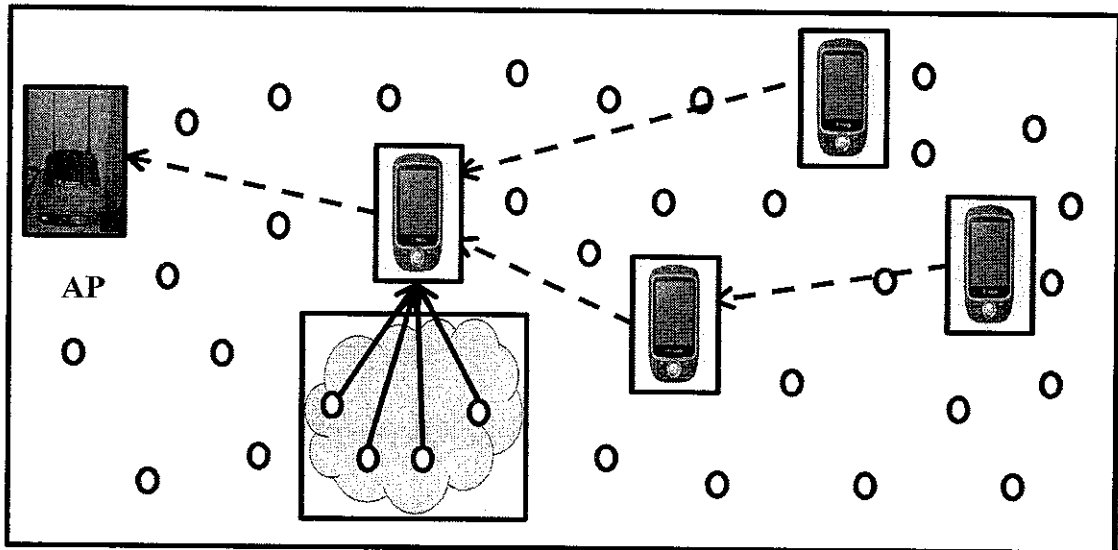

Figure 2.7 Non ad hoc overlay configuration of Two-Tiered sensor network

Slower movement of the mobile agents can preserve the overlay network more progressively; Bluetooth and IEEE 802.11 are appropriate innovative techniques to construct the wireless unified networks. The above-mentioned architecture is not suitable solution where mobile phones are small and the overlay networks are sparse. The most appropriate architecture is explained in Figure 2.7 where sensors nodes data

are stored near the neighborhood of each mobile phone. It stores the data in its existing memory and does not transmit to other nodes and access points. The memory of mobile agent must be enough to avoid data loss and keep the data until it is forwarded to mobile agents. Data loss is dependent upon the rate of data gathering by sensor nodes and maximum acceptable delay of data distribution based on mobile agents' round trip time [53].

2.2.2.3 Three-Tiered network architecture

Three-tier architecture of mobile WSNs is based on ad hoc and non-ad hoc overlay networks by relating the benefits of mobile agents and fixed access points acting as overlay elements together. This type of architecture decreases the number of access points because mobile agents are one-hop near to sensor nodes and mobile agents are fully responsible to forward sensor nodes data towards final destination. Therefore mobile agents could not inverse the scaling performance; it reduces the power consumption and number of access points which are valued properties in many sensor applications. Moreover, these typical and hypothetical issues of networking particularly for applications of sensing, some additional benefits of hierarchical heterogeneous layering that is not possible to achieve in flat-based homogenous sensors networks because of energy limitation and managing capabilities. The medium layer devices act as relay in three-tier architecture to caching and forwarding the aggregated data towards destination that is why mobile agents help to maintain energy limitations of sensors by monitoring the communication in their vicinity.

Furthermore, the performance of overall system can significantly increase in terms of flexibility, longevity, reliability and throughput in variety of sensor applications by better computing, more power and communication capabilities of higher-layer network devices. Sensor nodes are randomly deployed in lowest layer of three-tier architecture that are directly communicating with mobile agents of medium layer, this type of communication create ad hoc networks which is unnecessary. The mobility is the vital part of middle layer devices, responsible for data gathering and forwarding from lower to upper layers; these devices can easily move anywhere at any time. The devices of higher layer are particularly number of access points, which are normally

in fixed networks; this type of networking established on wireless or wired medium and deployed in Ad Hoc or Mesh network models. Access points of IEEE 802.11 and cellular base station of mobile networks can be used as access points of sensor networks in three-tier network architecture, this upper layer also provide WSNs communication on inter-city level.

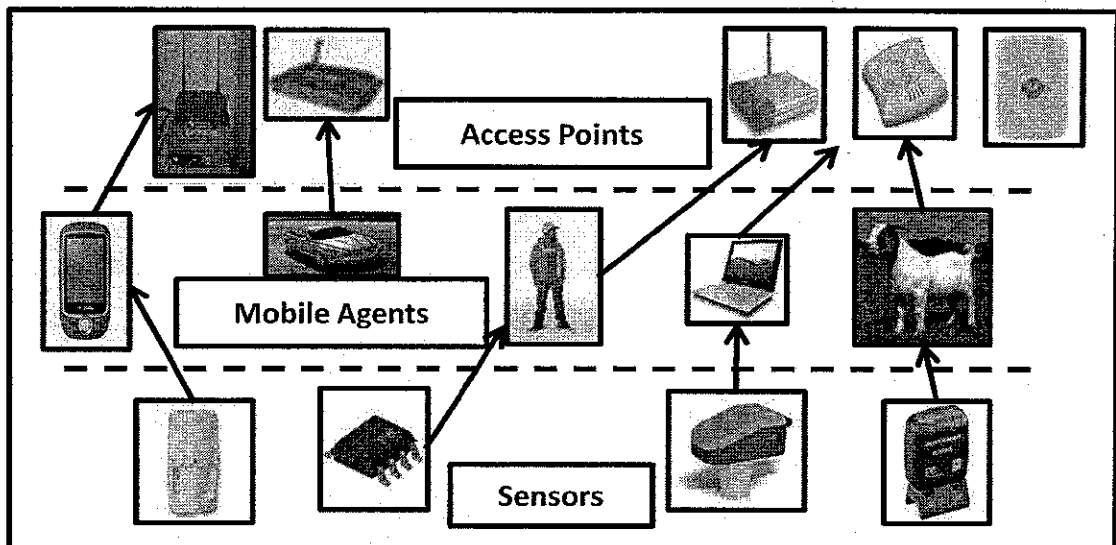

Figure 2.8 A planar illustration of Three-Tiered sensor network architecture

The combination between these layers is illustrated in Figure 2.8, in which mobile agents are in the arrangement of men, mobile phones, vehicles and even animal with different characteristics like controllable and predicted mobiles and some are random.

2.2.3 Types of mobile WSNs

Nowadays two types of mobile wireless sensor networks exist based on communication type. The first category is infrastructure network where the mobile devices are directly communicated with nearest sink in its network vicinity, such as existing cellular communication systems. Another category is known as ad hoc network that is infrastructure-less systems. This type of network does not need any fixed routers because all mobile units are self-organized, communicating in random fashion and easily move anywhere at any time [54].

2.2.4 Benefits of mobile WSNs

This section explains the advantages of mobile wireless sensor networks over traditional WSNs because of sensor mobility and mobile agents act as relay at middle layer of three-tier architecture. Some mobile WSNs advantages over static WSNs are presented herewith [43, 54]:

- Usage of energy efficiency is the main benefits of mobile WSNs, the overall network of static WSNs die early because of some nodes are near to the sink and continuously lose their energy first but in three-tier architecture of mobile WSNs the energy dissipation of sensor nodes is more efficient.
- Better targeting is another advantage of mobile WSNs, the utmost requirement in sensor network is to collect the data from edges of the network area because nodes are deployed randomly and mobility enhanced the quality of communication among the sensor nodes.
- Another benefit arises in the shape of data reliability, when the data packet has to travel from source to destination the error probability increases due to increase in number of hops. If restrict the limited number of hops then immediately reduce the error probability, which directly impact to increase the reliability of data and decreases the energy dissipation of static nodes because of retransmission of data packets due to error probability.

2.3 Data Collection Techniques with Mobile Elements

Traditional WSNs architectures consist of static nodes, deployed randomly in sensing area. Recent development in the field of WSNs utilizes mobile elements (ME) act as relay agent to collect the data from sensor nodes and forward to the sink.

2.3.1 Overview of mobile elements in WSNs

To better understand the specific features of wireless sensor networks with mobile elements (WSN-MEs), let us first introduce the reference network architecture, which is detailed according to the role of the MEs. The main components of WSN-MEs are

the following.

- *Regular sensor nodes* (or just nodes, for short) are the sources of information. Such nodes perform sensing as their main task and may also forward or relay messages in the network, depending on the adopted communication paradigm.
- *Sinks (base stations)* are the destinations of information. They collect data sensed by sensor nodes either directly (i.e., by visiting sensors and collecting data from each of them) or indirectly (i.e., through intermediate nodes). They can use data coming from sensors autonomously or make them available to interested users through an Internet connection.
- *Special support nodes* perform a specific task, such as acting as intermediate data collectors or mobile gateways. They are neither sources nor destinations of messages, but exploit mobility to support network operation or data collection.

Note that mobility might be involved at the different network components. For instance, nodes may be mobile and sinks can be static, or vice versa. In any case, we define a WSN-ME as a network where at least one of the above-mentioned components is mobile. When there are only regular nodes, the resulting WSN-ME architecture is *homogeneous* or *flat*. On the other hand, when support nodes are (also) present the resulting WSN-ME architecture is *non-homogeneous* or *tiered*. Furthermore, different from traditional WSNs, which are usually limited to be dense, WSN-MEs can also be sparse. As the network, architecture strongly depends on the role of the MEs.

2.3.2 Classification of mobile elements

This section introduces the different types of mobile elements (MEs) with increasing level of mobility, by focusing on architectural aspects.

2.3.2.1 Mobile Data Collectors (MDCs)

These mobile elements are visiting the network to collect data generated from source

nodes. Depending on the way they manage the collected data, MDCs can be either *mobile sinks* or *mobile relays*.

- *Mobile Sinks (MSs)* are mobile nodes; destination of messages originated by sensors and represent the endpoints of data collection in WSN-MEs. They can either autonomously consume collected data for their own purposes or make them available to remote users by using a long-range wireless connection. The MS-based WSN-ME architecture is illustrated in Figure 2.9 (a). In these cases, ordinary sensor nodes are static and densely deployed in the sensing area. One or multiple MSs move throughout the WSNs to gather data coming from all nodes. Note that the path between the source nodes and the MSs is multi-hop, although the actual path changes with time since the position of the MS is not fixed [55, 56 and 57].
- *Mobile Relays (MRs)* are support nodes, which gather messages from sensor nodes. They are not the endpoints of communication, but only act as mobile forwarders. This means that the collected data move along with them, until the MRs will obtain the contact with the sink or base station. The MR-based WSN-ME architecture is illustrated in Figure 2.9 (b). Data-MULE networks uses three-tier architecture, where the middle tier is represented by relays, called *mobile ubiquitous LAN extensions (MULEs)*. Static sensor nodes wait for a MULE to be in contact before starting communication. Then the MULE collects data and moves to different locations, eventually passing by the base station, where the gathered data is stored and made available to remote users [58 - 61].

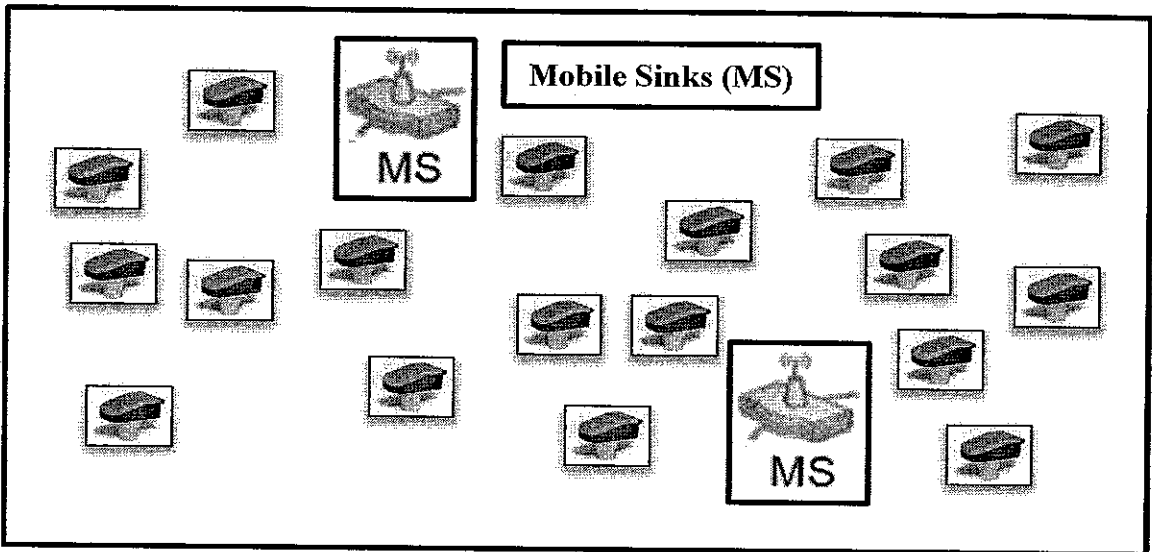

(a)

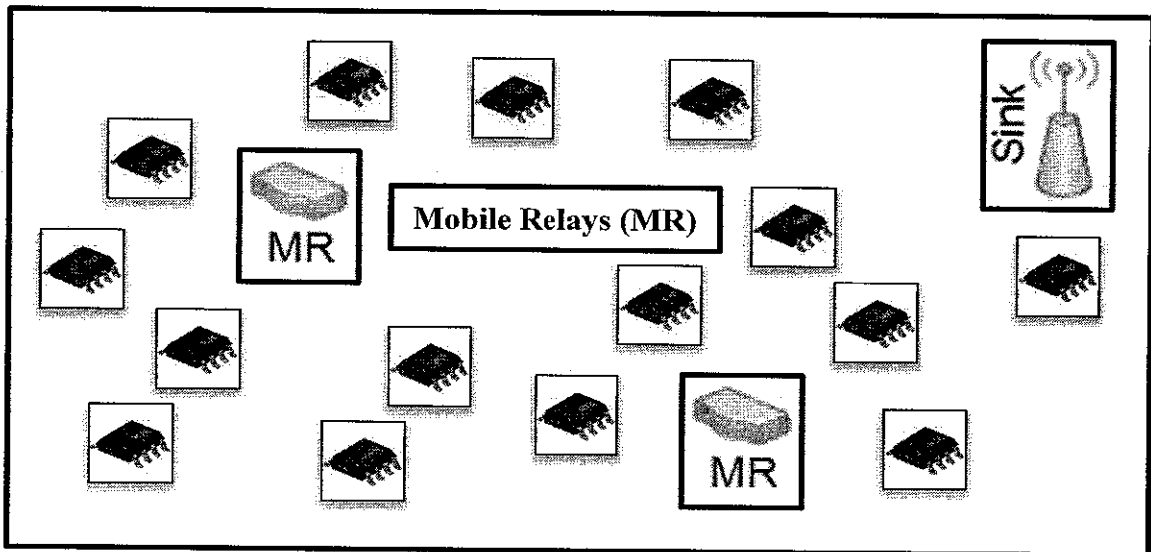

(b)

Figure 2.9 Architectures of WSN-MEs with MDCs: (a) mobile sinks and (b) mobile relays.

2.3.2.2 Relocatable nodes

These mobile nodes change their location to better characterize the sensing area, or to forward data from the source nodes towards the sink. In contrast with mobile data collectors, relocatable nodes do not carry data as they move in the network. In fact, they only change the topology of the network that is assumed rather dense for connectivity or coverage purposes. More specifically, after moving to the new

location they usually remain stationary and forward data along multi-hop paths. A WSN-ME architecture based on relocatable nodes is illustrated in Figure 2.10. Although in theory ordinary nodes might be relocatable, in most cases special MEs (e.g., support nodes) are used.

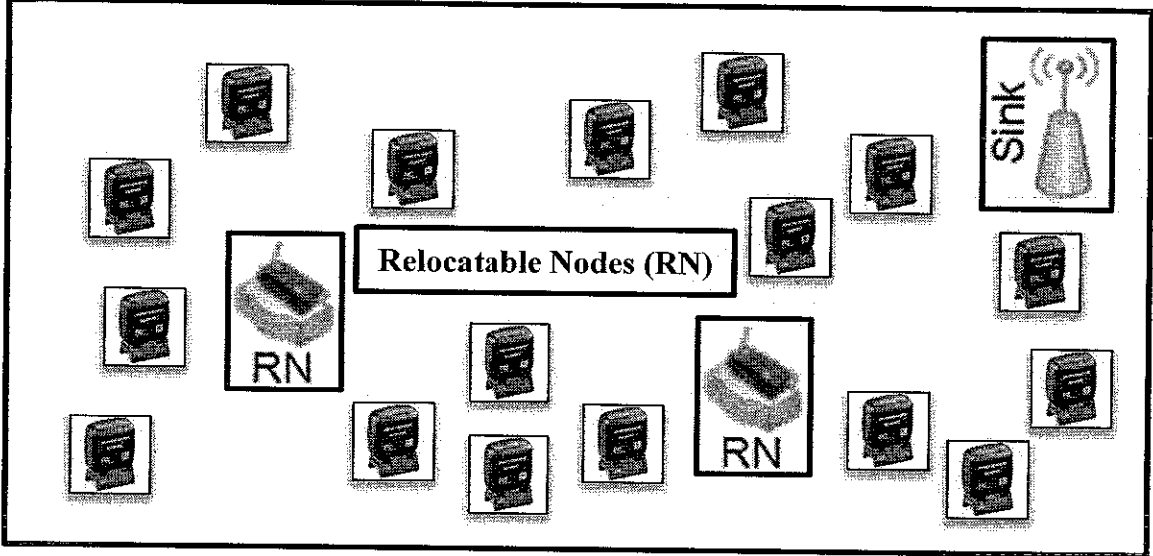

Figure 2.10 WSN-ME architecture with relocatable nodes

Relocatable nodes can also be used to address the problem of sensing coverage. In this case, the primary concern is not ensuring network connectivity but avoiding coverage holes areas where the density of nodes is not adequate to properly characterize a phenomenon or detect an event. Relocatable nodes provide a mobility-assisted approach to WSNs, in the sense that MEs are not actively exploited for data collection [62 - 67].

2.3.2.3 Mobile peers

Unlike MDCs, which are either sinks or special relay nodes, mobile peers are ordinary mobile sensor nodes in WSN-MEs. Since they can be both originator and relays of messages in the network, their interactions are symmetrical because the sink itself might also be mobile. When a peer is in the communication range of the base station, it transfers its own data as well as those gathered from other peers while moving in the sensing area. A WSN-ME architecture based on mobile peers is illustrated in Figure 2.11. In this case, the network is homogeneous and rather sparse.

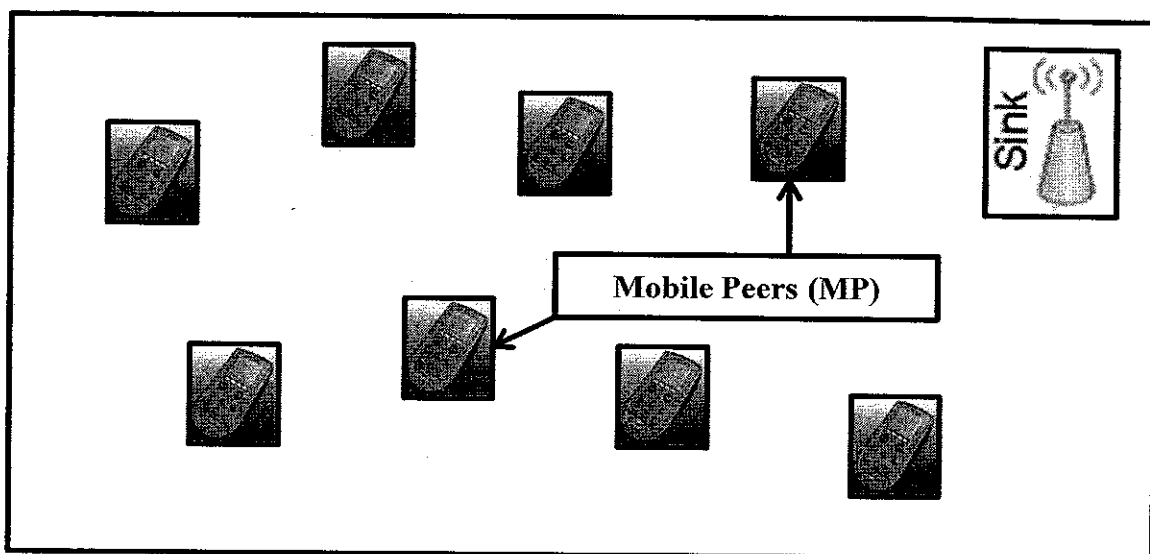

Figure 2.11 WSN-ME architecture with mobile peers.

Mobile peers successfully employed in the context of wildlife monitoring applications. Moreover, that not only do they generate their own data but they also carry and forward all data coming from other nodes, which they have been previously in contact with. When mobile peers get close to a base station, they transfer all the gathered data. Data already been transferred to a base station is flushed by peers in order to save storage [68 - 76].

2.3.3 Data Collection Mechanism

Three main phases associated with the data collection in WSN-MEs emerge, discovery, data transfer, and routing to MEs. Each phase has its own issues and requirements are briefly investigate in the following.

- *Discovery* is the first step for collecting data in WSN-MEs, since the presence of the ME in the contact area is generally unknown at sensors. The goal of discovery is to detect contacts as soon as they happen and with low energy expenditure. In other words, discovery should try to maximize the number of detected contacts and the residual contact time, while minimizing the energy consumption.
- *Data transfer* immediately follows discovery. The goal of data transfer protocols is to get the most out of the residual contact time, that is maximize

the throughput in terms of messages successfully transferred per contact while minimizing the energy consumption.

- *Routing* to MEs is actually possible only when the density of the network is enough to allow (even partial) multi-hop routes. This is true for dense WSN-MEs, where routing to ME is always possible. Actually, this can happen even with more sparse WSN-MEs where nodes can organize as disconnected clusters. In this case, routing is possible only when an ME is in contact with at least one node in the cluster. However, some nodes can be elected as bridges and act as gateways between the cluster nodes and the ME. In both cases, the goal of routing is to find the best multi-hop paths in terms of both delivery ratio and low energy consumption towards either the ME or a node, which can be in contact with the ME.

2.3.4 Mobility impact in WSNs

In previous sections discussed specific characteristics of mobility, even though addressed the presence of MEs in the data collection scenario. However, different kinds of mobility can significantly affect the phases of data collection. The aspect of mobility is the most significant impact on the data collection process is controllability, depending on whether the motion of the ME is autonomous or not.

There are two main patterns for uncontrolled mobility: deterministic and random. The deterministic mobility pattern is characterized by the regularity in the contacts of the ME, which enters the communication range of sensor nodes at specific (and usually periodic) times. This can happen when the ME is placed on a shuttle for public transportation [77]. On the other hand, the random mobility pattern is characterized by contacts, which takes place not regularly but with a distribution probability. In general, a node should perform discovery continuously, so that it can increase the chance of detecting contacts. However, when some knowledge on the mobility pattern of nodes can be exploited, the node can restrict discovery to the instants where the probability of an ME being in proximity is high [78, 80].

Different from the former case, *controlled mobility* exploits nodes can actively change their location, because they can control their trajectory and speed. Therefore,

motion becomes an additional factor that can be effectively exploited for designing data collection protocols specific to WSN-MEs. It should be noted that controlled mobility could make some issues related to data collection less relevant. For instance, the discovery problem can be somewhat simplified, since MEs can be instructed to visit (individual) nodes at specific times. In addition, the duration of contacts is also less problematic, since the MEs can stop at nodes until they have collected all buffered data. Anyway, different problems arise in this context, mainly related to how to schedule ME arrivals at sensors which includes defining both the trajectory and the speed of the ME while satisfying certain quality of service constraints (such as minimizing latency and buffer overflows) and keeping the energy consumption as low as possible [81, 82, 83].

Figure 2.12 summarizes the different aspects of data collection in WSN-MEs and illustrates taxonomy of the approaches used in the different phases.

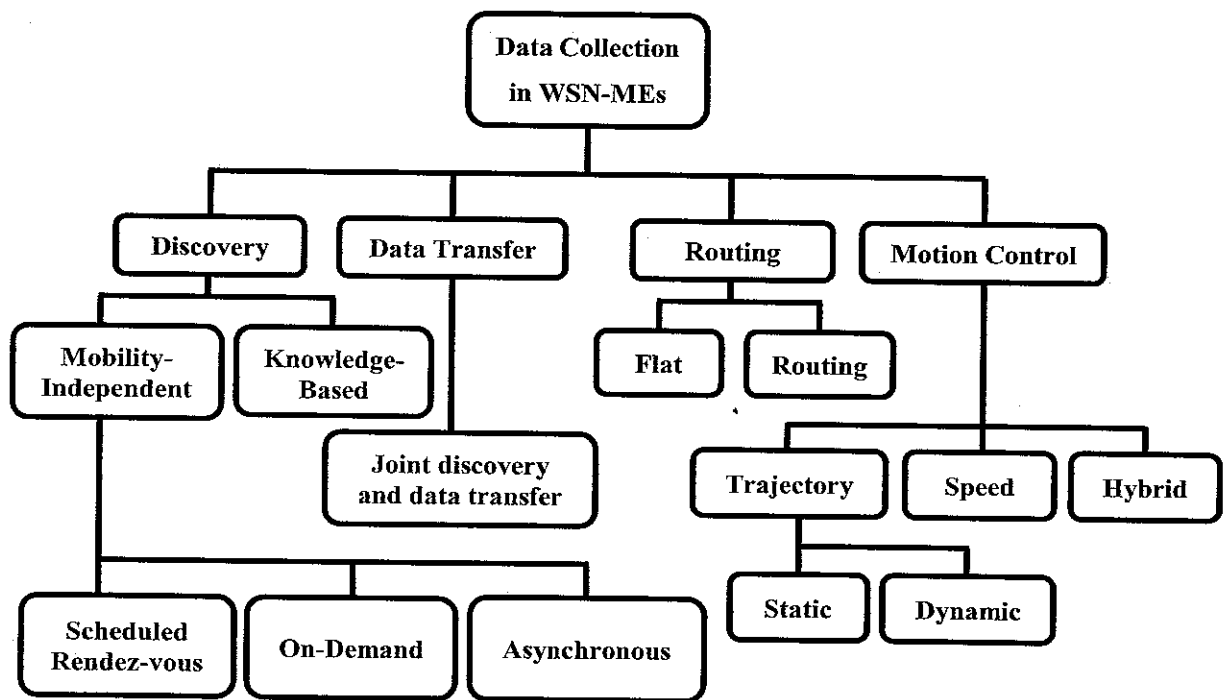

Figure 2.12 Taxonomy of the approaches for data collection in WSN-MEs

2.4 Study of Routing Protocols

Energy awareness in WSNs is of critical importance to the lifetime of the network. Depending on applications, sensor nodes can be deployed on the ground, in the air,

under water, on bodies, in vehicles and inside buildings. Many attempts have been made to create “intelligent” routing protocols that base routing decisions on energy levels within the nodes and in the network as a whole. All the routing protocols described in this chapter attempts to focus on energy awareness with trade-offs to certain design decisions. The WSNs routing protocols can be categorized as data centric or flat, hierarchical and mobility aware routing techniques. Each of these protocol paradigms is described in this chapter [84].

2.5 Design Consideration for WSNs Routing Protocol

The factors influencing the design [85 - 91] of WSNs routing protocols are important because they should provide protocol development guidelines. These factors can be used for the purpose of analysis and comparison among routing protocols. The aforementioned factors can be summarized as:

- *Scalability*: Network size may exceed 1000’s or even 10000’s and a routing protocol should be able to handle this amount of nodes.
- *Node density*: Nodes may be highly concentrated in specific sensing areas to maximize the sensing coverage area. Routing protocols should be able to select energy optimal routing paths within the dense node deployment area.
- *Deployment*: Sensor node deployment may be extremely dense, requiring a precise and energy efficient mechanism for handling of network topology maintenance. Node deployment may be a random distribution or at predetermined positions. Topology can typically be divided into three phases:
 - a. Deployment of nodes can be randomly distributed or placed at predetermined positions.
 - b. Post-deployment phase, where topology changes may occur due to failures, mobility, interference of node.
 - c. Redeployment of nodes to augment areas, where topology changes are causing detrimental network performance.
- *Network topology*: A multi-hop network of sensor nodes may form arbitrary paths from any source node to a base station. An important property on the WSNs is maximum amount of hops to reach the base station as determined by

the routing protocol. This affects network characteristics such as latency and path failure tolerance. Hence, it is required that network to be capable of independently reconfiguring once the topology changes.

- *Fault tolerance (Reliability)*: Node failures are inevitable in WSNs due to power depletion, damage or interference. A routing protocol's tolerance to fault conditions is measured against the effect of failing nodes on the remainder of the network's functionality. A Poisson distribution of the probability models for sensor node reliability is measured in [86].
- *Mobility*: The movement of sensor nodes may be required by the application or may be an incidental effect and may apply to any percentage of the nodes in the network. Movement may be at a constant speed or at intervals with periods of remaining static. The movement pattern of nodes may be random or determined by a preselected model, for example soldiers patrolling the perimeter of a base. Random movement will affect network topology changes worse than a predefined movement model, due to the unpredictability of the movement. Each of the mentioned mobility parameters will influence the network topology differently and the model assumed will affect the design and function of routing protocols.
- *Transmission media*: Sensor nodes are linked with a wireless medium that eliminates the criteria for line-of-sight between nodes. Most of the sensor nodes available in the industry utilize radio frequency (RF) for transmission among nodes.
- *Connectivity*: Two nodes are connected, if the nodes' positions are such that they are within a maximum transmission distance R from each other. Each source node is permanently connected to a base station with an arbitrary amount of hops; the network is termed as connected. Connectivity is sporadic if network connectivity is broken due to node mobility, node failures or interference.
- *Hardware Constraints*: The typical sensor node architecture comprises of a power module, sensing module, transceiver module, processing module and possibly additional application specific modules, as illustrated in Figure 2.13. The most important component is the power module that determines the total time-to-live (TTL). The additional modules can fulfil tasks such as positioning

but should be limited to the minimum because all the components need to fit into a very small containment unit and should consume the minimum amount of energy.

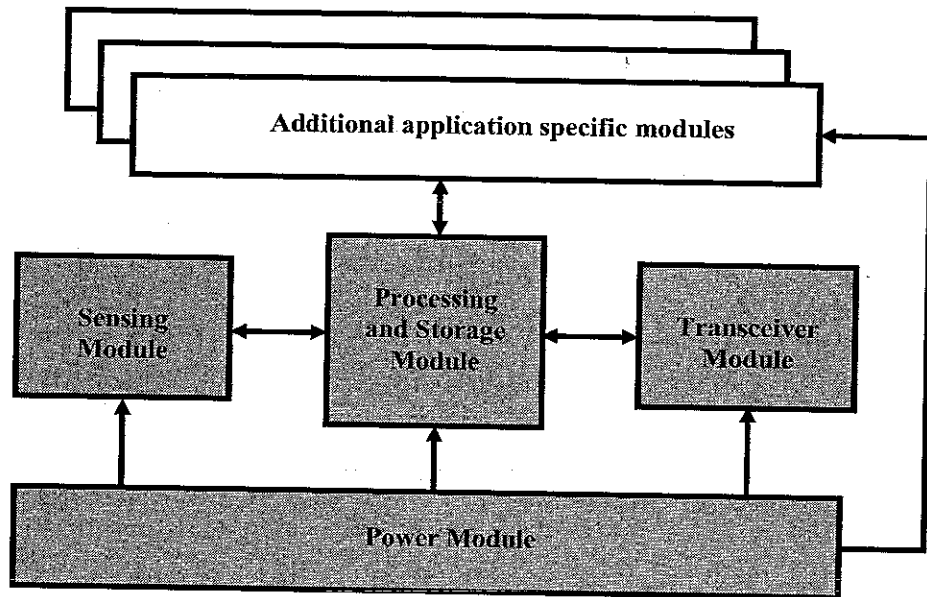

Figure 2.13 Typical sensor nodes architecture

- *Environment:* Sensor nodes can be literally placed very close or even directly within the sensed phenomena.
- *Power Consumption:* The limited power supply of a sensor node directly affects the functional lifetime of that node and indirectly the functional lifetime of the network. Each node in the WSNs may assume the role of data originator, data aggregator and/or data forwarder. The failure of a node may severely affect the network topology and negative performance. Additional energy will be consumed in an attempt to rectify routing information. The main operations consuming power on a sensor node can be attributed to:
 - a. Message transmission that is the highest consumer of node energy.
 - b. Sensing activities are typically the second highest consumer of energy.
 - c. Processing that involves calculations, routing protocol operations, application layer procedures, etc., and consumes the least amount of energy.

- *Lifetime*: The intended application determines the required functional lifetime of a WSNs. The functional lifetime has a direct impact on the energy efficiency of the routing protocol and node robustness.
- *Self-configuration*: Given the possible number of nodes organized in WSNs, the network must be capable to self-configure without any manual intervention. Self-configuration of the network should consume the least amount of energy, enabling a high degree of connectivity. The network should be able to automatically reconfigure to maintain the level of connectivity when network topology changes occur. Reconfiguration may be initiated by:
 - a. Periodic intervals.
 - b. Mechanisms to continuously update routing information, this type of network reconfiguration may potentially consume huge amounts of energy and its usage should be weighed against QoS properties.

2.6 Data Centric Routing Protocol

Data centric or flat routing protocols view all nodes as equal. In other words, all nodes will sense data as well as perform routing of messages and data [90, 91]. Literature accepts the following established flat routing protocols [87]: flooding, gossiping, SPIN (Sensor Protocols for Information via Negotiation), rumors routing, directed diffusion, MCFA (Minimum Cost Forwarding Algorithm), GBR (gradient based routing), and certain energy aware routing protocols as set out in [92 – 103]. The seminal contributions for data centric or flat network architectures are summarized in the following sub-sections.

2.6.1 Flooding and Gossiping

Flooding, actually can not be classified as a routing algorithm in the true meaning of the term. Flooding is rather a mechanism that functions on the same layer as routing protocols that ensures data messages will reach a base station. Flooding is a

source initiated protocol and each received message is stored in the node's memory. There is a small amount of decision logically involved, as every node will broadcast the received messages only if the message has not yet been forwarded. The broadcasting of a specific message will continue until the message reaches the sink or the message has reached its maximum time to live (TTL). Maximum TTL is typically specified either by the allowable amount of hops or as a time limit. The operation of flooding can be summarized in Figure 2.14 adopted from [104].

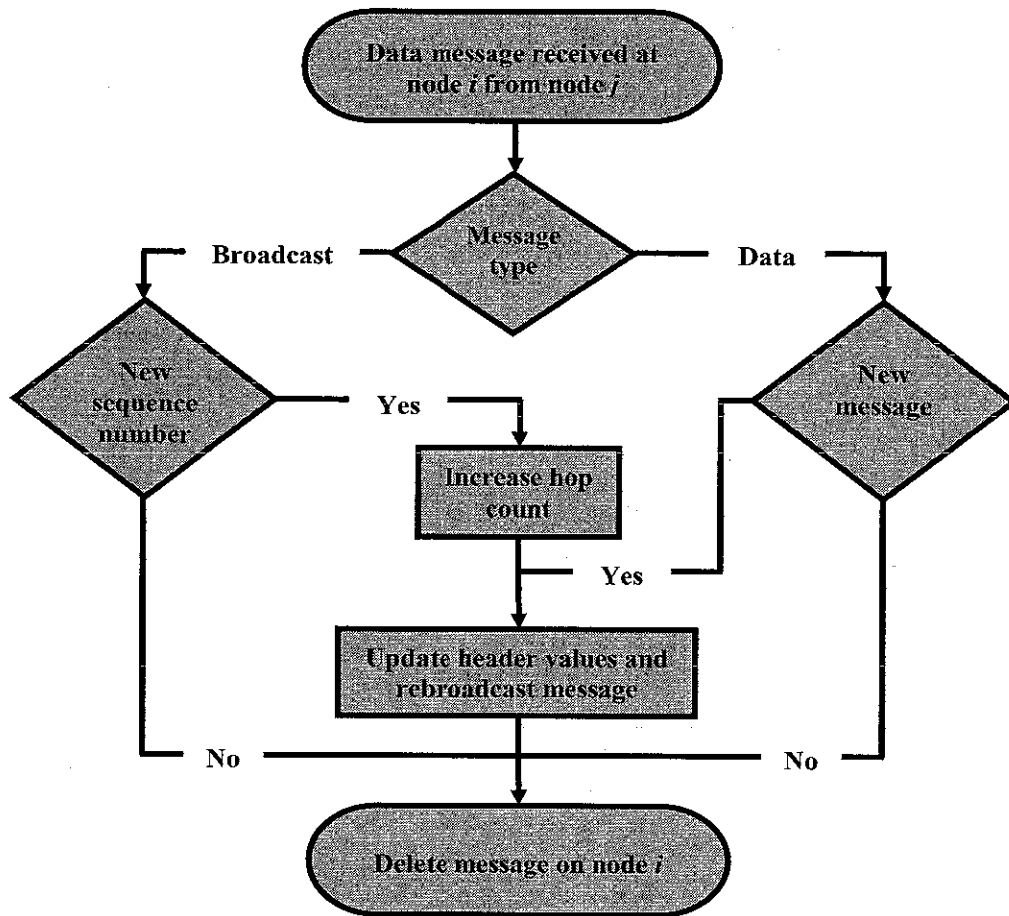

Figure 2.14 Message receiving process flow for Flooding

The major advantages of flooding are:

- Computational simplicity in terms of routing and topology maintenance.
- High degree of fault tolerance and topology changes.

Some disadvantages of flooding are:

- *Implosion*: Data messages are always forwarded from a specific node if that node has not yet sent that. The same messages could potentially be sent to the same node but from different sources.
- *Overlap*: Two source nodes may share the same sensing area, the same data is broadcasted and received by the two nodes with no data aggregation or dissemination, overlap is a much harder problem to solve.
- *High-energy consumption*: Nodes are not energy aware and do not modify routing logic based on available energy levels.

Gossiping is a derived version of flooding and attempts to avoid implosion by randomly selecting the next node from its neighbors rather than broadcasting a message. The receiving node will randomly select a new neighbor and forward the message. The cost of avoiding implosion is the long propagation times it may take for a message to reach a sink.

Directed flooding [104] is adapted from flooding but claims to consume much less energy and exhibit an even higher tolerance to network faults than flooding. This proposal however requires geographic positional and directional knowledge of the network such as global positioning system (GPS) abilities.

Flooding and gossiping should theoretically be able to adapt easily to network topology changes due to the fact that no routing information is discovered and stored.

2.6.2 Simple Energy Efficient Routing (SEER)

Simple Energy Efficient Routing (SEER) [105] proposes an event driven source initiated routing protocol to minimize energy consumption of each node to extend the functional network lifetime during normal routing activities. SEER attempts to provide a scalable solution on a deployment of homogeneous sensor nodes due to the computational simplicity in the routing logic. No node is aware of the global network structure and only requires local network knowledge of its neighbor nodes. Every node will store information of the neighbor nodes such as node address, available energy of the node and hop count to reach the base station. Figure 2.15 gives

a brief explanation of the neighbour selection process as implemented in SEER by adopting [105].

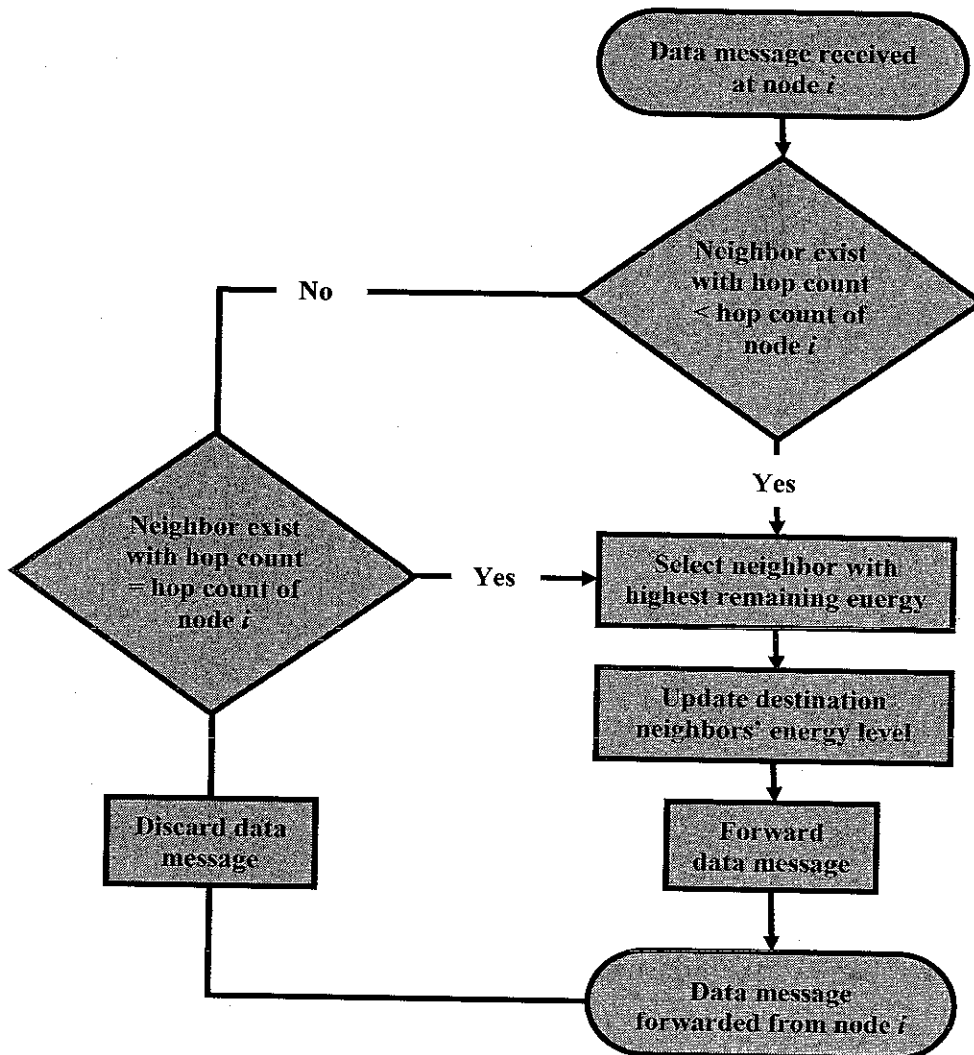

Figure 2.15 SEER neighbor selection process

Some of the identified disadvantages of SEER are:

- SEER proposes a single path to the base station for non-critical messages. This disadvantage implies when a single node in that path fail, all messages traversing that node will be lost. The changed topology will only be rectified after a broadcast has been re-initiated from the base station. The same applies to mobile nodes created as part of the path to the sink and then moving beyond the transmission distance of the specified path.

- The dual path implementation of critical messages could theoretically be very energy consuming so that the amount of critical messages significantly increase. This is rather a trade-off between reliability and energy preservation.

2.6.3 A generalized energy-aware data centric routing for Wireless Sensor Networks

The proposed protocol [106] is modified version of Energy Aware Data (EAD) centric routing protocol that intends to increase the lifetime of the network by increasing the number of candidate gateway nodes. The building tree protocol is generalized, such that not only the nodes that are close to the sink can be connected directly to sink but any node in the network can also be connected directly to the sink. The selected node will act as a gateway as long as its energy is greater than a threshold value E_{th} . New gateways will be selected in each round and therefore a new tree will be constructed. The selected gateways will initiate the building tree protocol as illustrated in Figure 2.16 adopted from [106].

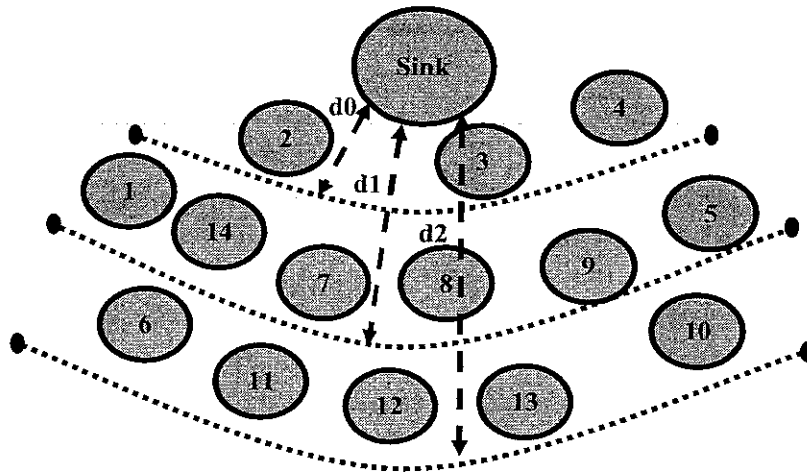

Figure 2.16 A Sample Network with its Tiers

$EAD_{General}$ is examined against the EAD using simulation; it shows significant improvements in terms of larger network lifetime, less consumption energy and higher throughput.

2.6.4 Data-centric cooperative storage in Wireless Sensor Networks

In [107] introduced a data-centric cooperative storage mechanism for wireless sensor networks. The approach is based on Virtual Cord Protocol (VCP), a virtual relative position based efficient routing protocol that also provide means for data management, e.g. insert, get, delete and replicate, as known from typical Distributed Hash Table (DHT) services. Data items are distributed deterministically over several nodes in the same vicinity. Thus, storing and retrieving data items typically require communication with local nodes. To maintain information about stored information, we use a bloom filter to track the nodes that are storing particular items.

Virtual Cord Protocol (VCP) is a DHT-like protocol in which all data items are associated with numbers in a pre-determined range $[S,E]$, i.e. a one-dimensional cord. All the available nodes capture this range. Thus, each node in the network is responsible for a portion of the entire space defined by its relative position to physical neighbors. This way, it is possible to store data on the nodes by mapping data items deterministically in space using a hash function.

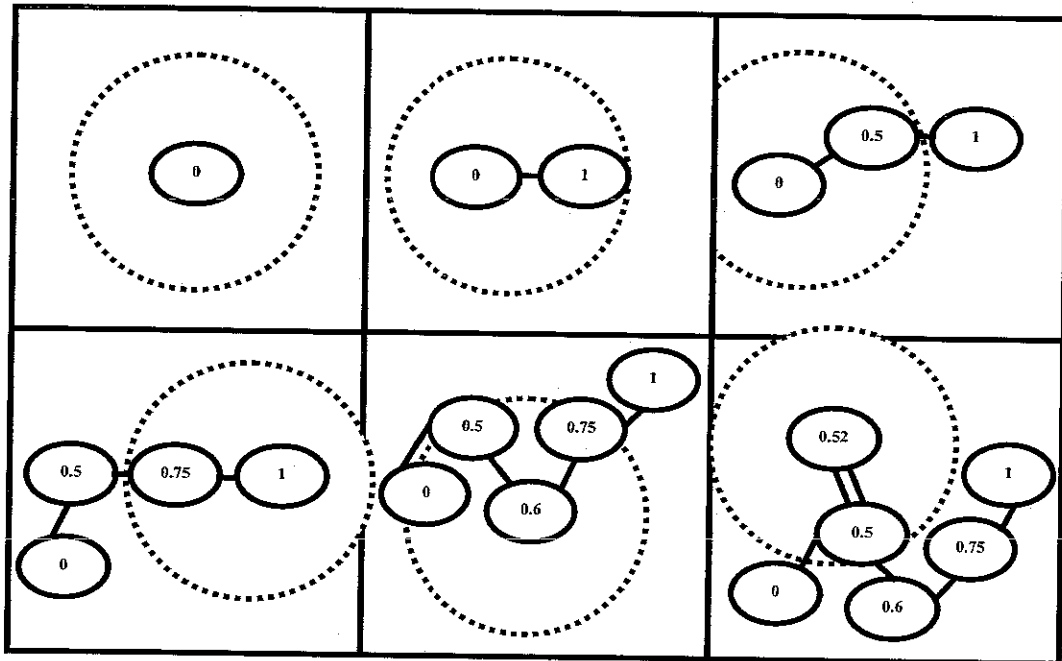

Figure 2.17 Join operations in VCP

The corresponding key-value pair is then stored at the node whose position is closest to the key. Routing of packets is performed based only on the position of the physical neighbors. To retrieve data items, nodes have to apply the same hash

function to find the key value. They then can route the request to the node whose position is closest to the key as illustrated in Figure 2.17 adopted from [107]. To this end, the authors have investigated the performance of VCP assuming each node can store all data items. The presented protocol is fully self-organizing data-centric cooperative storage system that maximizes the usage of network storage in presence of limited storage capacity nodes using the virtual position of nodes generated by VCP. Finally, the evaluation study validates that proposed scheme could effectively utilize the network storage capacity of individual sensor nodes to accommodate the sensory data.

2.6.5 A modified SPIN for Wireless Sensor Networks

Routing protocols based on data-centric approach are suitable in the context that performs in-network aggregation of data to yield energy saving data dissemination. In [108] propose a modified SPIN protocol named M-SPIN and compare its performance with traditional SPIN protocol using broadcast communication, which is a well-known protocol as benchmark.

Modified-SPIN (M-SPIN) protocol transmits information only to sink node instead of transmitting throughout the network. Total number of packets transmission is less in proposed protocol, therefore a significant amount of total energy can be saved. M-SPIN protocol is illustrated in Figure 2.18 adopted from [108].

The proposed a modified SPIN (M-SPIN) protocol using hop-count values of sensor nodes for WSNs. Normally SPIN protocol also negotiation is done before sending the actual data, but in M-SPIN the nodes which are nearer to sink node send REQ packets in response to ADV packet from the source node. Therefore data is disseminated to the sink or neighbor nodes towards the sink node. M-SPIN achieve energy savings by discarding packet transmission to the opposite direction of sink node.

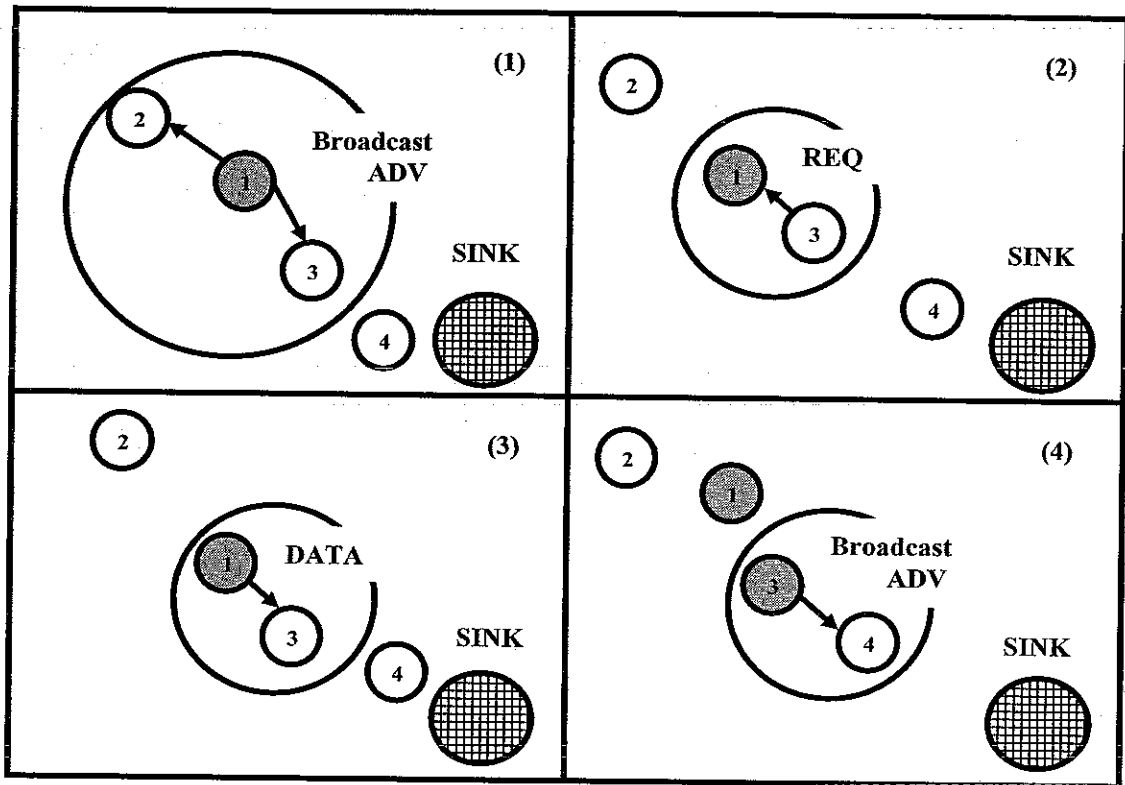

Figure 2.18 The M-SPIN Protocol

Table 2.1 illustrates the short view of some existing data centric routing protocols.

Table 2.1 Comparison chart of data centric routing protocol

	Classification	Data Aggregation	Multipath	Power Usage	Mobility	Negotiation Based	Query Based	Position Awareness	Scalability
Directed Diffusion	Flat	Yes	Yes	No	Yes	Yes	Yes	No	No
SPIN	Flat	Yes	Yes	No	Yes	Yes	Yes	No	No
MCFA	Flat	No	No	No	No	No	No	No	Yes
GBR	Flat	Yes	No	No	No	No	Yes	No	No
Rumor Routing	Flat	Yes	No	No	No	No	Yes	No	Yes
ACQUIRE	Flat	Yes	No	No	No	No	Yes	No	No
COUGAR	Flat	Yes	No	No	No	No	Yes	No	No
EAR	Flat	No	No	No	No	No	Yes	No	No
CADR	Flat	Yes	No	No	No	Yes	No	No	No

2.6.6 Advantages of data centric routing protocols

Topological changes are limited to neighboring nodes. This local network knowledge at each node and the fact that each node functions equally promotes protocol

scalability and computational simplicity. There is no requirement for complex calculations to determine or manage a hierarchical network topology.

Flat network topologies treat each node equally to simplify deployment strategies to the use of homogeneous nodes. There is no requirement of including and deploying specific nodes with higher specified functionality and resource capabilities.

2.6.7 Disadvantages of data centric routing protocols

The base station may overload and cause latency in message delivery in networks with a high density of source nodes surrounding a base station. The high volumes of data messages traversing the sink neighbor nodes may cause hot spots and power sources to fail prematurely.

Low-density networks may cause separation and even isolation of parts of the network if a single critical node fails in a deployment of homogeneous nodes. In this case, a suggestion would be to add additional base stations.

2.7 Hierarchical Cluster Based Routing Protocols

Hierarchical routing protocols on the other hand treat nodes differently in terms of functionality and purpose in the WSNs. Sensed data messages are aggregated at certain nodes and forwarded to next aggregation node in the path towards the base station. The aggregator nodes are predetermined nodes or dynamically assigned by the routing protocol, the purpose of the aggregator nodes may be for routing purposes only or both routing and data sensing. The majority of the nodes is still seen as sensing nodes and will propagate the sensed data originating in each node towards the aggregation node.

Literature accepts the following established hierarchical routing protocols: PEGASIS (Power-Efficient Gathering in Sensor Information System), EDC (Event-driven Cluster Routing), HEAR-SN (Hierarchical Energy-Aware Routing for Sensor Networks), BATR (Balanced Aggregation Tree Routing), Fault-tolerant wireless sensor network routing protocols for the supervision of context-aware

physical environments, A Novel cluster-based routing protocol with extending lifetime for wireless sensor networks, An improved LEACH-based power aware routing protocol in wireless sensor networks, A Taxonomy of cluster-based routing protocols for wireless sensor networks, A cluster-based routing protocol for wireless sensor networks with adjustable cluster size, Research on clustering routing algorithms in wireless sensor networks, Energy efficient cluster-based routing in wireless sensor networks, Design and implementation of cluster-based routing protocol using message success rate in sensor networks, and A Taxonomy of Cluster-Based Routing Protocols for Wireless Sensor Networks [109 - 121]. The seminal contributions for hierarchical network architectures are summarized in the following sub-sections.

2.7.1 Low Energy Adaptive Clustering Hierarchy (LEACH)

Low Energy Adaptive Clustering Hierarchy (LEACH) [122] was ground breaking research work in terms of hierarchical network topologies. As with flat network topologies, LEACH is based on the deployment of homogeneous nodes and assumes that the base station is stationary. The self-configuration of clusters groups a selection of nodes that are geographically close to a cluster head into a logically separate network. This mechanism assumes that source nodes will always be a single hop away from the cluster head. Data message aggregation is performed within each cluster at the cluster head. The operation of LEACH assumes that cluster heads will always be one transmission away from the sink node and will forward the aggregated messages directly towards the base station. This is a high-power transmission and will drain node power factors more than normal source to cluster head transmissions. LEACH protocol as illustrated in Figure 2.19 proposes a mechanism to randomly select and rotate cluster heads to distribute aggregation and sink transmission load across the network.

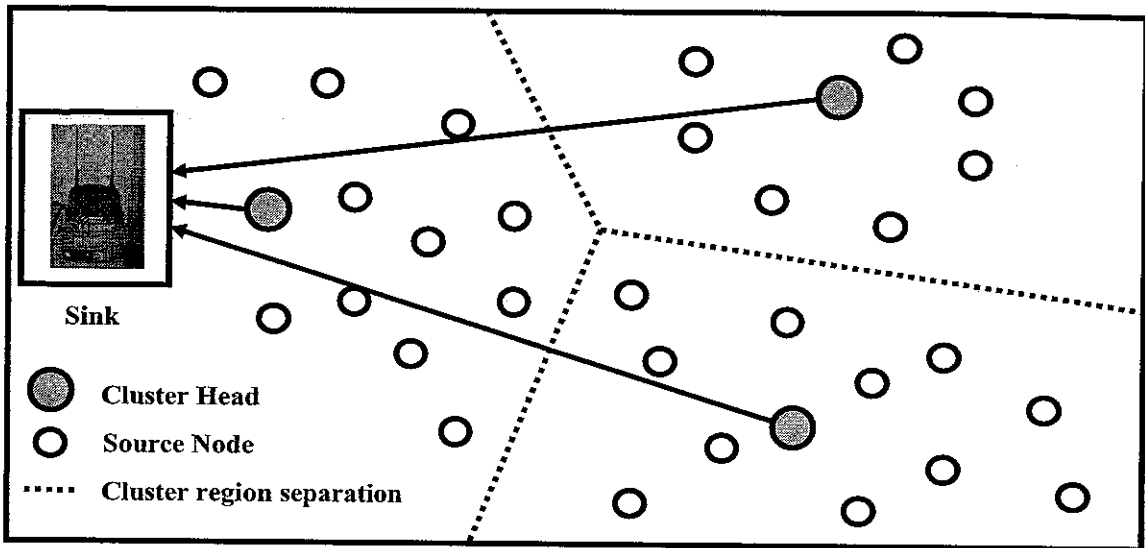

Figure 2.19 LEACH cluster configuration and transmission

The implementation of LEACH has its disadvantages:

- The assumption that any node in the network can assume the role of a cluster head implies that all nodes should have the capacity to transmit messages directly to the sink. Extensions of LEACH to utilize multi-hop clusters propose to solve this disadvantage.
- LEACH requires support for multiple MAC protocols to fulfil the functionality of the protocol.
- Maximum Energy Cluster-Head (MECH) [123] is based on LEACH and identifies deficiencies in the cluster formation mechanism of LEACH. MECH proposes alternative solutions to overcome the following drawbacks of LEACH:
 - a. The geographic distribution of nodes is not considered and cluster heads may be in one small location. This means that some source nodes may have to transmit across vast distances to reach that node's cluster head or may not even be within transmission distance of any cluster head.
 - b. Source nodes are not distributed evenly among cluster heads. The cluster heads of clusters containing more source nodes will drain the supply of that head much faster [124].

2.7.2 Threshold sensitive Energy Efficient sensor Network protocol (TEEN)

Threshold sensitive Energy Efficient sensor Network protocol (TEEN) [125] proposes a reactive routing protocol specifically applicable to time sensitive applications. TEEN adopts the principle of hierarchical clustering. Sensor nodes are grouped together that is geographically close to each other with one common cluster head. For the purposes of this section, these cluster heads are seen as first layer cluster heads. The first layer of cluster heads collect data messages from the sensor nodes within its cluster, aggregate the data messages and forward the aggregated messages to a higher layer.

The higher layer could be a base station or a next layer of cluster heads that cluster the first layer of cluster heads together. This process is repeated to form a hierarchical cluster topology with the highest layer cluster heads transmitting data messages directly to the base station. Figure 2.20 (adopted from [125]) illustrates a subset of a typical hierarchical network topology. The sensor nodes continuously sense the environment and will only forward data messages to the cluster node once the hard threshold has been exceeded. After this stage, the sensor node will only forward data if the change in the sensed attribute exceeds the soft threshold and still exceeds the hard threshold.

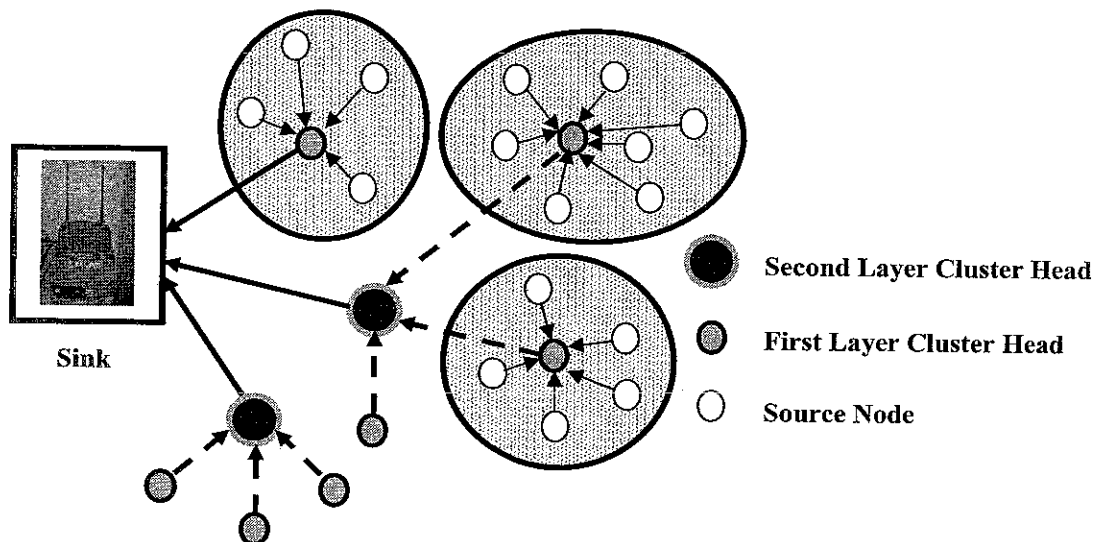

Figure 2.20 Typical hierarchical clustering network topology

The main disadvantage of TEEN is that if the hard threshold is never reached, no data messages will be forwarded towards the base station. TEEN is not suitable for applications requiring periodic data updates. This is however not a disadvantage but

merely a projection of specific application implementations. Adaptive Threshold sensitive Energy Efficient sensor Network (APTEEN) [126] proposes an extension to TEEN to mitigate the hard threshold problem described above. APTEEN proposes a mechanism to periodically transmit data messages in addition to the responsive threshold triggered data messages. In addition to the information broadcasted to the cluster members in TEEN, APTEEN will include a count time to reflect the maximum time between two successive initiations of data messages. If a source node is not triggered by the hard and soft threshold values within the specific period, the node will sense the specified attribute and forward the data message to the cluster head.

The disadvantage of both TEEN and APTEEN is the overhead, complexity of cluster formation, maintaining the attribute based queries and threshold based functions. The energy consumption of both TEEN and APTEEN is well planned to minimize the energy hungry actions such as message transmission. Simulation results in literature show the energy conservation of both TEEN and APTEEN are outperform than LEACH. The main benefit of both TEEN and APTEEN is that the user of the system can modify the sensed data requirements with every cluster topology change.

2.7.3 A novel application specific network protocol for Wireless Sensor Networks

In many routing protocols for traditional MANETs such as DSDV and DSR used widely multi-hop routing strategy, these protocols employed one or more intermediate nodes from source to destination to relay the data packets. The author of [127] proposed a novel self-organizing energy efficient Hybrid protocol based on LEACH that combines multiple-hop routing strategy and cluster based architecture. Cluster heads act as backbone after the formation of clusters, every member node of cluster directly send the data to respective cluster head and then cluster head adopting multi-hop routing strategy to transmit the data towards the base station as an alternative of straight communication in order to reduce communication energy and distribute energy load evenly throughout the whole network.

Moreover, this protocol creates same suppositions as LEACH protocol almost the network model like Carrier Sense Multiple Access (CSMA) MAC protocol utilizing

to decrease the probability of collision at set-up phase. The node in the network is aware of its location, which is necessary for the multi-hop routing between cluster heads and can be achieved by Global Positioning System (GPS) technology. It employs randomized rotation of local base stations (CHs) to consistently allocate the load of energy between the sensors in the network. All nodes are managed within some clusters by the help of short message communication during the set-up phase and one node is selected as cluster head, according to cluster head selection algorithm same as LEACH protocol. At the start of set-up phase, each node in the network needs to select whether it will become a cluster head or not, this decision is made based on threshold value that is random number between 0 and 1. The node converts into cluster head for the current round if the value of number is less than the threshold.

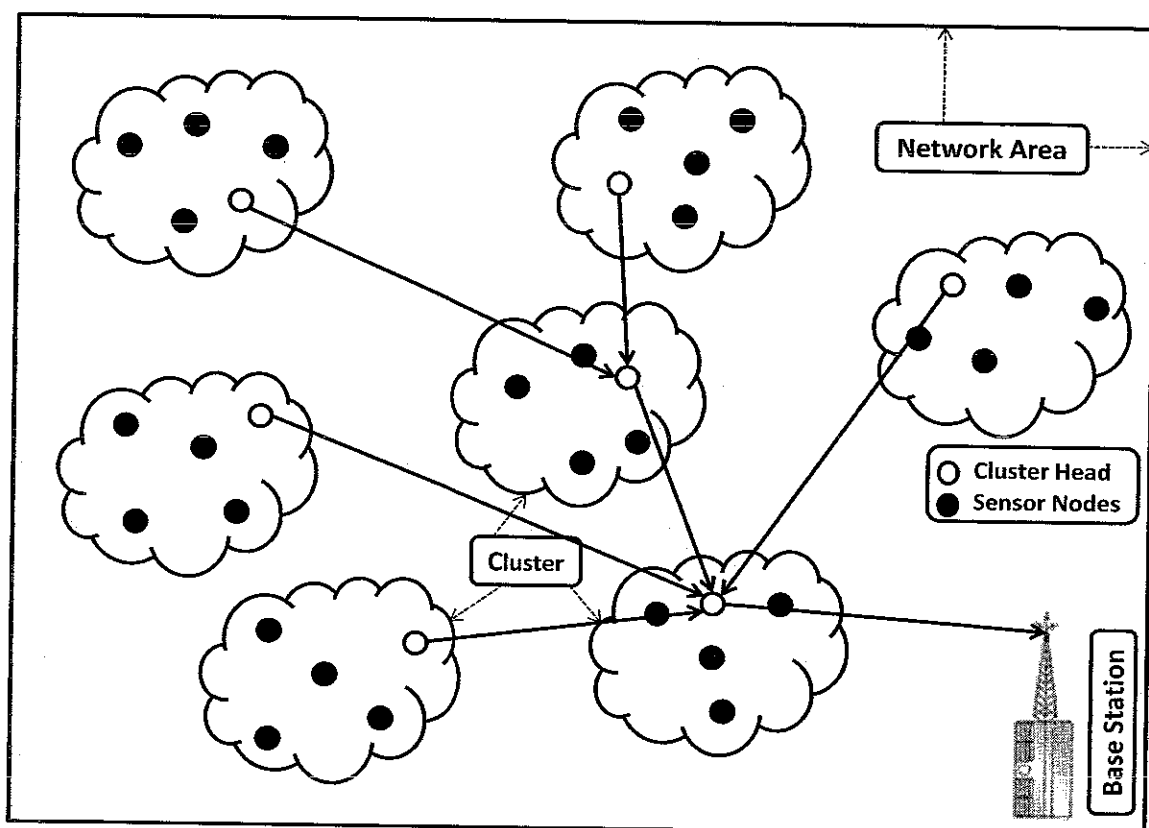

Figure 2.21 Architectural View of Hybrid multi-hop LEACH protocol

Similar as LEACH, the steady-state of Hybrid routing protocol is made up of many frames where each member node occupies its own time slot to send its data to the cluster head. If a cluster head has the fused data to transmit to the BS, it will try to find a multi-hop route among all cluster heads to relay the data packet to the BS according a routing algorithm as illustrated in Figure 2.21. Since energy is quite

precious in inaccessible sensor nodes for environment monitoring, the routing algorithm used here should be as simple as possible to prevent complexity of the protocol from rising too much. Therefore, the minimum transmission energy (MTE) [128, 129] routing is adopted as routing algorithm, which is a straightforward solution in the family of the multi-hop routing algorithms. The significant benefit of this proposed protocol is to reduce the transmission energy depletion that directly increases the overall network lifetime but network latency time and end-to-end delay is increased.

2.7.4 On hierarchical routing in wireless sensor networks

Based on numerous proposed hierarchical routing infrastructures [130] develops a framework that captures the common characteristics of the infrastructures and identifies design points where the infrastructures differ. Then evaluate the implementation of the framework in TOSSIM and on a 60-node test bed and demonstrate that from the practical perspective hierarchical routing is also an appealing routing approach for sensor networks. Despite only logarithmic routing state, it can offer low routing stretch: the average of ~ 1.25 and the 99th percentile of 2. Moreover, a hierarchical routing infrastructure can be autonomously bootstrapped and maintained by the nodes. By exploring the design points within proposed framework, the hierarchy maintenance protocol can optimize different metrics, such as the latency of bootstrapping and repairing the hierarchy after failures or the traffic volume, depending on the application requirements.

In terms of absolute values, however, these results diverge considerably from high-level simulation results, which confirm the need for practical evaluations. The proposed protocol show that the performance of different techniques for maintaining the hierarchical routing infrastructure can vary dramatically approaches based on hierarchical scoped flooding offer the lowest latency of bootstrapping and recovering the hierarchy, while approaches employing local communication minimize the traffic volume. An application can thus select the most suitable hierarchy maintenance technique or, as demonstrate combine some of the techniques to optimize certain metrics as illustrated in Figure 2.22 adopted from [130].

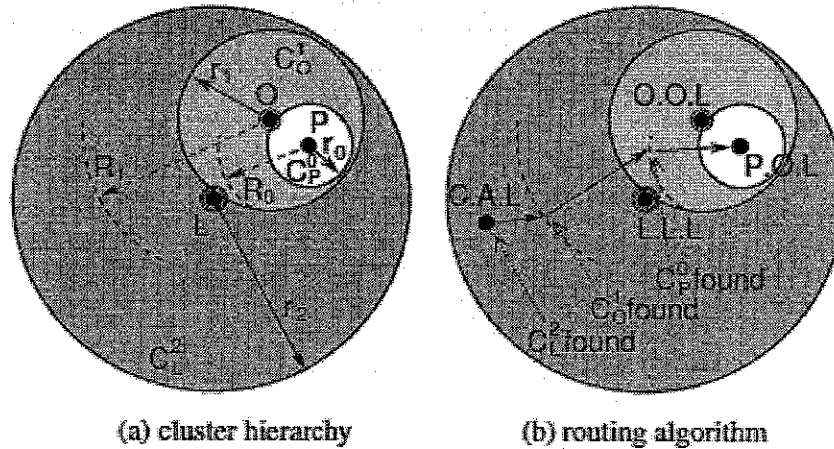

Figure 2.22 Hierarchical Routing [130]

The results obtained with the embedded implementations of proposed framework indicate that hierarchical routing is indeed an appealing point-to-point routing paradigm for large low power wireless networks. Apart from the results, the presented HR framework is itself a major contribution as it allows for experimenting with various design decisions and for comparing HR against other point-to-point routing techniques.

2.7.5 Cluster based routing protocol for mobile nodes in Wireless Sensor Network

The author of [131] proposed adaptive Time Division Multiple Access (TDMA) scheduling and round free cluster head protocol called Cluster Based Routing (CBR) protocol for Mobile Nodes in Wireless Sensor Network (CBR Mobile-WSN). In this protocol the cluster head receive data from not only its member during the TDMA allocated time slot but also other sensor nodes that just enter the cluster when it has free time slots, each cluster head takes turn to be the free cluster head in the network. CBR Mobile-WSN change TDMA scheduling adaptively according to traffic and mobility characteristics. The proposed protocol sends data to cluster heads in an efficient manner based on received signal strength.

A new low packet loss technique with efficient power consumption routing protocol for WSN has been proposed in CBR Mobile-WSN protocol. The cluster head sends data request message to its members, when the cluster head does not receive data from its members, the packet is considered loss and the cluster head consequently discharges the sensor node's membership, at the end of the frame. On the other hand,

when the sensor node does not receive data request message from the cluster head it will try to establish new membership with new cluster to avoid loss packets.

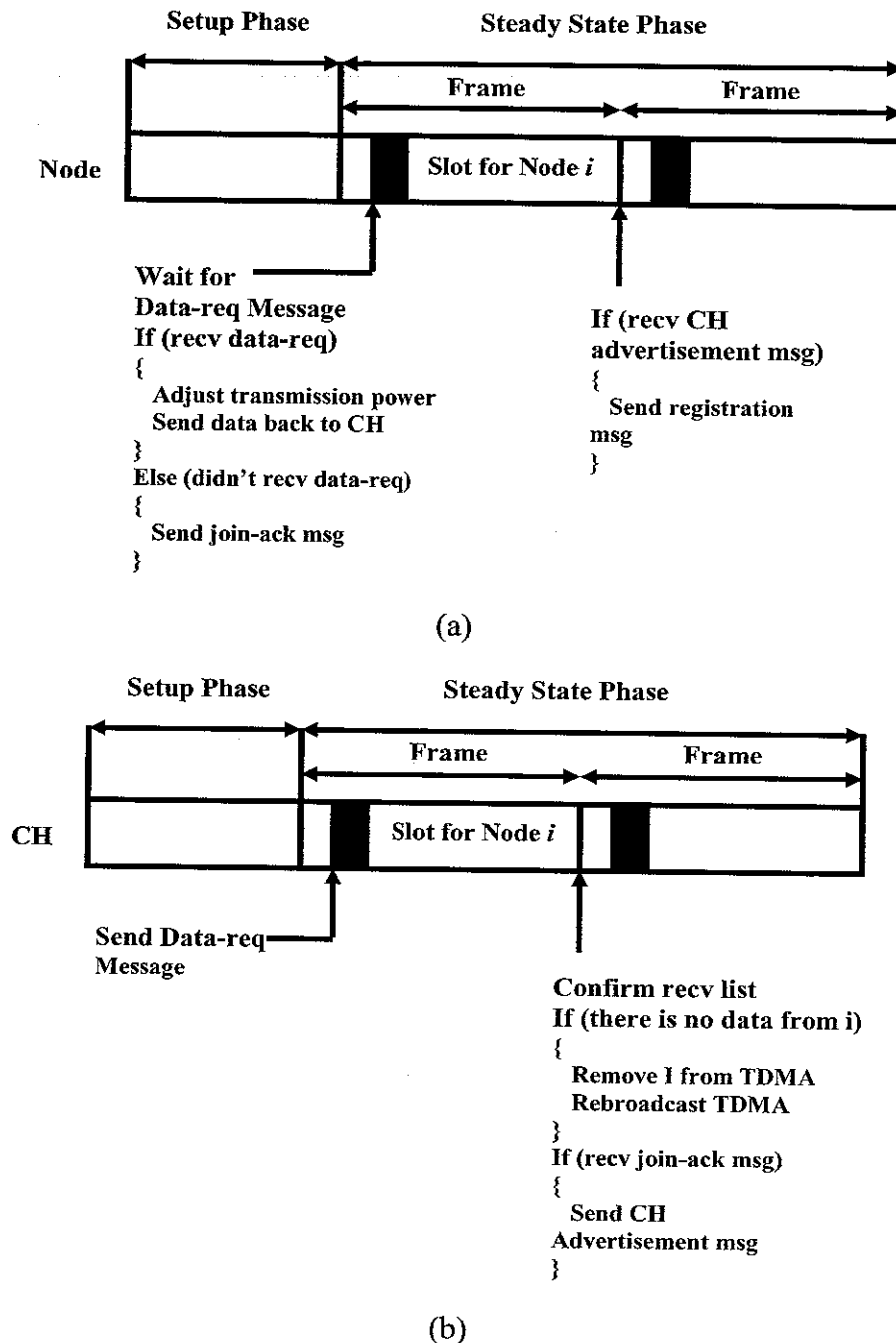

Figure 2.23 CBR Mobile-WSN Time Line: (a) Node's Time Line, and (b) Cluster Head's Time Line [131]

When the sensor node receives data request message from cluster head but it has no data to send, the node will not occupy any time slot. Thus, the timeslot will be assigned to another member who has data to send. This adaptive protocol can avoid wastage of timeslot, hence ensures efficient bandwidth utilization. Each cluster head

keep some free timeslot to enable other incoming nodes from other cluster to join its cluster. In energy efficient transmission, the transmitter will send the message according to the received signal strength of data request message from the cluster head as illustrated in Figure 2.23 adopted from [131]. This protocol reduces the effect of mobility by decreasing packet loss by changing the TDMA scheduling adaptively and using round free cluster head. This protocol is also energy aware, as it reduces the energy consumption by transmitting with low transmission with minimal amount of energy power based on the received signal strength of data request message. The CBR Mobile-WSN protocol shows significant improvement in data transfer success rate and energy consumption in mobility environment compared to LEACH-Mobile protocol.

Table 3.2 summarizes the comparison chart for some existing hierarchical routing protocol.

Table 2.2 Comparison chart of hierarchical routing protocol

	Classifier	Data Aggregation	Multipath	Power Usage	Mobility	Negotiation Based	Query Based	Position Awareness	Scalability
LEACH	Hierarchical	Yes	No	Yes	Fixed BS	No	No	No	Yes
SOP	Hierarchical	No	No	No	No	No	No	No	no
MECN & SMECN	Hierarchical	No	No	Yes	No	No	No	No	no
HPAR	Hierarchical	No	No	No	No	No	No	No	Yes
TEEN & APTTEEN	Hierarchical	Yes	No	Yes	Fixed BS	No	No	No	Yes
PEGASIS	Hierarchical	No	No	Yes	Fixed BS	No	No	No	Yes
FIDD	Hierarchical	No	Yes	No	Yes	No	Yes	Yes	no
Sensor Aggregate	Hierarchical	Yes	No	No	No	No	Yes	No	Yes
VGA	Hierarchical	Yes	Yes	No	No	Yes	No	No	Yes

2.7.6 Advantages of hierarchical routing protocol

In general, hierarchical protocols promote the use of data aggregation and data fusion. This could include some additional functionality to eliminate duplicate messages. Data aggregation reduces network overhead and the amount of messages being transmitted thus reducing energy consumption.

Some hierarchical network topologies simplify deployment strategies to the use of homogeneous nodes. There is no requirement of including and deploying specific nodes with higher specified functionality and resource capabilities.

The power consumed in clustering approaches is much lower to setup clusters rather than the network as a whole. Power consumption is localized to the cluster. Data messages also traverse much less nodes to reach the cluster heads. In general hierarchical routing protocols consume much less energy in the network as a whole.

2.7.7 Disadvantages of hierarchical routing protocol

Some hierarchical network topologies require the inclusion and deployment of specific nodes with much higher specified functionality and resource capabilities. This will influence the cost of the network in terms of deployment as well as manufacturing. Deploying nodes with differing functionality will complicate any attempt to rotate cluster heads.

To overcome this disadvantage some hierarchical protocols propose the use of homogeneous nodes. Routing strategies that require the cluster heads to communicate directly to the base station or over extra-long distances will significantly consume more energy. To overcome these cluster head hot spots, protocol implementations utilize dynamic cluster head selection and rotation.

The additional overhead to randomize cluster heads in homogeneous network, enhance additional computations and complexity. Additional information needs to be gathered by the sensor nodes to setup and initialize the network, thus introducing additional overhead and transmitted messages for initialization. Network initialization could consume much more energy than flat network topologies.

The selection of cluster heads is determined by the protocol operation. Scalability would be influenced negatively with increasing network sizes and the requirement for an increased amount of cluster heads.

2.8 Mobility Aware Routing Protocol

Node mobility is an interesting factor that influences the performance of routing protocols. Recently developed WSNs protocols assume that the sensor nodes and base stations are static; however in critical situation applications like battle environments where the requirement of the sink and sensors is to be mobile. Mobile nodes increase additional complexity to network topology changes that routing protocols have to manage. Frequently updates of mobile node location over the network reduce the energy level of nodes and busy the propagation medium. The Routing protocols must be efficient in order to manage the mobility overhead and topology changes in such an energy-constrained situation, while still maintaining the full functionality of the network. Design considerations for networks containing mobile nodes include reliable packet delivery, energy efficiency and slow message delivery latency.

2.8.1 Mobility principles

The wireless nature of WSNs presents the ability to support mobile entities within a WSNs. Mobility can be present in WSNs in three forms:

- *Node mobility*: All or a subset of the source nodes are mobile in this context and depends on the intended application. Node mobility implies that the network topology will change with time if one or more source nodes move away from predetermined message paths to a base station. There is a trade-off between the energy consumed to maintain full network functionality and the tolerance of routing protocols to handle topology changes due mobility of source nodes.
- *Sink mobility*: Sink nodes may be mobile in an attempt to reduce energy consumed to propagate a data message across the network to a base station. The base station may not even be part of the network; such as a user collecting data using a Personal Digital Assistant (PDA). The challenge is to design the routing protocol to be able to facilitate requests from a mobile base station that will change its geographic position over time and to route data message to such a mobile base station.

- *Event mobility*: The phenomena required to be sensed by the source nodes may be mobile and moving between sensor nodes. This does not seem challenging at all, if you consider that it is still just another phenomenon that needs to be sensed. However routing protocols such as TEEN (described in 2.7.2) may request specific attributes from source nodes in specific regions. These types of protocols need to be aware of event mobility and is tightly bound to the application.

The following are some established Mobility Aware routing protocols that are accepted by literature: An adaptive strategy for energy efficient data collection in sparse wireless sensor networks [132], Secure data collection using mobile data collector in clustered wireless sensor networks [133], Lightweight mobile data gathering strategy for wireless sensor networks [134], Mobile Agent based Data Fusion for Wireless Sensor Networks with a XML Framework [135], Data gathering in wireless sensor networks with mobile collectors [136], Data collection in sensor networks with data mules: An integrated simulation analysis [137], Deploying Multiple Mobile Sinks in Event-Driven WSNs [138], Multiple Mobile Sinks Positioning in Wireless Sensor Networks for Buildings [139], Data Gathering in Wireless Sensor Networks with Multiple Mobile Collectors and SDMA Technique Sensor Networks [140], On Data Collection Using Mobile Robot in Wireless Sensor Networks [141] and Data collection in wireless sensor networks assisted by mobile collector [142]. The next subsections are to give a brief description about some influential contributions for hierarchical network architectures.

2.8.2 Data collection in Wireless Sensor Networks by utilizing multiple mobile nodes

The major and vital concern in wireless sensor networks (WSNs) is data collection in an efficient manner. Many researches prove that using mobile nodes to collect and transfer data in WSNs is more beneficial than static multi-hop routing. The author of [143] emphasizes on data collection issues in WSNs with minimum mobile nodes and proposed a path planning based algorithm to reduce the number of mobile nodes by optimizing the feasible path for each mobile node. Mobile node is responsible to pick up the data cached in a sensor node via one-hop distance once it travels near a point

that R meters far from this static node. Every mobile node must visit the sensor nodes that are allocated to it because the storage capacity of sensor node is not enough, in every t seconds to elude the excess of sensor data as illustrated in Figure 2.24 adopted by [143]. The deployment of mobile nodes within the network is totally dependent upon the moving speed, when the moving speed of mobile node is fast enough then only one mobile node can cover all sensor nodes in t seconds. However, in real environment, the moving speed of mobile node is limited then multiple nodes are required to visit all sensor nodes in specified time.

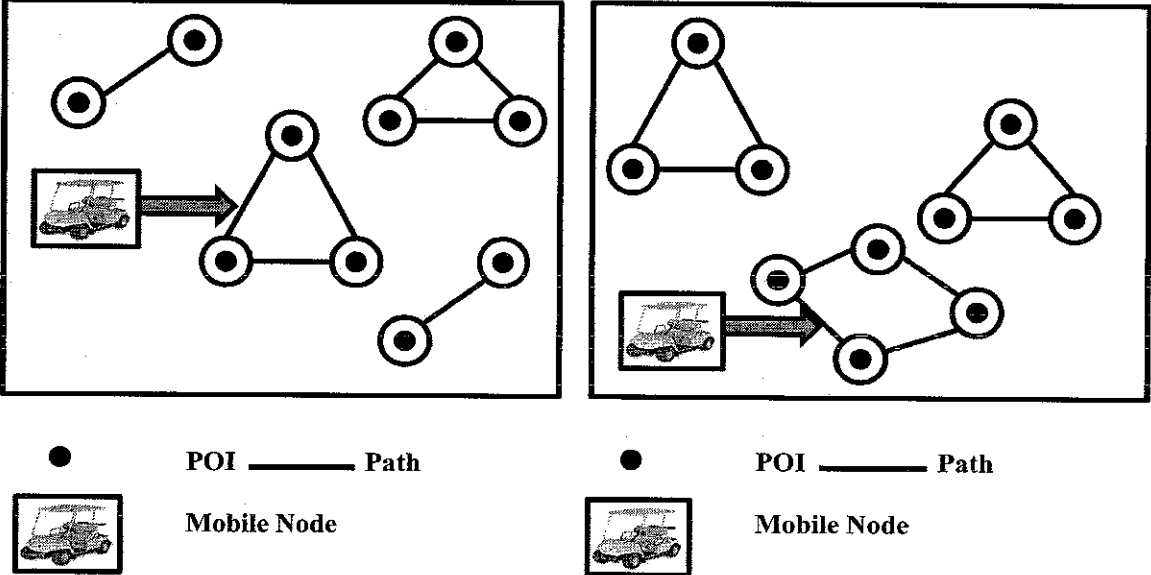

Figure 2.24 Data collection by using multiple mobile nodes [143]

In summary, this protocol provide formal model the issue of global t -visit with the minimum mobile nodes via one hop wireless communications, propose a heuristic path planning algorithm to reduce the number of mobile nodes and optimize their travel paths. Finally, the simulation results show that proposed scheme can extraordinarily decrease the number of mobile nodes once compared with existing protocols.

2.8.3 Mobile data collector strategy for delay sensitive applications

Wireless Sensor Networks (WSNs) literature demonstrates that the static sink accomplishes badly in terms of network lifetime and end-to-end delay, moreover number of techniques develop mobile sink to collect the data from sensor nodes in

non-delay-sensitive applications. The authors of [144] propose a new routing protocol for mobile data collector based on data reliability and low-latency for delay-sensitive WSNs applications. This proposed MDC/PEQ protocol employs mobile data collectors (MDCs) that periodically broadcast the beacon messages, sensor nodes receive these beacon messages to join the MDC's cluster and update their routing information in order to forward the data packets to related MDC.

All information exchanged are kept nearby the neighbors of the nodes to minimized the overhead and sensor nodes achieve simple but well-organized path re-establishment through the signal strength of the beacon message. According to proposed solution to minimize end-to-end packet delay and increasing the reliability of data with small or no overhead by decreasing the number of hops where packet of data have to navigate. Moreover, the simulation experiments results ensure that the introduction of mobile data collectors in WSNs minimizes the congestion at the nodes closer to the sink as illustrated in Figure 2.25 adopted from [144].

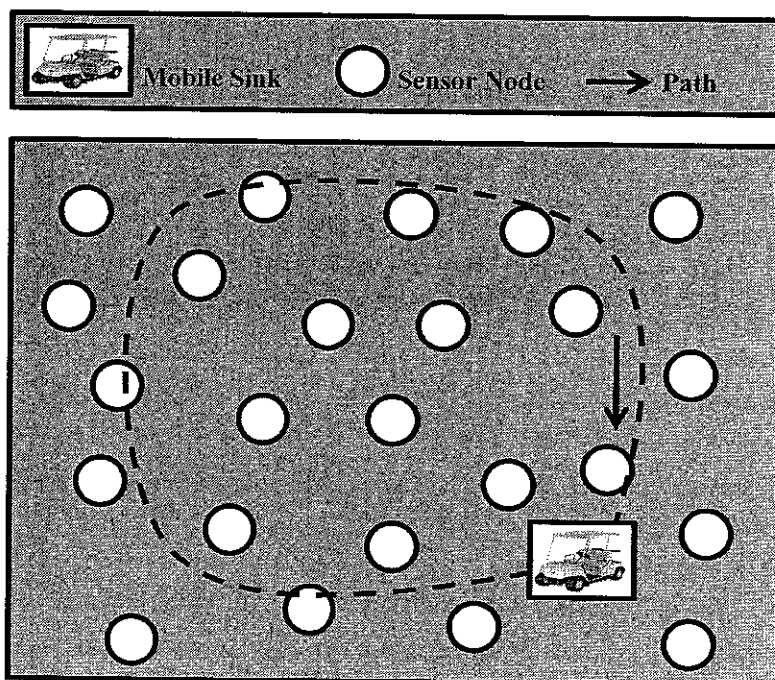

Figure 2.25 Sensor network with Mobile Data Collector [144]

The author showed an interesting experimental results that on average 80% of sent data messages are forwarded successfully to MDC. The results also indicate that the successful packets delivery ratio is much higher than compared to the static PEQ and argues that the improvement is due to the minimized hops of message propagation to

a MDC. The decreasing in the number of hops to reach a destination should positively reduce energy depletion in the network as a whole. The successful packet delivery ratio is however influenced negatively if the movement speed of the MDC increases.

2.8.4 Routing to a Mobile Data Collector (MDC) on a predefined trajectory

In [145] propose a novel distributed technique of data collection using mobile data collector in WSNs where MDC travels beside a predefined route along the area of sensor network and forward sensor data through relaying nodes towards the sink or access point. Delay-sensitive and delay-tolerant are two category of data; delay-sensitive data are directly forward the data to data collector while delay-tolerant data collected at nearby relaying node where data collector is responsible to gather the data and forward to base station or access point. Hypothetical investigation is to measure the effect of mobility of data collector in terms of network lifetime as matched with static data collector WSNs.

The proposed architecture does not need any type of synchronization among the data collector and sensor nodes, in delay-sensitive data the delay measured is very similar to stationary base station network. This is the first protocol scheme in mobility aware routing protocol that provides on-line data delivery to mobile data collector in localized, distributed and asynchronous techniques.

2.8.5 ROME: Routing Over Mobile Elements in Wireless Sensor Networks

The author of [146] presents Routing over Mobile Elements (ROME), a geographic protocol for WSNs characterized by high dynamics, such as node addition, node removal and the mobility of some of the network nodes. ROME builds on geographic forwarding protocols that have been defined for networks with static nodes and a static sink. The proposed protocol retains desirable properties such as optimized performance through cross layer design, receiver-based relay selection, asynchronous nodal duty cycles and the ability to deal with connectivity holes in the network topology (dead ends).

ROME combines an energy-efficient MAC protocol with greedy forwarding endowed with a mechanism for escaping from connectivity holes. The functioning of the protocol is summed up as follows. In order to save energy, nodes follow asynchronous awake/asleep schedules (duty cycles). A node does not know its neighbors and their duty cycles. When a node has a packet to transmit it initiates a contention phase, looking for a relay between its awake neighbors (eligible relays). The aim is that of finding a relay to advance the packet toward the sink. Let x be a node engaged in packet forwarding, and let $F(x)$ be the portion of node x transmission area where relays offering positive advancement toward the sink are located as illustrated in Figure 2.26 adopted from [new 78].

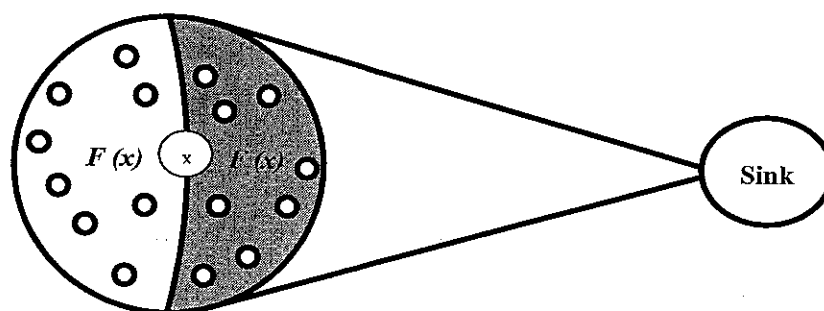

Figure 2.26 ROME: Forwarding region of x [146]

To advance the packet towards the sink node x selects a relay among the awake neighbors in $F(x)$ (greedy forwarding). This advancement is always possible when there is at least a neighbor closer to the sink. There are times, however, when this simple greedy mechanism fails because of dead ends i.e. nodes that have no neighbors in the direction of the sink. To cope with dead ends ROME borrows the basic ideas of ALBA-R coloring mechanism, extending it to cope with network dynamics and nodes mobility. The contribution of this research in WSNs by defining and testing, ROME, a routing protocols for networks with mobile nodes. While dealing with mobility, ROME also retains desirable properties of protocols proposed for routing in static WSNs which includes dealing with node addition and removal as well as congestion and connectivity holes. Through simulations, the results show that on scenarios with static and mobile nodes together ROME is an efficient solution that delivers all generated packets to the sink and outperforms ad hoc schemes that have been proposed for mobile networks.

2.8.6 Prolonging Network Lifetime via a Controlled Mobile Sink in Wireless Sensor Networks

In [147] explore the mobility of a mobile sink in a wireless sensor network (WSN) to prolong the network lifetime. Since the mechanical movement of mobile sink is driven by petrol and/or electricity, the total travel distance of the mobile sink should be bounded. To minimize the data loss during the transition of the mobile sink from its current location to its next location, its moving distance must be restricted. In addition, considering the overhead on a routing tree construction at each sojourn location of the mobile sink, it is required that the mobile sink sojourns for at least a certain amount of time at each of its sojourn locations. The distance constrained mobile sink problem in a WSN is to find an optimal sojourn tour for the mobile sink such that the sum of sojourn times in the tour is maximized.

First, formulate a joint optimization problem referred to as the distance-constrained mobile sink problem, by providing a mixed integer linear programming solution. Due to its hardness, then propose a novel three-stage heuristic that exhibits low computational complexity and high scalability. That is, it first calculates the sojourn time profile at each potential sojourn location. It then finds a feasible sojourn tour for the mobile sink such that the sum of sojourn times at the chosen sojourn locations is maximized, subject to the mentioned constraints. It finally makes a sojourn time scheduling for the mobile sink by determining its exact sojourn time at each chosen sojourn location. Finally conduct extensive experiments by simulations to evaluate the performance of the proposed algorithm in comparison with the optimal solution by solving the MILP. The experimental results demonstrated that the solution delivered by the proposed algorithm is the nearly optimal and comparable with the MILP formulation but with much shorter running time.

2.8.7 Advantages of mobility aware routing protocol

The main advantage of mobility aware routing protocols is its ability to support static as well as mobile nodes in the network. The mechanisms introduced to offer this support attempts to avoid network separation due to mobile nodes while promoting high message delivery success ratios at the base station.

2.8.8 Disadvantages of mobility aware routing protocol

The mechanisms utilized to provide mobility support may be detrimental to the protocol's network scalability with increasing network sizes and/or a higher fraction of mobile nodes in the network.

Mobility support adds additional computational complexity in order to determine and predict node movement and data collection strategies. The added computational complexity adds additional power requirements with an increase in the amount of mobile nodes to perform normal routing activities.

Mobile aware routing protocols may assume the deployment of homogeneous nodes or not. Some of the mobile nodes acting as data collectors may require unlimited power resources.

2.9 Critical Evaluation of LEACH and Hybrid Multi-hop LEACH

Since LEACH [122] and Multi-hop LEACH [127] are described in literature survey which are the base starting points of this research work, this section cover the critical analysis of the design rules of these protocols.

2.9.1 Energy dissipation due to displacement

The foremost drawback of LEACH routing protocol is directly forwarding the aggregated and compacted data from all cluster heads to the base station, in this situation some of the cluster heads are far from the base station and other are closer to it because of all sensor nodes are ubiquitous in an enormous area. This has been huge effect in terms of communication energy depletion among the cluster heads towards the base station. Two types of radio communication energy depletion includes transmitter/receiver electronics and transmit amplifier energy. Normally the energy of amplifier is essential for efficient communication that is much bigger than the energy of transmitter and receiver electronics and controls the energy depletion of communication.

The minimum essential energy of amplifier is directly related to double the distance from source to preferred destination (E_{Tx-amp}/d^2) advising in free space and lognormal shadowing model, so the energy depletion of communication significantly increases when the distance of communication rises. That is proved, the far cluster heads acquired much more energy to forward the data towards the base station than the other cluster heads those near the base station and the significance difference arises in energy dissipation among the sensor nodes those which are near and far the base station after successful rounds of the network. In LEACH protocol all sensor nodes start with same energy level, the far nodes utilizes the energy before those closer the base station, so the overall effect the network divided in two sections by alive and lifeless nodes and the network performance declines.

2.9.1.1 Energy dissipation calculation in LEACH protocol

First order radio model is the big achievement in the area of low energy radio networks; this model gives very simple equations for both transmitting and receiving data from one node to another node are given below in equations 2.1 and 2.2.

$$E_{Tx}(l, d) = E_{Tx-elec}(l) + E_{Tx-amp}(l, d) \quad (2.1)$$

$$= \begin{cases} lE_{elec} + lE_{fs}d^2, & d < d_0 \\ lE_{elec} + lE_{fs}d^4, & d \geq d_0 \end{cases}$$

$$E_{Rx}(l) = E_{Rx-elec}(l) = lE_{elec} \quad (2.2)$$

Transmission energy to transmit a message of l bits comprises radio electronics dissipation $E_{Tx-elec}(l)$ and amplifier dissipation $E_{Tx-amp}(l, d)$; d is the distance between transmitter and receiver. If d is less than a threshold d_0 , $E_{Tx-amp}(l, d) \propto d^2$ according to the free space model; otherwise $E_{Tx-amp}(l, d) \propto d^4$ is according to the multipath model. E_{elec} and E_{amp} are affected by many factors, LEACH protocol set as: $E_{elec} = 50$ nj/bit and $E_{amp} = 10$ pj/bit/m². Figure 2.27 explains the data transmission architectural view of LEACH protocol.

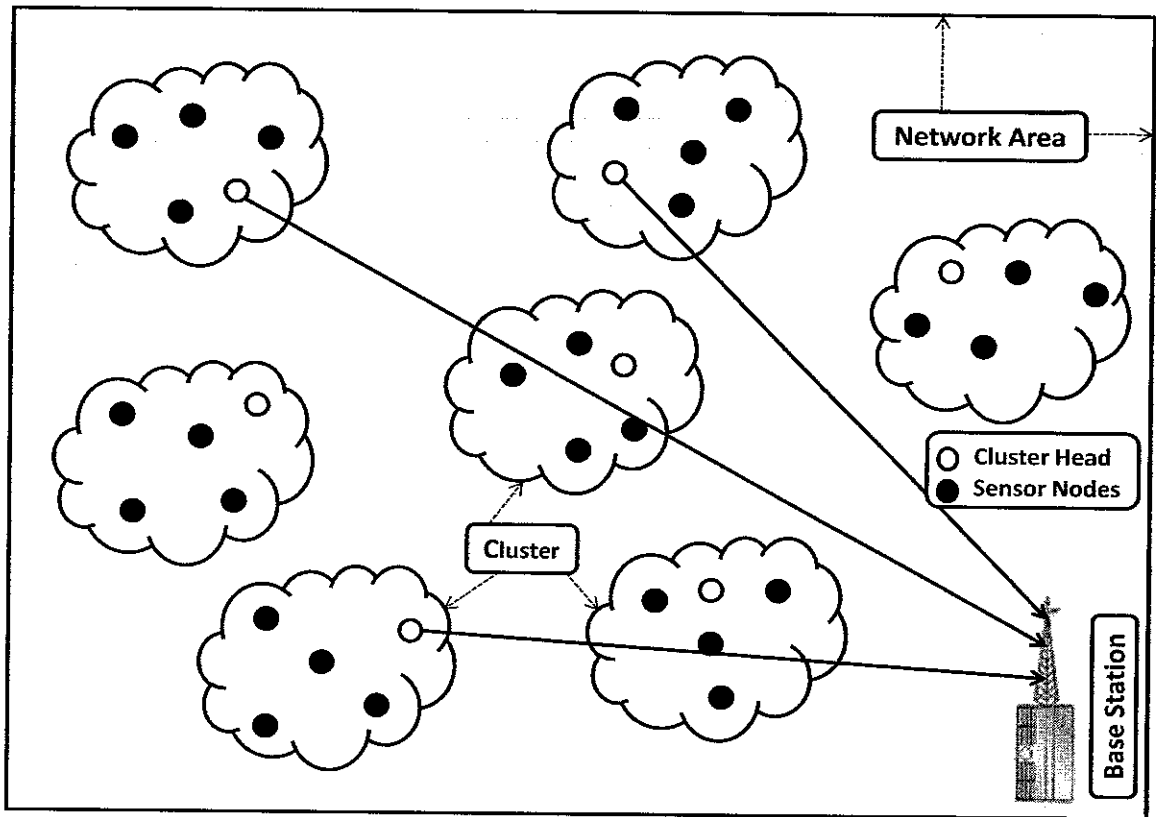

Figure 2.27 Data transmission in LEACH protocol

Therefore, for above given parameters it is clear that receiving and transmitting data is not a low cost operation. Energy dissipation of transmission and receiving analysis between nodes A and B are given below, suppose the packet size is 288 bits and distance d is approximately 30 meters.

$$\begin{aligned}
 \text{Energy dissipation to transmit per packet} &= lE_{elec} + lE_{amp}d^2 \\
 &= l(E_{elec} + E_{amp} * d^2) \\
 &= 288 (50 \text{ nj/bit} + 10 \text{ pj/bit/m}^2 * (30)^2) \\
 E_{Tx}(l, d) &= 16.9 * 10^{-6} \text{ J}
 \end{aligned}$$

$$\begin{aligned}
 \text{Energy dissipation to receive per packet} &= lE_{elec} \\
 &= 288 * 50 \text{ nj/bit} \\
 E_{Rx}(l) &= 14.4 * 10^{-6} \text{ J}
 \end{aligned}$$

2.9.1.2 Energy dissipation calculations in hybrid multi-hop LEACH protocol

Energy dissipation of transmission and receiving analysis between nodes A and B in Hybrid multi-hop LEACH, suppose the packet size is 288 bits and distance d is approximately 12 meters from cluster head to another cluster head.

$$\text{Energy dissipation to transmit per packet} = lE_{elec} + lE_{amp}d^2$$

$$= l(E_{elec} + E_{amp} * d^2)$$

$$= 288 (50 \text{ nj/bit} + 10 \text{ pj/bit/m}^2 * (12)^2)$$

$$E_{Tx}(l, d) = 14.8 * 10^{-6} \text{ J}$$

$$\text{Energy dissipation to receive per packet} = lE_{elec}$$

$$= 288 * 50 \text{ nj/bit}$$

$$E_{Rx}(l) = 14.4 * 10^{-6} \text{ J}$$

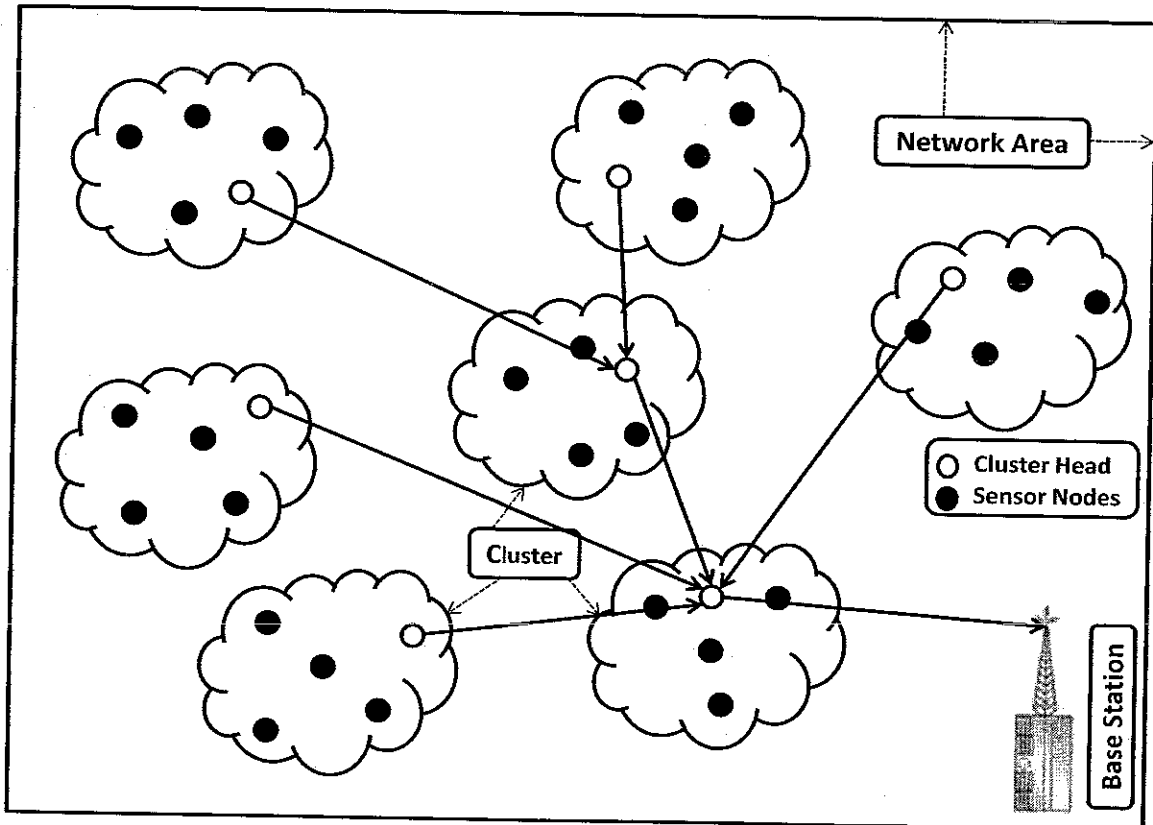

Figure 2.28 Data transmission in Hybrid multi-hop LEACH protocol

Figure 2.28 explains the data transmission architectural view of Hybrid Multi-hop LEACH protocol.

2.9.2 Communication holes

Energy and routing holes are the major types of communication holes. The energy hole problem is a key factor in WSNs which disturbs the lifetime of network because sensor nodes normally perform as originator and router of data. The communication obeys a many-to-one and converge-cast pattern, where nodes transmit heavy communication load near the base station, causing increased energy dissipation rate [1]. This eventually creates sink separation from rest of the network known as an energy hole. This energy hole is present near the base station instead of other topographical region covered by the network. After arising the energy hole the sink is not able to receive any data from sensor nodes, therefore an energy deletion is wasted in significant quantity and the network lifetime ends prematurely [148 - 152].

The primary and utmost objective in communication network is efficient routing. The efficient routing protocol in WSNs is to increase the quality of network services and prolong the network lifetime. Two types of “routing holes” can exist in real time sensor networks such as redeployable and non-redeployable holes. In redeployable holes are formed because of physically destruction or dissipation of energy, so the additional nodes may be redeployed in the network region to carry the whole WSNs back in an efficient way. Hence, this redeployable hole is also known as “temporary holes”. Another type of routing hole is “permanent holes” which are non-redeployable holes arise mainly because of harsh environment (e.g. lakes, river etc.) and physical hurdles (e.g. big trees, buildings etc.). As the name denotes the non-redeployable holes cannot be fixed by just falling extra sensors nodes [153 - 156].

2.9.3 Energy and routing hole in hybrid multi-hop LEACH protocol

The whole sensor network in Hybrid multi-hop LEACH [127] protocol is distributed into small areas that are acknowledged as cluster and one node is selected as a cluster head in each cluster which is responsible to collect accumulated data from its member nodes of the cluster and transmit it to next cluster head or base station. The drawback of this multi-hop routing protocol is facing energy and routing hole problems, since cluster head near the base station relaying heavy traffic load from another cluster heads in every round and relaying cluster head is died in current round because of

energy depletion as illustrated in Figure 2.29. This problem is arising again in every round because the network topology is changing due to the mobility of sensor nodes and cluster heads are different from the previous one in each round, so the overall effect is the network lifetime of this multi-hop routing protocol does not live longer and data reliability is not sufficient at the base station.

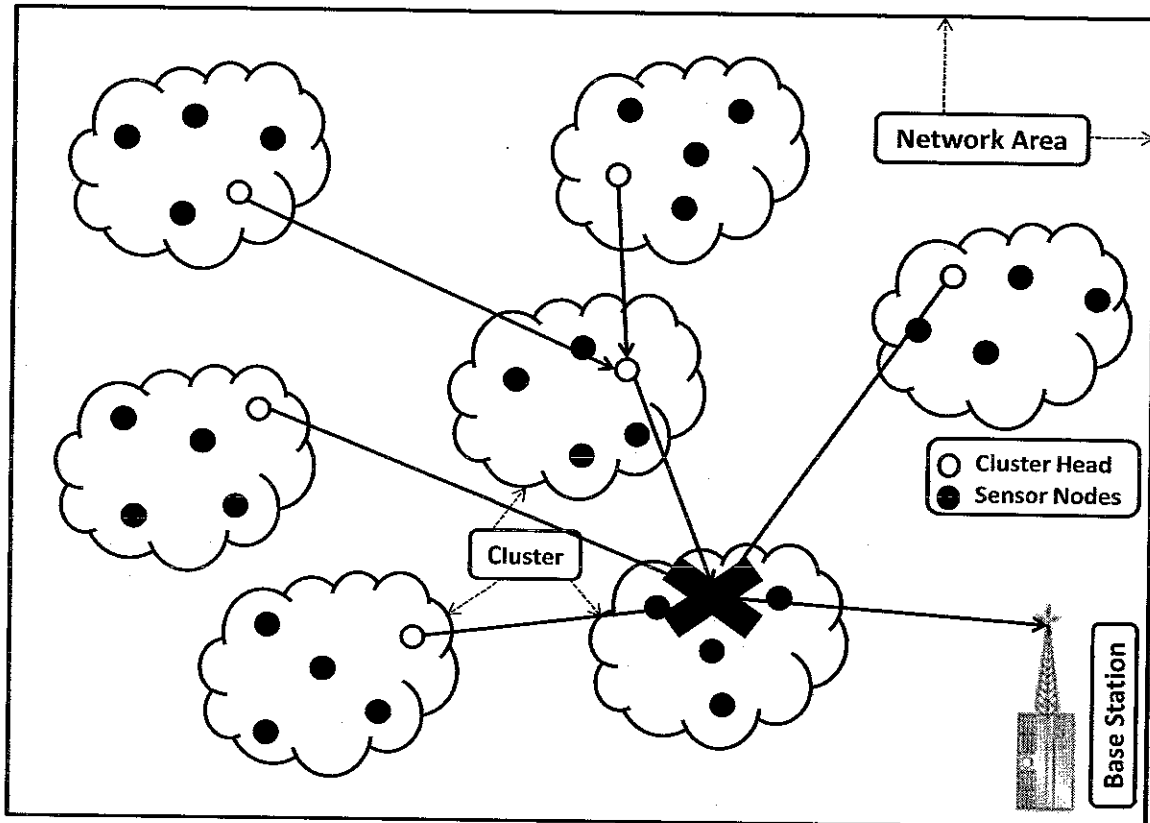

Figure 2.29 Energy hole in Hybrid multi-hop LEACH protocol

According to energy hole concern in Hybrid multi-hop LEACH protocol which directly impacts in routing mechanism of the network. The routing path from cluster head to the base station is not available any more due to heavy traffic loads from another CH's and immediately drain the energy; this effect is continuously dropping the sensed and valuable data because the final route destination is breakdown as illustrated in Figure 2.30. The overall effect is number of nodes which are selected as a cluster head in each round are died because of energy and routing hole problem occurs, so the network is not able to live for a longer period.

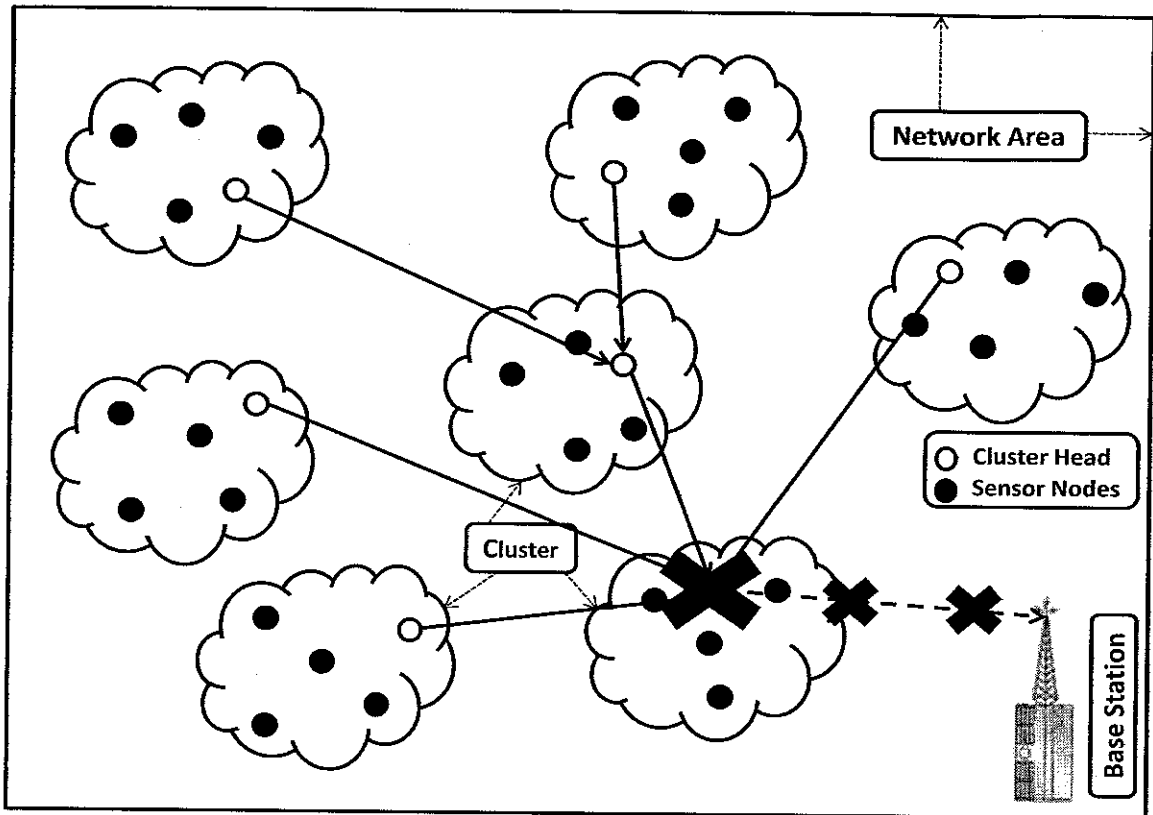

Figure 2.30 Routing Hole in Hybrid multi-hop LEACH protocol

2.10 Chapter Summary

Wireless Sensor Networks (WSNs) is a new technology with multitudes of possibilities for new and interesting applications. These networks can be deployed randomly without physical restrictions as with normal wired sensor systems. Communication within these networks is of utmost importance and the most energy consuming activity. Due to the physical restrictions of the network and its components, energy conservation should be the very first consideration when developing WSN and researching further the current body of knowledge.

This chapter presented a brief overview on the communication with WSNs and in more detail the concepts and principles that apply to the network layer. To conserve energy and maximize the lifetime of the network, a routing protocol needs to be as simple and scalable as possible. The design of a routing protocol should consider the intended network topology and operations required from the application layer. The considerations for protocol design, simulation and evaluation are summarized at a

high level.

The design and improvement of any research project to positively contribute the current body of knowledge, requires a fundamental understanding of the leading and most referenced work available in literature. This chapter summarizes the main contributor's research and implementations applicable to WSNs routing protocols. WSNs routing protocols can be categorized into data centric, hierarchical and mobility aware network topologies. The protocols influencing this research are covered at a high level with reference to more detailed documents. The protocols that are used as benchmark and for simulation analysis later in this dissertation are described; these are LEACH and novel application specific network protocol for wireless sensor networks (Hybrid multi-hop LEACH). Mobility aware routing protocol is covered briefly with the presentation of a protocol providing tolerance to mobility in WSNs; the concept of MDC provides the groundwork that is adopted to complement this research.

Each of the protocols presented in this chapter does have its own set of challenges and unique approaches but the intent is to use the advantages and powerful mechanisms to enhance the design of this research.

CHAPTER 3

DESIGN OF MOBILE DATA COLLECTOR BASED HIERARCHICAL CLUSTERING ROUTING PROTOCOL

3.1 Introduction

Each of the seminal contributions briefly described in previous chapter was designed while considering the consequences of every design decision made. Literature dictates the main consideration for the design of routing protocols should be energy efficient. Other considerations should also be taken into account such as communication holes, scalability, reliability and mobility. These considerations affect the final proposal, design and performance of a new routing protocol.

The scope of this dissertation includes the design of proposed routing protocol named the Mobile Data Collector Based clustering routing protocol (MDC based LEACH) for Wireless Sensor Networks. This protocol is grounded on famous LEACH and novel application specific network protocol for wireless sensor networks (Hybrid multi-hop LEACH) to allow for energy efficient data gathering within the networks where topological changes due to mobility are unavoidable.

3.2 Design Consideration of Proposed Protocol

This section discusses energy efficiency as well as the additional considerations taken into account during the design of Mobile Data Collector based routing protocol.

3.2.1 Energy efficiency

Sources in literature state that transmission among nodes in WSNs is the highest energy consuming activity in the network [86]. The functional lifetime of the network as a whole can be prolonged by reducing the energy consumption in every node. The design of MDC based LEACH routing protocol is based on the following mechanisms in an attempt to maximize energy conservation.

3.2.1.1 Source initiated

The source nodes will forward sense data messages towards the cluster head. There is no requirement for the cluster head to forward interests or queries to one or many of the source nodes. In fact, any request from the cluster head for any data messages should be ignored by the sensor nodes. This design choice reduces the global network knowledge of nodes and the number of messages transmitted to receive the data messages.

3.2.1.2 Event driven

Sensed data transmissions are dictated by the source nodes (source initiated) and will only forward data messages if relevant data is available. The transmission period can be based on a fixed period or when predefined thresholds are reached, source initiated and event driven mechanisms constitute the same operation in most cases.

3.2.1.3 Data aggregation

The aggregation of data messages in cluster heads reduces the amount of transmission overhead and the total amount of messages being transmitted in the network as a whole. Data aggregation has been proven in literature to produce higher energy conservation and reduction in message duplication.

3.2.2 Data reliability

The intention of sensor applications is to gather information of sensed phenomena in order to react to specific data if so required. The successful delivery of data messages at the base station is a very important QoS property and requirement to fulfill the need of the application. Data messages are thus required to successfully propagate through the network to the sink node with the lowest possible latency. The reliability of the protocol needs to be weighed against the energy efficiency, excellent energy efficiency does not add any value if the successful message delivery ratio is too low.

3.2.3 Scalability

All flat network routing protocols and some of the recently developed hierarchical routing protocols assume the deployment of homogeneous. The scalability of MDC based LEACH routing protocol is manifested in the following properties:

- Hardware independence requires that all nodes in the network have the same functionality, available resources and will equally participate in the protocol operation.
- Simplified multi-hop routing strategy enables a higher scalability factor for the expansion of network on demand. Routing logic is localized to each node and its immediate cluster head, no global network knowledge is required. Routing data messages will only know the current location of nearest MDC by the help of MDC beacon messages and then forward the message towards the base station.

3.2.4 Node mobility

Traditional routing protocols rely on a static deployment of sensor and base stations in the network. Some parts of the network may become isolated from its path to the sink; then the node will fail or move beyond the maximum transmission distance and static nodes are not able to sense the data from sharp edges of the network area. Implementation of the mobile nodes and mobile data collector within the network is

the viable solution to monitor or sense the data from whole network and collected at base station efficiently.

The node movement model can be random movement pattern by the help of probability density function and mobile data collector utilizes predefined trajectory to relay the data towards the base station. Mobile Data Collector may introduce as a reduction in traffic load at the cluster head that is closest to the sink and knowledge of MDC location status is required to successfully alter the routing protocol behavior for cluster heads.

3.3 System Model

Mobile Data Collector based routing protocol (MDC based LEACH) consider an environmental monitoring applications sensor network, consisting of R data collectors and N sensor nodes in an area A . To emulate the real-life situations, all the nodes are distributed randomly across the area A . Here, a number of mobile data collectors are assumed to be marked in the network with a predefined movement pattern and a relatively slow constant speed.

MDC based LEACH routing protocol follow the three-tier network architecture of Mobile Wireless Sensor Networks (mobile WSNs). The mobile data collectors in this type of architecture are equipped with a radio transceiver to communicate with sensor nodes and base station. Every sensor node collects the data from neighboring location and sends this collected data to cluster head and then cluster heads forward the data towards base station by one of the Mobile Data Collectors (MDC) (i.e. multi-hop communication). The multi-hop simulation model implies that nodes will be indirectly contacted with the sink/base station.

Every cluster head requires local memory to store sensed aggregated data messages of nodes until being sent. Every mobile data collector would require an internal clock (or timing mechanism) to update the current location itself by sending beacon messages to cluster heads in every 5 seconds.

3.3.1 Proposed framework and topological architecture

The proposed framework and topological architecture of MDC based LEACH routing protocol for wireless sensor networks is expressed in Figure 3.1 and 3.2 respectively. This architecture reduces the energy consumption of the sensor nodes, enhance the network lifetime and increase traffic received at base station. MDC based LEACH uses three-tier network architecture and multi-hop communication for data aggregation and transmission from sensor node to base station. It has been observed that this type of architecture enhances the network scalability for large-scale environmental applications, reduce the channel disputation area and prospective energy saving.

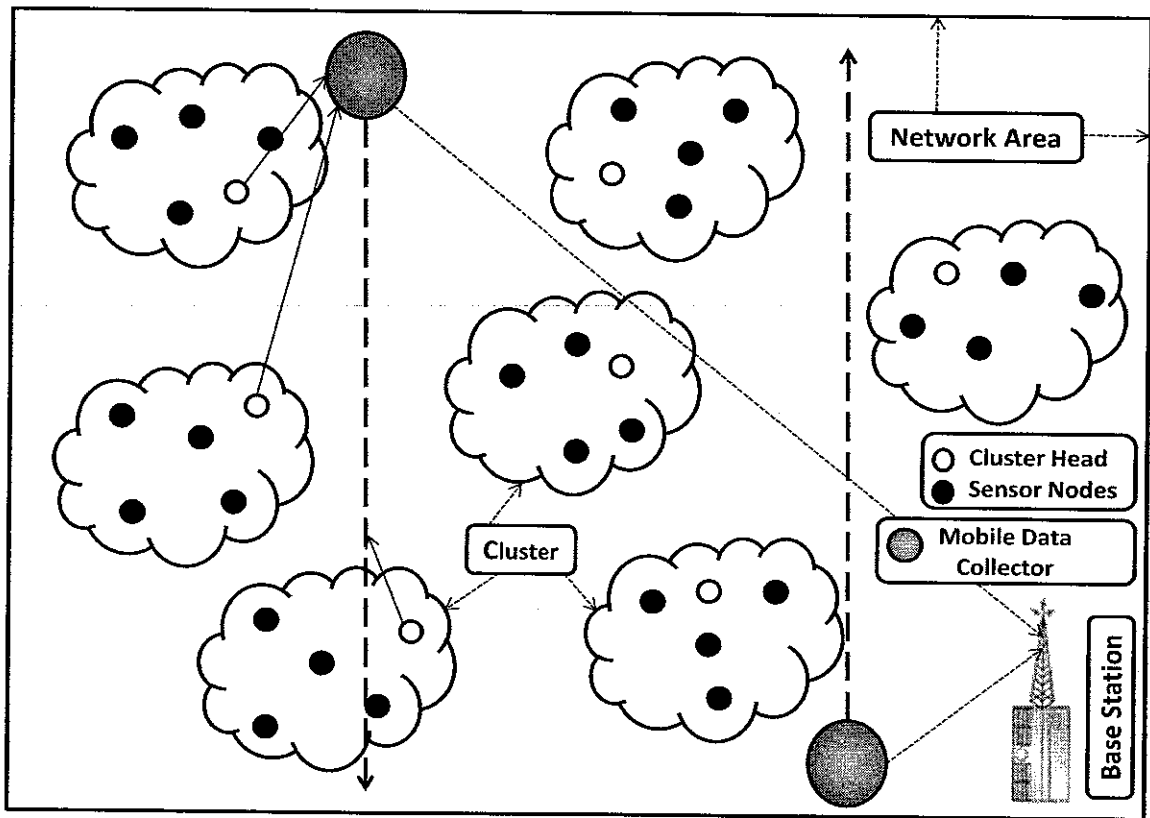

Figure 3.1 Proposed framework

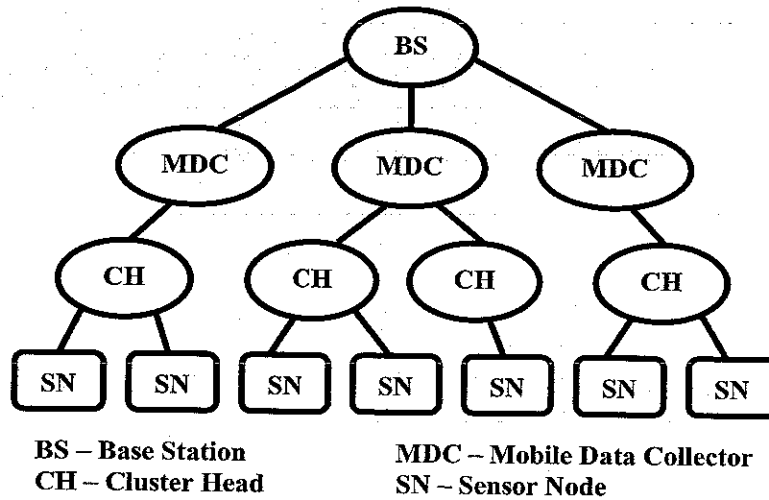

Figure 3.2 Topology of MDC based LEACH hierarchy

3.3.2 Description of proposed protocol

Mobile Data Collector based routing protocol is an application specific hierarchical protocol for WSNs, applicable to monitoring the remote environments. Therefore, proposed protocol is based on some assumptions as follows:

- Any node in the network has transmission power enough to communicate with cluster head and can amend the amount of transmission power to its need.
- Each node can perform protocols and tasks of signal processing.
- Sensor nodes have data to send to cluster head periodically.
- The sensed data of nodes are correlated because nodes are located close to each other.

At this scenario, data related to the events of the environment are often correlated. MDC based LEACH uses a clustering hierarchical architecture, all sensed data from nodes within a cluster can be processed locally and reduces the amount of data to be transmitted to the end user. The main characteristics of MDC based LEACH are described as follows.

- Cluster formation in MDC based LEACH is randomized, adaptive and self-configuring.
- Data transfers can be controlled locally.
- It Adopts MAC protocol for minimum energy consumption.

- It performs application specific data processing, such as data compression or accumulation.

The operation of MDC based LEACH mechanism is distributed into time intervals where every time interval consists of two phases: setup and steady state. The mentioned time interval is determined prior to node deployment, the clusters are formed in set-up phase and data transferring from cluster heads to MDC and then to the BS in the steady-state phase as illustrated in Figure 3.3.

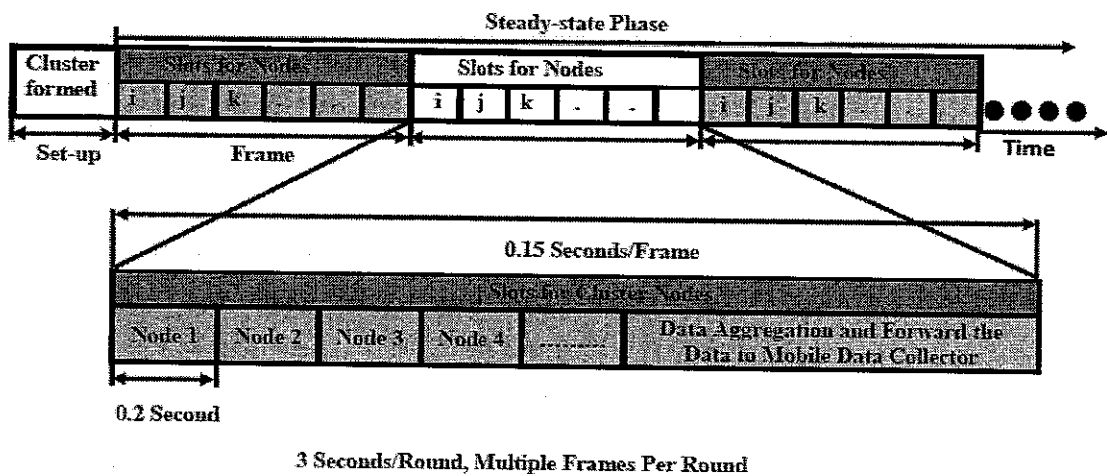

Figure 3.3 MDC based LEACH operation time line

The LEACH hierarchical architecture is adopted in this protocol, in addition with multi-hop routing by the help of relay agent that is mobile data collector. After the formation of clusters, the mobile data collector can create a multi-hop routing mainstay in proposed protocol; the data packets of this approach are routed to takes several hops towards the base station by the help of mobile data collector (MDC). The major benefit of this approach is to reduce communication energy dissipation of nodes and reliable data delivery but need to some tradeoff in End-to-End delay.

Carrier Sense Multiple Access (CSMA) protocol is used as a MAC layer protocol in order to decreasing the collision probability, thus CSMA MAC protocol is suitable to WSNs specialized for environmental monitoring applications. Moreover, the node in the network is aware of its location by Global Positioning System (GPS) technology and cluster head receives beacon messages timely from mobile data

collector to know about the location. At the beginning of every time interval, the network will start with a setup phase and progress on to a data transmission phase.

3.3.3 Setup phase

Every node chooses independently whether it should become a cluster head, based on the predetermined percentage of cluster heads and the amount of times that node has fulfilled the function of cluster head. Assume node n will determine its cluster head status by selecting an arbitrary number between 0 and 1 and compare it to a threshold value $T(n)$ for the round. If the chosen arbitrary number is less than the threshold value $T(n)$, then node n becomes a cluster head for the specific round. The threshold value [24] is calculated as:

$$T(n) = \begin{cases} \frac{P}{1 - P * \left(r \bmod \frac{1}{P}\right)} & \text{if } n \in G \\ 0 & \end{cases} \quad (3.1)$$

Where P is the desired percentage of the total amount of nodes to function as cluster heads at any given moment, r is the current round and G is the set of nodes involved in the cluster head selection that has not been cluster head in the last $\frac{1}{P}$ rounds. Empirical research shows that the optimal percentage of cluster heads average at 3 to 5 % of the total amount of nodes in the network.

Every node that selects itself as a cluster head will now broadcast an advertisement message to all its neighbors. Upon receiving the broadcast message, source nodes will decide on a cluster head to join based on the highest received signal strength of the broadcast message. The receiving node will notify the cluster head of its joining. The wireless transmission during the setup phase utilizes a Carrier Sense Multiple Access (CSMA) MAC protocol. Each cluster head creates a Time Division Multiple Access (TDMA) schedule, to assign a time slot for every joined source node and will broadcast the schedule to all the cluster nodes. The timeslot assigned in the TDMA schedule will allow every node to transmit data messages without interference from other node transmissions.

3.3.4 Steady state phase

After all nodes have been informed of the cluster TDMA schedule, it will forward data messages to the cluster head if they have data available. Each source node may disable its radio outside the period of that node's transmission timeslot in the TDMA schedule, as an additional method of conserving energy. After the time schedule of all nodes has elapsed, the cluster node aggregates the data into a single message to be transmitted to mobile data collector and immediately forward towards the base station. The operation of set-up phase of mobile data collector based routing protocol (MDC based LEACH) can be summarized by Figure 3.4.

When a CH's received sufficient data from its members then it will change the spreading code for transferring the data to MDC and uses CSMA is employed as a MAC layer protocol to avoid possible collision between them. The cluster head then filters all received energy using the given spreading code. Thus neighboring clusters radio signals will be filtered out and not corrupt the transmission of nodes in the cluster. Efficient channel assignment is a difficult problem, even when there is a central control centre that can perform the necessary algorithms. Using Code Division Multiple Access (CDMA) codes, while not necessarily the most bandwidth efficient solution does solves the problem of multiple-access in a distributed manner [64]. However, CDMA codes is a pre-eminent solution in cluster based WSNs routing because the method of multiple access that does not divide up the channel by time, every CHs send aggregated data at the same time with his own pseudo code. Using conventional modulation techniques, it is most certainly impossible.

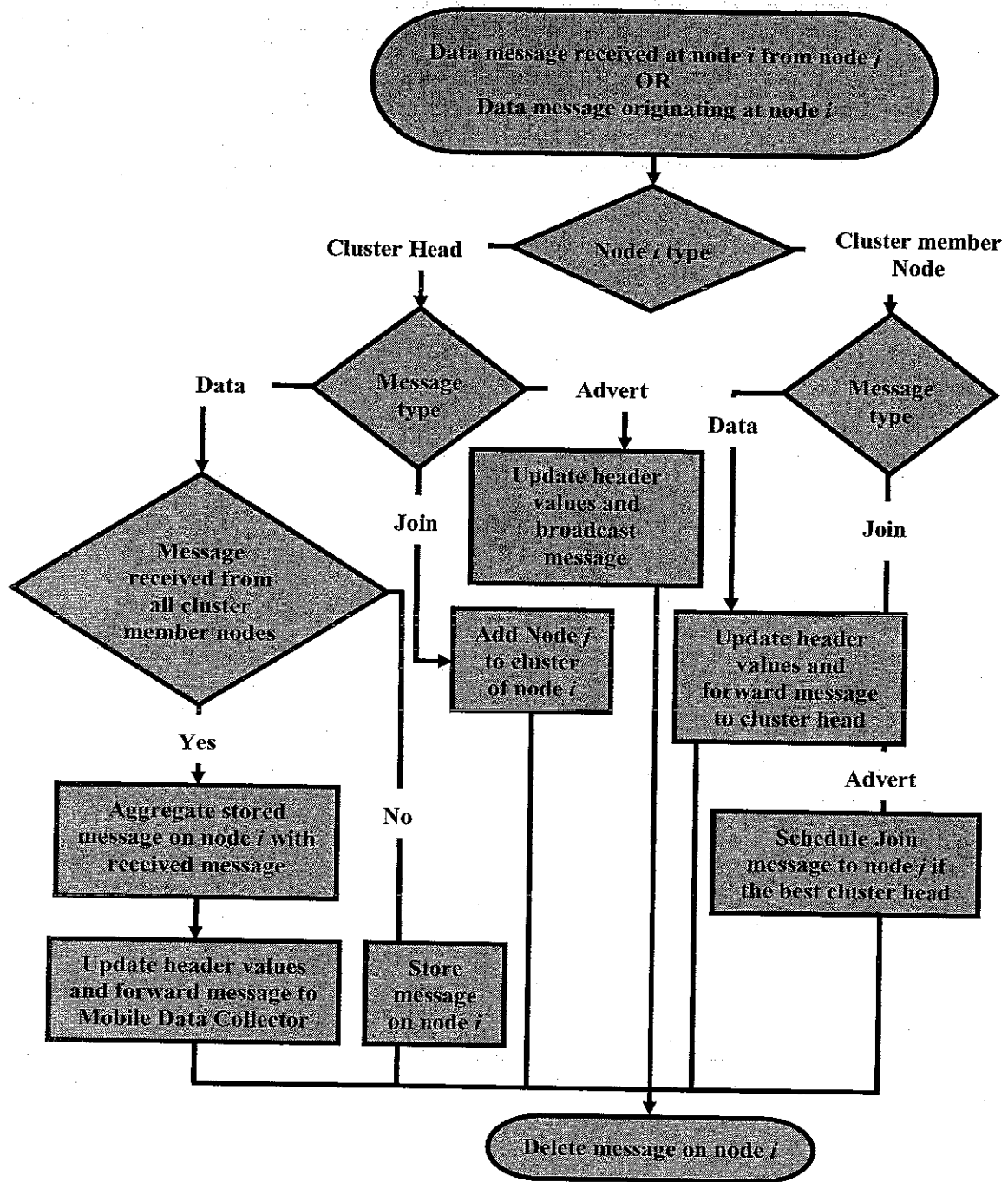

Figure 3.4 Set-up message process flow of MDC based LEACH

What makes CDMA work is a special type of digital modulation called “Spread Spectrum”. This form of modulation takes the user’s stream of bits and splatters them across a very wide channel in a pseudo-random fashion. The “pseudo” part is very important here, since the receiver must be able to undo the randomization in order to collect the bits together in a coherent order. After successful transmission of data

towards MDCs then CHs return to receive the sensed data messages from its member's node by allocating time slots. As discussed earlier, all CHs using multi-hop routing strategy by the help of mobile data collector to relay the aggregated data packet towards the base station. Every 5 seconds the MDC's transmit a beacon message to all cluster heads for data fusion, this beacon message contains the location update information of MDC is illustrated in Figure 3.5.

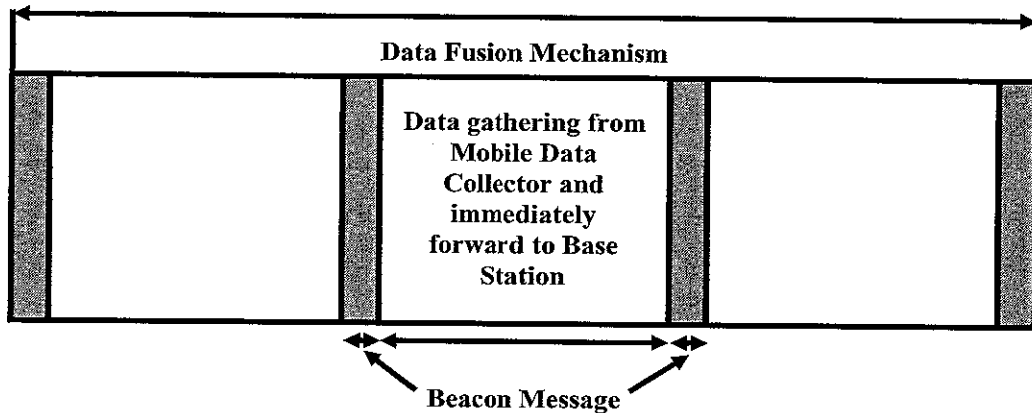

Figure 3.5 MDC Beacon Message

However, this multi-hop technique would increase network latency but in proposed protocol End-to-End and channel access delay is trade-off with energy dissipation of sensor nodes and data transport reliability. The duration of the steady state phase is much longer than the setup phase to conserve energy. Since energy is quite precious in inaccessible sensor nodes for environment monitoring, the routing algorithm used here should be as simple as possible to prevent complexity of the protocol.

3.4 Simulation of Proposed Routing Protocol

Lacking availability and additional cost of WSN hardware imposes difficulties on the research, practical implementation and verification of WSNs routing protocols. Routing protocols can be modeled in simulation tools to overcome these difficulties and emulate the real world scenarios. Simulation of routing protocols can provide valuable information in terms of protocol validation, optimization and simulation environments assist in improving the accuracy and credibility of protocol performance

by ensuring that results are repeatable and verifiable by other researchers. Available discrete event simulators can provide a base for researchers to analyze and debug the operation of a protocol design.

This dissertation focuses on the network layer routing protocol and certain assumptions have to be made about the rest of the sensor node architecture artifacts and environment variables. These artifacts and variables influence the implementation and simulation results of this research and are discussed in the following subsections.

3.4.1 Application layer

In an attempt to design a routing protocol adaptable to a wide variety of applications that function on a periodic data reporting mechanism, the application layer is specified very simplistically. The application layer expects all of the sensor nodes to forward the sensed data at a specific interval time.

3.4.2 Medium access control layer

It is assumed that the Medium Access Control (MAC) Layer will handle contention for the radio channel by implementing a Carrier Sense Multiple Access (CSMA) MAC protocol for all wireless communications in the proposed routing protocol. Simulation of other routing protocol for comparison purposes require the implementation of Time Division Multiple Access (TDMA) MAC protocol as well as CSMA for broadcasting purposes.

3.4.3 Physical layer

The physical layer consists of the basic networking hardware transmission technologies. It is a fundamental layer underlying the logical data structures of the higher level functions in a network. The Binary Phase Shift Key (BPSK) is a binary digital modulation scheme used in this research work i.e. one modulation symbol is one bit and gives high immunity against noise and interference and a very robust

modulation. A digital phase modulation, which is the case for BPSK modulation, uses phase variation to encode bits. Each modulation symbol is equivalent to one phase. The phase of the BPSK modulated signal is π or $-\pi$ according to the value of the data bit. An often-used illustration for digital modulation is the constellation, transmitting more bits per unit bandwidth comes at a cost and complexity of the receiver. In another schemes receiver requires complex DSP (number crunching) while BPSK receiver requires a simple design, which reduces energy consumption of node during sensing, processing and transmission in WSNs.

3.4.4 Channel model

The channel model for the purposes of this research assumes symmetrical radio frequency (RF) links. Symmetry of the radio channel implies that the same amount of energy will be consumed to transmit a message from node A to node B , as compared to a transmission from node B to node A . This is not a perfect model but is assumed sufficient for the purpose of routing protocol modeling, as long as the same model is used for all the simulated routing protocols. The author of [157] empirically attempts to prove that a symmetrical and error free RF link is not valid by collecting transmission and reception data between multiple nodes. Although the results show that link symmetry is not always valid, a fair amount of inter node communication still confirms to this model. The conclusion is that protocol simulations should not assume symmetry and should include a fair amount of link asymmetry as part of the research.

The channel model is further not assumed to be totally error free and does consider channel irregularities and interference to a minor extent. The adopted free-space-loss model in [18] is used in the simulations where the received power (P_r) can be represented as a function of the transmitted power (P_t) by:

$$P_r = \frac{P_t}{\left(4\pi/\lambda\right)^* d^\alpha} \quad (3.2)$$

Where λ is the signal wavelength, d is the distance between transmitting and receiving nodes and α is referred to as the path loss exponent. Environmental noise

conditions present a huge problem to the errors generated in wireless transmissions. The path loss exponent attempts to cater for environmental interferences.

When an electromagnetic signal propagates, it may be diffracted, reflected or scattered. These effects have two important consequences on the signal strength. First, the signal strength decays exponentially with respect to distance. Second, for a given distance d , the signal strength is random and log-normally distributed about the mean distance-dependent value.

The lognormal distribution describes the random shadowing effects, which occur over a large number of measurement locations and have the same transmitter and receiver separation but have different level of clutter on the propagation path. This phenomenon is referred to as lognormal shadowing. Simply put, lognormal shadowing implies that measured signal levels at specific transmitter and receiver separation have a Gaussian (normal) distribution about the distance-dependent mean, where the measured signal levels have values in dB units. The lognormal shadowing path loss model also adopted in this research work as well.

$$PL(d) = PL(d_0) + 10n \log_{10} \left(\frac{d}{d_0} \right) + X_\sigma \quad (3.3)$$

Where d is the transmitter-receiver distance, n the path loss exponent (rate at which signal decays), X_σ a zero-mean Gaussian (in dB) with standard deviation σ (multi-path effects), d_0 a reference distance and $PL(d_0)$ the power decay for this distance. Usually, n and σ are obtained through curve fitting of empirical data.

The received signal strength (P_r) at a distance d is the output power of the transmitter (P_t) minus $PL(d)$, i.e. $P_r = P_t - PL(d)$ (all powers in dB).

3.4.5 Radio model

The model of radio specifies the energy consumed during the transmission and reception of messages over a wireless medium. MDC based LEACH routing protocol employs a simple First Order Radio Model illustrate in Figure 3.6, where the transmitter and receiver dissipate E_{elec} 50 nj/bit and transmit amplifier circuit ϵ_{amp} 100 pj/bit/m² to achieve an acceptable E_b/N_o . The current state-of-the-art in radio

design, the First Order Radio Model factors are slightly improved than the other models. For example, the Bluetooth initiative specifies 700 kbps radios that operate at 2.7 V or 30 mA, or 115 nJ/bit [122].

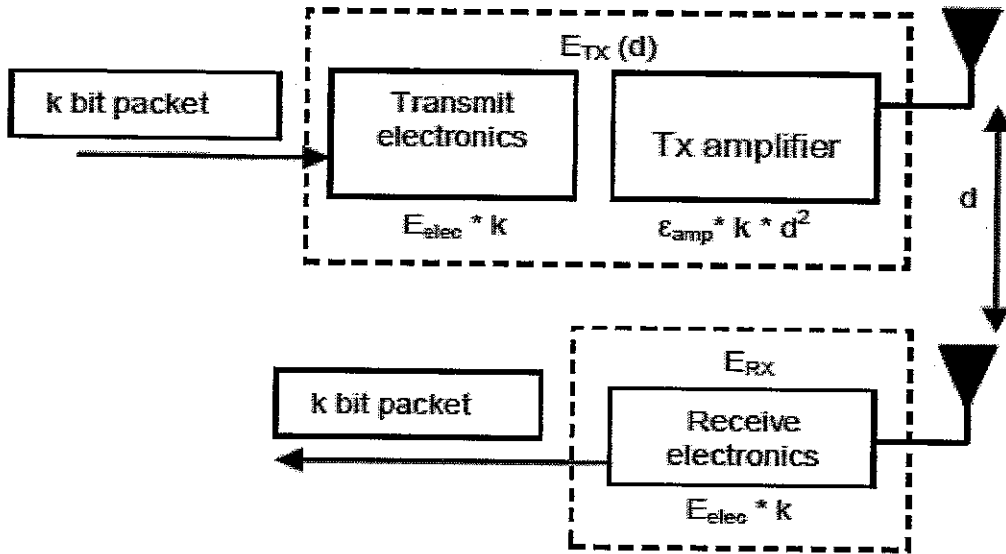

Figure 3.6 First order radio model

Suppose r^2 is energy loss within channel transmission, when send a k bit message at a distance d by the help of radio model, the transmission end calculations are in equation 3.4 and 3.5:

$$E_{Tx}(k, d) = E_{Tx-elec}(k) + E_{Tx-amp}(k, d)$$

$$E_{Tx}(k, d) = E_{elec} * k + \epsilon_{amp} * k * d^2 \quad (3.4)$$

And receiving end calculations are:

$$E_{Rx}(k) = E_{Rx-elec}(k)$$

$$E_{Rx}(k) = E_{elec} * k \quad (3.5)$$

This model specifies a high energy consuming radio model, which emphasizes the need to minimize message transmissions. The same maximum transmission distance is used for all the simulation models in this research work. Assumes that all radios can transmit at the same maximum transmission distance [157] questions this assumption with a real-world data collection exercise and suggests using real-world data as input to simulators to compensate for factors like elevation of nodes, radio interference etc.

3.4.6 Node hardware and mobility

This research assumes the deployment of homogeneous nodes across the simulation area with a single static base station. The following properties are assumed for every sensor node:

1. Cluster heads memory is used to store and aggregate sensed data of nodes.
2. Limited power source and variable power radio transmitter.
3. Location updates knowledge of mobile data collector to cluster heads.

The movement of mobile nodes is not orchestrated by the nodes but by means of external influence. The mobility of mobile data collector could be manifested by attaching a sensor node to a moving vehicle or to a person for that fact. The movement pattern of sensor nodes used for simulation is random and the movement speed of mobile data collector is predefined, mobility is one of the main research topics in this research work and proposed protocol is evaluated with mobile sensor nodes.

3.5 Mathematical Models

In this research work several mathematical models have been implemented at physical, data link and network layer of OSI reference model to simulate Mobile Data Collector based routing protocol. These are explained as follows:

3.5.1 Energy dissipation calculation

$$\text{Energy dissipation to transmit per packet} = lE_{elec} + lE_{amp}d^2 \quad (3.6)$$

$$\text{Energy dissipation to receive per packet} = lE_{elec} \quad (3.7)$$

l = Number of bits

E_{elec} = Radio electronics

E_{amp} = Transmit amplifier

d = displacement

3.5.2 Power received calculation

$$centre_{freq} = base_{freq} + \left(\frac{bandwidth}{2.0} \right) \quad (3.8)$$

$$\lambda = \left(\frac{C_{speed}}{center_{freq}} \right) \quad (3.9)$$

$$power = sqrt \left(\frac{\lambda^2 * own_{power}}{16\pi^2 * pkt_{power}} \right) \quad (3.10)$$

3.5.3 Displacement calculation between two nodes

$$displacement = pow \left((x_{pos} - intx_{pos}), 2 \right) + pow \left((y_{pos} - inty_{pos}), 2 \right) \quad (3.11)$$

pow = Power function

x_{pos} = Consume energy

$intx_{pos}$ = Initial position on x-axis

y_{pos} = Total energy

$inty_{pos}$ = Initial position of y-axis

3.5.4 Cluster head selection based on residual energy

$$P_i(t) = \begin{cases} (1 - (E_{con}/E_{total})) * \frac{k}{N - k * \left(r \bmod \frac{N}{k} \right)} & \\ 0 & \end{cases} \quad (3.12)$$

$P_i(t)$ = Calculate the probability

E_{con} = Consume energy

E_{total} = Total energy

k = Number of cluster

N = Total number of nodes

r = Round number

3.5.5 Free space propagation model

$$P_r = \frac{P_t}{\left(\frac{4\pi}{\lambda}\right)^2 d^\alpha} \quad (3.13)$$

P_r = Received power

P_t = Transmitting power

π = Pie standard value

λ = Signal wavelength

d = Transmitter-Receiving distance

α = Path loss exponent

3.5.6 Log-Normal shadowing model

$$PL(d) = PL(d_0) + 10n \log_{10} \left(\frac{d}{d_0} \right) + X_\sigma \quad (3.14)$$

$PL(d)$ = Path loss at reference distance

$PL(d_0)$ = Power decay at reference distance

d = Transmitter-Receiving distance

n = Path loss exponent

X_σ = Zero-mean Gaussian distributed random variable

σ = Standard deviation of X

3.6 Mobile Data Collector Based Routing with Minimum Distance

The architectural view of MDC Minimum Distance LEACH protocol and flowchart is illustrated in Figure 3.7 and 3.8 respectively.

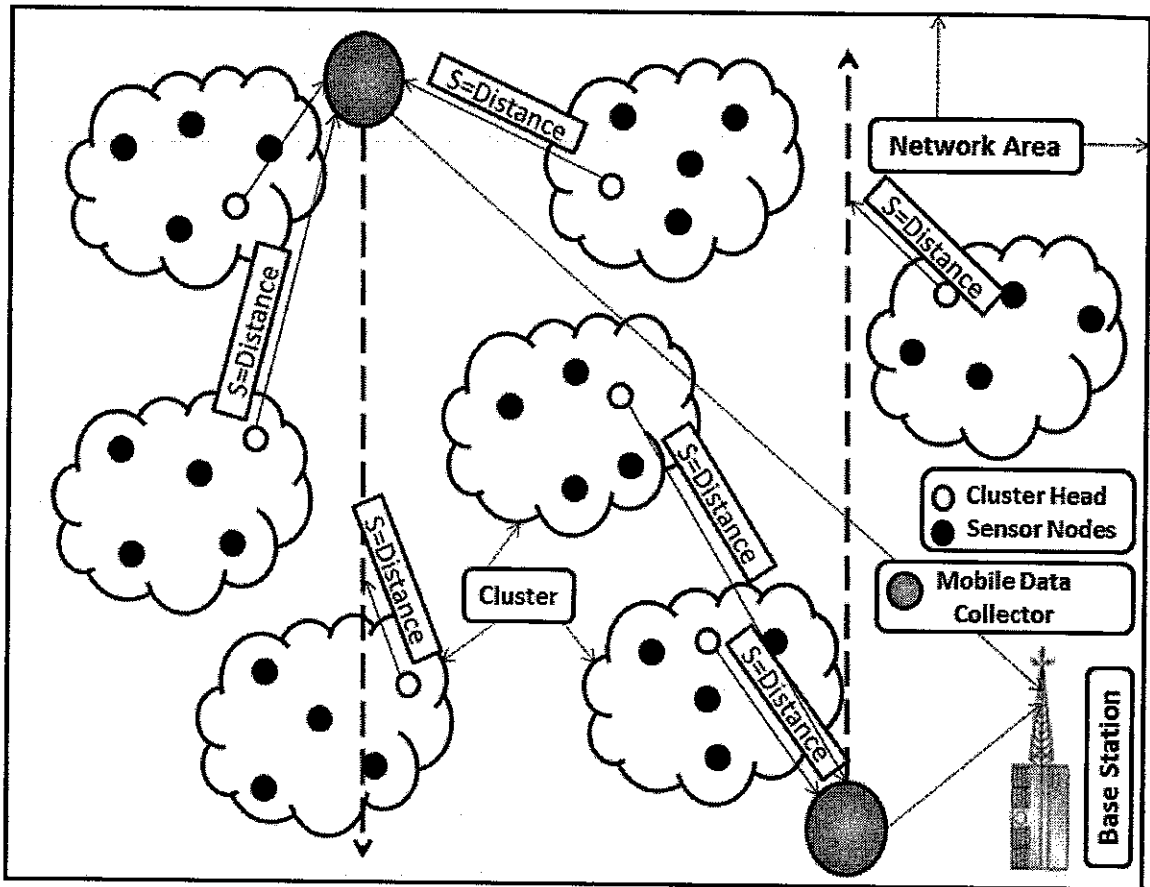

Figure 3.7 MDC minimum distance LEACH

According to inverse square law, the energy of transmission is directly proportional to the square of the distance, thus the sensor node A calculates the least distance by squared distance function $S(M)$ to reach the base station through MDC's as illustrated in Figure 3.7 and calculate by equation 3.15 and 3.16.

$$S(M) = S_{A-M}^2 + S_{M-BS}^2 \quad (M \text{ denotes } MDC) \quad (3.15)$$

Then the least of them is taken and in relation to the square of the distance from the head node A to BS .

$$\text{Min}(S(M)) < S_{A-BS}^2 \quad (3.16)$$

3.6.1 Flowchart of MDC minimum distance LEACH

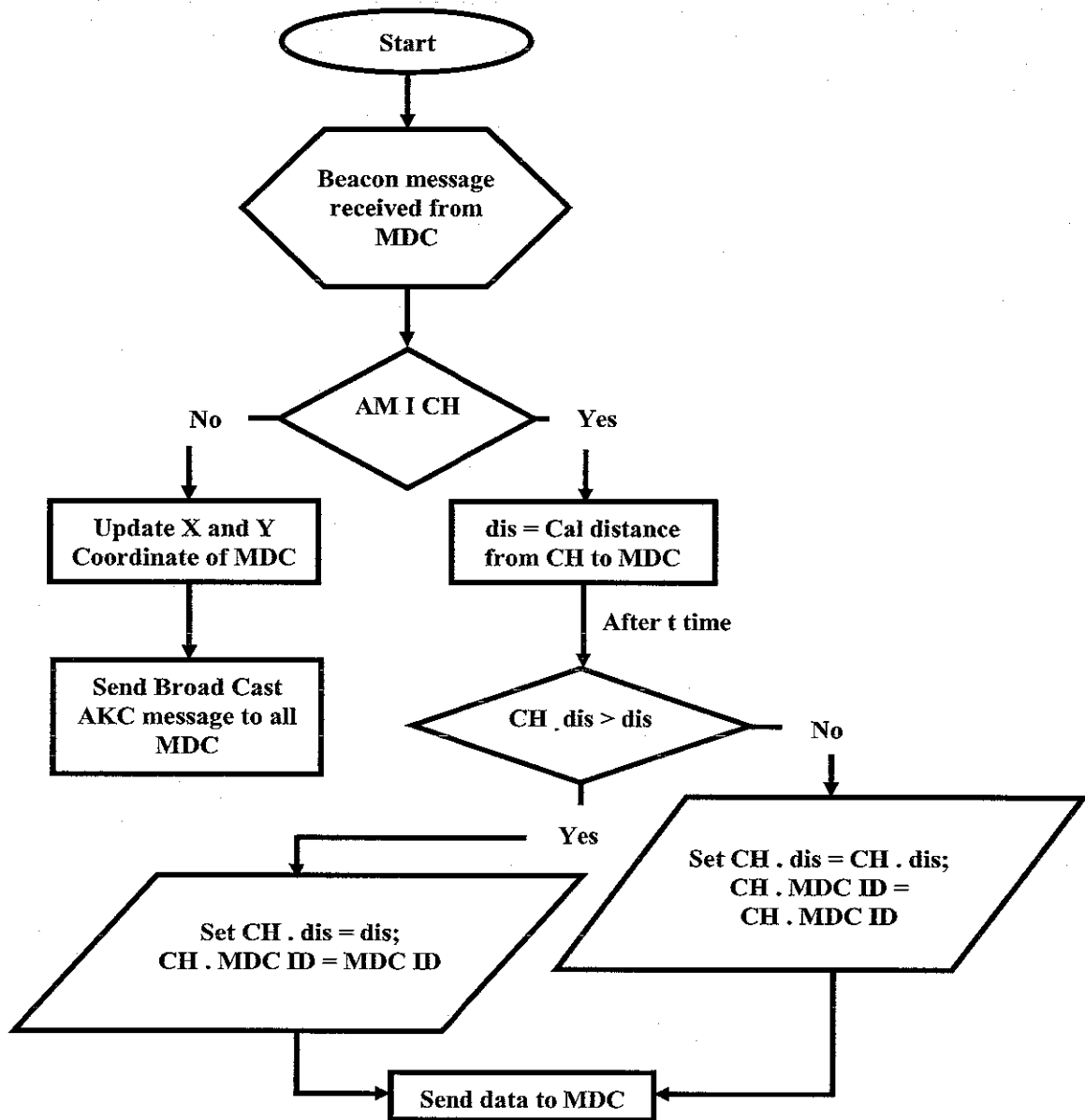

Figure 3.8 Cluster head to MDC flowchart

3.7 Mobile Data Collector Based Routing with Maximum Residual Energy

According to literature review of WSNs, the power efficient routing approaches are Maximum available (PA) route, Minimum energy (ME) route, Minimum hop (MH) route and Maximum minimum (PA) node route; MDC based maximum residual energy is based on Maximum available (PA) route [1]. In data fusion mechanism

towards the base station, all MDC's transmit a beacon message for all CH's contained by the network to update their current position and residual energy level. Figure 3.9 illustrated a MDC beacon message mechanism.

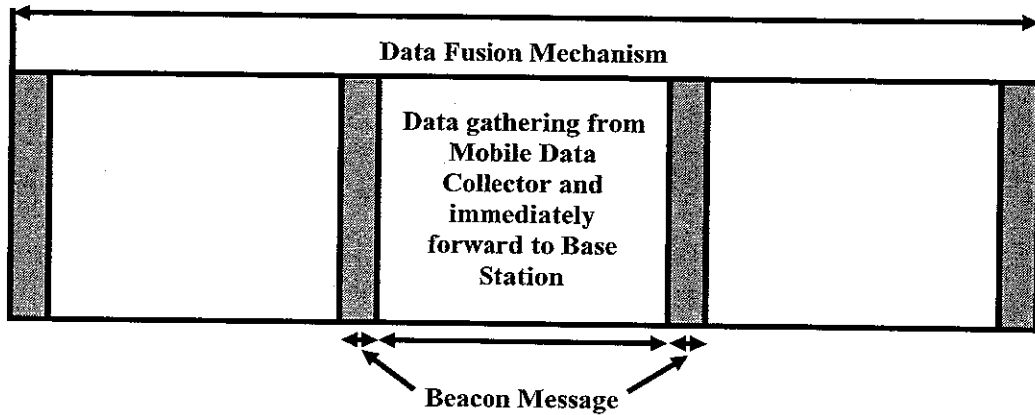

Figure 3.9 MDC Beacon Message

After receiving the MDC's Beacon message CH's select the maximum residual energy of MDC to route the data towards the base station in each round. Figure 3.10 illustrated the detailed data fusion mechanism by the approach of maximum residual energy of MDC, in current round cluster head $S1$ and $S2$ received the residual energy level from MDC 1 and MDC 2 that is 25 j and 23 j respectively. Cluster head $S1$ and $S2$ select MDC 1 for transmitting the data because the RE level of MDC 1 is higher than MDC 2. In next round, all cluster heads again receive residual energy information along with MDC current location by Beacon message from MDC's. At this round the RE level of MDC 2 is 23 j and MDC 1 is 22 j, every cluster head select MDC 2 as a relay node for data collection at the base station. Same procedure will follow for data collection within the network at the base station until the residual energy of sensor nodes and MDC's are accessible.

- Route 1 at Round 1: $S1$ and $S2$ – MDC 1 – Base Station
- Route 2 at Round 2: $S1$ and $S2$ – MDC 2 – Base Station
- Route 3 at Round 3: $S1$ and $S2$ – MDC 1 – Base Station

This approach clearly maintains the energy level of relay nodes that is MDC's throughout the network until the MDC's are alive.

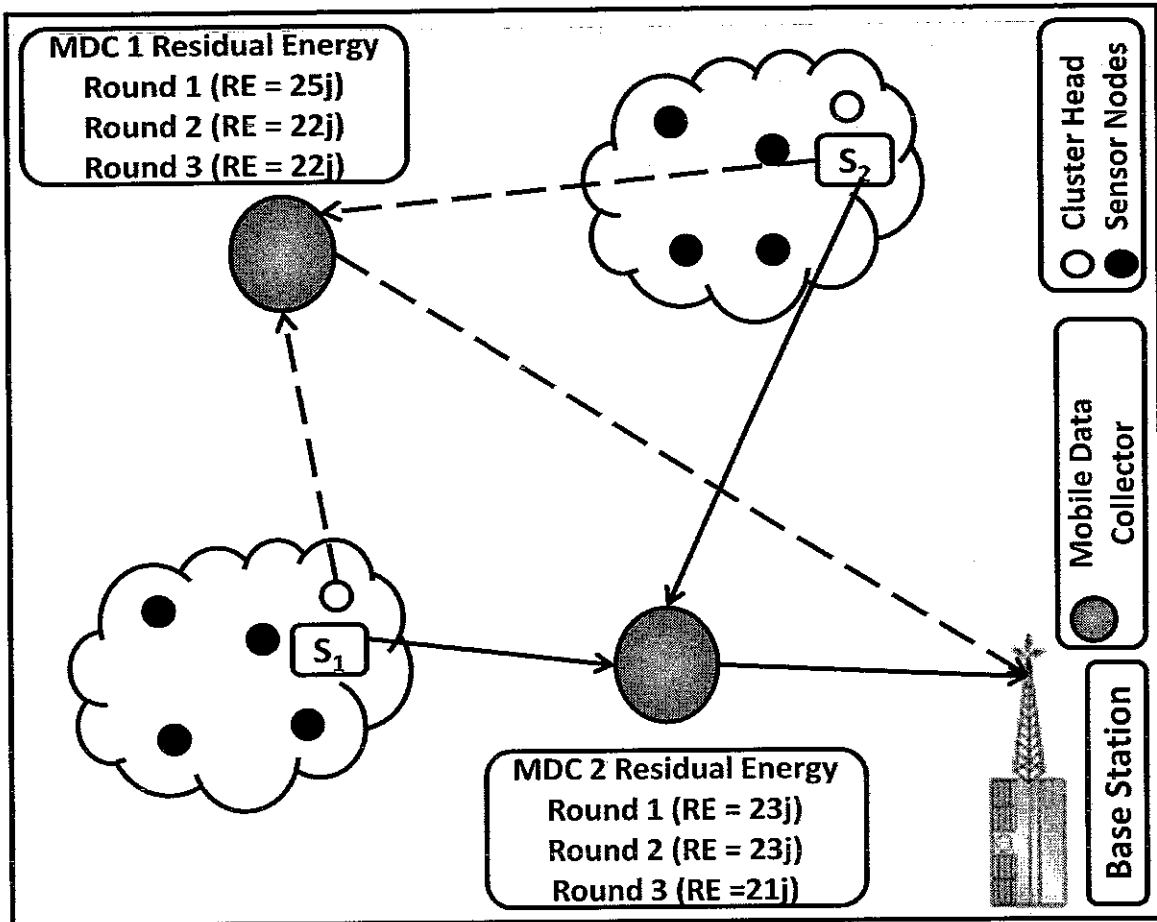

Figure 3.10 MDC maximum residual energy

3.7.1 Algorithm of MDC maximum residual energy LEACH

- a. Each Node First Decided to cluster head or member node
- b. IF a node is cluster head
 - i. Wait for t_1 random time interval and after waiting t_1 time interval cluster head broadcast announcement to all nodes.
- c. ELSE
 - i. Non-cluster head nodes listening cluster heads announces from multiple cluster heads in the network during the t_2 time interval.
 - ii. After t_2 time non-cluster heads send joining message to cluster head that is nearest to the node and wait for ACK message.
- d. IF Cluster Head receives a joining message from a node.
 - i. Add this node as member node for this round, set the TDMA schedule for that node and send ACK message to the node.

- e. IF Non-Cluster Head does not receive ACK message.
 - i. Send again joining message to the cluster head.
- f. ELSE
 - i. Wait for the beginning steady state message from its own cluster head
- g. After t_3 time all cluster heads send beginning steady state message to all member nodes in the cluster.
- h. IF non-cluster head node receives beginning steady state message from its cluster head then it will wait for its time slot for sending the data to its own cluster head.
- i. Cluster Heads receive data from member node in their own clusters and after receiving all data from member nodes then cluster head aggregate the data into one packet and send the packet to maximum residual energy MDC.
- j. IF MDC receive packet from cluster head then MDC immediately forward data to the Base Station.
- k. During Whole round MDC constantly send beacon messages to all cluster heads in the network.
- l. IF cluster head receives beacon message from MDC
 - i. IF MDC have maximum residual energy then it will keep the ID of the MDC in database.
 - ELSE
 - ii. Discard the beacon message.

3.8 Simulation Tool

Many simulation tools such as NS2, QualNet, OMNeT++ and OPNET are using to simulate WSNs environment. OPNET simulator is selected to simulate proposed MDC based LEACH routing protocol.

3.8.1 Introduction of OPNET

OPNET [158] provides an integrated development environment for distributed systems and modeling communication networks. Discrete event simulations are evaluated both behavior and performance of modeled systems. OPNET provides graphical editors and a flexible high-level programming language based on C/C++ for modeled system. This allow users to develop detailed custom models. Moreover, users can define new application statistics that are computed by user-defined process besides some built-in application statistics that are collected automatically during simulation. OPNET also includes a set of integrated post-simulation analysis tools; provide great function including processing of simulation output and performance evaluation.

3.8.2 Hierarchical editors of OPNET

OPNET [158] Models are developed hierarchically for parallels real network system consists of many editors and capture the characteristics of a modeled system's behavior at different levels of the hierarchy and address different aspects of a model. This allows lower level models to be reused and each editor has its own objects and operations. Brief descriptions of editors are as follows.

- *Project editor:* The Project Editor contains a workspace for creating and editing network models and provides the resources needed to model all high-level components of a real-world network. Project editor operations are: create and edit network models, create derived models of nodes and links, customize the network environment, run simulations and choose and analyze simulation results.
- *Node editor:* The Node Editor provides the resources necessary to model the internal functioning of nodes. Within the Node Editor, you can access different modules. Each kind of module serves to model some internal aspect of node behavior such as data creation, data storage, data processing or routing, data transmission, etc. A single node model is usually comprised of multiple modules, sometimes dozens or even hundreds of modules.

- *Process editor:* The Process Editor provides the necessary features for specifying process models that consist of both graphical and textual components. It uses state transition diagrams (STDs) to graphically depict the overall logical organization of the process model. Icons within an STD are used to represent logical states and lines are used to represent transitions between states. The operations performed by a process model are described in statements based on the C or C++ languages; these statements can be associated with states, transitions or special blocks within the process model. Editing pads are used to enter the statements associated with states and blocks.
- *External system editor:* The External System Editor provides the resources necessary to create and edit external system definitions (ESDs). An external system definition specifies an external simulator and defines the interfaces necessary to communicate with it. In the External System Editor, interfaces are represented as rows in a table.
- *Link editor:* Link models provide reusable specifications for particular “types” of link objects. Each type of link object can have different attribute interfaces, comments, representation etc. Each link object created in the Project Editor is considered to be an instance of the link model that it relies upon. Changes to the link model are inherited automatically by the link instances, allowing centralized control of large numbers of objects.
- *Packet format editor:* Packet formats define the internal structure of packets as a set of fields. For each field, the packet format specifies a unique name, a data type, a default value, a size in bits, an encoding style, a conversion method and optional comments. Packet formats are referenced as attributes of transmitter and receiver modules within node models, in calls to Kernel Procedures and by the Declare Packet Formats operation in the File menu of the Process Editor.
- *ICI (Interface Control Information) editor:* ICI formats (Interface Control Information formats) define the internal structure of *ICIs*. *ICIs* are collections of data used to formalize interrupt-based inter-process communication. Defined in the format are the names of attributes within the ICI, their data types, their default values and optional descriptions. ICI formats are referenced in call to Kernel Procedures from within process models.

- *PDF editor:* Use the PDF Editor to create, edit, and view probability density functions (PDFs). A *probability density function* defines the probability weighting for every possible outcome over a range of possible outcomes. PDFs are used as values for various attributes to model a wide variety of probabilistic events and variations within a network [158].

3.8.3 Wireless module in OPNET

OPNET [158] provides a set of tools that provide specific support for modeling of a variety of communication networks. Among them, Wireless Module allow users to simulate wireless networks that include moving sites (both nodes and subnets), radio communications, or both. Some capabilities are added to OPNET in the Wireless Module:

- *Moving sites:* The Wireless Module provides two types of unfixed sites: mobile and satellite. The former is proposed for most normal mobile wireless networks and the latter for satellite communication networks. Users can define trajectories of mobile sites that identify their locations as a purpose of time during simulation. While orbits of satellites can be defined that specify their motion.
- *Radio links:* In models of wireless networks, all sites communicate with each other via radio links, the most critical capability is provided by the Wireless Module. Radio links are implicit and affected by time-varying factors unlikely bus and point-to-point links such as the amendment of transmitter and receiver characteristics, communication sites movement and interfering from other simultaneous transmissions. Besides, terrain and atmospheric effects can also affect the performance of radio links. Thus, optional terrain models are provided in the Wireless Module.

In order to model transmission of packets via radio links, the Wireless Module adopts a Radio Transceiver Pipeline, which consists of multiple stages. These stages model main behavior of wireless transmission and receiving such as transmission delay, antenna gain, propagation delay and background and inference noise and error correction. There are several default

models available for each stage, which users can use to build different radio links according to their specific requirements. Certainly, users can also design their own models for the stages in the Radio Transceiver Pipeline using C/C++ programming language.

- *Simulation features:* The Wireless Module classify all nodes and share the results of pipeline stages among them to reduce simulation time. In addition, animation of sites movement can be viewed during simulation.

In this research project, OPNET is chosen as simulation tool to model the protocols for WSNs because the channel model is too simplistic and enough models of relevant protocols for WSNs. OPNET provides a fairly realistic simulation environment among the available network simulators and has many various data analysis and debugging tools and a perfect user interface.

The provision of modeler for an inclusive developed environment has then supported both the modeling of communication networks and distributed systems. The analysis towards behavior and performance of modeled systems comes to be possible by performing discrete event simulations. In its function, the modeler environment has integrated the tools to all phases of study which may includes model design, simulation, data collection and data analysis.

3.8.4 Network model

A network model is built to simulate LEACH, Hybrid multi-hop LEACH and MDC based LEACH protocols and these protocols are for WSNs environmental monitoring applications, the network model is based on outdoor environment. Forty (40) sensor nodes are deployed randomly in 1 (one) km² area, all sensor nodes move with random direction and user-set speed during simulation in LEACH and Hybrid multi-hop LEACH protocols. However in MDC based LEACH uses same network architecture addition with multiple mobile data collector (MDC) in predefined trajectory. The end user/BS node is stationary and located at the center of network as illustrated in Figure 3.11.

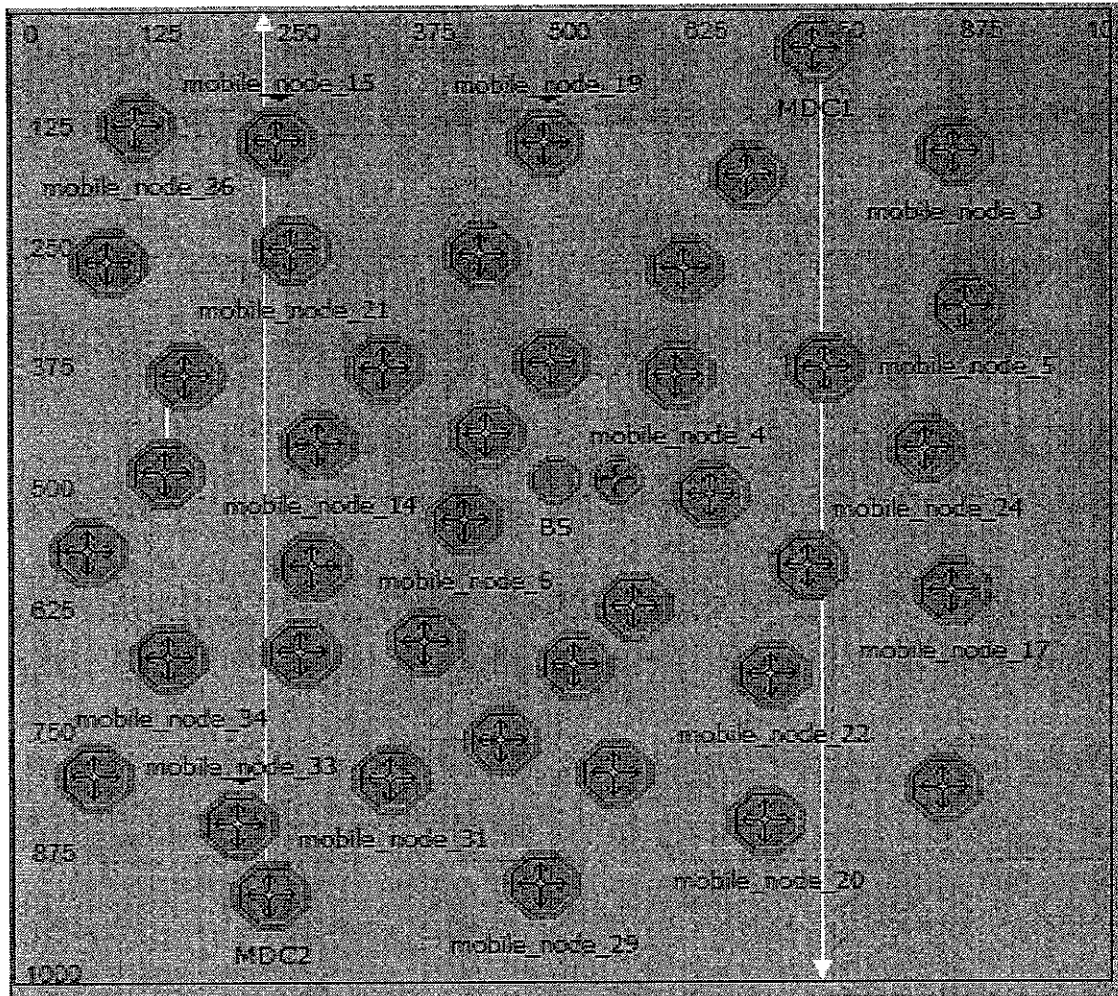

Figure 3.11 The network model

3.8.5 Node model

There are two types of nodes in network model, one is for all general sensor nodes and the other is for the BS which is for base station. The node model of sensors are illustrated in Figure 3.12.

Processor generates packets periodically and implements the network protocol such as LEACH, Hybrid multi-hop LEACH and MDC based LEACH protocol. It is the key process module in the node model and the queue *csma_proc* is the process module implementing CSMA MAC protocol. The radio transmit, receiver and antenna constitute the underlying layer, transmit and receive the data packets through radio links. There are received packet streams along antenna, the receiver to *Processor* and transmitted packet streams along *Processor*, *csma_proc*, the transmitter

to antenna. Two statistic wires from the receiver to *csma_proc* and *Processor* respectively are proposed for collecting statistics. Besides there is a *mobility* process which changes the direction and the node moves randomly with random time interval.

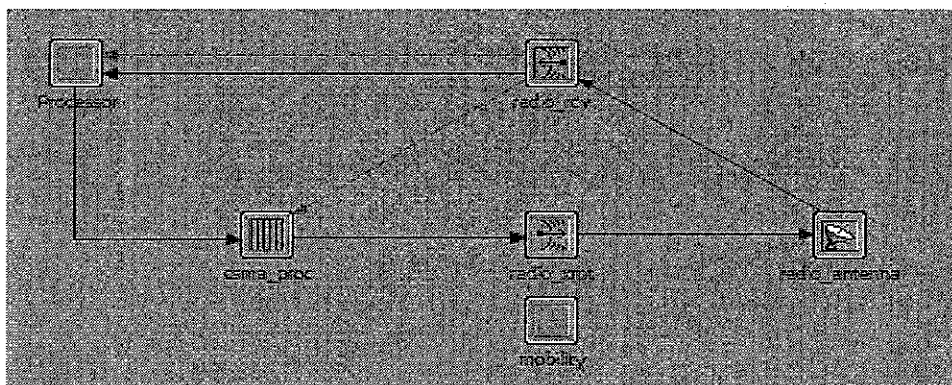

Figure 3.12 Node model of sensors

The model of the BS as illustrated in Figure 3.13; it is very simple and only a base station to receive data without any control function. The model comprises a sink process and a receiver.

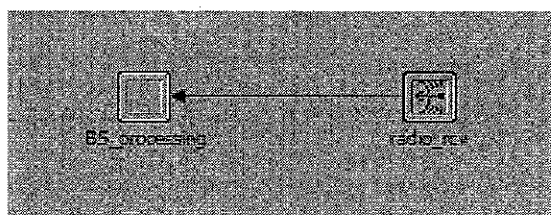

Figure 3.13 Node model of base station

Figure 3.14 illustrates the model attributes of sensor node. As discussed in previous chapter, the node in the MDC based LEACH loads a random time t_1 uniformly distributed between zero and t_1 if it is a cluster head. Alternatively, it loads a random time t_2 uniformly distributed between zero and t_2 if it is a cluster member.

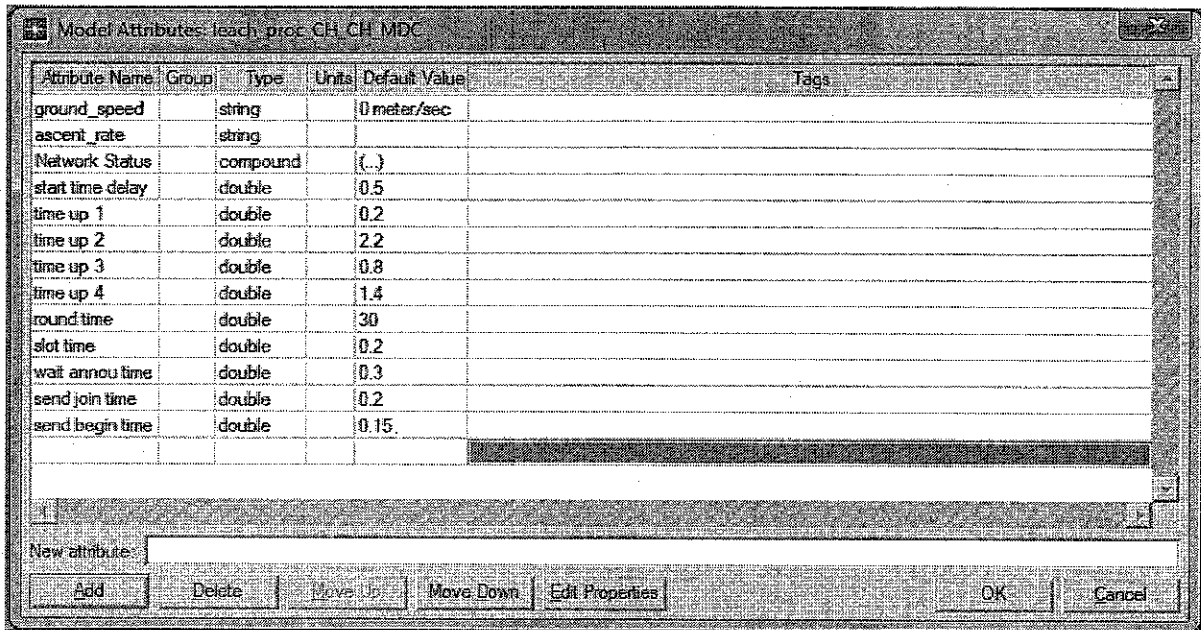

Figure 3.14 Model attributes of sensor nodes

The attributes, “*wait annou time*” and “*send join time*”, are included model attributes, representing t_1 and t_2 respectively. As for other critical attributes, “*round time*” is the duration of a round and “*slot time*” represents the duration a time slot in TDMA schedule. In addition, “*ground-speed*” is the speed of sensor nodes and “*Network status*” is a compound attribute of table. If the node is a cluster head, this table is used to store its member’s information such as ID’s and distances, and coordinates of mobile data collector by beacon messages for multi-hop routing to relay data packets towards the BS. Moreover, if the node is a member node then it stores only the information of its cluster head.

3.8.6 Process model

Specification of behavior of process model is performed using the Process Editor; meanwhile process models that are presented by actual examples are as the processes in the Node Domain and are within processor, queue and esys modules. Processes themselves can be autonomously executing threads of control by doing general communications and data processing functions.

3.8.6.1 Trajectory generating process

As described above, mobility process generates trajectory of node's movement during simulation as illustrated in Figure 3.15. The programmed behaviors are executed when the process enters, exits a state and transfer from one state to another.

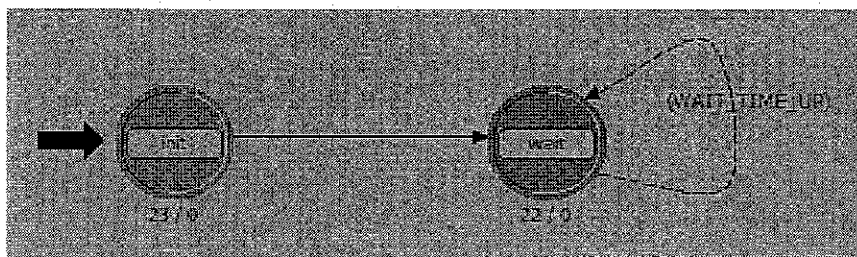

Figure 3.15 Process model of mobility

There are two types of states: forced state and unforced state. A forced state is a temporary state, the process transfers to another state automatically after it enter executives and exit executives are completed. An unforced state is a steady state, the process pauses at an unforced state after enter executives are completed. Its exit executives and next state transition are carried on when triggered by a system-scheduled interrupt.

This process model begins with an initial forced state “*init*”, it is enter executives which execute to complete some initiations including setting initial direction, getting user specified speed, loading PDF's to generate streams of stochastic values. Then the process transits to an unforced state “*wait*”, whose enter executives are completed to change direction with stochastic angle random, generate numeric outcomes for stochastic interval time and change angle, and schedule next interrupt for changing direction. When next interrupt time is up, the process execute self-state transition to “*wait*” and enter executives are implemented again.

3.8.6.2 Base station process

Base Station process model as illustrated in Figure 3.16, BS node model is the sink process where data packets are received from mobile data collector, this process model processing the data packet of the terminal and collects necessary statistics.

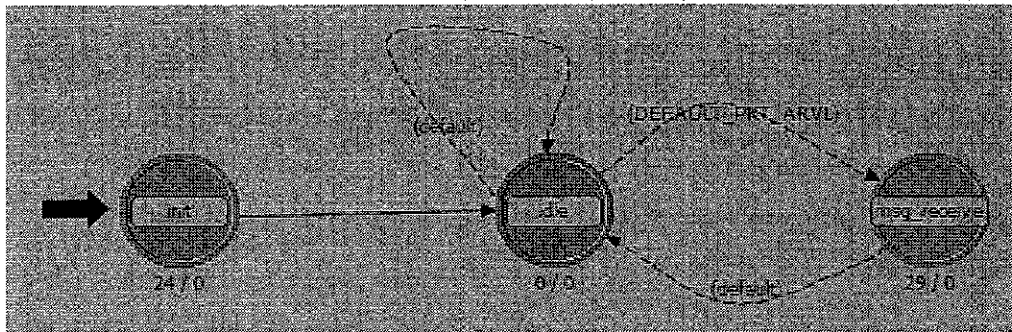

Figure 3.16 Process model of base station

3.8.6.3 Mobile Data Collector process

Figures 3.17 illustrates the process model of Mobile Data Collector that receives the aggregated data from all cluster heads and provide the location and residual energy of mobile data collector by the help of beacon messages to all cluster heads.

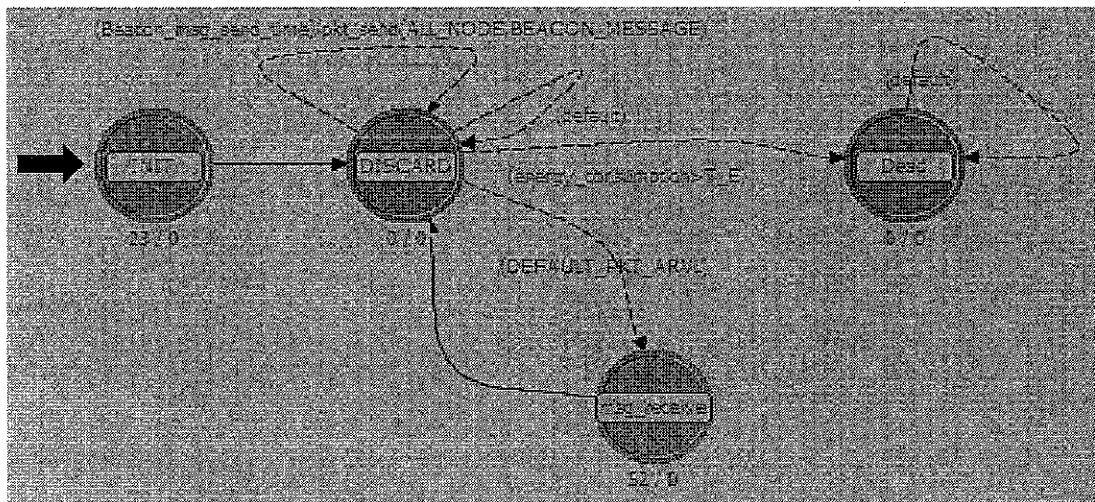

Figure 3.17 Process model of Mobile Data Collector

3.8.6.4 Routing process

Modeling of the MDC based LEACH focus in Processor node; Figure 3.18 shows the process model of Processor.

The process begins with “*init*” as well and then transits to unforced state “*start*” after completing initiations. When the START interrupt scheduled at “*init*” comes after start time delays specified by user, the process transits to an unforced state “*idle*” and send all other nodes a HELLO message to join the network. At “*idle*” state, the

node could receive HELLO messages from other nodes and get total number of nodes joining the network via an unforced state "*got a msg 1*". This mechanism leads to highly dynamic formation and organization of the network. After some time, the process transits to forced state "*tem*" at which the numeric outcome is generated to decide whether the node will become cluster head according to the probability algorithm described in previous chapter. If the node becomes a cluster member, the process enters the state "*wait to join*", the node receives ANNOU messages from cluster heads and chooses cluster head at this state during some time via a "*got a msg 3*". Then the process enters "*got annou*" and schedules an interrupt to send JOIN to its cluster head. At this stage it sends JOIN iteratively till it receives ACK from its cluster head, once it receives ACK then it will enter "*member*" through "*got a msg 4*", which is the state for cluster member to begin steady-state phase. The cluster member receives BEGINSTEADY from its head via "*got a msg 5*" and sends data packets to its cluster head periodically at this state. If the node becomes a cluster head, the process enters the state "*head*". At this state the process completes all operations of cluster head during both cluster formation period and steady-state phase described in previous chapter, it processes the receiving packets via "*got a msg 2*". At the steady-state phase, it does not only receive data packets from its cluster members but also relayed data packets to the BS by mobile data collector, which acts as intermediate relay node. However in both states "*member*" or "*head*", the process is at the end of each round it transits back to "*idle*" and sends HELLO again to begin a new round.

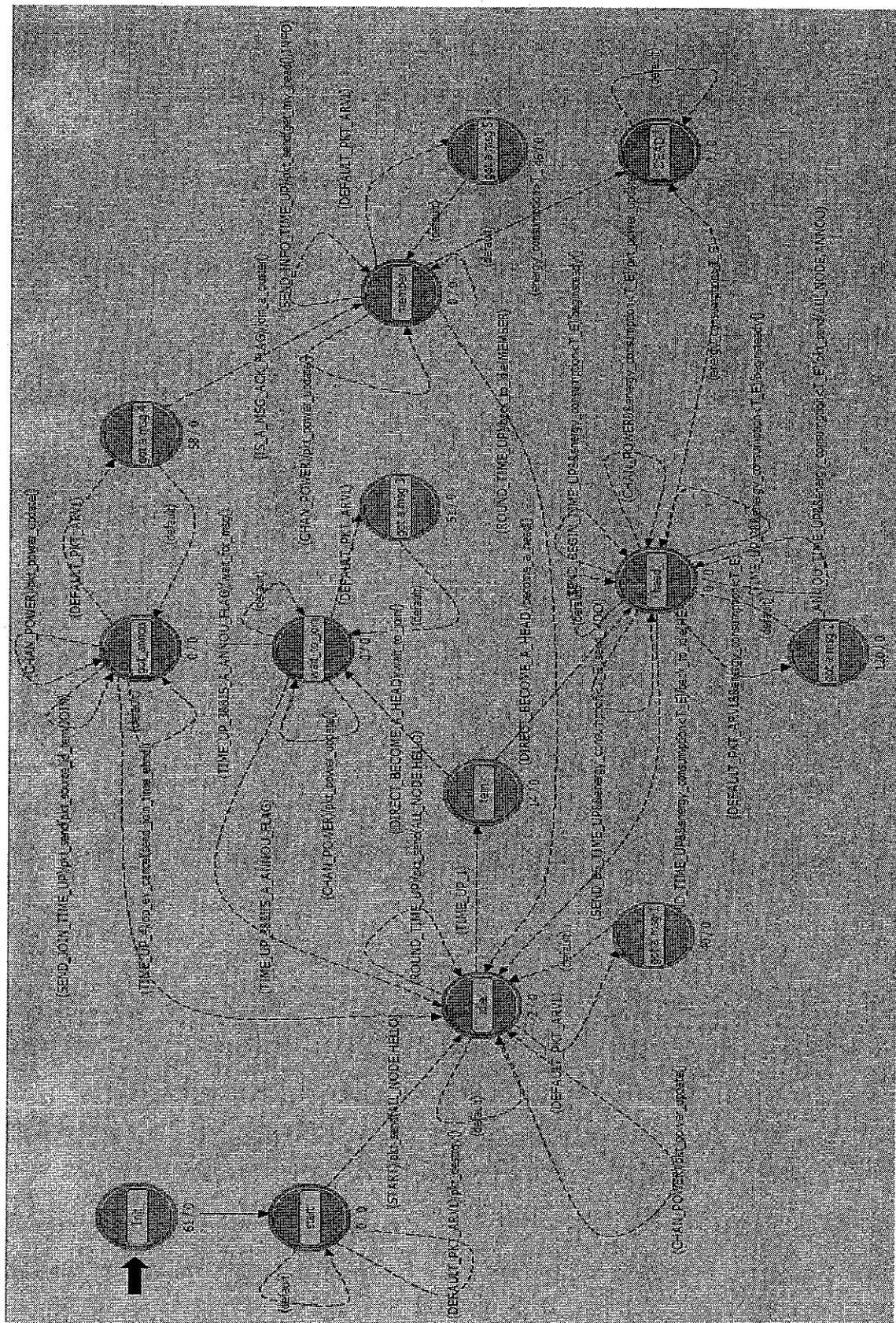

Figure 3.18 Process model of Mobile Data Collector based LEACH routing protocol

3.8.6.5 Medium Access Control (MAC) process

The process model as illustrated in Figure 3.19 is developed for the queue, *csma_proc*, when a packet is ready to be sent, it is passed from *Processor* to *csma_proc*. This module listens to whether the channel is free through the receiver, only if the channel is free then the packet will be sent to the transmitter otherwise it will be deferred.

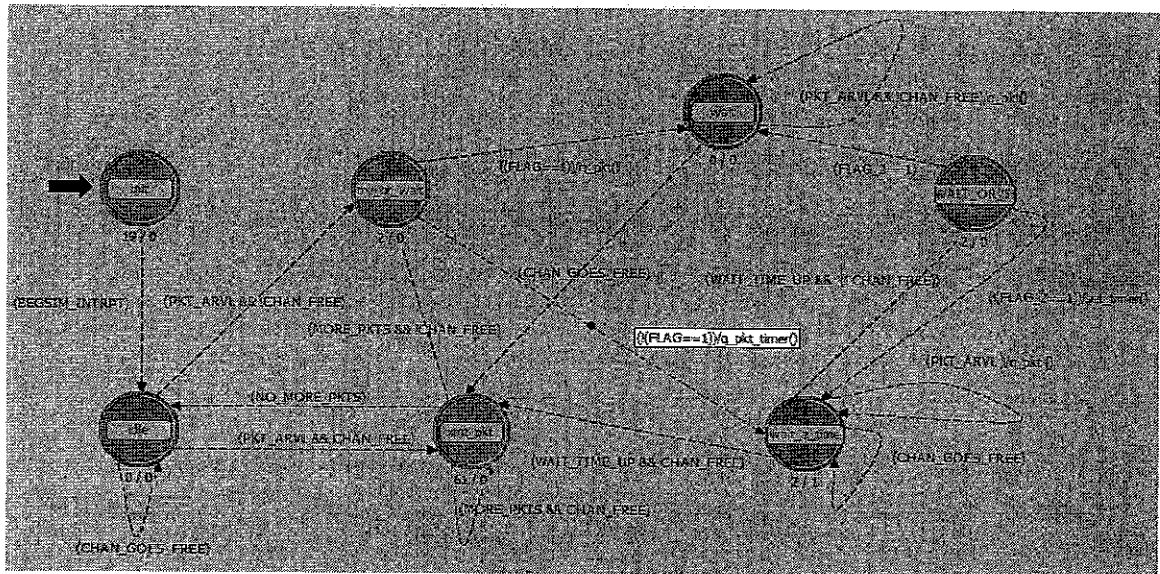

Figure 3.19 Process model of Carrier Sense Multiple Access (CSMA) protocol

3.8.7 Packet format

OPNET allow users to define their own packet format by packet format editor. In this research work, two types of packets are defined: short message and information message. As described in previous chapter, short message is used to exchange information during formation of clusters that includes six fields. Table 3.1 illustrates the meaning of fields in short message.

Table 3.1 Definition of short message

FIELDS	MEANING
dest-address	destination node ID
source-address	source node ID
Msg-type	Packet type
Status	Number of cluster member
x-pos	Source node's x position
y-pos	Source node's y position

Information packet is used to carry useful data sensed by sensor nodes that consists of header and information field. The header contains three fields of *dest-address*, *source-address* and *msg-type* that have the same functions as short message. The information field carries the data that the end user needs. The total length of information packet is 36 Bytes or 288 bits that is the default packet size of TinyOS. Table 3.2 illustrates the meaning of fields in information message.

Table 3.2 Definition of information message

FIELDS	MEANING
dest-address	destination node ID
source-address	source node ID
Msg-type	Packet type
Information	Data

3.9 Chapter Summary

Routing protocol design and operation is based on considerations dictated by literature and published works. The design considerations for the development of the proposed Mobile Data Collector based routing protocol (MDC based LEACH) are energy efficiency, scalability, reliability of message delivery and support for node mobility.

The functional model of MDC based LEACH provides an explicit statement of the simulation model used to produce the results. The model is abstracted up to a level with sufficient information to ensure that the results can be independently verified. The operation of MDC based LEACH routing protocol is initialized by a restricted broadcast from the base station to configure the routing information on each node. Each node will select a cluster head and mobile data collector as the next hop towards the base station and will use that node to propagate data messages towards the base station. Data aggregation at the cluster heads minimizes the amount of message transmissions. Self-configuration and tolerance to topological changes are manifested in the form of power, static route and dynamic route maintenance.

Simulation of Mobile Wireless Sensor Networks (mobile WSNs) routing protocols is very important to further the current body of knowledge. This chapter also introduced the simulation environment used for this research as first choice due to the vast amount of available documentation and support for OPNET. The Mobile Data Collector based routing protocol framework provides easy mechanism for users to design the protocol at network layer of the mobile WSNs communication stack with the support of node mobility and dynamic connection management.

A survey of literature has shown that all sources used in this dissertation assume certain properties and artifacts of the network and node design. The major problems identified are the amount, type and relevance of assumptions made to specify the routing protocol and for presenting results. These assumptions are needed to be considered, critically evaluated and the impact of each thoroughly understood when researching routing protocol specifications. The assumptions made during the design of the proposed protocol are described in detail as required to inform the reader of the possible weaknesses and future extensions of this research.

Finally, this chapter has presented the details of simulation assumptions and models for this research project. OPNET is a popular simulation tool for communication networks and distributed systems, which allow users to construct their own models hierarchically. This research work builds a network model to implement LEACH, Hybrid multi-hop LEACH and Mobile Data Collector based LEACH protocol in OPNET modeler.

CHAPTER 4

RESULTS AND DISCUSSIONS

4.1 Introduction

The design for Mobile Data Collector based routing protocol (MDC based LEACH) is implemented and simulated in OPNET. The performance of MDC based LEACH protocol as a routing protocol is compared with LEACH and Hybrid multi-hop LEACH, the implementation of each of these protocols only differs at the routing layer without any differences in inter layer communication paradigms. LEACH is one of the seminal contributions of hierarchical network architectures and referenced multiple times in literature. Hybrid multi-hop LEACH is another hierarchical cluster based routing protocol that utilizes multi-hop routing strategy from cluster head to the base station, as an alternative of direct transmission in order to reduce communication energy.

The artifacts and assumptions that do not differentiate the operation of any of the simulated routing protocols are used as base for the OPNET implementation of all the evaluated protocols. These artifacts and assumptions are described in more detail in previous chapters and should ensure that the simulated protocol performance results are evaluated equally under the same simulation conditions. A critical evaluation of selected metrics produced by the results of protocol performance simulations provide an indication of the industrial applicability of the designed protocol.

4.2 Simulation Parameters

The simulation parameters of LEACH, Hybrid multi-hop LEACH and Mobile Data Collector based routing protocol are based on outdoor environmental applications of

WSNs. The main simulation parameters are summarized in Table 4.1.

Table 4.1 Simulation setup

PARAMETRES	VALUES
Number of Nodes	Forty (40)
Simulation Area	1000 * 1000 (m)
Sensor Node Deployment	Random Deployment
Number of Cluster Head	Five (5)
Transmitter Electroics ($E_{TX-elec}$) Receiver Electronics ($E_{RX-elec}$)	50 nj/bit
Transmit Amplifier (E_{amp})	100 pj/bit/m ²
Sensing power dissipation	0.021W
Idle power dissipation	0.000054W
Sleeping power dissipation	0.0000027W
Reception threshold (Rx_{thresh})	-90 dBm
Battery	Initial capacity is assumed to be constant
Data Rate	250 kbps
Packet size	288 bits/packet or 36 Bytes
Traffic Model	CBR traffic for periodic data generation
Node Ground Speed	0.5 m/sec
MDC Beacon Message Rate	5 sec/message
Number of MDC's	2
MDC Velocity	0.054 m/sec
Round time	30 sec

As discussed in previous chapter, Forty (40) sensor nodes are randomly deployed in the area of 1000 * 1000 m and multiple mobile data collectors are travelled in predefined trajectory, five clusters formed in the whole network and one sensor node of the every cluster acts as cluster head. These sensor nodes are moving in the network and each sensor communicates with its cluster head directly, cluster heads forward the data to the base station, which is located in the middle of the network area by the help of mobile data collector. Free space propagation and log-normal shadowing model with an isotropic antenna have been deployed, the packet size is 288 bits or 36 Bytes which is the default size of TinyOS.

4.3 Simulation Metrics

When evaluating the performance of routing protocols, the research concentrates on following performance metrics. These metrics are used to measure and critically analyze the simulated performance of Mobile Data Collector based LEACH protocol against other leading routing protocols.

4.3.1 Energy consumption of sensor nodes and network lifetime

Energy consumption is most prominent metrics in mobile and static WSNs, since sensor nodes have limited battery power source. Energy consumption of a sensor node is equal to the sum of energy dissipation in transmitting, receiving, overhearing, sensing, idle and sleeping states. Energy depletion during communication in both transmitting and receiving is addressed to be the emphasis of this research dissertation. Moreover, the energy dissipation of sensor nodes has direct impact in the performance of the network or network lifetime, more energy dissipation less network lifetime and a smaller amount energy dissipation longer network lifetime.

4.3.2 Traffic received, packet loss ratio and packet inter-arrival time

The traffic received can be defined as the number of packets received at the base

station to the number of packets sent by all the source nodes. Traffic received is an important metric as it describes the message throughput of the routing protocol as well as the protocol's ability to handle topological changes and failures in the networks.

Traffic received depends mainly on path availability in terms of connectivity among nodes, connectivity among nodes may be influenced by sporadic connectivity to mobile data collector, node failures, transmission collisions, channel congestion, corrupted packet etc. that creates packet drop within the network.

Packet loss occurs when one or more packets of data travelling across a network fail to reach their destination. This metric is distinguished as one of the three main error types encountered in digital communications; the other two being bit error and spurious packets caused due to noise. Although energy efficiency should be the main design consideration for mobile WSNs routing protocols, the successful delivery of messages from source nodes to the base station is a very important performance metric. If messages are not successfully delivered at the base station, the network is wasting energy on unnecessary message transmissions and thus consuming more energy.

The packet loss ratio can be defined as the ratio of the number of packets received at the base station to the number of packets sent by all the source nodes. This ratio ranges between 0% to 100% where 100% indicates that all the data messages originating from the source nodes has successfully been delivered at the sink node. Packet loss ratio is an important metric as it describes the message throughput of the routing protocol as well as the protocol's ability to handle topological changes and failures in the networks.

Packet inter-arrival time estimation and measurements are integral parts of much traffic management, monitoring, and control tasks in packet-switched networks. The estimation of the inter-arrival time can be performed off-line or on-line due to the objective. The inter-arrival time estimation is important and has been applied in many communication networks, estimated values of packet inter-arrival time are used to measure the traffic rate for the QoS enabled networks. The packet inter-arrival time is defined as the difference of the arrival times of the i^{th} packet and the $(i-1)^{\text{th}}$ packet.

4.3.3 Channel access and End-to-End delay

Average delay of the packet is defined as the time interval between packet generation time in sensor nodes and received packet by the base station. As such, the packet experiences two sources of delay: first, queuing delay depends on the traffic load and the size of the queue that is time difference between packet entry to the queue and its leave. Second, End-to-End transmission delay that is the difference in the time from the moment of packet is transmitted until it reaches by the receiver. Normally this delay is determined by channel bandwidth, packet length and the coding scheme adopted.

4.3.4 Time until first and last node dies

Message transmissions among nodes within the network are the highest energy consumer in WSNs, the power source of a node is depleted with each transmission and reception of a message. The first complete depletion of a specific node's energy will determine the point in time at which the full functionality of the network will start to decrease; this time will initiate the start of topological changes in the network. Although this metric does not indicate the routing protocol's ability to handle topological changes due to failures or node mobility, it provides an indication of the energy consumption under no fault conditions and at maximum capacity.

Routing protocol functionality depends on the ability to successfully delivered messages originating from source nodes to the base station. The cluster heads within the maximum transmission distance from the base station will relay messages towards the base station by MDC. The routing protocol's message delivery ability is directly affected by the availability of the cluster member nodes and the failure of these nodes over time. As soon as all the power sources of the cluster member nodes are depleted, there is no way that a message can be sensed and delivered towards the base station. This metric benchmarks the point in time that a message will no longer be able to reach the base station and the functionality of the network will cease.

4.3.5 Node density vs. total energy consumption and total traffic received

Density is a physical property of matter, as each element and compound has a unique density associated with it and defined in a qualitative manner as the measure of the relative “heaviness” of objects with a constant volume. Therefore, it is important to study the relationship between node density vs. total energy dissipation and total traffic received, so that we can control the network resources in a desirable way. Total energy consumption depends on the particular power settings used for transmission, reception and idle listening, a metric of the traffic density and energy consumption is used to monitor the status of each sensor node in the network. Total traffic received means the successful packet delivery at the base station from sensor node by the help of MDC.

4.3.6 Energy dissipation of MDC and number of live MDC's

Mobile data collector acting as a backbone within the network to relay the data towards the base station in three-tier mobile WSNs architecture, in this context the energy dissipation of MDC's must be balanced throughout the network in order to achieve efficient and reliable network.

4.4 Simulation Results of MDC minimum distance LEACH

The network parameters of simulation are explained in table 4.1, following performance metrics are measured on average confidence interval after several simulations run.

- Energy consumption of sensor node and number of live nodes
- Traffic received, packet loss ratio and packet inter-arrival time
- Channel access and End-to-End delay

4.4.1 Energy consumption of sensor nodes, energy per packet and number of live nodes

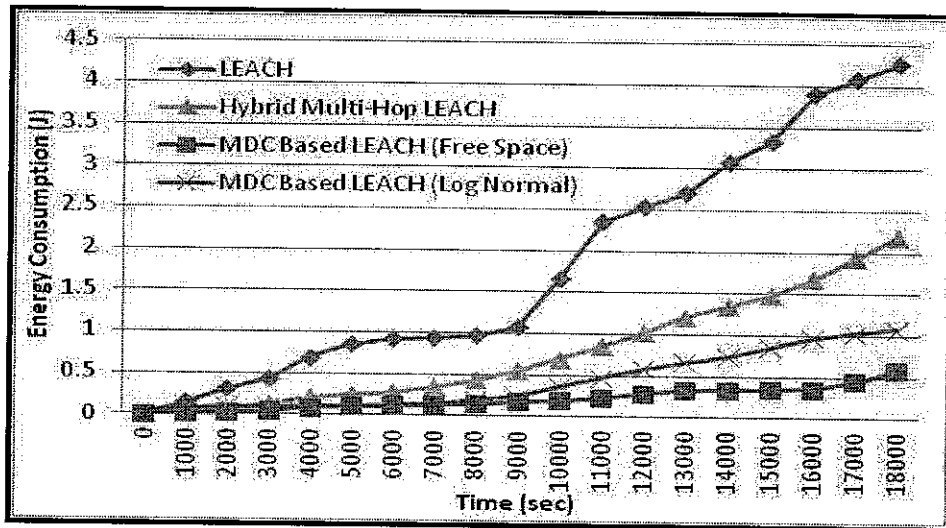

(a)

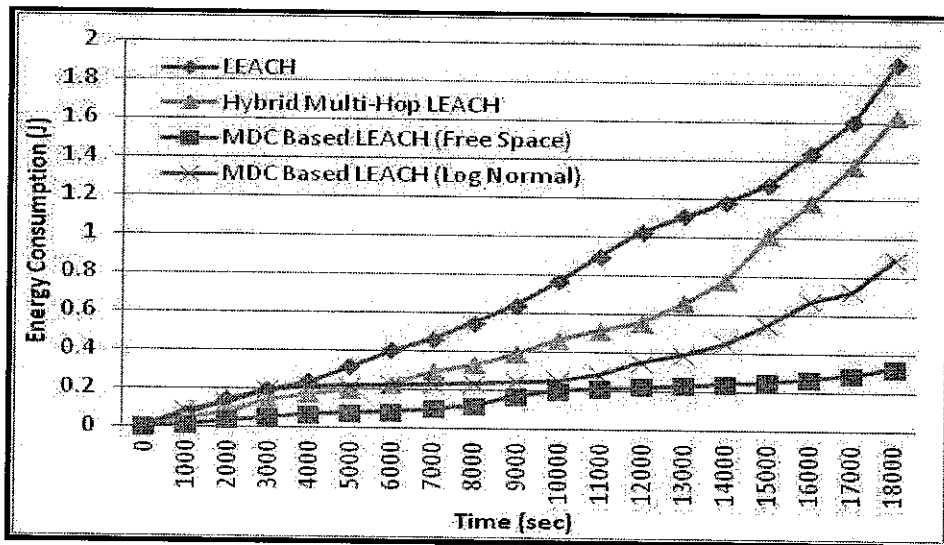

(b)

Figure 4.1 (a) and (b) Energy Consumption of Node 17 and 36

Figure 4.1 (a) and (b) illustrated the energy consumption of individual sensor node after multiple simulations run over LEACH, Hybrid multi-hop LEACH and MDC minimum distance LEACH routing protocol in both propagation models (Free Space and Log Normal Shadowing). Sensor nodes are randomly deployed in the network of all above-mentioned protocols, MDC minimum distance LEACH utilizes mobile data collector for communication from cluster heads to the base station. The energy

consumption of individual nodes in MDC minimum distance LEACH is less than LEACH and Hybrid multi-hop LEACH routing protocol after 5 hours several simulations run, because the distance is minimized from source to destination by cluster head and MDC that utilizes multi-hop routing strategy.

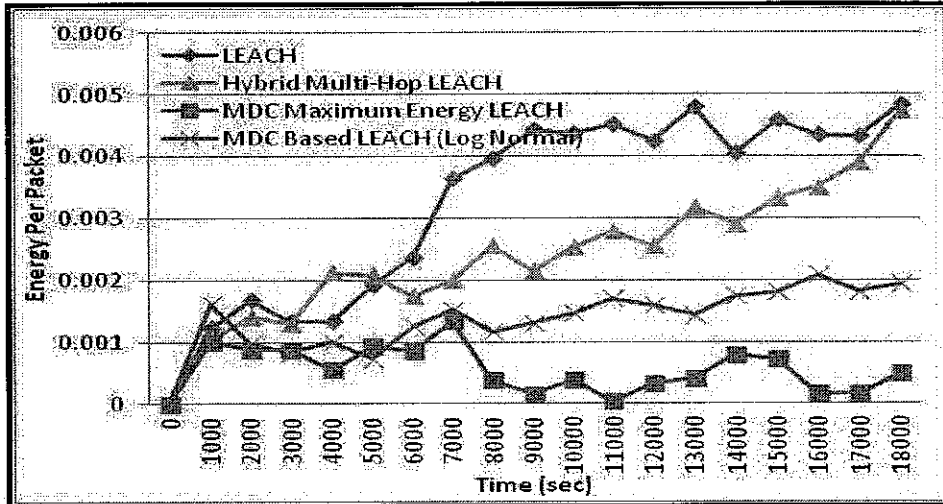

(a)

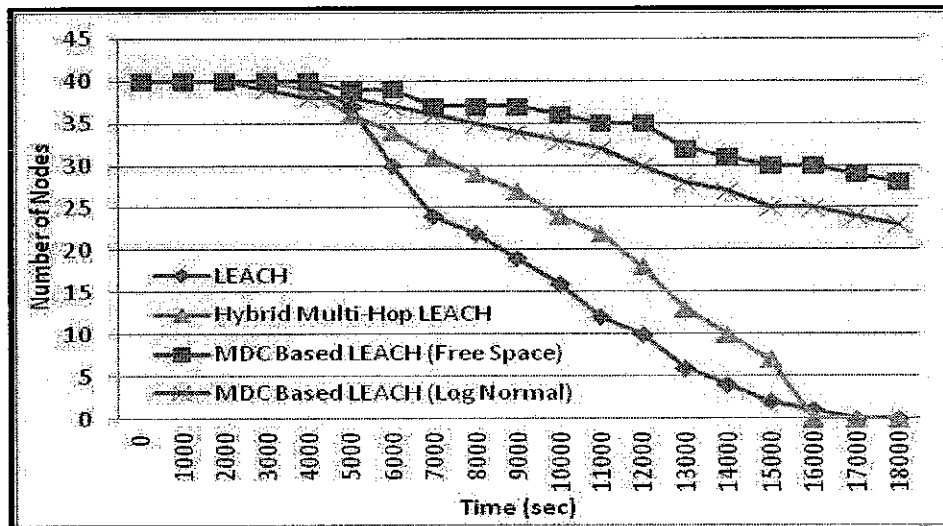

(b)

Figure 4.2 (a) Energy Per Packet (b) Number of Live Nodes

The graphs of energy dissipation of energy per packet is illustrated in Figure 4.2 (a) show a significant difference, which has direct impact on the performance of the overall network or number of live nodes. The simulated result of Figure 4.2 (b) exposed the considerable variation in number of live nodes. Therefore, MDC minimum distance LEACH routing protocol is better than LEACH and Hybrid multi-

hop LEACH routing protocol in terms of network lifetime because it stays active 73% as completely longer and falling slightly faster.

4.4.2 Traffic received, packet loss ratio and packet inter-arrival time

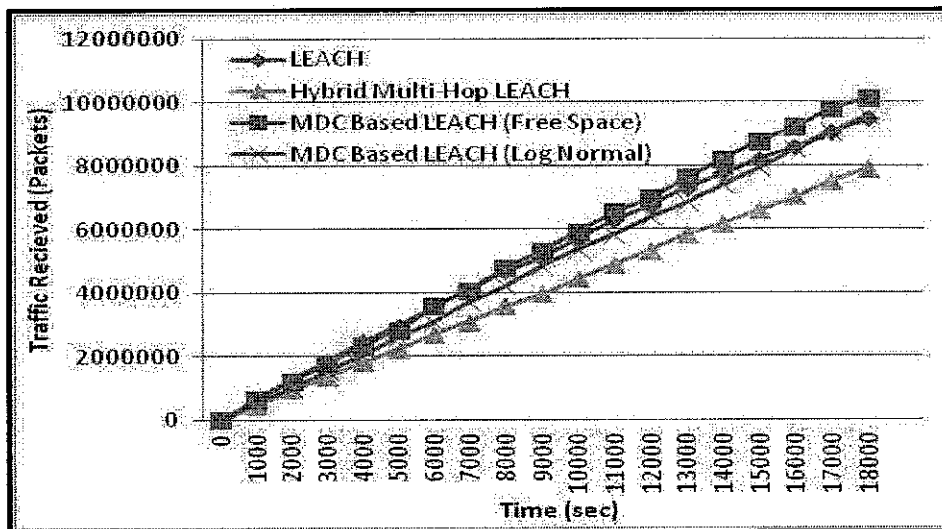

(a)

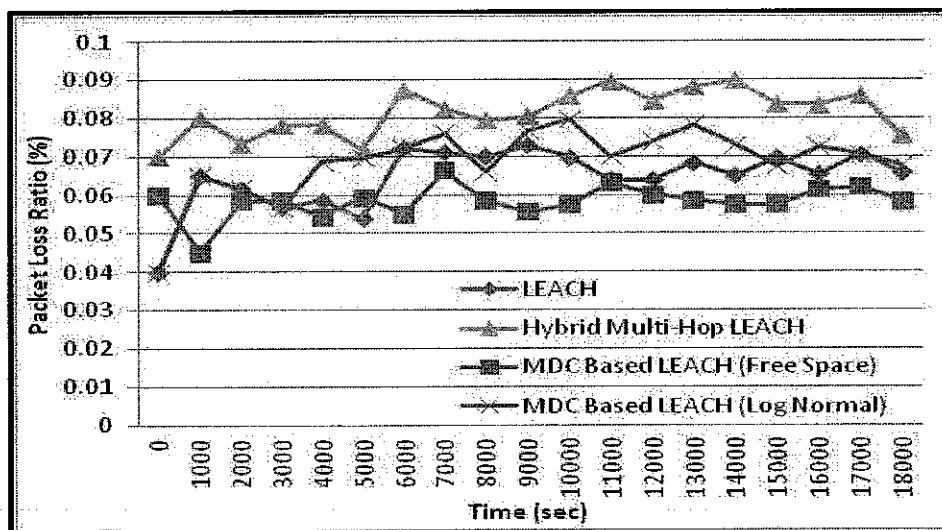

(b)

Figure 4.3 (a) Traffic Received (b) Packet Loss Ratio

Traffic or number of packets received at the base station in MDC minimum distance LEACH routing protocol is higher 5-20% than LEACH and Hybrid multi-hop LEACH routing protocol because the sensor nodes in MDC minimum distance

LEACH stays alive longer and generate more packets. MDC minimum distance LEACH has a smaller amount of packet loss ratio than LEACH and Hybrid multi-hop LEACH because to stay away from bad radio communication, congestion, packet collision, full memory capacity and node failures within the network. Figure 4.3 (a) and (b) demonstrates the traffic received or number of packets received at base station and packet loss ratio over time in LEACH, Hybrid multi-hop LEACH and MDC minimum distance LEACH routing protocols.

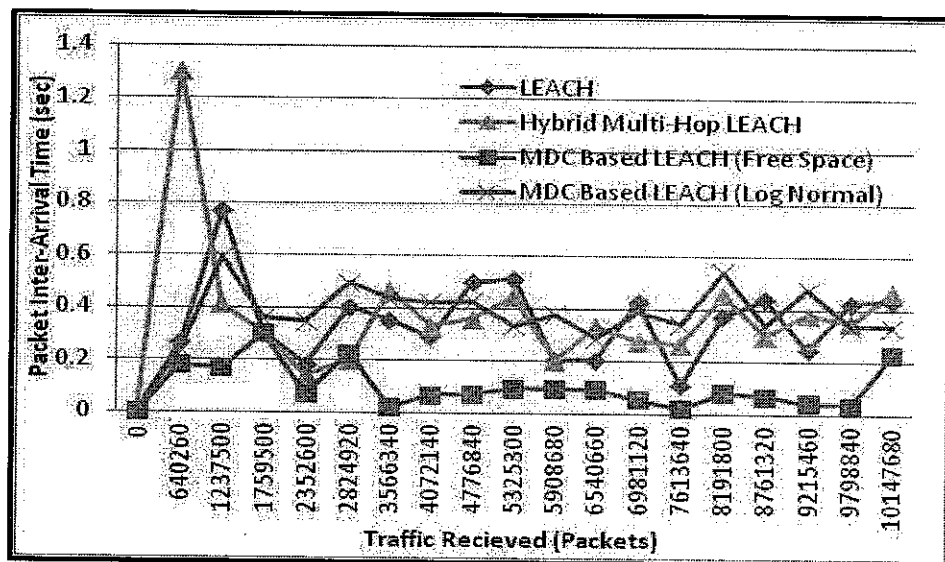

(c)

Figure 4.4 Packet Inter-Arrival Time

Moreover, the packet inter-arrival time is less in MDC minimum distance LEACH than LEACH and Hybrid multi-hop LEACH routing protocol as illustrated in Figure 4.4. The results proved that MDC minimum distance LEACH eliminates unsolicited traffic or identifying the abnormal or unexpected network activity and congestion level at the node or at the link. Estimation of the End-to-End performance and its improvement is important for transactions from sensor node to base station.

4.4.3 Channel access and End-to-End delay

Channel busyness or latency time of data packet, when it is entered in the network layer and getting out is measured by channel access delay, as illustrated in Figure 4.5

(a) the average channel access delay of LEACH, Hybrid multi-hop LEACH and MDC minimum distance LEACH routing protocol during the simulation.

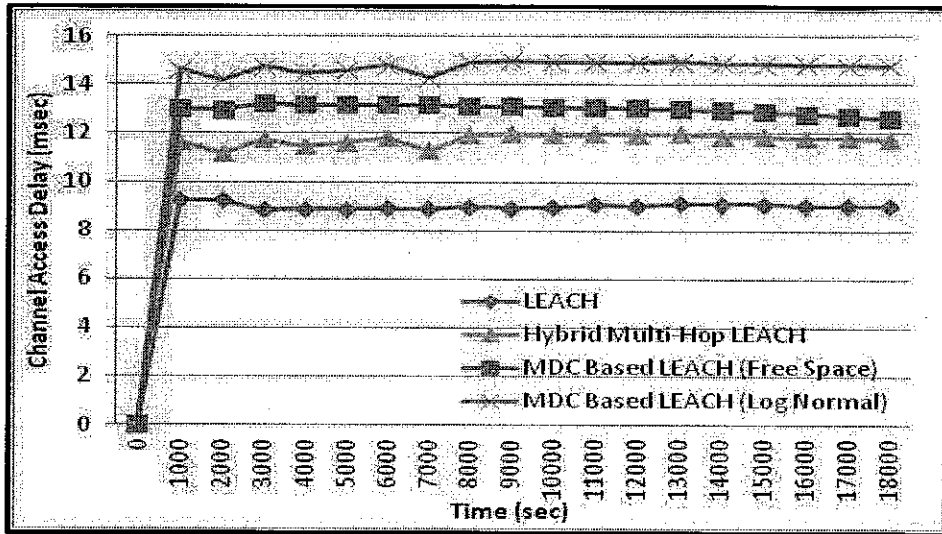

(a)

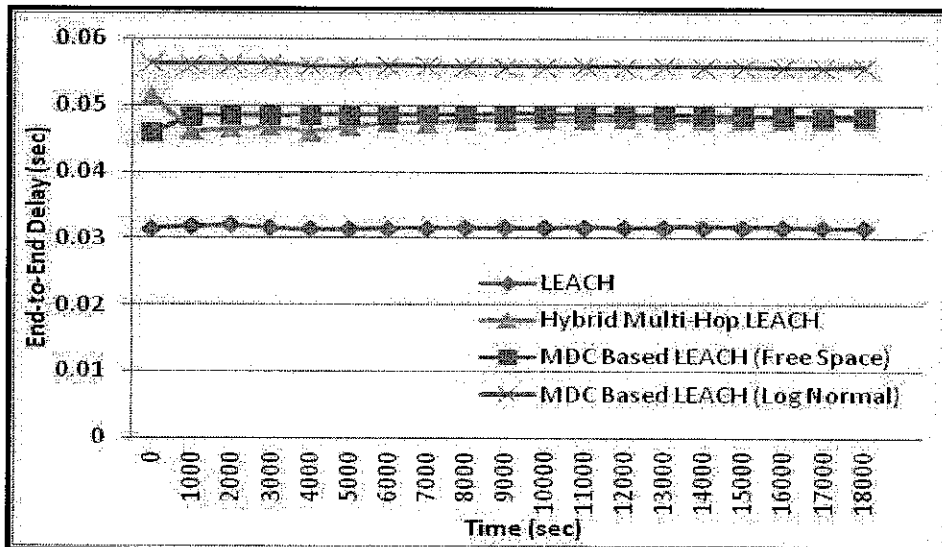

(b)

Figure 4.5 (a) Channel Access Delay (b) End-to-End Delay

The result shows that the channel access delay of MDC minimum distance LEACH is slightly higher than LEACH and Hybrid multi-hop LEACH routing protocol due to increased traffic load between sensor nodes to base station by applying mobile data collector that is based on multi-hop routing strategy. The main metric of network latency is End-to-End delay; it is defined as the time latency of data packet, channel access delay and other potential delays from source to destination.

Figure 4.5 (b) illustrates the graph of average End-to-End delay over time using LEACH, Hybrid multi-hop LEACH and MDC minimum distance LEACH routing protocol. The End-to-End delay of MDC minimum distance LEACH routing protocol is slightly higher than LEACH but same like as Hybrid multi-hop LEACH routing protocol due to aggregated data packets in MDC minimum distance LEACH and Hybrid multi-hop LEACH protocol takes multi-hops and consume more processing time to reach the base station.

4.5 Simulation Results of MDC maximum residual energy LEACH

According to simulation parameters of table 4.1, following performance metrics are measured on average confidence interval after several simulations run.

- Energy consumption of sensor node and number of live nodes
- Traffic received, packet loss ratio and packet inter-arrival time
- Channel access and End-to-End delay

4.5.1 Energy consumption of sensor nodes, energy per packet and number of live nodes

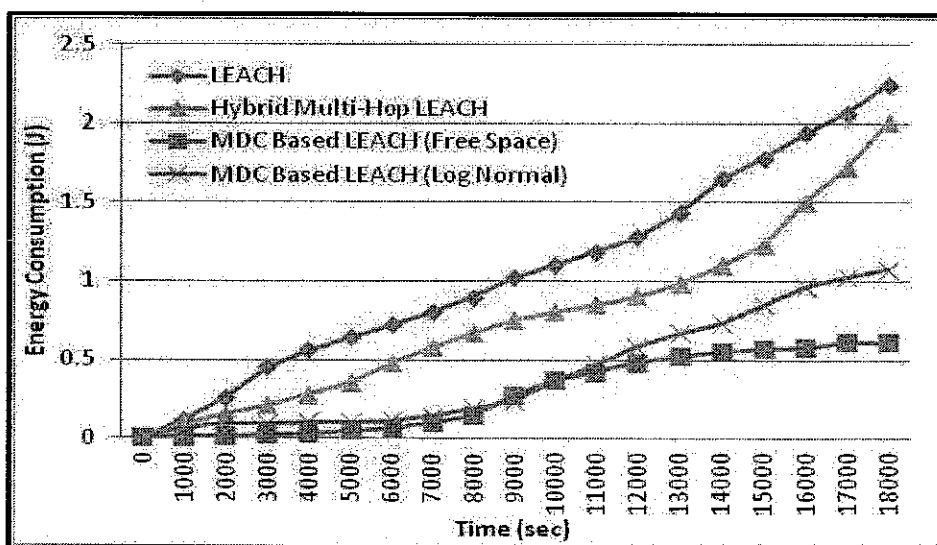

(a)

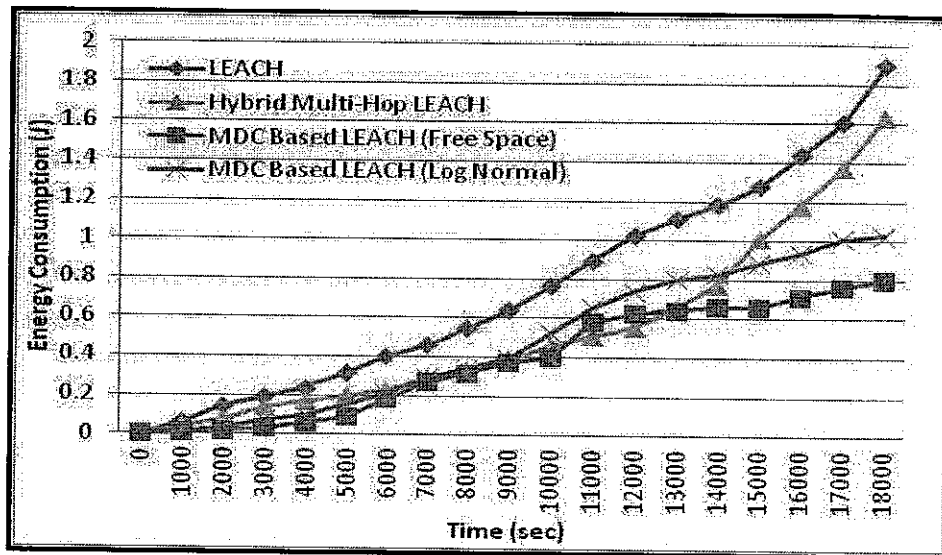

(b)

Figure 4.6 (a) and (b) Energy Consumption of Node 11 and 33

Figure 4.6 (a) and (b) illustrated the energy consumption of individual sensor node after multiple simulations run over LEACH, Hybrid multi-hop LEACH and MDC minimum distance LEACH routing protocol in both propagation model (Free Space and Log Normal Shadowing). Sensor nodes are randomly deployed in the network of all above-mentioned protocols, MDC minimum distance LEACH utilizes mobile data collector for communication from cluster heads to the base station. The energy consumption of individual nodes in MDC minimum distance LEACH is less than LEACH and Hybrid multi-hop LEACH routing protocol after 5 hours several simulations run because the distance is minimized from source to destination by cluster head and MDC utilizes multi-hop routing strategy.

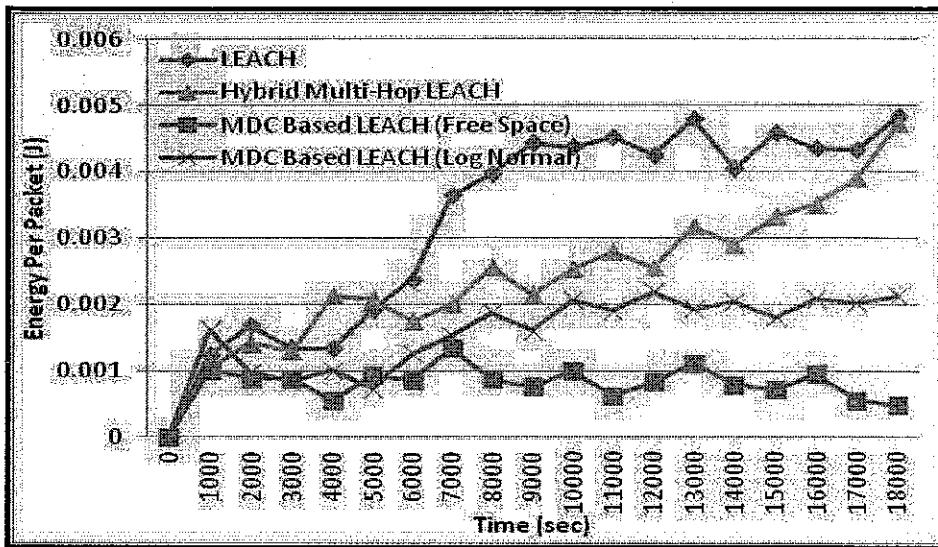

(a)

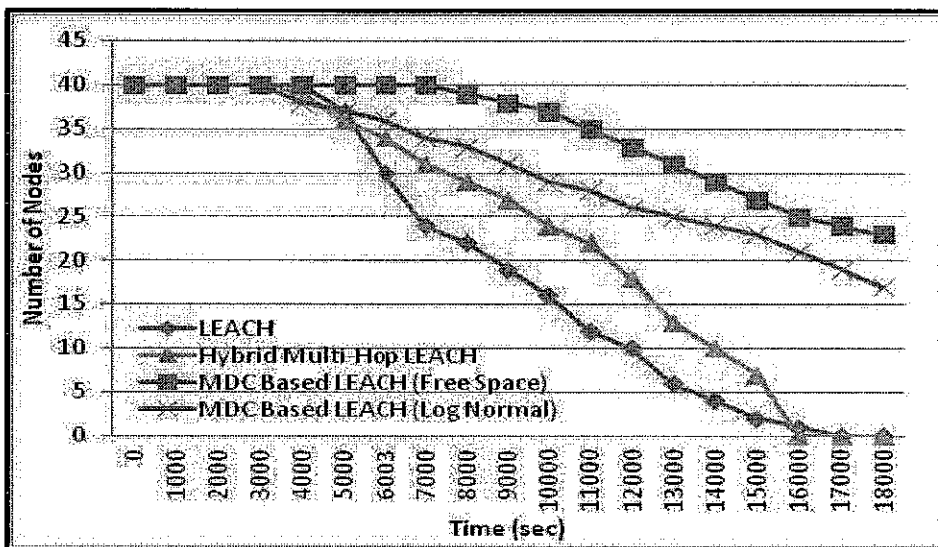

(b)

Figure 4.7 (a) Energy Per Packet (b) Number of Live Nodes

The graphs of energy dissipation of energy per packet is illustrated in Figure 4.7 (a) show a significant difference, which has direct impact on the performance of the overall network or number of live nodes. The simulated result of Figure 4.7 (b) are exposed the considerable variation in number of live nodes. Therefore, MDC minimum distance LEACH routing protocol is better than LEACH and Hybrid multi-hop LEACH routing protocol in terms of network lifetime because it stays active 55% as completely longer and falling slightly faster.

4.5.2 Traffic received, packet loss ratio and packet inter-arrival time

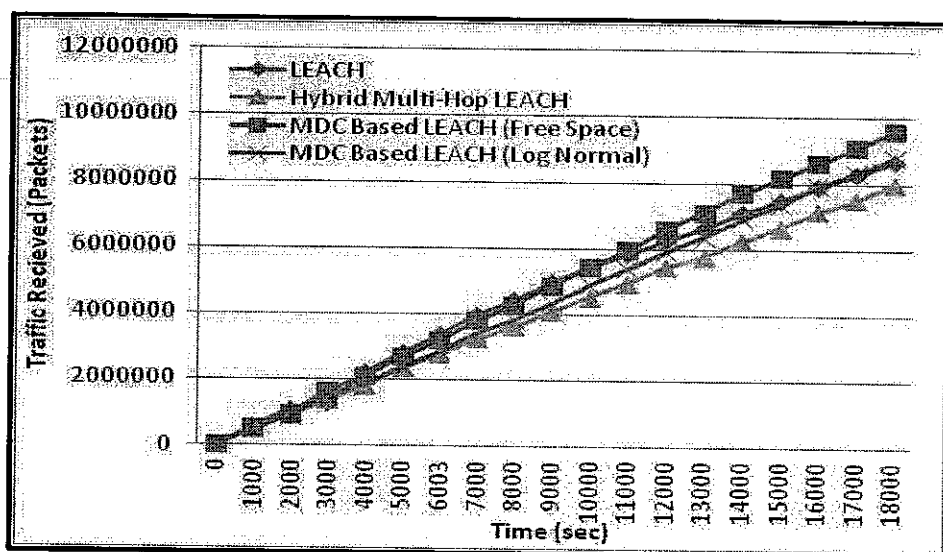

(a)

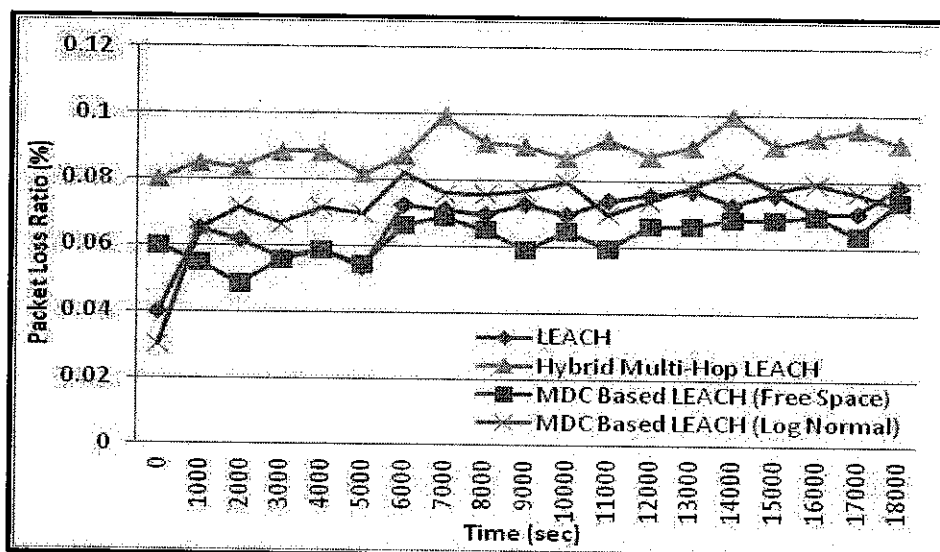

(b)

Figure 4.8 (a) Traffic Received (b) Packet Loss Ratio

Traffic or number of packets received at the base station in MDC minimum distance LEACH routing protocol is higher 5 to 15% than LEACH and Hybrid multi-hop LEACH routing protocol because the sensor nodes in MDC minimum distance LEACH stays alive longer and generate more packets. MDC minimum distance LEACH has a smaller amount of packet loss ratio than LEACH and Hybrid multi-hop LEACH in order to stay away from bad radio communication, congestion, packet collision, full memory capacity and node failures within the network. Figure 4.8 (a)

and (b) demonstrates the traffic received or number of packets received at base station and packet loss ratio over time in LEACH, Hybrid multi-hop LEACH and MDC minimum distance LEACH routing protocols.

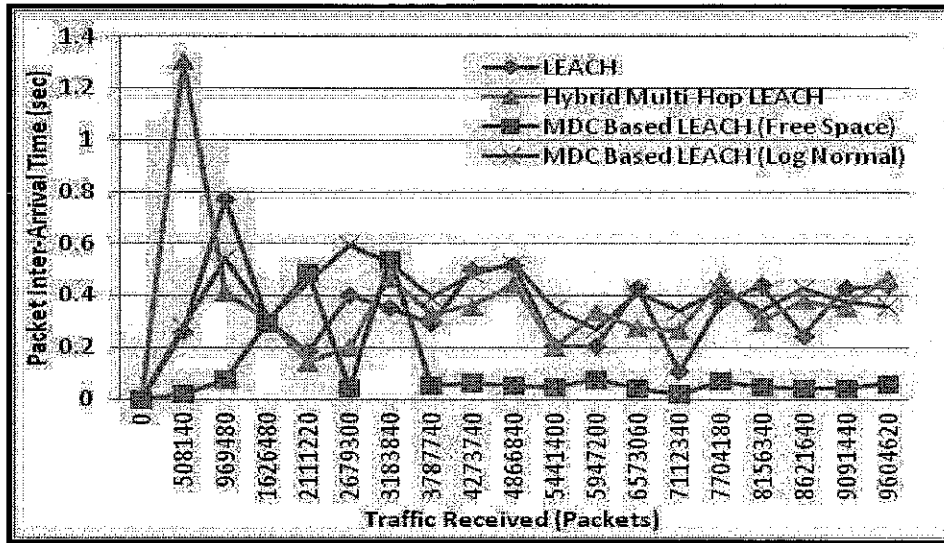

(c)

Figure 4.9 Packet Inter-Arrival Time

Moreover, the packet inter-arrival time is less in MDC minimum distance LEACH than LEACH and Hybrid multi-hop LEACH routing protocol as illustrated in Figure 4.9. The results proved that MDC minimum distance LEACH eliminates unsolicited traffic or identifying the abnormal or unexpected network activity and congestion level at the node or at the link. Estimation of the end-to-end performance and its improvement are important for transactions from sensor node to base station.

4.5.3 Channel access and End-to-End delay

Channel busyness or latency time of data packet, when it is entered in the network layer and getting out is measured by channel access delay, As illustrated in Figure 4.10 (a) the average channel access delay of LEACH, Hybrid multi-hop LEACH and MDC minimum distance LEACH routing protocol during the simulation.

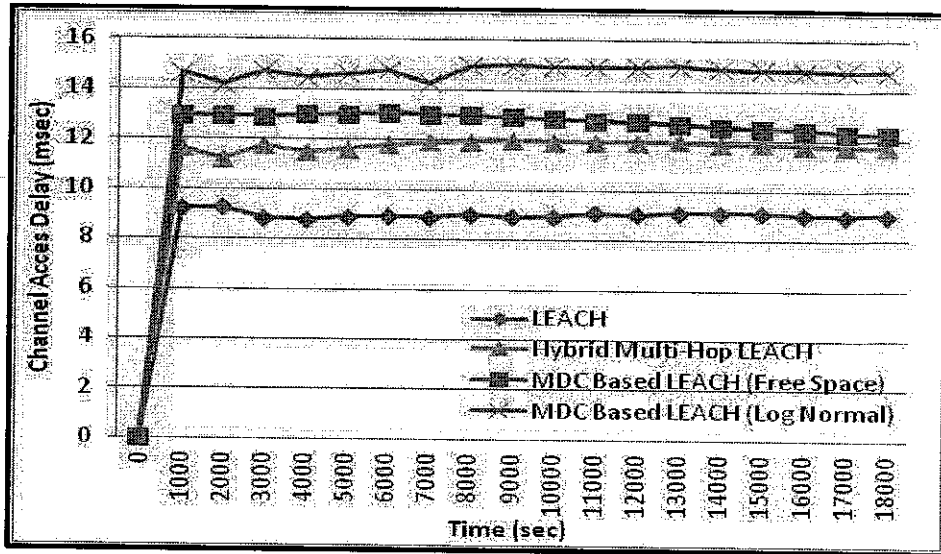

(a)

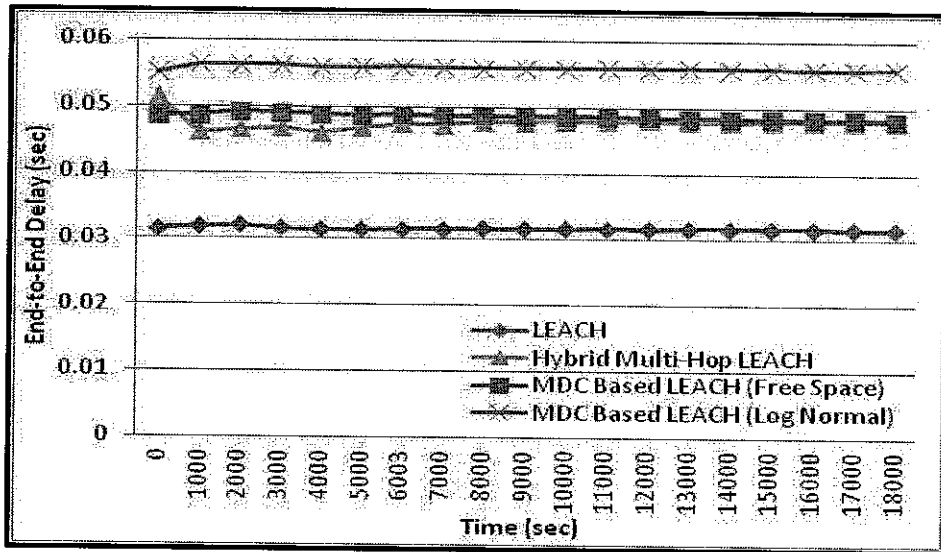

(b)

Figure 4.10 (a) Channel Access Delay (b) End-to-End Delay

The result shows that the channel access delay of MDC minimum distance LEACH is slightly higher than LEACH and Hybrid multi-hop LEACH routing protocol due to increased traffic load between sensor nodes to base station by applying mobile data collector that is based on multi-hop routing strategy. The main metric of network latency is End-to-End delay; it is defined as the time latency of data packet, channel access delay and other potential delays from source to destination. Figure 4.10 (b) illustrate the graph of average End-to-End delay over time using LEACH, Hybrid multi-hop LEACH and MDC minimum distance LEACH routing

protocol. The End-to-End delay of MDC minimum distance LEACH routing protocol is slightly higher than LEACH but same as Hybrid multi-hop LEACH protocol due to aggregated data packets in MDC minimum distance LEACH and Hybrid multi-hop LEACH protocol takes multi-hops and consume more processing time to reach the base station.

4.6 Simulation Results of other performance metrics

This section describes some additional performance metrics of LEACH, Hybrid multi-hop LEACH and MDC based LEACH routing protocols.

4.6.1 Time until first and last node dies

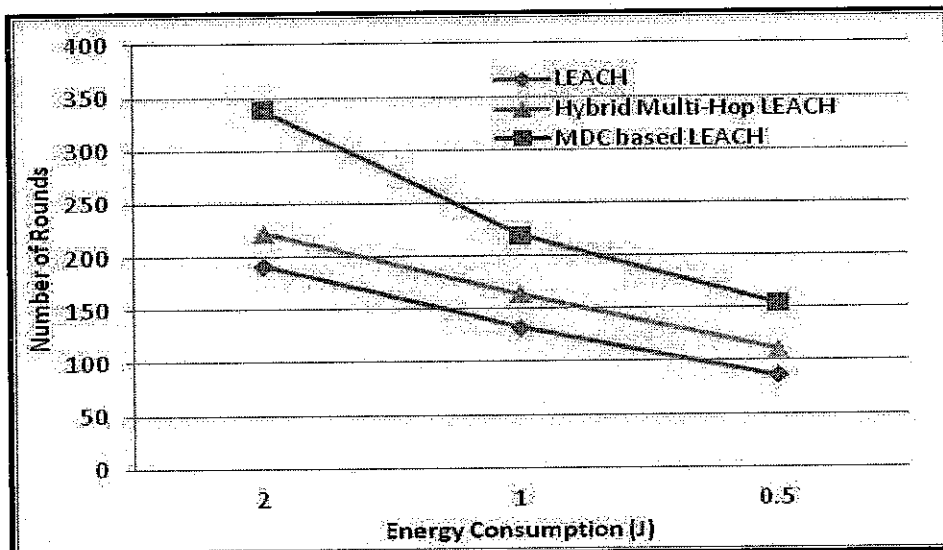

(a)

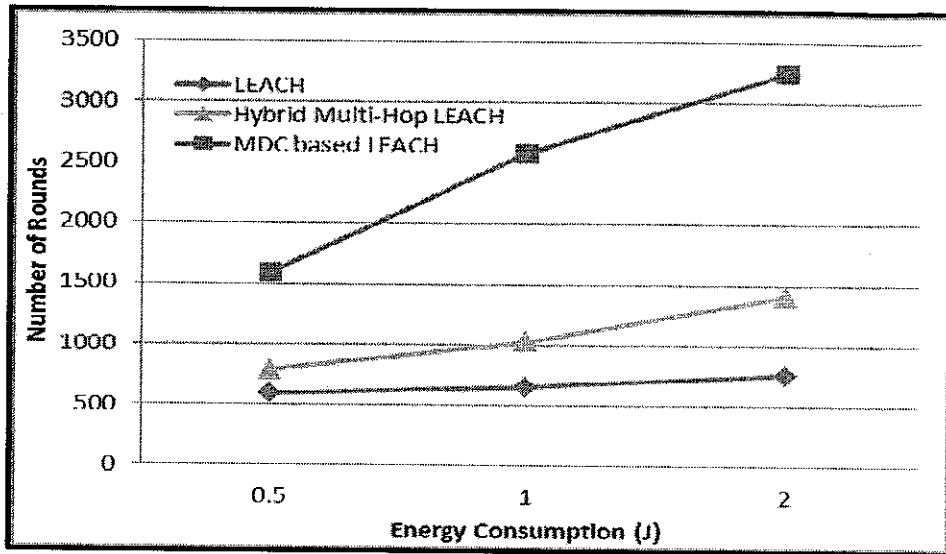

(b)

Figure 4.11 (a) and (b) First and Last Node Dies

The simulation results reflecting the first and last node failures for differing energy levels are illustrated in Figure 4.11 (a) and (b). The LEACH and Hybrid multi-hop LEACH protocols are less scalable than MDC based LEACH routing protocols. This can be seen from the performance of MDC based LEACH is much better than the LEACH and Hybrid multi-hop LEACH, because the time that the first node die for LEACH on the other side, declines exponentially due to the possible large distances that the cluster heads have to transmit to the base station. As expected one of the nodes that was elected as a cluster head is the first to deplete its energy source due to the deployment of homogeneous nodes. However, the first and last nodes dies in Hybrid multi-hop LEACH is later than LEACH protocol because multi-hop routing provide less energy dissipation of sensor nodes and enhance network lifetime.

4.6.2 Node density vs. total energy consumption and vs. total traffic received

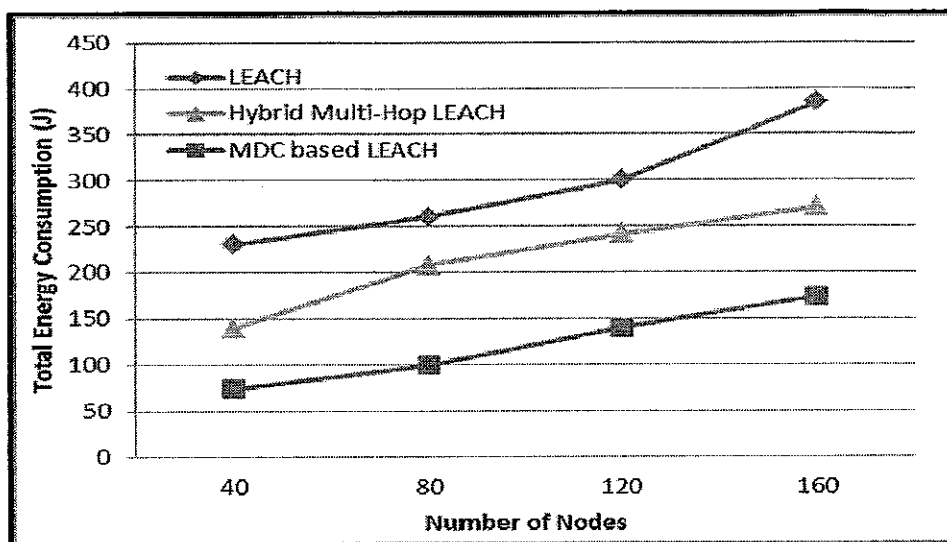

(a)

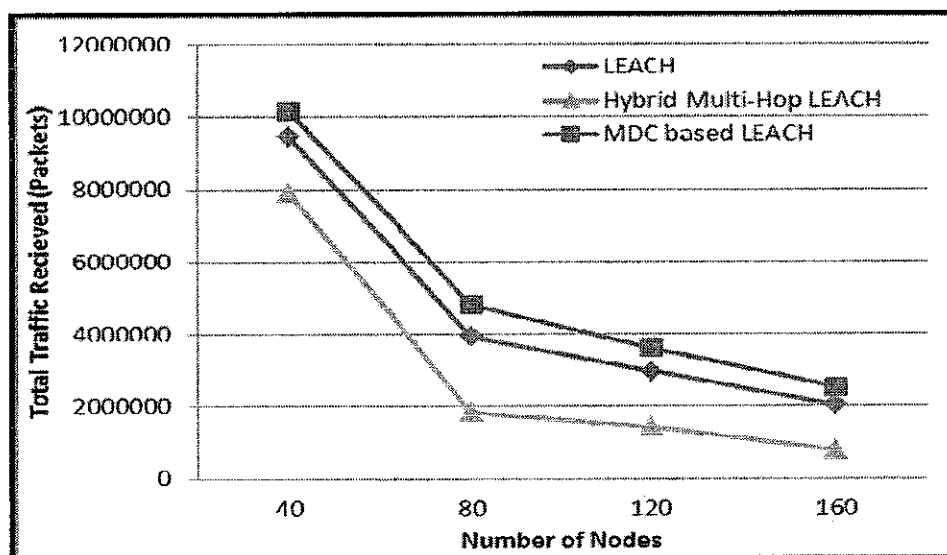

(b)

Figure 4.12 (a) and (b) Node Density vs. Total Energy Consumption and Total Traffic Received

Total energy consumption is the measure of energy dissipated in forwarding a packet to the base station that is indicating the network lifetime optimization attained by the protocols. Figure 4.12 (a), the total energy consumption is plotted on *Y-axis* with varying number of sensor nodes (40-200) on *X-axis*, the total energy consumption of MDC based LEACH is less than the LEACH and Hybrid multi-hop LEACH protocol while increasing node density. At first glance the results show that

the total energy consumption decreases significantly but this can be attributed to increased sensing, computing and forwarding more data towards base station with an increase in network size. Figure 4.12 (b) illustrate the throughput of the network which refers total traffic received while increasing node density, the simulation result validate that the MDC based LEACH protocol is better than LEACH and Hybrid multi-hop LEACH since the proposed protocol is scalable, robust and performs better with the larger WSNs. Moreover, the overall result shows that the total traffic received is decreasing expressively because of huge routing overhead and most importantly high packet loss ratio due to congestion between cluster heads, mobile data collectors and base station. To resolve routing overhead, packet loss and congestion issues from source to destination needs to allocate more cluster heads and mobile data collector as per network requirements.

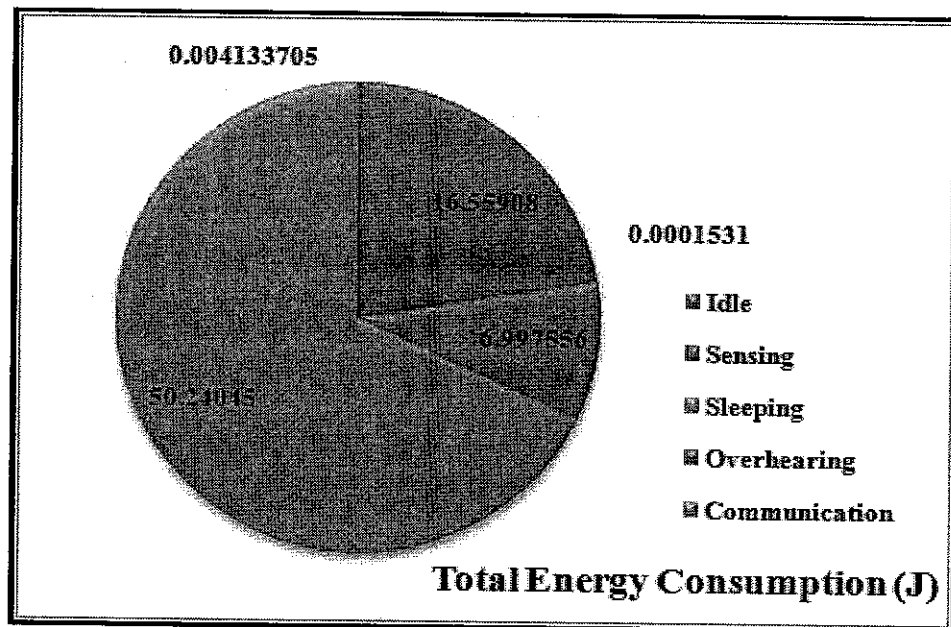

(c)

Figure 4.13 Total Energy Consumption

Figure 4:13 shows the pie chart of total energy consumption including idle, sensing, sleeping, overhearing and communication modes. The most important part is communication mode because 70% energy consumes during communication and rest of the 30 % consumes in sensing, idle, sleeping and overhearing.

4.6.3 Energy consumption of MDC and number of live MDC's

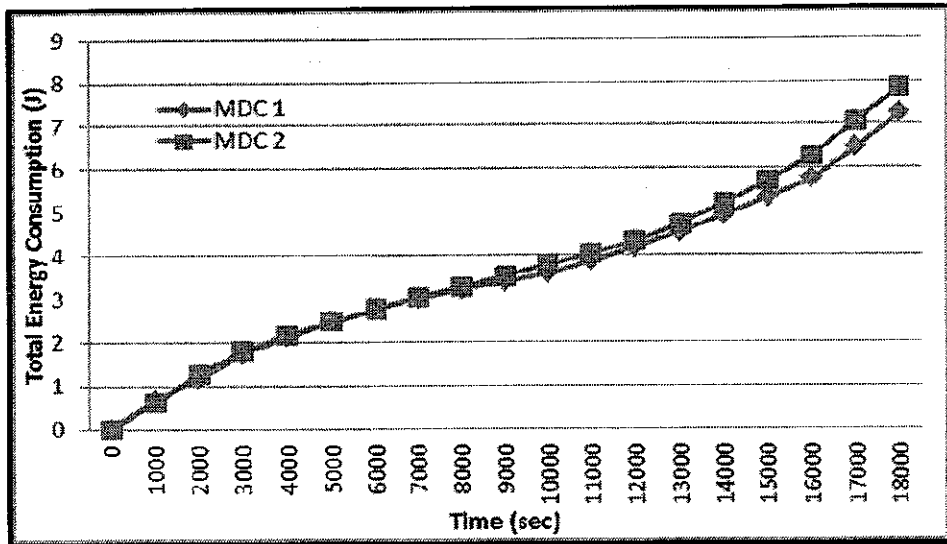

(a)

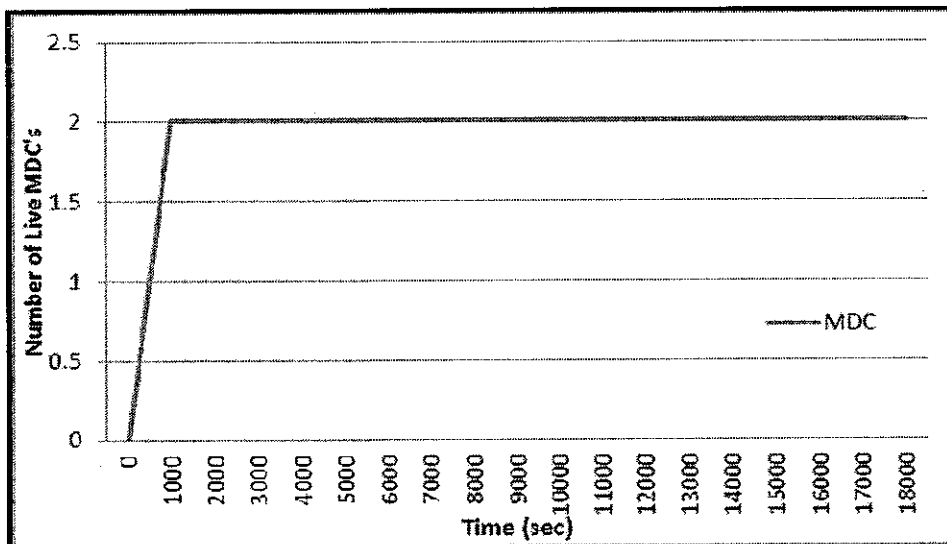

(b)

Figure 4.14 (a) and (b) Energy Consumption and Number of Live MDC's

As discussed earlier the core of the network is dependent upon the better utilization of the mobile data collector, in this concern the research work also consider, maintain and measured the energy consumption of MDC and number of live MDC's as illustrated in Figure 4.14 (a) and (b). According to results, prove that the energy consumption of both mobile data collector is balanced during simulation hours that affect both MDC's are alive longer.

4.7 Factors Influencing Simulation Results

Simulation analysis and deduction during simulations of the routing protocols yielded some interesting characteristics of factors that influence the results presented in this dissertation. It is important to note that any variation on these factors will yield differing results by different researchers. Variation of one or a combination of the factors may even provide results indicating superior performance above others. These factors must carefully be considered and the impact of it analyzed during network simulations.

The size of the simulation area and the number of nodes placed in this area affects the initial node placement, if random node placement is chosen. Random placement functions on a normal random number generator within the maximum X and Y axis perimeters. A popular assumption during the design of many routing protocols in literature state that all nodes will be connected; where connectivity is defined as being within the maximum transmission distance of another node. Random placement of nodes by a simulation may place nodes far away from other nodes causing isolation between nodes or even parts of a network. Protocol simulations can be written to ensure that all assumptions are met before simulation runs are commenced.

Node mobility introduces a few unknown variables that can be described as:

- Although this dissertation assumes random movement of sensor nodes, literature provides a vast number of mathematical models describing the movement of sensor nodes. The mobility model and the movement speed however will be directly affected by the intended application, the movement of sensor nodes within environment is explicitly known and routing protocols can be designed to anticipate that movement.
- As shown in the results, the number of mobile data collector in a sensor network has a direct effect on the performance of the protocol.
- Node mobility during the initialization phase may also cause havoc in protocol operation, if not taken into consideration.
- The mobility of the source nodes and mobile data collector has a direct impact on the strategy taken during message routing. Protocol design should

explicitly state and know the location of mobile nodes; all the protocols simulated in this research are assuming a static base station.

- A survey on literature mentioning node mobility assumes knowledge of the location of a mobile node in an effort to perform intelligent routing. Without proper scientific backing on the process of location determination, the researcher should be weary of these types of assumptions.

High density of nodes and mobile data collector will provide more alternative paths towards the base station. The impact of node mobility on the routing protocol in these deployments will be minimal as there will always be a next better path utilizing the static infrastructure. The researcher's opinion is that it is better to design for a network of sparsely deployed node to ensure that densely deployed nodes will yield the same result.

4.8 Protocol Evaluation and Comparison

The protocols that are used as a benchmark and for simulation analysis in this chapter are LEACH and Hybrid multi-hop LEACH, firstly analyzed and modified to suite the analysis requirement of this research dissertation and then simulation implementation of these protocols on OPNET. Each of the mentioned protocols is simulated in the mentioned environment to measure and analyze the simulated performance against MDC based LEACH routing protocol.

Table 4.2 shows a comparison chart with the simulated routing protocols, these comparisons clearly shows an improvement in energy efficiency of sensor nodes, overall network lifetime and enhance data transport reliability.

Table 4.2 Comparison of simulated protocols

Attributes	MDC Based LEACH Protocol	LEACH Protocol	Hybrid multi-Hop LEACH Protocol
Sensor Node Energy Consumption	No	High	Average
Network Lifetime	High	No	Average
Traffic Received	High	No	Average
Channel Access Delay	Average	No	Average
End-to-End Delay	Average	No	Average
First and Last Node Dies	No	High	Average
Node Density vs. Energy Consumption and Traffic Received	No and High	High and Average	Average and No

Furthermore, Table 4.3 summarizes with existing cluster based routing protocols, this comparison chart also clarify that the MDC based LEACH protocol is better than the other existing routing protocols, the contribution in summary are three-tier architecture of Mobile WSNs, cluster based approach, inter-cluster multi-path and multi-hop routing strategy and provide packet loss detection mechanism.

Table 4.3 Comparison with Existing Protocols

ROUTING PROTOCOLS FOR WIRELESS SENSOR NETWORKS									
Attributes	MDC Based LEACH	FLAVORS OF LEACH PROTOCOLS				CLUSTER BASED ROUTING PROTOCOL			
		Leach	TL-Leach	Hybrid Protocol Leach	Mobile Agent Based Leach	Teen and Apatteen	HEED	EECS	Optimal Relay Node Placement
Cluster Based Routing Three-Tier Architecture	Yes	Yes	Yes	Yes	Yes	Yes	Yes	Yes	Yes
Energy saving	Yes	No	No	No	No	No	No	No	Yes
CSMA/CA	Yes	Yes	Yes	Yes	Yes	Yes	Yes	Yes	Yes
Inter Cluster Multi-Hop Routing Strategy	Yes (CH-MDC-BS)	No	No	Yes (CH-CH-BS)	No (Intra Cluster)	No	No (Intra Cluster)	No	No (Intra Cluster)
Data Reliability	Yes	No	No	Yes	Yes	No	No	No	Yes
Packet Loss Detection	Yes	No	No	No	No	No	No	No	Yes

4.9 Chapter Summary

Simulation results and the verification thereof are crucial in an academic research without the possibility of industrial applications and testing. This chapter has introduced the simulation metrics used for this research to evaluate and analyze the performance of routing protocols. The protocols included in the simulations are: LEACH, Hybrid multi-hop LEACH and Mobile Data Collector based LEACH routing protocol.

The results presented in this chapter focuses on energy efficiency and the reliability of message delivery for two different scenarios. The first scenario is a deployment of mobile data collector based routing with minimum distance towards the base station and the second deployment of mobile data collector based routing with maximum residual energy towards the base station. The results are evaluated against the discussed metrics and possible reasons are stated for abnormalities in the simulation results. The performance metrics for the two scenarios are compared and clearly shows the impact of mobile data collector on the normal operation of a routing protocol.

During the simulation runs, the author realized a few factors that may influence the simulation results of routing protocols presented by literature. These factors are discussed briefly in the end of this chapter.

CHAPTER 5

CONCLUSION AND FUTURE WORK

5.1 Introduction

Mobile Wireless Sensor Network (mobile WSN) is a new technology with multitudes of possibilities for new and interesting applications. These networks can be deployed randomly without physical restriction as with normal wired sensor systems.

Transmission of data and communication within these networks is of utmost importance and the most energy consuming activities. Transmission of data relies on the network routing protocol to successfully delivered messages and data from source to the base station. Due to the physical restrictions of the network components, energy conservation should be the very first consideration when developing and researching network routing protocols within mobile WSNs. Mobile WSNs routing protocols is the focus of this dissertation to further the current body of knowledge.

5.2 Summary of Protocol Design

To conserve energy and maximize the lifetime of the network, a routing protocol needs to be as simple and scalable as possible. It should however not abstract away too much complexity because by doing so it might fail to handle failures and topological changes within the network. These topological changes might even consume more energy network wide in an attempt to compensate for changes.

This dissertation propose, develop and evaluate a mobile data collector based routing protocol for WSNs (MDC based LEACH) which forms the foundation of this research. The routing protocol is required to handle failures as well as topological changes (node mobility) within the network, without consuming too much energy in

the network as a whole to adapt the changed network architecture. The development of MDC based protocol required a thorough understanding of WSNs routing principles and the seminal contributions to the field. Literature proves that a routing protocol contributes to the energy efficiency of WSNs by limiting the amount of message transmissions. MDC based routing is built upon the following principles and design decisions:

- Combining the exceptional qualities of both hierarchical and mobility aware network topologies.
- Source initiated and event driven action.
- Multi message propagation path towards the base station.
- Data aggregation along the message propagation path.
- Routing based on knowledge of distance, available energy levels and mobility status of mobile data collector.
- Computational simplicity.
- Reliability of message delivery at the base station.
- Dynamic adaption to topological changes due to node mobility.

5.3 Summary of Results

The designing and simulation of mobile data collector based routing protocol (MDC based LEACH) was completed utilizing OPNET. The simulated MDC based protocol performance was compared to LEACH and Hybrid multi-hop LEACH using metrics such as energy efficiency of sensor nodes, network lifetime and the reliability of data delivery.

The simulation results presented in this research dissertation represents two network architectures: MDC based routing with minimum distance and MDC based routing with maximum residual energy. The performance metrics for the two scenarios are compared and clearly shows the impact of node mobility on the normal operation of a routing protocol. Multi-hop routing deployment performance of MDC based LEACH exceeds flat network performance but does not quite match the performance of LEACH and Hybrid multi-hop LEACH. Although MDC based

LEACH consumes little bit more End-to-End delay with the inclusion of multi-hop routing strategy in the network, network lifetime and reliability of message delivery more than compensates for this drawback.

Simulation results demonstrate that MDC based LEACH routing protocol reduces the transmission energy of sensor nodes that makes the energy consumption more evenly distributed among all sensor nodes and traffic received at the base station is much higher due to efficiently increase the network lifetime. Acceptable evaluation, comparison and verification of published routing protocols require the availability of source code for the same simulator environment. The simulation code for all the protocols was accepted as correctly implemented and the source code for mobile data collector based routing protocol is readily available for analysis and performance verification.

5.4 Future Work

Future research continuing on the design and principles used for the development of MDC based LEACH routing protocol will verify the results and design presented in this dissertation. Possible research areas and topics may include:

- The investigation of another mobility models like random walk, random waypoint and circular models with variable speed for mobile data collector movement based on specific applications in an attempt to verify the design of MDC based LEACH routing protocol.
- The current implementation of MDC based LEACH is based on single channel allocation at base station. MDC based LEACH will enhance and validate by multi-channel concept at the base station to directly allocate the channel for MDC's instead of single channel. Besides multi-channel approach, the proposed protocol utilizes multi-path concept as well, where aggregated data of cluster heads select the best routing path among the remaining cluster heads and mobile data collectors towards the base station.
- The operation of MDC based LEACH assumes that the successful delivery of critical messages. Further work could include intelligence in the routing layer

to associate critical messages with corresponding ACK messages by means of a “conversation identifier”. In this case, the routing protocol could take over the responsibility to retransmit failed transmissions and dynamically removed failed transmission links to future use.

5.5 Chapter Summary

The uses of dynamic route selection and multi-hop routing strategy towards the base station consumes more End-to-End delay but ensures reduction in the energy consumption of sensor nodes, enhance the network lifetime and reliability of message delivery when topology changes occur due to node mobility. Mobile data collector based routing protocol (MDC based LEACH) succeeds in providing energy efficient solution to mobile WSNs while operating within acceptable Channel access and End-to-End delays.

REFERENCES

- [1] I. F. Akyildiz, W. Su, Y. Sankarasubramaniam, E. Cayirci, "Wireless sensor networks: a survey," *Computer Networks*, vol. no. 38, pp 393–422, December 2001.
- [2] Arshad, M., Kamel, N., Saad, N.M., Armi, N., "Performance enhancement of wireless sensor nodes for environmental applications," *Intelligent and Advanced Systems (ICIAS), 2010 International Conference on*, vol., no., pp. 1-5, 15-17 June 2010.
- [3] Muhammad Arshad, Nasrullah Armi, Nidal Kamel, N.M. Saad, "Mobile data collector based routing protocol for wireless sensor networks," *Scientific Research and Essays Vol. 6(29)*, pp. 6162-6175, November 2011, DOI: 10.5897/SRE11.1339 ISSN 1992-2248 ©2011 Academic Journals.
- [4] Arshad, M., Saad, N.M., Kamel, N., Armi, N., "Routing strategies in hierarchical cluster based mobile wireless sensor networks," *International Conference on Electrical, Control and Computer Engineering (INECCE)*, 2011, vol., no., pp.65-69, 21-22 June 2011.
- [5] Muhammad Arshad, Mohamad Alsalem, Farhan A. Siddqui, N. M. Saad, Nasrullah Armi, Nidal Kamel, "Data Fusion in Mobile Wireless Sensor Networks," *International MultiConference of Engineers and Computer Scientists*, 14 -16 March 2012, Hong Kong.
- [6] M. Frodigh, P. Johansson, P. Larsson, "Wireless ad hoc networking – the art of networking without a network," *Ericsson Review*, vol. 4, pp. 248–263, 2000.
- [7] R. Min, M. Bhardwaj, S. H. Cho, E. Shih, A. Sinha, A. Wang, A. Chandrakasan, "Low-power wireless sensor networks," in *Proc. Fourteenth International Conference on VLSI Design*, Bangalore, India, pp. 205–210, Jan 2001.
- [8] Moyer, B., "Low-power design for embedded processors," *Proceedings of the IEEE*, vol.89, no.11, pp.1576-1587, Nov 2001.
- [9] Martinez, K., Hart, J.K., Ong, R., "Environmental sensor networks," *Computer*, vol.37, no.8, pp. 50- 56, Aug. 2004.

- [10] Wai-Chi Fang and Tsung-Hsien Lin, "Low-Power Radio Design for Wireless Smart Sensor Networks," International Conference on Intelligent Information Hiding and Multimedia Signal Processing, IIH-MSP '06, pp.583-586, Dec., 2006.
- [11] Yijun Liu, Guobo Xie, Pinghua Chen, Jingyu Chen, Zhenkun Li, "Designing an asynchronous FPGA processor for low-power sensor networks," Signals, Circuits and Systems, 2009. ISSCS 2009. International Symposium on, vol., no., pp.1-6, 9-10 July 2009.
- [12] K. Bult, A. Burstein, D. Chang, M. Dong, M. Fielding, E. Kruglick, J. Ho, F. Lin, T. Lin, W. Kaiser, H. Marcy, R. Mukai, P. Nelson, F. Newburg, K. Pister, G. Pottie, H. Sanchez, O. Stafsudd, K. Tan, S. Xue, J. Yao, "Low power systems for wireless microsensors," in Proceedings of the 1996 international symposium on Low power electronics and design (ISLPED '96). IEEE Press, Piscataway, NJ, USA, 17-21.
- [13] Jue Yang and Xinrong Li, "Design and implementation of low-power wireless sensor networks for environmental monitoring," Wireless Communications, Networking and Information Security (WCNIS), 2010 IEEE International Conference on , vol., no., pp.593-597, 25-27 June 2010.
- [14] Janicijevic, N., Lukic, M., Mezei, I., "Routing protocol for low-power and lossy wireless sensor networks," Telecommunications Forum (TELFOR), 2011 19th, vol., no., pp.234-237, 22-24 Nov. 2011.
- [15] Ahmed A. A. and Gurvinder S. B., "An overview of wireless sensor networks," 2012 International Conference on Computer Networks and Communication Systems (CNCS 2012), IPCSIT vol. 35 (2012) © (2012) IACSIT Press, Singapore.
- [16] Yu-Ping Chen and Quincy Wu, "Power consumption measurement and clock synchronization on low-power wireless sensor networks," Advanced Communication Technology (ICACT), 2012 14th International Conference on, vol., no., pp.406-409, 19-22 Feb. 2012.
- [17] Jingxian Wu, "Ultra-low power compressive wireless sensing for distributed wireless networks," Military Communications Conference, 2009. MILCOM 2009. IEEE, vol., no., pp.1-7, 18-21 Oct. 2009.

- [18] Unterassinger, H., Dielacher, M., Flatscher, M., Gruber, S., Kowalczyk, G., Prainsack, J., Herndl, T., Schweighofer, J., Pribyl, W., "A power management unit for ultra-low power wireless sensor networks," AFRICON, 2011, vol., no., pp.1-6, 13-15 Sept. 2011.
- [19] J. M. Kahn, R. H. Katz, K. S. J. Pister, "Next century challenges: Mobile networking for 'smart dust'," in Proceeding Mobicom, pp. 271-278, 1999.
- [20] Rabaey, J. M., Ammer, M. J., da Silva, J. L., Jr., Patel, D., Roundy, S., "Pico Radio supports ad hoc ultra-low power wireless networking," Computer, vol.33, no.7, pp.42-48, Jul 2000.
- [21] F. Burghardt, S. Mellers, J. Rabaey, "The Pico Radio Test Bed," Berkeley Wireless Research Center, U.C. Berkeley, Whitepaper, [http://bwrc.eecs.berkeley.edu/Research/PicoRadio/Test Bed/](http://bwrc.eecs.berkeley.edu/Research/PicoRadio/Test%20Bed/), 2002.
- [22] Charfi, W., Masmoudi, M., Derbel, F., "A layered model for wireless sensor networks," Systems, Signals and Devices, 2009. SSD '09. 6th International Multi-Conference on, vol., no., pp.1-5, 23-26 March 2009.
- [23] Liang Song and Dimitrios Hatzinakos, "A Cross-Layer Architecture of Wireless Sensor Networks for Target Tracking," Networking, IEEE/ACM Transactions on, vol.15, no.1, pp.145-158, Feb. 2007.
- [24] Guangjie Han, Jian Jun Ni, Deokjai Choi, "A Configurable Tiny TCP/IP Protocol Stack Supporting Mobile Node for Sensor Networks," Wireless Communications, Networking and Mobile Computing, 2008. WiCOM '08. 4th International Conference on, vol., no., pp.1-4, 12-14 Oct. 2008.
- [25] Zamani, B., Mohammadi, M., Jalalvand, A., Fakouri, R., Fathy, M., "A Cross Model Approach to Support of QOS Parameters in Wireless Sensor Networks," Computer and Electrical Engineering, 2008. ICCEE 2008. International Conference on, vol., no., pp.41-45, 20-22 Dec. 2008.
- [26] Shijin Dai, Xiaorong Jing, Lemin Li, "Research and analysis on routing protocols for wireless sensor networks," Communications, Circuits and Systems, 2005. Proceedings. 2005 International Conference on, vol.1, no., pp. 407- 411 Vol. 1, 27-30 May 2005.
- [27] Qilian Liang, "Fault-tolerant and energy efficient wireless sensor networks: a cross-layer approach," Military Communications Conference, 2005. MILCOM 2005. IEEE, vol., no., pp.1862-1868 Vol. 3, 17-20 Oct. 2005.

- [28] J.G. Page, "Energy Efficient Hybrid Routing Protocol for Wireless Sensor Networks," Faculty of Engineering, the Built Environment and Information Technology, Dissertation, University of Pretoria, December 2006.
- [29] Yick, J., Mukherjee, B., Ghosal, D., "Wireless sensor network survey," *Computer Networks*, vol. 52, no.12: p. 2292-2330, 2008.
- [30] Vardhan, S., Wilczynski, M., Portie, G.J., Kaiser, W.J., "Wireless integrated network sensors (WINS): distributed in situ sensing for mission and flight systems," *Aerospace Conference Proceedings, 2000 IEEE*, vol.7, no., pp.459-463 vol.7, 2000.
- [31] Dunfan Ye, Daoli Gong, Wei Wang, "Application of wireless sensor networks in environmental monitoring," *Power Electronics and Intelligent Transportation System (PEITS), 2009 2nd International Conference on*, vol.1, no., pp.205-208, 19-20 Dec. 2009.
- [32] Kejie Lu, Yi Qian, Rodriguez, D., Rivera, W., Rodriguez, M., "Wireless Sensor Networks for Environmental Monitoring Applications: A Design Framework," *Global Telecommunications Conference, 2007. GLOBECOM '07. IEEE*, vol., no., pp.1108-1112, 26-30 Nov. 2007.
- [33] Albesa, J., Casas, R., Penella, M.T., Gasulla, M., "REALnet: An environmental WSN Testbed," *Sensor Technologies and Applications, 2007. SensorComm 2007. International Conference on*, vol., no., pp.502-507, 14-20 Oct. 2007.
- [34] Khemapech, Ittipong, Duncan, Ishbel, Miller, Alan, "Energy Preservation in Environmental Monitoring WSN," *Sensor Networks, Ubiquitous, and Trustworthy Computing (SUTC), 2010 IEEE International Conference on*, vol., no., pp.312-319, 7-9 June 2010.
- [35] Gallart, V., Felici-Castell, S., Delamo, M., Foster, A., Perez, J. J., "Evaluation of a Real, Low Cost, Urban WSN Deployment for Accurate Environmental Monitoring," *Mobile Adhoc and Sensor Systems (MASS), 2011 IEEE 8th International Conference on*, vol., no., pp.634-639, 17-22 Oct. 2011.
- [36] Mustafa, R., Kim, J.H., Kelly, J., Ro Le, Jung-Hee Kim, Alexander, W.E., "Wireless sensor network application for cost effective environmental monitoring," *Southeastcon, 2009. IEEE*, vol., no., pp.339-344, 5-8 March 2009.

- [37] Mark Weiser, "The Computer for the Twenty-First Century," *Scientific American*, September 1991.
- [38] Liu, B., Brass, P., Dousse, O., Nain, P., Towsley, D., "Mobility Improve Coverage of Sensor Networks," *Proceedings of ACM MobiHoc 2005*.
- [39] Wei Wang, Vikram Srinivasan, Kee-Chaing Chua, "Using Mobile Relays to Prolong the Lifetime of Wireless Sensor Networks", *MobiCom '05*.
- [40] Yarvis, M., Kushalnagar, N., Singh, H., Rangarajan, A., Liu, Y., Singh, S., "Exploiting Heterogeneity in Sensor Networks," *Proceedings of IEEE INFOCOM 2005*, Miami, FL.
- [41] Mohammad Rahimi, Hardak Shah, Gaurav S. Sukhatme, John Heideman, Deborah Estrin, "Studying the feasibility of Energy Harvesting in a Mobile Sensor Network", in *Proceeding of the 2003 IEEE International Conference on Robotics & Automotion*, Taipei, Taiwan.
- [42] Gajbhiye, P. and Mahajan, A., "A survey of architecture and node deployment in Wireless Sensor Network," *Applications of Digital Information and Web Technologies*, 2008. *ICADIWT 2008. First International Conference on the*, vol., no., pp.426-430, 4-6 Aug. 2008.
- [43] Liu Yong-Min, Wu Shu-Ci, Nian Xiao-Hong, "The Architecture and Characteristics of Wireless Sensor Network," *Computer Technology and Development*, 2009. *ICCTD '09. International Conference on*, vol.1, no., pp.561-565, 13-15 Nov. 2009.
- [44] Xuhui Chen and Peiqiang Yu, "Research on hierarchical mobile wireless sensor network architecture with mobile sensor nodes," *Biomedical Engineering and Informatics (BMEI)*, 2010 3rd International Conference on, vol.7, no., pp.2863-2867, 16-18 Oct. 2010.
- [45] Al-Karaki, J. N., Kamal, A.E., "Routing techniques in wireless sensor networks: a survey," *IEEE Wireless Communications* 11(6), 6–28 (2004).
- [46] Abolhasan, M., Wysocki, T., Dutkiewicz, E., "A review of routing protocols for mobile ad hoc networks," *Ad Hoc Networks* 2(1), 1–22 (2004).
- [47] Wang, Q., Hempstead, M., Yang, W., "A realistic power consumption model for wireless sensor network devices," in *3rd Annual IEEE Communications Society on Sensor and Ad Hoc Communications and Networks (SECON)*, vol. 1, pp. 286–295 (2006).

- [48] Song, L. and Hatzinakos, D., "Architecture of Wireless Sensor Networks with Mobile Sinks: Sparsely Deployed Sensors," *Vehicular Technology, IEEE Transactions on*, vol.56, no.4, pp.1826-1836, July 2007.
- [49] Viani, F., Donelli, M., Oliveri, G., Massa, A., "A mobile wireless sensor network architecture for collaborative tasks achievement by means of autonomous robot swarm," *Antennas and Propagation Society International Symposium (APSURSI), 2010 IEEE*, vol., no., pp.1-4, 11-17 July 2010.
- [50] Haiyun Luo, Fan Ye, Jerry Cheng, Songwu Lu, Lixia Zhang, "TTDD: Two-tier Data Dissemination in Large-scale Wireless Sensor Networks", *ACM Journal of Mobile Networks and Applications (MONET), Special Issue on Mobicom 2003*.
- [51] Munir, S. A., Ren, B., Jiao, W., Wang, B., Xie, D., Ma, J., "Mobile wireless sensor network: Architecture and enabling technologies for ubiquitous computing," in *International Conference on Advanced Information Networking and Applications Workshops*, vol. 2, pp. 113–120 (2007).
- [52] Amundson, I., Koutsoukos, X., Sallai, J.; "Mobile sensor localization and navigation using RF doppler shifts," in *1st ACM International Workshop on Mobile Entity Localization and Tracking in GPS-less Environments, MELT (2008)*.
- [53] Fang, L., Antsaklis, P. J., Montestruque, L., McMickell, M. B., Lemmon, M., Sun, Y., Fang, H., Koutroulis, I., Haenggi, M., Xie, M., Xie, X., "Design of a wireless assisted pedestrian dead reckoning system – the NavMote experience," in *IEEE Transactions on Instrumentation and Measurement*, vol. 54(6), pp. 2342–2358 (2005).
- [54] Munir, S. A., Biao Ren, Weiwei Jiao, Bin Wang, Dongliang Xie, Man Ma, "Mobile Wireless Sensor Network: Architecture and Enabling Technologies for Ubiquitous Computing," *Advanced Information Networking and Applications Workshops, 2007, AINAW '07. 21st International Conference on*, vol.2, no., pp.113-120, 21-23 May 2007.
- [55] Wang, Z. M., Basagni, S., Melachrinoudis, E., Petrioli, C., "Exploiting sink mobility for maximizing sensor networks lifetime," in *Proceedings of the 38th Hawaii International Conference on System Sciences (HICSS 2005)*.

- [56] Jayanthi Rao and Biswas, S., "Joint routing and navigation protocols for data harvesting in sensor networks," *Mobile Ad Hoc and Sensor Systems*, 2008. MASS 2008. 5th IEEE International Conference on, vol., no., pp.143-152, Sept. 29 - Oct. 2 2008.
- [57] Soochang Park, Donghun Lee, Euisin Lee, Minsook Jin, Younghwan Choi, Sang-Ha Kim, "A Communication Architecture for Supporting Mobile User in Wireless Sensor Networks," *Advanced Communication Technology*, The 9th International Conference on, vol.1, no., pp.450-455, 12-14 Feb. 2007.
- [58] Shah, R. C., Roy, S., Jain, S., Brunette, W., "Data MULEs: modeling a three-tier architecture for sparse sensor networks," *Sensor Network Protocols and Applications*, 2003. Proceedings of the First IEEE. 2003 IEEE International Workshop on, vol., no., pp. 30- 41, 11 May 2003.
- [59] Jain, S., Shah, R., Brunette, W., Borriello, G., Roy, S., "Exploiting mobility for energy efficient data collection in wireless sensor networks," *ACM/Springer Mobile Networks and Applications* vol. 11, no. 3 (June 2006), pp. 327-339.
- [60] Xuhui Chen and Peiqiang Yu, "Research on hierarchical mobile wireless sensor network architecture with mobile sensor nodes," *Biomedical Engineering and Informatics (BMEI)*, 2010 3rd International Conference on, vol.7, no., pp.2863-2867, 16-18 Oct. 2010.
- [61] Soochang Park, Euisin Lee, Younghwan Choi, Fucui Yu, Sang-Ha Kim, "Communication Architecture to Support Multiple Mobile Users in Wireless Sensor Networks," *Wireless Communications and Networking Conference*, 2008. WCNC 2008. IEEE, vol., no., pp.2893-2898, March 31 - April 3 2008.
- [62] Wu, J. and Yang, S., "Smart: a scan-based movement-assisted sensor deployment method in wireless sensor networks," in *Proceedings of the 24th IEEE Conference on Computer Communications (INFOCOM 2005)*. vol. 4. pp. 2313-2324.
- [63] Tang, C. and McKinley, P. K., "Energy Optimization under Informed Mobility," *Parallel and Distributed Systems*, *IEEE Transactions on*, vol.17, no.9, pp.947-962, Sept. 2006.

- [64] Gianluca Dini, Marco Pelagatti, Ida Maria Savino, "An algorithm for reconnecting wireless sensor network partitions," in Proceedings of the 5th European conference on Wireless sensor networks (EWSN'08), Roberto Verdone (Ed.). Springer-Verlag, Berlin, Heidelberg, 253-267.
- [65] El-Moukaddem, F., Torng, E., Guoliang Xing, Kulkarni, S., "Mobile relay configuration in data-intensive Wireless Sensor Networks," Mobile Adhoc and Sensor Systems, 2009. MASS '09. IEEE 6th International Conference on, vol., no., pp.80-89, 12-15 Oct. 2009.
- [66] Tacconi, D., Carreras, I., Miorandi, D., Chlamtac, I., Chiti, F., Fantacci, R., "Supporting the Sink Mobility: a Case Study for Wireless Sensor Networks," Communications, 2007. ICC '07. IEEE International Conference on, vol., no., pp.3948-3953, 24-28 June 2007.
- [67] Wei Wang, Srinivasan, V., Kee-Chaing Chua, "Extending the Lifetime of Wireless Sensor Networks through Mobile Relays," Networking, IEEE/ACM Transactions on, vol.16, no.5, pp.1108-1120, Oct. 2008.
- [68] Juang, P., Oki, H., Wang, Y., Martonosi, M., Peh, L., Rubenstein, D., "Energy-efficient computing for wildlife tracking: Design tradeoffs and early experiences with ZebraNet," in Proceedings of the 10th International Conference on Architectural Support for Programming Languages and Operating Systems (ASPLOS 2002). 96-107.
- [69] Small, T. and Haas, Z., "The shared wireless info station model - a new ad hoc networking paradigm," in Proceedings of the 4th ACM International Symposium on Mobile Ad Hoc Networking and Computing (MobiHoc 2003). pp.233-244.
- [70] Haas, Z. J. and Small, T., "A new networking model for biological applications of ad hoc sensor networks," IEEE/ACM Transactions on Networking (TON), 14 (1), pp.27-40.
- [71] Campbell, A. T., Eisenman, S. B., Lane, N. D., Miluzzo, E., Peterson, R. A., "People-centric urban sensing," in Proceedings of the 2nd International Workshop on Wireless Internet (WICON 2006). Article no. 18.
- [72] Campbell, A. T., Eisenman, S. B., Lane, N. D., Miluzzo, E., Peterson, R. A., Lu, H., Zheng, X., Musolesi, M., Fodor, K., Ahn, G. S., "The rise of people-centric sensing," IEEE Internet Computing 12, 4, 12-21.

- [73] Abdelzaher, T., Anokwa, Y., Boda, P., Burke, J., Estrin, D., Guibas, L., Kansal, A., Madden, S., Reich, J., "Mobiscopes for human spaces," *IEEE Pervasive Computing* 6, 2 (April-June), 20-29.
- [74] Conti, M., Pelusi, L., Passarella, A., Anastasi, G., "Adaptation and Cross Layer Design in Wireless Networks," CRC Press, Chapter Mobile-relay Forwarding in Opportunistic Networks, 389-418.
- [75] Buratti, C. and Verdone, R., "A Hybrid Hierarchical Architecture: From a wireless sensor network to the fixed infrastructure," *Wireless Conference, 2008. EW 2008. 14th European*, vol., no., pp.1-7, 22-25 June 2008.
- [76] Eliasson, J., Chen Zhong, Delsing, J., "A heterogeneous sensor network architecture for highly mobile users," *Wireless Communication and Sensor Networks (WCSN), 2010 Sixth International Conference on* , vol., no., pp.1-6, 15-19 Dec. 2010.
- [77] Chakrabarti, A., Sabharwal, A., Aazhang, B., "Using predictable observer mobility for power efficient design of sensor networks," in *Proceedings of the 2nd International Workshop on Information Processing in Sensor Networks (IPSN 2003)*. 129-145.
- [78] Poduri, S. and Sukhatme, G. S., "Achieving connectivity through coalescence in mobile robot networks," in *Proceedings of the 1st International Conference on Robot Communication and Coordination (RoboComm 2007)*. 1-6.
- [79] Somasundara, A.A., Kansal, A., Jea, D.D., Estrin, D., Srivastava, M.B., "Controllably mobile infrastructure for low energy embedded networks," *Mobile Computing, IEEE Transactions on*, vol.5, no.8, pp.958-973, Aug. 2006.
- [80] Akyildiz, I. F., Weilian Su, Sankarasubramaniam, Y., Cayirci, E., "A survey on sensor networks," *Communications Magazine, IEEE*, vol.40, no.8, pp. 102- 114, Aug 2002.
- [81] Tao Yang, Barolli, L., Mino, G., Xhafa, F., Durresi, A., "Impact of Mobile Event Movement on the Performance of Wireless Sensor Networks," *Systems and Networks Communications (ICSNC), 2010 Fifth International Conference on*, vol., no., pp.88-93, 22-27 Aug. 2010.

- [82] Thanigaivelu, K. and Murugan, K., "Impact of Sink Mobility on Network Performance in Wireless Sensor Networks," *Networks and Communications*, 2009. NETCOM '09. First International Conference on, vol., no., pp.7-11, 27-29 Dec. 2009.
- [83] Pushpa, R.A., Vallimayil, A., Dhulipala, V.R.S., "Impact of mobility models on mobile sensor networks," *Electronics Computer Technology (ICECT)*, 2011 3rd International Conference on, vol.4, no., pp.102-106, 8-10 April 2011.
- [84] Abbas Mohammed and Zhe Yang, "A Survey on Routing Protocols for Wireless Sensor Networks," *Sustainable Wireless Sensor Networks*, Winston Seah and Yen Kheng Tan (Ed.), ISBN: 978-953-307-297-5, InTech, Available from: <http://www.intechopen.com/books/sustainable-wireless-sensornetworks/a-survey-on-routing-protocols-for-wireless-sensor-networks>.
- [85] V. Handziski, A. Kopke, H. Karl, A. Wolisz, "A common wireless sensor network architecture," *Telecommunications Networks Group*, Technische Universitat, Berlin, Technical Report TKN-03-012 pp 10-17, July 2003.
- [86] E. Yoneki and J. Bacon, "A survey of Wireless Sensor Network technologies: research trends and middleware's role," *Computer Laboratory*, University of Cambridge, Technical report UCAM-CL-TR-646, September 2005. [Online]. Available: <http://www.cl.cam.ac.uk/TechReports/>.
- [87] K. Akkaya and M. Younis, "A Survey on Routing Protocols for Wireless Sensor Networks," *Ad Hoc Networks*, Volume 3, Issue 3, pp 325-349, May 2005.
- [88] Vivek K., Narottam C., Surender S., "A Survey on Clustering Algorithms for Heterogeneous Wireless Sensor Networks," *International Journal Advanced Networking and Applications* Volume: 02, Issue: 04, Pages: 745-754 (2011).
- [89] Shio K. S., M. P. Singh, D. K. Singh, "Routing Protocols in Wireless Sensor Networks – A Survey," *International Journal of Computer Science & Engineering Survey (IJCSES)* Vol.1, No.2, November 2010.
- [90] Cirstea, C., "Energy efficient routing protocols for Wireless Sensor Networks: A survey," *Design and Technology in Electronic Packaging (SIITME)*, 2011 IEEE 17th International Symposium for , vol., no., pp.277-282, 20-23 Oct. 2011.

- [91] R. A. Roseline and P. Sumathi, "Energy Efficient Routing Protocols and Algorithms for Wireless Sensor Networks – A Survey," *Global Journal of Computer Science and Technology*, Vol., no 11, Issue 21 Version 1.0 Dec. 2011.
- [92] S Shijin Dai, Xiaorong Jing, Lemin Li, "Research and analysis on routing protocols for wireless sensor networks," *Communications, Circuits and Systems, 2005. Proceedings. 2005 International Conference on*, vol.1, no., pp. 407- 411 Vol. 1, 27-30 May 2005.
- [93] M. A. Perillo and W. B. Heinzelman, "Wireless Sensor Network Protocols," in *Algorithms and Protocols for Wireless and Mobile Networks*, Eds. A. Boukerche et al., CRC Hall Publishers, 2004.
- [94] Al-Karaki, J. N. and Kamal, A. E., "Routing techniques in wireless sensor networks: a survey," *Wireless Communications, IEEE*, vol.11, no.6, pp. 6- 28, Dec. 2004.
- [95] J. Kulik, W. R. Heinzelman, H. Balakrishnan, "Negotiation-Based Protocols for Disseminating Information in Wireless Sensor Networks," *Wireless Networks*, Volume 8, Issue 2-3, pp169-185, March 2002.
- [96] Fan Ye, Chen, A., Songwu Lu, Lixia Zhang, "A scalable solution to minimum cost forwarding in large sensor networks," *Computer Communications and Networks, 2001. Proceedings. Tenth International Conference on*, vol., no., pp.304-309, 2001.
- [97] Henderson, W.D. and Tron, S., "Verification of The Minimum Cost Forwarding Protocol for Wireless Sensor Networks," *Emerging Technologies and Factory Automation, 2006. ETFA '06. IEEE Conference on*, vol., no., pp.194-201, 20-22 Sept. 2006.
- [98] Intanagonwiwat, C., Govindan, R., Estrin, D., Heidemann, J., Silva, F., "Directed diffusion for wireless sensor networking," *Networking, IEEE/ACM Transactions on*, vol.11, no.1, pp. 2- 16, Feb 2003.
- [99] Yansheng Zhang, Dancheng Li, Zhiliang Zhu, "A Routing Protocol for Data Centric Storage in Location Ignorant Sensor Networks," *Information Engineering, 2009. ICIE '09. WASE International Conference on*, vol.2, no., pp.131-134, 10-11 July 2009.

- [100] Zabin, F., Misra, S., Woungang, I., Rashvand, H. F., Ma, N. W., Ahsan Ali, M., "REEP: data-centric, energy-efficient and reliable routing protocol for wireless sensor networks," *Communications, IET*, vol.2, no.8, pp.995-1008, September 2008.
- [101] Li-Ling Hung, Sheng-Wen Chang, Chih-Yung Chang, Yu-Chieh Chen, "A data-centric mechanism for Wireless Sensor Networks with weighted queries," *Pervasive Computing (JCPC), 2009 Joint Conferences on*, vol., no., pp.131-136, 3-5 Dec. 2009.
- [102] Zhao, Shousheng, Yu, Fengqi, Zhao, Baohua, "An Energy Efficient Directed Diffusion Routing Protocol," *Computational Intelligence and Security, 2007 International Conference on*, vol., no., pp.1067-1072, 15-19 Dec. 2007.
- [103] Cui Yanrong and Cao Jiaheng, "An Improved Directed Diffusion for Wireless Sensor Networks," *Wireless Communications, Networking and Mobile Computing, 2007. WiCom 2007. International Conference on*, vol., no., pp.2380-2383, 21-25 Sept. 2007.
- [104] Farivar, R., Fazeli, M., Miremadi, S.G., "Directed flooding: a fault-tolerant routing protocol for wireless sensor networks," *Systems Communications, 2005. Proceedings*, vol., no., pp. 395- 399, 14-17 Aug. 2005.
- [105] C. J. Leuschner, "The design of a simple energy efficient routing protocol to improve wireless sensor network lifetime," *Faculty of Engineering, the Built Environment and Information Technology, University of Pretoria*.
- [106] Al Khmour T. A. and Baroudi, U., "A Generalized Energy-Aware Data Centric Routing for Wireless Sensor Network," *Signal Processing and Communications, 2007. ICSPC 2007. IEEE International Conference on*, vol., no., pp.117-120, 24-27 Nov. 2007.
- [107] Awad, A., Germany, R., Dressler, F., "Data-centric cooperative storage in wireless sensor network," *Applied Sciences in Biomedical and Communication Technologies, 2009. ISABEL 2009. 2nd International Symposium on*, vol., no., pp.1-6, 24-27 Nov. 2009.
- [108] Rehena, Z., Roy, S., Mukherjee, N., "A modified SPIN for wireless sensor networks," *Communication Systems and Networks (COMSNETS), 2011 Third International Conference on*, vol., no., pp.1-4, 4-8 Jan. 2011.

- [109] Lindsey, S. and Raghavendra, C.S., "PEGASIS: Power-efficient gathering in sensor information systems," Aerospace Conference Proceedings, 2002. IEEE, vol.3, no., pp. 3-1125- 3-1130 vol.3, 2002.
- [110] Zheng Zeng-wei, Wu Zhao-hui, Lin Huai-zhong, "An Event-Driven Clustering Routing Algorithm for Wireless Sensor Networks," in Proceedings of International Conference on Intelligent Robots and Systems, 2004 (IROS 2004), Volume 2, pp 1802 – 1806, 28 September - 2 October 2004.
- [111] Hempel, M., Sharif, H., Raviraj, P., "HEAR-SN: A New Hierarchical Energy-Aware Routing Protocol for Sensor Networks," System Sciences, 2005. HICSS '05. Proceedings of the 38th Annual Hawaii International Conference on , vol., no., pp. 324a, 03-06 Jan. 2005.
- [112] Hyun-sook Kim and Ki-jun Han, "A power efficient routing protocol based on balanced tree in wireless sensor networks," Distributed Frameworks for Multimedia Applications, 2005. DFMA '05. First International Conference on, vol., no., pp. 138- 143, 6-9 Feb. 2005.
- [113] R. B. Araujo, A. Boukerche, R. W. N. Pazzi, "Fault-tolerant wireless sensor network routing protocols for the supervision of context-aware physical environments," International Symposium on Parallel Architectures, Algorithms, and Networks, 2008 (I-SPAN 2008), pp 247-253, 7-9 May 2008.
- [114] Lotf, J. J., Bonab, M. N., Khorsandi, S., "A Novel cluster-based routing protocol with extending lifetime for wireless sensor networks," Wireless and Optical Communications Networks, 2008. WOCN '08. 5th IFIP International Conference on, vol., no., pp.1-5, 5-7 May 2008.
- [115] Hwang, K. S., Cheng-Shong Wu, Bo-Chao Cheng, Chih-Chuan Cheng, Jia-Bin Lin, Huan Chen, "An improved LEACH-based power aware routing protocol in wireless sensor networks," Communications and Networking in China, 2008. ChinaCom 2008. Third International Conference on, vol., no., pp.726-731.
- [116] Martirosyan, A., Boukerche, A., Pazzi, R.W.N., "A Taxonomy of Cluster-Based Routing Protocols for Wireless Sensor Networks," Parallel Architectures, Algorithms, and Networks, 2008. I-SPAN 2008. International Symposium on, vol., no., pp.247-253, 7-9 May 2008.

- [117] Wei Kuang Lai, Chin-Shiuh Shieh, Yung-Tai Lee, "A cluster-based routing protocol for wireless sensor networks with adjustable cluster size," Communications and Networking in China, 2009. China COM 2009. Fourth International Conference on, vol., no., pp.1-5, 26-28 Aug. 2009.
- [118] Qing Bian, Yan Zhang, Yanjuan Zhao, "Research on Clustering Routing Algorithms in Wireless Sensor Networks," Intelligent Computation Technology and Automation (ICICTA), 2010 International Conference on, vol.2, no., pp.1110-1113, 11-12 May 2010.
- [119] Zeghilet, H., Badache, N., Maimour, M., "Energy efficient cluster-based routing in wireless sensor networks," Computers and Communications, 2009. ISCC 2009. IEEE Symposium on, vol., no., pp.701-704, 5-8 July 2009.
- [120] Min Yoon and Jaewoo Chang, "Design and Implementation of Cluster-Based Routing Protocol Using Message Success Rate in Sensor Networks," High Performance Computing and Communications (HPCC), 2011 IEEE 13th International Conference on , vol., no., pp.622-627, 2-4 Sept. 2011.
- [121] Naeimi, S., Ghafghazi, H., Chow, C.-O., Ishii, H., "A Survey on the Taxonomy of Cluster-Based Routing Protocols for Homogeneous Wireless Sensor Networks," Sensors 2012, 12, 7350-7409.
- [122] Heinzelman, W.R., Chandrakasan, A., Balakrishnan, H., "Energy-efficient communication protocol for wireless microsensor networks," System Sciences, 2000. Proceedings of the 33rd Annual Hawaii International Conference on, vol., no., pp. 10 pp. vol.2, 4-7 Jan. 2000.
- [123] Ruay-Shiung Chang and Chia-Jou Kuo, "An Energy Efficient Routing Mechanism for Wireless Sensor Networks," 20th International Conference on Advanced Information Networking and Applications, 2006 (AINA 2006), Volume 2, pp 5, 18-20 April 2006.
- [124] Mhatre, V. and Rosenberg, C., "Homogeneous vs heterogeneous clustered sensor networks: a comparative study," Communications, 2004 IEEE International Conference on, vol.6, no., pp. 3646- 3651 Vol.6, 20-24 June 2004.

- [125] Manjeshwar, A. and Agrawal, D.P., "TEEN: a routing protocol for enhanced efficiency in wireless sensor networks," *Parallel and Distributed Processing Symposium., Proceedings 15th International*, vol., no., pp.2009-2015, 23-27 April 2000.
- [126] Manjeshwar, A. and Agrawal, D.P., "APTEEN: a hybrid protocol for efficient routing and comprehensive information retrieval in wireless sensor networks," *Parallel and Distributed Processing Symposium., Proceedings International, IPDPS 2002, Abstracts and CD-ROM*, vol., no., pp.195-202, 2002.
- [127] Jichuan Zhao, Erdogan, A. T., Arslan, T., "A novel application specific network protocol for wireless sensor networks," *Circuits and Systems, 2005. ISCAS 2005. IEEE International Symposium on*, vol., no., pp. 5894- 5897 Vol. 6, 23-26 May 2005.
- [128] Ettus, M., "System capacity, latency, and power consumption in multihop-routed SS-CDMA wireless networks," *Radio and Wireless Conference, 1998. RAWCON 98. 1998 IEEE*, vol., no., pp.55-58, 9-12 Aug 1998.
- [129] T. Shepard, "A channel access scheme for large dense packet radio networks," in *Proc. ACM SIGCOMM, (Stanford, CA)*, pp. 219–230, Aug 1996.
- [130] Iwanicki, K. and Van Steen, M., "On hierarchical routing in wireless sensor networks," *Information Processing in Sensor Networks, 2009. IPSN 2009. International Conference on*, vol., no., pp.133-144, 13-16 April 2009.
- [131] Awwad, S. A. B., Ng, C. K., Noordin, N. K., Rasid, M. F. A., "Cluster Based Routing protocol for Mobile Nodes in Wireless Sensor Network," *Collaborative Technologies and Systems, 2009. CTS '09. International Symposium on*, vol., no., pp.233-241, 18-22 May 2009
- [132] Di Francesco, M., Shah, K., Kumar, M., Anastasi, G., "An adaptive strategy for energy efficient data collection in sparse wireless sensor networks," in *Proceedings of the 7th European Conference on Wireless Sensor Networks (EWSN'10)*, pp 322–337.
- [133] Poornima, A. S. and Amberker, B. B., "Secure data collection using mobile data collector in clustered wireless sensor networks," *Wireless Sensor Systems, IET*, vol.1, no.2, pp.85-95, June 2011.

- [134] Boukerche, A. and Pazzi, R. W. N., "Lightweight mobile data gathering strategy for wireless sensor networks," *Mobile Wireless Communications Networks, 2007 9th IFIP International Conference on*, vol., no., pp.151-155, 19-21 Sept. 2007.
- [135] Lu, Gehao, Lu, Joan, Yip, Yau Jim, "Mobile agent based data fusion for wireless sensor networks with a XML framework," in *Proceedings of the 2008 International Conference on Internet Computing, ICOMP 2008*. CSREA Press, pp. 298-303.
- [136] Ming Ma and Yuanyuan Yang, "Data gathering in wireless sensor networks with mobile collectors," *Parallel and Distributed Processing, 2008. IPDPS 2008. IEEE International Symposium on*, vol., no., pp.1-9, 14-18 April 2008.
- [137] Anastasi, G., Conti, M., Di Francesco, M., "Data collection in sensor networks with data mules: An integrated simulation analysis," *Computers and Communications, 2008. ISCC 2008. IEEE Symposium on*, vol., no., pp.1096-1102, 6-9 July 2008.
- [138] Bin Wang, Dongliang Xie, Canfeng Chen, Jian Ma, Shiduan Cheng, "Deploying Multiple Mobile Sinks in Event-Driven WSNs," *Communications, 2008. ICC '08. IEEE International Conference on*, vol., no., pp.2293-2297, 19-23 May 2008.
- [139] Ben Saad, L. and Tourancheau, B., "Multiple Mobile Sinks Positioning in Wireless Sensor Networks for Buildings," *Sensor Technologies and Applications, 2009. SENSORCOMM '09. Third International Conference on*, vol., no., pp.264-270, 18-23 June 2009.
- [140] Zhao, Miao and Yang, Yuanyuan, "Data Gathering in Wireless Sensor Networks with Multiple Mobile Collectors and SDMA Technique Sensor Networks," *Wireless Communications and Networking Conference (WCNC), 2010 IEEE* , vol., no., pp.1-6, 18-21 April 2010.
- [141] Zung-Cheng Chen, Tzung-Shi Chen, Ping-Wen Wu, "On Data Collection Using Mobile Robot in Wireless Sensor Networks," *Systems, Man and Cybernetics, Part A: Systems and Humans, IEEE Transactions on*, vol.41, no.6, pp.1213-1224, Nov. 2011.

- [142] Tzung-Cheng Chen, Tzung-Shi Chen, Ping-Wen Wu, "Data collection in wireless sensor networks assisted by mobile collector," *Wireless Days*, 2008. WD '08. 1st IFIP, vol., no., pp.1-5, 24-27 Nov. 2008.
- [143] Chao Wang and Huadong Ma, "Data Collection in Wireless Sensor Networks by Utilizing Multiple Mobile Nodes," *Mobile Ad-hoc and Sensor Networks (MSN)*, 2011 Seventh International Conference on, vol., no., pp.83-90, 16-18 Dec. 2011.
- [144] Richard W. N. Pazzi and Azzedine Boukerche, "Mobile data collector strategy for delay-sensitive applications over wireless sensor networks," *Computer Communications*, 31(5):1028 – 1039, 2008.
- [145] Alsalih, W., Hassanein, H., Akl, S., "Routing to a Mobile Data Collector on a Predefined Trajectory," *Communications*, 2009. ICC '09. IEEE International Conference on, vol., no., pp.1-5, 14-18 June 2009.
- [146] Basagni, S., Nati, M., Petrioli, C., Petroccia, R., "ROME: Routing Over Mobile Elements in WSNs," *Global Telecommunications Conference*, 2009. GLOBECOM 2009. IEEE , vol., no., pp.1-7, Nov. 30 2009-Dec. 4 2009.
- [147] Weifa Liang, Jun Luo, Xu Xu, "Prolonging Network Lifetime via a Controlled Mobile Sink in Wireless Sensor Networks," *Global Telecommunications Conference (GLOBECOM 2010)*, 2010 IEEE, vol., no., pp.1-6, 6-10 Dec. 2010.
- [148] Nadeem Ahmed, Salil S. Kanhere, Sanjay Jha, "The holes problem in wireless sensor networks: a survey," *SIGMOBILE Mob. Comput. Commun. Rev.* 9, 2 (April 2005), 4-18.
- [149] Fucai Yu, Soochang Park, Ye Tian, Minsuk Jin, Sang-Ha Kim, "Efficient Hole Detour Scheme for Geographic Routing in Wireless Sensor Networks," *Vehicular Technology Conference*, 2008. VTC Spring 2008. IEEE , vol., no., pp.153-157, 11-14 May 2008.
- [150] Liu An-Feng, Wu Xian-You, Gui Wei-Hua, "Research on Energy Hole Problem for Wireless Sensor Networks Based on Alternation between Dormancy and Work," *Young Computer Scientists*, 2008. ICYCS 2008. The 9th International Conference for, vol., no., pp.475-480, 18-21 Nov. 2008.

- [151] Xiaobing Wu, Guihai Chen, Das, S.K., "Avoiding Energy Holes in Wireless Sensor Networks with Nonuniform Node Distribution," *Parallel and Distributed Systems, IEEE Transactions on*, vol.19, no.5, pp.710-720, May 2008.
- [152] Weijia Jia, Tian Wang, Guojun Wang, Minyi Guo, "Hole Avoiding in Advance Routing in Wireless Sensor Networks," *Wireless Communications and Networking Conference, 2007.WCNC 2007. IEEE*, vol., no., pp.3519-3523, 11-15 March 2007.
- [153] P. Corkey, R. Peterson, D. Rus., "Finding Holes in Sensor Networks," *Proceedings of the Workshop on Omniscient Space: Robot Control Architecture Geared toward Adapting to Dynamic Environments at ICRA 2007*.
- [154] Lijie Xu, Guihai Chen, Xinchun Yin, Panlong Yang, Baijian Yang, "LORP: A Load-Balancing Based Optimal Routing Protocol for Sensor Networks with Bottlenecks," *Wireless Communications and Networking Conference, 2009. WCNC 2009. IEEE*, vol., no., pp.1-6, 5-8 April 2009.
- [155] Khan, I. F. and Javed, M. Y., "A Survey on Routing Protocols and Challenge of Holes in Wireless Sensor Networks," *Advanced Computer Theory and Engineering, 2008. ICACTE '08. International Conference on*, vol., no., pp.161-165, 20-22 Dec. 2008.
- [156] S. Funke, "Topological hole detection in wireless sensor networks and its applications," in *DIALM-POMC '05: Proceedings of the 2005 Joint Workshop on Foundations of Mobile Computing, 2005*, pp. 44-53.
- [157] D. Kotz, C. Newport, C. Elliot, "The mistaken axioms of wireless-network research," *Dartmouth College Computer Science Technical Report TR 2003-467*, July 2003.
- [158] OPNET Technologies, Inc., *OPNET MODELER*, 2004. <http://www.opnet.com/products/modeler/home.html>.
- [159] Uddin, M. S., Ali, N. B. Z., Hamid, N. H., "Wave propagation and energy model for dynamic Wireless Body Area Networks," *Electrical, Control and Computer Engineering (INECCE), 2011 International Conference on*, vol., no., pp.160-165, 21-22 June 2011.

- [160] C. Schurgers and M. B. Srivastava, "Energy efficient routing in Wireless Sensor Networks," Proceedings of MILCOM 2001 (Communications for Network-Centric Operations: Creating the Information Force). IEEE, vol. 1, pp 357-361, October 2001.
- [161] Shah, R. C. and Rabaey, J. M., "Energy aware routing for low energy ad hoc sensor networks," Wireless Communications and Networking Conference, 2002. WCNC2002. 2002 IEEE, vol.1, no., pp. 350- 355 vol.1, 17-21 Mar 2002.
- [162] Zhang, J. and Shi, H., "Energy-efficient routing for 2D grid wireless sensor networks," Information Technology: Research and Education, 2003. Proceedings. ITRE2003. International Conference on, vol., no., pp. 311- 315, 11-13 Aug. 2003.
- [163] Jae-Hwan Chang and Tassiulas, L., "Maximum lifetime routing in wireless sensor networks," Networking, IEEE/ACM Transactions on, vol.12, no.4, pp. 609- 619, Aug. 2004.
- [164] Datta, A., "A fault-tolerant protocol for energy-efficient permutation routing in wireless networks," Computers, IEEE Transactions on, vol.54, no.11, pp. 1409- 1421, Nov. 2005.
- [165] Culler, D., Estrin, D., Srivastava, M., "Guest Editors' Introduction: Overview of Sensor Networks," Computer, vol.37, no.8, pp. 41- 49, Aug. 2004.
- [166] David Braginsky and Deborah Estrin, "Rumor routing algorithm for sensor networks," in Proceedings of the 1st ACM international workshop on Wireless sensor networks and applications (WSNA '02). ACM, New York, NY, USA, 22-31.
- [167] Sadagopan, N., Krishnamachari, B., Helmy, A., "The ACQUIRE mechanism for efficient querying in sensor networks," Sensor Network Protocols and Applications, 2003. Proceedings of the First IEEE. 2003 IEEE International Workshop on, vol., no., pp. 149- 155, 11 May 2003.
- [168] Loh, P. K. K., Long, S. H., Pan, Y., "An Efficient and Reliable Routing Protocol for Wireless Sensor Networks," in Sixth IEEE International Symposium on a World of Wireless Mobile and Multimedia Networks (WoWMoM 2005) (2005).

- [169] M. Chu, H. Haussecker, F. Zhao, "Scalable Information-Driven Sensor Querying and Routing for ad hoc Heterogeneous Sensor Networks," *The International Journal of High Performance Computing Applications*, Vol. 16, No. 3, August 2002.
- [170] Subramanian, L. and Katz, R.H., "An architecture for building self-configurable systems," *Mobile and Ad Hoc Networking and Computing*, 2000. *MobiHOC. 2000 First Annual Workshop on*, vol., no., pp.63-73, 2000.
- [171] Rodoplu, V. and Meng, T.H., "Minimum energy mobile wireless networks," *Selected Areas in Communications, IEEE Journal on*, vol.17, no.8, pp.1333-1344, Aug 1999.
- [172] Li, L. and Halpern, J. Y., "Minimum-energy mobile wireless networks revisited," *Communications, 2001. ICC 2001. IEEE International Conference on*, vol.1, no., pp.278-283 vol.1, 11-14 Jun 2001.
- [173] Q. Li and J. Aslam; D. Rus, "Hierarchical Power-aware Routing in Sensor Networks," in *Proceedings of the DIMACS Workshop on Pervasive Networking*, May, 2001.
- [174] Fan Ye, Haiyun Luo, Jerry Cheng, Songwu Lu, Lixia Zhang, "A two-tier data dissemination model for large-scale wireless sensor networks," in *Proceedings of the 8th annual international conference on Mobile computing and networking (MobiCom '02)*. ACM, New York, NY, USA, 148-159.
- [175] Q. Fang, F. Zhao, L. Guibas, "Lightweight Sensing and Communication Protocols for Target Enumeration and Aggregation," *Proceedings of the 4th ACM international symposium on Mobile ad hoc networking and computing (MOBIHOC)*, 2003, pp. 165-176.
- [176] Al-Karaki, J. N., Ul-Mustafa, R., Kamal, A. E., "Data aggregation in wireless sensor networks - exact and approximate algorithms," *High Performance Switching and Routing, 2004. HPSR. 2004 Workshop on*, vol., no., pp. 241- 245, 2004.
- [177] Jeong Hee-Jin, Nam Choon-Sung, Jeong Yi-Seok, Shin Dong-Ryeol, "A Mobile Agent Based LEACH in Wireless Sensor Networks," in *Proc. ICACT 2008*, pp.75-78.
- [178] Ben Saad, L. and Tourancheau, B., "Multiple Mobile Sinks Positioning in Wireless Sensor Networks for Buildings," *Sensor Technologies and*

- Applications, 2009. SENSORCOMM '09. Third International Conference on, vol., no., pp.264-270, 18-23 June 2009
- [179] Mario Di Francesco, Kunal Shah, Mohan Kumar, Giuseppe Anastasi, "An adaptive strategy for energy-efficient data collection in sparse wireless sensor networks," in Proceedings of the 7th European conference on Wireless Sensor Networks (EWSN'10), Jorge Sá Silva, Bhaskar Krishnamachari, and Fernando Boavida (Eds.). Springer-Verlag, Berlin.
- [180] M. Di Francesco, S. Das, G. Anastasi, "Data Collection in Wireless Sensor Networks with Mobile Elements: A Survey," ACM Transactions on Sensor Networks, to appear (available at <http://info.iet.unipi.it/~anastasi/papers/tosn11.pdf>).
- [181] Tzung-Cheng Chen, Tzung-Shi Chen, Ping-Wen Wu, "On Data Collection Using Mobile Robot in Wireless Sensor Networks," Systems, Man and Cybernetics, Part A: Systems and Humans, IEEE Transactions on, vol.41, no.6, pp.1213-1224, Nov. 2011.
- [182] Anastasi, G., Conti, M., Di Francesco, M., "Data collection in sensor networks with data mules: An integrated simulation analysis," Computers and Communications, 2008. ISCC 2008. IEEE Symposium on, vol., no., pp.1096-1102, 6-9 July 2008.
- [183] Tzung-Cheng Chen, Tzung-Shi Chen, Ping-Wen Wu, "Data collection in wireless sensor networks assisted by mobile collector," Wireless Days, 2008. WD '08. 1st IFIP , vol., no., pp.1-5, 24-27 Nov. 2008.
- [184] Bin Wang, Dongliang Xie, Canfeng Chen, Jian Ma, Shiduan Cheng, "Deploying Multiple Mobile Sinks in Event-Driven WSNs," Communications, 2008. ICC '08. IEEE International Conference on, vol., no., pp.2293-2297, 19-23 May 2008.
- [185] Kumar, A. K. and Sivalingam, K. M., "Energy-efficient mobile data collection in Wireless Sensor Networks with delay reduction using wireless communication," Communication Systems and Networks (COMSNETS), 2010 Second International Conference on , vol., no., pp.1-10, 5-9 Jan. 2010.
- [186] Wenning, B. L., Lukosius, A., Timm-Giel, A., Gorg, C., Tomic, S., "Opportunistic Distance-aware Routing in Multi-Sink Mobile Wireless Sensor Networks". Proceeding ICT Mobile-Summit 2008.

- [187] Munir, S. A., Biao Ren, Weiwei Jiao, Bin Wang, Dongliang Xie, Man Ma, "Mobile Wireless Sensor Network: Architecture and Enabling Technologies for Ubiquitous Computing," Advanced Information Networking and Applications Workshops, 2007, AINAW '07. 21st International Conference on, vol.2, no., pp.113-120, 21-23 May 2007.
- [188] Vivek Katiyar, Narottam Chand, Surender Soni, "A Survey on Clustering Algorithms for Heterogeneous Wireless Sensor Networks" International Journal Advanced Networking and Applications vol. 02, no. 04, Pages: 745-754, 2011.
- [189] Yang, Z. and Mohammed, A., "A survey of routing protocols of wireless sensor networks", Proceedings of the Sustainable Wireless Sensor Networks. 2010.
- [190] Suraj Sharma and Sanjay Kumar Jena, "A Survey on Secure Hierarchical Routing Protocols in Wireless Sensor Networks," ICCCS'11 February 2011.
- [191] Cirstea, C., "Energy efficient routing protocols for Wireless Sensor Networks: A survey," International Symposium for Design and Technology in Electronic Packaging (SIITME), pp. 277 – 282, 2011.
- [192] R. Roseline and P. Sumathi, "Energy efficient routing protocols and algorithms for wireless sensor networks - a survey," Global Journal of Computer Science and Technology, vol. 11, pp. 61–67, Dec. 2011.

PUBLICATIONS

Journals:

- **Muhammad Arshad**, Nasrullah Armi, Nidal Kamel, N.M. Saad, “Mobile data collector based routing protocol for wireless sensor networks,” Scientific Research and Essays Vol. 6(29), pp. 6162-6175, 30 November, 2011, DOI: 10.5897/SRE11.1339 ISSN 1992-2248 ©2011 Academic Journals
- **Muhammad Arshad**, Mohamad Y. Alsalem, NidalKamel, N.M. Saad, “Energy Efficient Data Fusion in Mobile Wireless Sensor Networks”, Journal of Network and Computer Application (JNCA),(*under review*)
- **Muhammad Arshad**, Mohamad Y. Alsalem, NidalKamel, N.M. Saad, “Energy Efficient Cluster Based Routing Protocol for Mobile Wireless Sensor Networks”, Research Journal of Applied Sciences, Engineering and Technology,(*under review*)

Conferences:

- **Muhammad Arshad.**; Mohamad Y Aalsalem,; Farhan A Siddqui,; N.M. Saad,; Nasrullah Armi,; Nidal Kamel,, “Efficient Cluster Head Selection Scheme in Mobile Data Collector Based Routing Protocol”, “International Conference on Intelligent and Advanced Systems 2012”, Malaysia, 12-14 June 2012 (*Accepted*).
- **Muhammad Arshad.**; Mohamad Y Aalsalem,; Farhan A Siddqui,; N.M. Saad,; Nasrullah Armi,; Nidal Kamel,, “Data Fusion in Wireless Sensor Networks”, Proceeding of the “International MultiConference of Engineers and Computer Scientists 2012” Vol. I, IMECS 2012, March 14-16, 2012, Hong Kong.
- **Arshad, M.**; Saad, N.M.; Kamel, N.; Armi, N., “Routing strategies in hierarchical cluster based mobile wireless sensor networks,” International Conference on Electrical, Control and Computer Engineering (INECCE), 2011, vol., no., pp.65-69, 21-22 June 2011.
- **Arshad, M.**; Kamel, N.; Saad, N.M.; Armi, N., “Performance enhancement of wireless sensor nodes for environmental applications,” Intelligent and Advanced Systems (ICIAS), 2010 International Conference on, vol., no., pp. 1-5, 15-17 June 2010.

APPENDIX A

CODE FOR MOBILE DATA COLLECTOR BASED ROUTING PROTOCOL

SENSOR NODE

PROCESS STATE

Temporary Variables

```
double    gen_rate, mean_sz, var_sz;
double    dummy, my_theo_load;
char      pk_size_args_str[255];
char      pk_size_dist_str[255];
int       pk_size, member_no_tem, node_no;
Packet*   pkptr;
double    rand_time;
double    start_time_delay;
int       source_id, source_no;
double    base_freq, bandwidth, center_freq, lambda, own_power;
Objid     chan_id, sub_chan_id;
double    ete_delay;
```

Header Block

```
#include "stdio.h"
#include "math.h"
#include "string.h"
#define IN_STRM 0
#define OUT_STRM 0
#define IN_STAT 0
#define HELLO      0
#define ANNOU      1
#define JOIN       2
#define DISCONNECT 3
#define MSG_ACK    4
#define INFO       5
#define BEGINSTEADY 6
```



```

#define BEACON_MESSAGE 7
#define START_TIME_DELAY_FLAG 0
#define WAIT_DECISION_TIME_FLAG 1
#define WAIT_ANNOU_TIME_FLAG 2
#define WAIT_JOIN_TIME_FLAG 3
#define MSG_ACK_TIME_FLAG 4
#define SEND_INFO_TIME_FLAG 5
#define ROUND_TIME_FLAG 6
#define WAIT_SEND_ANNOU_FLAG 7
#define SEND_JOIN_TIME_FLAG 8
#define SEND_BEGIN_TIME_FLAG 9
#define SEND_BS_TIME_FLAG 10
#define ALL_NODE 0
#define HEAD "cluster head"
#define MEMBER "member"
#define CHAN_POWER (op_intrpt_type() == OPC_INTRPT_STAT)
#define DEFAULT_PKT_ARVL (op_intrpt_type() == OPC_INTRPT_STRM)
#define START ((op_intrpt_type() == OPC_INTRPT_SELF) &&
(op_intrpt_code() == START_TIME_DELAY_FLAG))
#define TIME_UP_1 ((op_intrpt_type () == OPC_INTRPT_SELF)
&& (op_intrpt_code() == WAIT_DECISION_TIME_FLAG))
#define TIME_UP_3 ((op_intrpt_type () == OPC_INTRPT_SELF)
&& (op_intrpt_code() == WAIT_ANNOU_TIME_FLAG))
#define TIME_UP_2 ((op_intrpt_type () == OPC_INTRPT_SELF)
&& (op_intrpt_code() == WAIT_JOIN_TIME_FLAG))
#define TIME_UP_4 ((op_intrpt_type () == OPC_INTRPT_SELF)
&& (op_intrpt_code() == MSG_ACK_TIME_FLAG))
#define SEND_INFO_TIME_UP ((op_intrpt_type () ==
OPC_INTRPT_SELF) && (op_intrpt_code() == SEND_INFO_TIME_FLAG))
#define ROUND_TIME_UP ((op_intrpt_type () ==
OPC_INTRPT_SELF) && (op_intrpt_code() == ROUND_TIME_FLAG))
#define SEND_ANNOU_TIME_UP ((op_intrpt_type () ==
OPC_INTRPT_SELF) && (op_intrpt_code() == WAIT_SEND_ANNOU_FLAG))

```

```

#define SEND_JOIN_TIME_UP ((op_intrpt_type () ==
OPC_INTRPT_SELF) && (op_intrpt_code()==SEND_JOIN_TIME_FLAG))
#define SEND_BEGIN_TIME_UP ((op_intrpt_type () ==
OPC_INTRPT_SELF) && (op_intrpt_code()==SEND_BEGIN_TIME_FLAG))
#define SEND_BS_TIME_UP ((op_intrpt_type () ==
OPC_INTRPT_SELF) && (op_intrpt_code()==SEND_BS_TIME_FLAG))

```

```
extern int No_live_nodes;
```

```
#define T_E 1
```

Function Block

```

#define SIXTEEN_PI_SQ 157.91367
#define C_speed 300000000
#define node_list_size 30
#define head_list_size 10
#define Efs 1e-11
#define Emp 1.3e-15
#define Eelec 5e-8
#define Eda 5e-9
#define l 284

```

```

/*****
*****
*****

```

The following functions are to maintain the network status list by modifying the network status attributes of the nodes

```

*****
*****
*****/
/*****

```

This function is to find distance of a node in the node list

```
*****/
```

```
double
```

```
node_find_distance(ID)
```

```

Objid ID;
{
Objid temp_id,init_id;
int id,i;
Objid found_id=OPC_FALSE;
double distance;
FIN(node_find_distance())

init_id=op_id_from_name((op_topo_child(network_list_id,OPC_OBJTYPE_GENER
IC,0)),OPC_OBJTYPE_COMP,"cluster head");
for(i=0;i<=node_list_size;i++)
{
temp_id=op_topo_child((init_id+2*i),OPC_OBJTYPE_GENERIC,0);
op_ima_obj_attr_get(temp_id,"ID",&id);
if(id==ID)
{
found_id=init_id+2*i;
op_ima_obj_attr_get(temp_id,"distance",&distance);
break;
}
}

FRET(distance);
}

/*****
*****
***
this function is to send the specific packet to low lever csma_proc
*****
*****
*****/

static void
pkt_send (target_id,content)

```

```

Objid target_id;
int content;
{
Packet*          pkptr;
int              pkt_size;
double          intx_pos,inty_pos,distance,distance2;
Objid           chan_id,sub_chan_id;
double          temp_energy;

FIN (pkt_send ());

if(content!=INFO)
{
pkptr = op_pk_create_fmt (pk_format_str);
/*Enter the specific value for the source_address in the packet*/
/*find the parent object ID of source*/
op_pk_nfd_set(pkptr,"source_address",node_id);
op_pk_nfd_set(pkptr,"dest_address",target_id);
op_pk_nfd_set(pkptr,"msg_type",content);
op_ima_obj_attr_get(node_id,"x position",&x_pos);
op_ima_obj_attr_get(node_id,"y position",&y_pos);
op_pk_nfd_set(pkptr,"x_pos",x_pos);
op_pk_nfd_set(pkptr,"x_pos",x_pos);
}
else
{
pkptr=op_pk_create_fmt(info_pkt_format);
pkt_size=284;
op_pk_bulk_size_set (pkptr, pkt_size);
op_pk_nfd_set(pkptr,"source_address",node_id);
op_pk_nfd_set(pkptr,"dest_address",target_id);
op_pk_nfd_set(pkptr,"msg_type",content);
op_ima_obj_attr_get(node_id,"x position",&x_pos);

```

```

op_ima_obj_attr_get(node_id,"y position",&y_pos);
    /*op_pk_bcast_unique(pkptr,target_id);*/
op_ima_obj_attr_get(xmt_id,"channel",&chan_id);
sub_chan_id=op_topo_child(chan_id,OPC_OBJTYPE_RATXCH,0);
op_ima_obj_attr_set(sub_chan_id,"spreading code",(double)(target_id));
op_ima_obj_attr_get(rcv_id,"channel",&chan_id);
sub_chan_id=op_topo_child(chan_id,OPC_OBJTYPE_RARXCH,0);
op_ima_obj_attr_set(sub_chan_id,"spreading code",(double)(target_id));
op_ima_obj_attr_get(target_id,"x position",&intx_pos);
op_ima_obj_attr_get(target_id,"y position",&inty_pos);
    distance2=pow((x_pos-intx_pos),2)+pow((y_pos-inty_pos),2);
    tem_energy_consumption=energy_consumption;
    temp_energy=1*(Eelec+Efs*distance2);
    energy_consumption=energy_consumption+temp_energy;
    op_stat_write(totalenergy_gstathandle,temp_energy);
    op_stat_write(energy_hndl,energy_consumption);

if((energy_consumption>=T_E)&&(tem_energy_consumption<T_E))
    {
        No_live_nodes=No_live_nodes-1;
        op_stat_write(No_live_nodes_hndl,No_live_nodes);
    }
else
    {
        op_stat_write(No_live_nodes_hndl,No_live_nodes);
    }
}

if(content==HELLO)
    {
        /* schedule intrpt for the delivery of the next pkt */
        time_up_1_ehndl=op_intrpt_schedule_self ((op_sim_time () + time_up_1),
WAIT_DECISION_TIME_FLAG);
round_time_up_ehndl=op_intrpt_schedule_self((op_sim_time()+round_time),

```

```

ROUND_TIME_FLAG);

if(round_no%(node_number/head_number)==0&&HAS_BEEN_HEAD==OPC_TR
UE)
    {
        HAS_BEEN_HEAD=OPC_FALSE;
    }
    round_no=round_no+1;
    op_ima_obj_attr_get(xmt_id,"channel",&chan_id);
    sub_chan_id=op_topo_child(chan_id,OPC_OBJTYPE_RATXCH,0);
    op_ima_obj_attr_set(sub_chan_id,"spreading
code",OPC_BOOLDBL_DISABLED);
    op_ima_obj_attr_get(rcv_id,"channel",&chan_id);
    sub_chan_id=op_topo_child(chan_id,OPC_OBJTYPE_RARXCH,0);
    op_ima_obj_attr_set(sub_chan_id,"spreading
code",OPC_BOOLDBL_DISABLED);
    }
    if(content==JOIN)
    {
        send_join_time_ehndl=op_intrpt_schedule_self((op_sim_time()
+
op_dist_uniform(send_join_time)), SEND_JOIN_TIME_FLAG);
    }
    if(content==MSG_ACK)
    {
        op_pk_nfd_set(pkptr,"status",member_no);
        op_pk_bcast_unique(pkptr,target_id);
    }
    if(content==ANNOU)
    {
        time_up_2_ehndl=op_intrpt_schedule_self ((op_sim_time () + time_up_2),
WAIT_JOIN_TIME_FLAG);
    }
    if(content==BEGINSTEADY)

```

```

    {
send_BS_time_ehndl=op_intrpt_schedule_self((op_pk_creation_time_get(pkptr)+(me
mber_no+1)*slot_time),SEND_BS_TIME_FLAG);
    op_ima_obj_attr_get(xmt_id,"channel",&chan_id);
    sub_chan_id=op_topo_child(chan_id,OPC_OBJTYPE_RATXCH,0);
    op_ima_obj_attr_set(sub_chan_id,"spreading code",(double)(node_id));
    op_ima_obj_attr_get(rcv_id,"channel",&chan_id);
    sub_chan_id=op_topo_child(chan_id,OPC_OBJTYPE_RARXCH,0);
    op_ima_obj_attr_set(sub_chan_id,"spreading code",(double)(node_id));
    }
/* send the pkt to the output stream */
op_pk_send (pkptr, OUT_STRM);
FOUT;
}

```

/******

This function is to find a node in the node list, return corresponding object id of the compound attributes

*****/

Objid

node_find(ID)

Objid ID;

{

Objid temp_id,init_id;

int id,i;

Objid found_id=OPC_FALSE;

FIN(node_find())

```

init_id=op_id_from_name((op_topo_child(network_list_id,OPC_OBJTYPE_GENER
IC,0)),OPC_OBJTYPE_COMP,"cluster head");

```

```

for(i=0;i<=node_list_size;i++)

```

```

{

```

```

temp_id=op_topo_child((init_id+2*i),OPC_OBJTYPE_GENERIC,0);

```

```

op_ima_obj_attr_get(temp_id,"ID",&id);

```

```

        if(id==ID)
        {
            found_id=init_id+2*i;
            break;
        }
    }
    FRET(found_id);
}
/*****

```

This function is to update the "ID" field and the "distance" field of a node. FLAG specify if it is a cluster head or member node

```

*****/
Boolean
node_add(ID,distance,status,xpos,ypos,FLAG)
    Objid ID;
    double distance;
    char FLAG[64];
    double status;
    double xpos,ypos;
    {
        Objid temp_id,init_id;
        int id,i;
        Boolean Mark=OPC_FALSE;
        char head[64]="cluster head";
        char member[64]="member";
        char anotherhead[64]="another head";
        FIN(node_add())
        if(strcmp(FLAG,head)==0)
        {
init_id=op_id_from_name((op_topo_child(network_list_id,OPC_OBJTYPE_GENERIC,0)),OPC_OBJTYPE_COMP,"cluster head");
            temp_id=op_topo_child(init_id,OPC_OBJTYPE_GENERIC,0);
            op_ima_obj_attr_set(temp_id,"ID",ID);

```



```

    op_ima_obj_attr_set(temp_id,"distance",distance);
    op_ima_obj_attr_set(temp_id,"status",status);
    Mark=OPC_TRUE;
}
else
{if(strcmp(FLAG,member)==0)
{
init_id=op_id_from_name((op_topo_child(network_list_id,OPC_OBJTYPE_GENERIC,0)),OPC_OBJTYPE_COMP,"member_1");
for(i=0;i<=(node_list_size-1);i++)
{
temp_id=op_topo_child((init_id+2*i),OPC_OBJTYPE_GENERIC,0);

op_ima_obj_attr_get(temp_id,"ID",&id);
if(id==0)
{
op_ima_obj_attr_set(temp_id,"ID",ID);
op_ima_obj_attr_set(temp_id,"distance",distance);
op_ima_obj_attr_set(temp_id,"status",status);
Mark=OPC_TRUE;
break;
}
}
}
else
{
init_id=op_id_from_name((op_topo_child(network_list_id,OPC_OBJTYPE_GENERIC,0)),OPC_OBJTYPE_COMP,"anotherhead_1");
for(i=0;i<=(head_list_size-1);i++)
{
temp_id=op_topo_child((init_id+2*i),OPC_OBJTYPE_GENERIC,0);
op_ima_obj_attr_get(temp_id,"ID",&id);
if(id==0)

```

```

    {
        op_ima_obj_attr_set(temp_id,"ID",ID);
        op_ima_obj_attr_set(temp_id,"distance",distance);
        op_ima_obj_attr_set(temp_id,"status",status);
        op_ima_obj_attr_set(temp_id,"x_pos",xpos);
        op_ima_obj_attr_set(temp_id,"y_pos",ypos);
        Mark=OPC_TRUE;
        break;
    }
}
}
}
FRET(Mark);
}

```

```

/*****
*****
*****

```

this function is to record that having got a hello(heart_beat) signal from the cluster head, set the flag

```

*****
*****
*****/

```

```

void
got_a_hello(void)
{
    FIN(got_a_hello());
    node_number=node_number+1;
    FOUT;
}

```

```

/*****
*****
*****

```

this function is to make the node to be a head, send the hello message, update the

node_list , set the hello_beat timer

```
*****  
*****  
*****/
```

void

become_a_head(void)

{

FIN(become_a_head());

op_prg_odb_bkpt("become_a_head");

member_no=0;

op_ima_obj_attr_get(node_id,"x position",&x_pos);

op_ima_obj_attr_get(node_id,"y position",&y_pos);

node_add(node_id,0.0,1.0,x_pos,y_pos,"cluster head"); /*myself is a cluster head*/

wait_annou_time_ehndl=op_intrpt_schedule_self ((op_sim_time
()+op_dist_uniform(wait_annou_time)), WAIT_SEND_ANNOU_FLAG);

HAS_BEEN_HEAD=OPC_TRUE;

FOUT;

}

```
*****
```

```
*****
```

This function is for a node to join a cluster, record the information of the cluster head, set the relative timer

```
*****
```

```
*****/
```

void

join_a_cluster(void)

{

FIN(join_a_cluster())

op_sim_end("","","sad");

node_add(pkt_source_id_tem,pkt_source_distance_tem,1.0,x_pos,y_pos,"cluster head");

FOUT;

```

}
/*****
*****

```

This function is for a head to send a "begin" message of steady_state to all members

```

*****
*****/

```

```

void
beginsteady(void)
{
    FIN(beginsteady())
    pkt_send(ALL_NODE,BEGINSTEADY);
    info_count=0;
    FOUT;
}

```

```

/*****

```

This function is to get the head ID of my cluster

```

*****/

```

Objid

```

    get_my_head(void)
{
    Objid temp_id,id;
    FIN(get_my_head())
temp_id=op_topo_child(op_id_from_name((op_topo_child(network_list_id,OPC_OBJTYPE_GENERIC,0)),OPC_OBJTYPE_COMP,"cluster
head"),OPC_OBJTYPE_GENERIC,0);
    op_ima_obj_attr_get(temp_id,"ID",&id);
    FRET(id);
}

```

```

/*****
*****

```

this function instantly record the incoming packet's power, in order to calculate the distance from the souece node

```

*****
*****/

static void
    pkt_power_update(void)
    {
        FIN(pkt_power_update(void));
        pkt_power=op_stat_local_read(IN_STAT);
        FOUT;
    }

/*****
*****
*****/

```

this function is to destroy a pkt that is no need, when the node is not actually start to detect the channel

```

*****
*****
*****/

void
    pkt_destroy(void)
    {
        Packet* pkptr;
        FIN(pkt_destroy());
        pkptr = op_pk_get (op_intrpt_strm ());
        op_pk_destroy (pkptr);
        FOUT;
    }

/*****
*****

```

this function is to update the network status when the node goes back to idle

```

*****

```

```

*****/
void
back_to_idle(FLAG)
    char FLAG[64];
    {
    Objid temp_id,init_id;
    int i;
    char head[64]="cluster head";
    char member[64]="member";
    FIN(back_to_idle(FLAG));
        if(strcmp(FLAG,head)==0)
            {
init_id=op_id_from_name((op_topo_child(network_list_id,OPC_OBJTYPE_GENER
IC,0)),OPC_OBJTYPE_COMP,"cluster head");
                for(i=0;i<=40;i++)
                    {
temp_id=op_topo_child((init_id+2*i),OPC_OBJTYPE_GENERIC,0);
                    op_ima_obj_attr_set(temp_id,"ID",0);
                    op_ima_obj_attr_set(temp_id,"distance",0.0);
                    op_ima_obj_attr_set(temp_id,"status",0.0);
                    op_ima_obj_attr_set(temp_id,"x_pos",0.0);
                    op_ima_obj_attr_set(temp_id,"y_pos",0.0);
                    }
                    /*op_ev_cancel(time_up_2_ehdl);*/
                }
            else
                {
                    init_id=op_id_from_name((op_topo_child(network_list_id,OPC_OBJTYPE_GE
NERIC,0)),OPC_OBJTYPE_COMP,"cluster head");
                    for(i=0;i<=40;i++)
                        {
temp_id=op_topo_child((init_id+2*i),OPC_OBJTYPE_GENERIC,0);
                            op_ima_obj_attr_set(temp_id,"ID",0);

```

```

    op_ima_obj_attr_set(temp_id,"distance",0.0);
    op_ima_obj_attr_set(temp_id,"status",0.0);
    op_ima_obj_attr_set(temp_id,"x_pos",0.0);
    op_ima_obj_attr_set(temp_id,"y_pos",0.0);
    }
    pkt_source_distance_tem=0;
    /*op_ev_cancel(send_info_time_ehndl);*/
    }
    pkt_send(ALL_NODE,HELLO);
FOUT;
}

/*****
*****
this function is to schedule an interupt when the node waits to join
*****
*****/

void
wait_to_join(void)
{
    FIN(wait_to_join())
    time_up_3_ehndl=op_intrpt_schedule_self ((op_sim_time () +
time_up_3), WAIT_ANNOU_TIME_FLAG);
    FOUT;
}

/*****
*****
this function is to schedule an interupt to send JOIN to the head
*****
*****/

void
wait_for_msg(void)
{
    FIN(wait_for_msg())

```

```

        send_join_time_ehdl=op_intrpt_schedule_self((op_sim_time() +
op_dist_uniform(send_join_time)), SEND_JOIN_TIME_FLAG);
        time_up_4_ehdl=op_intrpt_schedule_self ((op_sim_time () +
time_up_4), MSG_ACK_TIME_FLAG);
        FOUT;
    }

```

```

/*****

```

```

*****

```

```

this function is to find the member number in the netlist

```

```

*****

```

```

*****/

```

```

int

```

```

node_find_no(ID)

```

```

    Objid ID;

```

```

    {

```

```

        Objid temp_id,init_id;

```

```

        int id,i;

```

```

        int found_no=0;

```

```

        FIN(node_find_no())

```

```

init_id=op_id_from_name((op_topo_child(network_list_id,OPC_OBJTYPE_GENER
IC,0)),OPC_OBJTYPE_COMP,"cluster head");

```

```

    for(i=0;i<=node_list_size;i++)

```

```

    {

```

```

        temp_id=op_topo_child((init_id+2*i),OPC_OBJTYPE_GENERIC,0);

```

```

        op_ima_obj_attr_get(temp_id,"ID",&id);

```

```

        if(id==ID)

```

```

        {

```

```

            found_no=i;

```

```

            break;

```

```

        }

```

```

    }

```

```

    FRET(found_no);

```



```

    }
    /**
    *****
    this function is to send information to BS
    *****
    *****/
    /*void
    send_BS()
    {
    FIN(send_BS())
        tem_energy_consumption=energy_consumption;
        energy_consumption=energy_consumption+l*Eda*(info_count+1);
        op_stat_write(energy_hndl,energy_consumption);
        if((energy_consumption>=T_E)&&(tem_energy_consumption<T_E))
            {
            No_live_nodes=No_live_nodes-1;
            op_stat_write(No_live_nodes_hndl,No_live_nodes);
            }
        else
            {
            op_stat_write(No_live_nodes_hndl,No_live_nodes);
            }
        pkt_send(BS_id,INFO);
        send_begin_time_ehndl=op_intrpt_schedule_self((op_sim_time()
send_begin_time), SEND_BEGIN_TIME_FLAG);
        FOUT;
    }*/
    void
    send_MDC()
    {
        double temp_energy;
        FIN(send_MDC())

```

```

// if(MDC_ID!=OPC_OBJID_INVALID)
    {
        tem_energy_consumption=energy_consumption;
        temp_energy=1*Eda*(info_count+1);
        energy_consumption=energy_consumption+temp_energy;
        op_stat_write(energy_hndl,energy_consumption);
        op_stat_write(totalenergy_gstathandle,temp_energy);
        if((energy_consumption>=T_E)&&(tem_energy_consumption<T_E))
            {
                No_live_nodes=No_live_nodes-1;
                op_stat_write(No_live_nodes_hndl,No_live_nodes);
            }
        else
            {
                op_stat_write(No_live_nodes_hndl,No_live_nodes);
            }
        op_stat_write (packet_send_stathandle,1);
        pkt_send(BS_i,INFO);
    }
    send_begin_time_ehndl=op_intrpt_schedule_self((op_sim_time() +
send_begin_time), SEND_BEGIN_TIME_FLAG);
    FOUT;
}

```

Init Enter Exec

```

/* get the objid of the generator process module */
self_id = op_id_self ();
node_id = op_topo_parent(self_id);
subnet_id = op_topo_parent(node_id);
//BS_i = op_id_from_name(subnet_id,OPC_OBJTYPE_NODE_MOB,"MDC1");
D=BS_i = op_id_from_name(subnet_id,OPC_OBJTYPE_NODE_FIX,"BS");
//MDC_ID=op_id_from_name(subnet_id,OPC_OBJTYPE_NODE_MOB,"mobile
_node_41");

```

```

op_ima_obj_attr_get (BS_i, "x position", &BSx);
op_ima_obj_attr_get (BS_i, "y position", &BSy);
op_ima_obj_attr_get (node_id, "Network Status", &network_list_id);
xmt_id=op_id_from_name (node_id, OPC_OBJTYPE_RATX, "radio_xmt");
rcv_id=op_id_from_name (node_id, OPC_OBJTYPE_RARX, "radio_rcv");
HAS_BEEN_HEAD=OPC_FALSE;
round_no=0;
head_number=5;
node_number=40;
pkt_source_distance_tem=0;
energy_consumption=0;
op_prg_odb_bkpt ("init");
/* read the promoted attributes at run time */
op_ima_obj_attr_get (node_id, "start time delay", &start_time_delay);
op_ima_obj_attr_get (node_id, "time up 1", &time_up_1);
op_ima_obj_attr_get (node_id, "time up 2", &time_up_2);
op_ima_obj_attr_get (node_id, "time up 3", &time_up_3);
op_ima_obj_attr_get (node_id, "time up 4", &time_up_4);
op_ima_obj_attr_get (node_id, "round time", &round_time);
op_ima_obj_attr_get (node_id, "slot time", &slot_time);
op_ima_obj_attr_get (node_id, "wait annou time", &wait_annou_time);
op_ima_obj_attr_get (node_id, "send join time", &send_join_time);
op_ima_obj_attr_get (node_id, "send begin time", &send_begin_time);
op_ima_obj_attr_get (self_id, "packet format", pk_format_str);
op_ima_obj_attr_get (self_id, "information packet format",
info_pkt_format);
/* load the pkt generation distribution */
/*pkt_source_distance_hndl=op_stat_reg ("node_distance", OPC_STAT_INDEX_
NONE, OPC_STAT_LOCAL);
member_number_hndl=op_stat_reg ("number of
members", OPC_STAT_INDEX_NONE, OPC_STAT_GLOBAL);*/
ete_delay_hndl=op_stat_reg ("ETE
Delay(s)", OPC_STAT_INDEX_NONE, OPC_STAT_LOCAL);

```

```

energy_hndl=op_stat_reg("Energy
Consumption(J)",OPC_STAT_INDEX_NONE,OPC_STAT_LOCAL);
No_live_nodes_hndl=op_stat_reg("Num          of          live
nodes",OPC_STAT_INDEX_NONE,OPC_STAT_GLOBAL);
packet_send_stathandle=op_stat_reg("Num          of          Packets
Send",OPC_STAT_INDEX_NONE,OPC_STAT_GLOBAL);
totalenergy_gstathandle=op_stat_reg("Total Energy Consume by all
nodes",OPC_STAT_INDEX_NONE,OPC_STAT_GLOBAL);
/* calculate the random time for generating the next pkt */
/*rand_time = op_dist_uniform (start_time_delay);
/*op_intrpt_schedule_self      (op_sim_time      ()      +      node_id,
START_TIME_DELAY_FLAG);*/
op_intrpt_schedule_self      (op_sim_time      ()      +      start_time_delay,
START_TIME_DELAY_FLAG);
first=0;
last=0;
table=op_stat_reg("Table",OPC_STAT_INDEX_NONE,OPC_STAT_LOCAL);

got msg 1 Enter exec
pkptr=op_pk_get(op_intrpt_strm());
op_pk_nfd_get(pkptr,"source_address",&source_id);
/*the packet is not from own transmitter*/
/*calculate the distance from the source node to the target node basing on the
path loss model,suppose all node transmit in the same power level */
/*basing on the isotropic antenna, the Gain of all directions are 0 dB, assume
the inband power is the same as own power*/
base_freq=op_td_get_dbl(pkptr,OPC_TDA_RA_TX_FREQ);
bandwidth=op_td_get_dbl(pkptr,OPC_TDA_RA_TX_BW);
/*suppose each node transmit the signal in the same level, so we can
evaluate the originally transmitted power by getting each node's own transmit power*/
op_ima_obj_attr_get(xmt_id,"channel",&chan_id);
sub_chan_id=op_topo_child(chan_id,OPC_OBJTYPE_RATXCH,0);
op_ima_obj_attr_get(sub_chan_id,"power",&own_power);

```

```

/*****
*****/

center_freq=base_freq+(bandwidth/2.0);
lambda=( C_speed/center_freq);
pkt_source_distance=sqrt((lambda*lambda*own_power)/(SIXTEEN_PI_SQ*pkt_po
wer));

/*****
*****/

/*****
*****
record the contend of the packet
*****/

op_pk_nfd_get(pkptr,"dest_address",&pkt_dest_id);
op_pk_nfd_get(pkptr,"msg_type",&pkt_message);
/*op_pk_nfd_get(pkptr,"status",&pkt_status);*/
pkt_source_id=source_id;
/*message type analysis*/
/*if(pkt_message==HELLO)
{
node_number=node_number+1;
}*/
op_pk_destroy (pkptr);

```

Tem Enter Exec

```

if(HAS_BEEN_HEAD==OPC_TRUE)
{
DIRECT_BECOME_A_HEAD=OPC_FALSE;
}
else
{
prob_to_head=(double)(head_number)/(double)(node_number-
head_number*(round_no%8-1));
try_dist_ptr=op_dist_load("bernoulli",prob_to_head,0.0);
DIRECT_BECOME_A_HEAD=op_dist_outcome (try_dist_ptr);

```

```

    }
    pkt_source_distance_tem=0;
    pkt_source_id_tem=0;
    MDC_distance=0;
    if(No_live_nodes==39 && first ==0)
    {
        first=1;
        op_stat_write(table,round_no);
    }
    if(No_live_nodes==0 && last ==0)
    {
        last=1;
        op_stat_write(table,round_no);
    }
    if(No_live_nodes<6 && No_live_nodes>0)
    {
        op_stat_write(table,round_no);
    }

```

Wait to join Enter exec

```

if(No_live_nodes==39 && first ==0)
{
    first=1;
    op_stat_write(table,round_no);
}
if(No_live_nodes==0 && last ==0)
{
    last=1;
    op_stat_write(table,round_no);
}

```

Got annou Enter exec

```
if(No_live_nodes==39 && first ==0)
{
    first=1;
    op_stat_write(table,round_no);
}
if(No_live_nodes==0 && last ==0)
{
    last=1;
    op_stat_write(table,round_no);
}
```

Got msg 3 Enter Exec

```
pkptr=op_pk_get(op_intrpt_strm());
op_pk_nfd_get(pkptr,"source_address",&pkt_source_id);
/*the packet is not from own transmitter*/
/*calculate the distance from the source node to the target node basing on the
path loss model,suppose all node transmit in the same power level */
/*basing on the isotropic antenna, the Gain of all directions are 0 dB, assume
the inband power is the same as own power*/
base_freq=op_td_get_dbl(pkptr,OPC_TDA_RA_TX_FREQ);
bandwidth=op_td_get_dbl(pkptr,OPC_TDA_RA_TX_BW);
/*suppose each node transmit the signal in the same level, so we can
evaluate the originally transmitted power by getting each node's own transmit power*/
op_ima_obj_attr_get(xmt_id,"channel",&chan_id);
sub_chan_id=op_topo_child(chan_id,OPC_OBJTYPE_RATXCH,0);
op_ima_obj_attr_get(sub_chan_id,"power",&own_power);
/*****
*****/
center_freq=base_freq+(bandwidth/2.0);
lambda=( C_speed/center_freq);
pkt_source_distance=sqrt((lambda*lambda*own_power)/(SIXTEEN_PI_SQ*pkt_
```

```

power));
    /**
    *****/
    /**
    *****/
    record the contend of the packet
    *****/
    op_pk_nfd_get(pkptr,"dest_address",&pkt_dest_id);
    op_pk_nfd_get(pkptr,"msg_type",&pkt_message);
    // op_pk_nfd_get(pkptr,"status",&pkt_status);
    /*message type analysis*/
        if(pkt_message==ANNOU)
            {
                IS_A_ANNOU_FLAG=OPC_TRUE;
if((pkt_source_distance>pkt_source_distance_tem)&&(pkt_source_distance_tem!=0))
                {
                    pkt_source_id=pkt_source_id_tem;
                }
            else
                {
                    pkt_source_distance_tem=pkt_source_distance;
                    pkt_source_id_tem=pkt_source_id;
                }
            /*ete_delay=0;
            ete_delay=(op_sim_time()-op_pk_creation_time_get(pkptr));
            op_stat_write(ete_delay_hndl,ete_delay);*/
            }
    pkt_source_id=pkt_source_id_tem;
    pkt_source_distance=pkt_source_distance_tem;
    op_pk_destroy (pkptr);

```

Got msg 4 Enter exec

```

pkptr=op_pk_get(op_intrpt_strm());
op_pk_nfd_get(pkptr,"source_address",&source_id);

```



```

/*the packet is not from own transmitter*/
/*calculate the distance from the source node to the target node basing on the
path loss model,suppose all node transmit in the same power level */
/*basing on the isotropic antenna, the Gain of all directions are 0 dB, assume
the inband power is the same as own power*/
base_freq=op_td_get_dbl(pkptr,OPC_TDA_RA_TX_FREQ);
bandwidth=op_td_get_dbl(pkptr,OPC_TDA_RA_TX_BW);
/*suppose each node transmit the signal in the same level, so we can
evaluate the originally transmitted power by getting each node's own transmit power*/
op_ima_obj_attr_get(xmt_id,"channel",&chan_id);
sub_chan_id=op_topo_child(chan_id,OPC_OBJTYPE_RATXCH,0);
op_ima_obj_attr_get(sub_chan_id,"power",&own_power);
/*****
*****/
center_freq=base_freq+(bandwidth/2.0);
lambda=( C_speed/center_freq);
pkt_source_distance=sqrt((lambda*lambda*own_power)/(SIXTEEN_PI_SQ*pkt_
power));
/*****
*****/
/*record the contend of the packet
*****/
/*message type analysis*/
if((pkt_message==MSG_ACK) && (pkt_dest_id==node_id))
{
op_sim_end(““,”j”,”“,”“);
op_pk_nfd_get(pkptr,”dest_address",&pkt_dest_id);
op_pk_nfd_get(pkptr,”msg_type",&pkt_message);
op_pk_nfd_get(pkptr,”status",&pkt_status);
op_pk_nfd_get(pkptr,”x_pos",&x_pos);
op_pk_nfd_get(pkptr,”y_pos",&y_pos);
op_prg_odb_bkpt(“receive_msg”);

```

```

IS_A_MSG_ACK_FLAG=OPC_TRUE;
member_no=pkt_status;
if(op_prg_odb_ltrace_active("receive_msg"))
{
source_no=source_id-2;
node_no=node_id-2;
printf("node:mobile_node_%d,head:mobile_node_%d,
member_no=%f\n",node_no,source_no,member_no);
}
op_ev_cancel(time_up_4_ehndl);
op_ev_cancel(send_join_time_ehndl);
op_ima_obj_attr_get(xmt_id,"channel",&chan_id);
sub_chan_id=op_topo_child(chan_id,OPC_OBJTYPE_RATXCH,0);
op_ima_obj_attr_set(sub_chan_id,"spreading
code",(double)(source_id));
op_ima_obj_attr_get(rcv_id,"channel",&chan_id);
sub_chan_id=op_topo_child(chan_id,OPC_OBJTYPE_RARXCH,0);
op_ima_obj_attr_set(sub_chan_id,"spreading
code",(double)(source_id));
}
op_pk_destroy (pkptr);
Member Enter exec
if(No_live_nodes==39 && first ==0)
{
first=1;
op_stat_write(table,round_no);
}
if(No_live_nodes==0 && last ==0)
{
last=1;
op_stat_write(table,round_no);
}

```

Got msg 5 Enter exec

```
pkptr=op_pk_get(op_intrpt_strm());
op_pk_nfd_get(pkptr,"source_address",&source_id);
    /*the packet is not from own transmitter*/
    /*calculate the distance from the source node to the target node basing on the
path loss model,suppose all node transmit in the same power level */
    /*basing on the isotropic antenna, the Gain of all directions are 0 dB, assume
the inband power is the same as own power*/
    base_freq=op_td_get_dbl(pkptr,OPC_TDA_RA_TX_FREQ);
    bandwidth=op_td_get_dbl(pkptr,OPC_TDA_RA_TX_BW);
    /*suppose each node transmit the signal in the same level, so we can
evaluate the originally transmitted power by getting each node's own transmit power*/
    op_ima_obj_attr_get(xmt_id,"channel",&chan_id);
    sub_chan_id=op_topo_child(chan_id,OPC_OBJTYPE_RATXCH,0);
    op_ima_obj_attr_get(sub_chan_id,"power",&own_power);
    /***/
    /***/
    center_freq=base_freq+(bandwidth/2.0);
    lambda=( C_speed/center_freq);
    pkt_source_distance=sqrt((lambda*lambda*own_power)/(SIXTEEN_PI_SQ*pkt
power));
    /***/
    /***/
    /***/
    record the contend of the packet
    /***/
op_pk_nfd_get(pkptr,"dest_address",&pkt_dest_id);
op_pk_nfd_get(pkptr,"msg_type",&pkt_message);
/*op_pk_nfd_get(pkptr,"status",&pkt_status);*/
    pkt_source_id=source_id;
    /*message type analysis*/
    if(pkt_message==BEGINSTEADY)
        {
```

```

        op_prg_odb_bkpt("receive_beginsteady");
send_info_time=op_pk_creation_time_get(pkptr)+member_no*slot_time;
        if(op_prg_odb_ltrace_active("receive_beginsteady"))
        {
            node_no=node_id-2;
            source_no=source_id-2;
            printf("node:mobile_node_%d,
head:mobile_node_%d\n",node_no,source_no);

printf("member_no=%f,slot_time=%f\n",member_no,slot_time);
            printf("intrpt_time=%f\n",send_info_time);
        }
        send_info_time_ehndl=op_intrpt_schedule_self (send_info_time,
SEND_INFO_TIME_FLAG);
    }
    op_pk_destroy (pkptr);

```

Got msg 2 Enter exec

```

double temp_energy;
pkptr=op_pk_get(op_intrpt_strm());
op_pk_nfd_get(pkptr,"source_address",&source_id);
/*the packet is not from own transmitter*/
/*calculate the distance from the source node to the target node basing on the
path loss model,suppose all node transmit in the same power level */
/*basing on the isotropic antenna, the Gain of all directions are 0 dB, assume
the inband power is the same as own power*/
base_freq=op_td_get_dbl(pkptr,OPC_TDA_RA_TX_FREQ);
bandwidth=op_td_get_dbl(pkptr,OPC_TDA_RA_TX_BW);
/*suppose each node transmit the signal in the same level, so we can
evaluate the originally transmitted power by getting each node's own transmit power*/
op_ima_obj_attr_get(xmt_id,"channel",&chan_id);
sub_chan_id=op_topo_child(chan_id,OPC_OBJTYPE_RATXCH,0);
op_ima_obj_attr_get(sub_chan_id,"power",&own_power);

```

```

/*****
*****/

    center_freq=base_freq+(bandwidth/2.0);
    lambda=( C_speed/center_freq);
pkt_source_distance=sqrt((lambda*lambda*own_power)/(SIXTEEN_PI_SQ*pkt_po
wer));

/*****
*****/

/*****
*****/

    record the contend of the packet
*****/

    op_pk_nfd_get(pkptr,"dest_address",&pkt_dest_id);
    op_pk_nfd_get(pkptr,"msg_type",&pkt_message);
    pkt_source_id=source_id;
    if(pkt_message==BEACON_MESSAGE)
    {
        if((pkt_source_distance>MDC_distance)&&(MDC_distance!=0))
        {
            BS_i=BS_i;
            if(pkt_source_id==BS_i)
                MDC_distance=pkt_source_distance;
        }
        else
        {
            //op_sim_end("1","","");
            MDC_distance=pkt_source_distance;
            BS_i=pkt_source_id;
        }
        /*ete_delay=0;
        ete_delay=(op_sim_time()-op_pk_creation_time_get(pkptr));
        op_stat_write(ete_delay_hndl,ete_delay);*/
    }

/*message type analysis*/

```

```

if(pkt_dest_id==node_id)
{
    if(pkt_message==JOIN) /*a new node want to be added*/
    {
        op_prg_odb_bkpt("send_msg");
        if(node_find(pkt_source_id)==OPC_FALSE)
        {
            op_pk_nfd_get(pkptr,"status",&pkt_status);
            op_pk_nfd_get(pkptr,"x_pos",&x_pos);
            op_pk_nfd_get(pkptr,"y_pos",&y_pos);
            node_add(pkt_source_id,pkt_source_distance,1.0,x_pos,y_pos,"member");
            /*update the information*/
            member_no=member_no+1;
            pkt_send(pkt_source_id,MSG_ACK);
        }
        else
        {
            member_no_tem=member_no;
            member_no=node_find_no(pkt_source_id);
            pkt_send(pkt_source_id,MSG_ACK);
            member_no=member_no_tem;
        }
    }
    if(pkt_message==ANNOU) /*another head*/
    {
        op_pk_nfd_get(pkptr,"status",&pkt_status);
        op_pk_nfd_get(pkptr,"x_pos",&x_pos);
        op_pk_nfd_get(pkptr,"y_pos",&y_pos);
        node_add(pkt_source_id,pkt_source_distance,1.0,x_pos,y_pos,"another head");
        /*update the information*/
    }
    if(pkt_message==INFO) /*information*/

```

```

    {
    op_prg_odb_bkpt("receive_info");
    info_count=info_count+1;
    tem_energy_consumption=energy_consumption;
    temp_energy=l*Eelec;
    energy_consumption=energy_consumption+temp_energy;
    op_stat_write(totalenergy_gstathandle,temp_energy);
    op_stat_write(energy_hndl,energy_consumption);
    if(op_prg_odb_ltrace_active("receive_info"))
        {
            node_no=node_id-2;
            source_no=source_id-2;
            printf("node:mobile_node_%d,member:mobile_node_%d,info_count=%d\n",node
            _no,source_no,info_count);
        }
    ete_delay=0;
    ete_delay=(op_sim_time()-op_pk_creation_time_get(pkptr));
    op_stat_write(ete_delay_hndl,ete_delay);

if((energy_consumption>=T_E)&&(tem_energy_consumption<T_E))
    {
        No_live_nodes=No_live_nodes-1;
        op_stat_write(No_live_nodes_hndl,No_live_nodes);
    }
else
    {
        op_stat_write(No_live_nodes_hndl,No_live_nodes);
    }

    /*if(info_count>=member_no)
        {
energy_consumption=energy_consumption+l*Eda*(member_no+1);

```

```

        op_stat_write(energy_hndl,energy_consumption);
        pkt_send(BS_id,INFO);
        send_begin_time_ehdl=op_intrpt_schedule_self((op_sim_time()+send_begin_time), SEND_BEGIN_TIME_FLAG);
    }*/
}
}
op_pk_destroy (pkptr);

```

CSMA proc

Header Block

```

#define IN_STRM 0
#define OUT_STRM 0
#define CH_BUSY_STAT 0
#define HELLO 0
#define INFO 5
#define BEGINSTEADY 6
#define BEGSIM_INTRPT (op_intrpt_type() ==
OPC_INTRPT_BEGSIM)
#define PKT_ARVL (op_intrpt_type() == OPC_INTRPT_STRM)
#define CHAN_FREE (op_stat_local_read (CH_BUSY_STAT) == 0.0)
#define MORE_PKTS (!op_strm_empty (IN_STRM) ||
!op_subq_empty (0))
#define CHAN_GOES_FREE(op_intrpt_type() == OPC_INTRPT_STAT)
#define NO_MORE_PKTS (op_strm_empty (IN_STRM) &&
op_subq_empty (0))
#define WAIT_TIME_UP (op_intrpt_type () == OPC_INTRPT_SELF)

```

Function Block

```

/* if the channel is found busy, remove pkt from the
input stream and buffer it then set up the timer */
void
q_pkt_timer ()

```



```

    {
    Packet *pkptr;
    double rand_time;
    FIN (q_pkt_timer ())
    /*remove pkt from the strm*/
    pkptr = op_pk_get(IN_STRM);
    /*buffer pkt in the queue*/
    op_subq_pk_insert (0, pkptr, OPC_QPOS_TAIL);
    /*calculate the random time to wait till another transmission*/
    rand_time=op_dist_outcome(waiting_dist_ptr);
    /*schedule intrpt for the delivery of the next pkt*/
    op_intrpt_schedule_self(op_sim_time()+rand_time,0);
    FOUT
    }/* end q_pkt_timer() */
void
q_pkt ()
    {
    Packet *pkptr;
    FIN (q_pkt ())
    /*remove pkt from the strm*/
    pkptr = op_pk_get(IN_STRM);
    /*buffer pkt in the queue*/
    op_subq_pk_insert (0, pkptr, OPC_QPOS_TAIL);
    FOUT
    }/* end q_pkt() */
void
set_timer()
    {
    double rand_time;
    FIN(set_timer())
    /*calculate the random time to wait till another transmission*/
    rand_time=op_dist_outcome(waiting_dist_ptr);
    /*schedule intrpt for the delivery of the next pkt*/

```

```

op_intrpt_schedule_self(op_sim_time()+rand_time,0);
FOUT
}
/*end set_timer()*/

```

Init Enter exec

```

node_id = op_topo_parent(op_id_self());
/* get the statistics handles */
chan_access_local_handle = op_stat_reg ("Chan Access Delay (msec)",
OPC_STAT_INDEX_NONE, OPC_STAT_LOCAL);
chan_access_global_handle = op_stat_reg ("Chan Access Delay (msec)",
OPC_STAT_INDEX_NONE, OPC_STAT_GLOBAL);
own_id=op_id_self();
/*read the promoted attributes at run time*/
op_ima_obj_attr_get(own_id,"waiting time",&waiting_time);
op_ima_obj_attr_get(own_id,"try probability",&try_probability);
/*load the waiting time distribution*/
waiting_dist_ptr=op_dist_load("uniform",0.0,waiting_time);
try_dist_ptr=op_dist_load("bernoulli",try_probability,0.0);

```

XMT pkt Enter exec

```

/* check if there are packets in the buffer */
if (op_subq_empty (0) == OPC_FALSE)
{
/* remove pkt from the head of the queue */
pkptr = op_subq_pk_remove (0, OPC_QPOS_HEAD);
}/* end if */
else
{
/* get the packet from the input stream */
pkptr = op_pk_get (IN_STRM);
} /* end else */
/* determine and record channel acces delay */

```

```

chan_access_delay = op_sim_time () - op_pk_creation_time_get (pkptr);
op_stat_write (chan_access_global_handle, chan_access_delay * 1000.0);
op_stat_write (chan_access_local_handle, chan_access_delay * 1000.0);
/*op_pk_nfd_get(pkptr,"dest_address",&pkt_dest_id);
op_pk_nfd_get(pkptr,"msg_type",&pkt_message);
if(pkt_message==HELLO)
{
xmt_id=op_id_from_name(node_id,OPC_OBJTYPE_RATX,"radio_xmt");
op_ima_obj_attr_get(xmt_id,"channel",&chan_id);
sub_chan_id=op_topo_child(chan_id,OPC_OBJTYPE_RATXCH,0);
op_ima_obj_attr_set(sub_chan_id,"spreading
code",OPC_BOOLDBL_DISABLED);
rcv_id=op_id_from_name(node_id,OPC_OBJTYPE_RARX,"radio_rcv");
op_ima_obj_attr_get(rcv_id,"channel",&chan_id);
sub_chan_id=op_topo_child(chan_id,OPC_OBJTYPE_RARXCH,0);
op_ima_obj_attr_set(sub_chan_id,"spreading
code",OPC_BOOLDBL_DISABLED);
}
if(pkt_message==INFO)
{
xmt_id=op_id_from_name(node_id,OPC_OBJTYPE_RATX,"radio_xmt");
op_ima_obj_attr_get(xmt_id,"channel",&chan_id);
sub_chan_id=op_topo_child(chan_id,OPC_OBJTYPE_RATXCH,0);
op_ima_obj_attr_set(sub_chan_id,"spreading code",&pkt_dest_id);
}
if(pkt_message==BEGINSTEADY)
{
xmt_id=op_id_from_name(node_id,OPC_OBJTYPE_RATX,"radio_xmt");
op_ima_obj_attr_get(xmt_id,"channel",&chan_id);
sub_chan_id=op_topo_child(chan_id,OPC_OBJTYPE_RATXCH,0);
op_ima_obj_attr_set(sub_chan_id,"spreading code",&node_id);
rcv_id=op_id_from_name(node_id,OPC_OBJTYPE_RARX,"radio_rcv");
op_ima_obj_attr_get(rcv_id,"channel",&chan_id);

```

```

sub_chan_id=op_topo_child(chan_id,OPC_OBJTYPE_RARXCH,0);
op_ima_obj_attr_set(sub_chan_id,"spreading code",&node_id);
}*/
/*send the pkt to the transmitter*/
/*filter the suitable destinate nodes*/
xmt_id=op_id_from_name(node_id,OPC_OBJTYPE_RATX,"radio_xmt");
op_ima_obj_attr_get(xmt_id,"channel",&chan_id);
sub_chan_id=op_topo_child(chan_id,OPC_OBJTYPE_RATXCH,0);
op_radio_txch_rxgroup_compute(sub_chan_id,OPC_TXCH_RXGROUP_PS);
op_pk_send (pkptr, OUT_STRM);

```

Mobility

Temporary Variables

```

double rand_time;
double direction;

```

Header Block

```

#define WAIT_TIME_UP (op_intrpt_type () == OPC_INTRPT_SELF)

```

Init Enter exec

```

/*initial the phase of the direction*/
phase=60;
present_direction=0;
/*obtain the parent node's object ID.*/
self_id=op_id_self();
node_id=op_topo_parent(self_id);
/*get the user specified ground_speed and the ascending rate*/
op_ima_obj_attr_get(node_id,"ground_speed",&speed);
/*op_ima_obj_attr_get(node_id,"ascent_rate",&ascent_rate);*/
/*set the initial ground_speed and the ascending rate of the node*/
op_ima_obj_attr_set(node_id,"ground speed",speed);
/* Load PDF for bearing direction */
bearing_dist_ptr = op_dist_load("xiang_sun_mobile_pdf", 0, 0);

```

```
time_interval_dist_ptr= op_dist_load("exponential",1.0,0.0);
```

Wait Enter exec

```
/*get the random bearing direction of node*/
```

```
direction=op_dist_outcome(bearing_dist_ptr);
```

```
direction=direction*phase;
```

```
present_direction=present_direction+direction;
```

```
if(present_direction<0)
```

```
{
```

```
    present_direction=(360+present_direction);
```

```
}
```

```
if(present_direction>=360)
```

```
{
```

```
    present_direction=(present_direction-360);
```

```
}
```

```
/*set the bearing direction fo the node*/
```

```
op_ima_obj_attr_set(node_id,"bearing",present_direction);
```

```
/*calculate the random time to wait till another transmission*/
```

```
rand_time=op_dist_outcome(time_interval_dist_ptr);
```

```
/*schedule intrpt for the delivery of the next pkt*/
```

```
op_intrpt_schedule_self(op_sim_time()+rand_time,0);
```

APPENDIX B

CODE FOR MOBILE DATA COLLECTOR BASED ROUTING PROTOCOL

BASE STATION

BS PROCESSING

Temporary Variables

```
Packet*   pkptr;
double    pk_size;
double    ete_delay;
```

Header Block

```
#define   DEFAULT_PKT_ARVL (op_intrpt_type()==OPC_INTRPT_STRM)
#define   HELLO           0
#define   ANNOU           1
#define   JOIN            2
#define   DISCONNECT     3
#define   MSG_ACK        4
#define   INFO           5
#define   BEGINSTEADY    6
#define   BEACON_MESSAGE 7
int No_live_nodes=40;
int No_live_m_nodes=2;
```

Init Enter exec

```
self_id = op_id_self ();
node_id = op_topo_parent(self_id);
rcv_id=op_id_from_name(node_id,OPC_OBJTYPE_RARX,"radio_rcv");
pk_count=0;
pk_ct=op_stat_reg("pk ct",OPC_STAT_INDEX_NONE,OPC_STAT_LOCAL);
/* Initilaize the statistic handles to keep */
/* track of traffic sinked by this process. */
bits_rcvd_stathandle = op_stat_reg ("Traffic Sink.Traffic Received (bits)",
```

```

        OPC_STAT_INDEX_NONE, OPC_STAT_LOCAL);
    bitssec_rcvd_stathandle = op_stat_reg ("Traffic Sink.Traffic Received
(bits/sec)", OPC_STAT_INDEX_NONE, OPC_STAT_LOCAL);
    pkts_rcvd_stathandle = op_stat_reg ("Traffic Sink.Traffic Received
(packet)", OPC_STAT_INDEX_NONE, OPC_STAT_LOCAL);
    pktssec_rcvd_stathandle = op_stat_reg ("Traffic Sink.Traffic Received
(packet/sec)", OPC_STAT_INDEX_NONE, OPC_STAT_LOCAL);
    ete_delay_stathandle = op_stat_reg ("Traffic Sink.End-to-End Delay
(seconds)", OPC_STAT_INDEX_NONE, OPC_STAT_LOCAL);
    bits_rcvd_gstathandle = op_stat_reg ("Traffic Sink.Traffic Received
(bits)", OPC_STAT_INDEX_NONE, OPC_STAT_GLOBAL);
    bitssec_rcvd_gstathandle = op_stat_reg ("Traffic Sink.Traffic Received
(bits/sec)", OPC_STAT_INDEX_NONE, OPC_STAT_GLOBAL);
    pkts_rcvd_gstathandle = op_stat_reg ("Traffic Sink.Traffic Received
(packet)", OPC_STAT_INDEX_NONE, OPC_STAT_GLOBAL);
    pktssec_rcvd_gstathandle = op_stat_reg ("Traffic Sink.Traffic Received
(packet/sec)", OPC_STAT_INDEX_NONE, OPC_STAT_GLOBAL);
    ete_delay_gstathandle = op_stat_reg ("Traffic Sink.End-to-End Delay
(seconds)", OPC_STAT_INDEX_NONE, OPC_STAT_GLOBAL);
    PIAT= op_stat_reg ("Packet Inter Arrival Rate",OPC_STAT_INDEX_NONE,
OPC_STAT_GLOBAL);
    prev=-1;
    // op_ima_obj_attr_get(rcv_id,"channel",&chan_id);
        // sub_chan_id=op_topo_child(chan_id,OPC_OBJTYPE_RARXCH,0);
        // op_ima_obj_attr_set(sub_chan_id,"spreading code",(double)(node_id));
    //

```

Msg receive Enter exec

```

double interval=0.0;
pkptr = op_pk_get (op_intrpt_strm ());
op_pk_nfd_get(pkptr,"dest_address",&pkt_dest_id);
op_pk_nfd_get(pkptr,"msg_type",&pkt_message);
if(pkt_dest_id==node_id)

```

```

    {
        //op_sim_end("as1","c","c","c");
        pk_size = (double) op_pk_total_size_get (pkptr);
        ete_delay = op_sim_time () - op_pk_creation_time_get (pkptr);
        op_stat_write (bits_rcvd_stathandle,    pk_size);
        op_stat_write (pkts_rcvd_stathandle,    1.0);
        op_stat_write (ete_delay_stathandle,    ete_delay);

        op_stat_write (bitssec_rcvd_stathandle, pk_size);
        op_stat_write (bitssec_rcvd_stathandle, 0.0);
        op_stat_write (pktssec_rcvd_stathandle, 1.0);
        op_stat_write (pktssec_rcvd_stathandle, 0.0);
        /* Update global statistics.    */
        op_stat_write (bits_rcvd_gstathandle,    pk_size);
        op_stat_write (pkts_rcvd_gstathandle,    1.0);
        op_stat_write (ete_delay_gstathandle,    ete_delay);
        op_stat_write (bitssec_rcvd_gstathandle, pk_size);
        op_stat_write (bitssec_rcvd_gstathandle, 0.0);
        op_stat_write (pktssec_rcvd_gstathandle, 1.0);
        op_stat_write (pktssec_rcvd_gstathandle, 0.0);
        cur= op_sim_time ();
        if(prev!=-1)
            {
                interval=cur-prev;
                op_stat_write (PIAT,interval);
            }
        else
            {
                op_stat_write (PIAT,0);
            }
        prev=cur;
    }
    op_pk_destroy(pkptr);

```

APPENDIX C

CODE FOR MOBILE DATA COLLECTOR BASED ROUTING PROTOCOL

MOBILE DATA COLLECTOR

PROCESS STATE

Temporary Variables

```
Packet*   pkptr;
double    pk_size;
double    ete_delay;
Objid     chan_id,sub_chan_id;
int source_id;
```

Header Block

```
#include<math.h>
#define   OUT_STRM 0
#define   IN_STAT 0
#define   HELLO      0
#define   ANNOU      1
#define   JOIN        2
#define   DISCONNECT  3
#define   MSG_ACK     4
#define   INFO        5
#define   BEGINSTEADY  6
#define   BEACON_MESSAGE  7
#define   ALL_NODE    0
#define   Time_Beacon_Msg_FLAG  11
#define   DEFAULT_PKT_ARVL (op_intrpt_type()==OPC_INTRPT_STRM)
#define   Beacon_msg_send_time ((op_intrpt_type()==OPC_INTRPT_SELF)
&& (op_intrpt_code()==Time_Beacon_Msg_FLAG))
extern int No_live_m_nodes;
#define   T_E  30
```

Function Block

```
# define      Efs      1e-11
# define      Emp      1.3e-15
# define      Eelec    5e-8
# define      Eda      5e-9
# define      I        184

static void
pkt_send (target_id,content)
    Objid target_id;
    int content;
    {
    Packet*      pkptr;
    int          pkt_size;
    double       intx_pos,inty_pos;
    Objid        chan_id,sub_chan_id;
    FIN (pkt_send ());
    if(content!=INFO)
        {
        pkptr = op_pk_create_fmt ("xiang_sun_ultimate_packet");
        /*Enter the specific value for the source_address in the packet*/
        /*find the parent object ID of source*/
        op_pk_nfd_set(pkptr,"source_address",node_id);
        op_pk_nfd_set(pkptr,"dest_address",target_id);
        op_pk_nfd_set(pkptr,"msg_type",content);
        op_ima_obj_attr_get(node_id,"x position",&x_pos);
        op_ima_obj_attr_get(node_id,"y position",&y_pos);
        op_pk_nfd_set(pkptr,"x_pos",x_pos);
        op_pk_nfd_set(pkptr,"y_pos",y_pos);
        }
    else
        {
        pkptr=op_pk_create_fmt("information_packet");
        //op_sim_end("yes BS",,"","");
        }
```

```

    pkt_size=160;
    op_pk_bulk_size_set (pkptr, pkt_size);
    op_pk_nfd_set(pkptr,"source_address",node_id);
    op_pk_nfd_set(pkptr,"dest_address",target_id);
    op_pk_nfd_set(pkptr,"msg_type",content);
    op_ima_obj_attr_get(node_id,"x position",&x_pos);
    op_ima_obj_attr_get(node_id,"y position",&y_pos);
    /*op_pk_bcast_unique(pkptr,target_id);*/
    op_ima_obj_attr_get(xmt_id,"channel",&chan_id);
    sub_chan_id=op_topo_child(chan_id,OPC_OBJTYPE_RATXCH,0);
    op_ima_obj_attr_set(sub_chan_id,"spreading code",(double)(target_id));
    op_ima_obj_attr_get(rcv_id,"channel",&chan_id);
    sub_chan_id=op_topo_child(chan_id,OPC_OBJTYPE_RARXCH,0);
    op_ima_obj_attr_set(sub_chan_id,"spreading code",(double)(target_id));
    op_ima_obj_attr_get(target_id,"x position",&intx_pos);
    op_ima_obj_attr_get(target_id,"y position",&inty_pos);
}
if(content==BEACON_MESSAGE)
{
    op_pk_nfd_set(pkptr,"remaining_enregy",energy_consumption);op_intrpt_sch
edule_self (op_sim_time () + 5, Time_Beacon_Msg_FLAG);
}
/* send the pkt to the output stream */
op_pk_send (pkptr, OUT_STRM);
FOUT;
}
void
send_BS()
{
    FIN(send_BS())
    pkt_send(BS_id, INFO );
    FOUT;
}

```

Init Enter exec

```
//op_prg_odb_bkpt("BS");
self_id = op_id_self ();
node_id = op_topo_parent(self_id);
subnet_id = op_topo_parent(node_id);
BS_id = op_id_from_name(subnet_id,OPC_OBJTYPE_NODE_FIX,"BS");
if(BS_id==OPC_OBJID_INVALID)
op_sim_end("End","","");
op_ima_obj_attr_get (BS_id, "x position", &BSx);
op_ima_obj_attr_get (BS_id, "y position", &BSy);
rcv_id=op_id_from_name(node_id,OPC_OBJTYPE_RARX,"radio_rcv");
xmt_id=op_id_from_name(node_id,OPC_OBJTYPE_RATX,"radio_xmt");
op_ima_obj_attr_get(rcv_id,"channel",&chan_id);
sub_chan_id=op_topo_child(chan_id,OPC_OBJTYPE_RARXCH,0);
op_ima_obj_attr_set(sub_chan_id,"spreading code",(double)(node_id));
pk_count=0;
pk_ct=op_stat_reg("pk ct",OPC_STAT_INDEX_NONE,OPC_STAT_LOCAL);
op_intrpt_schedule_self (op_sim_time () + 1, Time_Beacon_Msg_FLAG);
No_live_mob_nodes_hdl=op_stat_reg("Num of live mobiles
nodes",OPC_STAT_INDEX_NONE,OPC_STAT_GLOBAL);
energy_hdl=op_stat_reg("Energy
Consumption(J)",OPC_STAT_INDEX_NONE,OPC_STAT_LOCAL);
```

Msg receive Enter exec

```
double distance2;
/* Obtain the incoming packet. */
pkptr = op_pk_get (op_intrpt_strm ());
op_pk_nfd_get(pkptr,"source_address",&source_id);
op_pk_nfd_get(pkptr,"dest_address",&pkt_dest_id);
op_pk_nfd_get(pkptr,"msg_type",&pkt_message);
/* Caclulate metrics to be updated. */
pk_size = (double) op_pk_total_size_get (pkptr);
ete_delay = op_sim_time () - op_pk_creation_time_get (pkptr);
```

```

if(pkt_dest_id==node_id)
{
++pk_count;
tem_energy_consumption=energy_consumption;
energy_consumption=energy_consumption+l*Eelec;
op_stat_write(energy_hndl,energy_consumption);
if((energy_consumption>=T_E)&&(tem_energy_consumption<T_E))
{
No_live_m_nodes=No_live_m_nodes-1;
op_stat_write(No_live_mob_nodes_hndl,No_live_m_nodes);
}
else
{
op_stat_write(No_live_mob_nodes_hndl,No_live_m_nodes);
}
op_ima_obj_attr_get(node_id,"x position",&x_pos);
op_ima_obj_attr_get(node_id,"y position",&y_pos);
distance2=pow((x_pos-BSx),2)+pow((y_pos-BSy),2);
tem_energy_consumption=energy_consumption;
energy_consumption=energy_consumption+l*(Eelec+Efs*distance2);
op_stat_write(energy_hndl,energy_consumption);
if((energy_consumption>=T_E)&&(tem_energy_consumption<T_E))
{
No_live_m_nodes=No_live_m_nodes-1;
op_stat_write(No_live_mob_nodes_hndl,No_live_m_nodes);
}
else
{
op_stat_write(No_live_mob_nodes_hndl,No_live_m_nodes);
}
op_pk_nfd_set(pkptr,"source_address",node_id);
op_pk_nfd_set(pkptr,"dest_address",BS_id);
//op_ima_obj_attr_get(xmt_id,"channel",&chan_id);

```

```
//sub_chan_id=op_topo_child(chan_id,OPC_OBJTYPE_RATXCH,0);
//op_ima_obj_attr_set(sub_chan_id,"spreading code",(double)(BS_id));
op_pk_send (pkptr, OUT_STRM);
//send_BS();
op_stat_write(pk_ct,pk_count);
}

//op_sim_end("yes","","");
/* Update local statistics.*/
/* Destroy the received packet.*/
//op_pk_destroy (pkptr);
```