

CERTIFICATION OF APPROVAL

THE EFFECT OF TRAFFIC LIGHT COUNTDOWN TIMER ON RED LIGHT RUNNING

by

Laila Binti Che Long

**A project dissertation submitted to the
Civil Engineering Programme
Universiti Teknologi PETRONAS
in partial fulfilment of the requirement for the
Bachelor of Engineering (Hons)
(Civil Engineering)**

Approved by,



ASSOC. PROF. DR. MADZLAN NAPIAH
Project Supervisor

**UNIVERSITI TEKNOLOGI PETRONAS
TRONOH, PERAK**

June 2006

CERTIFICATION OF ORIGINALITY

This is to certify that I am responsible for the work submitted in this project, that the original work is my own except as specified in the references and acknowledgements, and that the original work contained herein have not been undertaken or done by unspecified sources or persons.



Laila Binti Che Long

ACKNOWLEDGMENT

First of all, highest appreciation to Assoc. Prof. Dr Madzlan B Napiah, author's Final Year Project Supervisor from Civil Engineering Department; University Technology of Petronas for his constant guidance and taught in completing this project. Without his guidance the objective of this project cannot be successfully accomplished.

Author thank to Dr. Shamsul Abd Rahman Kutty, Lecturers of Civil Engineering Department; University Technology of Petronas for his guidance in author's analysis. Author appreciation also goes to Final Year Project Committee especially Miss Koh Moi Ing, the FYP coordinator for all her efforts in managing all FYP students in completing their tasks.

Thank also to the technician that helps in supplying the equipments. Finally, author would like to thank everybody who had helped me directly and indirectly throughout this project.

ABSTRACT

Red-light running occurs when a driver enters an intersection after the traffic signal has turned red. This situation then resolves to minor accidents and even lost of life. Due to this critical problem, countdown timer is installed at the traffic light with a hope to reduce the number of red light violent. However, the effect of this countdown timer to the red light running in Malaysia is never been studied. This project evaluated the case in detail and clarifies the findings. Two intersections are chosen which are with and without countdown timer that representing an upstream and a downstream. Three stations are identified, namely Station 1 (Intersection Balai Polis Pekan Baru), Station 2 (Intersection Silibin) and Station 3 (Intersection Pasir Puteh). Traffic survey is conducted by leaving the video camera at the right angle of the intersection to capture the intersection movements. The recorded data are run through a television to project the visual and traffic count is performed. The levels of service (LOS) of all the intersections involved in the traffic survey are obtained through aaSIDRA software. The percentages of red light running were derived from the data summary. The Chi-Square statistical analysis is carried out from those percentages. The statistical analysis shows that the effect of countdown timer on the number of red light running for Station 1 and Station 2, are not significant but shown a significant effect on Station 3 at 95% confidence level. By percentages, the road users who comply with the red light, cross the intersection during amber and violate the red light are approximately the same for both intersections with and without timer at Station 1. The percentages of road users who violate the red light and cross the intersection during amber were approximately reduced by half at intersection with countdown timer in Station 2. The percentage of compliance to the red light was tremendously higher at the upstream compared downstream intersection in Station 3 case. The percentages of road user who violate the red light and cross the intersection during amber were remarkably lower at intersection with countdown timer. Results obtained showed that the installation of countdown timer at the signalized intersection able to reduce the number of red light running.

TABLE OF CONTENT

| | |
|--|-----------|
| Introduction | 1 |
| 1.1 Problem Statement | 1 |
| 1.2 Objective | 2 |
| 1.3 Scope of Study | 2 |
| 1.4 The Relevancy of the Project | 3 |
| Literature Review | 4 |
| 2.1 Understanding Red Light Running | 4 |
| 2.2 Factors Influence Red Light Running | 5 |
| 2.2.1 Intersection Factors | 5 |
| 2.2.2 Human Factors | 8 |
| 2.3 Red Light Running in United States | 10 |
| 2.3.1 What is Red Light Running? | 10 |
| 2.3.2 Is Red Light Running a Big Problem? | 10 |
| 2.3.3 How Often Do Drivers Run Red Lights? | 10 |
| 2.4 Countdown Timer in Ipoh City Center | 11 |
| 2.4.1 Installation Process of a Countdown Timer in Ipoh City Center | 11 |
| 2.4.2 Background of Countdown Timer in Ipoh City Center | 11 |
| 2.5 Level of Service (LOS) | 13 |
| 2.5.1 LOS Classifocations | 14 |
| 2.6 aaSidra Software (aaTraffic Signalized & Unsignalized Intersection Design and Research Aid) | 16 |
| Methodology | 19 |
| 3.1 Reconnaissance Survey | 19 |
| 3.2 Pre-Survey | 23 |
| 3.3 Traffic Survey | 23 |
| 3.4 Traffic Count | 23 |
| 3.5 Data Analysis (LOS) | 24 |
| 3.6 Data Analysis (Statistical Analysis) | 24 |

| | |
|---|-----------|
| Results and Discussion | 25 |
| 4.1 Junction Turning Movement and Red Light Violations | 25 |
| 4.2 Junction analysis using aaSIDRA software | 28 |
| 4.3 Statistical Analysis of the Traffic Count Data | 32 |
| Conclusion and Recommendation | 37 |
| 5.1 Conclusion | 37 |
| 5.2 Recommendations | 38 |
| References | 39 |
| Appendices | 41 |

LIST OF FIGURES

| | |
|---|----|
| Figure 1: Vehicle Approaching Signalized Intersection at the Onset of Yellow | 4 |
| Figure 2: Probability of Stopping as a Function of Travel Time and Control Type | 6 |
| Figure 3: Location of Traffic Survey | 19 |
| Figure 4: Location of Station 1-Intersection Balai Polis Pekan Baru | 20 |
| Figure 5: Intersection Balai Polis Pekan Baru from left Upstream (Timer), right Downstream(without Timer) | 20 |
| Figure 6: Location of Station 1- Intersection Silibin | 21 |
| Figure 7: Intersection Silibin from left Upstream (Timer), right Downstream (without Timer) | 21 |
| Figure 8: Location of Station 1- Intersection Pasir Puteh | 22 |
| Figure 9: Intersection Pasir Puteh from left Upstream (Timer), right Downstream | 22 |
| Figure 10: Junction Analysis of Upstream Balai Polis Pekan Baru (Intersection with Countdown Timer) | 28 |
| Figure 11: Junction Analysis of Downstream Balai Polis Pekan Baru (Intersection without Countdown Timer) | 29 |
| Figure 12: Junction Analysis of Upstream Silibin (Intersection with Countdown Timer) | 29 |
| Figure 13: Junction Analysis of Downstream Silibin (Intersection without Countdown Timer) | 30 |
| Figure 14: Junction Analysis of Upstream Jalan Pasir Puteh (Intersection with Countdown Timer) | 30 |
| Figure 15: Junction Analysis of Downstream Jalan Pasir Puteh (Intersection without Countdown Timer) | 31 |
| Figure 16: Percentage of Red Light Running at Intersection with Countdown Timer for Station 1, Balai Polis Pekan Baru | 33 |

| | |
|--|----|
| Figure 17: Percentage of Red Light Running at Intersection without Countdown Timer for Station 1, Balai Polis Pekan Baru | 33 |
| Figure 18: Percentage of Red Light Running at Intersection with Countdown Timer for Station 2, Intersection Silibin | 34 |
| Figure 19: Percentage of Red Light Running at Intersection without Countdown Timer for Station 2, Intersection Silibin | 35 |
| Figure 20: Percentage of Red Light Running at Intersection with Countdown Timer for Station 3, Intersection Pasir Puteh | 36 |
| Figure 21: Percentage of Red Light Running at Intersection without Countdown Timer for Station 3, Intersection Pasir Puteh | 36 |

LIST OF TABLES

| | |
|---|-----------|
| Table 1: LOS Criteria for Signalized Intersections (HCM 2000) | 14 |
| Table 2: Level-of-service definitions for VEHICLES based on both vehicle delay and degree of saturation. | 15 |
| Table 3: Equivalent PCU by Arahan Teknik (Malaysia) | 24 |
| Table 4: Traffic Volume for Station 1, Intersection Balai Polis Pekan Baru | 25 |
| Table 5: Traffic Volume for Station 2, Intersection Silibin | 26 |
| Table 6: Traffic Volume for Station 3, Intersection Jalan Pasir Puteh | 26 |
| Table 7: Data Summary of Station 1, Intersection Balai Polis Pekan Baru | 27 |
| Table 8: Data Summary of Station 2, Intersection Silibin | 27 |
| Table 9: Data Summary of Station 3, Intersection Jalan Pasir Puteh | 28 |
| Table 10: Red Light Running at Station 1, Intersection Balai Polis Pekan Baru | 32 |
| Table 11: Red Light Running at Station 2, Intersection Silibin | 34 |
| Table 12: Red Light Running at Station 3, Intersection Jalan Pasir Puteh | 35 |

INTRODUCTION

1.1 Problem Statement

Thousands of accidents occurred at the intersection due to red light running. The traffic signal seems fail to function effectively as there are vehicles which speed up their vehicle as the light turns to amber so that they still can make it through the intersection. Due to this behavior, many fatal crashes and injuries occur when the vehicle didn't make it through the intersection but at the same time failed to slow down or stop the vehicles and clash with the oncoming vehicles. Not surprisingly then, can be a hazardous location as evidenced by various accident reported. [3]

Traffic light countdown signal is a timer display that counts down and shows the number of seconds left either for the vehicles to stop or to cross the intersection. The main objectives of signal timing at an intersection are to reduce the average delay of all vehicles and the probability of crashes. This device is also intended to aid vehicles to separate into traffic streams from each other. The objective of reducing delay however, sometimes conflicts with that crash reduction. Therefore the purpose of this study is to evaluate the effect of the countdown timer on red light running.

Not every road intersection is installed with the countdown timer. Why the timer signal has not been installed to all of the intersection with fix control (traffic light)? Did the countdown timer affect the cases of red light running or is it the best solution to prevent red light running violation? Therefore a study must be made to answer these issues.

1.2 Objective

The objective of this study is to evaluate the effect of countdown signal on the number of red light running and to conduct a data analysis of red light violence between the intersection with and without countdown timer in Ipoh City Centre.

1.3 Scope of Study

The study involved the following:

i. Data Collection

- *Literature Reviews*

The details understanding on the project's objective is made throughout text books, internet and journal researches. These researches function as main guideline and references.

- *Pre-Survey*

Collection of pre-sampling data at the intersection is made to determine the appropriate point and time of the data that will be used for real survey.

ii. Traffic Survey

- *Data collection*

The numbers of vehicle violate the red light in a certain period at both for intersection with and without the countdown signal will be recorded. The tape recorded is then being put in tabulated data form.

iii. Data Analysis

- Analyze the effect of countdown signal at intersection in Ipoh City Center on the number of red light running base on the data obtained.

1.4 The Relevancy of the Project

This project is related to study the effect of the countdown timer on red lights running cases. It is based on traffic survey by obtaining an amount of red lights running violation in both intersections with or without countdown timer. The effectiveness of countdown timer on red lights running cases has never been studied in Malaysia. This project will verify the significant of countdown timer usage hence the installation identification and guidelines.

LITERATURE REVIEW

2.1 Understanding Red Light Running

Figure 1 illustrates vehicle approaching a signalized intersection at the onset of the yellow interval. A driver who decides to stop can stop the vehicle safely before the stop line, provided there is a minimum distance (x_c) from the intersection, which depends on a number of factors including approaching speed, duration of the yellow interval, and perception-reaction-time.

A driver who decides not to stop can clear the intersection, provided the driver is located within the distance (x_o) from the stop line (which might not be the same as x_c) that allows the driver to clear the intersection safely. In some cases, a driver who decides not to stop (or cannot stop the vehicle in a timely manner) ends up entering the intersection after the signal indication has changed to red. Such a driver is said to have 'run the red light'.

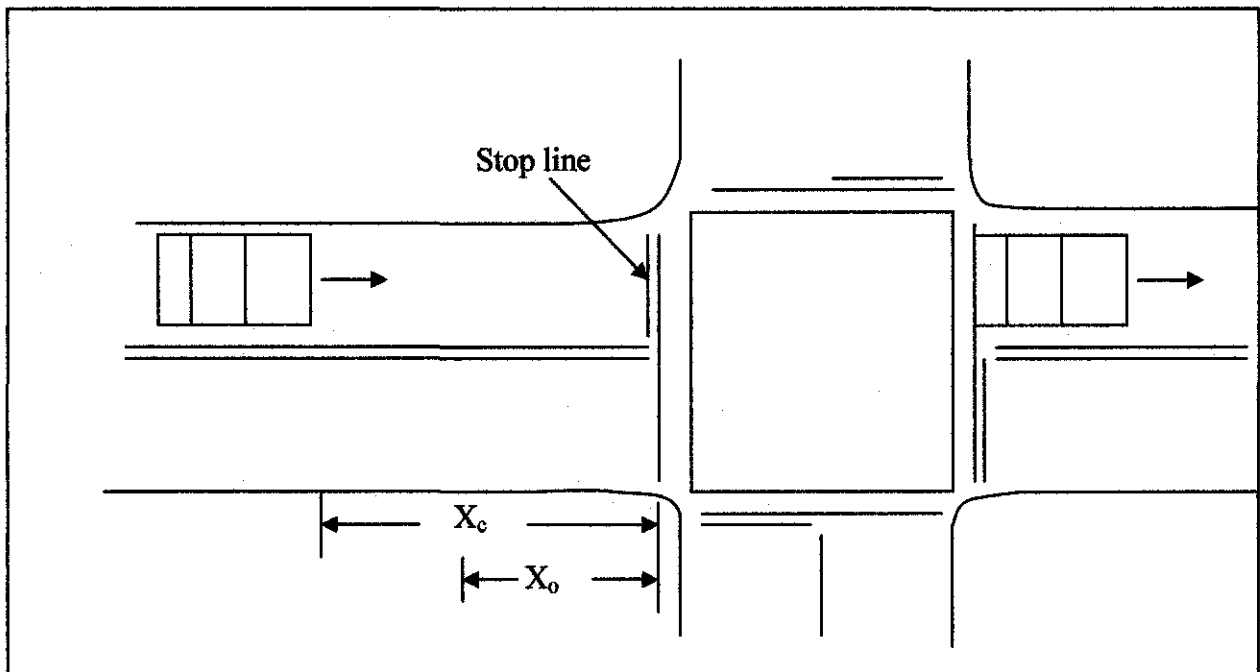

Figure 1: Vehicle Approaching Signalized Intersection at the Onset of Yellow

2.2 Factors Influence Red Light Running

2.2.1 Intersection Factors

2.2.1.1 Intersection Flow Rates

Several studies have found a correlation between volume/flow rates and the incidence of red light running events. In general, as the flow rate on the approaches to an intersection increases, the red light running frequency also increases. This is also an indication that intersections with higher traffic volumes are more likely to experience a higher number of red light running events. [3]

2.2.1.2 Frequency of Signal Cycles

Many researchers recognize a correlation between the frequency of signal changes and red light running. If the cycle length increases, the hourly frequency of signal changes decreases, which should reduce the exposure of drivers to potential red light running situations. [3]

2.2.1.3 Vehicle Speed

The speed at which a driver is approaching an intersection plays a role in the decision of whether to stop at the intersection. Assuming the same travel time to the intersection, high-speed drivers tend to be less likely to stop than low-speed drivers. Differences between high-speed drivers and low-speed drivers tend to decrease, however, as the travel time to the stop line (assuming a constant approaching speed) decreases. [3]

2.2.1.4 Travel Time to the Stop Line

The probability of stopping before the stop line when the light changes to yellow depends on the location of the vehicle and the travel time to the stop line. In general, as the available travel time to the stop line increases, the probability of stopping also increases. This relationship is not linear, as shown in Figure 2. The response in the probability of stopping is particularly strong for travel times in the 2–5 second range. This observation is important because it helps to identify ranges in the duration of the yellow which is usually based on estimates of travel time to the stop line—for which there is a good probability that drivers will be able to stop before the stop line at the onset of yellow. [3]

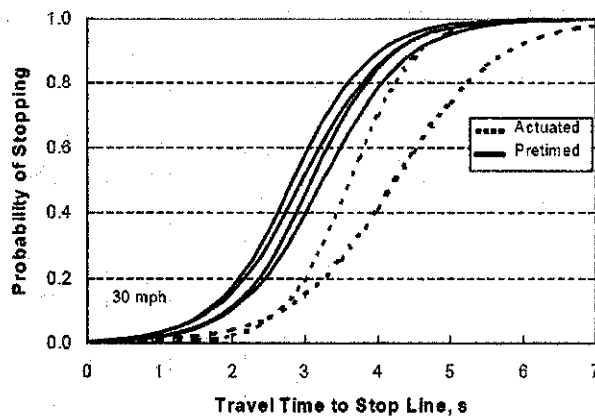

Figure 2: Probability of Stopping as a Function of Travel Time and Control Type [1]

2.2.1.5 Type of Signal Control

The type of signal control plays a role in the exposure of drivers to red light running situations. Highway corridors with vehicle-actuated traffic control tend to produce more compact vehicle platoon configurations than pretimed traffic control. The result is an increase in the number of drivers who may be exposed to the yellow and/or red indications during “max out” phase terminations in the operation of the system and a reduction in the probability of stopping before the stop line after the light changes to yellow. Figure 2 illustrates this effect by showing a lag in the probability of stopping curve for actuated control systems [1].

2.2.1.6 Duration of Yellow Interval

There is a correlation between the duration of the yellow interval and red light running events. A substantial reduction in the number of red light running events after increasing the duration of the yellow interval from 3 to 4 seconds (in urban areas) and from 4 to 5 seconds (in rural areas) was observed [2]. Bonneson, Brewer and Zimmerman observed a small adjustment in the drivers' stopping behavior, which attributed to the relatively low increase in the duration of the yellow interval. They noted, however, that long yellow interval durations tend to result in greater variability in the decision making, which could result in an increase in the number of rear-end collisions. [1]

2.2.1.7 Approach Grade

The approach grade has an effect on the probability that drivers will stop. Drivers on downward approaches are less likely to stop (at a given travel time to the stop line) than drivers on level approaches or upward approaches. The effect is particularly noticeable in the 2–6 second travel time range. [3]

2.2.1.8 Signal Visibility

Signal visibility has long been recognized as a critical factor contributing to red light running. Examples of sight restrictions that can limit the driver's view of the signal include tree foliage, parked vehicles in the immediate vicinity of the intersection, inadequate intersection geometric layouts, and inadequate signal head physical characteristics (such as insufficient number of signal heads, small lens sizes, insufficient lens brightness, and insufficient background contrast). [3]

2.2.2 Human Factors

2.2.2.1 Vision

Visual impairments have an obvious effect on driving performance, particularly in the case of older drivers. Less clear is the relationship between visual impairments and safety. There are three visual factors that affect the processing of dynamic information play a critical role on crash rates: dynamic visual acuity, angular movement, and movement in depth. Dynamic visual acuity refers to the task of seeing objects that are moving with respect to the eye, whereas angular movement and movement in depth refer to the task of judging the speed of objects crossing or approaching the path of travel. [3]

2.2.2.2 Driver Attention

This includes factors such as distraction, inattentiveness, improper lookout, and sleepiness. Interestingly, cell phone use has been associated with a significant increase in the risk of motor vehicle crashes. Driver attention is critical at intersections because of the additional cognitive demands required of drivers at those locations. [3]

2.2.2.3 Perception-Response Time

Perception-response time is a critical component in the calculation of yellow interval durations. However, the perception-reaction time is different by different researchers. [3]

2.2.2.4 Effect of Other Drivers

Drivers approaching an intersection tend to be affected by neighboring vehicles, including preceding vehicles and following vehicles. Drivers were more likely to go, therefore increasing the risk of running the red light, if they were closely following other vehicles or if they were being

followed closely by other vehicles. In other words, when vehicles approaching a signalized intersection are close together, the probability of stopping decreases. The effect was particularly noticeable for time headways of 2 seconds or less. [3]

There is a close correlation between time headway, distance headway, and flow rate in the context of car following situations. In general, both time headways and the scatter in the distribution of time headways decrease as the flow rate increases, resulting in higher interaction among vehicles and more uniform time headways. Researchers observed that drivers tend to adjust their distance headways with speed in an effort to maintain relatively uniform time headways. They also noticed that drivers substantially overestimate their actual time headways. [3]

2.3 Red Lights Running in United States:

2.3.1 What is red light running?

A violation occurs when a motorist enters an intersection, often deliberately; some time after the signal light has turned red. Motorists inadvertently in an intersection when the signal changes to red (waiting to turn left, for example) aren't red light runners. [10]

2.3.2 Is red light running a big problem?

A nationwide study in U.S. of fatal crashes at traffic signals in 1999 and 2000 estimated that 20 percent of the vehicles involved failed to obey the traffic signal. In 2003 more than 900 people were killed and an estimated 176,000 were injured in crashes that involved red light running. About half of the deaths in red light running crashes are pedestrians and occupants in other vehicles who are hit by the red light runners. [10]

2.3.3 How often do drivers run red lights?

A study conducted over several months at 5 busy intersections in Fairfax, Virginia, prior to the use of red light cameras found that, on average, a motorist ran a red light every 20 minutes. During peak travel times, red light running was more frequent. Analysis of red light violation data from 19 intersections in 4 states found that 1,775 violations occurred over 554 hours, for a violation rate of 3.2 per hour. [10]

2.4 Countdown Timer in Ipoh City Center

2.4.1 Installation Process of a Countdown Timer in Ipoh City Center

An installation of a countdown timer in Ipoh city Center is made by Majlis Bandaray Ipoh(MBI) from the demand of Ipoh City citizen. After evaluating the citizen demand, a budget analysis will be made by MBI. If there is sufficient budget, an open tender will be published via newspaper or web page to install the countdown timer. The best contractor will be chosen based on the bill of quantities (B.Q) provided by the contractors. No study was conducted before the installation had been made. After the installation, MBI monitored the effectiveness of the usage of the countdown timer by getting the feedback from Ipoh city citizen. Installation is considered successful when positive feedback obtained from public. [4]

2.4.2 Background of Countdown Timer in Ipoh City Center

The first countdown timer installed in Ipoh City Center is at Jalan Sultan Iskandar Shah Intersection in May 2003. Installation period of one countdown timer is about five to six months. Countdown timer can only be installed in a fix time control intersection. The main purpose of installing the countdown timer is as user guidance as they know the time they have when approaching an intersection and time to cross an intersection. This will minimize the time delay as the road user will be prepared to cross the intersection before the light turns to green. As for safety, countdown timer also can prevent accident when the road user stops early by knowing that they don't have enough time to cross the intersection. [4]

There are 94 intersections with signal control (traffic light) in Ipoh City Center. 44 units were installed by MBI while the other 50 units were installed by Jabatan Kerja Raya(JKR). Currently, MBI has installed countdown timer at 12 intersections. [4]

There are 3 types of countdown timer installed around the Ipoh City Center area provided by 3 suppliers/contractors. Ten out of twelve countdown timer installed were from PPK Technology Sdn Bhd. One each from Intramas Corporation Sdn. Bhd and Wangsa Ukay Trading Sdn. Bhd. [4]

2.5 Level of Service (LOS)

The performance of the intersections which involved in this project can be determined from the level of service at those particular intersections. The improvement of level of service at each intersection usually results in an improvement of the overall operating performance of the highway. Factors that affect the level of service at intersections include the flow and the distribution of traffic, the geometric characteristics, and the signalization system.

Controlled delay is the portion of the total delay attributed to traffic signal operation for signalized intersection is computed to define level of service. Control delay includes initial deceleration delay, queue move-up time, stopped time and final acceleration delay. Control delay is use to define the level of service at signalized intersections, since delay not only indicates the amount of lost travel time and fuel consumption, it is also a measure of frustration and discomfort of the motorists. However, delay is depends on the red time which in turns depends on cycle length.

LOS can also be measured by degree of saturation. The capacity at a signalized intersection is given for each lane group is defined as the maximum rate of flow for the subject lane group that can go through the intersection under prevailing traffic, roadway and signalized condition. Capacity is given in vehicles per hour (veh/h), but it is based on the flow during a peak 15-min period.

The concept of a saturation flow is used to determine the capacity of a lane group. The saturation flow rate is the maximum flow rate on the approach that can go through the intersection under prevailing traffic and roadway conditions when 100 percent effective green time is available. The saturation flow rate is given in units of veh/h of effective green time.

The ratio of flow to the capacity (v/c) is usually referred to as the *degree of saturation* and can be expressed as:

$$(v/c)_i = X_i = \frac{v_i}{s_i (g_i / C)}$$

where

X_i = (v/c) ratio for lane group approach i

v_i = actual flow rate or projected demand for the lane group or approach i (veh/h)

s_i = saturation flow for lane group or approach i (veh/h/g)

g_i = effective green time for lane group i or approach i (sec)

$s_i (g_i / C)$ is the capacity of an approach or lane group

2.5.1 LOS Classifications

LOS is categorized into five levels namely LOS A, B, C, D, E and F. Various criteria are used to define the LOS. Table 1 and 2 show LOS classification based on vehicle delay and degree of saturation.

Table 1: LOS Criteria for Signalized Intersections (HCM 2000) [8]

| LOS | Controlled Delay/Veh (sec/veh) |
|-----|-----------------------------------|
| A | ≤ 10 |
| B | $> 10 - 20$ |
| C | $> 20 - 35$ |
| D | $> 35 - 55$ |
| E | $> 55 - 80$ |
| F | > 80 |

Table 2: Level-of-service definitions for VEHICLES based on both vehicle delay and degree of saturation (HCM 2000). [8]

| Level of Service | Control delay per vehicle in seconds (d) (including geometric delay) | | Degree of saturation (x) |
|------------------|---|---------------------------------|--------------------------|
| | Signals and Roundabouts | Stop and Give-Way (Yield) Signs | |
| A | $d \leq 10$ | $d \leq 10$ | $0 < x \leq 0.90$ |
| B | $10 < d \leq 20$ | $10 < d \leq 15$ | $0 < x \leq 0.90$ |
| C | $20 < d \leq 35$ | $15 < d \leq 25$ | $0 < x \leq 0.90$ |
| | $0 < d \leq 35$ | $0 < d \leq 25$ | $0.90 < x \leq 0.93$ |
| D | $35 < d \leq 55$ | $25 < d \leq 35$ | $0 < x \leq 0.93$ |
| | $0 < d \leq 55$ | $0 < d \leq 35$ | $0.93 < x \leq 0.95$ |
| E | $55 < d \leq 80$ | $35 < d \leq 50$ | $0 < x \leq 0.95$ |
| | $0 < d \leq 80$ | $0 < d \leq 50$ | $0.95 < x \leq 1.00$ |
| F | $80 < d$ | $50 < d$ | $1.00 \leq x$ |

2.6 aaSIDRA Software (aaTraffic Signalized & Unsignalized Intersection Design and Research Aid)

The aaSIDRA, or aaTraffic SIDRA (Signalised & unsignalised Intersection Design and Research Aid) software is an aid for design and evaluation of the following intersection types:

- i. signalised intersections (fixed-time / pretimed and actuated),
- ii. roundabouts,
- iii. two-way stop sign control,
- iv. all-way stop sign control, and
- v. Give-way (yield) sign-control.

aaSIDRA uses detailed analytical traffic models coupled with an iterative approximation method to provide estimates of capacity and performance statistics (delay, queue length, stop rate, etc). Although aaSIDRA is a single intersection analysis package, this software also allows performing traffic signal analysis as an isolated intersection (default) or as a coordinated intersection by specifying platoon arrival data. aaSIDRA traffic models can be calibrated for local conditions. The outputs of each junction from the aaSIDRA analysis are as below:

- i. Degree of Saturation
- ii. Average Delay
- iii. LOS
- iv. Average Speed
- v. Worst Turning Movement

aaSIDRA software is able to do the following analyses:

- i. Obtain estimates of capacity and performance characteristics such as delay, queue length, stop rate as well as operating cost, fuel consumption and pollutant emissions for all intersection types;
- ii. Analyze many design alternatives to *optimize* the intersection geometry, signal phasing and timings specifying different strategies for optimization;
- iii. Handle intersections with up to 8 legs, each with one-way or two-way traffic, one-lane or multi-lane approaches, and short lanes, slip lanes, continuous lanes and turn bans as relevant;
- iv. Determine *signal timings* (fixed-time / pre-timed and actuated) for any intersection geometry allowing for simple as well as complex phasing arrangements;
- v. Carry out a design life analysis to assess impact of traffic growth;
- vi. Carry out a parameter sensitivity analysis for optimization, evaluation and geometric design purposes;
- vii. Design intersection geometry including lane use arrangements taking advantage of the unique *lane-by-lane* analysis method of aaSIDRA;
- viii. Design short lane lengths (turn bays, lanes with parking upstream, and loss of a lane at the exit side);
- ix. Analyze effects of heavy vehicles on intersection performance;
- x. Analyze complicated cases of shared lanes and opposed turns (e.g. permissive and protected phases, slip lanes, turns on red);
- xi. Analyze oversaturated conditions making use of aaSIDRA's time-dependent delay, queue length and stop rate formulae.
- xii. Prepare data and inspect output with ease due to the graphical nature of aaSIDRA input and output;
- xiii. Obtain output including capacity, timing and performance results reported for individual lanes, individual movements (or lane groups), movement groupings (such as vehicles and pedestrians), and for the intersection as a whole;

- xiv. Control the amount of output by selecting individual output tables, with options for summary and full output;
- xv. Present data and results in picture and graphs form in reports;
- xvi. Carry out sensitivity analyses to evaluate the impact of changes on parameters representing intersection geometry and driver behaviors;
- xvii. Calculate annual sums of statistics such as operating cost, fuel consumption, emissions, total person delay, stops and so on, and present demonstrate benefits of alternative intersection treatments in a more powerful way;
- xviii. Compare alternative (gap-acceptance and "empirical") capacity estimation methods for roundabouts;
- xix. Calibrate the parameters of the operating cost model for local conditions allowing for factor such as the value of time and resource cost of fuel.

METHODOLOGY

3.1 Reconnaissance Survey

Reconnaissance survey is the visual observation of the spot that will be used for the real survey. Peak hour was observed to occur during lunch time (1.00-2.00 pm) but the survey cannot be conducted at this time because the intersections were controlled by traffic police. Therefore traffic surveys were conducted in the morning. Three stations for traffic survey were identified. Figure 3 shows the final site chosen.

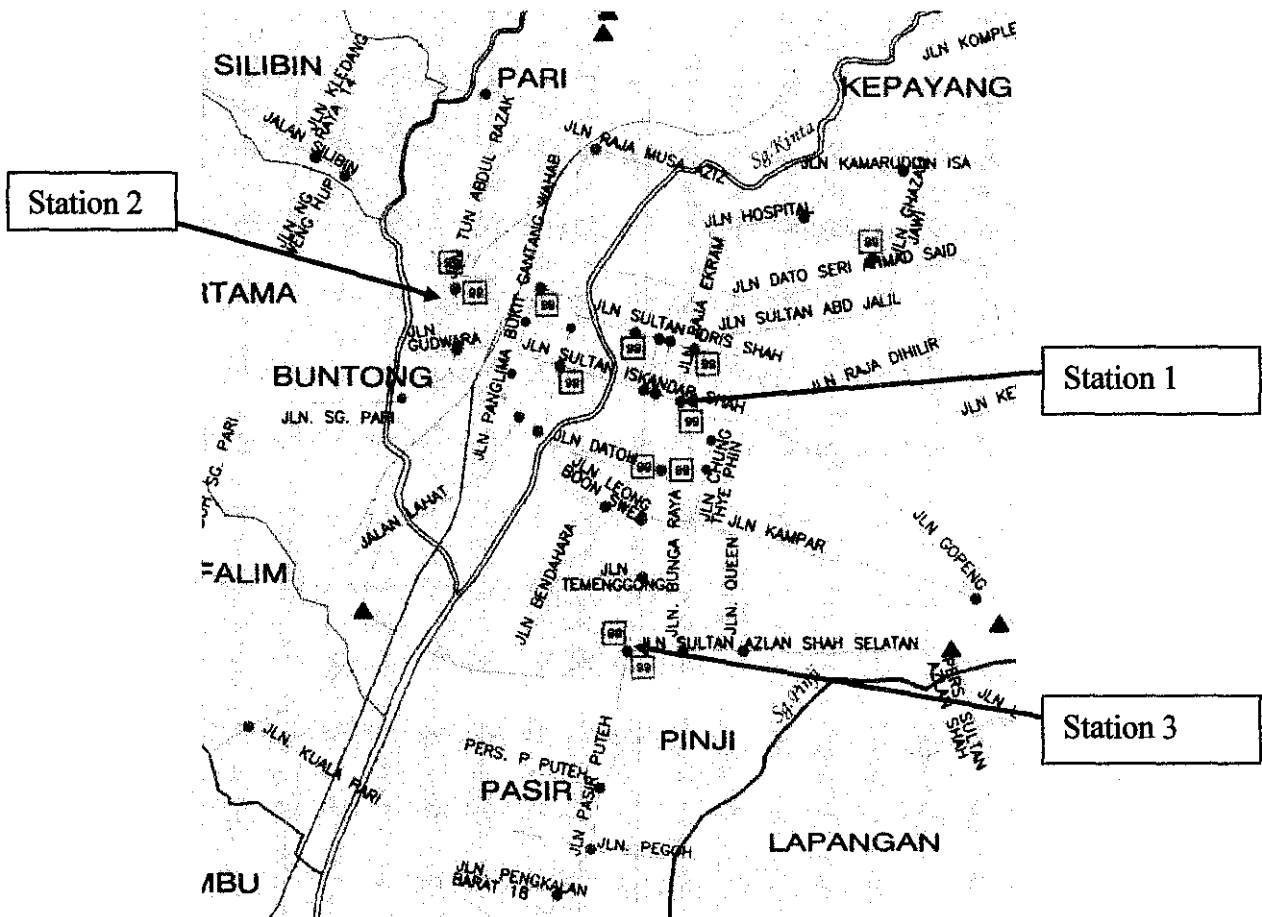

Figure 3: Location of Traffic Survey

- Station 1: Intersection Balai Polis Pekan Baru at Jalan Sultan Iskandar Shah
- Station 2: Intersection Silibin at Jalan Tun Abdul Razak
- Station 3: Intersection Pasir Puteh at Jalan Pasir Puteh

Site's layout and sample photos for all three sites are shown in Figure 4 to 9.

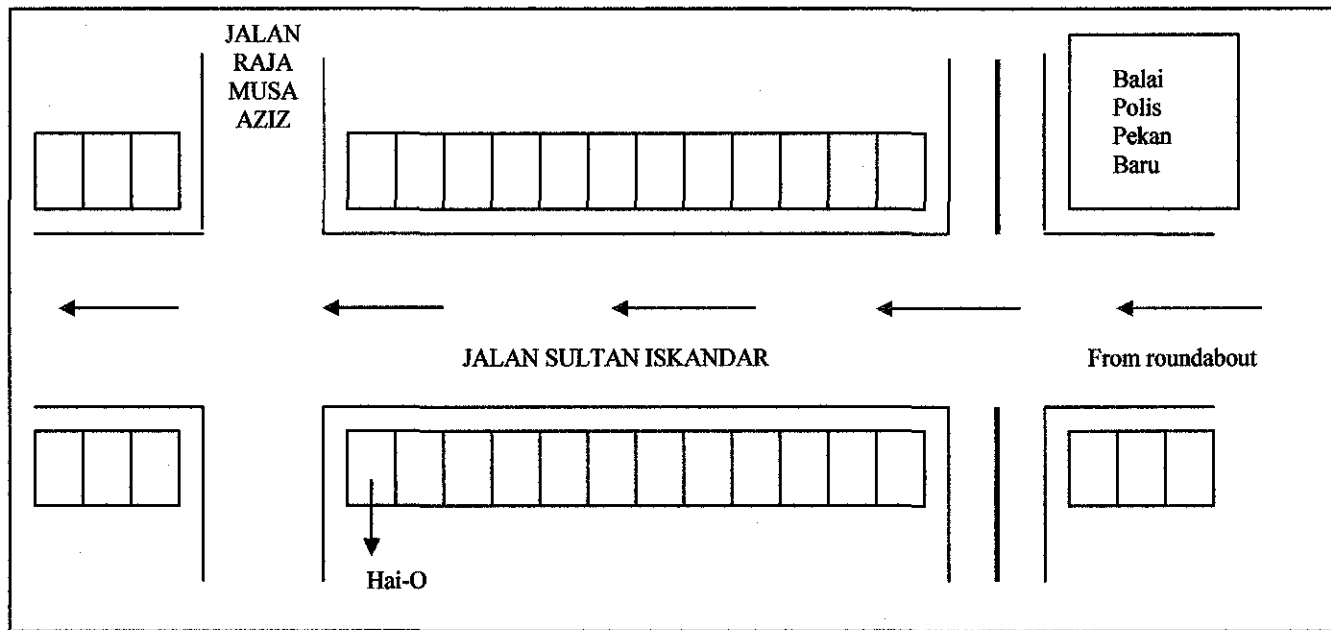

Figure 4: Location of Station 1-Intersection Balai Polis Pekan Baru

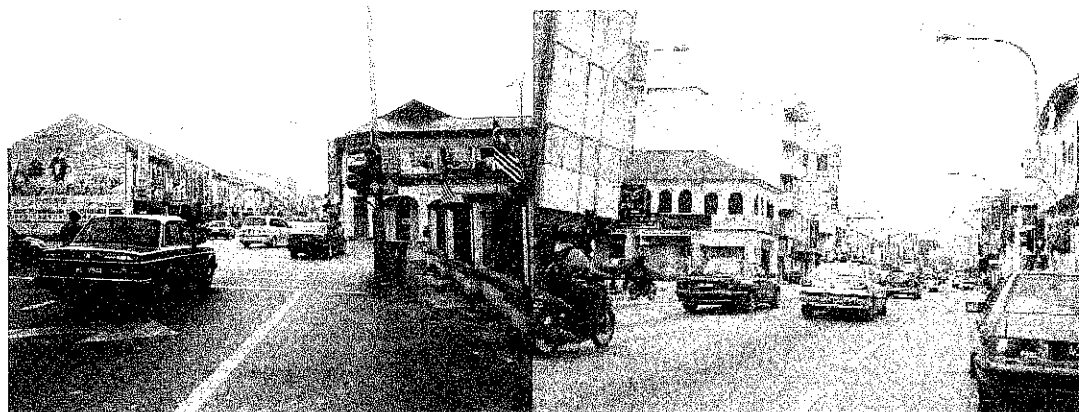

Figure 5: Intersection Balai Polis Pekan Baru from left Upstream(Timer), right Downstream(without Timer)

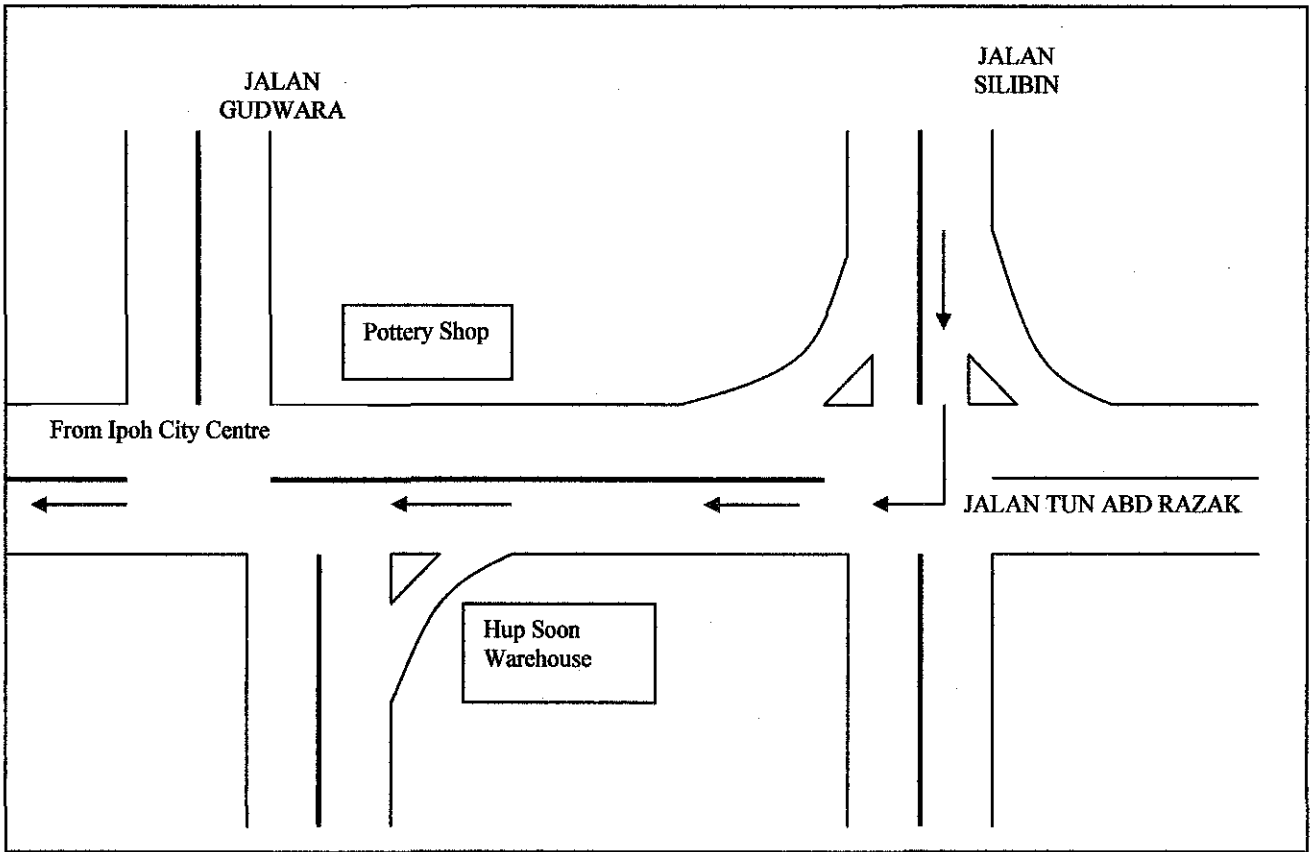

Figure 6: Location of Station 2- Intersection Silibin



Figure 7: Intersection Silibin from left Upstream(Timer), right Downstream (without Timer)

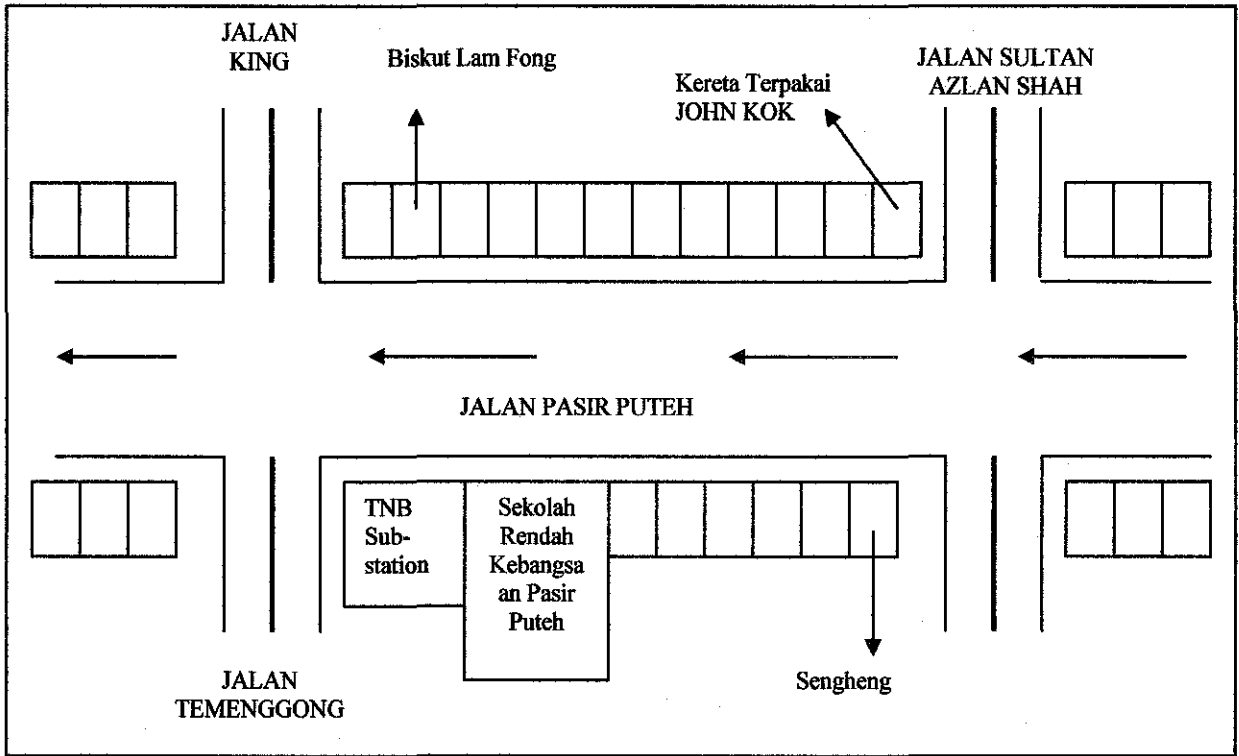

Figure 8: Location of Station 3- Intersection Pasir Puteh



Figure 9: Intersection Pasir Puteh from left Upstream (Timer), right Downstream.

3.2 Pre-Survey

Preliminary traffic surveys were performed at the chosen stations for sampling purposes. From this pre-sampling data, traffic count data were tabulated. The pattern of the data was analysed. Problem or obstacles in performing the traffic survey were identified during this stage. Solutions and alternatives for the survey or the traffic count were justified and rectification was made for the next process, which is the real traffic survey.

3.3 Traffic Survey

The field traffic surveys were carried out by using video recording technique. Two video cameras were leaved to run for two hours, from 9 a.m. to 11 a.m. simultaneously at both intersections with the countdown timer (upstream) and without the countdown timer (downstream). Three field surveys were conducted at those 3 stations identified.

3.4 Traffic Count

The recorded data were replayed on a television to project the visual. The volume of the road user comply with the red light, cross the intersection during amber and violates the red light were tabulated. This process was preformed by manual count. Data counted are only for the approach that use the countdown timer at the upstream intersection and the approach downstream that flows from the upstream approach with countdown timer before. The data was then converted into data summary and after that been summarized in (Passenger Car Unit) PCU. Table 3 shows the equivalent factors used. Full junction turning movements were determined for all intersections.

Table 3: Equivalent (Passenger Car Unit) PCU by Arahan Teknik (Jalan) 8/86[9]

| Type of Vehicle | Rural | Urban | Traffic Signal |
|-----------------|-------|-------|----------------|
| Passenger Car | 1.00 | 1.00 | 1.00 |
| Motorcycle | 1.00 | 0.75 | 0.33 |
| Light Vans | 2.00 | 2.00 | 2.00 |
| Medium Lorries | 2.50 | 2.50 | 1.75 |
| Heavy Lorries | 3.00 | 3.00 | 2.25 |
| Busses | 3.00 | 3.00 | 2.25 |

3.5 Data Analysis (Level of Service)

The levels of service (LOS) of all the intersections involved in the traffic survey were obtained through aaSIDRA software. Traffic volumes of the junctions for all of the phases were obtained from the previous traffic survey..

3.6 Data Analysis (Statistical Analysis)

The data summary was then converted into percentage. The Chi-Square statistical analysis was carried out from the percentage gained. The purpose of this analysis is to determine the significant of red light running cases between the with the countdown timer and without the countdown timer. A pie chart also was prepared to clearly indicate the difference between values of intersection with and without the installation of countdown timer.

RESULTS AND DISCUSSION

4.1 Junction Turning Movements and Red Light Running Violations.

Traffic volume data surveys at all three stations were converted into pcu are shown on Tables 4 to 6.

Table 4: Traffic Volume for Station 1, Intersection Balai Polis Pekan Baru

| 9.00 a.m. to 10 a.m. | Upstream(timer) | | | | Downstream | | | |
|---|---------------------|-----------------------|----------------|-----------|---------------------|-----------------------|----------------|-----------|
| | Total passenger car | Total lorry and buses | Equivalent pcu | Total pcu | Total passenger car | Total lorry and buses | Equivalent pcu | Total pcu |
| Road user comply with the red light | 1318 | 14 | $1318+14*1.75$ | 1342.5 | 1433 | 16 | $1433+16*1.75$ | 1461 |
| Road user cross the intersection during amber | 76 | 0 | $76+0*1.75$ | 76 | 70 | 0 | $70+0*1.75$ | 70 |
| Road user violates the red light | 4 | 0 | $4+0*1.75$ | 4 | 4 | 0 | $4+0*1.75$ | 4 |
| 10 a.m. to 11 a.m. | Upstream(timer) | | | | Downstream | | | |
| | Total passenger car | Total lorry and buses | Equivalent pcu | Total pcu | Total passenger car | Total lorry and buses | Equivalent pcu | Total pcu |
| Road user comply with the red light | 1346 | 8 | $1346+8*1.75$ | 1360 | 1508 | 11 | $1508+11*1.75$ | 1527.25 |
| Road user cross the intersection during amber | 50 | 2 | $50+2*1.75$ | 53.5 | 50 | 2 | $50+2*1.75$ | 53.5 |
| Road user violates the red light | 6 | 0 | $6+0*1.75$ | 6 | 6 | 0 | $6+0*1.75$ | 6 |

Table 5: Traffic Volume for Station 2, Intersection Silibin

| 9.00 a.m. to 10.00 a.m. | Upstream(timer) | | | | Downstream | | | |
|---|---------------------|-----------------------|----------------|-----------|---------------------|-----------------------|----------------|-----------|
| | Total passenger car | Total lorry and buses | Equivalent pcu | Total pcu | Total passenger car | Total lorry and buses | Equivalent pcu | Total pcu |
| Road user comply with the red light | 379 | 9 | $379+1.75*9$ | 394.75 | 382 | 16 | $382+16*1.75$ | 410 |
| Road user cross the intersection during amber | 13 | 0 | $13+0*1.75$ | 13 | 30 | 2 | $30+2*1.75$ | 33.5 |
| Road user violates the red light | 3 | 1 | $3+1*1.75$ | 4.75 | 4 | 0 | $4+0*1.75$ | 4 |
| 10.00 a.m. to 11.00 a.m. | Upstream(timer) | | | | Downstream | | | |
| | Total passenger car | Total lorry and buses | Equivalent pcu | Total pcu | Total passenger car | Total lorry and buses | Equivalent pcu | Total pcu |
| Road user comply with the red light | 464 | 13 | $464+13*1.75$ | 486.75 | 479 | 17 | $479+17*1.75$ | 508.75 |
| Road user cross the intersection during amber | 22 | 0 | $22+0*1.75$ | 22 | 43 | 5 | $43+5*1.75$ | 51.75 |
| Road user violates the red light | 3 | 0 | $3+0*1.75$ | 3 | 9 | 0 | $9+0*1.75$ | 9 |

Table 6: Traffic Volume for Station 3, Intersection Pasir Puteh

| 9.00 a.m. to 10.00 a.m. | Upstream(timer) | | | | Downstream | | | |
|---|---------------------|-----------------------|----------------|-----------|---------------------|-----------------------|----------------|-----------|
| | Total passenger car | Total lorry and buses | Equivalent pcu | Total pcu | Total passenger car | Total lorry and buses | Equivalent pcu | Total pcu |
| Road user comply with the red light | 1160 | 8 | $1160+8*1.75$ | 1174 | 922 | 5 | $933+5*1.75$ | 930.75 |
| Road user cross the intersection during amber | 2 | 0 | $2+0*1.75$ | 2 | 61 | 1 | $61+1*1.75$ | 62.75 |
| Road user violates the red light | 2 | 0 | $2+0*1.75$ | 2 | 12 | 0 | $12+0*1.75$ | 12 |
| 10.00 a.m. to 11.00 a.m. | Upstream(timer) | | | | Downstream | | | |
| | Total passenger car | Total lorry and buses | Equivalent pcu | Total pcu | Total passenger car | Total lorry and buses | Equivalent pcu | Total pcu |
| Road user comply with the red light | 1035 | 15 | $1035+15*1.75$ | 1061.25 | 1083 | 12 | $1083+12*1.75$ | 1104 |
| Road user cross the intersection during amber | 3 | 0 | $3+0*1.75$ | 3 | 57 | 0 | $57+0*1.75$ | 57 |
| Road user violates the red light | 0 | 0 | 0 | 0 | 21 | 0 | $21+0*1.75$ | 21 |

Meanwhile, Tables 7 to 9 shows data summary of red light running incidents for all three stations.

Table 7: Data Summary of Station 1, Intersection Balai Polis Pekan Baru

| 9.00 a.m. to 10 a.m. | Upstream with countdown timer (pcu) | Downstream without countdown timer(pcu) |
|---|-------------------------------------|---|
| Road user comply with the red light | 1342 | 1461 |
| Road user cross the intersection during amber | 76 | 70 |
| Road user violates the red light | 4 | 4 |
| 10.00 a.m. to 11.00 a.m. | Upstream with countdown timer (pcu) | Downstream without countdown timer(pcu) |
| Road user comply with the red light | 1360 | 1527 |
| Road user cross the intersection during amber | 54 | 54 |
| Road user violates the red light | 6 | 6 |
| Total | 2842 | 3122 |

Table 8: Data Summary of Station 2, Intersection Silibin

| 9.00 a.m. to 10 a.m. | Upstream with countdown timer (pcu) | Downstream without countdown timer(pcu) |
|---|-------------------------------------|---|
| Road user comply with the red light | 395 | 410 |
| Road user cross the intersection during amber | 13 | 34 |
| Road user violates the red light | 5 | 4 |
| 10.00 a.m. to 11.00 a.m. | Upstream with countdown timer (pcu) | Downstream without countdown timer(pcu) |
| Road user comply with the red light | 487 | 509 |
| Road user cross the intersection during amber | 22 | 52 |
| Road user violates the red light | 3 | 9 |
| Total | 921 | 1018 |

Table 9: Data Summary of Station 3, Intersection Jalan Pasir Puteh

| 9.00 a.m. to 10 a.m. | Upstream with countdown timer (pcu) | Downstream without countdown timer(pcu) |
|---|-------------------------------------|---|
| Road user comply with the red light | 1174 | 931 |
| Road user cross the intersection during amber | 2 | 62 |
| Road user violates the red light | 2 | 12 |
| 10.00 a.m. to 11.00 a.m. | Upstream with countdown timer (pcu) | Downstream without countdown timer(pcu) |
| Road user comply with the red light | 1061 | 1104 |
| Road user cross the intersection during amber | 3 | 57 |
| Road user violates the red light | 0 | 21 |
| Total | 2242 | 2188 |

4.2 Junction Analysis using aaSIDRA Software.

4.2.1 Station 1: Intersection Balai Polis Pekan Baru

Figures 10 and 11, show that the LOS at the downstream intersection was better than the upstream intersection. This also means that a road user have to wait longer to cross the intersection at upstream intersection which was about 35sec/veh-80sec/veh (LOS D-E) compared to 20-55veh/sec (LOS C-D) at the downstream.

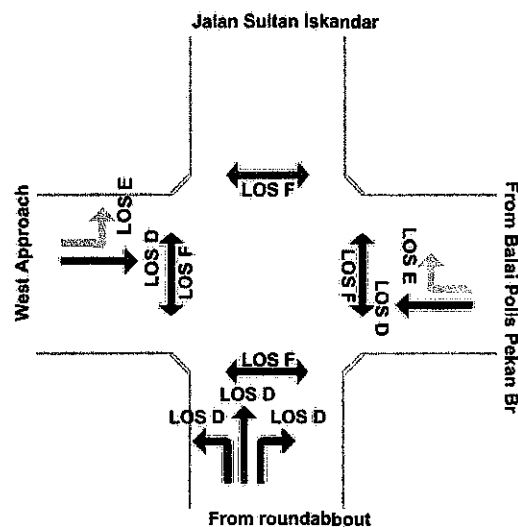

Figure 10: Junction Analysis of Upstream Balai Polis Pekan Baru
(Intersection with Countdown Timer)

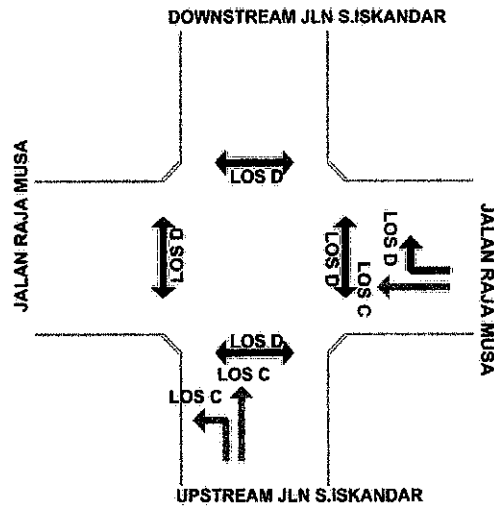

Figure 11: Junction Analysis of Downstream Balai Polis Pekan Baru
(Intersection without Countdown Timer)

4.2.2 Station 2: Intersection Silibin

Figure 12 and 13 show that the LOS at the upstream intersection was better than the downstream intersection. At the upstream intersection, only one movement has LOS F compared to the downstream intersection which registered LOS for almost all movements.

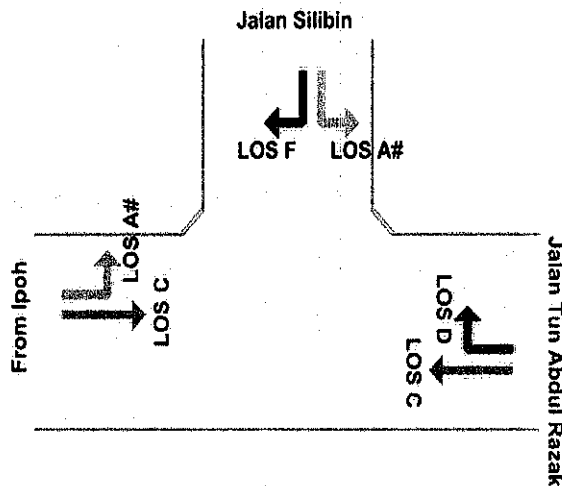

Figure 12: Junction Analysis of Upstream Silibin
(Intersection with Countdown Timer)

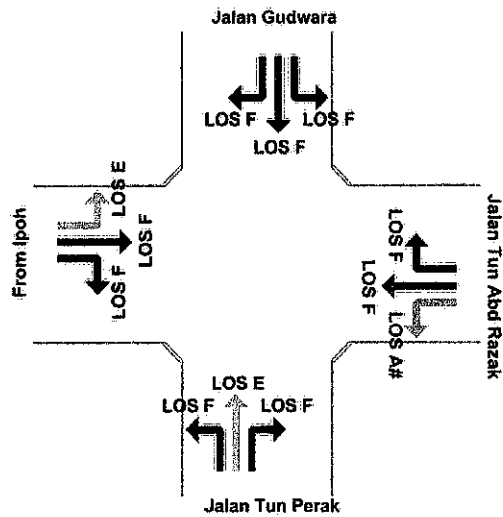

Figure 13: Junction Analysis of Downstream Silibin
(Intersection without Countdown Timer)

4.2.3 Station 3: Intersection Pasir Puteh

Unlike other previous two stations, the LOS for the upstream and downstream intersection at Station 3 as shown in Figure 14 and 15 were almost similar. Both of the intersection's approaches have LOS D and LOS E. In other words, road users of both intersections experience the same level of service.

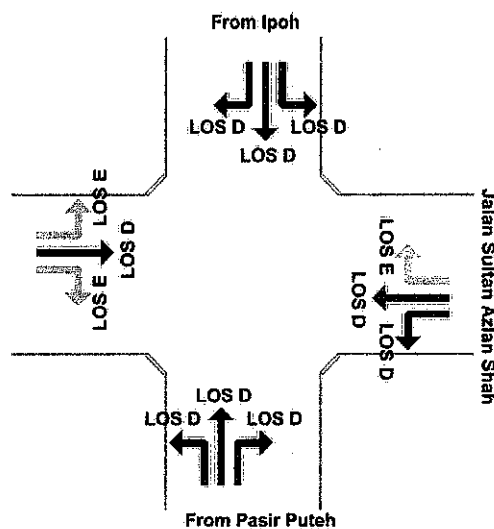

Figure 14: Junction Analysis of Upstream Jalan Pasir Puteh (Intersection with Countdown Timer)

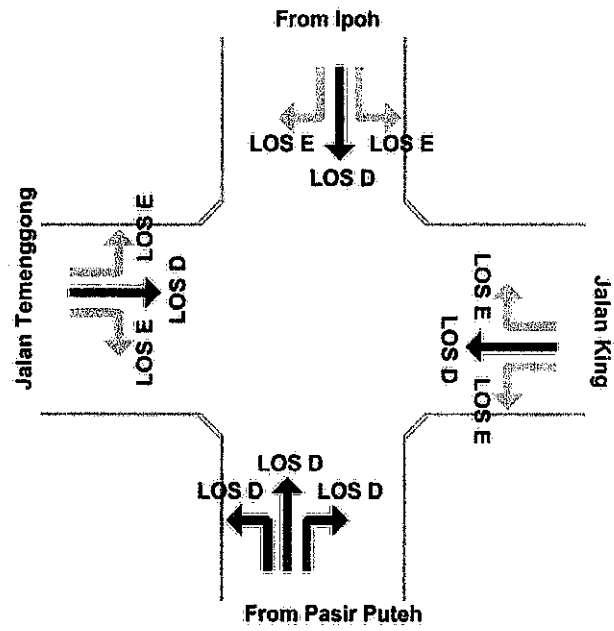

Figure 15: Junction Analysis of Downstream Jalan Pasir Puteh
(Intersection without Countdown Timer)

4.3 Statistical Analysis of the Traffic Count Data

The analyses were carry out on data obtained for the whole two hours.

4.3.1 Station 1: Intersection Balai Polis Pekan Baru

The chi-square statistic was used to compare the levels of red light compliance and violation at the signalized intersections with and without countdown timer. The null hypotheses for all of the statistical analysis were the installation of countdown timer has no effect on the red light violation. The statistical analysis on results obtained for Station 1 is shown in table 10.

Table 10: Red Light Running at Station 1, Balai Polis Pekan Baru

| 10.00 a.m. to 11.00 a.m. | Upstream,timer (pcu) | Downstream (pcu) |
|---|----------------------|------------------|
| Road user comply with the red light | 2706 (95.2%) | 2988 (95.7%) |
| Road user cross the intersection during amber | 130 (4.6%) | 124 (4.0%) |
| Road user violates the red light | 10 (0.4%) | 10 (0.3%) |

Chi-square statistic = 0.046

Chi-square critical at 95% confidence interval = 5.992

Table 10 show results obtained for Station 1. Since the $0.046 < 5.992$ the hypothesis was accepted that difference was not significant at probability of 0.987. Figures 19 and 20 show that the percentages of road users violates the red light and cross the intersection during amber are only slightly higher at intersection with countdown timer. In addition, the percentage shown that the compliance of red light was slightly lower at intersection with the countdown timer. This condition was contradicted to the purpose of countdown timer installation.

Percentage of Red Light Running at Intersection with Countdown Timer(Upstream)

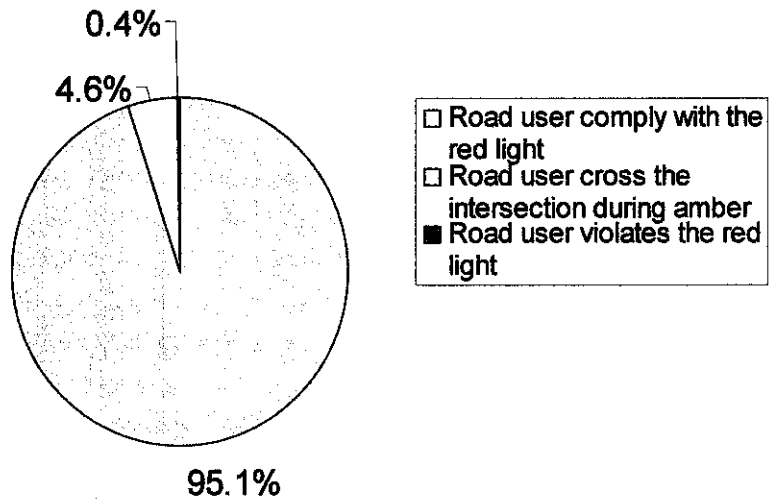

Figure 16: Percentage of Red Light Running at Intersection with Countdown Timer for Station 1, Balai Polis Pekan Baru

Percentage of Red Light Running at Intersection without Countdown Timer(Downstream)

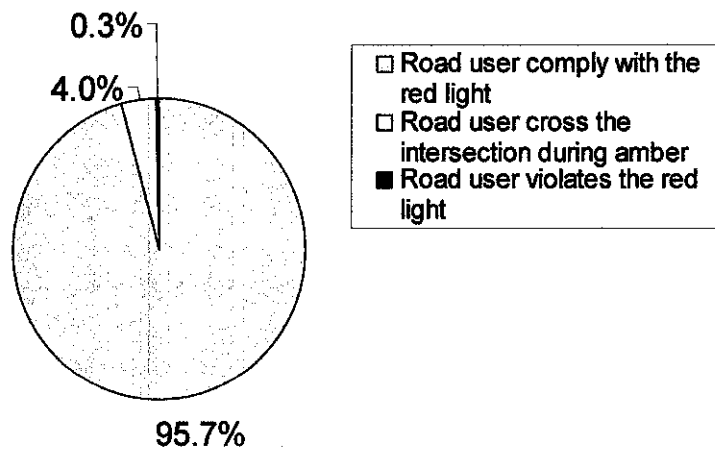

Figure 17: Percentage of Red Light Running at Intersection without Countdown Timer for Station 1, Balai Polis Pekan Baru

4.3.2 Station 2: Intersection Silibin

Table 11: Red Light Running at Station 2, Intersection Silibin

| 10.00 a.m. to 11.00 a.m. | Upstream,timer (pcu) | Downstream (pcu) |
|---|----------------------|------------------|
| Road user comply with the red light | 882 (95.4%) | 919 (90.3%) |
| Road user cross the intersection during amber | 35 (3.8%) | 86 (8.4%) |
| Road user violates the red light | 8 (0.8%) | 13 (1.3%) |

Chi-square statistic = 1.997

Chi-square critical at 95% confidence interval = 5.992

Table 11 shows results obtained for Station 2. Since the $1.997 < 5.992$ the hypothesis was accepted that the difference was not significant at probability of 0.511. However, the percentages comparison of each data above, show that the red light compliance was higher at intersection with the countdown timer. The road user who cross the intersection during amber and who violates the red light were decreased by almost double at intersection with the countdown timer compared to the intersection without timer as showed in Figures 18 and 19.

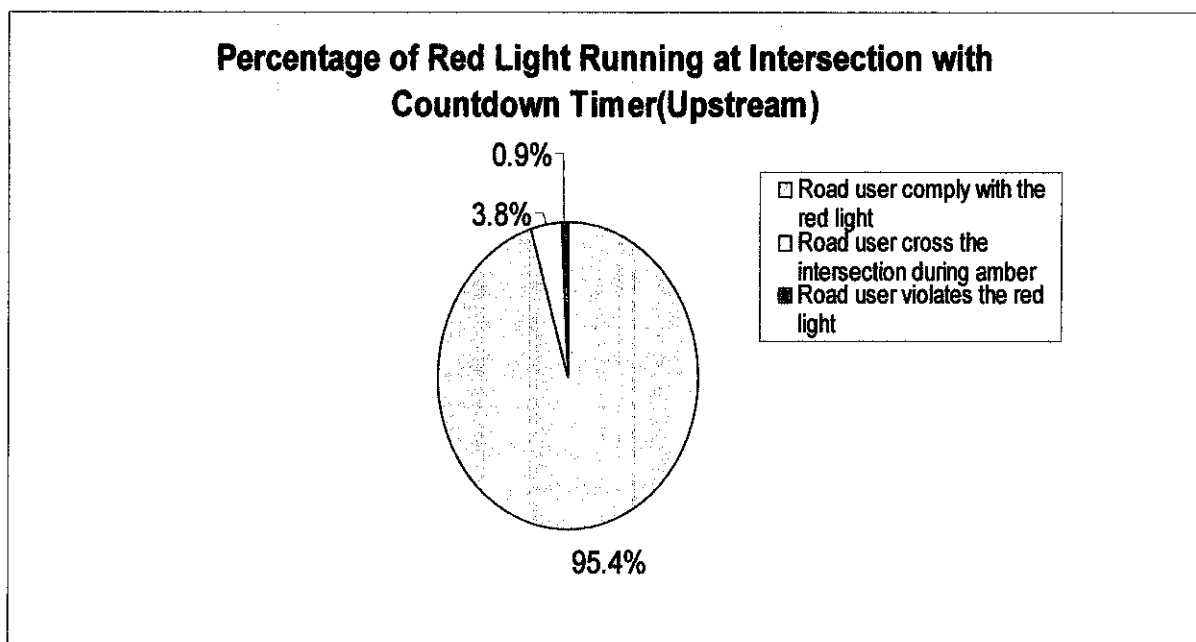

Figure 18: Percentage of Red Light Running at Intersection with Countdown Timer for Station 2, Intersection Silibin

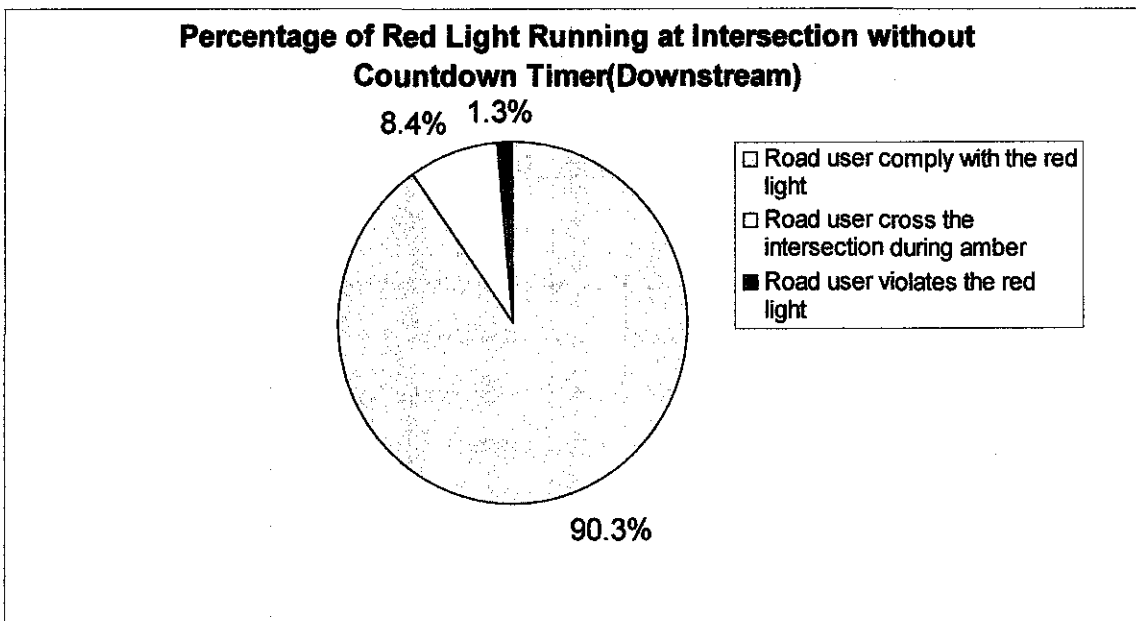

Figure 19: Percentage of Red Light Running at Intersection without Countdown Timer for Station 2, Intersection Silibin

4.3.3 Station 3: Intersection Pasir Puteh

Table 12: Red Light Running at Station 3, Intersection Pasir Puteh

| 10.00 a.m. to 11.00 a.m. | Upstream,timer (pcu) | Downstream (pcu) |
|---|----------------------|------------------|
| Road user comply with the red light | 2235 (99.7%) | 2035 (93.0%) |
| Road user cross the intersection during amber | 5 (0.2%) | 120 (5.5%) |
| Road user violates the red light | 2 (0.1%) | 33 (1.5%) |

Chi-square statistic = 6.342

Chi-square critical at 95% confidence interval = 5.992

Results for data obtained at Station 3 are shown in Table 12. Since the $6.342 > 5.992$ the hypothesis was rejected. Thus the difference was significant at probability 0.05. The percentages of road users violate the red light and cross the intersection during amber show a remarkable increase from the intersection with countdown timer to intersection without countdown timer. Figures 20 and 21 illustrate the differences.

**Percentage of Red Light Running at Intersection
without Countdown Timer(Downstream)**

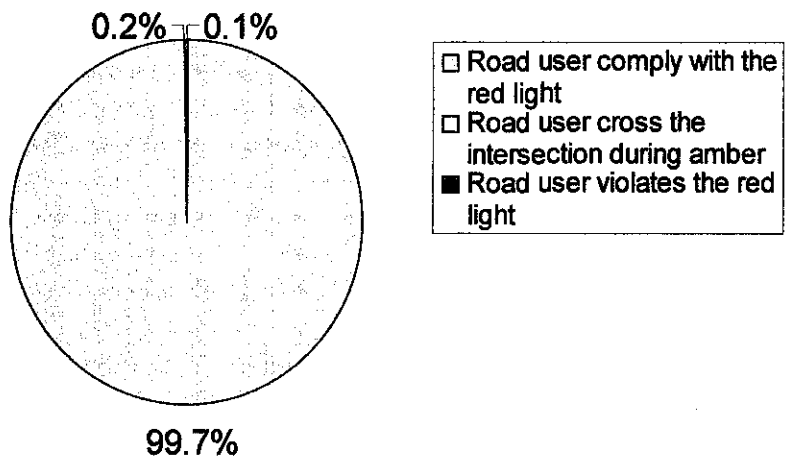

Figure 20: Percentage of Red Light Running at Intersection with Countdown Timer for Station 3, Intersection Pasir Puteh

**Percentage of Red Light Running at Intersection
without Countdown Timer(Downstream)**

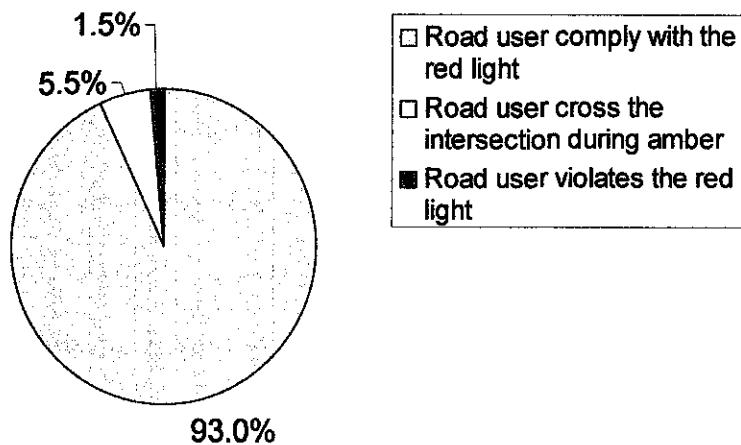

Figure 21: Percentage of Red Light Running at Intersection without Countdown Timer for Station 3, Intersection Pasir Puteh

CONCLUSION AND RECOMMENDATIONS

5.1 Conclusion

The junction analyses show that the LOS at the downstream intersection without countdown was better than the upstream intersection with countdown timer at Station 1, Balai Polis Pekan Baru. The LOS at the upstream intersection was better than the downstream intersection in Station 2, Intersection Silibin case. The LOS of both intersections with and without the countdown timer at Station 3, Intersection Pasir Puteh were almost similar.

The statistical analysis shown that the effect of countdown timer on the number of red light running for Station 1, Balai Polis Pekan Baru and Station 2, Intersection Silibin was not significant at 95% confidence level. However the effect of countdown signal on the number of red light running for Station 3, Intersection Pasir Puteh was significant at 95% confidence level.

By percentages, the road users who comply with the red light, cross the intersection during amber and violate the red light were approximately the same at Station 1, Balai Polis Pekan Baru. The percentages of road users who violate the red light and cross the intersection during amber were approximately reduced by half at intersection with countdown timer in Station 2, Intersection Silibin. The percentage of compliance to the red light was higher at the upstream compared downstream intersection. Station 3, Intersection Pasir Puteh case. The percentages of road user who violate the red light and cross the intersection during amber were remarkably lower at intersection with countdown timer.

These conclude that the effect of countdown signal on red light running varies between different intersections. The countdown timer showed a significant effect at 95% confidence level only at Station 3, Intersection Pasir Puteh. Compared to other station, Station 3 had almost similar LOS at the upstream and downstream intersection. This factor might contribute to the effectiveness of the countdown timer installation. The countdown timer had no effect when been installed at upstream intersection that had poorer LOS level than the downstream LOS level. This case was proven by Station 1,

Balai Polis Pekan Baru analysis. The analyses also conclude that the countdown timer had significantly reduced the number of red light running at signalized intersection.

5.2 Recommendation

This study was conducted between two different intersections, one with countdown timer and one without countdown timer. Ideally, the data would have been collected using before-and-after approach which can eliminate the intersection factor such the geometric, capacity and location of the intersection itself. In that case, the effect of countdown timer behavior is in fact the results of the treatment alone, not the differences between sites. However a before-and-after approach study requires the involvement of the local authority installing schedule and coordination. This was not possible within short period study. Adequate data collection also can be obtained through large number of locations site. Countdown timer should be tested in other cities, especially on newly constructed road.

There are numbers of alternatives to reduce the red light violation such as through enforcement and education. Better enforcement perhaps by using red light cameras may also be effective in reducing the red light running cases. Constant monitoring by police traffic will make road users behave while driving. Campaign from the local government also can improve the awareness of risk in violating the red light.

References:

- 1) Bonneson, J., Brewer, M., and Zimmerman, K. (2001). *Review and evaluation of factors that affect the frequency of red-light-running* (Report FHWA/TX-02/4027-1). Austin, TX: Texas Department of Transportation, 78 pp.
- 2) Van der Horst, R. (1998). Driver decision making at traffic signals. *Transportation Research Record 1172*, 93-97.
- 3) Cesar Quiroga, Edgar Kraus, Ida van Schalkwyk and James Bonneson. *Red light running-A policy review*, February 2002-October 2002.
- 4) Encik Mohd Sukhaile, Transport Officer. Traffic Department Majlis Bandaraya Ipoh (MBI).
- 5) Karim, Kidwai and Ibrahim. *Traffic flow analysis of digital countdown signalized urban intersection*. Proceeding of the Eastern Asia Society for Transportation Studies, Vol 5, pp. 1301-1308, 2005.
- 6) Rahmi Akcelik, *aaSIDRA user guide, Introduction to aaSIDRA*, Akcelik & Associates Pty Ltd, February 2002.
- 7) Nicholas J. Garber and Lester A. Hoel, *Traffic and Highway Engineering-third edition*, Brooks/Cole, CA USA, 2002
- 8) Transportation Research Board, National Research Council, *Highway Capacity Manual*, HCM 2000 Washington D.C., 2000.
- 9) Jabatan Kerja Raya, *Arahan Teknik (Jalan) 8/86*
- 10) Jay L. Devore, *Probability and Statistics for Engineering and the Sciences*, Brooks/Cole, Third Edition.

Online References:

11) <http://www.iihs.org/research/qanda/rlr.html#1>

12) www.akcelik/trafficsignal.com

13) www.ppktech.net

Appendices

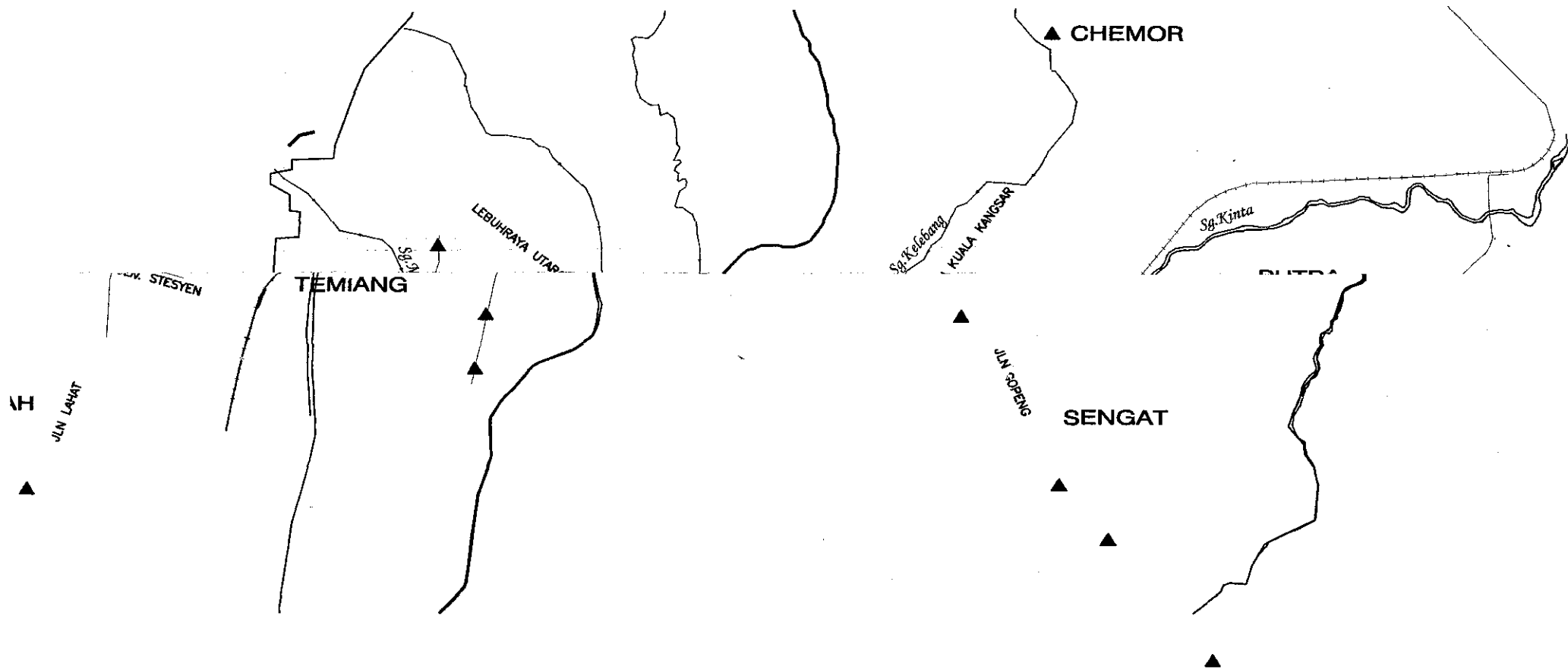

| |
|---|
| AN |
| SIMPANG LAMPU ISYARAT SEDIA ADA (44 UNIT) |
| PEDESTRIAN CROSSING (9 UNIT) |
| LAMPU ISYARAT DIGITAL (12 UNIT) |
| SIMPANG LAMPU ISYARAT SEDIA ADA (JKR) (50 UNIT) |
| PEDESTRIAN CROSSING (JKR) (2 UNIT) |

**KONTRAK TAHUNAN UNTUK MENYELENGGARA LAMPU
 ISYARAT LALULINTAS DI DALAM KAWASAN MBI BAGI
 TAHUN 2005 HINGGA 2007 (24 BULAN)**

 MALIS BANDARAYA IPOH
 BERKHIDMAT CEMERLANG BANDARAYA GEMILANG

Appendix A: Station 1, Intersection Balai Polis Pekan Baru

RED LIGHTS VIOLENCE AND COMPLIANCE VOLUME COUNT

STATION: STATION 1 BALAI POLIS PEKAN BARU INTERSECTION (UPSTREAM)

DAY: FRIDAY DATE: _____

WEATHER: FINE/CLOUDY/RAIN

NAME OF THE ROAD: JALAN SULTAN ISKANDAR SHAH

DIRECTION OF TRAVEL:

SHEET NO: 1

| TIME | APPROACH | | | | | | | | | | | | | | | | | |
|------------------------|----------|---|---|---|---|---|----|---|----|---|---|---|----|----|---|---|---|---|
| | ↶ | | | | ↑ | | | | ↷ | | | | | | | | | |
| VEHICLE CLASSIFICATION | 1 | 2 | 1 | 2 | 1 | 2 | 1 | 2 | 1 | 2 | 1 | 2 | 1 | 2 | 1 | 2 | 1 | 2 |
| 900 | 7 | | | | | | 20 | 1 | 10 | | | | | 4 | | | | |
| 910 | 6 | | | | | | 20 | 2 | 11 | | | | | 2 | | | | |
| 920 | 4 | | | | | | 20 | | 8 | | | | 5 | 3 | | | | |
| 930 | 4 | | | | | | 21 | | 9 | | | | 4 | 2 | | | | |
| 940 | 5 | | | | | | 20 | | 10 | | | | 5 | 3 | | | | |
| 950 | 8 | | | | | | 21 | | 11 | | | | 5 | 3 | | | | |
| TOTAL | 37 | | 0 | 0 | | | 28 | | 59 | 0 | | | 27 | 17 | 0 | | | |
| 1000 | 7 | | | | | | 10 | | 6 | 1 | | | 5 | 1 | | | | |
| 1010 | 9 | | | | | | 20 | | 7 | 1 | | | 20 | 2 | | | | |
| 1020 | 5 | | | | | | 22 | | 8 | | | | | | | | | |
| 1030 | | | | | | | 16 | | 7 | | | | | | | | | |
| 1040 | | | | | | | | | 9 | | | | 9 | 2 | | | | |
| 1050 | 4 | | | | | | 22 | | 8 | | | | 5 | | | | | |
| TOTAL | 38 | | 0 | 0 | | | 30 | | 45 | 2 | | | 30 | 5 | 0 | | | |

| 1st HOUR | | 2nd HOUR | | |
|----------|----|----------|---|---|
| 1 | 2 | 1 | 2 | |
| 1318 | 14 | 1348 | 8 | Road User comply with red light |
| 76 | 0 | 50 | 2 | Road User cross the intersection during amber |
| | | | | Road User violate the red light |

RED LIGHTS VIOLENCE AND COMPLIANCE VOLUME COUNT

STATION: STATION 1 BALAI POLIS PEKAN BARU INTERSECTION(DOWNSTREAM)

DAY: FRIDAY DATE: _____

WHEATER: FINE/CLOUDY/RAIN

NAME OF THE ROAD: JALAN SULTAN ISKANDAR SHAH

DIRECTION OF TRAVEL:

SHEET NO: 1

| TIME | APPROACH | | | | | | | | | | | | | | | | | |
|------------------------|----------|---|---|---|---|---|----|---|---|---|---|---|---|---|---|---|---|---|
| | ↙ | | | | ↑ | | | | ↘ | | | | | | | | | |
| VEHICLE CLASSIFICATION | 1 | 2 | 1 | 2 | 1 | 2 | 1 | 2 | 1 | 2 | 1 | 2 | 1 | 2 | 1 | 2 | 1 | 2 |
| 900 | 13 | | 4 | | | | 22 | | | | | | | | | | | |
| 910 | 16 | | | | | | 1 | | | | | | | | | | | |
| 920 | 15 | | | | | | 13 | | | | | | | | | | | |
| 930 | 21 | | 3 | | | | 10 | | | | | | | | | | | |
| 940 | 23 | | 1 | | | | 9 | | | | | | | | | | | |
| 950 | 34 | | 1 | | | | 6 | | | | | | | | | | | |
| TOTAL | 105 | | 9 | 0 | | | 61 | 0 | | | | | | | | | | |
| 1000 | 14 | | 1 | | | | | | | | | | | | | | | |
| 1010 | 20 | | | | | | 8 | | | | | | | | | | | |
| 1020 | 25 | | | | | | 11 | | | | | | | | | | | |
| 1030 | 15 | | | | | | 7 | 1 | | | | | | | | | | |
| 1040 | 31 | | | | | | 13 | 1 | | | | | | | | | | |
| 1050 | 10 | | | | | | 10 | | | | | | | | | | | |
| TOTAL | 128 | | 1 | 0 | | | 49 | 2 | | | | | | | | | | |

| 1st HOUR | | 2nd HOUR | |
|----------|----|----------|----|
| 1 | 2 | 1 | 2 |
| 1433 | 18 | 1508 | 11 |
| 70 | 0 | 50 | 2 |

Road User comply with red light
 Road User cross the intersection during amber
 Road User violate the red light

Intersection Summary



BALAI POLIS PEKAN BARU DOWNSTREAM

| Performance Measure | Vehicles | Pedestrians | Persons |
|-----------------------------------|-----------------|--------------|------------------|
| Command Flow | 3095 veh/h | 212 ped/h | 4855 pers/h |
| Degree of Saturation | 0.637 | 0.057 | |
| Capacity (Total) | 5330 veh/h | | |
| % Back of Queue (m) | 103 m | 0 m | |
| % Back of Queue (veh) | 14.7 veh | 0.2 ped | |
| Control Delay (Total) | 24.18 veh-h/h | 2.01 ped-h/h | 38.28 pers-h/h |
| Control Delay (Average) | 28.1 s/veh | 34.1 s/ped | 28.4 s/pers |
| Level of Service | LOS C | LOS D | |
| Level of Service (Worst Movement) | LOS D | LOS D | |
| Total Effective Stops | 2410 veh/h | 196 ped/h | 3811 pers/h |
| Effective Stop Rate | 0.78 per veh | 0.92 per ped | 0.79 per pers |
| Travel Distance (Total) | 1874.8 veh-km/h | 2.1 ped-km/h | 2814.4 pers-km/h |
| Travel Distance (Average) | 606 m | 10 m | 580 m |
| Travel Time (Total) | 55.4 veh-h/h | 2.5 ped-h/h | 85.7 pers-h/h |
| Travel Time (Average) | 64.5 secs | 43.1 secs | 63.5 secs |
| Travel Speed | 33.8 km/h | 0.8 km/h | 32.8 km/h |
| Operating Cost (Total) | 1304 \$/h | 35 \$/h | 1339 \$/h |
| Fuel Consumption (Total) | 223.1 L/h | | |
| Carbon Dioxide (Total) | 557.7 kg/h | | |
| Hydrocarbons (Total) | 0.990 kg/h | | |
| Carbon Monoxide (Total) | 43.76 kg/h | | |
| NOx (Total) | 1.290 kg/h | | |

U:\lala\FYP2\sidraa\balaipolis_downstream_
 Produced by aaSIDRA 2.0.1.206 (Unregistered Version)
 Copyright © 2000-2002
 akcelik & Associates Pty Ltd

Generated 6/11/2006 8:13:24 PM

ovement Summary



ALAI POLIS PEKAN BARU DOWNSTREAM

alised - Actuated isolated
e Time = 78 seconds

hicle Movements

| er No | Turn | Dem Flow (veh/h) | Cap (veh/h) | Deg of Satn (v/c) | Aver Delay (sec) | Level of Service | 95% Back of Queue (m) | Eff. Stop Rate | Aver Speed (km/h) | Oper Cost (\$/h) |
|-----------------------------|------|------------------|-------------|-------------------|------------------|------------------|-----------------------|----------------|-------------------|------------------|
| DREAM JLN S.ISKANDAR | | | | | | | | | | |
| 1 | L | 141 | 571 | 0.247 | 31.8 | LOS C | 35 | 0.79 | 31.9 | 67 |
| 2 | T | 1529 | 2400 | 0.637 | 26.5 | LOS C | 103 | 0.77 | 34.7 | 616 |
| roach | | 1670 | 2971 | 0.637 | 26.9 | LOS C | 103 | 0.77 | 34.5 | 683 |
| IN RAJA MUSA | | | | | | | | | | |
| 5 | T | 924 | 1529 | 0.604 | 26.1 | LOS C | 97 | 0.76 | 34.9 | 371 |
| 5 | R | 501 | 829 | 0.604 | 35.8 | LOS D | 95 | 0.85 | 30.2 | 251 |
| roach | | 1425 | 2359 | 0.604 | 29.5 | LOS C | 97 | 0.79 | 33.1 | 622 |
| icles | | 3095 | 5330 | 0.637 | 28.1 | LOS C | 103 | 0.78 | 33.8 | 1304 |

lestrian Movements

| lov No | Dem Flow (veh/h) | Aver Delay (sec) | Level of Service | 95% Back of Queue (m) | Eff. Stop Rate | Oper Cost (\$/h) | |
|------------|------------------|------------------|------------------|-----------------------|----------------|------------------|-----------|
| 51 | 53 | 33.2 | LOS D | 0 | 0.92 | 9 | |
| 53 | 53 | 33.2 | LOS D | 0 | 0.92 | 9 | |
| 55 | 53 | 35.7 | LOS D | 0 | 0.93 | 9 | |
| 57 | 53 | 34.2 | LOS D | 0 | 0.93 | 9 | |
| eds | | 212 | 34.1 | LOS D | 0 | 0.92 | 35 |

TP\lala\FYP2\sidraa\balaipolis_downstream_
uced by aaSIDRA 2.0.1.206 (Unregistered Version)
right© 2000-2002
lik & Associates Pty Ltd

ated 6/11/2006 8:13:50 PM

hasing



LAIPOLIS PEKAN BARU DOWNSTREAM

78 seconds

Time Option: Program calculated cycle time

Green times determined by the program.

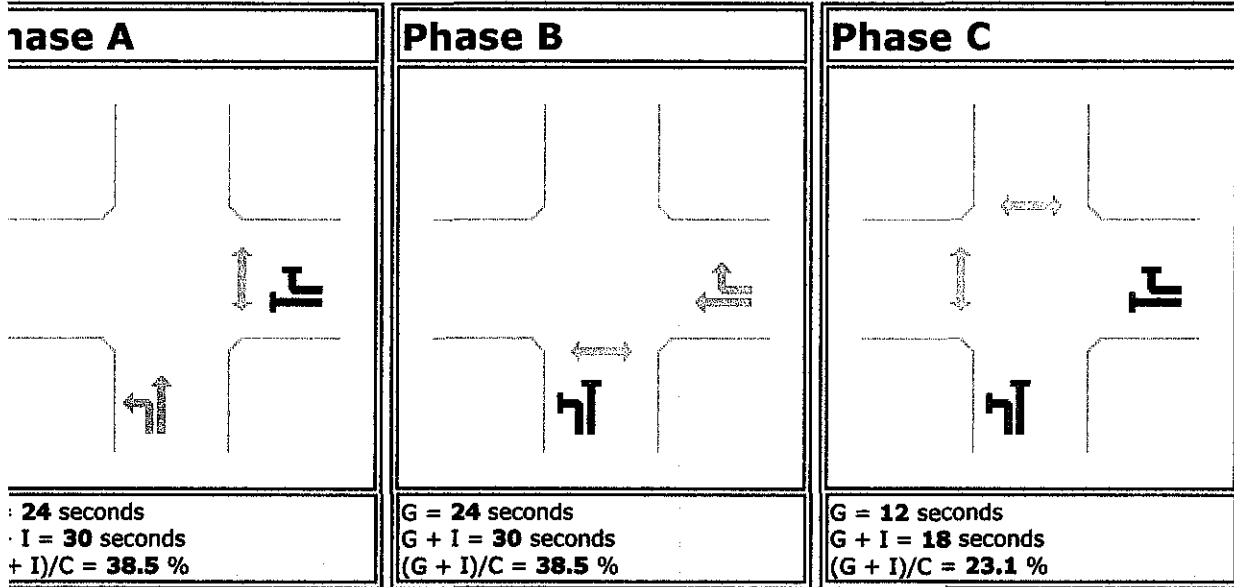

- Normal Vehicle
- Permitted/Opposed
- Stopped Vehicle
- Slip-Lane
- Opposed Slip-Lane
- Continuous
- Pedestrian
- Turn On Red
- Dummy

Cycle Time

Green Time

Intergreen Time (yellow plus all-red)

(G + I)/C Phase time as a percentage of cycle

Path: I:\lala\FYP2\sidraa\balaipolis_downstream_
 created by aaSIDRA 2.0.1.206 (Unregistered Version)

Copyright © 2000-2002

akcelik & Associates Pty Ltd

Printed: 6/11/2006 8:14:25 PM

Level of Service



Based on Delay (HCM method)

BALAI POLIS PEKAN BARU DOWNSTREAM

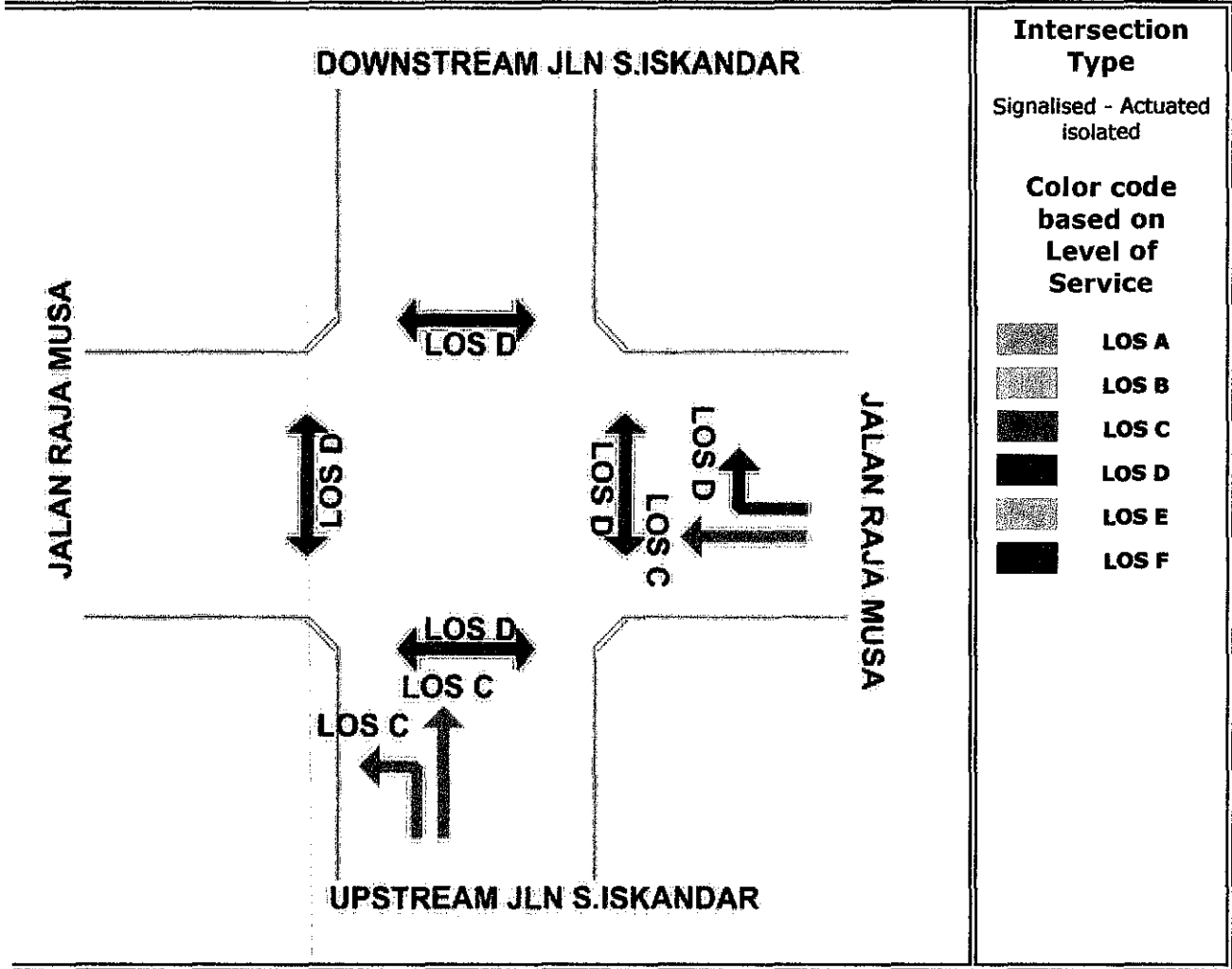

TP\lala\FYP2\sidraa\balaipolis_downstream_
 used by aaSIDRA 2.0.1.206 (Unregistered Version)
 right© 2000-2002
 akcelik & Associates Pty Ltd

dated 6/11/2006 8:15:01 PM

Appendix B: Station 2, Intersection Silibin

RED LIGHTS VIOLENCE AND COMPLIANCE VOLUME COUNT

STATION: SILIBIN (UPSTREAM-COUNTDOWN)

DAY: _____ DATE: _____ WHEATER: FINE/CLOUDY/RAIN

NAME OF THE ROAD: JALAN TUN ABDUL RAZAK

DIRECTION OF TRAVEL: SILIBIN-IPOH

SHEET NO: 1

| TIME | APPROACH | | | | | | | | | | | | | | | | | |
|------------------------|----------|---|---|---|---|---|---|---|---|---|---|---|-----|----|----|---|---|---|
| | ↶ | | | | ↑ | | | | ↷ | | | | | | | | | |
| VEHICLE CLASSIFICATION | 1 | 2 | 1 | 2 | 1 | 2 | 1 | 2 | 1 | 2 | 1 | 2 | 1 | 2 | 1 | 2 | 1 | 2 |
| 900 | | | | | | | | | | | | | | | | | | |
| 910 | | | | | | | | | | | | | 75 | | | | | |
| 920 | | | | | | | | | | | | | 81 | 2 | 2 | | | |
| 930 | | | | | | | | | | | | | 58 | | 1 | | | |
| 940 | | | | | | | | | | | | | 66 | | 1 | | | |
| 950 | | | | | | | | | | | | | 53 | | 2 | | | |
| TOTAL | | | | | | | | | | | | | 55 | 6 | 6 | | | |
| 1000 | | | | | | | | | | | | | 379 | 9 | 13 | 0 | | |
| 1010 | | | | | | | | | | | | | 71 | | 2 | | | |
| 1020 | | | | | | | | | | | | | 62 | | 1 | | | |
| 1030 | | | | | | | | | | | | | 80 | | 3 | | | |
| 1040 | | | | | | | | | | | | | 91 | | 10 | | | |
| 1050 | | | | | | | | | | | | | 76 | | 4 | | | |
| TOTAL | | | | | | | | | | | | | 81 | 2 | 2 | | | |
| | | | | | | | | | | | | | 464 | 15 | 22 | 0 | | |

| 1st HOUR | | 2nd HOUR | |
|----------|---|----------|----|
| 1 | 2 | 1 | 2 |
| 379 | 9 | 484 | 13 |
| 13 | 0 | 22 | 0 |

Road user comply with red light
 Road user cross the intersection during amber
 Road user violate the red light

RED LIGHTS VIOLENCE AND COMPLIANCE VOLUME COUNT

STATION: SILIBIN (DOWNSTREAM)

DAY: _____ DATE: _____ WHEATER: FINE/CLOUDY/RAIN

NAME OF THE ROAD: JALAN TUN ABDUL RAZAK

DIRECTION OF TRAVEL: IPOH-SILIBIN

SHEET NO:1

| TIME | APPROACH | | | | | | | | | | | | | | | |
|------------------------|----------|---|---|---|---|---|----|---|---|---|---|---|---|----|---|---|
| | ↶ | | | | ↑ | | | | ↷ | | | | | | | |
| VEHICLE CLASSIFICATION | 1 | 2 | 1 | 2 | 1 | 2 | 1 | 2 | 1 | 2 | 1 | 2 | 1 | 2 | 1 | 2 |
| 900 | | | | | | | 4 | | | | | | | 1 | | |
| 910 | | | | | | | 6 | 2 | | | | | | 2 | | |
| 920 | | | | | | | 3 | | | | | | | 2 | | |
| 930 | | | | | | | 2 | | | | | | | | | |
| 940 | | | | | | | 1 | | | | | | | 2 | | |
| 950 | | | | | | | 4 | | | | | | | 3 | | |
| TOTAL | | | | | | | 20 | 2 | | | | | | 10 | 0 | |
| 1000 | | | | | | | 2 | 1 | | | | | | | | |
| 1010 | | | | | | | 3 | 1 | | | | | | 1 | | |
| 1020 | | | | | | | 3 | 2 | | | | | | 1 | | |
| 1030 | | | | | | | 8 | 1 | | | | | | 1 | | |
| 1040 | | | | | | | 11 | | | | | | | 2 | | |
| 1050 | | | | | | | 8 | | | | | | | 3 | | |
| TOTAL | | | | | | | 35 | 5 | | | | | | 8 | 0 | |

| 1st HOUR | | 2nd HOUR | | |
|----------|----|----------|----|---|
| 1 | 2 | 1 | 2 | |
| 382 | 16 | 479 | 17 | Road user comply with red light |
| 30 | 2 | 43 | 5 | Road user cross the intersection during amber |
| | | | 0 | Road user violate the red light |

Intersection Summary



Intersection Silibin Upstream (with countdown timer)

| Performance Measure | Vehicles | Persons |
|-----------------------------------|-----------------|------------------|
| Band Flow | 1911 veh/h | 2867 pers/h |
| Degree of Saturation | 1.052 | |
| Capacity (Total) | 5942 veh/h | |
| Queue Back of Queue (m) | 207 m | |
| Queue Back of Queue (veh) | 29.6 veh | |
| Control Delay (Total) | 22.31 veh-h/h | 33.46 pers-h/h |
| Control Delay (Average) | 42.0 s/veh | 42.0 s/pers |
| Level of Service | LOS D | |
| Level of Service (Worst Movement) | LOS F | |
| Number of Effective Stops | 1610 veh/h | 2415 pers/h |
| Effective Stop Rate | 0.84 per veh | 0.84 per pers |
| Travel Distance (Total) | 1156.7 veh-km/h | 1735.1 pers-km/h |
| Travel Distance (Average) | 605 m | 605 m |
| Travel Time (Total) | 41.6 veh-h/h | 62.4 pers-h/h |
| Travel Time (Average) | 78.3 secs | 78.3 secs |
| Travel Speed | 27.8 km/h | 27.8 km/h |
| Operating Cost (Total) | 1013 \$/h | 1013 \$/h |
| Fuel Consumption (Total) | 152.4 L/h | |
| Carbon Dioxide (Total) | 381.0 kg/h | |
| Hydrocarbons (Total) | 0.699 kg/h | |
| Carbon Monoxide (Total) | 28.62 kg/h | |
| Particulates (Total) | 0.834 kg/h | |

TP\laila\FYP2\sidraa\silibin_timer_btulnye
 created by aaSIDRA 2.0.1.206 (Unregistered Version)
 Copyright © 2000-2002
 akcelik & Associates Pty Ltd

Printed 6/11/2006 8:17:12 PM

ovement Summary



Intersection Silibin Upstream (with countdown timer)

Controlled - Actuated isolated
Cycle Time = 96 seconds

Vehicle Movements

| Vehicle No | Turn | Dem Flow (veh/h) | Cap (veh/h) | Deg of Satn (v/c) | Aver Delay (sec) | Level of Service | 95% Back of Queue (m) | Eff. Stop Rate | Aver Speed (km/h) | Oper Cost (\$/h) |
|---------------------------------|------|------------------|-------------|-------------------|------------------|------------------|-----------------------|----------------|-------------------|------------------|
| Approach Tun Abdul Razak | | | | | | | | | | |
| 5 | T | 341 | 670 | 0.509 | 28.1 | LOS C | 103 | 0.71 | 33.8 | 142 |
| 6 | R | 493 | 663 | 0.744 | 40.2 | LOS D | 158 | 0.86 | 28.4 | 256 |
| Approach | | 834 | 1333 | 0.744 | 35.3 | LOS D | 158 | 0.80 | 30.4 | 398 |
| Approach Silibin | | | | | | | | | | |
| 7 | L | 126 | 1857 | 0.068 | 8.3 | LOS A# | 2# | 0.62 | 48.9 | 43 |
| 9 | R | 407 | 387 | 1.052 | 92.3 | LOS F | 207 | 1.19 | 16.9 | 353 |
| Approach | | 533 | 2244 | 1.052 | 72.4 | LOS E | 207 | 1.06 | 20.0 | 396 |
| Approach Ipoh | | | | | | | | | | |
| 10 | L | 253 | 1857 | 0.136 | 8.3 | LOS A# | 4# | 0.62 | 48.9 | 86 |
| 11 | T | 291 | 508 | 0.573 | 35.0 | LOS C | 98 | 0.76 | 30.6 | 133 |
| Approach | | 544 | 2365 | 0.573 | 22.6 | LOS C | 98 | 0.70 | 37.1 | 219 |
| Approach | | 1911 | 5942 | 1.052 | 42.0 | LOS D | 207 | 0.84 | 27.8 | 1013 |

JTP\lala\FYP2\sidraa\silibin_timer_btulnye
 developed by aaSIDRA 2.0.1.206 (Unregistered Version)
 Copyright © 2000-2002
 akcelik & Associates Pty Ltd

Generated 6/11/2006 8:17:29 PM

hasing



tersection Silibin Upstream(with countdown ner)

96 seconds

Time Option: **Program calculated cycle time**
 Green times determined by the program.

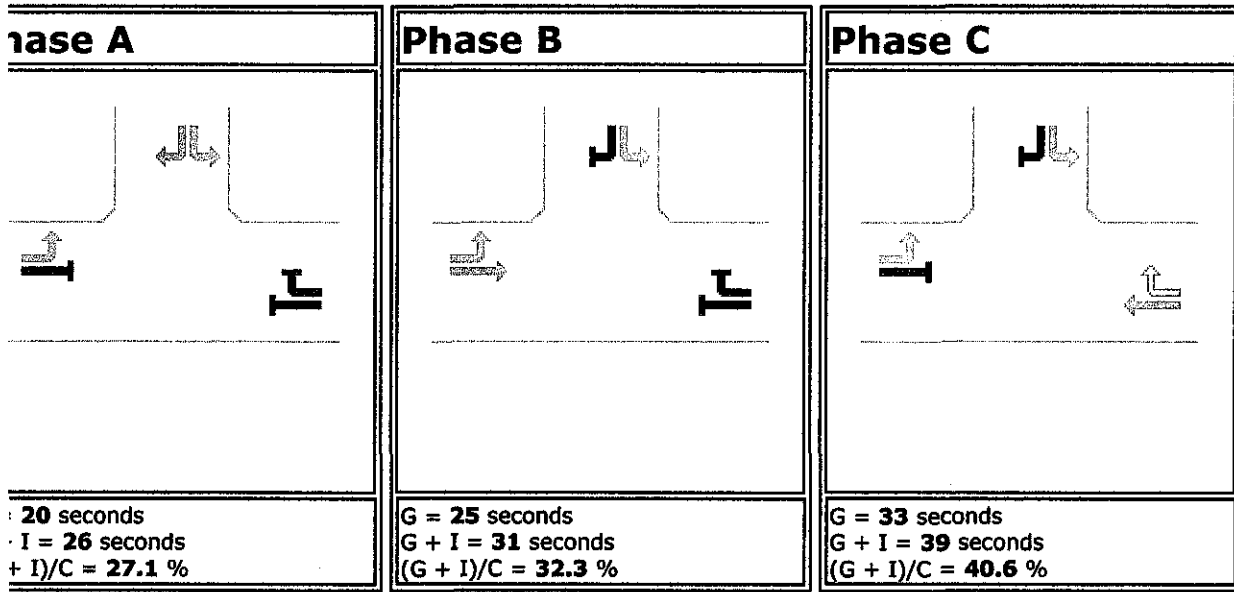

Normal Vehicle
 Permitted/Opposed
 Stopped Vehicle
 Slip-Lane
 Opposed Slip-Lane
 Continuous
 Pedestrian
 Turn On Red
 Dummy

Cycle Time

Green Time

Intergreen Time (yellow plus all-red)

(G + I)/C Phase time as a percentage of cycle

TP\lala\FYP2\sidraa\silibin_timer_btulnye
 created by aaSIDRA 2.0.1.206 (Unregistered Version)
 Copyright © 2000-2002
 akcelik & Associates Pty Ltd

Printed 6/11/2006 8:17:40 PM

Level of Service



Based on Delay (HCM method)

Intersection Silibin Upstream (with countdown timer)

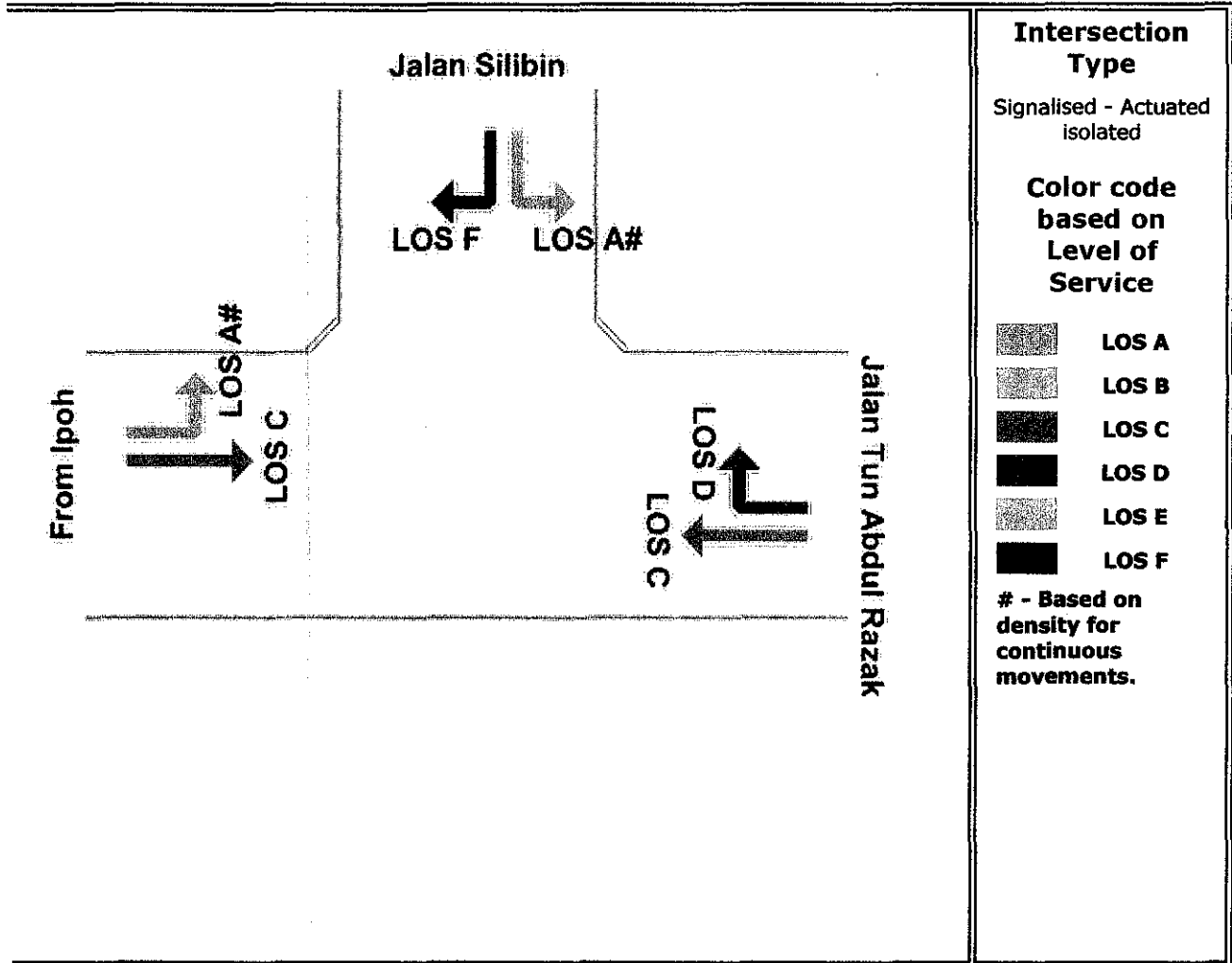

TP\lala\FYP2\sidraa\silibin_timer_btulnye
 used by aaSIDRA 2.0.1.206 (Unregistered Version)
 right© 2000-2002
 akcelik & Associates Pty Ltd

dated 6/11/2006 8:17:55 PM

Intersection Summary



Intersection Silibin Downstream(Without Countdown Timer)

| Performance Measure | Vehicles | Persons |
|-----------------------------------|-----------------|------------------|
| Command Flow | 2974 veh/h | 4461 pers/h |
| Degree of Saturation | 2.887 | |
| Queue Length (Total) | 4616 veh/h | |
| Queue Length Back of Queue (m) | 2226 m | |
| Queue Length Back of Queue (veh) | 318.0 veh | |
| Control Delay (Total) | 432.97 veh-h/h | 649.46 pers-h/h |
| Control Delay (Average) | 524.1 s/veh | 524.1 s/pers |
| Level of Service | LOS F | |
| Level of Service (Worst Movement) | LOS F | |
| Number of Effective Stops | 4998 veh/h | 7497 pers/h |
| Effective Stop Rate | 1.68 per veh | 1.68 per pers |
| Travel Distance (Total) | 1798.2 veh-km/h | 2697.3 pers-km/h |
| Travel Distance (Average) | 605 m | 605 m |
| Travel Time (Total) | 462.9 veh-h/h | 694.4 pers-h/h |
| Travel Time (Average) | 560.4 secs | 560.4 secs |
| Travel Speed | 3.9 km/h | 3.9 km/h |
| Operating Cost (Total) | 10777 \$/h | 10777 \$/h |
| Fuel Consumption (Total) | 857.3 L/h | |
| Carbon Dioxide (Total) | 2143.4 kg/h | |
| Hydrocarbons (Total) | 4.678 kg/h | |
| Carbon Monoxide (Total) | 91.78 kg/h | |
| Particulates (Total) | 2.725 kg/h | |

TP\lala\FYP2\sidraa\silibin_downstream
 Produced by aaSIDRA 2.0.1.206 (Unregistered Version)
 Copyright © 2000-2002
 akcelik & Associates Pty Ltd

Generated 6/11/2006 8:19:45 PM

ovement Summary



ersection Silibin Downstream(Without unddown Timer)

alised - Actuated isolated
e Time = 183 seconds

hicle Movements

| v No | Turn | Dem Flow (veh/h) | Cap (veh/h) | Deg of Satn (v/c) | Aver Delay (sec) | Level of Service | 95% Back of Queue (m) | Eff. Stop Rate | Aver Speed (km/h) | Oper Cost (\$/h) |
|------------------------|------|---------------------|----------------|-------------------------|------------------------|---------------------|--------------------------------|-------------------|-------------------------|------------------------|
| n Tun Perak | | | | | | | | | | |
| 1 | L | 206 | 355 | 0.580 | 83.4 | LOS F | 135 | 0.83 | 18.1 | 163 |
| 2 | T | 6 | 10 | 0.575 | 74.3 | LOS E | 135 | 0.78 | 19.7 | 4 |
| 3 | R | 259 | 365 | 0.709 | 85.9 | LOS F | 166 | 0.85 | 17.8 | 208 |
| roach | | 471 | 731 | 0.709 | 84.6 | LOS F | 166 | 0.84 | 18.0 | 375 |
| n Tun Abd Razak | | | | | | | | | | |
| 4 | L | 158 | 1857 | 0.085 | 8.3 | LOS A# | 3# | 0.62 | 48.9 | 54 |
| 5 | T | 474 | 477 | 0.994 | 104.5 | LOS F | 390 | 1.10 | 15.5 | 433 |
| 6 | R | 53 | 53 | 0.995 | 113.4 | LOS F | 390 | 1.10 | 14.5 | 53 |
| roach | | 685 | 2387 | 0.994 | 83.0 | LOS F | 390 | 0.99 | 18.3 | 540 |
| n Gudwara | | | | | | | | | | |
| 7 | L | 69 | 174 | 0.398 | 91.8 | LOS F | 66 | 0.78 | 17.0 | 58 |
| 8 | T | 25 | 63 | 0.398 | 82.8 | LOS F | 66 | 0.74 | 18.3 | 19 |
| 9 | R | 183 | 233 | 0.784 | 98.2 | LOS F | 129 | 0.85 | 16.1 | 161 |
| roach | | 277 | 470 | 0.784 | 95.2 | LOS F | 129 | 0.82 | 16.5 | 238 |
| n Ipoh | | | | | | | | | | |
| 10 | L | 38 | 507 | 0.075 | 62.6 | LOS E | 22 | 0.75 | 22.0 | 25 |
| 11 | T | 726 | 252 | 2.885 | 949.0 | LOS F | 2226 | 2.44 | 2.2 | 4603 |
| 12 | R | 777 | 269 | 2.887 | 957.9 | LOS F | 2226 | 2.44 | 2.2 | 4995 |
| roach | | 1541 | 1028 | 2.886 | 931.6 | LOS F | 2226 | 2.40 | 2.2 | 9623 |
| icles | | 2974 | 4616 | 2.887 | 524.1 | LOS F | 2226 | 1.68 | 3.9 | 10777 |

UTP\lala\FYP2\sidraa\silibin_downstream
duced by aaSIDRA 2.0.1.206 (Unregistered Version)
yright© 2000-2002
elik & Associates Pty Ltd

erated 6/11/2006 8:19:56 PM

Timing



Intersection Silibin Downstream (Without Countdown Timer)

183 seconds

Time Option: **Program calculated cycle time**
 Green times determined by the program.

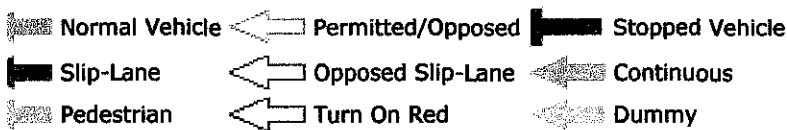
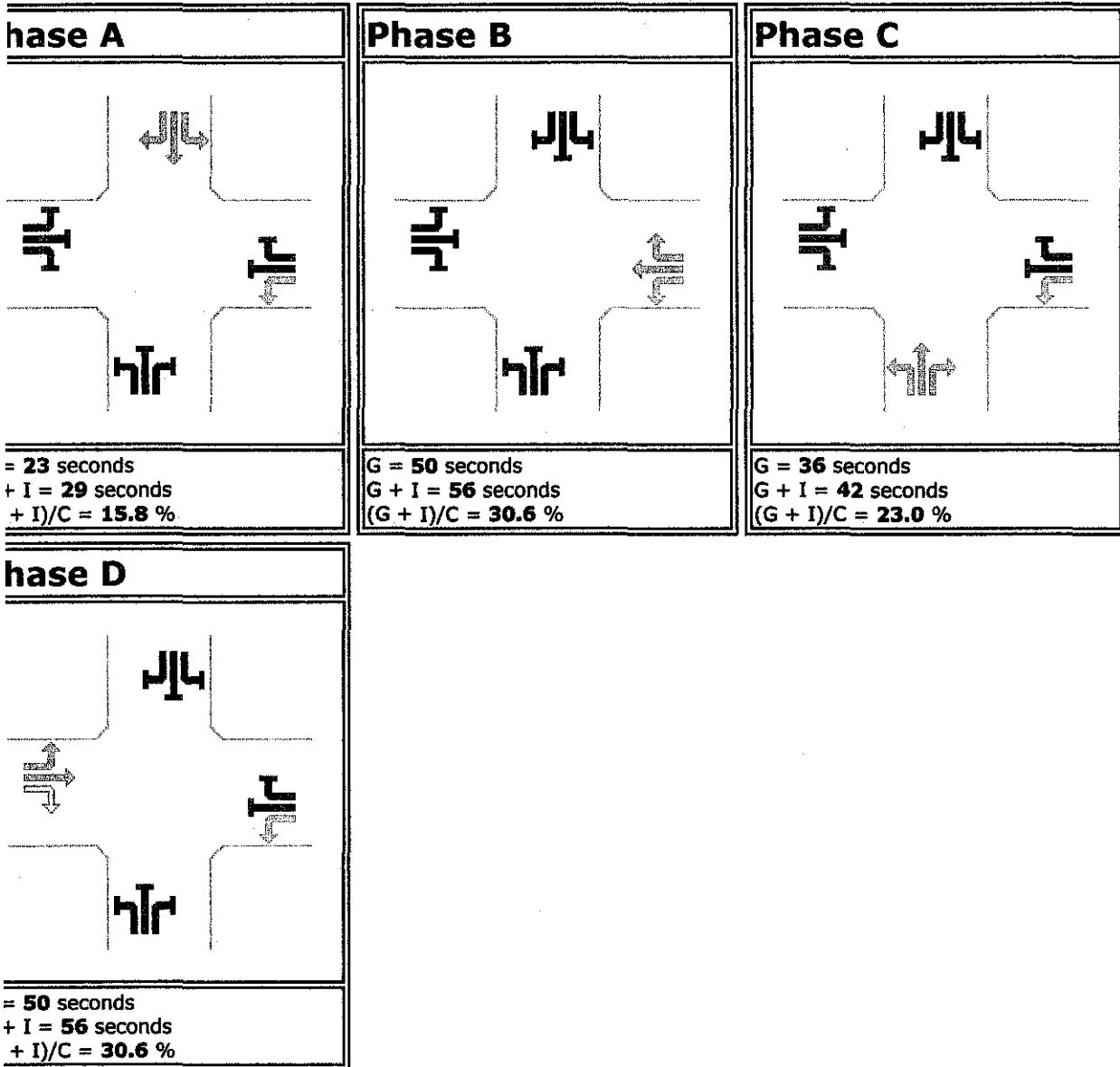

Cycle Time
 Green Time

Level of Service



Based on Delay (HCM method)

Intersection Silibin Downstream (Without Countdown Timer)

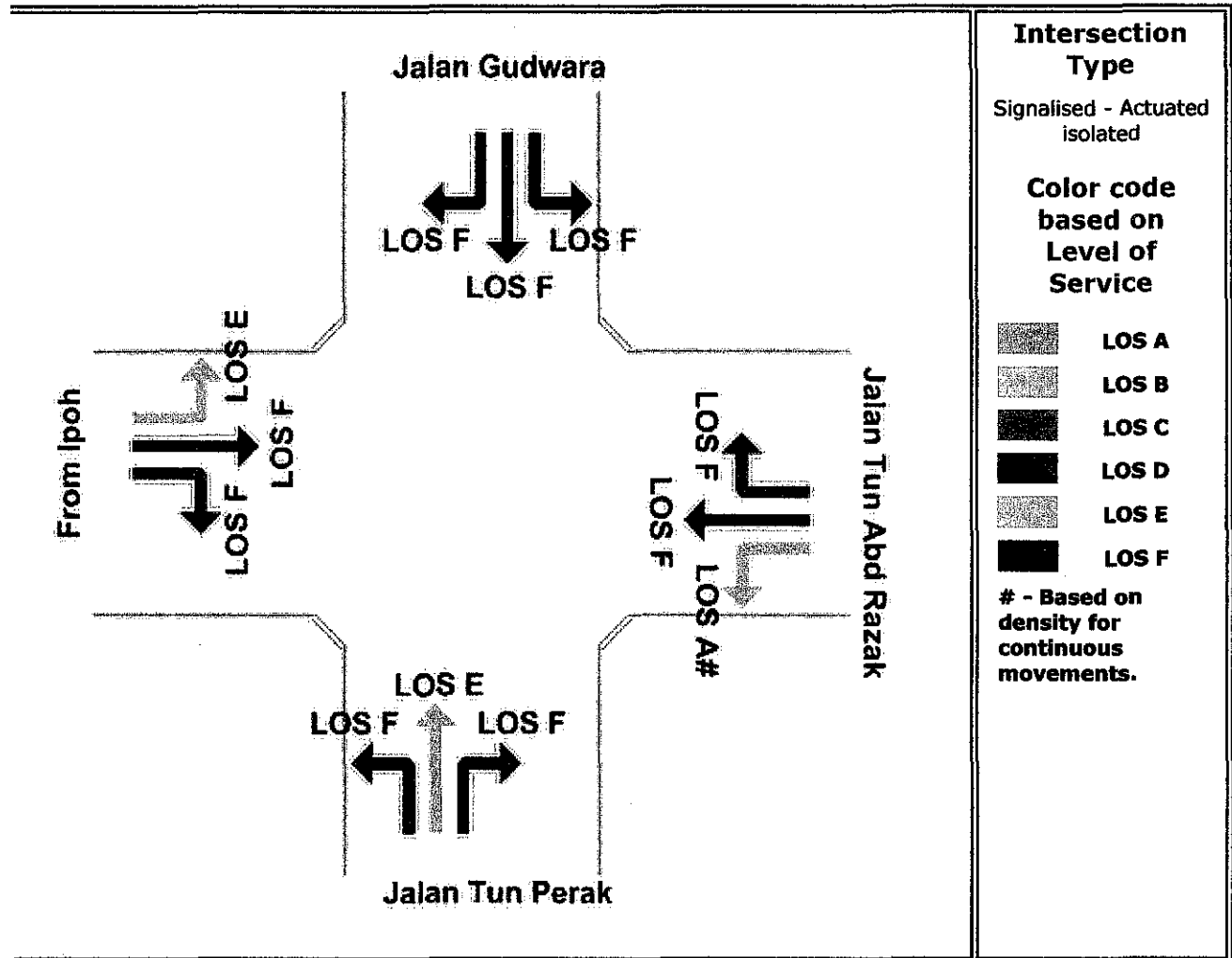

JTP\lala\FYP2\sidraa\silibin_downstream
 Produced by aaSIDRA 2.0.1.206 (Unregistered Version)
 Copyright © 2000-2002
 akcelik & Associates Pty Ltd

Printed 6/11/2006 8:20:47 PM

Appendix C: Station3, Intersection Pasir Puteh

RED LIGHTS VIOLENCE AND COMPLIANCE VOLUME COUNT

STATION:STATION 3 JALAN PASIR PUTEH(UPSTREAM)

DAY: _____ DATE: _____

WHEATER: FINE/CLOUDY/RAIN

NAME OF THE ROAD:JALAN PASIR PUTEH

DIRECTION OF TRAVEL: IPOH-PASIR PUTEH

SHEET NO:1

| TIME | APPROACH | | | | | | | | | | | | | | | | | |
|------------------------|----------|---|---|---|---|---|----|---|---|---|---|---|-----|---|---|---|---|---|
| | ↶ | | | | ↑ | | | | ↷ | | | | | | | | | |
| VEHICLE CLASSIFICATION | 1 | 2 | 1 | 2 | 1 | 2 | 1 | 2 | 1 | 2 | 1 | 2 | 1 | 2 | 1 | 2 | 1 | 2 |
| 900 | 10 | | | | | | | | 1 | | | | | | | | | |
| 910 | 14 | | | | | | | | | | | | | | | | | |
| 920 | 5 | | | | | | | | | | | | | | | | | |
| 930 | 12 | | | | | | | | | | | | | | 1 | | | |
| 940 | 10 | | | | | | | | | | | | | | | | | |
| 950 | 10 | | | | | | | | | | | | | | | | | |
| TOTAL | 64 | | 0 | 0 | | | | | 1 | 0 | | | | | 1 | 0 | | |
| 1000 | 12 | | | | | | | | 1 | | | | | | 1 | | | |
| 1010 | 10 | | | | | | | | | | | | | | | | | |
| 1020 | 11 | | | | | | | | | | | | | | | | | |
| 1030 | 12 | | | | | | | | 1 | | | | | | | | | |
| 1040 | 11 | | | | | | | | | | | | | | | | | |
| 1050 | 10 | | | | | | | | | | | | | | | | | |
| TOTAL | 71 | 0 | 0 | 0 | 0 | 0 | 13 | 2 | 0 | | | | 259 | 2 | 1 | 0 | | 0 |

| 1st HOUR | | 2nd HOUR | | |
|----------|---|----------|----|---|
| 1 | 2 | 1 | 2 | |
| 1180 | 9 | 1035 | 15 | Road user comply with red light |
| 2 | 0 | 3 | 0 | Road user cross the intersection during amber |
| | | | | Road user violate the red light |

RED LIGHTS VIOLENCE AND COMPLIANCE VOLUME COUNT

STATION: STATION 3 PASIR PUTEH (DOWNSTREAM)

DAY: _____

DATE: _____

WHEATER: FINE/CLOUDY/RAIN

NAME OF THE ROAD: JALAN PASIR PUTEH

DIRECTION OF TRAVEL: IPOH-PASIR PUTEH

SHEET NO: 1

| TIME | APPROACH | | | | | | | | | | | | | | | |
|------------------------|----------|---|----|---|---|---|-----|---|----|---|---|---|----|---|---|---|
| | ↶ | | | | ↑ | | | | ↷ | | | | | | | |
| VEHICLE CLASSIFICATION | 1 | 2 | 1 | 2 | 1 | 2 | 1 | 2 | 1 | 2 | 1 | 2 | 1 | 2 | 1 | 2 |
| 900 | 10 | | 1 | | | | 12 | | 8 | 1 | | | | | 1 | |
| 910 | 14 | | | | | | 12 | | 9 | | | | | | | |
| 920 | 23 | | 2 | | | | 10 | | 10 | | | | | | | |
| 930 | 15 | | | | | | 12 | | 8 | | | | | | | |
| 940 | 18 | | | | | | 13 | | 12 | | | | 15 | | 1 | |
| 950 | 18 | | | | | | 10 | | 8 | | | | 13 | | 1 | |
| TOTAL | 98 | | 3 | 0 | | | 72 | | 55 | 1 | | | 43 | | 3 | 0 |
| 1000 | 15 | | | | | | 13 | | 10 | | | | | | | |
| 1010 | 17 | | | | | | 10 | | 8 | | | | | | | |
| 1020 | 13 | | | | | | 13 | | 10 | | | | | | | |
| 1030 | 15 | | | | | | 16 | | 5 | | | | 5 | | 2 | |
| 1040 | 22 | | 2 | | | | 16 | | 8 | | | | | | | |
| 1050 | 21 | | 3 | | | | 17 | | 1 | | | | | | 2 | |
| TOTAL | 297 | | 11 | 0 | | | 108 | | 94 | 0 | | | 83 | | 4 | 0 |

| 1st HOUR | | 2nd HOUR | |
|----------|---|----------|----|
| 1 | 2 | 1 | 2 |
| 922 | 5 | 1088 | 12 |
| 61 | 1 | 57 | 0 |

Road user comply with red light
 Road user cross the intersection during amber
 Road user violate the red light

Intersection Summary



LAN PASIR PUTEH INTERSECTION

| Performance Measure | Vehicles | Persons |
|-----------------------------------|-----------------|------------------|
| Volume and Flow | 2464 veh/h | 3696 pers/h |
| Level of Saturation | 0.921 | |
| Queue Length (Total) | 2808 veh/h | |
| Back of Queue (m) | 226 m | |
| Back of Queue (veh) | 32.3 veh | |
| Control Delay (Total) | 34.28 veh-h/h | 51.41 pers-h/h |
| Control Delay (Average) | 50.1 s/veh | 50.1 s/pers |
| Level of Service | LOS D | |
| Level of Service (Worst Movement) | LOS E | |
| Effective Stops | 2543 veh/h | 3814 pers/h |
| Effective Stop Rate | 1.03 per veh | 1.03 per pers |
| Travel Distance (Total) | 1490.7 veh-km/h | 2236.1 pers-km/h |
| Travel Distance (Average) | 605 m | 605 m |
| Travel Time (Total) | 59.1 veh-h/h | 88.7 pers-h/h |
| Travel Time (Average) | 86.4 secs | 86.4 secs |
| Travel Speed | 25.2 km/h | 25.2 km/h |
| Operating Cost (Total) | 1416 \$/h | 1416 \$/h |
| Fuel Consumption (Total) | 212.2 L/h | |
| Carbon Dioxide (Total) | 530.5 kg/h | |
| Hydrocarbons (Total) | 0.985 kg/h | |
| Nitrogen Monoxide (Total) | 41.25 kg/h | |
| Particulates (Total) | 1.175 kg/h | |

P:\lala\FYP2\sidraa\pasirputeh_downstream
 generated by aaSIDRA 2.0.1.206 (Unregistered Version)
 Copyright © 2000-2002
 akcelik & Associates Pty Ltd

Printed 6/11/2006 8:22:12 PM

ovement Summary



LAN PASIR PUTEH INTERSECTION

alised - Fixed time
 a Time = 90 seconds

hicle Movements

| v No | Turn | Dem Flow (veh/h) | Cap (veh/h) | Deg of Satn (v/c) | Aver Delay (sec) | Level of Service | 95% Back of Queue (m) | Eff. Stop Rate | Aver Speed (km/h) | Oper Cost (\$/h) |
|----------------------|------|------------------|-------------|-------------------|------------------|------------------|-----------------------|----------------|-------------------|------------------|
| n Pasir Puteh | | | | | | | | | | |
| 1 | L | 345 | 378 | 0.913 | 53.1 | LOS D | 222 | 1.09 | 24.3 | 214 |
| 2 | T | 805 | 882 | 0.913 | 44.0 | LOS D | 226 | 1.09 | 27.2 | 426 |
| 3 | R | 94 | 103 | 0.912 | 52.8 | LOS D | 226 | 1.09 | 24.4 | 58 |
| roach | | 1244 | 1363 | 0.913 | 47.2 | LOS D | 226 | 1.09 | 26.1 | 698 |
| n King | | | | | | | | | | |
| 4 | L | 13 | 20 | 0.662 | 55.2 | LOS E | 48 | 0.83 | 23.7 | 8 |
| 5 | T | 101 | 153 | 0.661 | 46.2 | LOS D | 48 | 0.83 | 26.4 | 53 |
| 6 | R | 152 | 165 | 0.921 | 66.6 | LOS E | 68 | 1.01 | 21.1 | 105 |
| roach | | 266 | 337 | 0.921 | 58.3 | LOS E | 68 | 0.93 | 23.0 | 166 |
| n Ipoh | | | | | | | | | | |
| 7 | L | 82 | 94 | 0.877 | 56.9 | LOS E | 119 | 1.01 | 23.3 | 52 |
| 8 | T | 474 | 540 | 0.877 | 47.9 | LOS D | 119 | 1.01 | 25.9 | 259 |
| 9 | R | 82 | 94 | 0.877 | 56.8 | LOS E | 119 | 1.01 | 23.3 | 52 |
| roach | | 638 | 727 | 0.877 | 50.2 | LOS D | 119 | 1.01 | 25.2 | 363 |
| n Temenggong | | | | | | | | | | |
| 10 | L | 44 | 53 | 0.830 | 58.8 | LOS E | 66 | 0.94 | 22.8 | 28 |
| 11 | T | 158 | 190 | 0.831 | 49.8 | LOS D | 66 | 0.94 | 25.3 | 87 |
| 12 | R | 114 | 137 | 0.830 | 58.9 | LOS E | 65 | 0.94 | 22.8 | 73 |
| roach | | 316 | 380 | 0.831 | 54.3 | LOS D | 66 | 0.94 | 24.0 | 189 |
| icles | | 2464 | 2808 | 0.921 | 50.1 | LOS D | 226 | 1.03 | 25.2 | 1416 |

JTP\lala\FYP2\sidraa\pasirputeh_downstream
 luced by aaSIDRA 2.0.1.206 (Unregistered Version)
 yright© 2000-2002
 alik & Associates Pty Ltd

rated 6/11/2006 8:22:22 PM

hasing

LAN PASIR PUTEH INTERSECTION

90 seconds

Time Option: **Program calculated cycle time**

Phase times determined by the program.

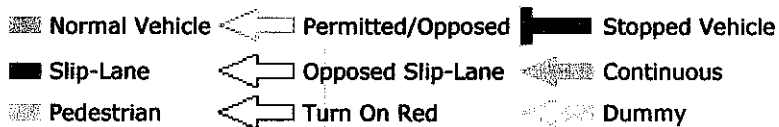
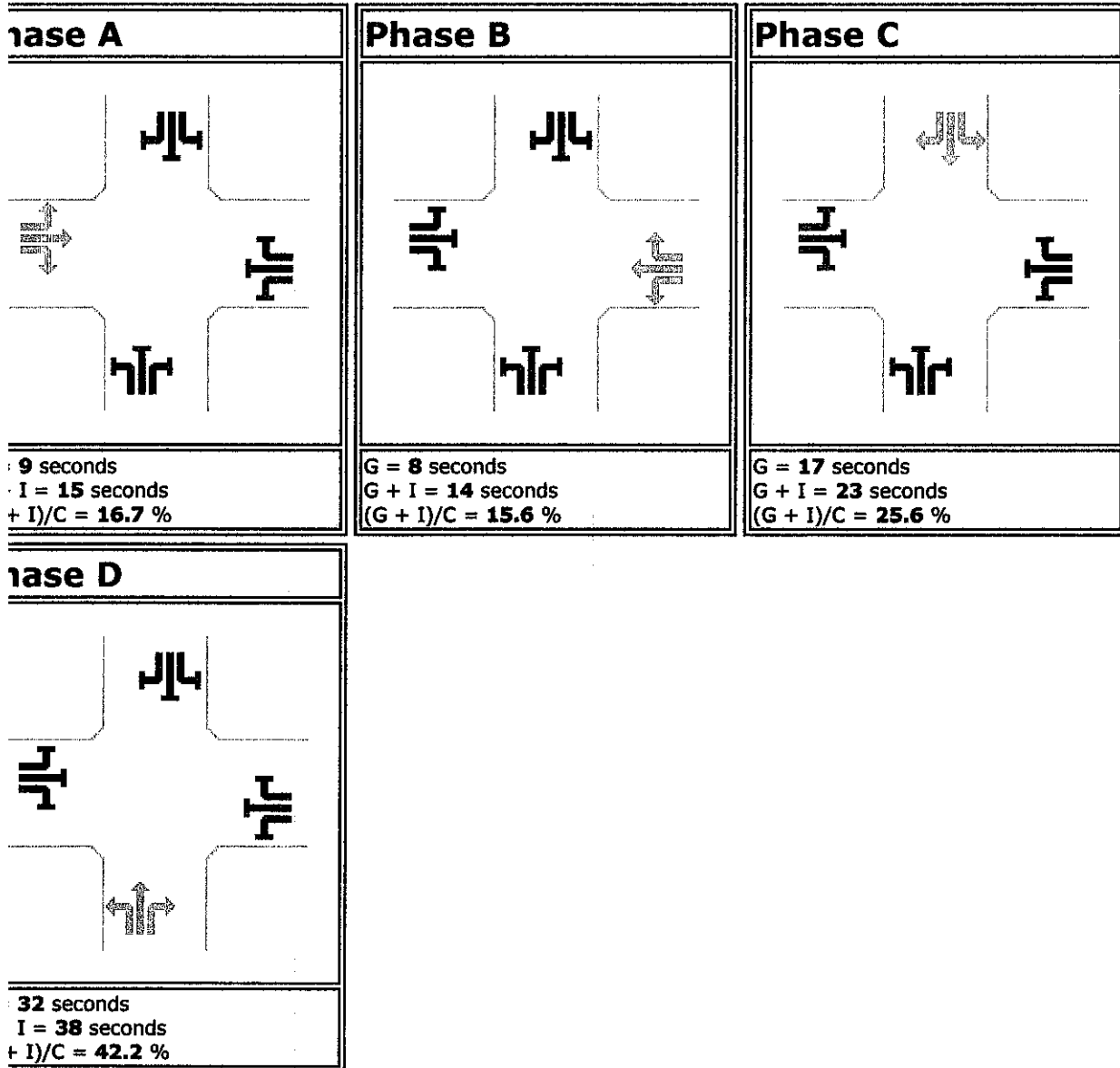

Cycle Time

Green Time

Intergreen Time (yellow plus all-red)

(G + I)/C Phase time as a percentage of cycle

Level of Service



Based on Delay (HCM method)

JALAN PASIR PUTEH INTERSECTION

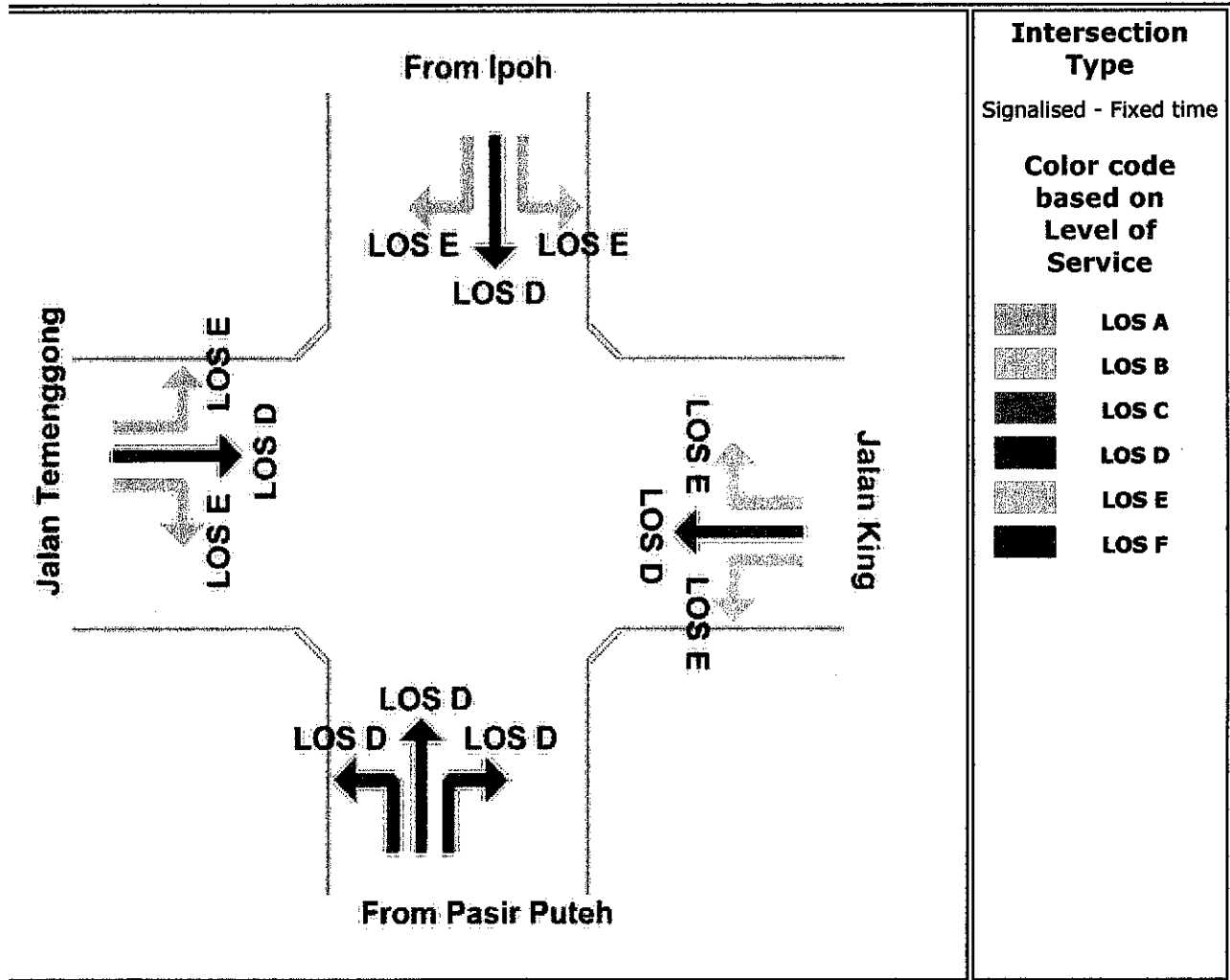

Path: P:\lala\FYP2\sidraa\pasirputeh_downstream
 Created by aaSIDRA 2.0.1.206 (Unregistered Version)
 Copyright © 2000-2002
 akcelik & Associates Pty Ltd

Printed: 6/11/2006 8:22:46 PM