

Mobile Geographical Information System:  
Using Personal Digital Assistant to Monitor Vehicle Navigation

by

BOON XIAN YU

Dissertation submitted in partial fulfillment of  
the requirements for the  
Bachelor of Technology (Hons) Information Technology

JUNE 2004

Universiti Teknologi PETRONAS  
Bandar Seri Iskandar  
31750 Tronoh  
Perak Darul Ridzuan

t

05

70-2

.0724

2004

1) Geographical information system  
2) IT/IS - thesis

# CERTIFICATION OF APPROVAL

Mobile Geographical Information System:  
Using Personal Digital Assistant to Monitor Vehicle Navigation

by

BOON XIAN YU

A project dissertation submitted to the  
Information Technology Program  
Universiti Teknologi PETRONAS  
In partial fulfillment of the requirement for the  
Bachelor of Technology (Hons) Information Technology

Approved by,

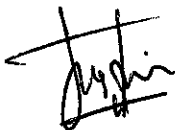

---

(Mr. Justin Dinesh Devaraj)

UNIVERSITI TEKNOLOGI PETRONAS  
TRONOH, PERAK

JUNE 2004

## **CERTIFICATION OF ORIGINALITY**

This is to certify that I am responsible for the work submitted in this project, that the original work is my own except as specified in the references and acknowledgements, and that the original work contained herein has not been undertaken or done by unspecified sources or persons.

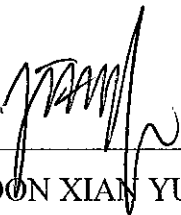

---

BOON XIAN YU

## ABSTRACT

Geographic analysis has been around longer than maps; probably back thousands of years when early humans planned hunting and movement. Perhaps the first GIS were scratches in the dirt or sand. Traditionally, highly skilled cartographers spent many hours drawing maps, and map users labored over the analytical tasks. Modern GIS arrived when computers became powerful, easier to operate, more affordable, and generally available to many users. Technology has created many changes, including geography, data, and methods of analysis. Modern GIS is a new paradigm, even more so when Modern GIS goes mobile. The rapid growth in mobile telecommunications and internet business is living proof of a radical change in today's information society and infrastructure. The current phase in this development is the continued increase in total mobility with wideband services. This paper explores GIS in the mobile environment using commercial-off-the-shelf (COTS) components. It sees the research on GIS, focusing on GIS in mobile environment. It presents the idea of applying GIS concept in vehicle tracking, where mobile GIS will couple up with GPS as a vehicle movement monitoring tool. The Reuse-Oriented Development Model is used as guidance for the project progress. The methodology is suitable as it stresses on component reuse. It encourages timely completion of the project. A simulation of vehicle tracking and navigating concept would be presented as the findings of the research. The simulation presents the idea of real-time tracking of a moving vehicle using data output from the GPS.

## **ACKNOWLEDGEMENT**

The project is dedicated to my family and loved ones, who have constantly given me spiritual support, advice, and help without barrier throughout the process of completing the project. Without them, it would have been tougher than it already is. Thank you very much.

Heartfelt gratitude goes out to my supervisor, Mr Justin Dinesh Devaraj for his patient guidance, and knowledge sharing. His valuable feedback and commitment has motivated me to strive for the best I could. He had given me a whole new perspective in looking at things.

I would also like to record my deepest appreciation to Dr Nasir bin Matori from the Civil Engineering Faculty, for his approval in lending the registered vector map, and sharing his knowledge on GPS and position locating. Thank you to Kak Sa'diah Saat, a researcher in the Civil Engineering Faculty, for her assistance, suggestions, and knowledge sharing in the GPS receivers and raster maps.

Throughout the project development process, I have received tremendous feedback from kind hearted experts in the field. Thank you especially to Dale DePriest for the timely feedback via E-mail, and also to Joe Zastrow (ESRI) for answering my questions in the forum. Frederick Teng, a dear friend and a VB guru, who has helped me in VBScript without hesitation, thank you very much.

The support and assistance coming from all parties have contributed to this project one way or another, resulting in the success of the project for a rather short timeframe. Thank you all.

## TABLE OF CONTENTS

<b>ABSTRACT.</b>		i
<b>ACKNOWLEDGEMENT.</b>		ii
<b>TABLE OF CONTENTS.</b>		iii
<b>LIST OF FIGURES.</b>		vi
<b>LIST OF TABLES.</b>		vi
<b>ABBREVIATIONS AND NOMENCLATURES.</b>		vii
<b>CHAPTER 1</b>	<b>INTRODUCTION.</b>	<b>1</b>
	1.1 Background Study.	1
	1.2 Problem Statement.	2
	1.3 Objectives and Scope of Study.	3
	1.3.1 Objective.	3
	1.3.2 Scope of Study.	3
<b>CHAPTER 2</b>	<b>THEORY / LITERATURE REVIEW.</b>	<b>4</b>
	2.1 Geographical Information System.	4
	2.1.1 Components of GIS.	5
	2.2 GIS Going Mobile.	7
	2.2.1 Components of Mobile GIS.	8
	2.2.2 Benefits of Mobile GIS.	11
	2.3 Global Positioning System (GPS).	12
	2.3.1 What is a GPS?.	12
	2.3.2 How does a GPS works?.	13
	2.4 Real-world Implementation of GIS.	15
	2.4.1 Management of Ambulances.	15
	2.4.2 Urban Disaster Management.	16
	2.4.3 Evolving GIS at KNP.	17

<b>CHAPTER 3</b>	<b>METHODOLOGY AND PROCEDURE.</b>	18
3.1	Reuse-Oriented Development Model.	18
3.1.1	Phase 1 – Requirements Specification.	19
3.1.2	Phase 2 – Component Analysis.	19
3.1.3	Phase 3 – Requirements Modification.	20
3.1.4	Phase 4 – System Design With Reuse.	21
3.1.5	Phase 5 – Development and Integration.	21
3.1.6	Phase 6 – System Validation.	21
3.2	Benefits of using Reuse-Oriented Development Model.	22
3.3	Tools Required.	22
<b>CHAPTER 4</b>	<b>RESULTS AND DISCUSSION.</b>	24
4.1	Results and Discussion – Requirements Specification.	24
4.2	Results and Discussion – Component Analysis.	25
4.2.1	Hardware Component Analysis.	26
4.2.2	Connection Component Analysis.	29
4.2.3	Software Component Analysis.	30
4.3	Results and Discussion – Requirements Modification.	33
4.4	Results and Discussion – System Design with Reuse.	34
4.5	Results and Discussion – Development and Integration	35
4.5.1	Simulation Alternative 1.	35
4.5.2	Simulation Alternative 2.	37
4.6	Results and Discussion – System Validation	38
4.7	Discussion – Problems Faced.	39
<b>CHAPTER 5</b>	<b>CONCLUSION AND RECOMMENDATIONS.</b>	41
5.1	Conclusion.	41
5.2	Recommendation.	42
<b>REFERENCES.</b>		44

**APPENDICES.** . . . . . 47

Appendix 1 Final Year Project Gantt Chart. . . . . 48

Appendix 2 Selected pages of ESRI ArcPad Quick Guide. . . . . 49

Appendix 3 NMEA Messages supported by ArcPad 5. 52

Appendix 4 NMEA Deciphered. . . . . 53

Appendix 5 Steps to connect GPS to ArcPad. . . . . 54

Appendix 6 Bluetooth vs. Wi-Fi. . . . . 55

Appendix 7 ArcXML Applet Source Code . . . . . 56

Appendix 8 VBScript Source Code. . . . . 57

Appendix 9 Sample GPS Data. . . . . 60



## LIST OF FIGURES

Figure 2.1	Components of Mobile GIS. . . . .	9
Figure 2.2	Available GPS receiver in the market. . . . .	13
Figure 2.3	24 Earth-orbiting satellites. . . . .	13
Figure 2.4	GPS location detecting. . . . .	14
Figure 3.1	Reuse-Oriented Development Model flowchart. . . . .	19
Figure 4.1	Components of Mobile GIS for This Project (in circle). . . . .	25
Figure 4.2	HP iPAQ H4150. . . . .	28
Figure 4.3	Leica GS50. . . . .	28
Figure 4.4	TopCon HiPer. . . . .	28
Figure 4.5	Connection architecture from GPS to PDA. . . . .	29
Figure 4.6	Custom made cable. . . . .	30
Figure 4.7	GPS Tracklog. . . . .	31
Figure 4.8	Conceptual data flow model. . . . .	34
Figure 4.9	Architecture design of the system. . . . .	35
Figure 4.10	Customized Toolbar using ArcXML Applet. . . . .	36
Figure 4.11	ArcPad 6.03 customized interface with Ipoh route map. . . . .	36
Figure 4.12	Points plotted onto the map. . . . .	37
Figure 4.13	TYPE command in DOS. . . . .	38

## LIST OF TABLES

Table 4.1	ESRI ArcPad 6.0 system requirements	27
Table 4.2	List of PDA (chosen PDA is grayed)	27

## ABBREVIATIONS AND NOMENCLATURES

COTS	: commercial-off-the-shelf
ESRI	: Environmental Systems Research Institute
GIS	: geographic information system
GPS	: global positioning system
GSM	: global system for mobile communication
KNP	: Kruger National Park
LAN	: local area network
MP3	: MPEG-2 layer 3
MPEG	: moving picture experts group
NMEA	: National Marine Electronics Association
OS	: operating system
PC	: personal computer
PDA	: personal digital assistant
PDE	: positioning determining equipment
PPT	: Positioning-Processing Technology
RS	: remote sensing
TCP/IP	: transmission control protocol/Internet protocol
TSIP	: Trimble Standard Interface Protocol
USB	: universal serial bus
USGS	: United States Geological Survey
UTP	: Universiti Teknologi PETRONAS
VB	: Visual Basic
Wi-Fi	: wireless fidelity
WLAN	: wireless local area network
XML	: eXtensible markup language

# **CHAPTER 1**

## **INTRODUCTION**

### **1 INTRODUCTION**

Chapter 1 sees the basic information of the project. It consists of the background of study, the problem statement for the project, and also its objective and scope of study. The report started off with basic definition of GIS, followed by the identification of real world problems with paper maps, and the project's significance in solving such a problem in the problem statement section. The objective and scope of study section will outline the aim of the project as well as the scope of which the project covers.

#### **1.1 Background of Study**

This paper sees that vehicle tracking can be put into reality by combining all these high-end technology – mobile devices, Geographical Information System (GIS), and Global Positioning System (GPS). Vehicle movements can be monitored as the vehicle travels along a route. Maps can be updated as new routes are traveled.

GIS technology can be used for scientific investigations, resource management, and development planning. A GIS might allow emergency planners to easily calculate emergency response time in the event of a natural disaster, or a GIS might be used to find wetlands that need protection from pollution.

All devices, which are portable and easily carried around, are considered mobile. This includes laptops, watches, personal digital assistant (PDA), and cell phones, just to name a few. The project makes use of the PDA as the mobile device.

A GIS links location (spatial) and database (tabular) information and enables a person to visualize patterns, relationships, and trends. This process gives an entirely new perspective to data analysis that cannot be seen in the table or list format. The five components of GIS are hardware, software, data, methods, and people. Without any one of these components, it is no longer a GIS.

Recent advancements in GPS technology, wireless communications and ruggedized handheld devices have made mobile GIS a reality. The GPS receiver provides location information as a set of coordinates in latitude and longitude format in real-time. By providing user-focused information at real-time, mobile GIS is the state of the art technology that supports individual and corporation clientele to acquire information management function that collects information on surrounding facilities.

Mobile GIS provides the flexibility in viewing data with standard GIS features of pan, zoom, filtering and searching/browsing features. It has the flexibility of object representation allowing real-world objects to be easily highlighted for field activities.

## **1.2 Problem Statement**

Conventional way of communicating locations with maps and plans via naked eyes is time consuming and inefficient. They have minimum information, tend to deteriorate and inflexible. With rapid development in the country, routes change constantly, hence most maps are out of date soon after they are published. Such problem will be eliminated with the development of Mobile GIS, providing efficiency, and conveniences in locating places and routes.

Field updates of the maps can be done on the spot with the help of a GPS receiver. Changes of routes can be captured, and stored in the handheld device right away. This not only saves time, but promotes productivity along side with efficiency. GPS receiver helps monitor vehicle movements and navigation.

This project is to exploit GIS as the software, PDA and the GPS receiver as the hardware for the system to operate to provide efficiency and conveniences with Digital Maps. Mobile GIS is still at its infant stage in the country, but as the PDA and GPS receivers get cheaper every fortnight, Mobile GIS solution will be in popular demand in the future.

### **1.3 Objective and Scope of Study**

#### **1.3.1 Objective**

The objectives of the project are as follows:

- a) To study and understand the underlying concepts of Geographical Information System (GIS) and the Global Positioning System (GPS)
- b) To research on Mobile GIS, and the relation between the handheld devices, GIS and GPS in Mobile GIS
- c) To utilize of the state of the art technology – Personal Digital Assistant (PDA), with GIS, and also the GPS for vehicle tracking
- d) To integrate theory with practical – to develop or set up a system which simulate real-time interaction between the PDA and the GPS receiver.

#### **1.3.2 Scope of Study**

The project scope will not only include the research on GIS, but mainly GIS in mobile environment. This answers questions such as “What is GIS?” “What are the benefits of using GIS?” “How to implement GIS?” and also “How can GIS go mobile?” In addition, there will be the study of integration of Mobile GIS with GPS – to locate and track the exact location of the user. This will simulate the users’ interaction with the system in real-time, as in receiving customized feedback in a timely manner. With the given time frame of approximately 14 weeks, the functionality of the system will include tracking the path the user traveled. Additional functionalities will be included as time allows.

## **CHAPTER 2**

### **LITERATURE REVIEW**

#### **2 LITERATURE REVIEW**

This chapter focuses on GIS, which sees the definition and components of the system, followed by GIS going mobile. It covers more in depth GIS in a mobile environment, providing information about the components necessary for Mobile GIS. Benefits of mobile GIS will be covered. The chapter will also provide some background information on the GPS receiver. The last section of the chapter will presents some of the acknowledged findings on this field while looking into some examples of real-world implementation of the technology.

#### **2.1 Geographical Information System**

It is not easy to give GIS an unarguable definition as it associated with so many disciplines, such as information technology, system engineering, survey and photogrammetry, cartography, engineering, socioeconomy and geography (Juppenlatz & Tian, 1996). So what is GIS? A GIS is a computer system capable of capturing, storing, analyzing, and displaying geographically referenced information that is data identified according to location (USGS, 2004).

ESRI White Paper – Geography Matters gives another definition. GIS is defined as a computer software that links geographical information (where things are) with description information (what things are). Unlike a flat paper map, where “what you see is what u get,” a GIS can present many layers of different information (2002, p.1).

Simply put, GIS is a computer system complete with hardware and software, which captures geographical information, and stores the location's descriptive information in many different layers, to allow users to analyze the available data for certain purposes, through a monitor or other means of display.

It was mentioned before that there are five components are hardware, software, data, methods, and people. Each of these components will be looked into detail in the following section.

### **2.1.1 Components of GIS**

#### ***Hardware***

The hardware component of GIS is the computer and peripherals on which the GIS operates. This could be desktop computers, laptop computers, handheld devices, networks, peripheral devices such as printers, plotters, digitizers; it can also be a centralized computer server running the UNIX or Windows NT operating system. The computer may operate in isolation or in a networked configuration. In short, this aspect of GIS includes all devices used to set up the system. The hardware is used to store, process, and display maps.

#### ***Software***

The GIS software component provides the functions and tools users need to store, analyze, and display geographical information. The key software components are GIS software – such as ESRI's ArcGIS, database software (Oracle 9i), the Operating Software, e.g. UNIX, Windows NT, and Windows CE. It also includes the Network Software such as the Novell NetWare. The software is expected to run on compatible hardware, to perform GIS operations.

## ***Data***

Data is one of the most important components in a GIS. It is absolutely essential that data be accurate. Data for a GIS comes in three basic forms – spatial data, tabular data, and image data (GIS.com, 2004). Spatial data is made up of points, lines, and areas. It is the heart of every GIS. It is what maps are made of. Spatial data forms the locations and shapes of map features such as buildings, streets, or cities.

Tabular data is information describing a map feature (GIS.com, 2004). For instance, a map of customer locations may be linked to demographic information about those customers. Image data on the other hand, includes diverse elements such as satellite images, aerial photographs, and scanned data.

## ***Methods***

Methods are well designed plans and application-specific business rules describing how technology is applied. This includes guidelines, specifications, standards, and procedures. There are very few standards in the world that apply to many aspects of this industry (Juppenlatz & Tian, 1996).

According to Juppenlatz, and Tian (1996), the standards of GIS are coming from two major sources: one is the governing body in a country, such as the National Standards Agency, and the other is from industry, which adopt some de facto standards. It is also mentioned that the most important standards associated with GIS are the data exchange standards, software standards, and the hardware standards.

## ***People***

A GIS is a front-running and interdisciplinary technology, and it requires qualified people in several areas of operational levels (Juppenlatz & Tian, 1996). GIS technology is clearly of limited value without the people to



manage the system and to develop plans for applying it. Users of GIS range from highly qualified technical specialists to planners, foresters, and market analysts who use GIS to help their everyday work. They could be Administrators, Managers, GIS Technicians, Application Experts, End Users, and wide range of consumers.

## **2.2 GIS Going Mobile**

Mobile GIS is an extension of the GIS enterprise. It is a part of a system, and in fact is dependant on a system for its success. It is not an island unto itself. The field device is an integral component of the GIS system. The location is central to the operation of Mobile GIS (Goughnour, 2004).

With Mobile GIS, one is able to store vast amount of data on a small notebook or handheld devices that can provide all the information, not just the minimum that is typically annotated on maps and plans (Spencer, 2003). It is also a much more durable/robust computer-based medium than paper maps. Paper maps tend to deteriorate due to wear and tear – fold lines will smudge the ink printed on the paper maps, the maps might get soaked in rain water during field travel, and it gets out of date almost too soon, just to name a few instances.

Viewing a digital map on a handheld device has much more flexibility with standard GIS features of pan, zoom, filtering, and many searching/browsing features both attribute and graphically based. A digital map is easy to use according to an ESRI White Paper – Geography Matters (2002)

As on the paper map, there are dots or points that represent features on the map such as cities, lines that represent features such as roads, and small areas that represent features such as lakes. This information is stored as layers in digital format as a pattern of ones and zeroes in a computer. Each layer represents a particular theme or feature of the map. One could be roads; another could be all lakes in the same area. (p. 1)

These themes can be laid on top of one another, creating a stack of information about the same geographic area. Each layer could be turned on and off, as if you were peeling a layer off the stack or placing it back on. The amount of information about an area that you want to see, at any time, on any specific map, could be controlled.

(p. 2)

Mobile phones, laptop computers and personal digital assistants (PDA) have set high standards for mobile devices, and offer a myriad of options for improving communication across organization and with customers and trading partners. Such gadgets enable the employees to access the company network from anywhere and at any time. (ESBI Computing, 2004)

Productivity and timeliness have become benchmarks by which we rate the value of any new mobile technologies. As such, mobile GIS is the center of attention as users and developers alike are focusing on creating and deploying full-featured “m-GIS” applications. (ESBI Computing, 2004)

### **2.2.1 Components of Mobile GIS**

In a large scale mobile GIS, there will be four components. These are the client (Mobile end-user devices), the location (Position Determining Equipment), the network (Telecommunication Server Providers), and the servers (GIS Content Providers). The relationship of each component is as in Figure 2.1.

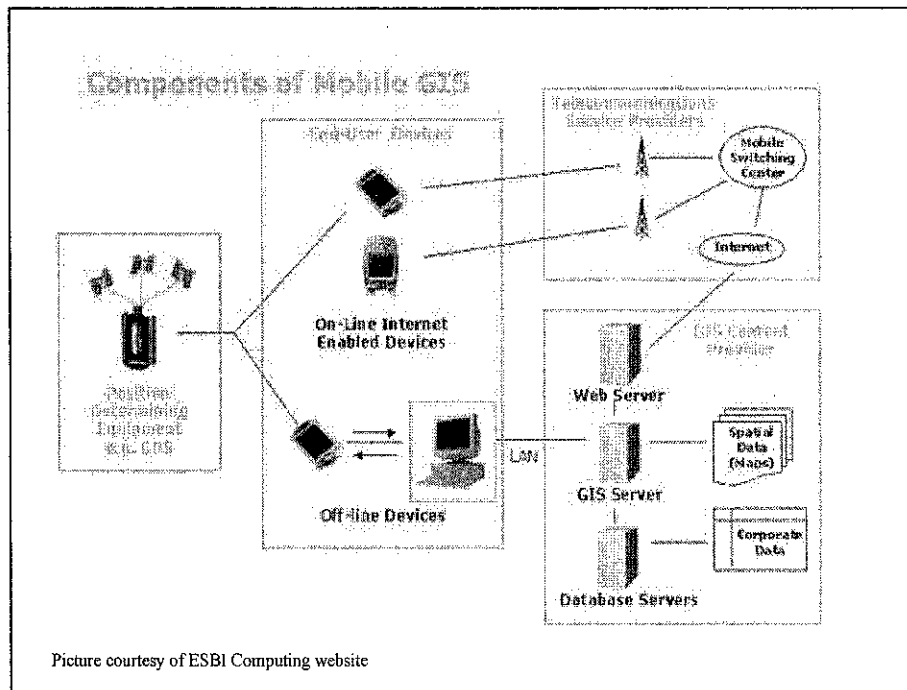

Figure 2.1: Components of Mobile GIS

Mobile or wireless GIS is very similar to wire-line Web GIS (ESBI Computing, 2004). Both have the client, the server, and the network. The main differences are the client devices and the network type. Mobile GIS uses wireless communication service providers, though not a compulsory in all cases. The server functions and structures are similar to Internet GIS. The mobile applications are a little like the “thin client” applications of Internet GIS. The only additional component in mobile is the location.

### *The Clients – End User Devices*

These are the client devices utilized in the field. There is a full range of client devices that can be used for mobile GIS, from mainstream laptop computers with all the computing power of a PC to PDAs or Pocket PCs with smaller screens but more portable, to cellular telephones with even smaller displays but compensate with portability, simpler input devices and limited processing power.

Two main possible ways to access and use of GIS data and functions through mobile and wireless devices are on-line, with real-time access to

service/corporate data, or off-line, where data is downloaded and used without a real-time connection to a server/corporate database.

The online internet enabled devices can access and display Internet services in real-time. Users can make requests for data, modify the data, and return results. Using this method, the need to store large amounts of data on the device and to return to the office to synchronize files is eliminated (ESBI Computing, 2004).

Offline devices users download the data they require onto the device, and then use a GIS application installed on the device to view and manipulate this data in the field. This method will need to synchronize the changes made to the data with the PC in the office, but eliminates the need to establish live internet connections in the field.

#### ***The Location – Positioning Determining Equipment (PDE)***

An example of a PDE is a Global Positioning System (GPS) receiver. Mobile GIS usually, but not necessarily, coupled with GPS and wireless communication to facilitate exchanges between the existing spatial server and mobile devices. Position-determining components determine the location of the mobile devices in real-time. Generally, there are two ways to determine the mobile device's location. First, a handset-based system that relies on GPS, which is placed at the mobile handset; second, a network-based system that relies on triangulation of the cellular information, where the PDE is at the switch centers. Positioning-Processing Technology (PPT) can then be used to process, track, manage, and help other applications to query and retrieve the location information sent from a PDE.

#### ***The Network – Telecommunication Service Providers***

This is the wire-line or wireless communication networks. Internet Enabled Devices rely on the wireless network to transport information. Performance is a function of the wireless network architectures because difference

wireless networks have different transmission rates (ESBI Computing, 2004).

### ***The Server – GIS Content Providers***

This component of mobile GIS solution serves data and applications to the user. For instance, it offers location information content and information processing services. The type of information and services provided varies depending on the type of application being used (ESBI Computing, 2004).

GIS Content Providers are usually GIS Servers with GIS content, Information Processing Services, and Gateway Services. GIS servers contain the GIS content of Location Information Components. Location Information is content information about a specific location. It could be geographic information such as mapping, addresses or street networks; it could also be specific attribute information about a location such as services, customer details, asset details and so on. GIS servers could be web servers, application servers, map servers, or data servers.

Information Processing Services on the other hand are the components that process and output data to feed to mobile devices via Gateway Services. The services include location, query and display, geo-coding, spatial search, routing, and map display and rendering. Gateway Services are middleware services that link wireless devices to Information Processing Services and the GIS Servers (ESBI Computing, 2004).

### **2.2.2 Benefits of Mobile GIS**

Mobile GIS can be used for a variety of tasks. Just to name a few, it can be used to locate yourself using the GPS or mobile cell location, or to track the location of vehicles, also to find and view information relevant to the user's immediate location.

It can also be used to find and query. For example, to search for a place or feature visually either by landmark, point of interest, or asset. Users can also find the place easily by name or address. Mobile GIS also provide real-time location based information on points of interest such as hotels, restaurants or local services.

Mobile GIS has navigation to a feature. It provides navigation capabilities to varying degrees of sophistication. This could vary from a simple map-viewing capability allowing users to display their locations directly on a map, to sophisticated routing that provides turn-by-turn instructions for a street network to reach a designated spot.

With the navigation feature from Mobile GIS, there could be increased productivity due to less driving. Mobile GIS coupled with Artificial Intelligence can guide the user to avoid certain traffic conditions; it could help the user to identify the shortest route to a location. With less time spent on the road, more time can be spent on doing other more important things.

## **2.3 Global Positioning System (GPS)**

A GPS is used to calculate the coordinate of the user's position using the satellites orbiting the Earth. For the purpose of the project, the GPS is mainly used to track the vehicle's movement.

### **2.3.1 What is a GPS?**

When talking about "a GPS", it is usually meant a GPS receiver. It is a constellation of 27 Earth-orbiting satellites (24 in operation and 3 extras in case one fails). The United States military developed and implemented this satellite network as a military navigation system, but soon opened it up to everybody to use. A GPS receiver's job is to locate four or more of these satellites, figure out the distance to each, and use this information to deduce

its own location (howstuffworks.com, 2004). Figure 2.2 shows some of the available models of GPS in the market.

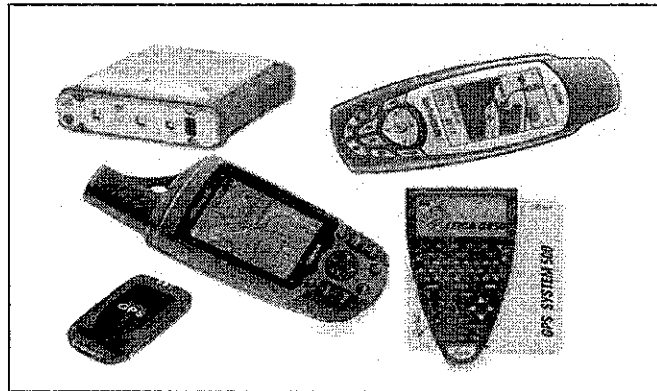

Figure 2.2: Available GPS receiver in the market

### 2.3.2 How does a GPS works?

Each of those 3,000 to 4,000 pound solar-powered satellites shown in Figure 2.3, circles the globe at about 19,300 kilometers per hour (howstuffworks.com, 2004). This means they are making two complete rotations around the world each day. The orbits are arranged so that at any given time, anywhere on Earth, there are at least four satellites “visible” in the sky (Figure 2.3).

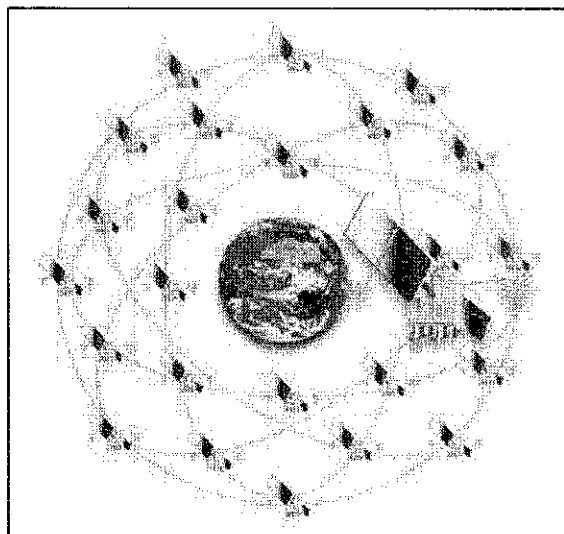

Figure 2.3: 24 Earth-orbiting satellites

A GPS receiver's job is to locate four or more of these satellites, figure out the distance to each of the satellites, and use that information to deduce its own location (howstuffworks.com, 2004). This operation is based on a mathematical principal – Trilateration. By using three-dimensional trilateration, the location of the GPS will be the intersection between the spheres “surrounding” each of the at least three satellites detected by the GPS. The concept is shown in 2D in Figure 2.4.

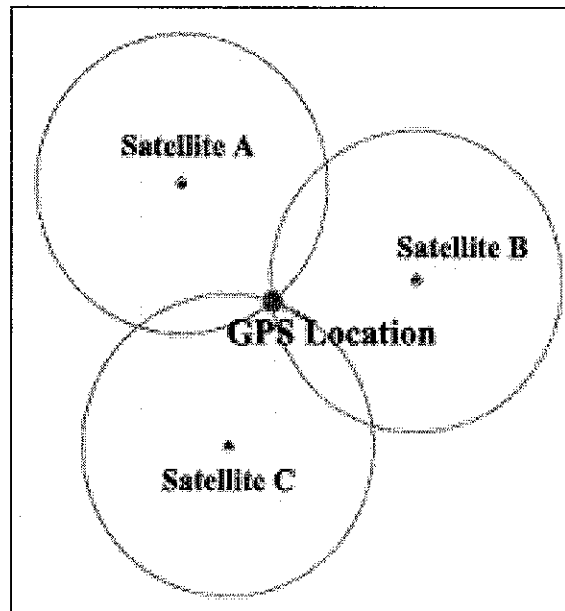

Figure 2.4: GPS location detection

In order for the GPS to make calculation for its location, the GPS receiver has to know the location of at least three satellites above it, and also the distance between the receiver and those satellites. The GPS receiver figures those out by analyzing high-frequency, low-power radio signals from the GPS satellites.

Radio waves are electromagnetic energy, which means they travel at the speed of light (howstuffworks.com, 2004) of approximately 300,000 kilometers per second in a vacuum. The receiver can then figure out how far the signal has traveled by timing how long it took the signal to arrive with the speed of light.



Once the receiver makes the calculation, it can tell the latitude, longitude and altitude (or some similar measurement) of its current position. To make navigation more user-friendly, most receivers plug this raw data into map files stored in its memory. A standard GPS receiver will not only place the user on a map at any particular location, it will also trace the path across a map as the user moves (howstuffworks.com, 2004).

## **2.4 Real-world Implementation of Mobile GIS**

While Mobile GIS is still at the infant stage in Malaysia, this state of the art technology has long been deployed in the developed nations such as the United States, the United Kingdom, and some of the European countries.

### **2.4.1 Management of Ambulances**

Derekenaris, Garofalakis, Makris, Prentzas, Sioutas, and Tsakalidis (2000) wrote a paper describing a system offering a solution to the problem of ambulance management and emergency incident handling in the prefecture of Attica Greece. It is based on the integration of GIS, GPS and global system for mobile communication (GSM) technologies. A significant operation for the handling of emergency incidents is the routing of ambulances to incident sites and then to closest appropriate hospitals (p. 267).

The system was the result of a project funded by the Greek Secretariat of Research and Technology. It will operate in the National Center of Immediate Assistance in Greek, which deals with emergency medical incidents by coordinating and routing ambulances to appropriate hospitals and health units as well as offering medical care to patients during their transport to hospitals (Derekenaris et al. 2000, p. 268). Thus, a similar system could be put in place to navigate users to a location using similar technology.

Some of the primary functions performed by the GIS operating in the system will be the following:

1. Depiction on a map of ambulance positions and hospital locations
2. Ambulance districting
3. Finding the site of the incident
4. Choosing the appropriate ambulance to handle an emergency incident
5. Routing an ambulance to the incident site and from there to the closest appropriate hospitals
6. Generation of statistics regarding incidents

(Derekenaris et al. 2000, p. 271).

#### **2.4.2 Urban Disaster Management**

Montoya from International Institute for Geo-Information Science and Earth Observation explored the use of off-the-shelf low-cost and rapid method of data collection for the development of a building inventory based on the combination of remote sensing (RS), global positioning systems (GPS), digital video and GIS.

GIS have considerable potential for improving urban disaster management since they offer more efficiency and speed in the input, management, manipulation, analysis and output of data/information, but also because of the value of better decisions (Montoya, 2003, p. 871).

Montoya (2003) also pointed out that with the introduction of palm-top computer systems, it is now possible to capture, manipulate, analyze and visualize data in the field (p. 872). Montoya (2003) believes that mobile GIS enables the distribution of processing capabilities and real-time support for data gathering in the field (p. 872).

Mobile GIS is a growing technology, which makes use of existing off-the-shelf techniques and equipment, and mainly focuses on the linking of various

existing resources and data rather than in the development of new stand-alone devices (Montoya, 2003, p. 876).

### **2.4.3 Evolving GIS at KNP**

The vision of those working in the Kruger National Park (KNP) is that all South Africans can have a joint stake and stewardship in one of Africa's most important ecological resources. GIS is playing an important role in the evolution and realization of this vision (Longley, Goodchild, Maguire & Rhind, 2001).

KNP has been active in GIS since the early 1990s. In the early days, GIS software products from four vendors were used to accomplish different specialist or niche products in the areas of ecological analysis and facilities management (Longley, Goodchild, Maguire & Rhind, 2001).

Today, KNP has several Internet applications providing distributed access to geographic data and functions, such as the one where visitors can view and query live maps and even add information about game sightings and then query the locations of, say, buffalo on a particular day (Longley, Goodchild, Maguire & Rhind, 2001).

## **CHAPTER 3**

### **METHODOLOGY**

#### **3 METHODOLOGY**

Chapter 3 contains the detailed description of the Reuse-Oriented Development Model methodology. This chapter will explain in detail the six phases under the methodology, and the actions taken under each phases, together with its expected final output in each phase. It will also see the benefits of using this methodology. The last section of the chapter covers the tools required for each component of GIS for the success of the project. The methodology as detailed step by step guide provides a systematic way in managing the project efficiently.

#### **3.1 Reuse-Oriented Development Model**

As mentioned by Montoya (2003): “Mobile GIS is a growing technology, which makes use of existing off-the-shelf techniques and equipment” (p. 876). The system will require some software reuse. Thus, the most suitable methodology for the particular system would be the Reuse-oriented Development model. The reuse-oriented approach relies on a large base of reusable software components, which can be accessed and some integrating framework for these components.

The initial requirements specification stage and the validation stage are comparable with other development models. The stages in between the two mentioned stages in a reuse-oriented model are different. Figure 3.1 shows the flowchart for the reuse-oriented development model.

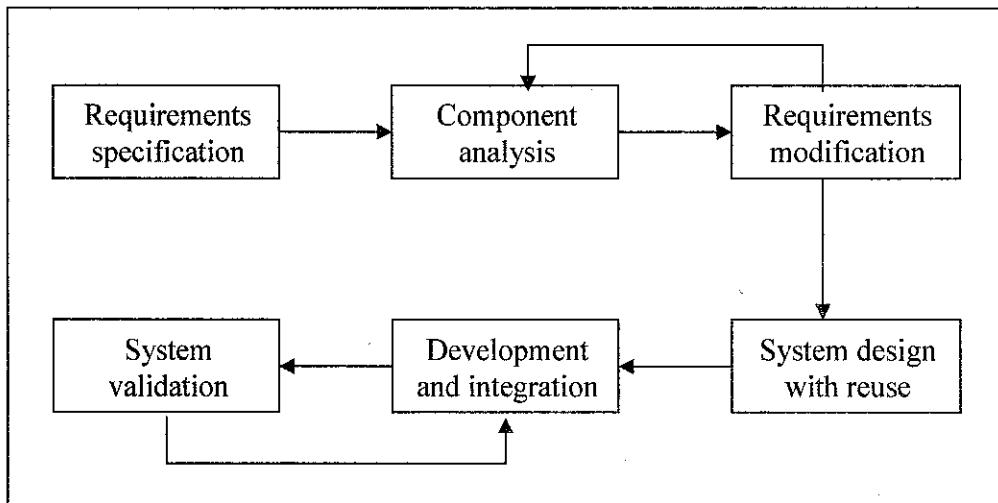

Figure 3.1: Reuse-Oriented Development Model flowchart

### 3.1.1 Phase 1 – Requirements Specification

During the requirements specification stage, expected functionalities of the mobile GIS system are outlined, and examined against time constraint. These specifications are first listed, and then sorted by the level of importance to the system.

For example, the search function takes precedence to the navigation function in the system; the navigation function takes precedence to the GPS tracking function.

The system requirements specification phase serves as a guide for initializing the project. The requirements can be modified from time to time, and is expected to revise after the second phase of the methodology – Component Analysis.

### 3.1.2 Phase 2 – Component Analysis

After the requirements are specified, the software, hardware and tools are identified and analyzed in the component analysis phase. The appropriate

equipments will be identified, and the best will be picked after some research and analysis were done.

These equipments will be analyzed based on the appropriate functions that it will provide for the development of the system. For example, if there are two types of hardware identified as possible tool for the system, the hardware will be compared and contrasted. Let's say, with the requirements of the system to be wireless connection between devices, hardware chosen for the system will all have wireless devices.

Assuming after market research were done, and there are two choices – Hardware A and Hardware B. Hardware A has a Bluetooth device, where as Hardware B has a Bluetooth device and a Wi-Fi device but with a higher price. These properties will be taken into consideration against the given constraints when choosing the suitable hardware. The less favorable hardware will be screened out.

### **3.1.3 Phase 3 – Requirements Modification**

As the components available have been analyzed, certain requirements will have to be modified to make the project successful. This is due to the fact that with the given budget, and time constraints, in favor of the completion of the project, modification of the scope (thus, the requirements) is inevitable.

For example, the hardware available does not have a wireless device, and it would be impossible to purchase a new hardware with the given time frame. It is also not financially feasible to do so. Thus, the original requirement to connect all the devices wirelessly would not be feasible. Such requirements will need to be modified or eliminated all together in favor of the completion of the project. If the modification or elimination of the requirements is not possible, the component analysis phase may be re-entered to search for alternative solutions.

### **3.1.4 Phase 4 – System Design With Reuse**

At this stage, the system is expected to be linked together. The framework of the system is designed or existing framework is reused. Since the latter does not exist, the former is taken into place. At the beginning of the phase, developer will need to design the system framework and architecture arrangement, as per requirements. This includes how all the components are to be linked together.

The software is to be installed in the hardware; the raw data files should be converted into shape files and images as necessary, and then transferred and stored in the hardware.

### **3.1.5 Phase 5 – Development and Integration**

The activities included in this particular phase would be the development of codes, customization of ArcPad 6.03 with toolbars and functions. The next step is integrating all the forms, toolbars, and functions developed into ArcPad 6.03 and making sure they work together. The language used for customizing ArcPad 6.03 would be VBScript, C++ for extension files and ArcXML for applet in ArcPad.

This phase will also include the connectivity between the hardware devices such as the PDA, the GPS, and so on. At the end of this phase should see the successful integration between components – hardware, software, and customized codes.

### **3.1.6 Phase 6 – System Validation**

The system will finally be tested and validated. It would be tested and validated against the modified requirements. Both Alpha testing and Beta

testing will be carried out. Alpha testing will be carried out by the developer with the intention to crash the system. Beta testing will be carried out by some novice users of the system. The purpose of both types of testing is to locate any bugs in the system, also to make sure that the requirements were met.

If requirements are not fully met, or bugs were found in the system, the Development and Integration phase will be repeated until the system is accepted and bug-free.

### **3.2 Benefits of using Reuse-Oriented Development Model**

This model has the obvious advantage that reduces the amount of software to be developed and so reduces the cost and risks. As Montoya (2003) puts it: “mobile GIS mainly focuses on the linking of various existing resources and data rather than in the development of new stand-alone devices.”

It usually leads to faster delivery of the software. Since the time frame given to complete the project is approximately 14 weeks, this model is most suitable to ensure that the end system will meet requirements, while developed within the given time constraint.

With this model, there is an increased reliability. This is due to the fact that the components have been exercised in working systems in various other researches. They have been tried and tested in a variety of different environments, and functionalities. The successful rate is thus much higher as well.

### **3.3 Tools Required**

In developing GIS, 5 major components must be present to make it complete – Hardware, Software, Data, Method, and People.



The hardware required for the project includes a laptop or a desktop, the PDA itself, the GPS receiver which outputs data in the NMEA protocol, the cables to connect these devices together, and in the later stage, the Wi-Fi device for wireless purposes.

The software involved is the Windows XP platform for the laptop or desktop, and Windows CE as the platform for the PDA. As for the development of GIS, ESRI ArcView 3.2, and ArcPad 6.03 software for Mobile GIS are used. Microsoft Visual Studio 6 is used as a development tool for the simulation of real-time interaction between the PDA and the GPS receiver.

The data required for the project are the digitized raster map of Ipoh city obtained from Dr Nasir from UTP Civil Engineering faculty, and the coordinates obtained from the GPS receiver as NMEA messages saved as the text pad or note pad format. The usage of the data was agreed to be solely for the development and implementation of the project for education purposes.

The method used to develop and implement the project, Mobile GIS, has been described in the earlier sections. Standards outlined from the industry such as Hardware, Software and Network standards will be referred to during the development of the system. The steps and phases from the methodology will have to be followed closely to ensure the successfulness of the project within the duration of 14 weeks.

The people component mentioned will be inclusive of the developer, the users, the supervisor of the project, and the external examiners of the project.

## **CHAPTER 4**

### **RESULTS AND DISCUSSION**

#### **4 RESULTS AND DISCUSSION**

Chapter 4 compiles the results and discussion of the project by phase as indicated in the methodology. This chapter sees the process of the project development, together with the problems faced during the whole experience. The phase-by-phase discussion will cover the activities, approach used, and findings. It gives a clear view of how intense and exciting the whole development process has been. The chapter ends with discussion on the problems faced along the journey, and lessons learnt in completion of the project.

##### **4.1 Results and Discussion – Requirements Specification**

Every project is constrained in different ways by its scope, time, and cost (Schwalbe, 2004). There will be a need to balance between the three ultimate constraints, also known as the triple constraints, of a project – time, cost, and scope.

The only variable in the project will be the scope as the time interval had been fixed to a period of 14 weeks, and the budget allocated for the development of the project was also fixed. During the requirements specification phase, the functionalities, thus the scope of project, were outlined, and examined against the other two important elements/constraints, to keep a balance.

The system requires setting up a wireless connection between the PDA and the GPS to track the vehicle movement in real-time. There are many options to achieve this, hence the need for component analysis.

## 4.2 Results and Discussion – Component Analysis

Such a system architecture indicated in Figure 2.1 (p.8) in the earlier section is not required for this particular project. The project is a smaller mocked-up version of the large scale Mobile GIS system in order to be completed in the duration of 14 weeks. Thus, the system architecture is much simpler. It would only include the client, and the location from the larger system, as shown in Figure 4.1.

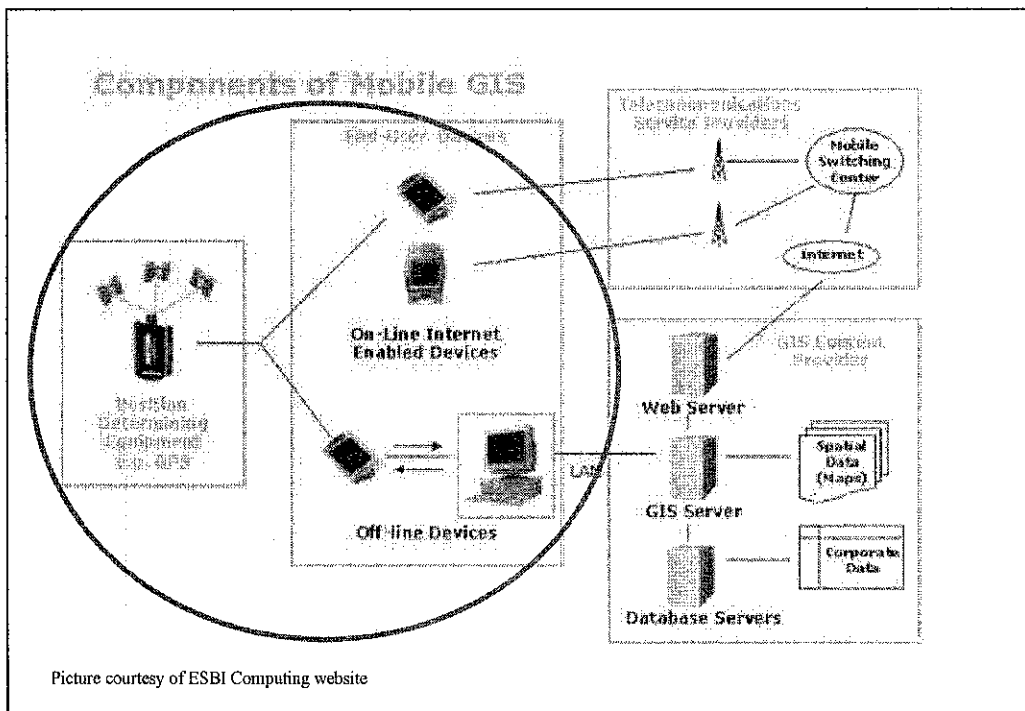

Figure 4.1: Components of Mobile GIS for This Project (in circle)

There will only be the positioning determining equipment (PDE) such as a GPS, the PDA, and the connection between the two mentioned devices, be it via cable or via wireless connection, as the hardware component for the project. The software which will be used has already been determined in the previous phase – ESRI's ArcPad 6.03. The rest of the supporting software will be determined during this phase and discussed in the later sections. The exact brand and model of the equipment will be determined during this component analysis phase. The detailed process of choosing the suitable tools will be elaborated in the following sections.

#### 4.2.1 Hardware Component Analysis

##### *Mobile Device*

Mobile gadgets are inclusive of laptop computers, mobile phones, and personal digital assistant (PDA), watches, and so on. The device chosen for this particular project was the PDA, as laptop computers are not as convenient and not as portable as the PDA, and mobile phones do not provide a “large-enough” high-resolution screen as the PDA, not to mention watches.

For PDA itself, there are two major branches – the Palm Top, and the Pocket PC. Both are PDAs, but both running on different platforms. Palm Tops generally run Palm OS, while the Pocket PC runs on the famous Microsoft Windows CE/Pocket PC 2003. Palm OS takes up less memory and runs faster. Pocket PC on the other hand, easily supports color displays, graphics, miniaturized Windows packages such as Word and Excel, and other devices such as built-in MP3 player or MPEG movie players.

Palm OS use to dominate the market, but Pocket PC is now picking up popularity. Thus, analysis will have to be done on both types of PDA, using the features, and price factors as the variables for comparison.

There are many brands and models of PDA in the market which fits the system requirements. The manufacturers include Sony, DELL, Hewlett-Packard, Tungsten, O2, and the list goes on. There are many models from each of these manufacturers.

The system requirements for ESRI ArcPad 6.03 are listed in Table 4.1. As the first step, those PDA that has features that meets the system requirements will be listed in Table 4.2. Then the price for each of those PDA will also be listed in Table 4.2 as the second step. The best PDA as shown in Figure 4.2 is chosen from the list.

Table 4.1: ESRI ArcPad 6.03 system requirements

CATEGORY	REQUIREMENTS
Operating System	<ul style="list-style-type: none"> <li>○ Pocket PC, Pocket PC 2002, and Pocket PC 2003</li> <li>○ Windows CE 2.11, 2.12, and 3.0</li> <li>○ Windows CE .NET (CE 4.x)</li> <li>○ Windows 95/98/2000, Windows NT, and Windows XP</li> </ul>
CPU Chips for Windows CE	<ul style="list-style-type: none"> <li>○ Hitachi SH3 and SH4</li> <li>○ XScale</li> <li>○ StrongARM</li> <li>○ MIPS</li> <li>○ x86</li> </ul>
GPS Protocol Supported	<ul style="list-style-type: none"> <li>○ NMEA (National Maritime Electronics Association)</li> <li>○ TSIP (Trimble)</li> <li>○ DeLorme Earthmate</li> <li>○ Rockwell PLGR GPS binary protocol</li> </ul>

Table 4.2: List of PDA (chosen PDA is grayed)

Model	OS	CPU Chips	Bluetooth	Wi-Fi	Price
HP iPAQ H4350	Pocket PC 2003	XScale	YES	YES	RM 1888
HP iPAQ H4150	Pocket PC 2003	XScale	YES	YES	RM 1688
HP iPAQ H5550	Pocket PC 2003	XScale	YES	YES	RM 2288
HP iPAQ H2210	Pocket PC 2003	XScale	YES	NO	RM 1588
O2 XDAII	Windows Mobile 2003	XScale	YES	NO	RM 3500 (Estimated)
Fujitsu – PocketLOOX 600	Pocket PC 2002	XScale	YES	YES	RM 1588
Toshiba E750	Pocket PC 2003	XScale	NO	YES	RM 2088
Toshiba E350	Pocket PC 2003	XScale	NO	NO	RM 998
Toshiba E330	Pocket PC 2002	XScale	NO	NO	RM 799
Toshiba E740	Pocket PC 2002	XScale	NO	YES	RM 1288
Casio PEIA E-200	Pocket PC 2002	StrongARM	NO	NO	RM 1599

Prices courtesy of [handheld.com.my](http://handheld.com.my) as of February 2004

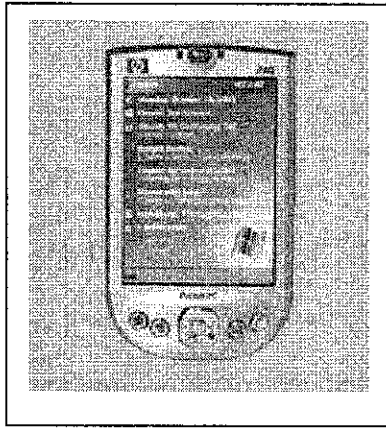

Figure 4.2: HP iPAQ H4150

### *GPS Receiver*

Generally, GPS receivers are expensive gadgets. The GPS receivers available from the Civil Engineering Faculty of the university are Leica's GS50, and TopCon HiPer, shown in Figure 4.3 and Figure 4.4 respectively.

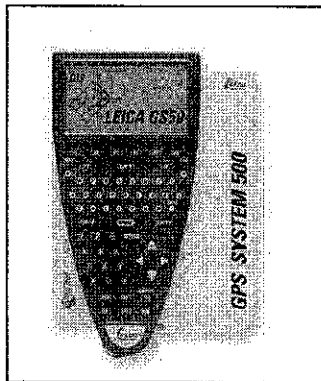

Figure 4.3: Leica GS50

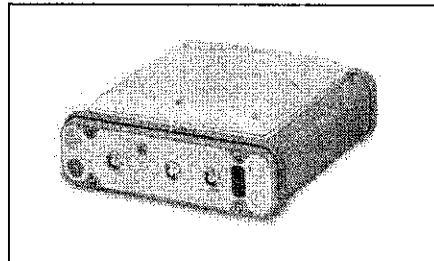

Figure 4.4: TopCon HiPer

The system requirements for ESRI ArcPad 6.03 as seen from Table 4.1, is to use one of the four protocols to output data. Both the GPS receiver uses the NMEA protocol to output data messages. Both GPS receiver does not have Bluetooth device, or Wi-Fi wireless device incorporated in them. Thus, the connection of GPS receiver to the PDA will need to be done using a DB9 serial cable – a cable with 9-Pin serial port. Hence, since the TopCon HiPer GPS connects to a normal desktop using a serial cable, this GPS is a better fit to the project than of Leica GS50.

## 4.2.2 Connection Component Analysis

As the GPS receivers available does not consist any wireless devices, such as the Bluetooth or the WLAN 802.11b (Wi-Fi) device (Appendix 6), the only option to connect the GPS to the PDA is via the DB9 serial cable – a 9-Pin serial port cable.

### *Cable Connection*

Since the TopCon HiPer is a device that normally plugs into a desktop, there are two options in connecting the devices together.

First, is to connect them together using the architecture shown in Figure 4.5. There will be a need for a null modem adapter. This is due to the fact that the signal transmitted from the GPS are reversed (or crossed). The null modem adapter is used to connect a straight through cable (such as the one from the PDA) to a null modem cable (such as the one from the GPS). The null modem adapters are usually available in two configurations – male-to-female, and female-to-female. The gender changer is required if the gender of the ports are the same.

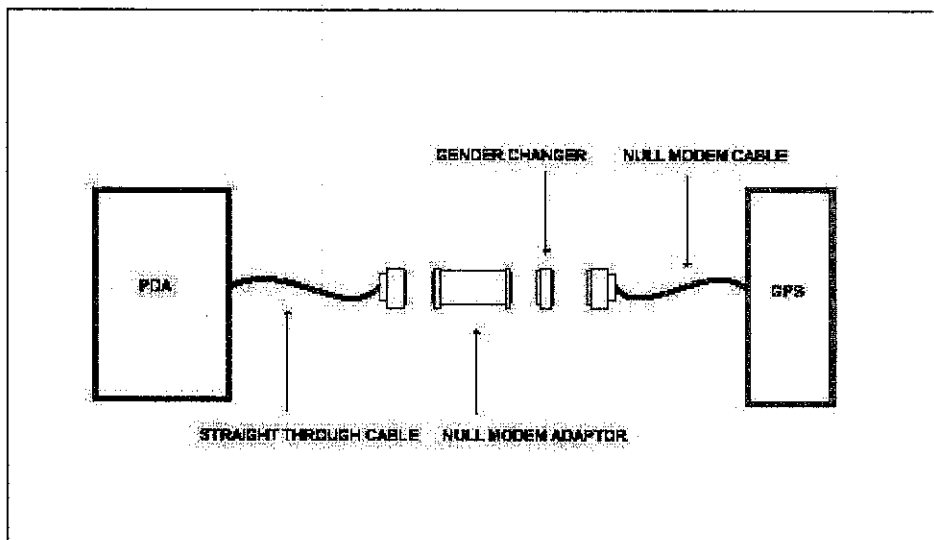
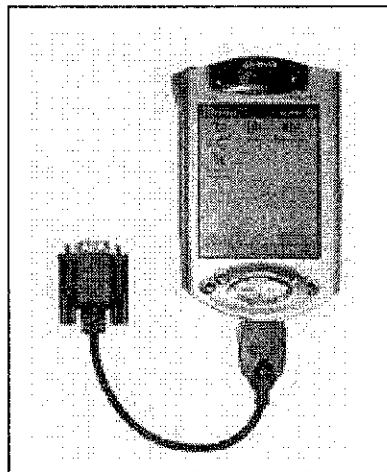

Figure 4.5: Connection architecture from GPS to PDA

The second option is to get a cable designed to feed a GPS or modem from the PDA such as the one shown in Figure 4.6. This cable connects to the bottom of several models of the iPAQ Pocket PC. The other end of the cable is meant to connect to a GPS or a cellular data cable. Such a cable is not available in the local market as of writing. It will have to be shipped from the United States or Hong Kong for an approximate price of RM 150 inclusive of shipping cost.



Picture courtesy of [thesupplynet.com](http://thesupplynet.com)

Figure 4.6: Custom made cable

### 4.2.3 Software Component Analysis

#### *Mobile GIS Software – ESRI ArcPad 6.03*

ESRI is the leading GIS software developer in the market. Its ArcPad software is a mobile mapping and GIS technology that comprises the integration of four technologies: GIS, lightweight hardware, GPS, and wireless communications. ArcPad 6.03 provides database access, mapping, GIS and GPS integration to users out in the field using handheld and mobile devices such as the PDA.



With ArcPad 6.03, the existing data can be used. It supports vector map and raster image display. It can also add data from the Internet via wireless communications. It gives the users the convenience to move around the map which includes zooming. ArcPad 6.03 enables the users to query the data such as display additional information about features through a hyperlink. Users can also measure distances, area, and bearings on the map, navigate with the GPS, also to create and edit the data in the database.

ArcPad 6.03 provides the several map navigation tools such as zoom, and pan, special bookmarks, and center on the current GPS position. Navigating with GPS is possible if ArcPad is configured to “talk” to the GPS receiver using a common protocol. This can be used for vehicle monitoring, as well as navigation. As the main requirement of the project to monitor vehicle movements, ArcPad 6.03 is most suitable as the GIS software component for the project. Figure 4.7 shows the GPS Tracklog feature.

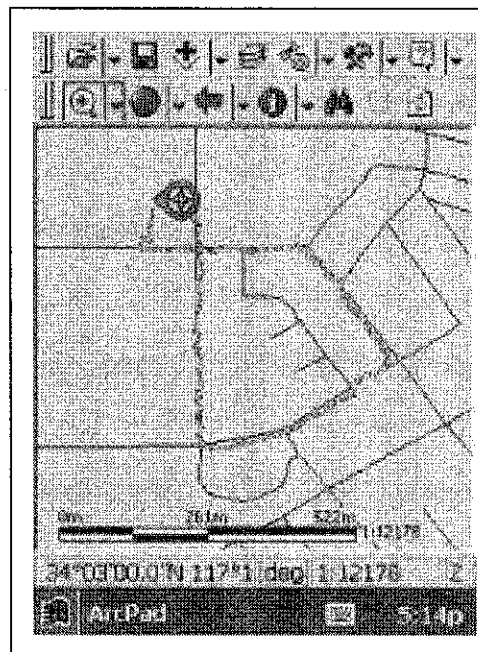

Figure 4.7: GPS Tracklog

One of the most important elements for connecting the GPS with ArcPad is to make sure that the GPS is outputting data compatible to the ones supported by ArcPad 6.03.

ESRI ArcPad 6.03 supports 4 GPS protocols. The first is NMEA 0183 Standard (National Marine Electronics Association), which defines electrical signal requirements, data transmission protocol, timing and specific sentence formats. The other protocols supported by ArcPad are the Trimble Standard Interface Protocol (TSIP), DeLorme Earthmate, and Rokwell PLGR GPS Binary Protocol (ESRI Support, 2004).

ArcPad is GPS-enabled for use with Trimble® GPS within the territory of the United States. Beginning one degree in latitude and longitude outside any United States' territorial border, ArcPad is GPS-enabled for all GPS receivers using NMEA format. Outside US territory, any GPS receiver which outputs data according to the NMEA 0183 standard should work with ArcPad. Refer to Appendix 3 for the NMEA messages supported by ArcPad.

### ***Mobile GIS Software Customization Language***

Although ArcPad is designed to be flexible and easy to use, users may want the interface to reflect their own preferences and the way they work. The customization features offered by ArcPad 6.03 makes it flexible for developers to create their own forms or applet for functions not offered by ArcPad. Customization of the ArcPad software can be done using ArcPad Application Builder's ArcPad Studio. The customization may include toolbars or applets with functions such as finding shape files, or detecting the GPS unit. The languages used to program such customization are VBScripts, ArcXML, and C/C++. In the future, JScripts could also be used for customization purposes.

### **4.3 Results and Discussion – Requirements Modification**

The initial system requirements are to set up a wireless connection between the PDA and the GPS to monitor the vehicle movements in real-time. After the hardware component analysis phase, such a requirement would need to be modified.

The first reason being, the budget allocated for the project does not allow the purchase of a new GPS receiver with wireless devices intact. The requirement to set up a wireless connection will have to be revised to make the project reasonable.

The first revision of the system requirements were to set up a serial connection between the PDA and the GPS to monitor the vehicle movements in real-time. The component analysis phase was then repeated to identify the suitable cable. The second round of component analysis have identified the cables and components needed for the serial connection between the PDA and the GPS as discussed in section 4.2.2

The first option from section 4.2.2 posses some form of infeasibility as the port changer from a USB port to a 9-pin RS232 serial port has yet available for PDA to GPS connection. Cables available in the local market are meant for PC to PDA connection, which makes use of a connection driver on the PC side.

The second option, on the other hand, posses the infeasibility in the form of time and budget. Shipping the cable from US to Malaysia will take at least 14 days if not more, and costs an approximate sum of RM 150 for a 8-inch long custom made cable. Time and budget constraint does not allow for such an arrangement to take place.

Thus, the second revision of the system requirements were to simulate a real-time vehicle navigation monitoring system, where real coordinates captured from the GPS saved in the form of text pad or note pad format, will be plot on the ArcPad map using customization flexibility of ArcPad 6.03.

#### 4.4 Results and Discussion – System Design with Reuse

At this stage, the system will be designed. The framework of the system is designed as per requirements. This includes how all the components are to be linked together. There are two (2) alternatives in simulating the vehicle navigation monitoring system.

For the first alternative, ArcPad 6.03 will be customized with the GPS Tracklog simulation toolbar using ArcXML Applet. The NMEA messages output from the GPS will be saved in a text file. The applet will call upon the VBScript function responsible to read from the text file. After obtaining the required data, another VBScript function will plot the coordinates on the map opened in ArcPad. The conceptual data flow model for the first simulation alternative is shown in Figure 4.8.

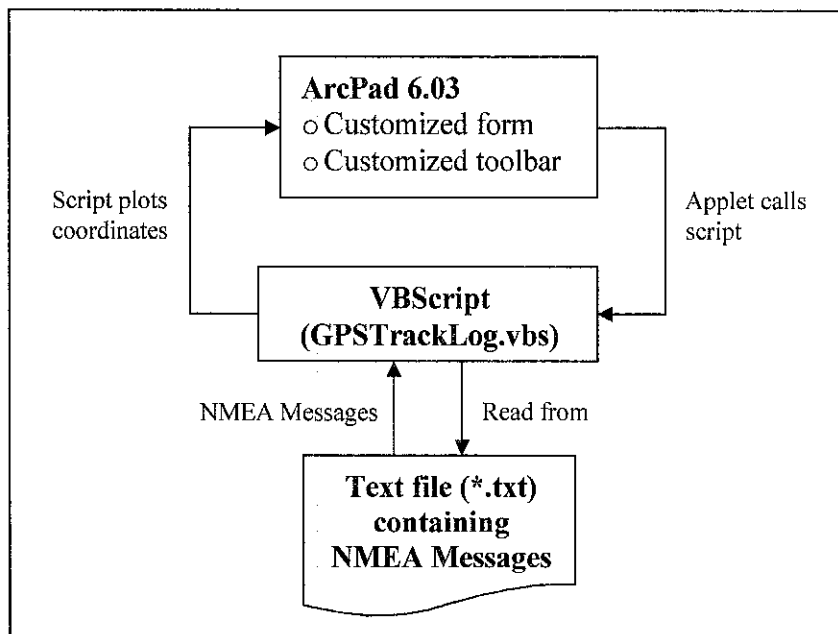

Figure 4.8: Conceptual data flow model

The ArcPad 6.03 software will be installed in the PDA itself, along with the applet and VBScript. The data – text file, shapefiles, and maps will also be stored in the PDA itself.

For the second simulation alternative, the text file will be stored in a PC. The PC will be made believe as the GPS by ArcPad 6.03 as NMEA signals are output from the PC. ArcPad 6.03 will be set to detect the signals from the PC as if it were from the GPS. There will be a need to set up a PDA to PC connection complying with the Network standards via wireless connection – WLAN 802.11b (Wi-Fi) using the TCP/IP protocol. The architecture of such framework is shown in Figure 4.9.

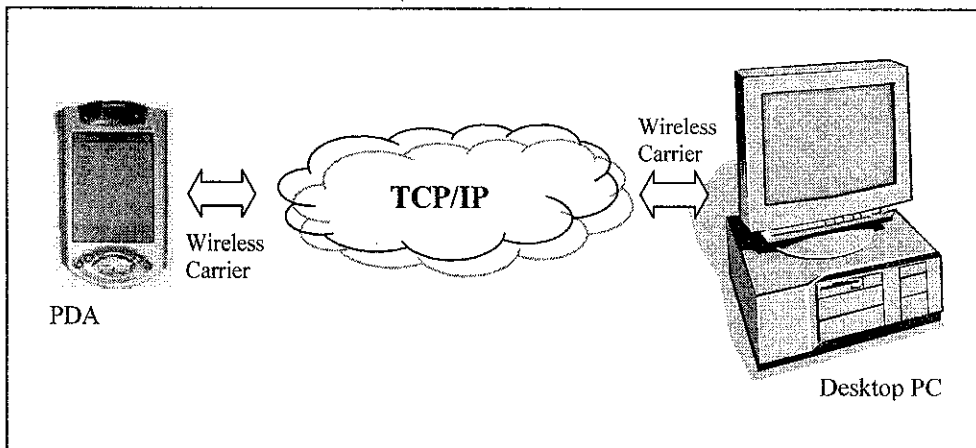

Figure 4.9: Architecture design of the system

#### 4.5 Results and Discussion – Development and Integration

The development and integration phase sees the customization of ArcPad 6.03 with toolbar and buttons needed for the simulation of the GPS Tracklog feature as the requirement of the project for alternative 1, and setting up a Wi-Fi connection between the PDA and the PC in alternative 2.

##### 4.5.1 Simulation Alternative 1

The simulation of the GPS Tracklog feature would be done using ArcXML Applet as the interface for user interaction. The applet would then call on a VBScript function to read the NMEA messages saved in a text pad or note pad format. Another VBScript function would then simulate the plotting of the coordinates on the ArcPad map as if the vehicle is moving in real-time.

This data flow has been shown in Figure 4.8 in the previous section. The toolbar is shown in Figure 4.10. The ArcXML Applet code was saved as “GPSTrackLog.apa” and located in the ArcPad’s “Applet” folder. Please refer to Appendix 7 for the source code.

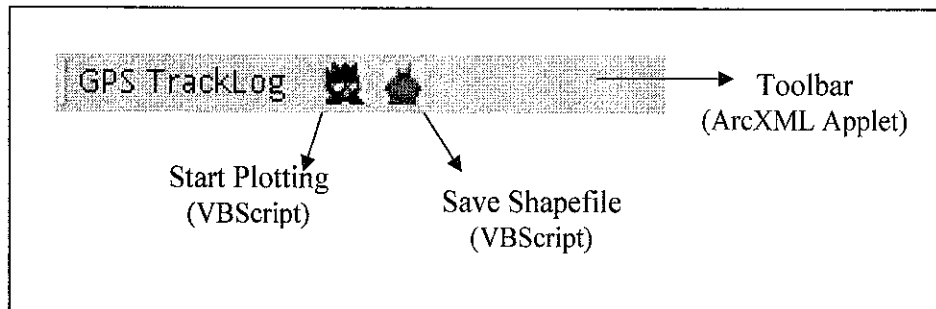

Figure 4.10: Customized Toolbar using ArcXML Applet

ArcPad’s “Applet” folder in Program Files will be checked for applet (\*.apa) files while starting up ArcPad 6.03 on the PDA. The above toolbar will then be loaded into ArcPad. The interface is shown in Figure 4.11. The function for each buttons in ArcPad 6.03 can be found in Appendix 2.

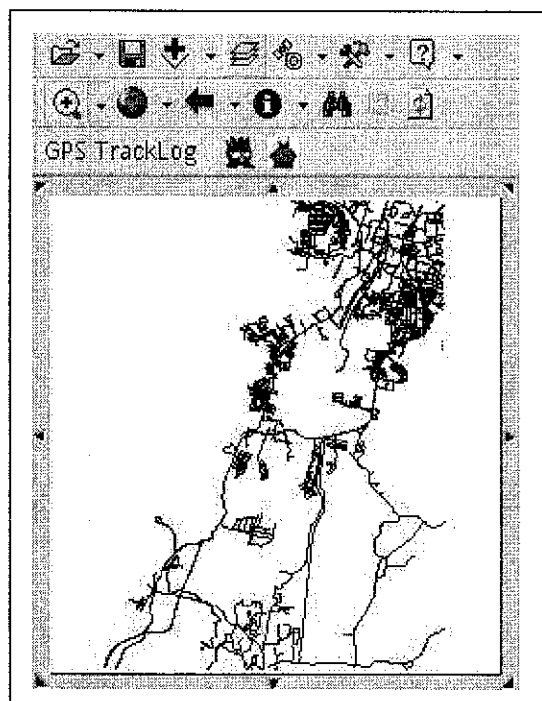

Figure 4.11: ArcPad 6.03 customized interface with Ipoh route map

The “Start Plotting” button will call upon a VBScript function to read the NMEA messages from the text file, extract out the Latitude/Longitude information, and finally plotting the point onto the digital map opened in ArcPad 6.03. Figure 4.12 shows the points plotted onto the map. If there is no layer on the map, it will return an error message. The “Save Shapefile” button will call upon a VBScript function to save the points as another layer, called a Shape File. Please refer to Appendix 8 for the VBScript source code.

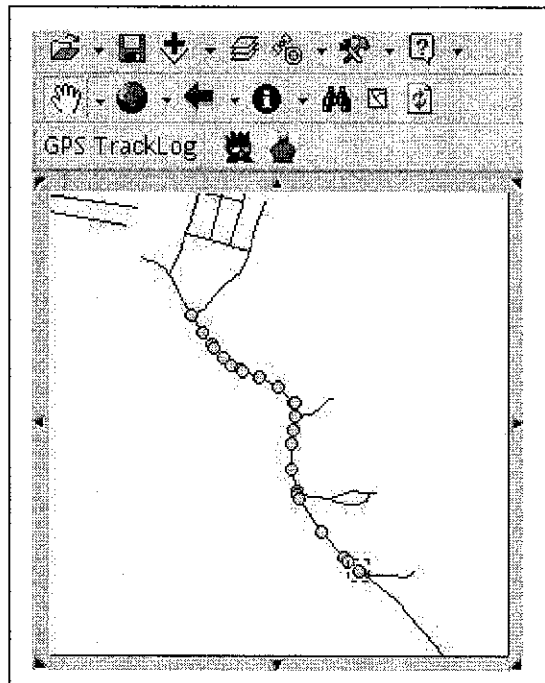

Figure 4.12: Points plotted onto the map

#### 4.5.2 Simulation Alternative 2

One of the ArcPad experts, Joe Zastrow, has suggested in the ESRI User Forum that the simulation could be done using an old hardware/software trick. The file containing NMEA messages will be placed on a desktop/laptop computer. Then hook the mobile device (the PDA) to the computer with a wireless device by turning on the Wi-Fi device on the PDA (make sure the desktop also has a Wi-Fi device).

For ArcPad to detect the messages, the ports used by both ArcPad and the desktop to receive or output the data have to be the same. So the port will be set to COM1 in this case. In ArcPad, set the protocol to NMEA. Get ArcPad going, and waiting for NMEA messages. The steps are the same as connecting ArcPad to the GPS. Please refer to Appendix 5 for detailed steps. On the desktop, assuming COM1 port is used, use the TYPE command in the DOS command to output the messages in the file from COM1, and into the COM1 port in ArcPad. The command is “TYPE GPSData3.txt >COM1”. This is shown in Figure 4.13.

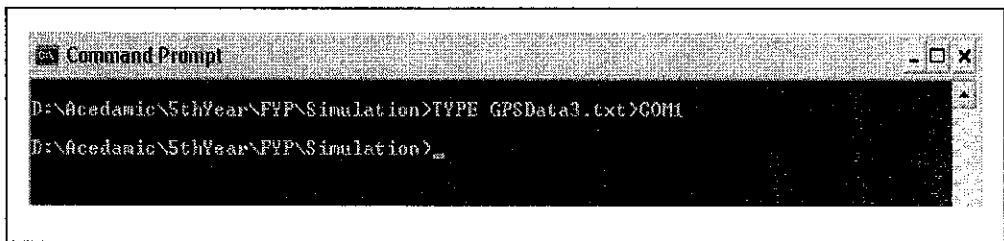

Figure 4.13: TYPE command in DOS

The trick is actually trying to fool ArcPad into thinking that the NMEA messages are actually coming from a GPS, instead of a file. This method was tested using the PDA and the desktop, and ArcPad returned an “Error 55” message. “Error 55” appears when the COM port is used by another program or a program uses the port and would not release it even though the process was long done. This error can be resolved using a soft reset on the PDA or a self-test on the PDA to release the port. This method could be implemented using two desktops without any problems.

#### 4.6 Results and Discussion – System Validation

The final stage of the system development is the System Validation phase. This phase sees the testing of the simulation to make sure that the requirements set during the Requirements Modification phase was fully met.



The first stage of the phase is testing done by the developer. This is often referred to as Alpha testing. As mentioned in the Methodology section, the main purpose of this testing is to crash the system, using every possible actions as test items. There was not many buttons and functions offered in the simulation, hence, the confusion that will be brought to the end user could be minimized. During the process of this phase, the Development and Integration phase had to be repeated several times.

The second stage of the phase is to let some novice users test run the simulation. Some of the participants for testing were the engineering students who have not used or even heard of ArcPad before. They are the perfect testing group, as there are no bias as of how to use the simulation. Assumptions were made that if the testing runs smooth with this particular user group, user groups with knowledge of ArcPad will not have problem using the simulation.

After test running the simulation with some novice users, the simulation is then brought to the ArcPad savvy users for the final stage of the system validation. The Development and Integration phase was repeated to fine tune some loose ends found during the testing process.

#### **4.7 Discussion – Problems Faced**

Tracking a vehicle's movement in real-time requires the GPS and the PDA as the main hardware component. The complexity of the physical integration between the GPS and PDA was overlooked at the initial stage of the project, resulting in several iterations of phases, while halting the overall progress of the project. Research before was mostly done on connecting the GPS to ArcPad 6.03, focusing on the configuration settings in the GPS and ArcPad 6.03 as the virtual connection. Refer to Appendix 4 for more details on the matter. The physical connection however, was taken for granted.

Problems arisen when it was found that the port used by the GPS is a RS232 9-Pin female serial port, where as the PDA use a USB port to connect to the PC. The solution of the problem was discussed in section 4.2.2. It was then taken for granted

again that such a cable could be found in one of the largest computer center in Malaysia. It was later on discovered that the custom cable is not available in the country, and has to be shipped from overseas. There were difficulties in obtaining the connection cable for the GPS and the PDA. The project system requirements were then modified to overcome the cable problem. Time has definitely played a major role in defining the project. By this stage, time was running short and the project due date is fast approaching.

Difficulties in obtaining budget for the project had also affected the project progress in its own way. The customization of ArcPad 6.03 needs the ArcPad Studio, which comes in a complete ArcPad Application Builder 6.0. The lack of funding in such purchasing area makes it the more difficult to simulate the GPS Tracklog feature in ArcPad 6.03. It was definitely a huge challenge in writing the codes for such feature using an entirely new language such as ArcXML Applet, and VBScript, moreover in notepad as the developing tool.

Important lessons were learnt in the hard way – to never take anything for granted, and to never overlook even the slightest matters. Prior research and full understanding of a matter were shown to be very elements before undertaking a project. It was also full-heartedly felt that time, and budget plays a defining role in any given projects.

## **CHAPTER 5**

### **CONCLUSION AND RECOMMENDATION**

#### **5 CONCLUSION AND RECOMMENDATION**

Chapter 5 concludes the project by giving several thoughts that have been formed while developing the system simulation. It is then followed by some recommendations for future expansion of the project. A real working model of Mobile GIS would be very impressive, and it would mark the entrance of Malaysia into the world of GIS system “on the run”. The full capability of such a powerful system should be fully studied. It brings convenience to mankind in the long run, and should not be taken lightly.

##### **5.1 Conclusion**

This project has fulfilled its objective of studying and understanding the underlying concept of GIS and the GPS receiver in Chapter 2: Literature Review. The Chapter sees the discussion on GIS, GIS in mobile environment, together with GPS and how the GPS works. It also sees the components that are required in a GIS and mobile GIS. The relationships between the different components were able to be identified.

To integrate theories with practical, the state of the art technology was utilized in the project. A high-end Hewlett-Packard Pocket PC was used to do the simulation of the GPS Tracklog feature, while exploiting GPS functionality of providing a location.

The project put the research knowledge obtained about GIS and also GIS in mobile environment into use where it evolves around how movements can be monitored, and tracked using the GPS together with a rugged handheld device such as a PDA.

With a short timeframe, the Reuse-Oriented Development Model has been identified to tackle such a development environment. The methodology saves time, and leads to faster delivery of the system, along with the increased reliability of the system.

The simulation project is able to demonstrate the true power of GPS coupled up with a mobile device such as a PDA, which unleashes the wild imagination one could have with GIS. This paper has shown that hardware and software trends are making Mobile GIS a reality in the country. It will be picking up popularity as the technology trend sets in.

## **5.2 Recommendation**

Several aspects have been identified as possible future expansions of the project. The first option suggested for expansion involves the actual physical connection between the GPS and the PDA, along with full customization of ArcPad 6.03 to uncover the potential of such software. Maps are a vital medium for communicating geographical or spatial information in the form of spatial patterns, directions, and locations. Thus, preparing real data with ArcView 3.x or ArcGIS 8.x could be done in more depth. Another main feature of collecting data, and updating attribute with GPS should be explored. Creating points, lines and polygons in the field at real-time should also be tackled, making use of the feature plotting function of ArcPad 6.03.

The second option suggested for expansion would be to deploy a full and complete system of Mobile GIS. This would mean to integrate GIS database and server, along with telecommunication service provider into the current component architecture of the system. It would be interesting to see the real-implementation of GPS, and Remote Sensing (RS) into the current project structure. This is probably an unrealistic scope for a 14-week project. Thus, it is suggested that the complete system to be undertaken as a two-semester project, with approval of a generous budget, if possible.

A full understanding and research should be known and acquired before the official commencement of the project, to avoid lack of resources and materials, causing the

shortening of development time. A combination of perseverance, endurance, persistence, and carefulness is extremely crucial in designing, building, and completing the project. The smallest matter should not be overlooked, or taken for granted. Proper online resources, documentations, and books are to be obtained before hand. The learning experience in such methods is beneficial, valuable, and cannot be bought with money.

## REFERENCES

- An ESRI White Paper, September 2000, "ArPad: Mobile Mapping and GIS"
- An ESRI White Paper, April 2002, "What's New in ArcPad 6"
- An ESRI White Paper, September 2002, "Geography Matters" GIS.com [On-line] viewed 4 January 2004, available <[www.gis.com](http://www.gis.com)>
- Brad Spencer, "Mobile GIS", geoplance.com [On-line] viewed 15 October 2003, available <[www.geoplance.com](http://www.geoplance.com)>
- Chris Wayne, October – December 2003, "Creating Custom Tool Buttons for ArcPad", *ArcUser Online*, available <[www.esri.com](http://www.esri.com)>
- Dale DePriest, DaleDePriest Home Page [On-line] viewed 31 March 2004, available <<http://users.cwnet.com/daled/>>
- Dave Goughnour, "Mobile GIS" [On-line] viewed 28 January 2004, available <<http://www.trimble.com/news/121003a.htm>>
- David R. Green (Editor). 2000, *GIS: A Sourcebook for Schools*, USA and Canada, Taylor & Francis Inc
- Davis, Bruce E. 2001, *GIS: A Visual Approach*, 2<sup>nd</sup> Edition, Canada, OnWord Press
- ESBI Computing [On-line] viewed 4 January 2004, available <[www.esbic.ie](http://www.esbic.ie)>
- ESRI, January – March 2004, "Inventorying Infrastructure with ArcPad", *ArcUser Online*, available <[www.esri.com](http://www.esri.com)>
- ESRI [On-line] viewed 22 October 2003, available <[www.esri.com](http://www.esri.com)>
- ESRI Support [On-line] viewed 7 February 2004, available <[support.esri.com](http://support.esri.com)>
- G. Derekenaris, J. Garofalakis, C. Makris, J. Prentzas, S. Sioutas, and A. Tsakalidis, July 2000, "Integrating GIS, GPS, and GSM technologies for the effective management of ambulances", Greece, Pergamon Press
- GeoLog Newsmagazine of the Geological Association of Canada, Volume 32, Number 1, Spring 2003
- GIS [On-line] viewed 6 December 2003, available <[www.gis.com](http://www.gis.com)>

- GIS Lounge, "Basic Guide to ArcXML" [On-line] viewed 24 March 2004, available <[gislounge.com/features/aa012402a.shtml](http://gislounge.com/features/aa012402a.shtml)>
- Handheld Shop [On-line] viewed 9 April 2004, available <[www.handheld.com.my](http://www.handheld.com.my)>
- How Stuff Works [On-line] viewed 24 February 2004, available <[www.howstuffworks.com](http://www.howstuffworks.com)>
- J. Olwyn Bruce, and Wes Hodson, 2003, "Final Report: ArcIMS & Customized PDA Interfaces in Field Data Collection", DFM Spatial Press
- Joe Bell, LS. July 2002, "ESRI ArcPad 6.0", *Professional Surveyor Magazine*, available <[www.profsurv.com](http://www.profsurv.com)>
- Leica [On-line] viewed 7 February 2004, available <[www.leica.com](http://www.leica.com)>
- Leica GeoSystem Newsletter on System 500 GPS, Vol. 01, No. 24, "GPS Newsletter – GS5/GS5+ and ArcPad"
- Lorena Montoya, March 2003, "Geo-data through mobile GIS and digital video: an urban disaster management perspective", The Netherlands, Elsevier Press
- Malaysia GIS [On-line] viewed 22 October 2003, available <[www.malaysiagis.com](http://www.malaysiagis.com)>
- Morris Juppenlatz, Tian XiaoFeng. 1996, *Geographic Information Systems and Remote Sensing*, Sydney, Mcgraw-Hill
- N. Niemi, 2003, "Creating an ArcPad map file (.apm) for use on the iPAQ" [On-line] viewed 24 March 2004, available <[web.mit.edu/dtfg/www/education/FieldCampWeb/LastWeb/help/ArcPad/apm.htm](http://web.mit.edu/dtfg/www/education/FieldCampWeb/LastWeb/help/ArcPad/apm.htm)>
- Paul A. Longley, Michael F. Goodchild, David J. Maguire, David W. Rhind. 2001, *Geographic Information Systems and Science*, West Sussex, John Wiley & Sons, LTD
- Petter Bennett, "NMEA FAQs Version 6.4", *NMEA-0183 and GPS Information* [On-line] viewed 15 April 2004, available <[vancouver-webpages.com/peter/](http://vancouver-webpages.com/peter/)>
- PPczone.net Forum [On-line] viewed 31 March 2004, available <<http://www.ppcw.net/forum/viewtopic.php?pid=4644>>
- Schwalbe, Kathy. 2004, "Chapter 1: Introduction to Project Management", *Information Technology Project Management*, 3<sup>rd</sup> Edition, Canada, Thomson Course Technology
- Scott Hutchinson, Larry Daniel, 2000, *Inside ArcView GIS*, 3<sup>rd</sup> Edition, New York, OnWord Press

Sommerville, Ian. 2001, "Chapter 3: Software Processes", *Software Engineering*, 6<sup>th</sup> Edition, England, Addison-Wesley

Supplynet [On-line] viewed 3 April 2004, available <[www.thesupplynet.com](http://www.thesupplynet.com)>

TopCon [On-line] viewed 7 February 2004, available <[www.topconpositioning.com/home.html](http://www.topconpositioning.com/home.html)>

Ty Fitzpatrick, July – September 2002, "Use ArcPad Forms to Streamline Data Collection", *ArcUser Online*, available <[www.esri.com](http://www.esri.com)>

















USGS Eastern Region Geography, "Geographical Information System" [On-line] viewed 4 January 2004, <[erg.usgs.gov/isb/pubs/gis\\_poster/index.html](http://erg.usgs.gov/isb/pubs/gis_poster/index.html)>

















## **APPENDICES**







- Appendix 1 Final Year Project Gantt-chart
- Appendix 2 Selected pages of ESRI ArcPad Quick Reference Guide
- Appendix 3 NMEA Messages supported by ArcPad 5
- Appendix 4 NMEA Deciphered
- Appendix 5 Steps to connect GPS to ArcPad
- Appendix 6 Bluetooth vs. Wi-Fi
- Appendix 7 ArcXML Applet Source Code (GPSTracklog4.apa)
- Appendix 8 VBScript Source Code
- Appendix 9 Sample GPS Data

## Appendix 2: Selected pages of ESRI ArcPad Quick Reference Guide



MAIN TOOLBAR	
	<b>Open Map</b> Open an ArcPad map (a file with an .apm extension).
	<b>Save Map</b> Save the current ArcPad map.
	<b>Add Layer</b> Add one or more layers to the current map.
	<b>Layers</b> Open the Layers dialog box.
	<b>GPS Position Window</b> Open or close the GPS Position Window.
	<b>Tools</b> Open the ArcPad Options dialog box.
	<b>Help</b> Open the online help.
OPEN MAP DROPDOWN LIST	
	<b>New Map</b> Close the current map and create a new map.
	<b>New Layer</b> Create a new shapefile and load it into the current map.
	<b>Open Map</b> Open an ArcPad map (a file with an .apm extension).
	<b>Save Map</b> Save the current ArcPad map.
	<b>Save Map As</b> Save the current ArcPad map with a new name and/or in a different folder.
	<b>Map Properties</b> Enter the title of the current map.
	<b>Recent Maps</b> Display the nine most recently opened maps.
	<b>Recent Layers</b> Display the nine most recently added layers.
	<b>Exit</b> Close ArcPad.

ADD LAYER DROPDOWN LIST	
	<b>Add Layer</b> Add one or more layers to the current map.
	<b>Add Internet Server</b> Add an ArcIMS® image service as a layer to the current map.
	<b>Geography Network</b> Go to the <a href="http://www.geographynetwork.com">www.geographynetwork.com</a> Web site, using the default Internet browser.
GPS POSITION WINDOW DROPDOWN LIST	
	<b>GPS Position Window</b> Open or close the GPS Position Window.
	<b>GPS Active</b> Activate or deactivate the GPS.
	<b>GPS Tracklog</b> Start or stop storing GPS points in the tracklog shapefile.
	<b>GPS Debug</b> Open or close the GPS Debug Window.
TOOLS DROPDOWN LIST	
	<b>Options</b> Open the ArcPad Options dialog box.
	<b>Scale Bar</b> Display or hide the scale bar.
	<b>Panning Frame</b> Display or hide the map panning frame.
	<b>Status Bar</b> Display or hide the status bar.
	<b>Toolbars</b> Display a submenu containing all the toolbars in ArcPad.
HELP DROPDOWN LIST	
	<b>Help Topics</b> Open the online help.
	<b>About ArcPad</b> Open the About ArcPad dialog box.
	<b>About Extension</b> Display a submenu listing all loaded ArcPad extensions.







### BROWSE TOOLBAR

	<b>Zoom In</b>	Zoom in on the map using the pen.
	<b>Zoom to Full Extent</b>	Zoom to the full extent of the map.
	<b>Go Back to Previous Extent</b>	Zoom back to the previous extent you were using.
	<b>Identify</b>	Activate the Identify tool.
	<b>Find</b>	Open the Find tool.
	<b>Clear Selected</b>	Unselect the selected feature.
	<b>Refresh</b>	Redraw the map.







### ZOOM IN DROPDOWN LIST

	<b>Zoom In</b>	Zoom in on map using the pen.
	<b>Zoom Out</b>	Zoom out on map using the pen.
	<b>Pan</b>	Pen the map using the pen.







### ZOOM FULL EXTENT DROPDOWN LIST

	<b>Fixed Zoom In</b>	Zoom in on the center of the map by 25%.
	<b>Fixed Zoom Out</b>	Zoom out on the center of the map by 25%.
	<b>Zoom to selected</b>	Zoom to the extent of the selected feature.
	<b>Center on GPS</b>	Center the map on the current GPS position.
	<b>Zoom to Full Extent</b>	Zoom to the full extent of the map.
	<b>Zoom to Layer</b>	Zoom to the extent of a particular layer in the map.







### GO BACK TO PREVIOUS EXTENT DROPDOWN LIST

	<b>Go Back to Previous Extent</b>	Zoom back to the previous extent you were using.
	<b>Go to Next Extent</b>	Zoom forward to the next extent in the extent history.
	<b>Set View Coordinates</b>	Set the map extent or center the map at specified coordinates.
	<b>Set Map Scale</b>	Set the map scale.
	<b>Create Bookmark</b>	Create a spatial bookmark.
	<b>Manage Bookmarks</b>	Edit or delete existing spatial bookmarks.
	<b>Zoom to Bookmark</b>	Zoom to an existing spatial bookmark.

### IDENTIFY DROPDOWN LIST

	<b>Identify</b>	Activate the Identify tool.
	<b>Measure</b>	Measure distances in the map view in "point mode".
	<b>Radial Measure</b>	Measure radial distances in the map view using the pen.
	<b>Freehand Measure</b>	Measure distances in the map view in "freehand mode".
	<b>Hyperlink</b>	Activate the Hyperlink tool.
	<b>Go To</b>	Activate the Go To tool.
	<b>Advanced Select</b>	Activate the Advanced Select tool.

## EDIT/DRAWING TOOLBAR





-  **Select**  
Activate the Select tool.
-  **Vertex Edit**  
Activate vertex display and editing for the selected feature.
-  **Point**  
Activate the point feature type for data capture.
-  **Capture Point Using GPS**  
Capture a point feature in the editable point layer using the current GPS position.
-  **Add GPS Vertex**  
Capture a single vertex in the current line or polygon feature using the current GPS position.
-  **Add GPS Vertices Continuously**  
Continuously capture vertices in the current line or polygon feature using the current GPS position.
-  **Feature Properties**  
Open the Feature Properties dialog box (or custom edit form) for the selected feature.

## SELECT DROPDOWN LIST





-  **Select**  
Activate the Select tool.
-  **Select at GPS Position**  
Select the feature at the current GPS position.

## POINT DROPDOWN LIST

-  **Point**  
Activate the point feature type for data capture.
-  **Line**  
Capture a straight line feature using the pen.
-  **Polyline**  
Activate the polyline feature type for data capture and start a new line feature.
-  **Freehand Line**  
Capture a freehand line feature using the pen.

-  **Rectangle**  
Capture a rectangle polygon feature using the pen.
-  **Polygon**  
Activate the polygon feature type for data capture and start a new polygon feature.
-  **Ellipse**  
Capture an ellipse polygon feature using the pen.
-  **Circle**  
Capture a circle polygon feature using the pen.
-  **Freehand Polygon**  
Capture a freehand polygon feature using the pen.

## FEATURE PROPERTIES DROPDOWN LIST

-  **Feature Properties**  
Open the Feature Properties dialog box (or custom edit form) for the selected feature.
-  **Zoom to Selected Feature**  
Zoom to the selected feature.
-  **Center on Selected Feature**  
Center the map on the selected feature without changing the current map scale.
-  **Go to Selected Feature**  
Set the selected feature to be the current destination for navigation.
-  **Delete Feature**  
Delete the selected feature.

## ArcPad Resources

- Visit [www.esri.com/arcpad](http://www.esri.com/arcpad) for:
- The latest information on ArcPad.
  - Updates and downloads.
  - Technical Support Knowledge Base.
  - ArcPad Discussion Forum.



Copyright © 1995-2002 ESRI. All rights reserved. ESRI, the ESRI logo, ArcPad, the ArcPad logo, www.esri.com, and the ArcPad logo are trademarks, registered trademarks, or service marks of ESRI in the United States, the European Community, or certain other jurisdictions.

### Appendix 3: NMEA Messages supported by ArcPad 5

Sentence Title	Description
\$GPGGA	GPS Fix Data
\$GPGLL	Geographic Position, Latitude/Longitude
\$GPGSA	GPS DOP and Active Satellites
\$GPGSV	GPS Satellites in view
\$GPRMC	Recommend Minimum Specific GPS/TRANSIT Data
\$GPRRE	Range Residual Error
\$GPVTG	Track Made Good and Ground Speed
\$GPZDA	Time and Date
\$PGRME	Estimated Error Information (Garmin Proprietary)

Courtesy of ESRI website, [www.esri.com](http://www.esri.com)

## Appendix 4: NMEA Deciphered

\_\_\_\_\_ 1            2            3 4            5 6 7 8    9    10 11 12 13 14    15  
 GGA,hhmmss.ss,xxxx.xx,a,yyyyy.yy,a,x,xx,x.x,x.x,M,x.x,M,x.x,xxxx\*hh

- 1 UTC of Position
- 2-3 Latitude - N/S
- 4-5 Longitude - E/W
- 6 GPS Quality indicator
  - 0 = no fix, or invalid
  - 1 = GPS SPS mode, fix valid
  - 2 = Differential GPS, SPS mode, fix valid
  - 3 = GPS PPS mode, fix valid
- 7 Number of satellites in use
- 8 Horizontal dilution of precision
- 9 Antenna altitude above/below mean sea level
- 10 Units of altitude M=meters
- 11 Geoidal separation
- 12 Units of Geoidal separation, M = meters
- 13 Age differential GPS data - Time in seconds since last SC104 type 1 or 9 update, null field when DGPS is not used.
- 14 DIfferential reference station ID
- 15 Checksum

E.g.:

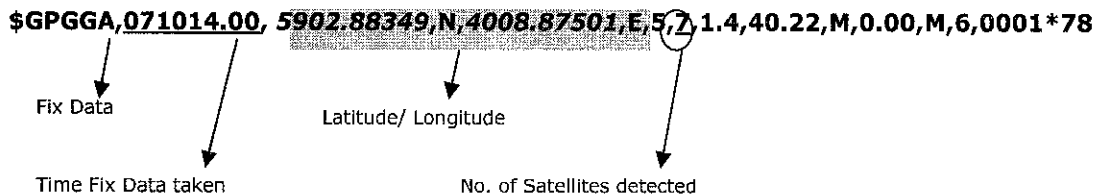

## **Appendix 5: Steps to connect GPS to ArcPad**

In order to connect a GPS receiver to ArcPad, several steps will be needed.

1. Make sure that the ArcPad project has a defined projection; hence the GPS buttons are enabled.
2. In ArcPad, under the ArcPad options, GPS tab, select GPS protocol (NMEA, TSIP DeLorme Earthmate, or Rockwell PLRG GPS Binary Protocol). In this case, since both the GPS unit uses the NMEA protocol, the NMEA option should be selected.
3. Make sure the GPS receiver is configured to output the same protocol as ArcPad, the NMEA protocol.
4. Make sure the GPS port configurations on the GPS receiver and in ArcPad's GPS Port options match.
5. Make sure the serial connection between the GPS receiver and the Windows CE computer, or PC is OK.
6. Open the GPS Debug window to verify that the communication with the GPS receiver is working.
7. Open the GPS Position Window and verify that the GPS coordinates are correct and what you would expect.

These are the given guidelines from the ESRI Support Forum. The reliability of these steps will only be confirmed once the design and development phase of the end product commence. Also, further confirmation will be needed to ensure that the PDA can be connected to the GPS unit via serial cable.

Courtesy of ESRI website, [www.esri.com](http://www.esri.com)

## **Appendix 6: Bluetooth vs. Wi-Fi**

Bluetooth is a low-power, short-range (approximately 3 meters) networking specification with moderately fast transmission speeds of 800 Kbps. It provides a wireless, point-to-point, and “personal area network” for PDA, notebooks, printers, mobile phones, audio components, and other devices. The wireless technology can be used anywhere you have two or more devices that are Bluetooth enabled.

802.11b standard is ratified by the Institute of Electrical and Electronics Engineers (IEEE) in 1999. With Wireless LAN 802.11b (WLAN), or more commonly known as Wi-Fi (short for Wireless Fidelity), users can access to Ethernet networks such as a corporate LAN or the Internet at a speed of up to 11 Mbps. Its connection can be made up to about 30 meters away from a Wi-Fi networking node (regularly referred to as “hot-spot”). With a Wi-Fi networking card or built-in chip, the user can surf the Internet at broadband speeds wirelessly.

### Similarities:

1. Both are wireless networking standards that provides connectivity via radio waves
2. Both operate in the same frequency band – 2.45 GHz
3. Both provides agreement at the physical level and the data link level

### Differences:

1. Bluetooth’s primary use is to replace cables, while Wi-Fi is largely used to provide wireless high-speed access to the Internet or a Local Area Network (LAN)
2. The range for the two standards is different. Bluetooth can operate within 3 meters, where as Wi-Fi can operate within 30 meters from the “hot-spot”
3. The speed of transmission for Bluetooth is approximately 800 Kbps, while Wi-Fi with 802.11b standard offers a speed up to 11 Mbps (and 54 Mbps with 802.11a standard)
4. Bluetooth is point-to-point, where as Wi-Fi is point-to-multipoint



## Appendix 7: ArcXML Applet Source Code (GPSTracklog4.apa)

```
<!-- *****GPS Tracklog Simulation Toolbar*****-->

<?xml version="1.0" encoding="UTF-8"?>
<ArcPad>
<APPLET name="GPSTrackLog">
<FORMS>
  <FORM name="GPSTrackLog" caption="GPS TrackLog" width="110" height="30" tabsvisible="false">
  <PAGE name="tracklog" caption="GPS TrackLog Simulation" onok="MakePoint">
    <LABEL name="Label1" x="5" y="10" width="150" height="20" caption="Click OK to Start the GPS
    Tracklog Simulation"/>
  </PAGE>
  </FORM>
</FORMS>
<TOOLBARS>
  <TOOLBAR name="GPSTrackLog" visible="true" caption="GPS TrackLog ">
  <TOOLBUTTON image="badzMaruStart.bmp" onclick="Call StartGPS" />
  <TOOLBUTTON image="chefStop.bmp" onclick="Call SaveShapeFile" />
  </TOOLBAR>
</TOOLBARS>
<SYSTEMOBJECTS>
  <AUX oncomm="Call Trigger"></AUX>
  <APPLICATION ontimer="Call timer" onstartup="Aux.Open"></APPLICATION>
</SYSTEMOBJECTS>
</APPLET>
<SCRIPT src="GPSTrackLog3.vbs"/>
</ArcPad>
```

## Appendix 8: VBScript Source Code

```
*****
'Final Year Project
*****
'Name      : Boon Xian Yu
'Program   : Information Technology
'Supervisor : Mr. Justin Dinesh Devaraj
'Latest Date : 31 May 2004
'File Name  : GPSTracklog3.vbs
*****
```

Option Explicit

```
Dim intStopBit, Timer1
Dim Conn, intNum, Pt, MyArray, dblX, dblY, pPt
```

```
Private Sub Timer
    Call StartPlotting
End Sub
```

```
Sub Trigger
    Set Timer1 = Application.Timer
    Timer1.Interval = 1000
    Timer1.Enabled = True
End Sub
```

```
Sub StartGPS
    'If there are no layers in the map, then exit (no statistics to calculate).
    If Map.Layers.Count = 0 Then
        MsgBox "The current map does not contain any layers.",48,"No Layers"
        Exit Sub
    'Otherwise, start plotting.
    Else
        intStopBit=0
        Call MakePoint
    End If
End Sub
```

```
Sub StartPlotting

    Pt = Conn.ReadLine
    MsgBox "Read " & intNum & " " & Pt
```

```

MyArray = split(Pt, ",", -1, 1)
dblX = MyArray(0)           'Assume the first two entries in the text file contain Lat/long info
dblY = MyArray(1)
'MsgBox "dblX is " & dblX & " and dblY is " & dblY

Call Application.Map.AddfeatureXY(dblX, dblY, False)

End Sub

Sub MakePoint

Dim fileimport, objSel, objRS
Dim objLayer

Set fileimport = Application.CreateAppObject("recordset")
Call fileimport.Create ("\\Program Files\\ArcPad\\Applets\\GPSPlot.shp", 1)
Call fileimport.Fields.Append("Status", 129, 16)

Set fileimport = Nothing

Call Application.Map.AddLayerFromFile ("\\Program Files\\ArcPad\\Applets\\GPSPlot.shp")

Set objLayer = Map.Layers("GPSPlot")
'MsgBox "objLayer set already"
If objLayer.CanEdit Then
    objLayer.Editable = True
End If

Set Conn = Application.CreateAppObject ("File")           'Open GPSData3.txt
Conn.Open "\\Program Files\\ArcPad\\Applets\\GPSData3.txt"
intNum = 1

While Not Conn.EOF And intStopBit=0
    Pt = Conn.ReadLine
    'MsgBox "Read " & intNum & " " & Pt

    MyArray = split(Pt, ",", -1, 1)
    dblX = MyArray(0)           'Assume the first two entries in the text file contain Lat/long info
    dblY = MyArray(1)
    'MsgBox "dblX is " & dblX & " and dblY is " & dblY

    Call Application.Map.AddfeatureXY(dblX, dblY, False)

Call Timer

```

```

    intNum = intNum + 1
Wend
Conn.Close

Set objSel = Application.Map.SelectionLayer
Set objRS = objSel.Records
objRS.Bookmark = Map.SelectionBookmark
objRS.Fields("Status").Value = "Imported"
objRS.Update

Call SaveShapeFile

End Sub

Sub StopGPS
    intstopBit = 1
    MsgBox "GPS TrackLog Terminated!"
    Call SaveShapeFile
End Sub

Sub SaveShapeFile

dim defFile, defExt, myfilter, title, result
defFile = "GPSPlot"
defExt = ".shp"
myfilter = "ArcPad Layer Files (*.shp)|*.shp|All Files|*.*"
title = "Save File As"

'Show the Save As dialog box and get the result
result = CommonDialog.ShowSave(defFile,defExt,myfilter,title)

'If the result is numeric (0), the user pressed the cancel button or closed the dialog box
'Otherwise, display the selected file
If isnumeric(result) then
    MsgBox "Save As dialog cancelled!",64,"Cancel"
    Exit Sub
Else
    MsgBox result,64,"Result"
End If

End Sub

```

## Appendix 9: Sample GPS Data

\$GPGGA,071014.00, 5902.88349,N,4008.87501,E,5,7,1.4,40.22,M,0.00,M,6,0001\*78  
\$GPGGA,071015.00, 5882.88349,N,4108.87501,E,5,7,1.4,40.21,M,0.00,M,7,0001\*7B  
\$GPGGA,071016.00, 5872.88349,N,4208.87501,E,5,7,1.4,40.21,M,0.00,M,8,0001\*77  
\$GPGGA,071017.00, 5862.88349,N,4258.87501,E,5,7,1.4,40.21,M,0.00,M,9,0001\*77  
\$GPGGA,071018.00, 5862.88349,N,4408.87501,E,5,7,1.4,40.21,M,0.00,M,10,0001\*40  
\$GPGGA,071019.00, 5862.88349,N,4508.87501,E,5,7,1.4,40.21,M,0.00,M,11,0001\*40  
\$GPGGA,071020.00, 5852.88349,N,4608.87501,E,5,7,1.4,40.21,M,0.00,M,12,0001\*49  
\$GPGGA,071021.00, 5832.88348,N,4708.87500,E,5,7,1.4,40.22,M,0.00,M,13,0001\*4A  
\$GPGGA,071022.00, 5822.88348,N,4808.87500,E,5,7,1.4,40.21,M,0.00,M,14,0001\*4D  
\$GPGGA,071023.00, 5812.88348,N,4908.87500,E,5,7,1.4,40.20,M,0.00,M,15,0001\*4C  
\$GPGGA,071024.00, 5802.88348,N,5008.87500,E,5,7,1.4,40.20,M,0.00,M,16,0001\*48  
\$GPGGA,071025.00, 5832.88348,N,5108.87500,E,5,7,1.4,40.20,M,0.00,M,17,0001\*48  
\$GPGGA,071026.00, 5842.88349,N,5208.87501,E,5,7,1.4,40.21,M,0.00,M,10,0001\*4D  
\$GPGGA,071027.00, 5802.88349,N,5308.87501,E,5,7,1.4,40.21,M,0.00,M,11,0001\*4D  
\$GPGGA,071028.00, 5752.88349,N,5408.87501,E,5,7,1.4,40.21,M,0.00,M,12,0001\*41  
\$GPGGA,071029.00, 5722.88349,N,5508.87501,E,5,7,1.4,40.22,M,0.00,M,13,0001\*42  
\$GPGGA,071030.00, 5702.88349,N,5608.87500,E,5,7,1.4,40.22,M,0.00,M,14,0001\*4C  
\$GPGGA,071031.00, 5692.88348,N,5708.87500,E,5,7,1.4,40.23,M,0.00,M,15,0001\*4C  
\$GPGGA,071032.00, 5672.88348,N,5808.87500,E,5,7,1.4,40.22,M,0.00,M,16,0001\*4D  
\$GPGGA,071033.00, 5662.88348,N,5908.87500,E,5,7,1.4,40.23,M,0.00,M,17,0001\*4C  
\$GPGGA,071034.00, 5651.88348,N,6008.87500,E,5,7,1.4,40.23,M,0.00,M,18,0001\*44  
\$GPGGA,071035.00, 5651.88348,N,6108.87500,E,5,7,1.4,40.23,M,0.00,M,19,0001\*44