

Accepted version

Andrew P-K, Raudsepp A, Nock V, Fan D, Williams MAK, Stauffer U, Avci E (2022). Developing an Optical Microlever for Stable and Unsupported Force Amplification. 2022 International Conference on Manipulation, Automation and Robotics at Small Scales (MARSS). 25/07/2022-29/07/2022. 2022 International Conference on Manipulation, Automation and Robotics at Small Scales (MARSS).

Published in: [2022 International Conference on Manipulation, Automation and Robotics at Small Scales \(MARSS\)](#)

Date of Conference: 25-29 July 2022

Date Added to IEEE *Xplore*: 02 September 2022

DOI: [10.1109/MARSS55884.2022.9870464](#)

Publisher: IEEE

Conference Location: Toronto, ON, Canada

© 2022 IEEE. Personal use of this material is permitted. Permission from IEEE must be obtained for all other uses, in any current or future media, including reprinting/republishing this material for advertising or promotional purposes, creating new collective works, for resale or redistribution to servers or lists, or reuse of any copyrighted component of this work in other works.

Developing an Optical Microlever for Stable and Unsupported Force Amplification

Philippa-Kate Andrew¹, Allan Raudsepp², Volker Nock^{3,5}, Daniel Fan⁴, Martin A. K. Williams^{2,5}, Urs Staufer⁴, and Ebubekir Avci^{1,5}

Abstract—Optical micromachines have the potential to improve the capabilities of optical tweezers by amplifying forces and allowing for indirect handling and probing of specimens. However, systematic design and testing of micromachine performance is still an emerging field. In this work we have designed and tested an unsupported microlever, suitable for general-purpose optical tweezer studies, that demonstrates stable trapping performance and repeatable doubling of applied forces. Stable trapping was ensured by analysing images to monitor focus shift when levers oscillated repeatedly, before the best-performing design was selected for force amplification. This study also shows that direct measurement of trap stiffness using the equipartition theorem appears to be a valid method for measuring applied forces on the spherical handles of microlevers.

I. INTRODUCTION

Optical tweezers have proven to be a useful technology for investigating the effects of minuscule forces on biological specimens [1]. Investigating mechanical changes in cancer cells [2], examining enzyme activity [3], and stretching single molecules [4] are just a few of the studies that have been enabled by optical tweezers. However, there are two major drawbacks to optical tweezers: the potential for damage to biological samples, due to the intensely focused laser used to create the traps; and the low limit to forces that can be applied (tens of femto-Newtons to hundreds of pico-Newtons) [5].

There are several strategies that have been proposed to reduce damage caused by optical tweezers. These traditionally include the introduction of scavenging species to deal with free radicals generated during trapping [6], careful selection of the laser wavelength to limit absorption [7], [8], and limiting the laser power to reduce overall exposure. Indirect manipulation has also been utilised, which has the added bonus of allowing researchers to examine specimens that cannot be trapped with traditional Gaussian beams. Such specimens include DNA, which is below the diffraction limit

*This work was supported by the Marsden Fund Council from New Zealand Government funding, managed by Royal Society Te Aparangi (MAU1714)

¹ Department of Mechanical and Electrical Engineering, Massey University, Palmerston North 4442, New Zealand.

² School of Fundamental Sciences, Massey University, Palmerston North 4442, New Zealand.

³ Department of Electrical and Computer Engineering, University of Canterbury, Christchurch, New Zealand.

⁴ Department of Precision and Micro Engineering, Technische Universiteit Delft, 2600 AA Delft, The Netherlands.

⁵ The MacDiarmid Institute for Advanced Materials and Nanotechnology, Wellington 6140, New Zealand.

Corresponding author: E. Avci e.avci@massey.ac.nz

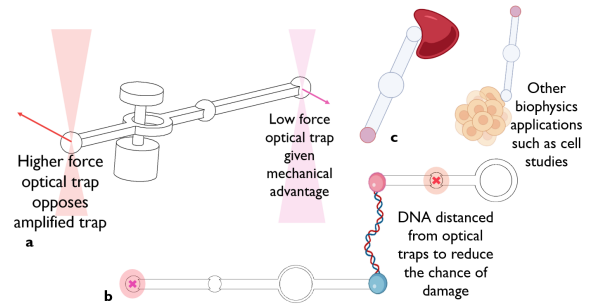

Fig. 1. Using microlevers to distance optical traps from the sample being studied, as well as amplifying the forces applied could have useful applications in biology and biophysics. Our experiment uses a two-trap set-up to test and quantify optical force amplification (a), with the hope that such levers could become useful tools in areas such as molecule stretching (b) and cell studies (c).

[4], large, flat objects that scatter the beam [9] and complex biological cells with varied refractive indices [10].

The past 20 years have brought advances in micro-manufacturing for optical micromachines; particularly the use of two-photon absorption polymerisation (TPAP) to facilitate laser-based, nanoscale 3D printing [11]. This has allowed the tools for indirect manipulation of biological specimens to advance beyond microbeads to more complex shapes [12] and even multi-body micromachines [13]. Using micromachines as end-effectors for optical tweezer studies also introduces the opportunity to tackle the problem of limited forces, as well as the damage associated with trap proximity [14], through giving optical traps the mechanical advantage [15], [16]. In Fig. 1 we have illustrated our method to test force amplification of unsupported levers using two optical traps of different strengths, as well as some applications where distancing the optical traps, and potentially amplifying force, would be useful.

While the multiplication of optical force has been demonstrated, and optical micromachines have been used to perform a few tasks, systematic analysis of optical microrobots is still in its infancy. Analytical models of optical trapping forces are known to be relatively simple when the trapped particles fit in the dipole [17] or ray optics regimes [18]. Even so, these models require exact knowledge of the optical trapping set up, which may not be available to every user, and the majority of strongly-trapped (and therefore useful) objects are of intermediate size, similar to the trapping wavelength. Likewise, forces on spheres which fall within the intermediate size range can be calculated using Mie

theory, but producing a quantitative result is non-trivial, and complexity increases for non-spherical objects [19].

One popular way to calculate forces on non-spherical objects is to define a transformation matrix (T-matrix) that describes how an object scatters the incoming electromagnetic wave. This allows for the calculation of forces by comparing incoming and scattered waves [20], and computational toolboxes have been developed for this method [21]. However, for scientists undertaking inter-disciplinary research, a more practical method is to accept a Hookean spring model of optical tweezers. This allows the researcher to simply take calibration measurements of trap stiffness and forces based on restricted thermal diffusion of trapped particles [22] or of forces generated in competition with known Stokes drag forces through monitoring particle velocity [23]. This gives good results for spherical objects, and can be used to determine the relationship between laser power and optical tweezers force. Comparison of the stiffness measurement and drag force methods also show that they are in good agreement with each other, leaving the choice of method up to the researcher [23].

In previous works involving micromachines, calibration on spherical particles has been used to find a relationship between optical force and supplied laser power. It has then been assumed that this relationship between power and force is exactly maintained when a spherical handle on a lever, rather than a single particle, is trapped [15], [24], [25]. Some studies, such as one involving 3D printed optical gears, do not attempt to quantify the forces used at all, and instead use successful movement of the machine as proof-of-principle that amplification of optical forces can occur in this way [26]. Several lever-based studies have used a spring, fabricated through TPAP to measure the resulting forces after amplification [15], [16]. While this is an excellent way to demonstrate both the amplification of force and the capabilities of TPAP, it means that only amplification of high powered optical tweezers can be demonstrated, as lower power optical tweezers lack the stiffness required to compress the polymer. Such springs also act to restrict the motion of the lever, ensuring motion remains in the plane of force application, but restricts direct application of such tools. Removing the spring to create a general-purpose lever means that stable optical trapping of the tool becomes crucial.

In this article we cover the design and characterisation of levers to be used for force amplification, using the Nanoscribe Photonic Professional GT2 (PPGT2) (Nanoscribe GmbH, Karlsruhe, Germany) and the IP-L 780 photoresin, also from Nanoscribe. These levers were used to demonstrate force amplification using two optical traps: an adjustable holographic optical tweezers (HOT) trap, controlled using the Red Tweezers software from Bowman et al. [27] and a fixed trap, capable of applying much higher forces. In contrast to earlier studies, our levers are completely unsupported, and the pivot point is created by mechanical contact between the central pin and the lever arm, rather than the lever being held in place by a spring. In addition, we have compared

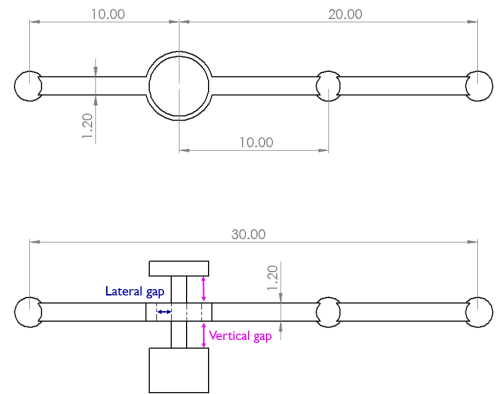

Fig. 2. The basic design for levers in this work featured an "effort arm" twice as long as the shorter "output arm". The longer side also featured two spherical handles, to be used for optical trapping, to allow for comparison between force applied with an equal lever arm ratio and a force applied using the 2:1 arm ratio. The lateral and vertical gaps, shown in dark blue and magenta respectively, are important for the functionality of the lever, as inadequate separation between parts leads to a greater likelihood of adhesion between parts.

the trapping stability offered by differently shaped "handles" on the levers, as well as the impact of reducing separation between components, by analysing changes in image quality over cycles of lever oscillation. This work shows the capability of well-designed optical micro-levers to amplify even low forces, in contrast with previous studies, which used extremely high-powered optical tweezers to actuate micromachines. As TPAP is an extremely versatile technique, which can be used to create complex geometries, a general purpose lever such as this can be easily adapted for different biological studies. An example of such an adaptation can be found in our previous work [13], where a pocket was printed at one end of the lever, for the attachment of a functionalised microbead.

II. LEVER DESIGN

The lever is a classic machine for amplifying mechanical forces, and examples can be found everywhere in engineering and in nature. To amplify forces, there needs to be a greater distance between effort and pivot compared to that between the pivot and the output force. Therefore, the first step of this work was to design a basic lever that rotates around a central pin, with one side of the arm twice as long as the other. This should allow for a doubling of the input force, assuming no losses, and a drawing of the basic lever is shown in Fig. 2, where dimensions are shown in micrometres.

While this is an extremely simple concept, the prevalence of surface forces contributing to adhesion at the microscale means that even ensuring the lever will rotate is a relatively difficult task. Attractive forces on the microscale are associated with small separation distance and large overlapping area between objects, so introducing large gaps between parts, and minimising the overlapping area both seem like appropriate first steps when creating functional micromachines [28], [29]. However, in this case, the goal is to demonstrate effective multiplication of force, which requires

some contact between the pin and the lever arm. Therefore, the tolerance around the pin joint, which is required to ensure the clean printing of two parts, and to increase the likelihood of turning, poses a challenge to force multiplication. In short, the joint needs to have enough tolerance to print correctly, enough contact to multiply force, and low enough friction so that it does not prevent the lever from turning. In previous studies [15], [25] the problem of pin-joint tolerance and internal friction was dealt with by introducing a spring, which held the lever at an appropriate pivot point and showed force amplification through its compression and extension. In our work, joint tolerance has been improved by limiting the gap around the centre pin to $1.0\ \mu\text{m}$, which was the smallest lateral gap that led to 100% of the levers in a printed batch being able to rotate in milliQ water.

The choice to use a small lateral gap contrasts with our earlier work [29], where a gap of $1.6\ \mu\text{m}$ was used, in order to increase the chances of rotation in high ionic strength environments. However, in that work the primary motivator for such a large gap was to decrease the overlapping area between the pin and the lever arm. A short test using a very large centre pin and levers with four different lateral gap sizes was used to validate that the previous success of designs with large lateral gaps was likely due to reduction in overlapping area rather than the increase in part separation, as shown in Fig. 3. Decreasing the diameter of the centre pin to $4.0\ \mu\text{m}$ from the $6.0\ \mu\text{m}$ diameter used for this test was then sufficient to improve rotation success to 100%. While the parameters used for this study were sufficient to produce 100% successful levers in each test batch of 10 levers, fabrication windows for the PPGT2 may change over time, requiring dose-testing and adjustment.

The levers have a very high aspect ratio (a length:width/thickness value of 25 for the lever arm) meaning that stable optical trapping is a challenge, due to the tendency of optically trapped objects to align their longest dimension with the axis of the trap. This is partially addressed by leaving the centre pin of the lever fixed to the substrate, rather than entirely detaching it. However, some movement of the lever out of the trap centre will still be seen, and it is our wish to reduce this as much as possible. One method is to change the size and shape of the printed handles, using the intuitive understanding that flatter surfaces lead to more scattering interactions with the trap, which decreases the apparent strength of the gradient force. By making the handles larger, the difference in geometry between the spheres and the rest of the lever arm becomes more pronounced, which is also true if we elongate the handles, making them spheroids rather than spheres by design. Therefore, in this work we have produced levers with $2\ \mu\text{m}$ and $3\ \mu\text{m}$ diameter spherical handles, as well as levers with elongated spheroidal handles, which have a long axis of $3\ \mu\text{m}$, and a short axis of $2\ \mu\text{m}$. These different lever handles are shown in Fig. 4.

Additionally, a reduction in the vertical gap between the centre pin and the lever arm was explored. Similar to the lateral gap size, the decision was made to produce some

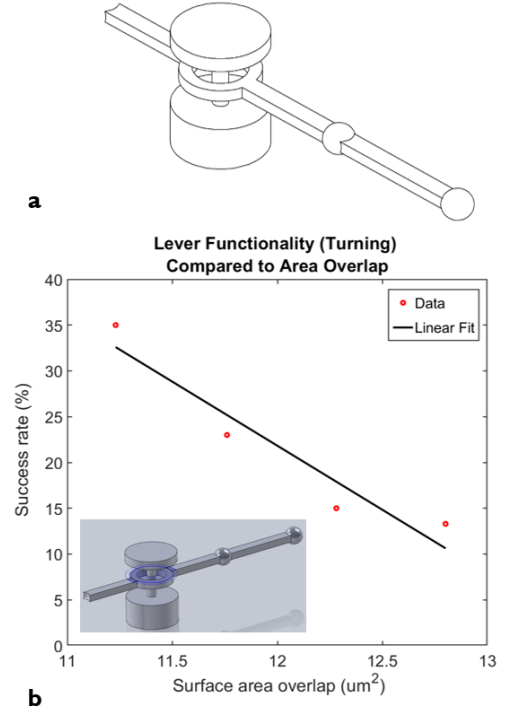

Fig. 3. A short test using a series of levers with outsize centre pins (concept shown in a) showed a decrease in success rate with increasing area (b), despite the levers with larger area also having larger lateral gaps. Gap size was incremented by $0.2\ \mu\text{m}$, from 1.0 to $1.6\ \mu\text{m}$. Overlapping area was calculated per the shaded area shown in (b, inset), based on the projected vertical area of the lever arm on the pin, when in a perfectly centred position.

levers with a vertical gap size of $1.4\ \mu\text{m}$, compared to the larger gap of $1.8\ \mu\text{m}$, as this was found to be the smallest vertical gap at which 100% rotating, 10-lever batches could be produced. The varying features of the chosen lever designs are explained in Table I. All levers had a vertical projected area of $5.5\ \mu\text{m}^2$ and a $200\ \text{nm}$ thick ridge on the inside radius of the lever arm, in order to reduce contact with the centre pin.

TABLE I
VARIABLE FEATURES OF THE LEVERS USED IN THIS WORK.

Lever Name	Vertical Gap (μm)	Handle Shape	Handle Diameter (μm)
1014 2H	1.4	Spherical	2.0
1014 3H	1.4	Spherical	3.0
1014 3OH	1.4	Elongated Spheroid	3.0/2.0
1018 2H	1.8	Spherical	2.0
1018 3H	1.8	Spherical	3.0
1018 3OH	1.8	Elongated Spheroid	3.0/2.0

A. OPTICAL TWEEZERS SET-UP

The experiments for quantifying out of plane movement and amplifying force were both based around a Nikon Eclipse TE2000-U inverted microscope, mounted to a vibration isolation table. The microscope was equipped with a $1064\ \text{nm}$, $2\ \text{W}$ maximum power laser for creating holographic optical tweezers (Arryx, Chicago, USA) and a $1030\ \text{nm}$, $5\ \text{W}$ maximum power laser for creating a single, fixed

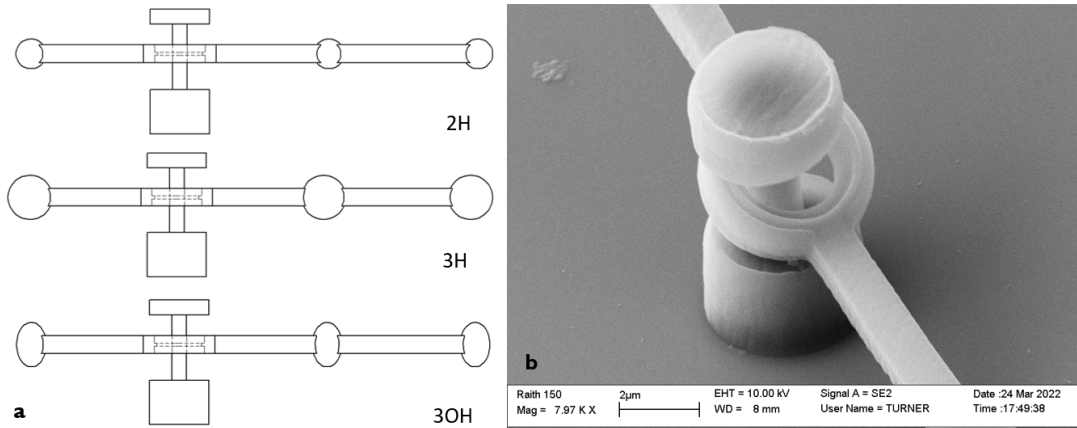

Fig. 4. (a) The levers used for this study had different handle shapes, which were referenced by 2H, 3H or 3OH in the naming convention used. (b) an SEM image showing the successful printing of the ridge that was used to reduce contact between the centre axis and the inner radius of the lever arm.

trap in the centre of the imaging plane (Arryx, Chicago, USA). These lasers were focused through a 60x, 1.2 NA plan apo water immersion objective (Nikon) to create optical tweezers.

The fixed optical trap provides much higher optical forces than the holographic optical trap- approximately 6–10x higher [13], [30]. The power of the fixed trap was attenuated using a neutral density filter (OD 0.6), in order to measure the force amplification by limiting the force to approximately twice as high as that which can be achieved with the HOT. Without attenuating the fixed trap, it would be too stiff to measure force amplification at the 2:1 mechanical advantage trialled here. The holograms for the HOT were created using a Boulder Nonlinear Systems spatial light modulator, and placed using the Red Tweezers software. A piezo-motor stage (Physik Instrumente, Karlsruhe, Germany) was used to position the sample relative to the 1030 nm trap. Experiments were performed in bright field conditions, and images were captured using a high speed sCMOS camera (CC215MU, ThorLabs, USA). The microlevers were rotated using a borosilicate microprobe mounted on stepper-motor stages (TAMM40-10C and OSMS60-5ZF, Sigma-Koki, Japan), prior to the experiments, to ensure the levers were free-floating and able to rotate. A diagram of the set-up is shown in Fig. 5.

III. EXPERIMENTATION AND RESULTS

A. QUANTIFYING OUT OF PLANE MOVEMENT

Confidence in the results from force-related experiments performed using optical tweezers can be improved if the motion used to apply the force is restricted to the x-y plane, where it can be directly observed using a conventional microscope. This is relatively simple when using microbeads to apply force, as the focus of the optical tweezers can be adjusted to coincide with the focus of the camera used to image the experiment. In our system, despite the use of two separate traps, the matching focus is created by adjusting the height of the sample using a piezo stage, and the height of the HOT, while the position of the 1030 nm trap

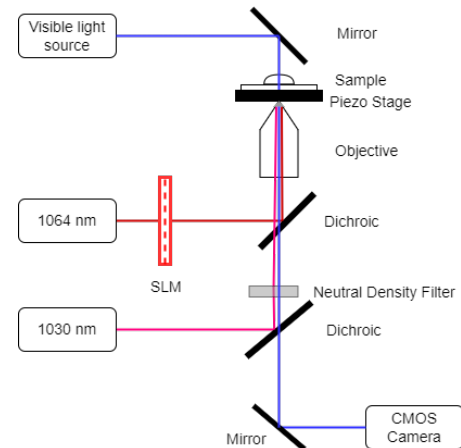

Fig. 5. The setup was equipped with two lasers for creating separate optical traps. This forms two optical tweezers: one holographic and dynamic and the other fixed. The fixed trap was attenuated using a neutral density filter.

is fixed. However, despite the careful adjustment of focus, maintaining in-plane motion over the course of an experiment is a challenge.

In order to quantify the out-of-plane movement of the different lever types, the levers were oscillated using a sin-wave applied via the piezo-stage (frequency = 0.2 Hz, amplitude = 2.0 μm), while trapped by the HOT as shown in Fig. 6. The experiment was imaged at 100 fps using the ThorLabs CC215MU camera and it was assumed that a change in Z-position of any part of the lever would result in a change in focus, which could be detected using changes in pixel intensity values. Obviously, a change in position of the lever in-plane also results in a change in intensity values, and so images in the sequence are compared with others showing the same lever position. Two positions were chosen: the stationary "flat" lever at the start of an oscillation, and the "rotated" lever at the peak of the oscillation. The frames were easily selected by tracking movement of the lever's centre pin, or pivot point, over the course of the experiment, as shown in Fig. 7 and selecting frames at the peaks and the

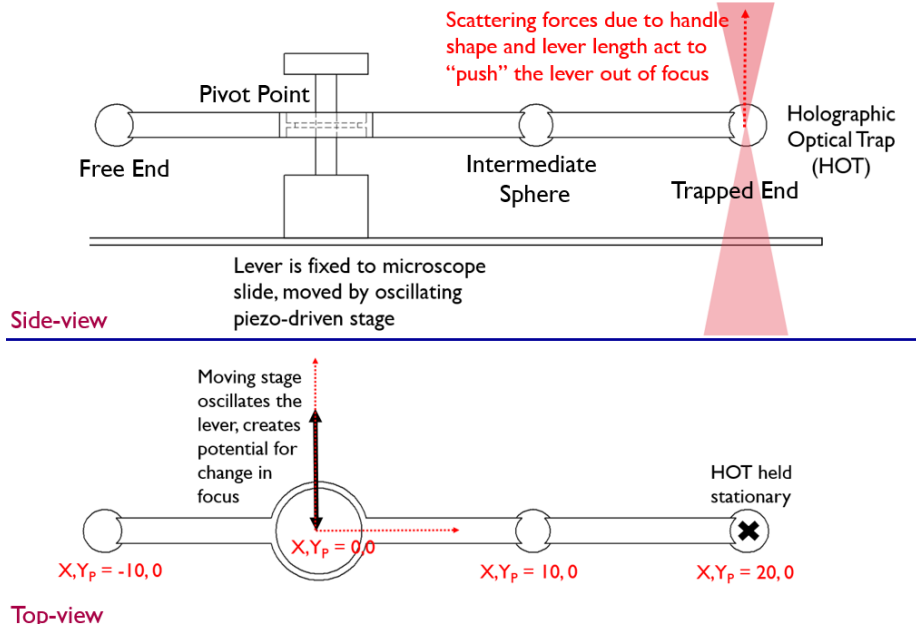

Fig. 6. The levers were oscillated in the Y-direction, for 10 cycles using the piezo stage, with the goal of monitoring out-of-plane movement over the course of these oscillation.

troughs of the resulting wave.

Once frames were selected, evenly spaced rows of pixels were compared with those in the other frames corresponding to the same lever position. The Image Quality Method described in [31] was used to quantify the focus shift between frames, namely by calculating the Pearson correlation of the vectors of Fourier power spectra corresponding to the different images. It was assumed that the best focused frames of the image sequences would be those at the start of the oscillations, and so the correlation was calculated using (1), where η is the length of the Fourier power spectrum vector, X is the power spectrum vector of the first image and Y is the power spectrum vector of the image being compared.

$$r_k = \frac{\eta \sum XY - \sum X \sum Y}{\sqrt{(\eta \sum X^2 - (\sum X)^2)(\eta \sum Y^2 - (\sum Y)^2)}} \quad (1)$$

As the lever is oscillated in the Y-direction, a large amount of pixel variation in this direction can be expected. Therefore, the intensity was sampled using ten evenly spaced rows of pixels, rather than the evenly spaced columns used in the cited paper. The mean focus shift over the course of the levers' oscillations for different supplied trapping powers is presented in Fig. 8, where lever design 1014 3OH, which had spheroidal handles and a $1.4 \mu\text{m}$ vertical gap, was shown to perform most poorly. Interestingly, lever design 1018 3OH performed well, perhaps indicating that interaction between the vertical pin and lever arm, rather than the trapping handle shape, caused the issue. Most of the levers showed more out of plane movement when rotated at lower laser powers, as levers are more likely to move out of a weak trap.

B. AMPLIFYING FORCE

The levers selected for the force amplification task were from the 1018 2H and 1018 3H design groups, as these

had the lowest average focus shift at 2 W trapping power. The trap stiffness of the HOT acting on the lever handles was calculated using the equipartition theorem, (2), where $\langle Y^2 \rangle$ is the position variance of a trapped sphere in the Y direction, k_B is the Boltzmann constant and T is the temperature in K. The resulting relationship between supplied laser power and the trap stiffness can be seen for the two handle sizes in Fig. 9, where the stiffness measurements for a trapped polystyrene bead (diameter = $2 \mu\text{m}$) are also shown. The fair agreement between the values for the microbeads and those for 1018 2H adds confidence to the use of this method for measuring forces on the levers. The slightly lower maximum for 1018 2H can possibly be attributed to the IP-L 780 resin having a lower refractive index than polystyrene [32].

$$k_y = \frac{k_B T}{\langle Y^2 \rangle} \quad (2)$$

The trap stiffness on the handles for 1018 2H was almost twice as high as that on 1018 3H at 2 W. This indicates that the size of trapping handles on micromachines should be carefully chosen according to the optical trap being used, as well as what can be repeatably manufactured. As the HOT is much weaker than the fixed trap, the highest trap stiffness was desirable for this experiment. Therefore, the decision was made to only attempt force amplification with levers from the 1018 2H group. Stiffness of the fixed trap on the 1018 2H lever handles was measured using the same method, and the results are shown in Fig. 10.

The lever was positioned with the "sensor" handle in the 1030 nm fixed optical trap, and the HOT was used to move the lever, opposing the fixed trap. By using the intermediate handle, a 1:1 proportional factor was created and no force

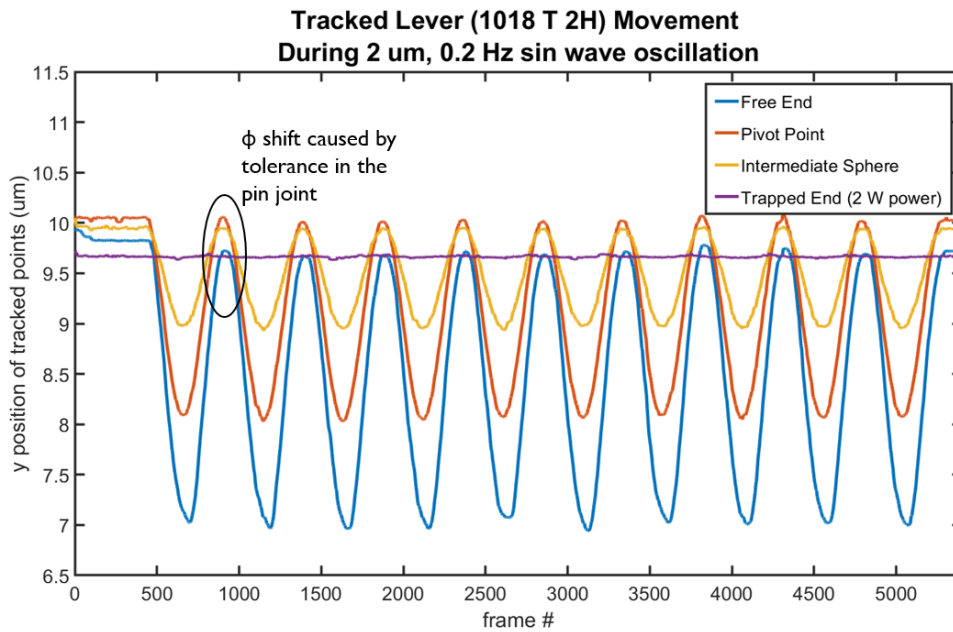

Fig. 7. Tracking the movement of the lever over the course of the experiment provided an easy method for selecting frames to compare to each other. In this case 100 frames were selected from the peaks and the troughs of the pivot's movement, respectively. This plot also shows the inconsistent phase shift between the free end of the lever and the oscillating pivot, which is attributed to the tolerance of the pin joint.

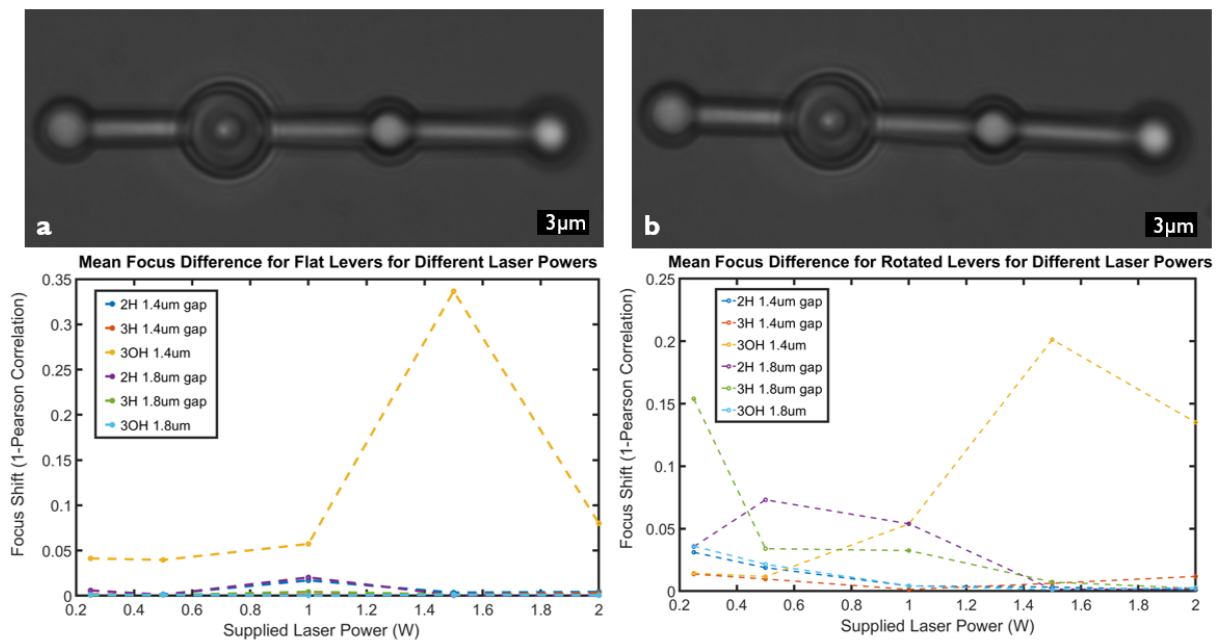

Fig. 8. Strips across the image were used to quantify a change in focus as the levers were moved back and forth to test trap stability. Correlation of the Fourier power spectra of these strips was calculated for the "flat" (a) and "rotated" (b) cases, which corresponded with the beginning and peak of oscillations respectively.

amplification occurred, resulting in small fluctuations from the fixed trap. When the end handle was used, a 2:1 proportional factor was created, and increased movement was observed. It was expected that the force provided by the HOT would be amplified by the same ratio as the proportional factor, due to balancing of moments about the central pivot. Force amplification was attempted using 2 W power for the

HOT and the full range of powers used for the fixed trap stiffness calculations. However, repeatable force transfer and amplification could not be properly tested until the fixed trap was supplied with ≥ 0.23 W. This is because at lower trap powers the amplified force from the HOT was sufficient to move the lever completely out of the fixed trap, meaning that the amplification could not be quantified. Amplification was

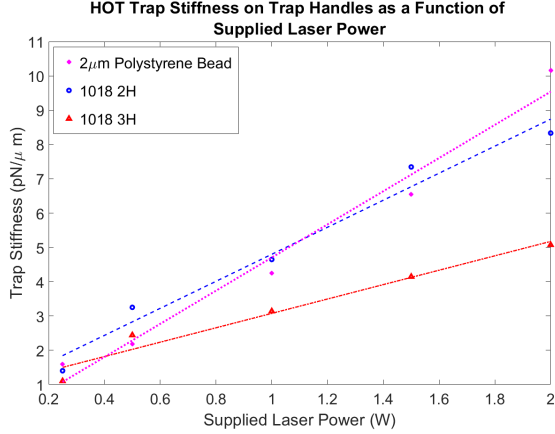

Fig. 9. The calculated trap stiffness for the 3 μm trap handles was much lower than for the 2 μm handles at the same trapping powers, while the values for the 2 μm handles were comparable to values for 2 μm polystyrene beads.

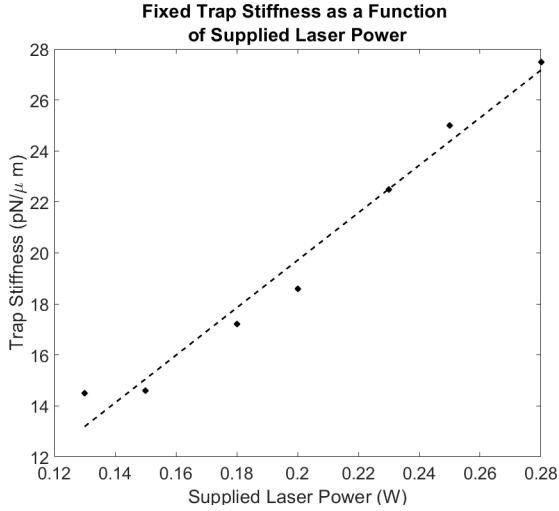

Fig. 10. The calculated trap stiffness for the fixed high power trap was much higher than for the HOT trap, as expected.

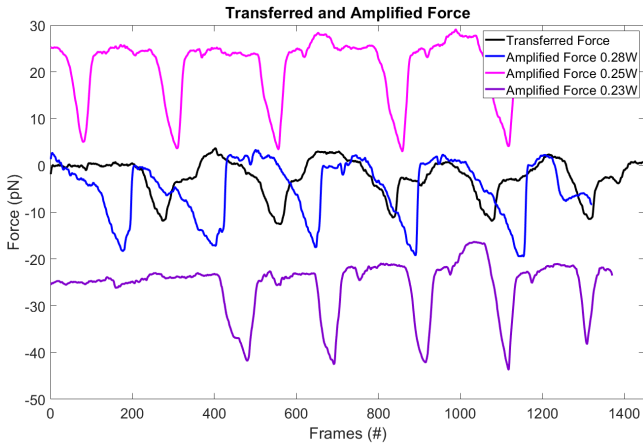

Fig. 11. Force amplification could be measured successfully at three different laser powers, with results shown vertically offset in order to make separate lines clearer.

attempted five times at each of the fixed trap powers, and the force transferred by the lever was calculated using the Hookean model of optical tweezers, given by (3), where k is the trap stiffness and y is the fluctuation from the centre of the trap.

$$F_{trap} = -ky \quad (3)$$

The amplified forces can be seen in Fig. 11, where force transfer and amplification are shown with 0.23 W supplied to the sensing trap, as well as the amplified forces sensed with higher powers, which have been vertically offset for clearer viewing. The force transferred when the 1:1 lever arm ratio was used was approximately 10 pN; in line with what we expect to be the maximum that can be applied with the HOT trap at 2 W power. The amplified forces were consistently measured to be close to 20 pN, with the mean values and uncertainties shown in Table II. The restricted diffusion of the trapped handle, calculated using the mean-square displacement, can be used to estimate the lowest force that can be measured by this set-up. Based on this, the estimated lowest force is of the order of a few femto-Newtons, far below the range we are interested in for this study. At such low forces, Brownian motion could become noticeable in the measurements, in which case time averaging and multiple repetitions of an experiment would go some way to reducing such effects. It is likely that error from other sources, such as drift, would become problematic before Brownian motion. The fact that the amplified force was consistently slightly lower than 2x the transferred force could point to losses in the force transfer. Therefore, characterising drag and internal friction on levers in force amplification studies could be an interesting avenue for future work. As shown in Fig. 7, the tolerance of the lever leads to an inconsistent phase shift- varying between 0.2 and 0.6 rad-between the movement of the pivot point and the free end of the lever, whereas a rigid lever would be in phase with this movement. This complicates the characterisation of drag and internal friction for such pin-jointed levers, but as this work demonstrates, such levers can still be used effectively for force amplification.

TABLE II
MEAN TRANSFERRED AND APPLIED FORCES

Trap Power (W)	Measured Transferred Force (pN)	Uncertainty (pN)	Measured Amplified Force (pN)	Uncertainty (pN)
0.23	10.37	0.98	16.65	2.75
0.25	10.45	0.65	20.11	1.05
0.27	11.86	0.71	21.83	1.14

IV. CONCLUSIONS

Our aim in performing this study was to systematically develop and test performance of an unsupported microlever for amplifying forces; specifically creating a lever that can be trapped stably to repeatably perform the task. We monitored drift of the levers out of focus over the course of several

oscillations, which identified spherical handles as superior to elongated spheroids, particularly at high trapping powers. While 3 μm diameter spherical handles performed well in terms of maintaining focus stability, the low trap stiffness of the HOT on these handles made the 2 μm diameter handles more suitable for the task. The work we have performed demonstrates the potential that optical micromachines have for multiplying even small forces from optical tweezers, as well as the importance of considered handle design. Additionally, we demonstrated that using the equipartition theorem to calculate trap stiffness on a lever handle appears to give acceptable results, allowing researchers to directly measure force amplification, rather than relying on calibration performed with microbeads. Consistent doubling of the applied force was observed and measured using three different trapping powers, demonstrating the suitability of the levers for this task. There is still work to be carried out in characterising the forces on the levers: specifically the drag on the levers, as well as internal friction in the pin joint, as the force amplification results indicated losses that could come from those areas.

V. ACKNOWLEDGMENTS

Authors thank G. Turner, from the UC Nano lab, for equipment assistance and helpful discussions.

REFERENCES

- [1] M. Capitanio and F. S. Pavone, "Interrogating biology with force: single molecule high-resolution measurements with optical tweezers," *Biophys J*, vol. 105, no. 6, pp. 1293–1303, 2013.
- [2] S. Pradhan, M. A. Williams, and T. K. Hale, "Changes in the properties of membrane tethers in response to hp1 α depletion in mcf7 cells," *Biochem. Biophys. Res. Commun.*, vol. 587, pp. 126–130, 2022.
- [3] F. M. Fazal, D. J. Koslover, B. F. Luisi, and S. M. Block, "Direct observation of processive exoribonuclease motion using optical tweezers," *PNAS*, vol. 112, no. 49, pp. 15 101–15 106, 2015.
- [4] C. J. Bustamante, Y. R. Chemla, S. Liu, and M. D. Wang, "Optical tweezers in single-molecule biophysics," *Nat. Rev. Methods Primers*, vol. 1, no. 1, p. 25, 2021.
- [5] C.-H. Lien, M.-T. Wei, T.-Y. Tseng, C.-D. Lee, C. Wang, T.-F. Wang, H. D. Ou-Yang, and A. Chiou, "Probing the dynamic differential stiffness of dsdna interacting with reca in the enthalpic regime," *Opt. Express*, vol. 17, no. 22, pp. 20 376–20 385, 2009.
- [6] A. Blázquez-Castro, "Optical tweezers: Phototoxicity and thermal stress in cells and biomolecules," *Micromachines*, vol. 10, no. 8, 2019.
- [7] G. Leitz, E. Fällman, S. Tuck, and O. Axner, "Stress response in caenorhabditis elegans caused by optical tweezers: Wavelength, power, and time dependence," *Biophys. J.*, vol. 82, no. 4, pp. 2224–2231, 2002.
- [8] M. B. Rasmussen, L. B. Oddershede, and H. Siegmundfeldt, "Optical tweezers cause physiological damage to escherichia coli and listeria bacteria," *AEM*, vol. 74, no. 8, pp. 2441–2446, 2008.
- [9] E. Avci and G.-Z. Yang, "Development of a microhand using direct laser writing for indirect optical manipulation," in *2016 IEEE/RSJ International Conference on Intelligent Robots and Systems (IROS)*. IEEE Press, 2016, p. 5125–5130.
- [10] B. L. Aekbote, T. Fekete, J. Jacak, G. Vizsnyiczai, P. Ormos, and L. Kelemen, "Surface-modified complex su-8 microstructures for indirect optical manipulation of single cells," *Biomed. Opt. Express*, vol. 7, no. 1, pp. 45–56, 2016.
- [11] F. Niesler and M. Hermatschweiler, "Two-photon polymerization — a versatile microfabrication tool," *Laser Technik Journal*, vol. 12, no. 3, pp. 44–47, 2015.
- [12] I. Grexa, T. Fekete, J. Molnár, K. Molnár, G. Vizsnyiczai, P. Ormos, and L. Kelemen, "Single-cell elasticity measurement with an optically actuated microrobot," *Micromachines*, vol. 11, no. 9, 2020.
- [13] P.-K. Andrew, A. Raudsepp, D. Fan, U. Staufer, M. A. K. Williams, and E. Avci, "Optical microlever assisted dna stretching," *Opt. Express*, vol. 29, no. 16, pp. 25 836–25 847, 2021.
- [14] P.-K. Andrew, M. A. K. Williams, and E. Avci, "Optical micromachines for biological studies," *Micromachines*, vol. 11, no. 2, 2020.
- [15] C.-L. Lin, Y.-H. Lee, C.-T. Lin, Y.-J. Liu, J.-L. Hwang, T.-T. Chung, and P. L. Baldeck, "Multiplying optical tweezers force using a microlever," *Opt. Express*, vol. 19, no. 21, pp. 20 604–20 609, 2011.
- [16] Y. J. Jeong, T. W. Lim, Y. Son, D.-Y. Yang, H.-J. Kong, and K.-S. Lee, "Proportional enlargement of movement by using an optically driven multi-link system with an elastic joint," *Opt. Express*, vol. 18, no. 13, pp. 13 745–13 753, 2010.
- [17] Y. Harada and T. Asakura, "Radiation forces on a dielectric sphere in the rayleigh scattering regime," *Opt. Commun.*, vol. 124, no. 5, pp. 529–541, 1996.
- [18] A. Ashkin, "Forces of a single-beam gradient laser trap on a dielectric sphere in the ray optics regime," *Biophys. J.*, vol. 61, no. 2, pp. 569–582, 1992.
- [19] G. Gouesbet, J. A. Lock, and G. Gréhan, "Generalized lorenz–mie theories and description of electromagnetic arbitrary shaped beams: Localized approximations and localized beam models, a review," *J. Quant. Spectrosc. Radiat. Transf.*, vol. 112, no. 1, pp. 1–27, 2011.
- [20] T. A. Nieminen, V. L. Y. Loke, A. B. Stilgoe, G. Knöner, A. M. Brańczyk, N. R. Heckenberg, and H. Rubinsztein-Dunlop, "Optical tweezers computational toolbox," *J. Opt.*, vol. 9, no. 8, pp. S196–S203, 2007.
- [21] I. C. D. Lenton, T. A. Nieminen, V. L. Y. Loke, A. B. Stilgoe, Y. Hu, G. Knöner, A. M. Brańczyk, N. R. Heckenberg, and H. Rubinsztein-Dunlop, "Optical tweezers toolbox," <https://github.com/ilent2/ott>, 2020.
- [22] A. Raudsepp, M. Griffiths, A. J. Sutherland-Smith, and M. A. K. Williams, "Developing a video tracking method to study interactions between close pairs of optically trapped particles in three dimensions," *Appl. Opt.*, vol. 54, no. 32, pp. 9518–9527, 2015.
- [23] N. Malagnino, G. Pesce, A. Sasso, and E. Arimondo, "Measurements of trapping efficiency and stiffness in optical tweezers," *Opt. Commun.*, vol. 214, no. 1, pp. 15–24, 2002.
- [24] C. W. Ha and D.-Y. Yang, "Rotational elastic micro joint based on helix-augmented cross-spring design for large angular movement," *Opt. Express*, vol. 22, no. 17, pp. 20 789–20 797, 2014.
- [25] C.-L. Lin, Y.-H. Li, C.-T. Lin, C.-C. Chiang, Y.-J. Liu, T.-T. Chung, and P. L. Baldeck, "Preliminary study of lever-based optical driven micro-actuator," in *Proc. SPIE*, J. Leng, Y. Bar-Cohen, I. Lee, and J. Lu, Eds., vol. 8409, International Society for Optics and Photonics. SPIE, 2012, pp. 589 – 594.
- [26] Y.-H. Lee, Y.-J. Liu, C. Tsou, M. Bouriau, P. Baldeck, and C.-L. Lin, "Optically driven gear-based mechanical microtransducer for a lab-on-a-chip," *J. Neurosci. Neuroeng.*, vol. 2, pp. 58–60, 2013.
- [27] R. W. Bowman, G. M. Gibson, A. Linnenberger, D. B. Phillips, J. A. Grieve, D. M. Carberry, S. Serati, M. J. Miles, and M. J. Padgett, "red tweezers": Fast, customisable hologram generation for optical tweezers," *Comput. Phys. Commun.*, vol. 185, no. 1, pp. 268–273, 2014.
- [28] E. Avci, M. Grammatikopoulou, and G.-Z. Yang, "Laser-printing and 3d optical control of untethered microrobots," *Adv. Opt. Mater.*, vol. 5, 2017.
- [29] P.-K. Andrew, D. Fan, A. Raudsepp, M. Lofroth, U. Staufer, M. A. K. Williams, and E. Avci, "Design of optical micromachines for use in biologically relevant environments," in *2020 IEEE/ASME International Conference on Advanced Intelligent Mechatronics (AIM)*, 2020, pp. 2039–2045.
- [30] A. Raudsepp, L. M. Kent, S. B. Hall, and M. A. Williams, "Overstretching partially alkyne functionalized dsdna using near infrared optical tweezers," *Biochem. Biophys. Res. Commun.*, vol. 496, no. 3, pp. 975–980, 2018.
- [31] C.-N. Nguyen, K. Ohara, T. Takubo, Y. Mae, and T. Arai, "High-speed autofocusing of multisized microobjects," in *2012 IEEE International Conference on Automation Science and Engineering (CASE)*, 2012, pp. 34–39.
- [32] M. Schmid, D. Ludescher, and H. Giessen, "Optical properties of photoresists for femtosecond 3d printing: refractive index, extinction, luminescence-dose dependence, aging, heat treatment and comparison between 1-photon and 2-photon exposure," *Opt. Mater. Express*, vol. 9, no. 12, pp. 4564–4577, 2019.