

Assessment of the ASTEC Model of a Generic BWR-4 Mark-1 Peach Bottom Unit-2 NPP and Analysis of the ST-SBO Severe Accident Scenario

Onur Murat*, Dr. Fabrizio Gabrielli*, Dr. Victor Hugo Sanchez Espinoza*, Dr. Robert Stieglitz*

**Karlsruhe Institute of Technology, Institute for Neutron Physics and Reactor Technology, Hermann-von-Helmholtz Platz 1, D-76344 Eggenstein-Leopoldshafen*

Institute for Neutron Physics and Reactor Technology



Content

- ASTEC Model of the Peach Bottom Unit-2 NPP
 - CESAR Volumes and Connections
 - Containment Zones and Connections
 - Transient Scenario: ST-SBO
- ASTEC Results
- JRODOS Model
 - Source Term of PB-2 ASTEC Model
 - Selected Region of Interest
 - Statistical Analysis for Worst Case Scenario
- JRODOS Results

Cesar Volumes and Connections ASTEC PB2 Model

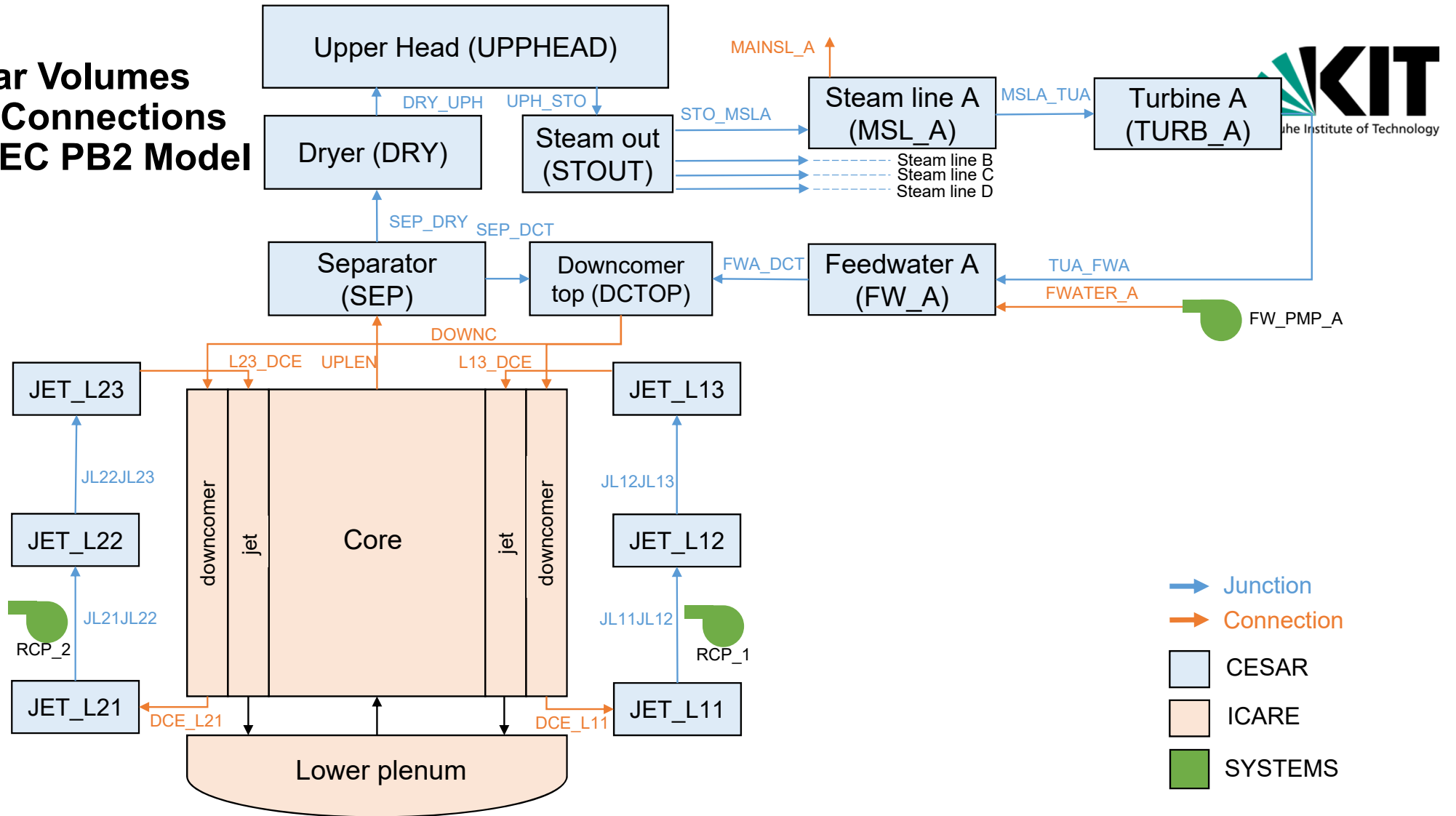

CPA Zones and Connections ASTEC PB2 Model

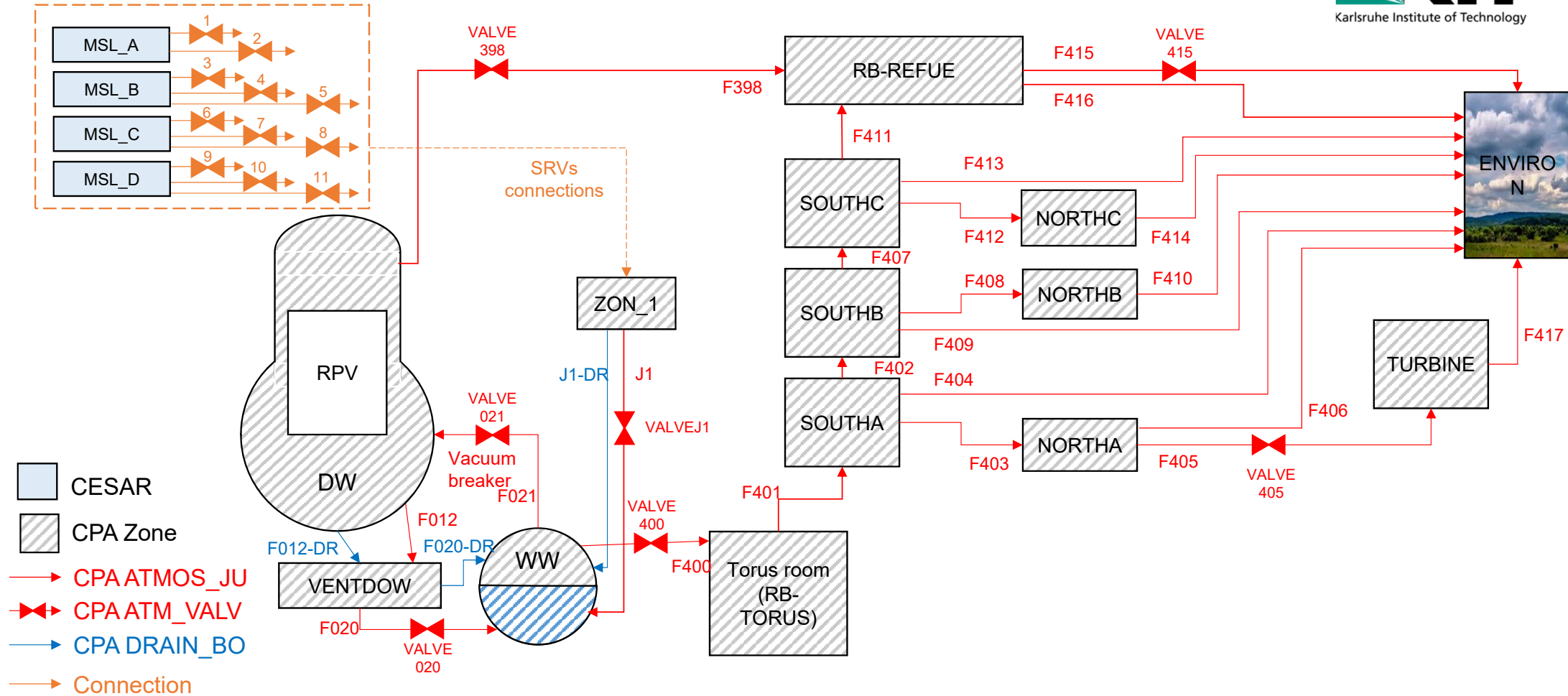

Transient Scenario: ST-SBO

- Loss of offsite power initiation.
- Automatic SRV-1 operation for 200 seconds.
- At 200 seconds closing of SRV-1 and manual operation of one of the SRVs between 6.49 MPa and 7.18 MPa up to 3983 seconds.
- At 3983 seconds point, ADS system activation.
- Battery depletion leads to unavailable reactor safety systems.

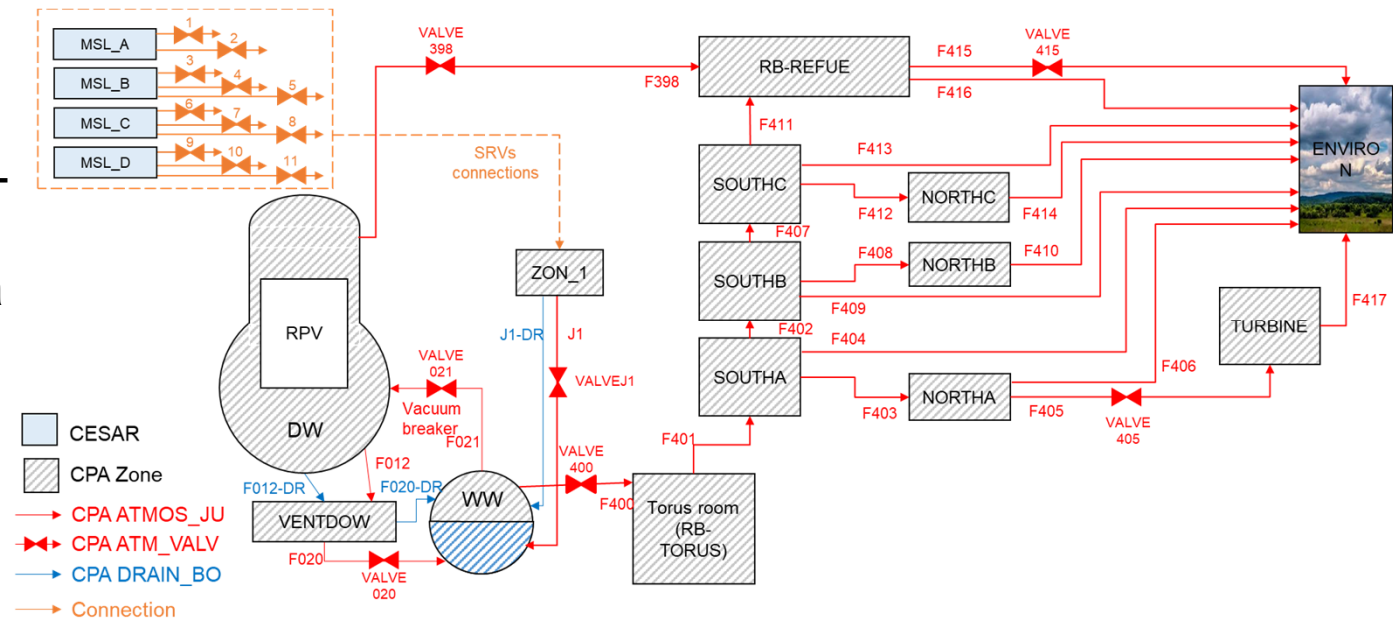

IRSN-KIT Collaboration



ASTEC V2.2 Rev6330 Developer Version

Containment Failure Modes ASTEC PB2 Model

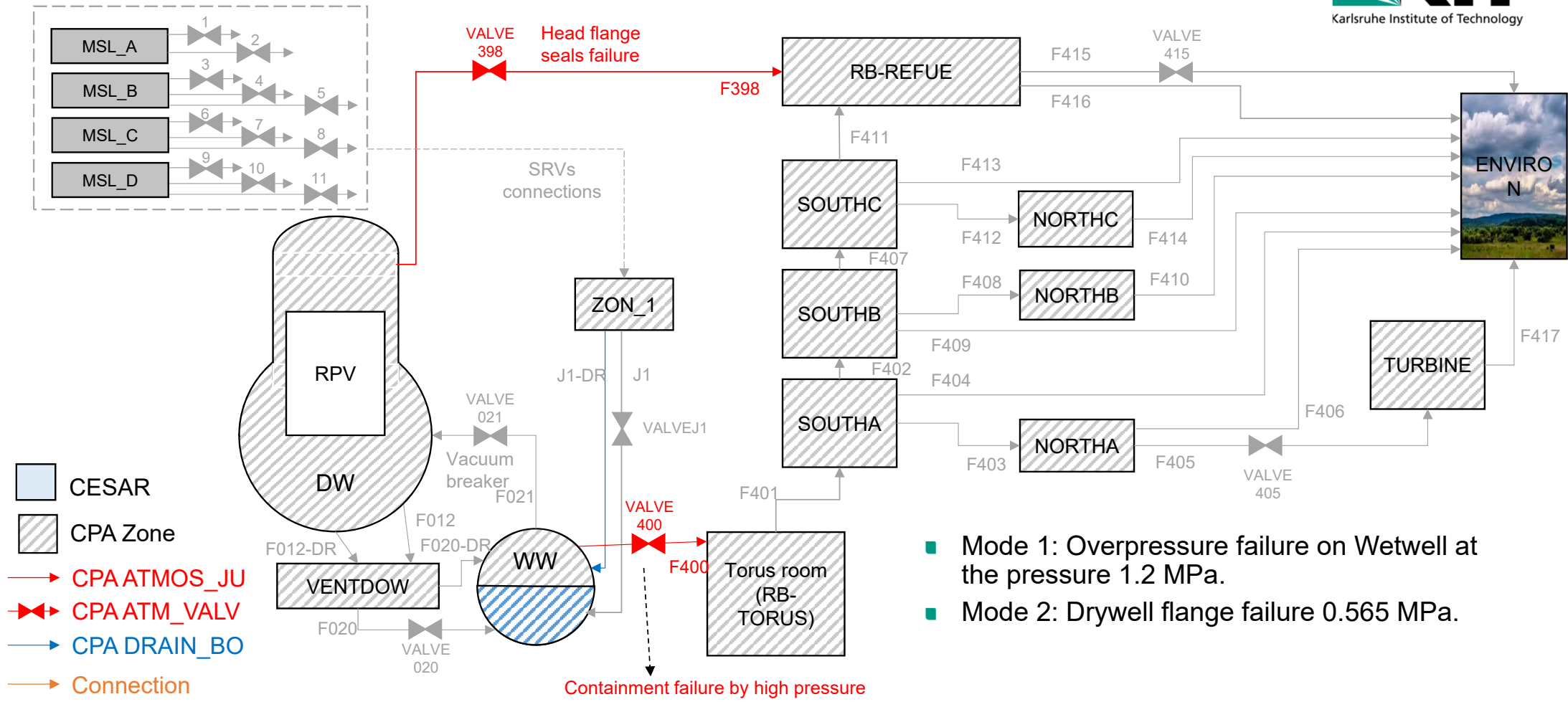

Peach Bottom Unit-2 ASTEC Model ST-SBO Results

Sequence of Events PB2 ASTEC Model ST-SBO Scenario

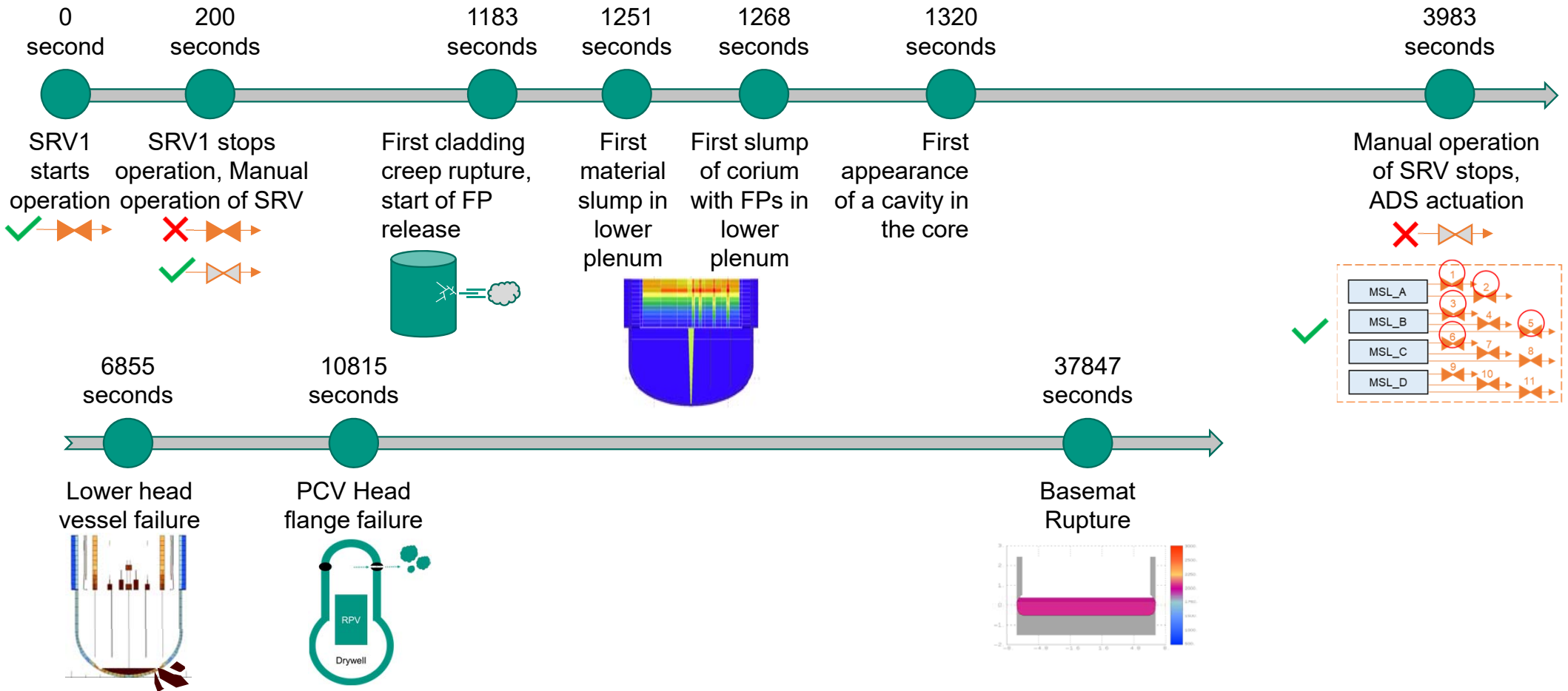

ST-SBO: Steam Release through SRVs 1/3

Extracted Steam Flowrate from SRV1

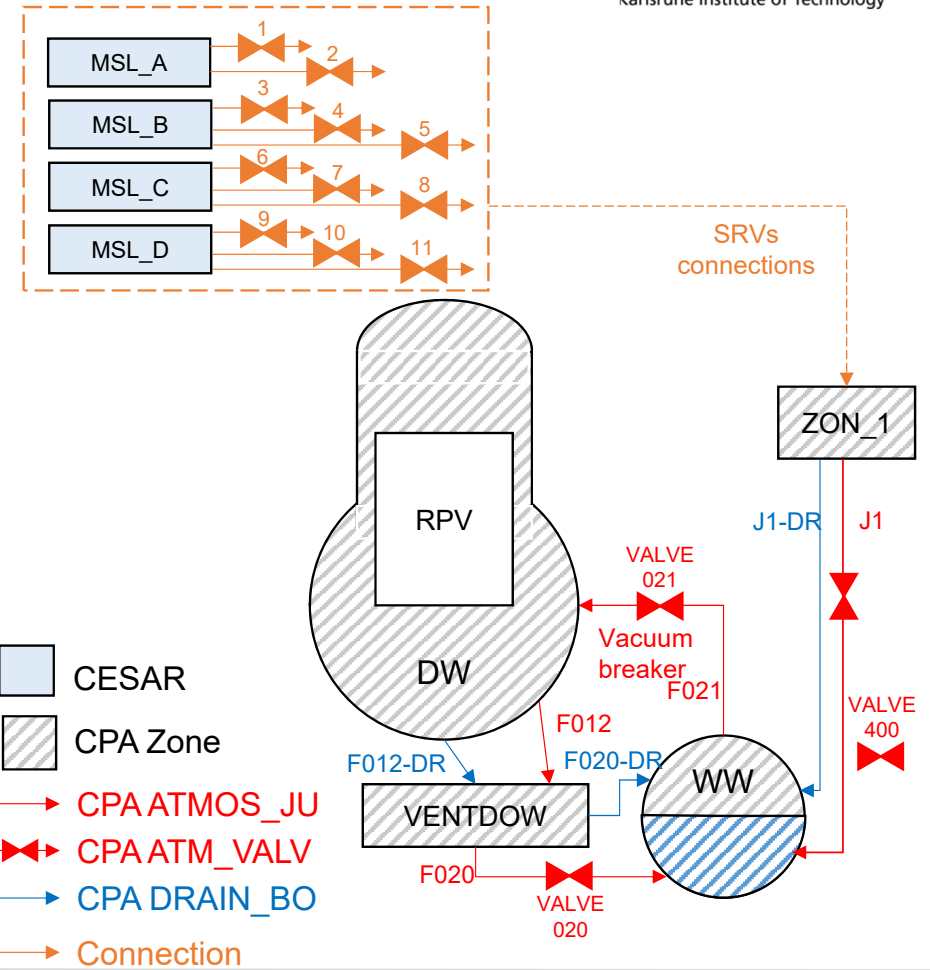
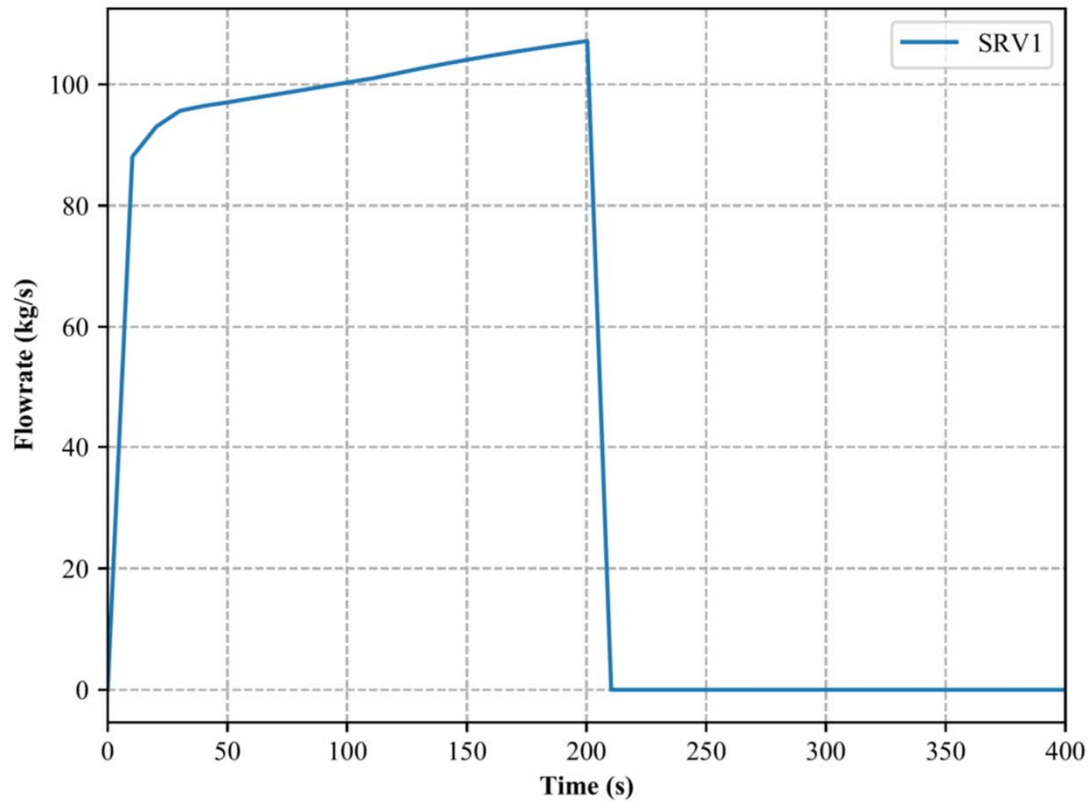

ST-SBO: Steam Release through SRVs 2/3

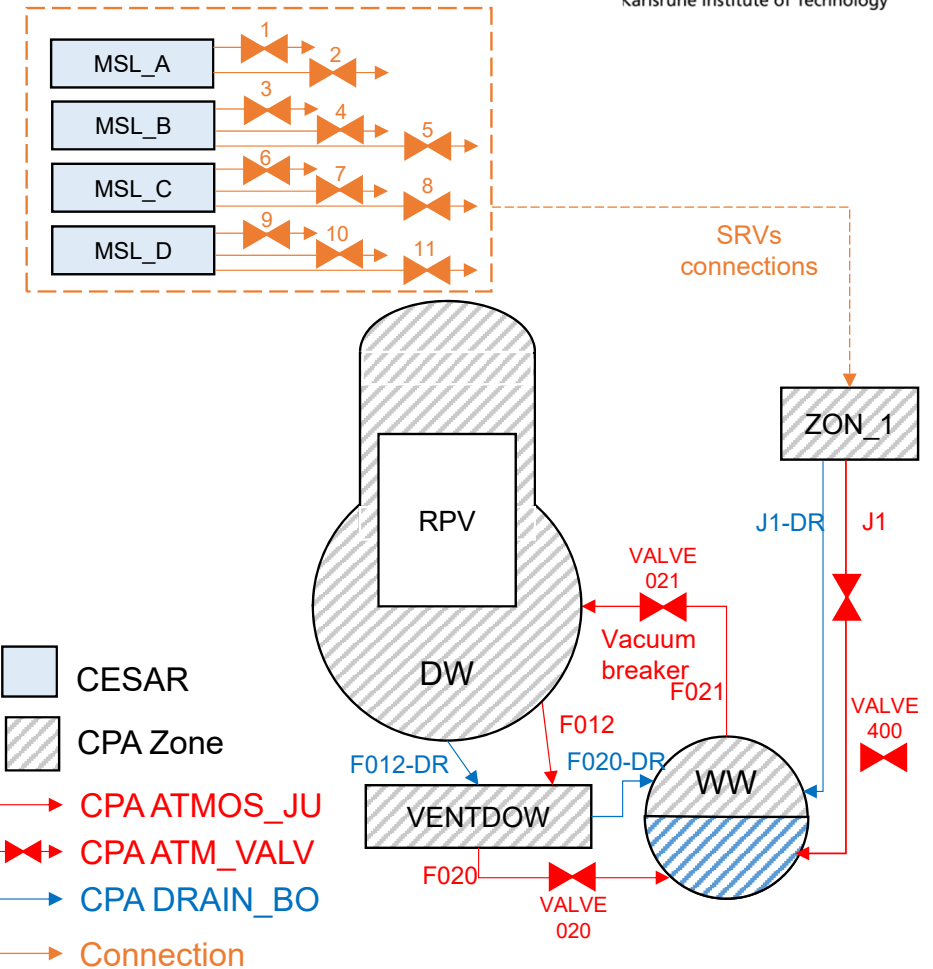
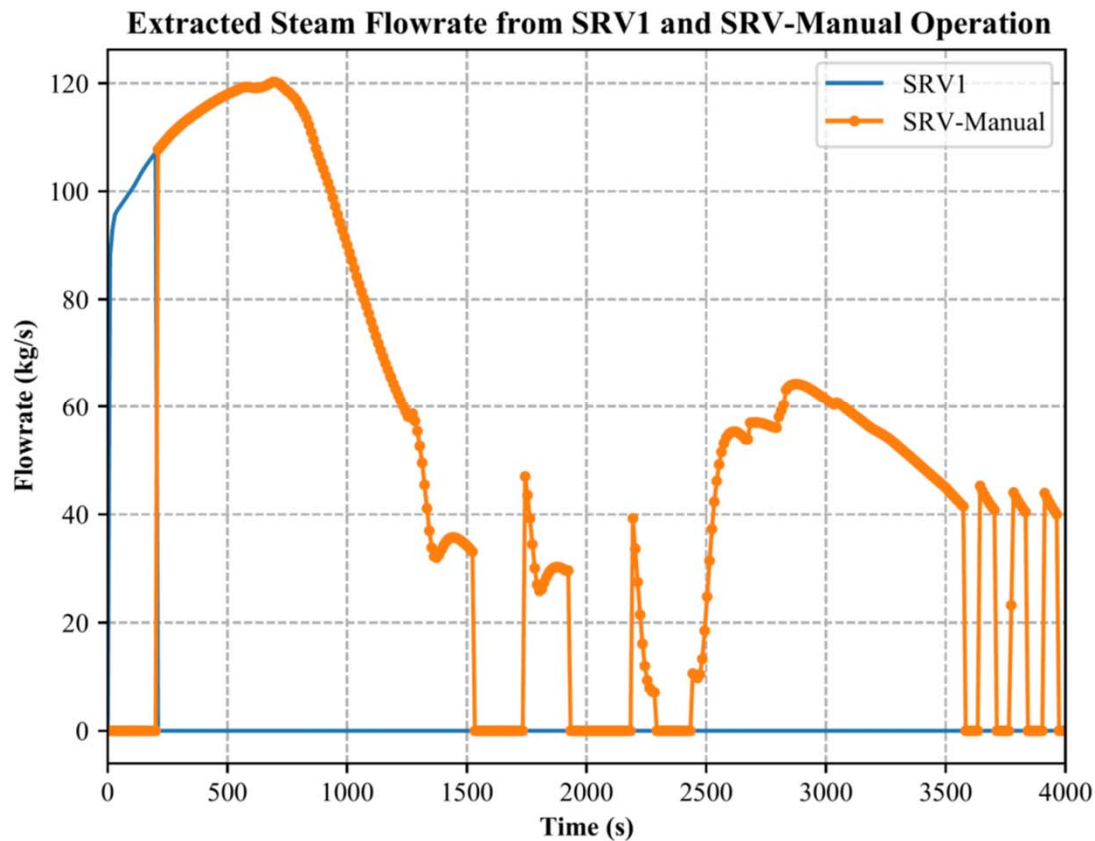

ST-SBO: Steam Release through SRVs 3/3

Extracted Steam Flowrate from SRVs

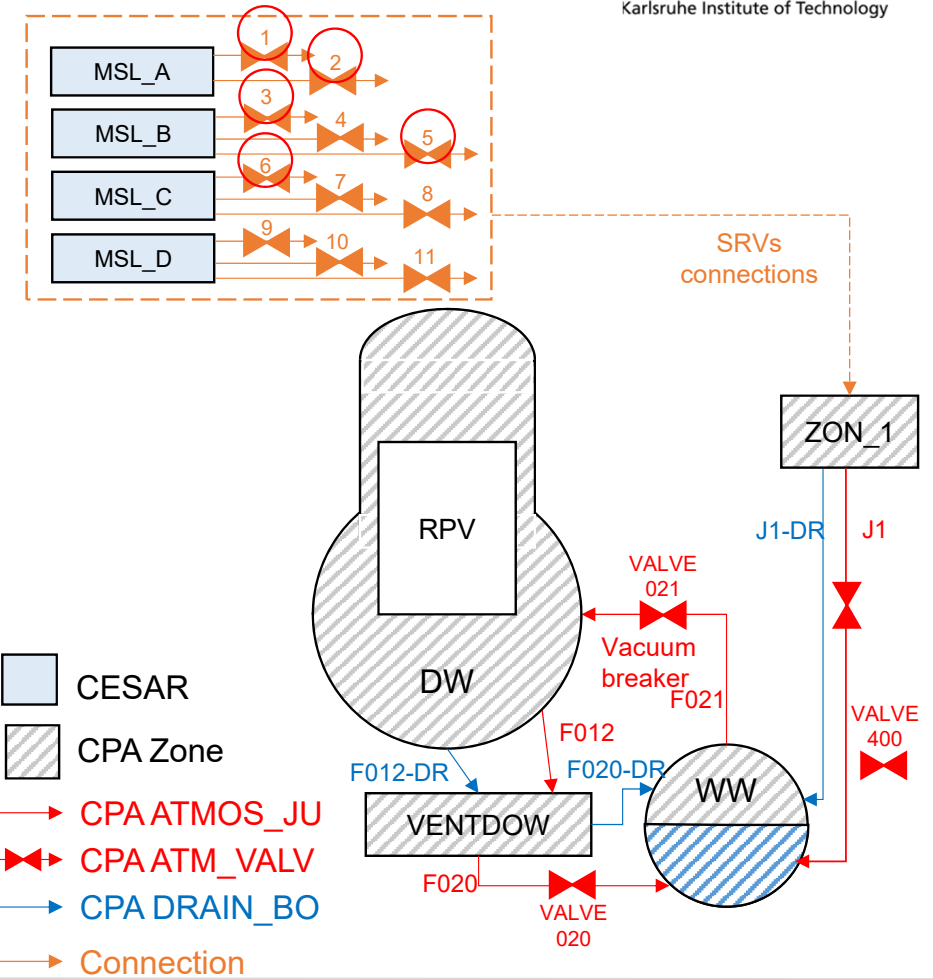
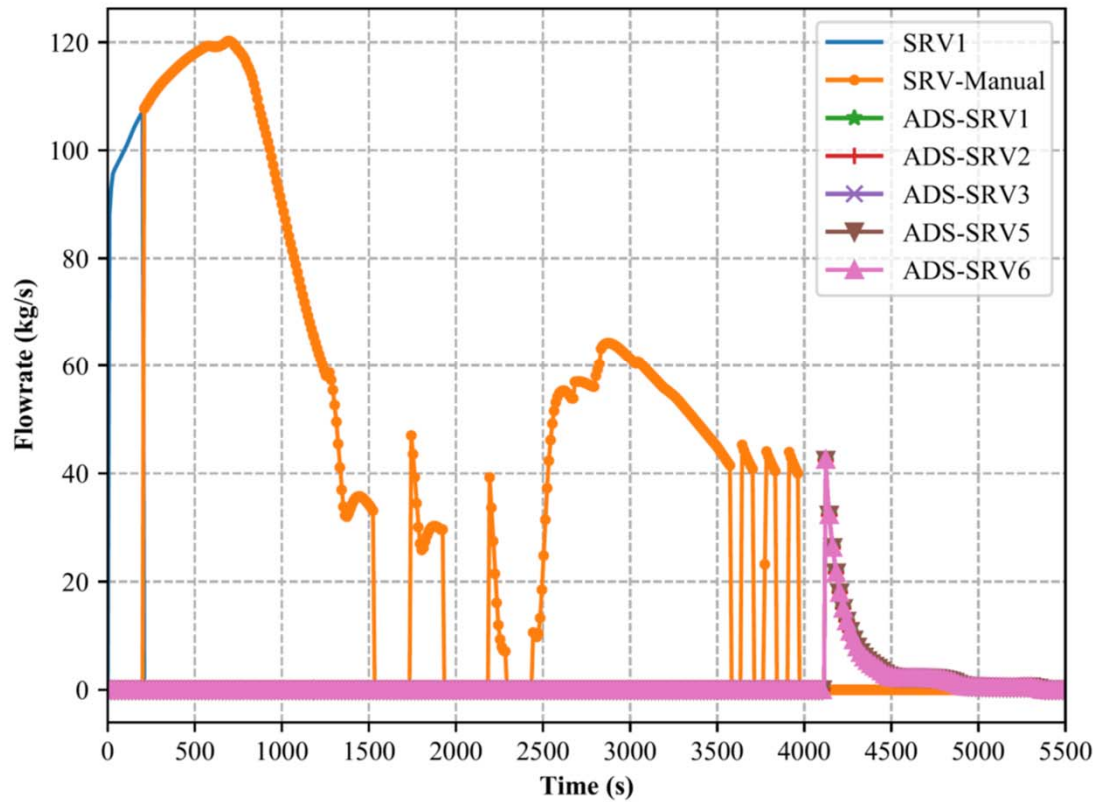

ST-SBO: Hydrogen Production in the Core 1/3

Generated Hydrogen Caused by Oxidation

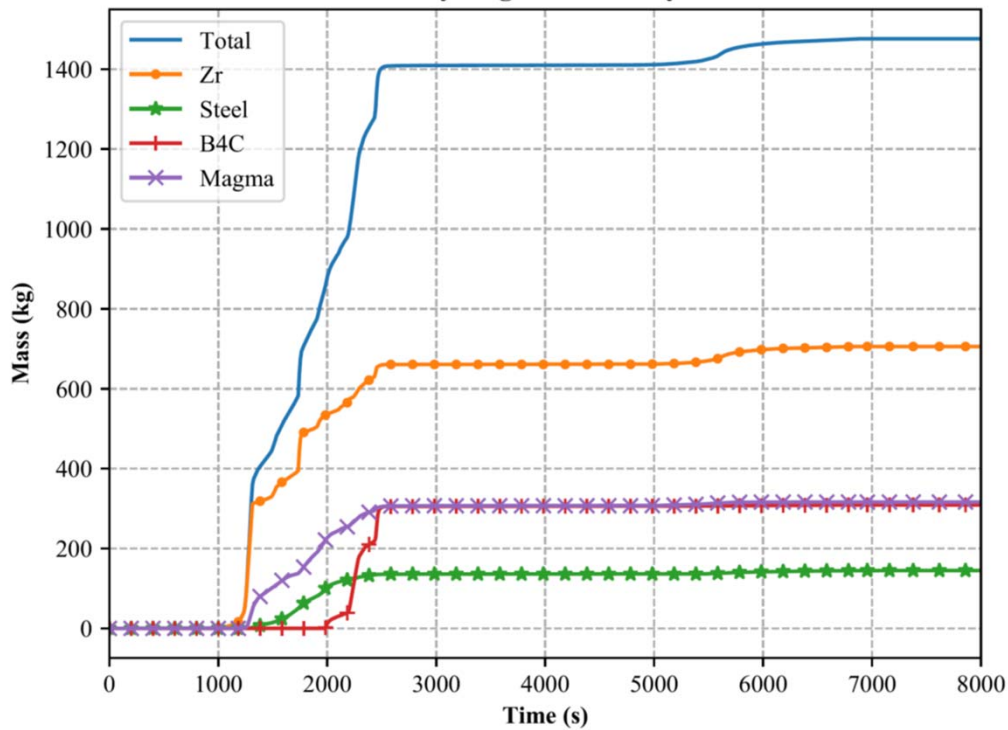

Extracted Steam Flowrate from SRVs

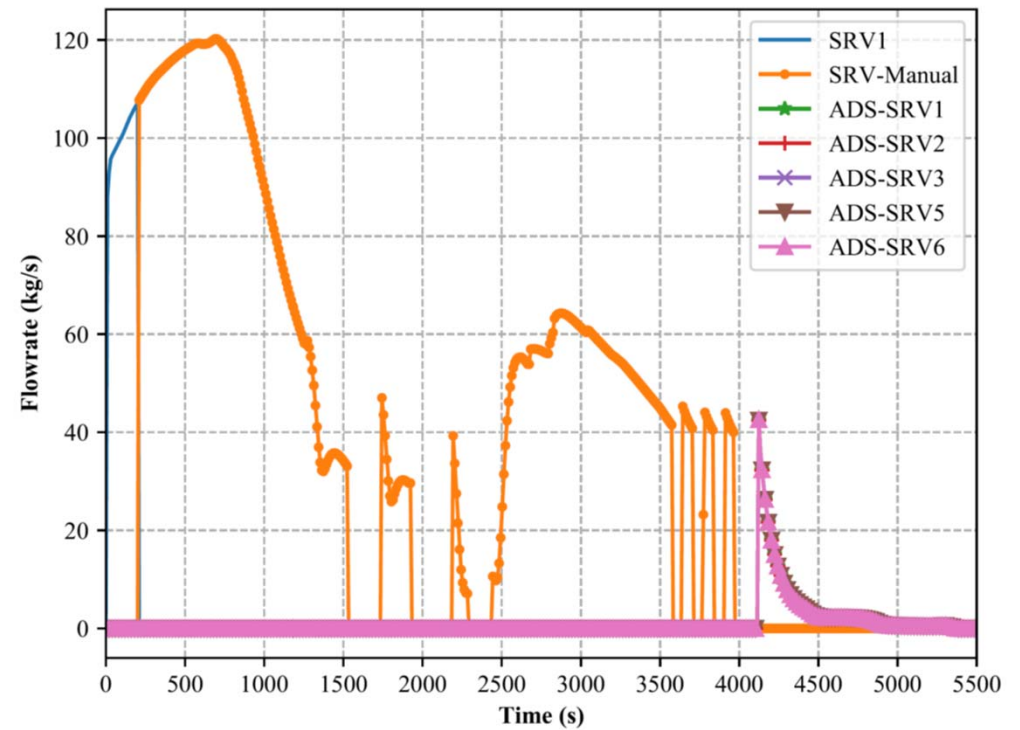

ST-SBO: Hydrogen Production in the Core 2/3

Generated Hydrogen Caused by Oxidation

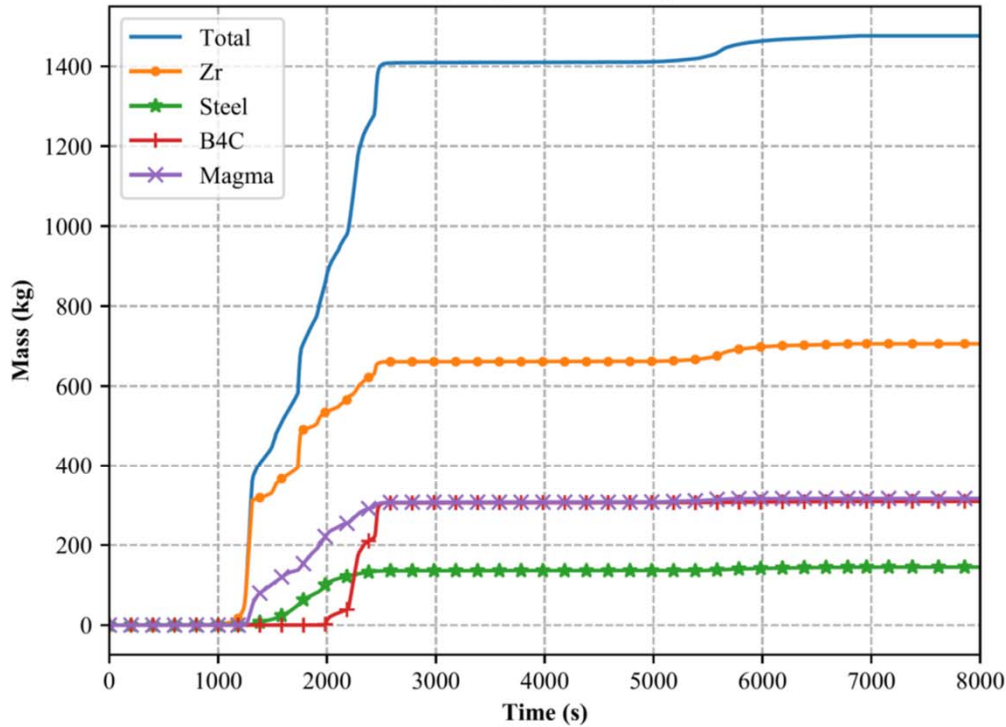

Generated Hydrogen Caused by Oxidation

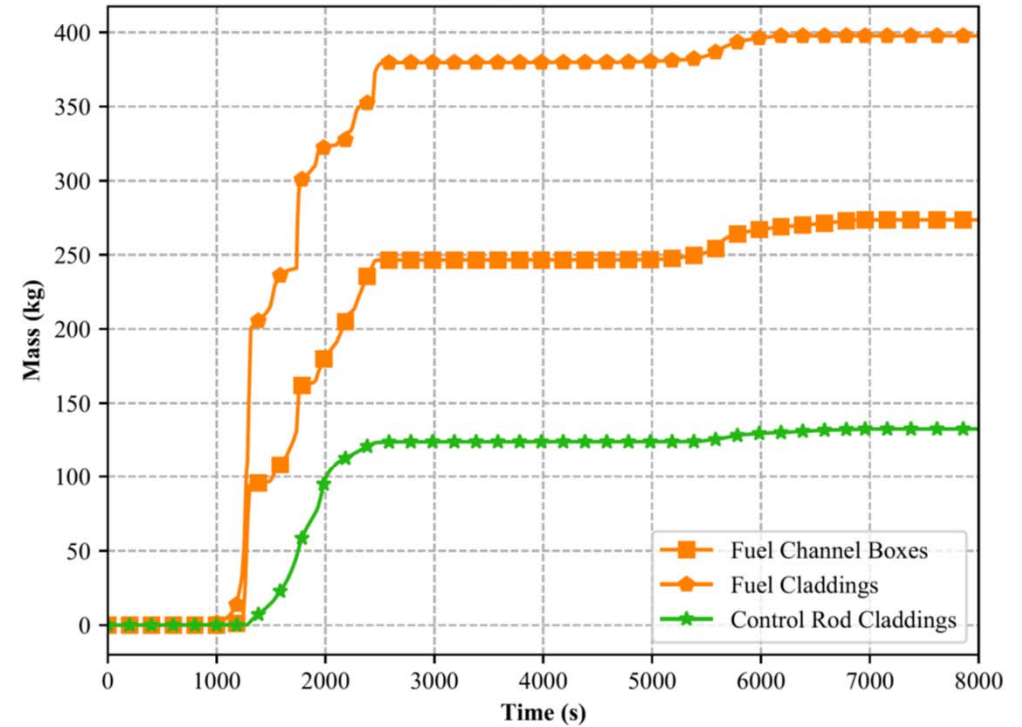

ST-SBO: Hydrogen Production in the Core 3/3

	Fuel Cladding (Zr)	Fuel Channel Box (Zr)	Absorber Cladding (Fe)	Absorber (B4C)	Hydrogen Generation
French 900 MWe PWR	~20 tons	-	~300 kg	-	~900 kg
Peach Bottom Unit-2 BWR4 ASTEC Model	34.17 tons	22.64 tons	1265 kg	1424 kg	1359 kg

Generated Hydrogen Caused by Oxidation

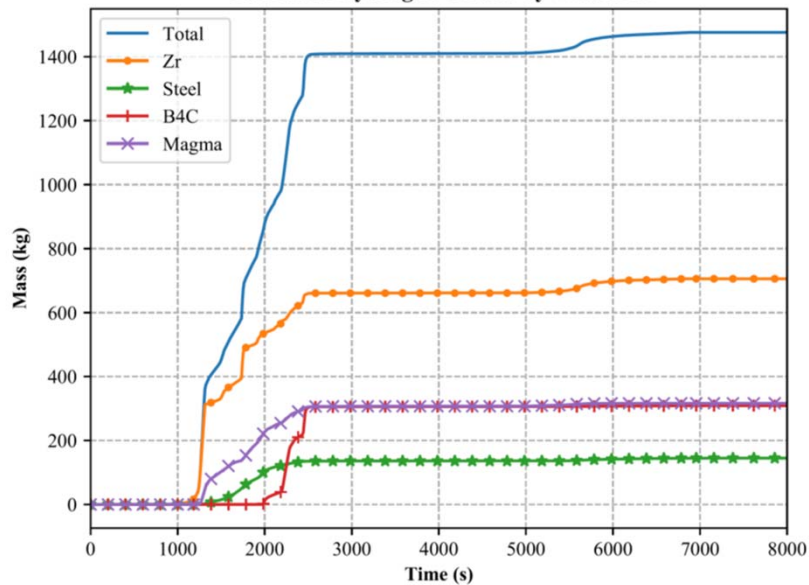

Generated Hydrogen Caused by Oxidation

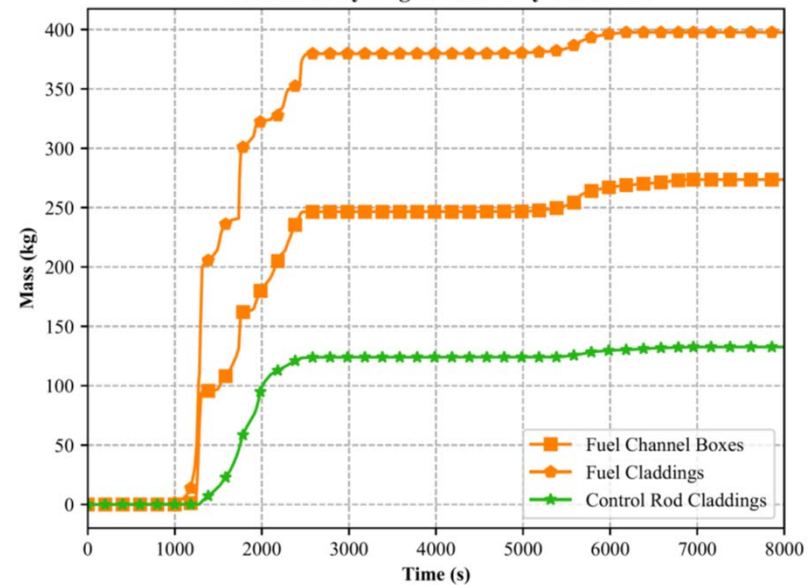

ST-SBO: Water Level

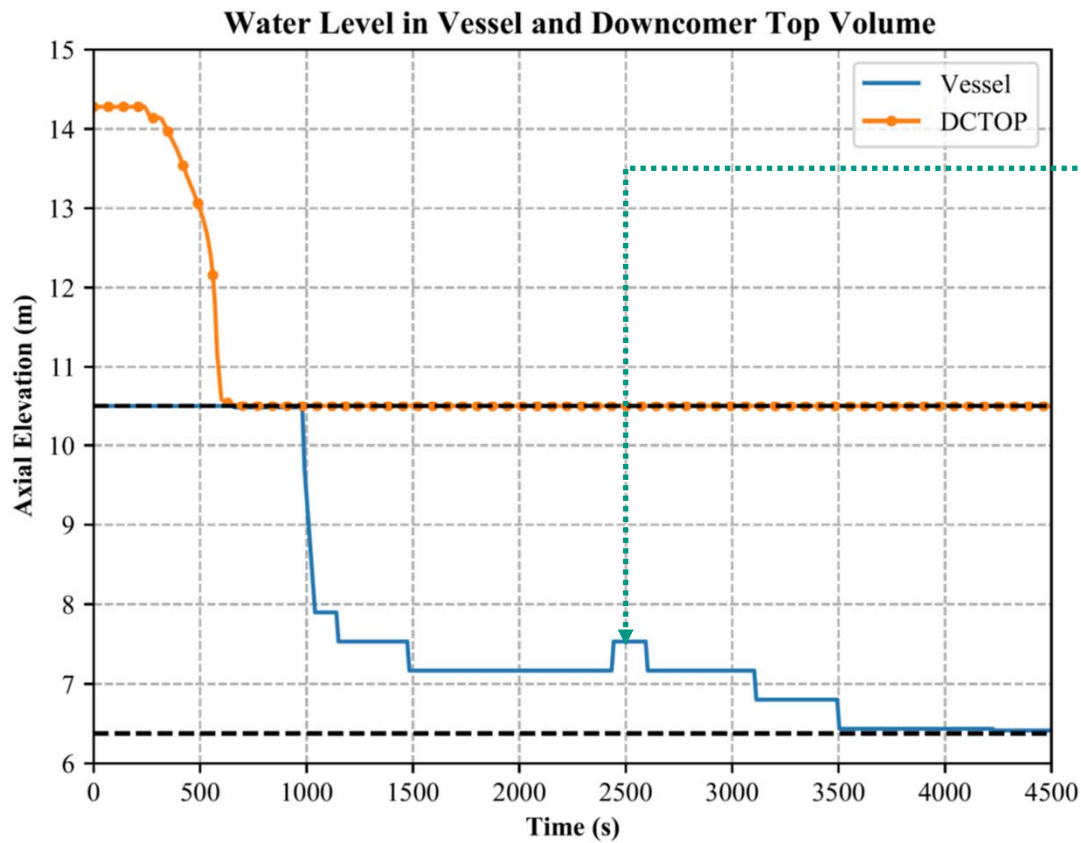

Manual SRV operation

- Pressure Decrease
- Liquid to steam flashing

Downcomer top (DCTOP)

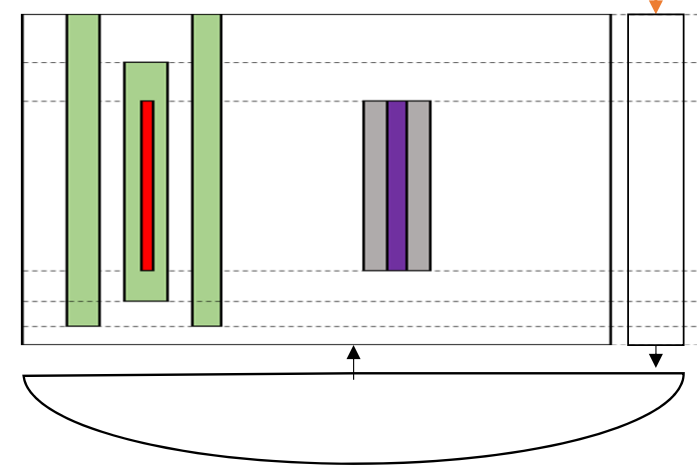

ST-SBO: Corium Mass in Lower Plenum 1/2

Corium Mass in Lower Plenum

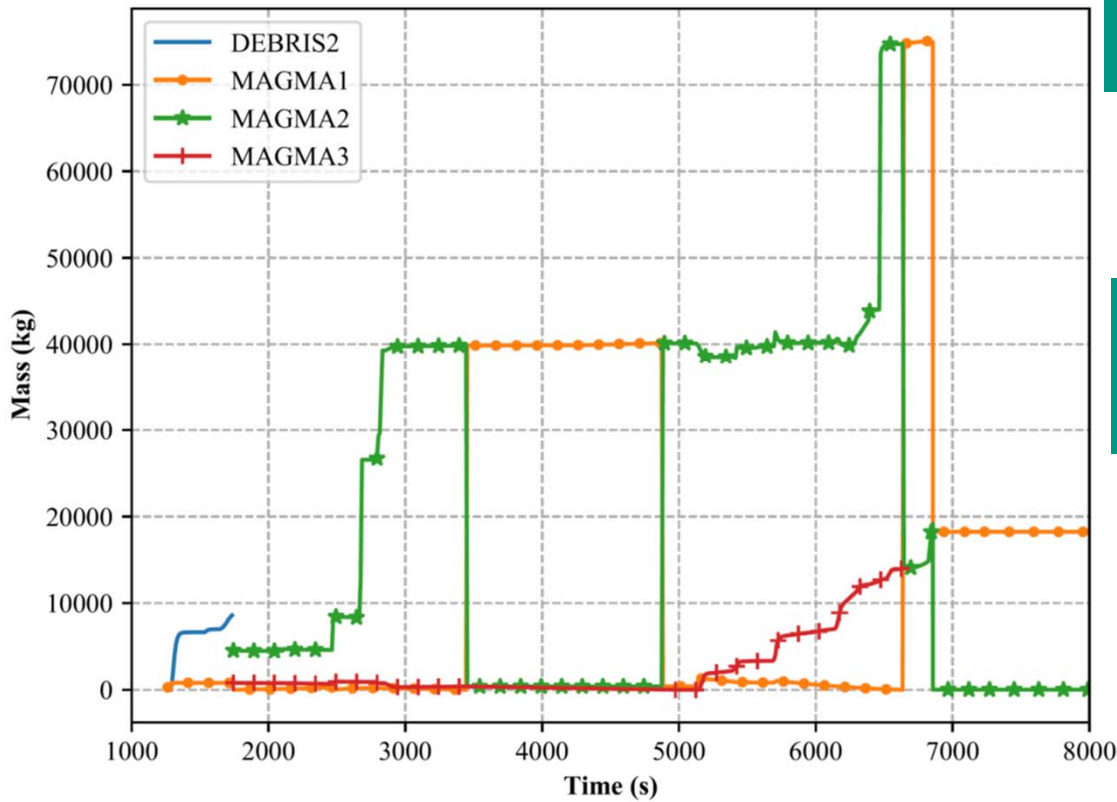

ASTEC Typical Debris Configuration in Lower Plenum

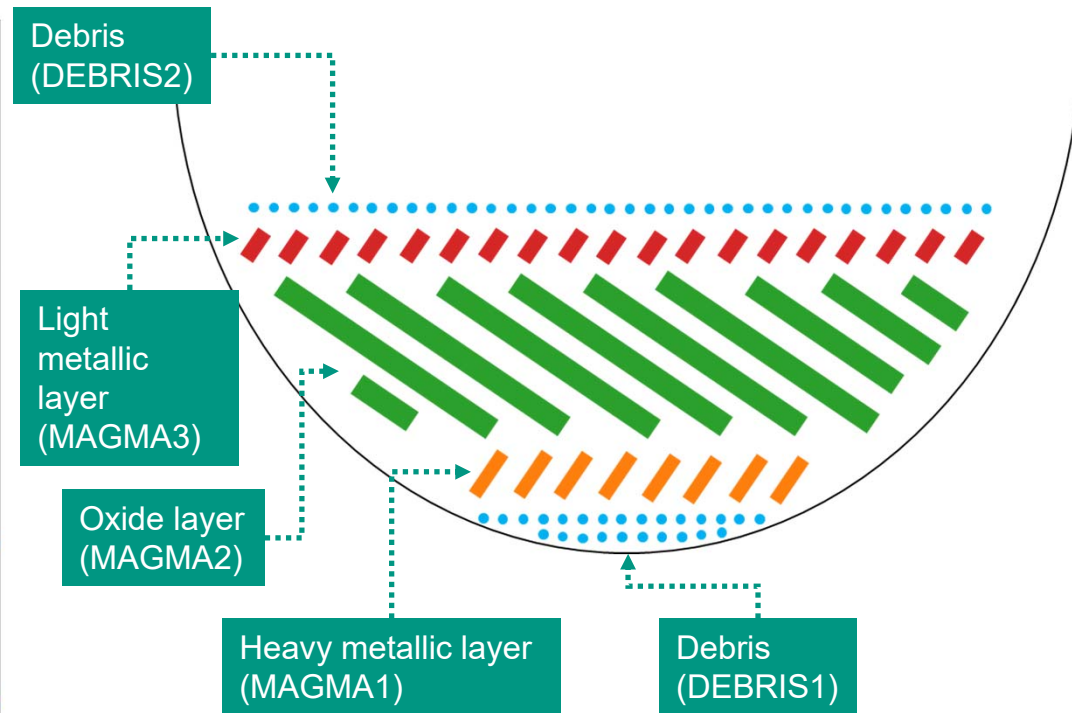

ST-SBO: Corium Mass in Lower Plenum 2/2

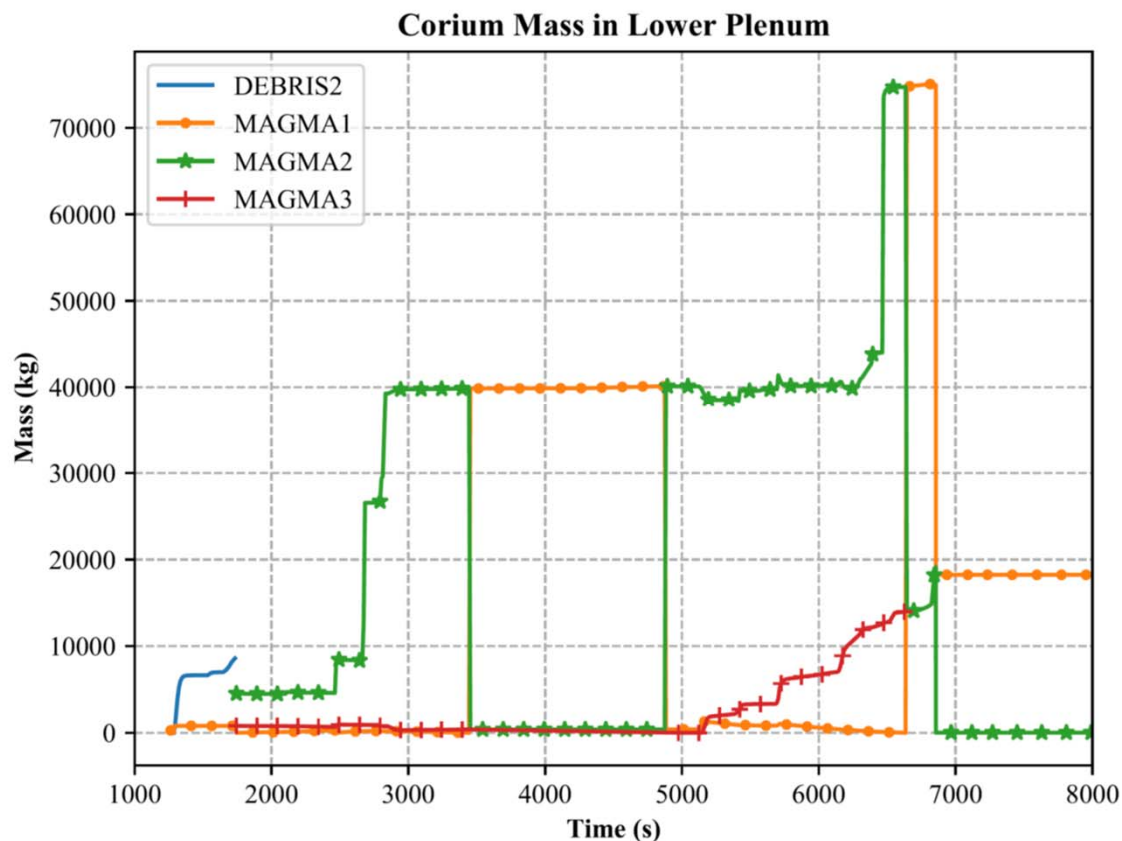

- **0 second** : SRV1 starts operation
- **200 seconds** : SRV1 stops operation, Manual operation of SRV
- **1183 seconds** : First cladding creep rupture, start of FP release
- **1251 seconds** : First material slump in lower plenum
- **1268 seconds** : First slump of corium with FPs in lower plenum
- **1320 seconds** : First appearance of a cavity in the core
- **3983 seconds** : Manual operation of SRV stops, ADS actuation
- **6855 seconds** : **Lower head vessel failure**
- **10815 seconds** : PCV Head flange failure
- **37847 seconds** : Basemat Rupture

ST-SBO: Degradation Level and Temperature Levels after Lower Vessel Head Failure

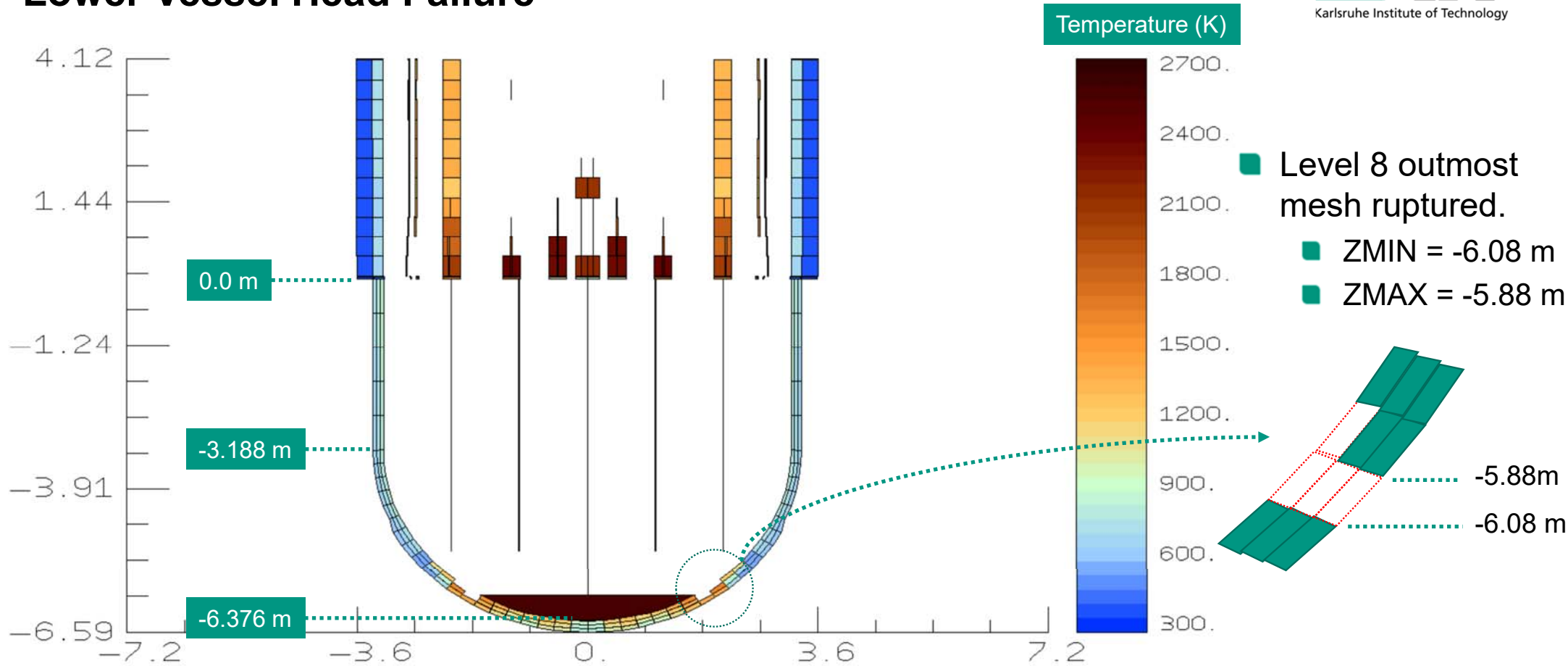

ST-SBO: Corium Layer Accumulation and Positional Changes in Lower Plenum

Position Evaluations of the ASTEC Magma Structures in Lower Plenum

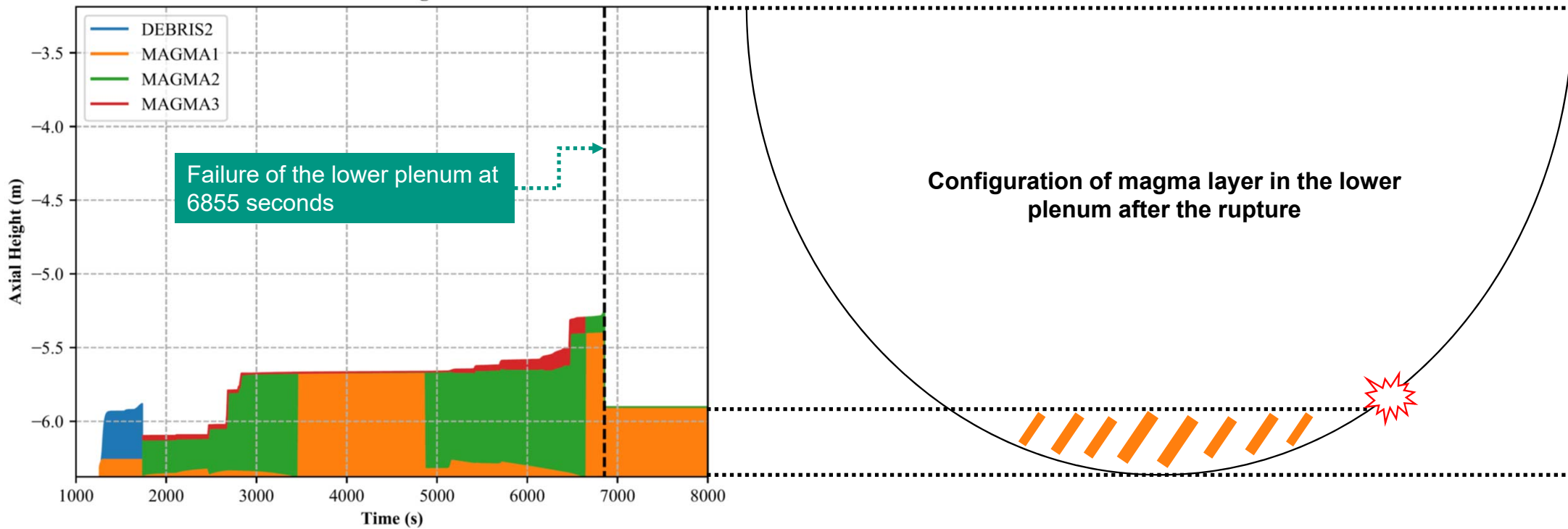

ST-SBO: Corium Layers Material Compositions 1/4

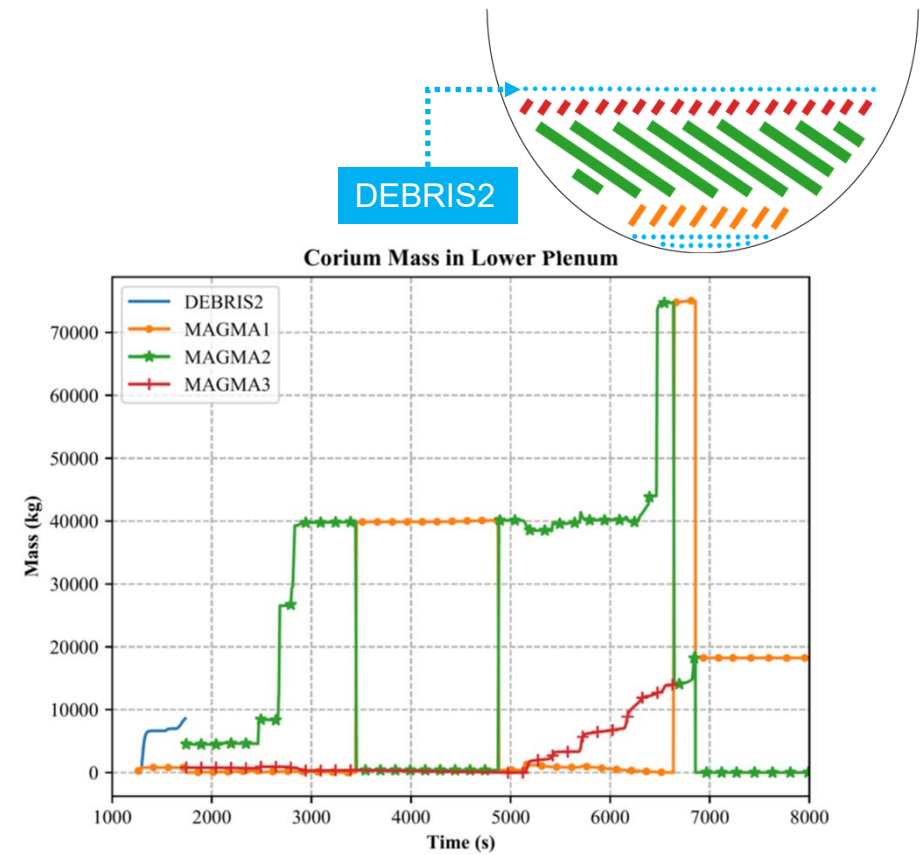
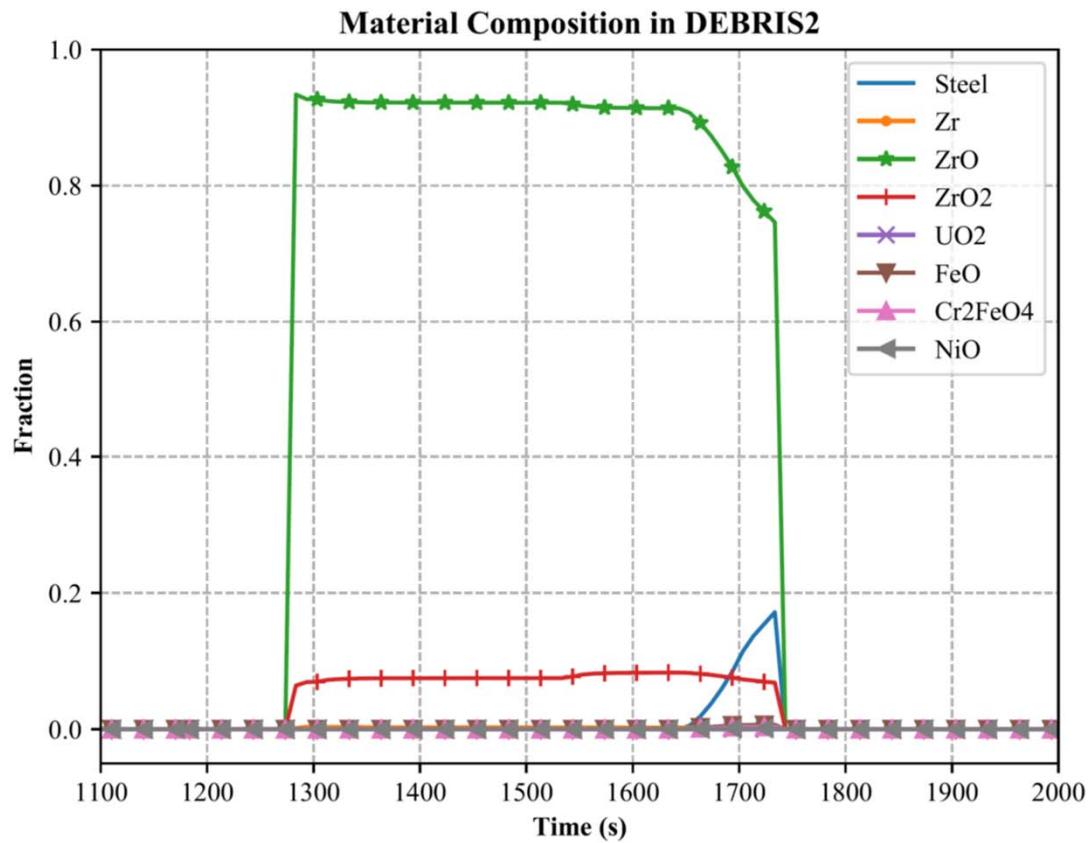

ST-SBO: Corium Layers Material Compositions 4/4

Material Composition in MAGMA3

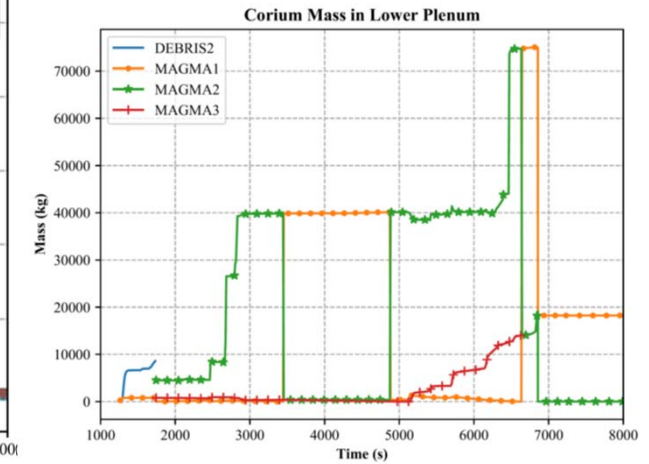
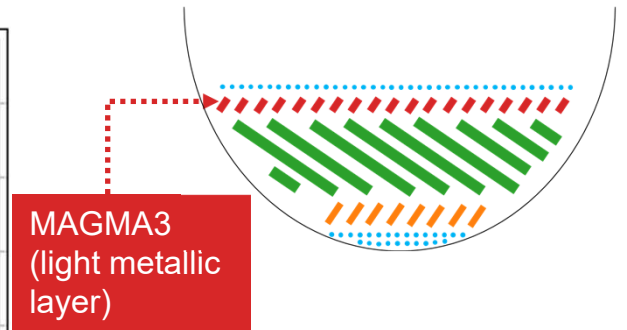
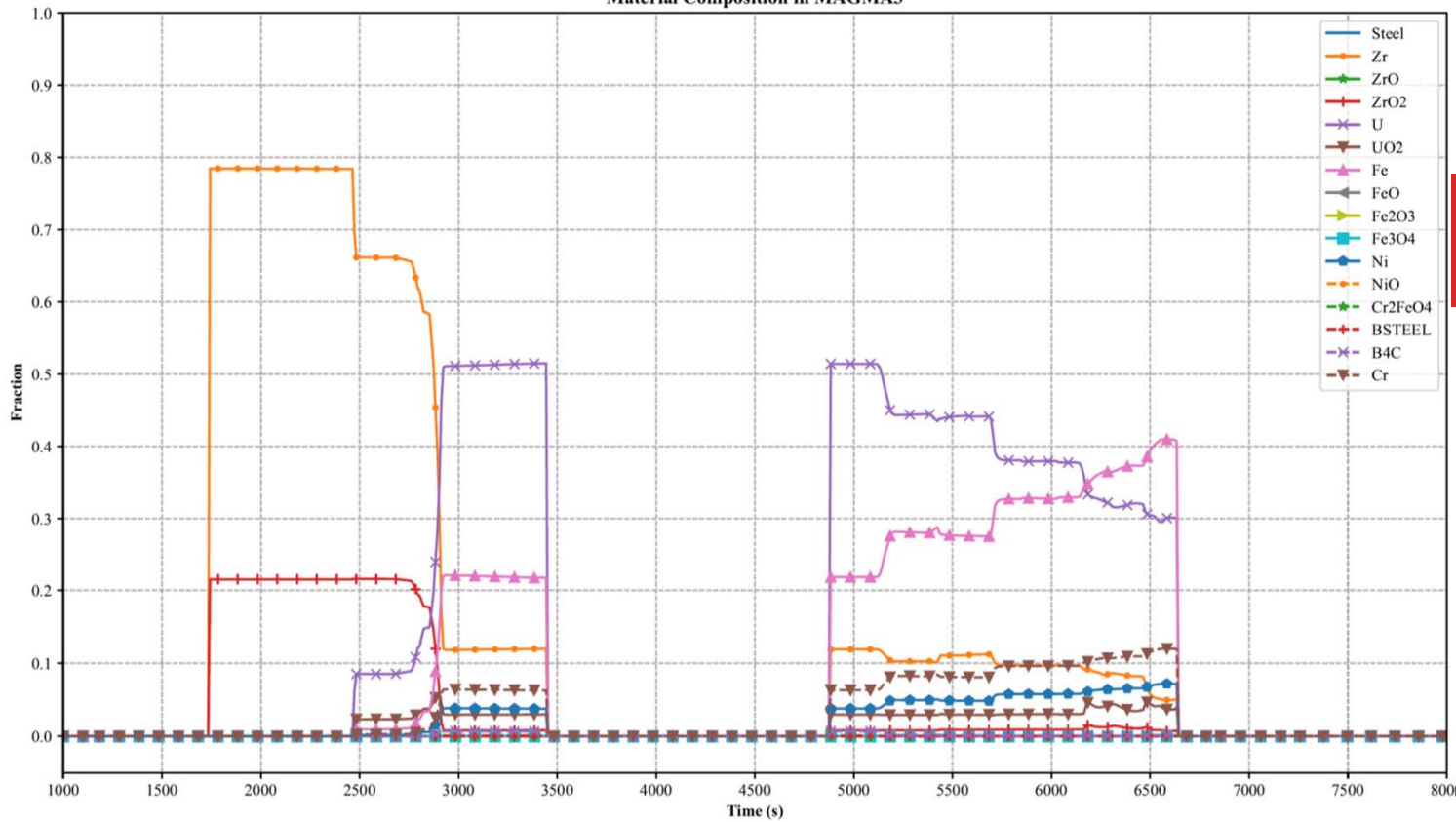

ST-SBO: Corium Layers Material Compositions 3/4

Material Composition in MAGMA2

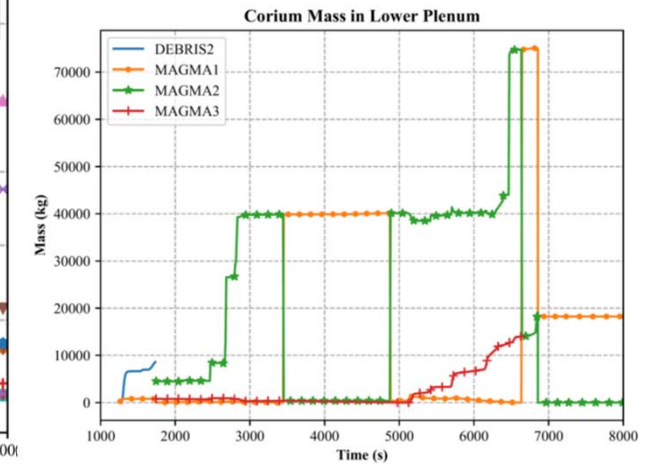
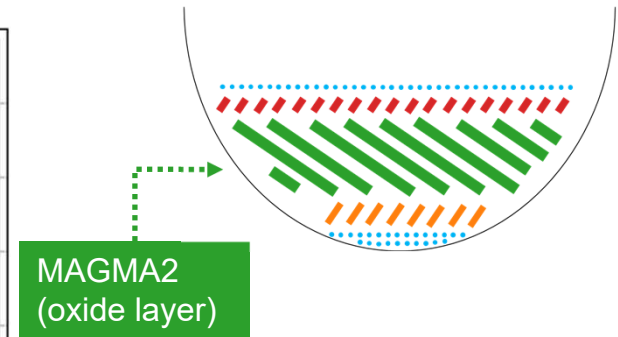
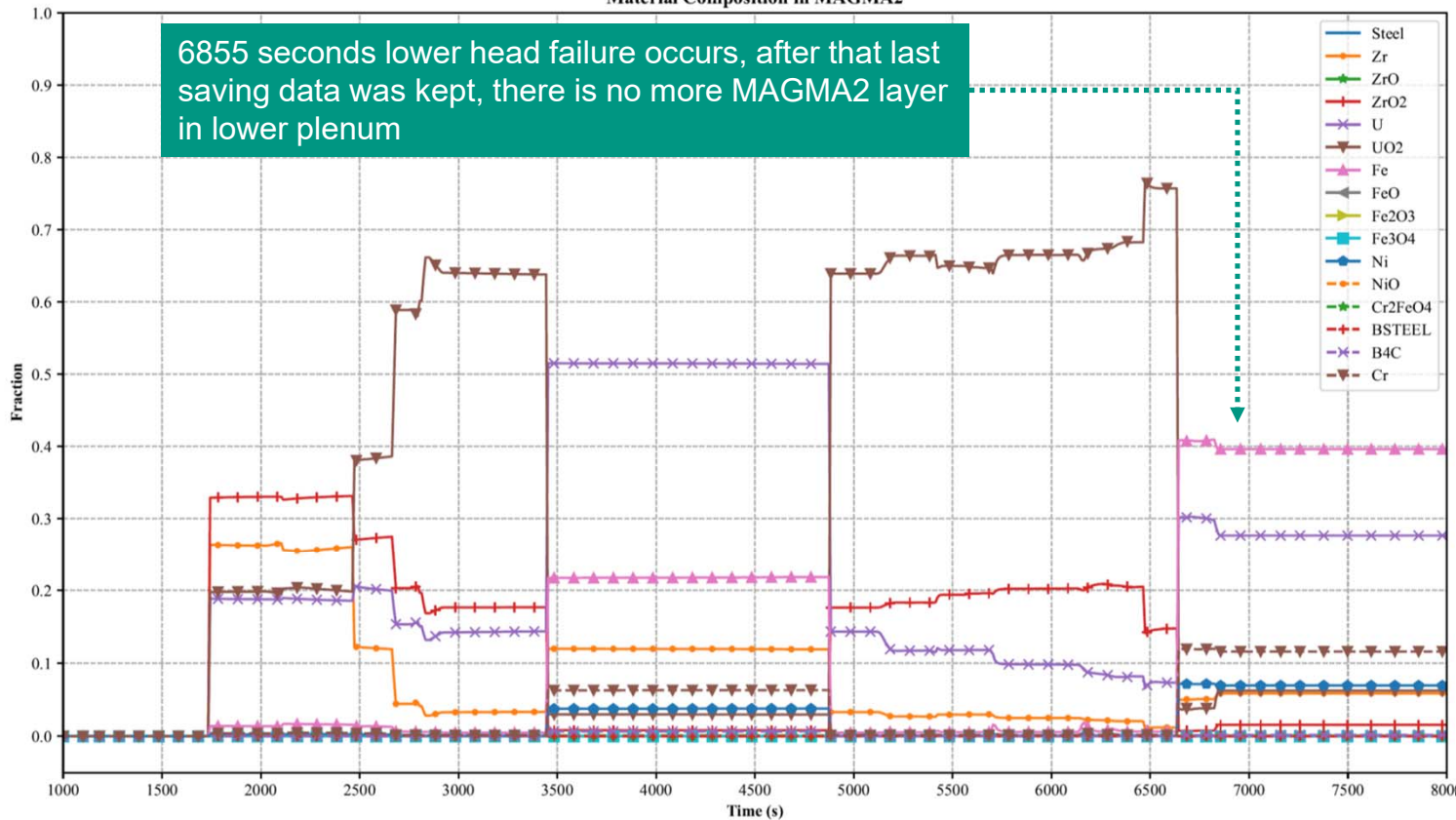

ST-SBO: Corium Layers Material Compositions 2/4

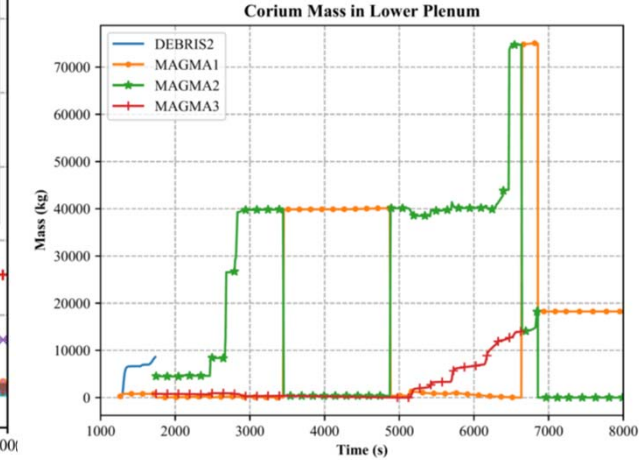
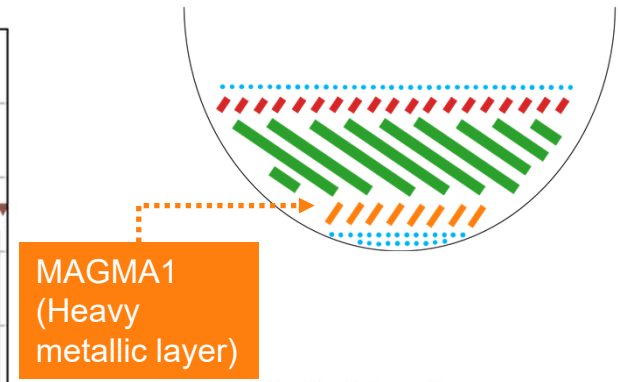
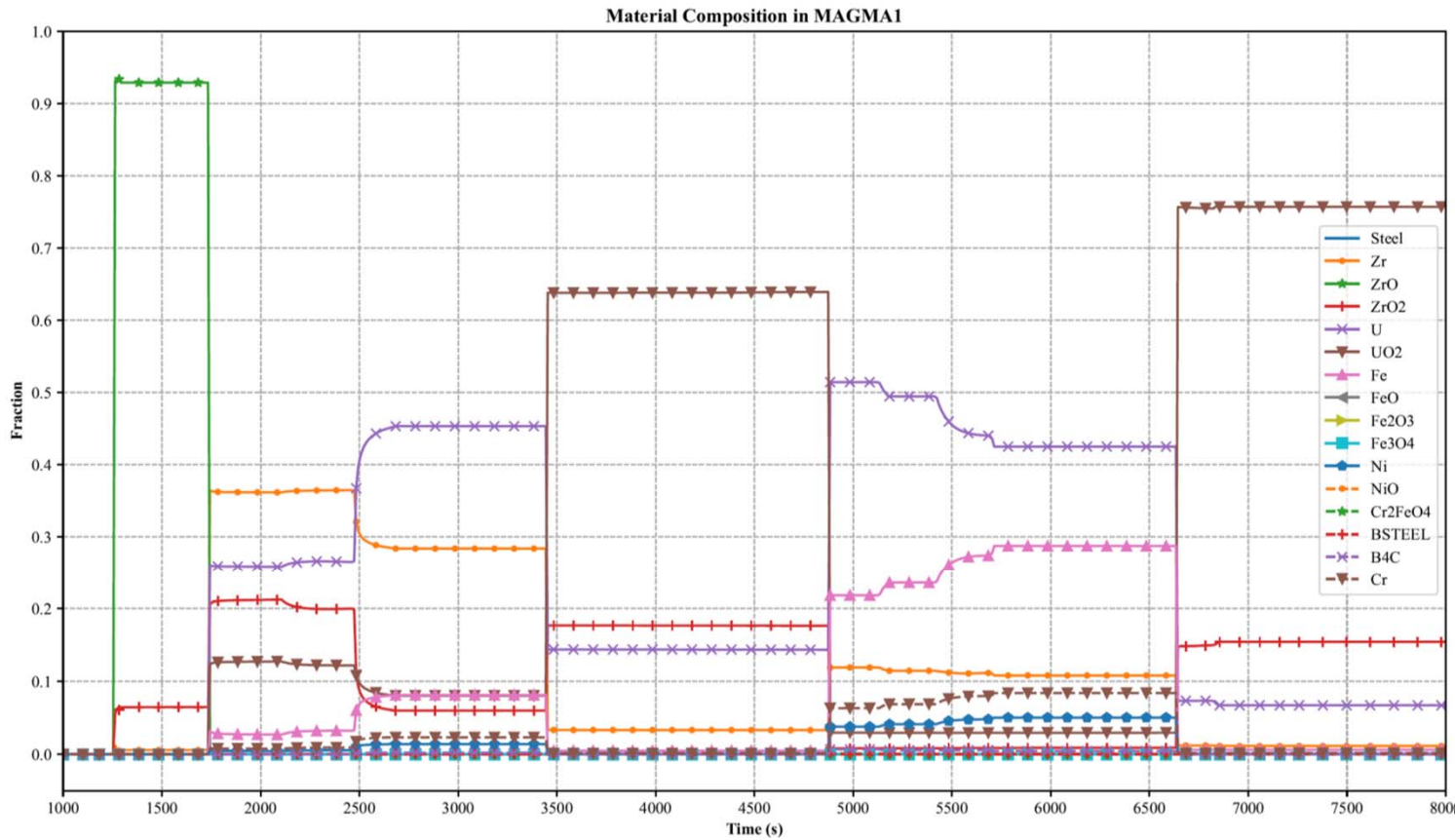

ST-SBO: Pressure in Containment Zones 2/2

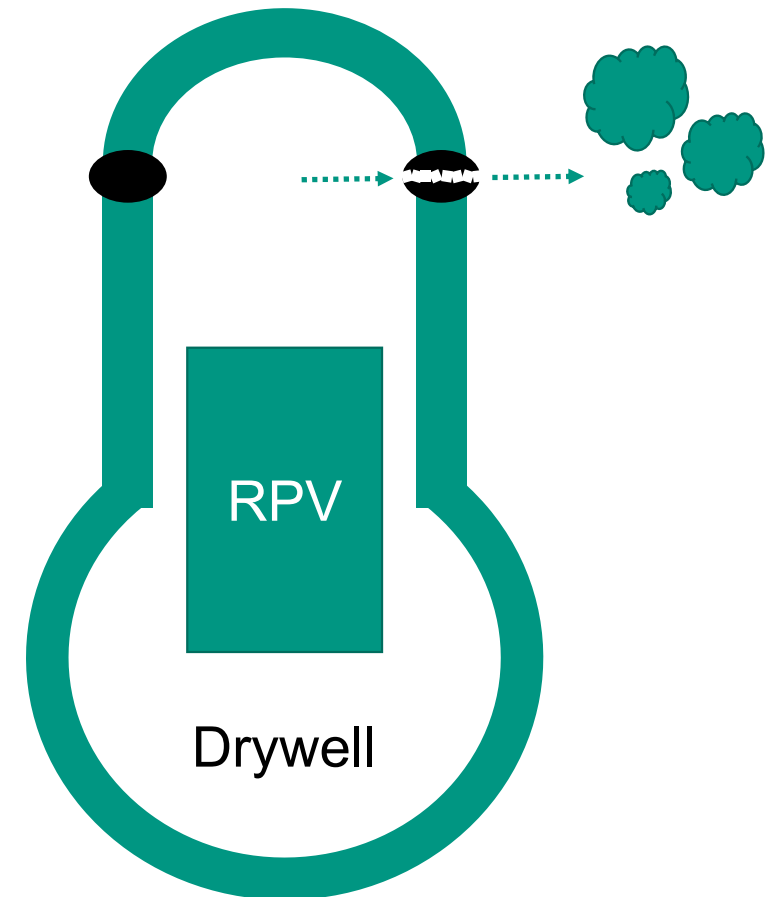
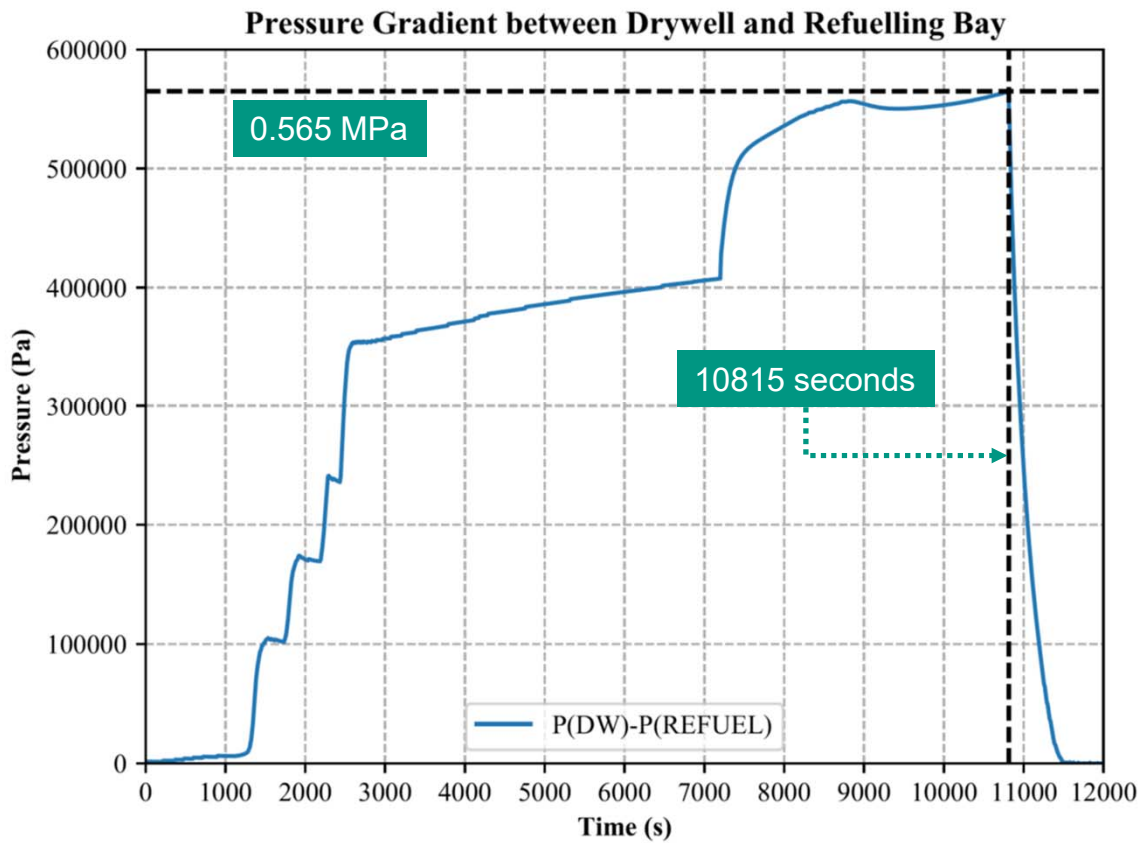

ST-SBO: Pressure in Containment Zones 1/2

Containment Zone Pressures

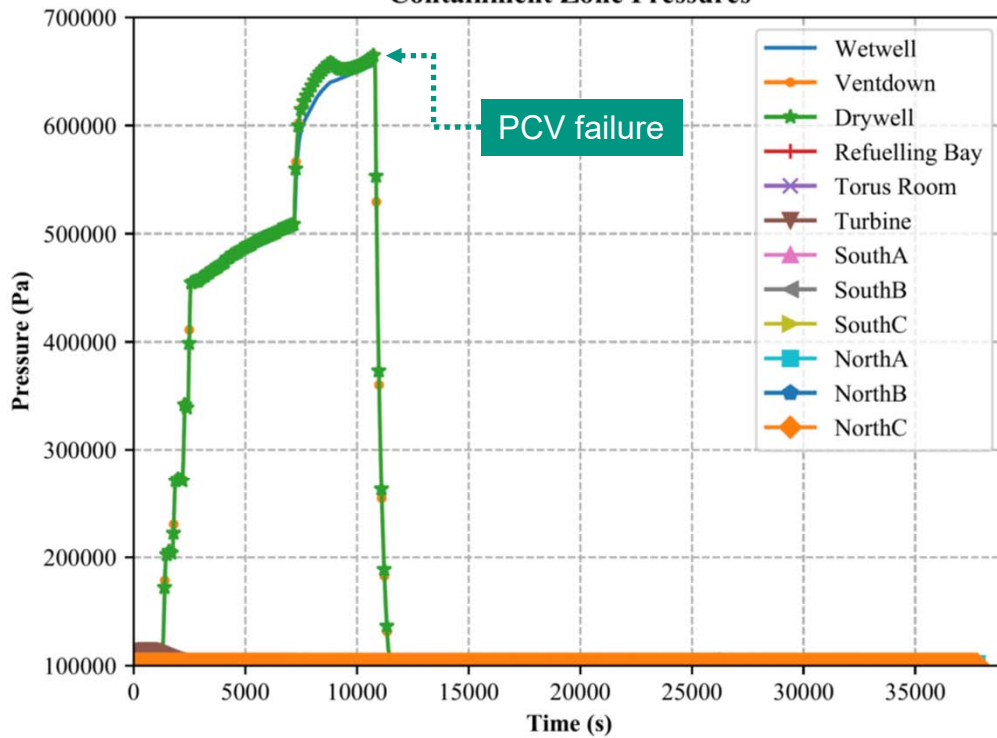

Extracted Steam Flowrate from SRVs

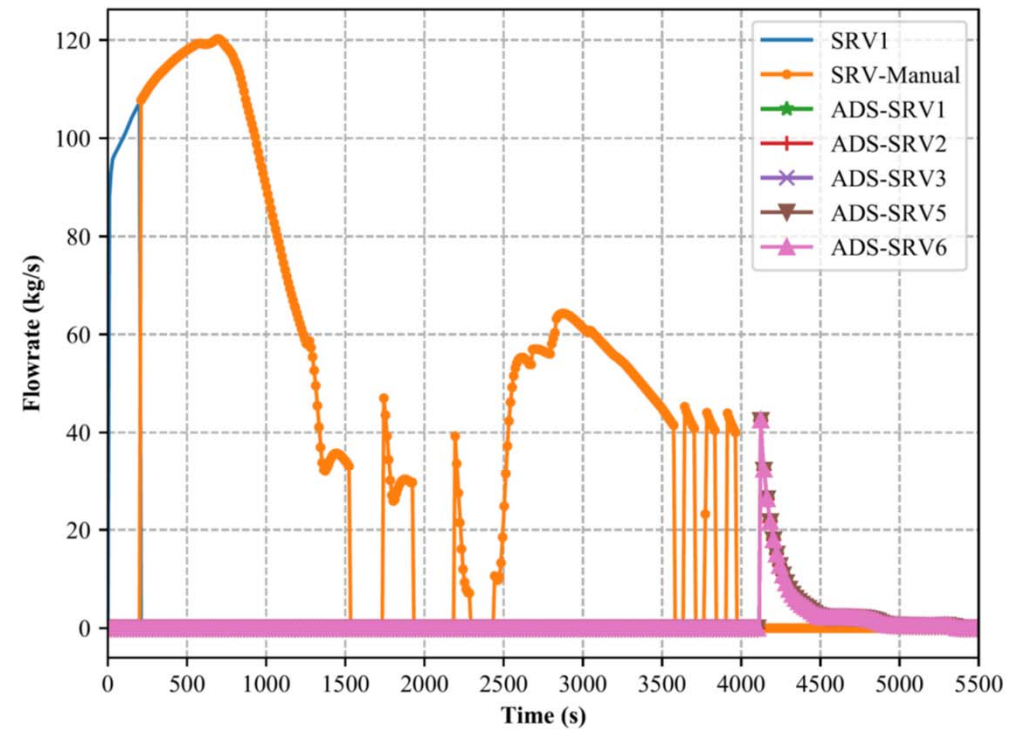

ST-SBO: Fission Products in the Core

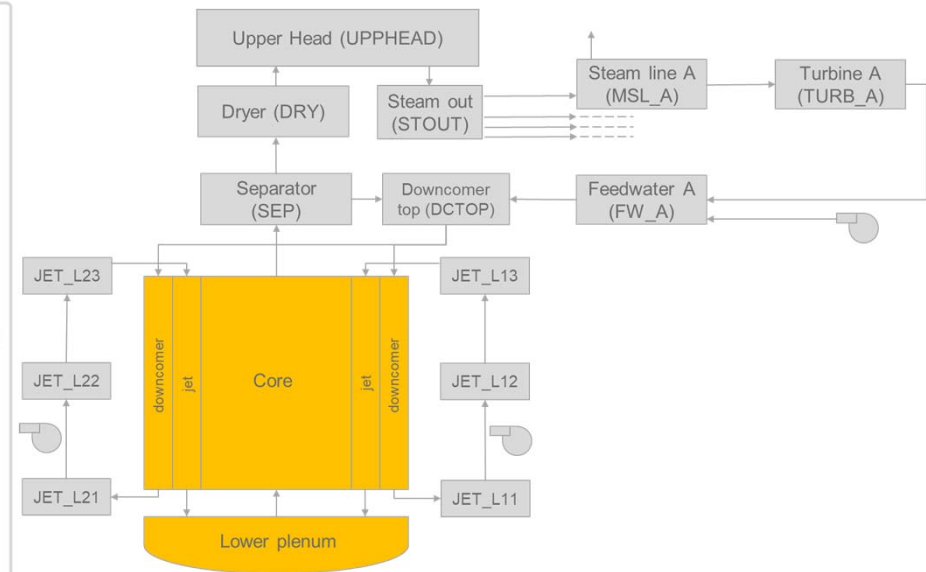
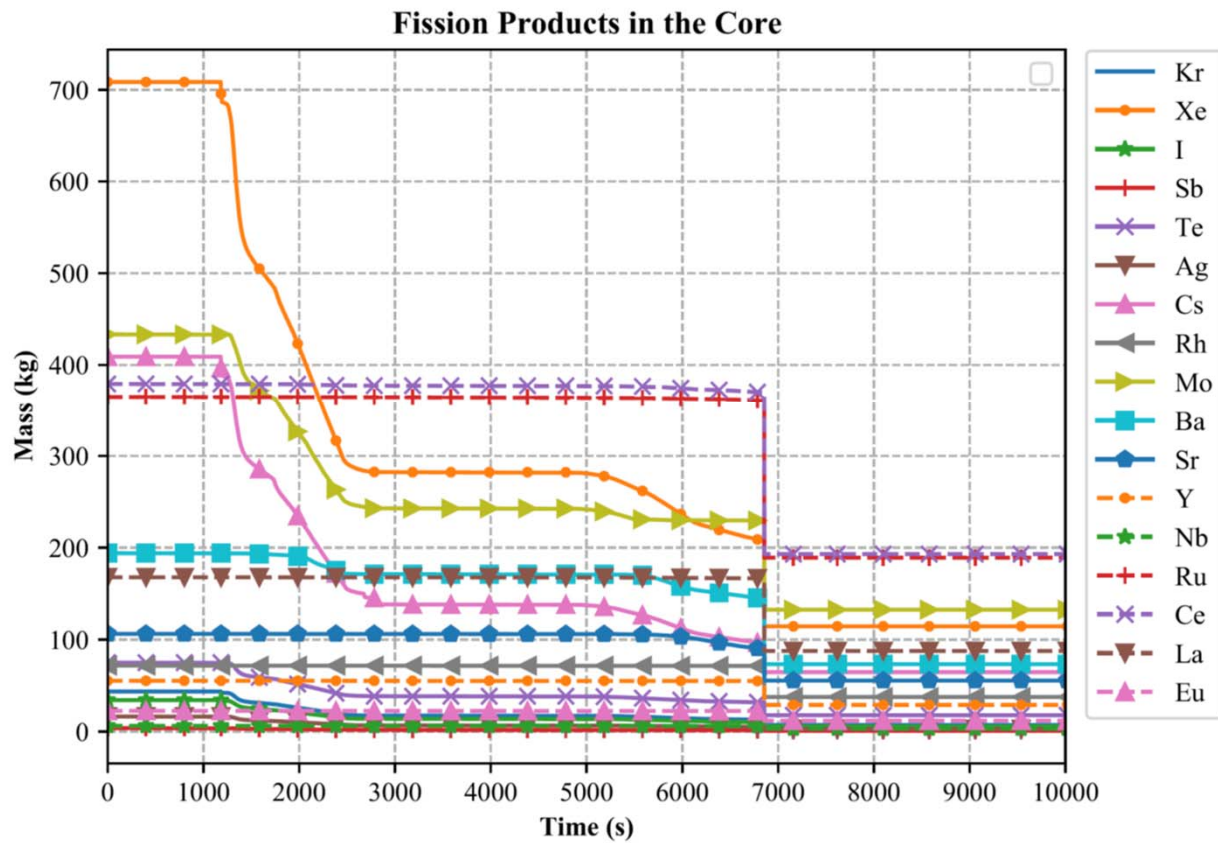

ST-SBO: Fission Products in CESAR Volumes 1/2

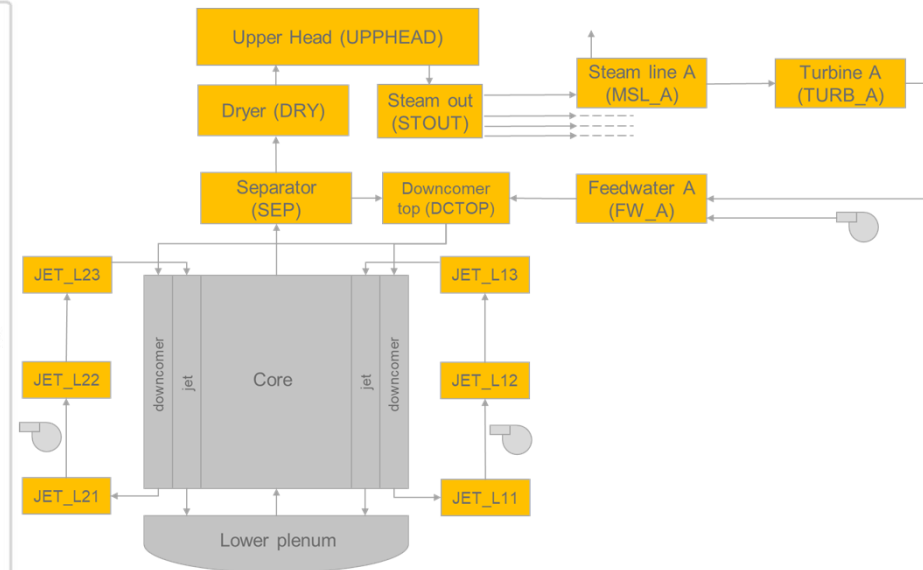
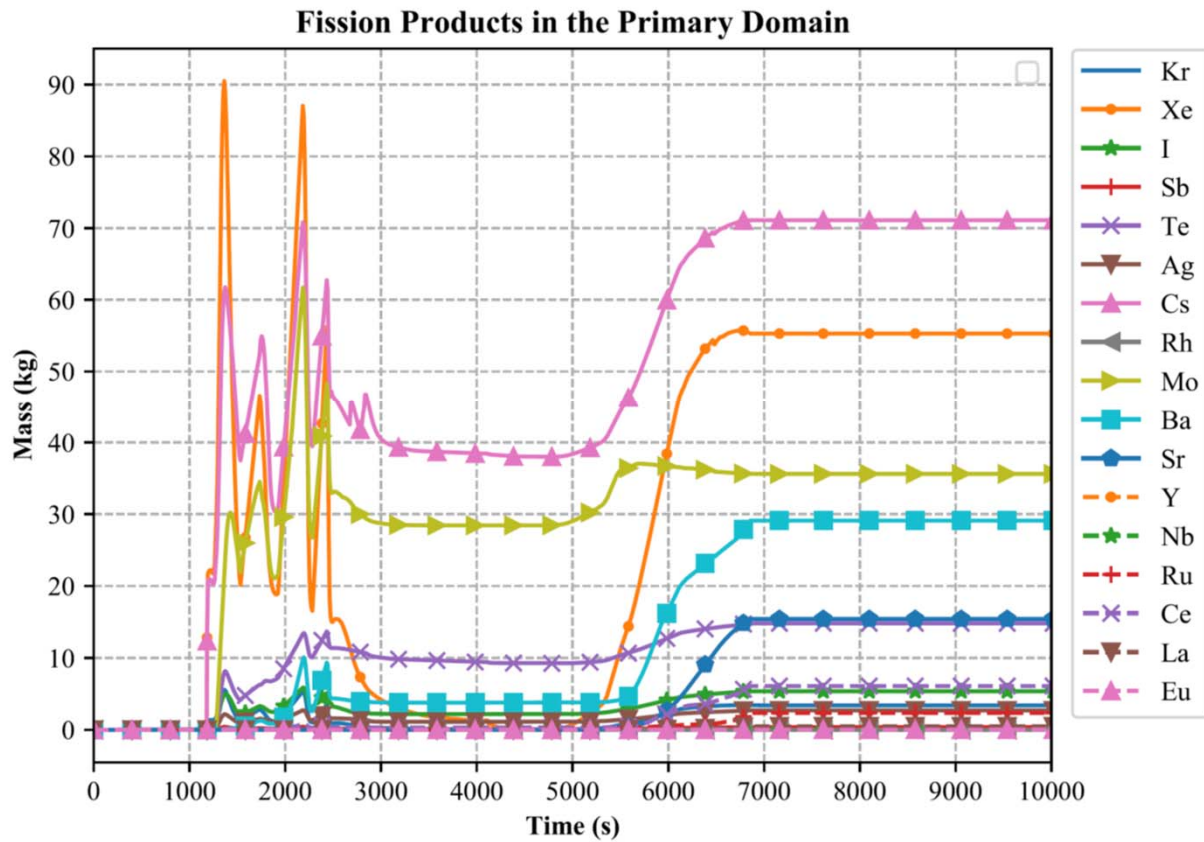

ST-SBO: Fission Products in CESAR Volumes 2/2

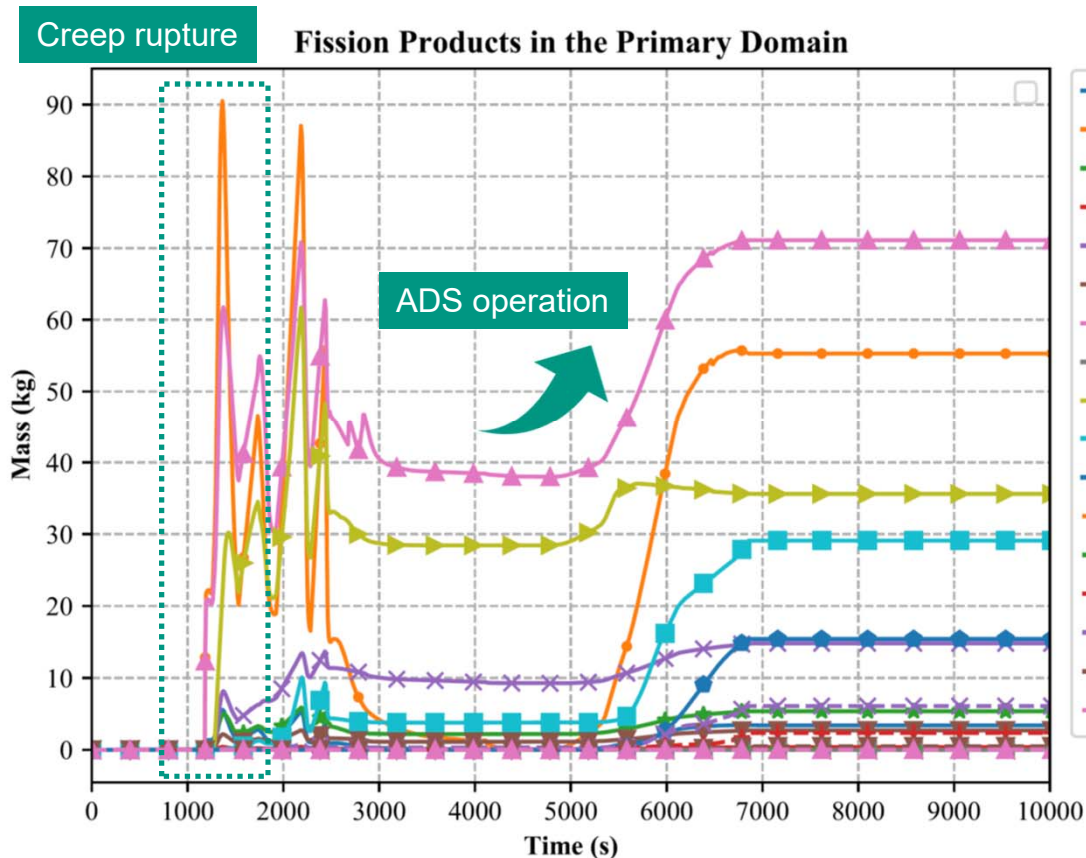

- **0 second** : SRV1 starts operation
- **200 seconds** : SRV1 stops operation, Manual operation of SRV
- **1183 seconds** : First cladding creep rupture, start of FP release
- **1251 seconds** : First material slump in lower plenum
- **1268 seconds** : First slump of corium with FPs in lower plenum
- **1320 seconds** : First appearance of a cavity in the core
- **3983 seconds** : Manual operation of SRV stops, ADS actuation
- **6855 seconds** : Lower head vessel failure
- **10815 seconds** : PCV Head flange failure
- **37847 seconds** : Basemat Rupture

ST-SBO: Fission Products in the Containment Zones 1/2

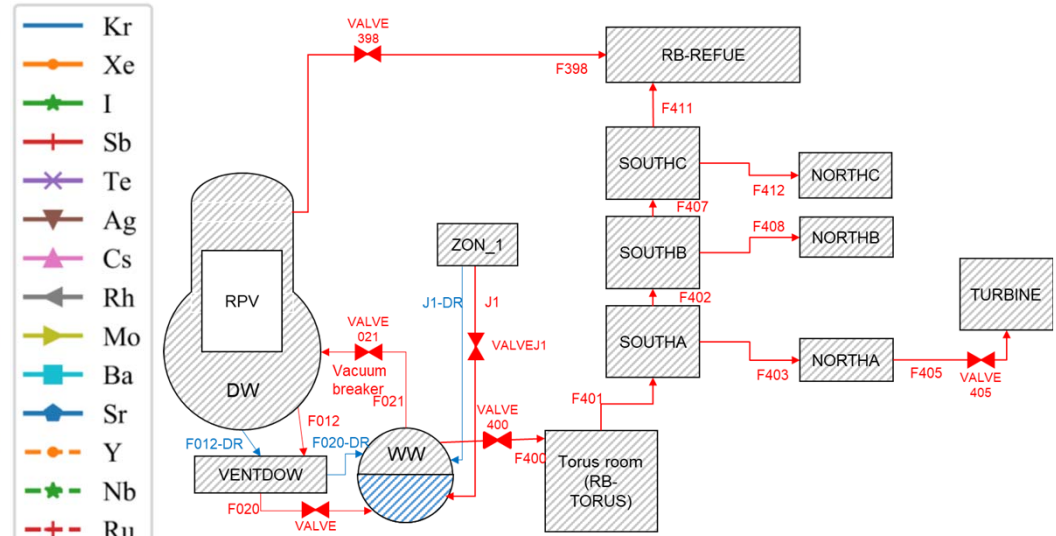
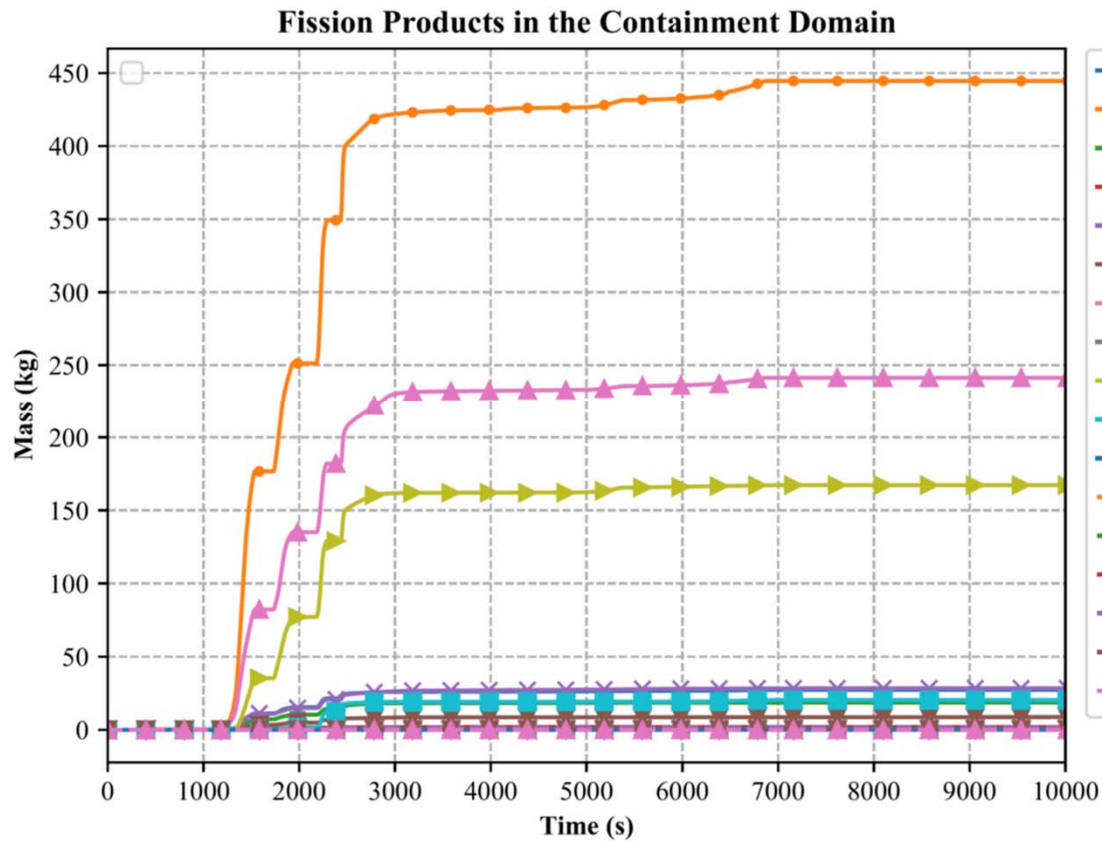

ST-SBO: Fission Products in the Containment Zones 2/2

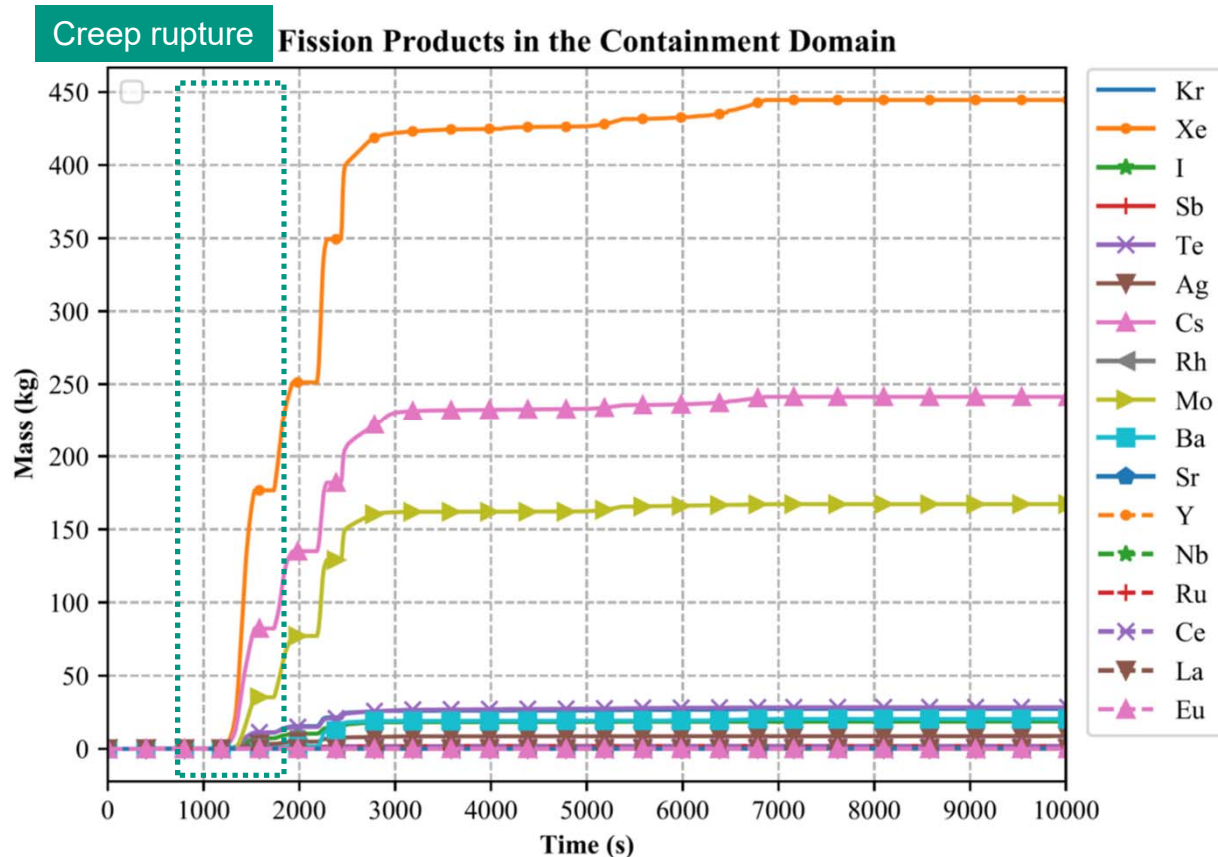

- **0 second** : SRV1 starts operation
- **200 seconds** : SRV1 stops operation, Manual operation of SRV
- **1183 seconds** : First cladding creep rupture, start of FP release
- **1251 seconds** : First material slump in lower plenum
- **1268 seconds** : First slump of corium with FPs in lower plenum
- **1320 seconds** : First appearance of a cavity in the core
- **3983 seconds** : Manual operation of SRV stops, ADS actuation
- **6855 seconds** : Lower head vessel failure
- **10815 seconds** : PCV Head flange failure
- **37847 seconds** : Basemat Rupture

ST-SBO: Fission Products Released to the Environment

Fission Products in the Environment

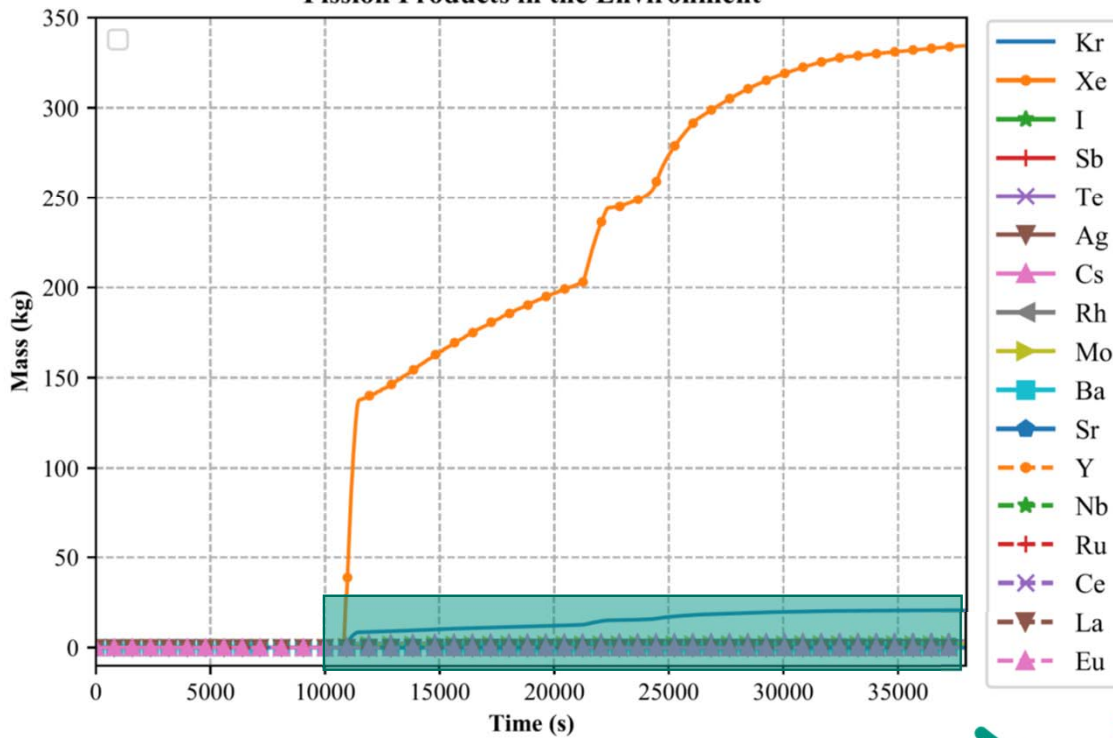

Fission Products in the Environment

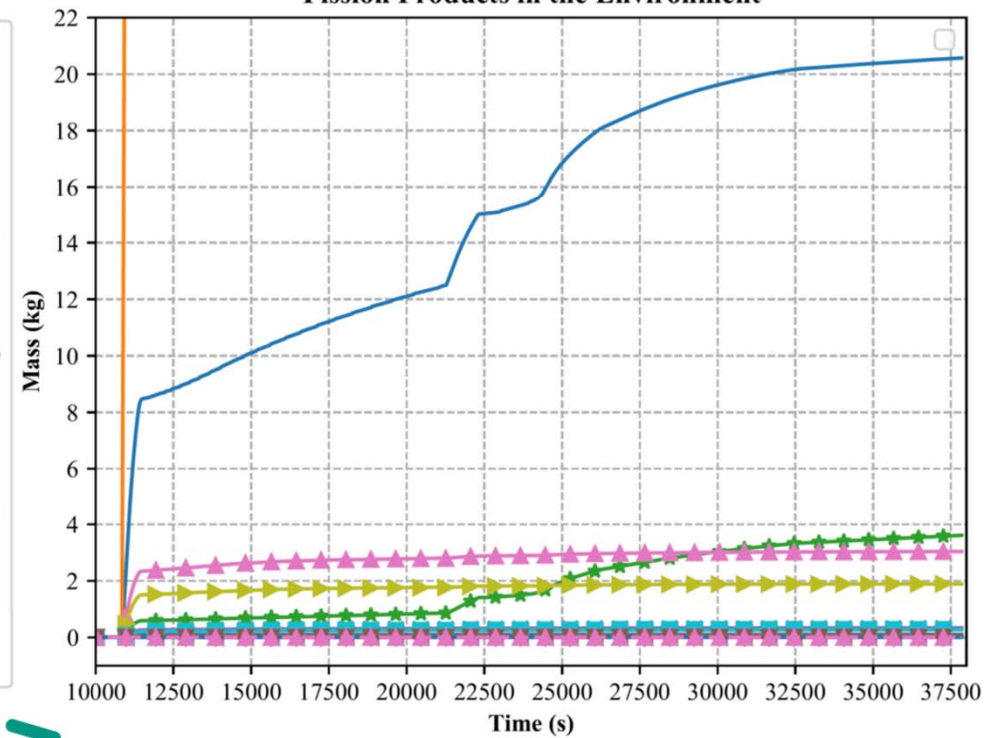

ST-SBO: Shape of the Cavity Erosion and Temperature at the Basemat Rupture

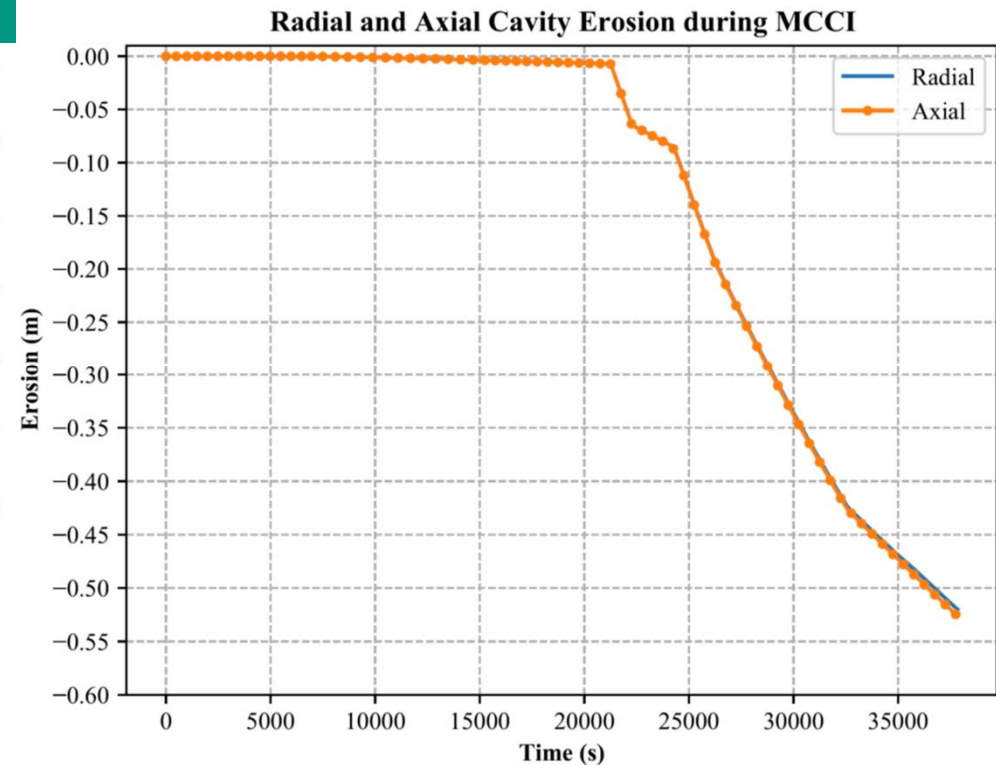
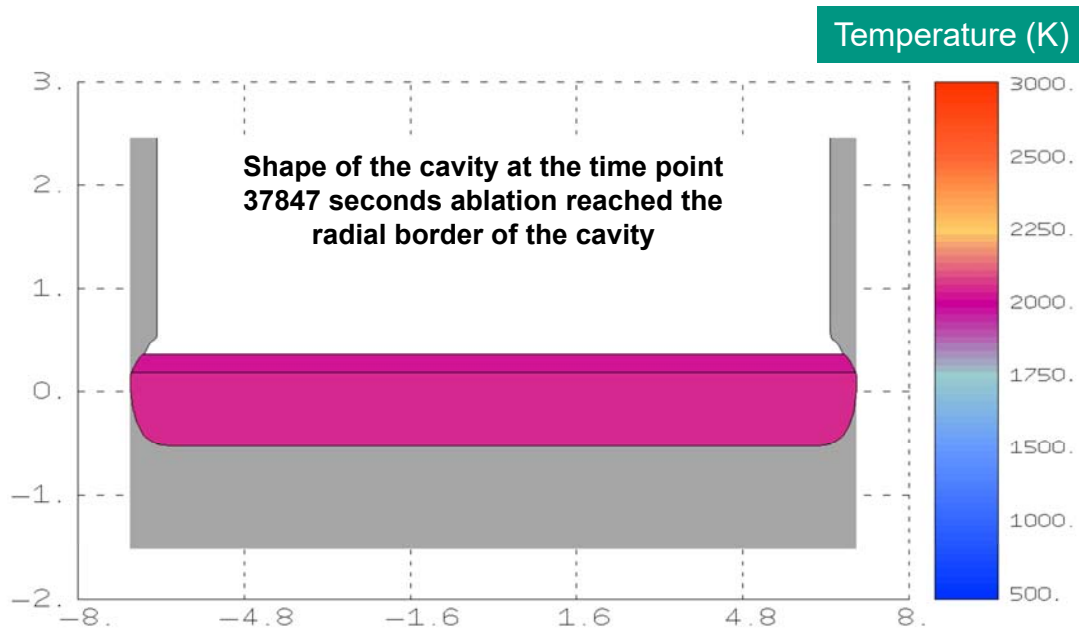

- U.S. standard, limestone-commond sand concreete covers the cavity.
- Radial-axial ablations on U.S. limestone-commond sand concrete are in **same magnitude** compare to E.U. siliceous concrete type which radial ablation is factor of two greater than axial one.

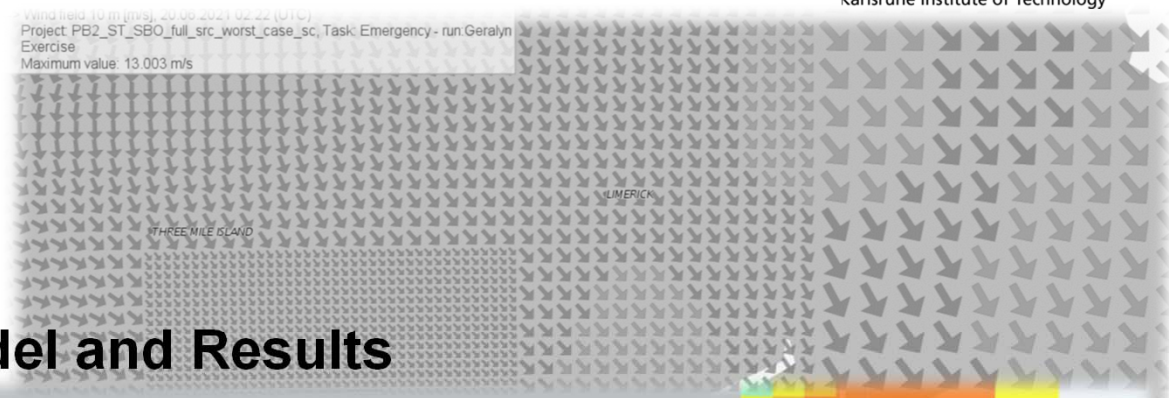

Model and Results

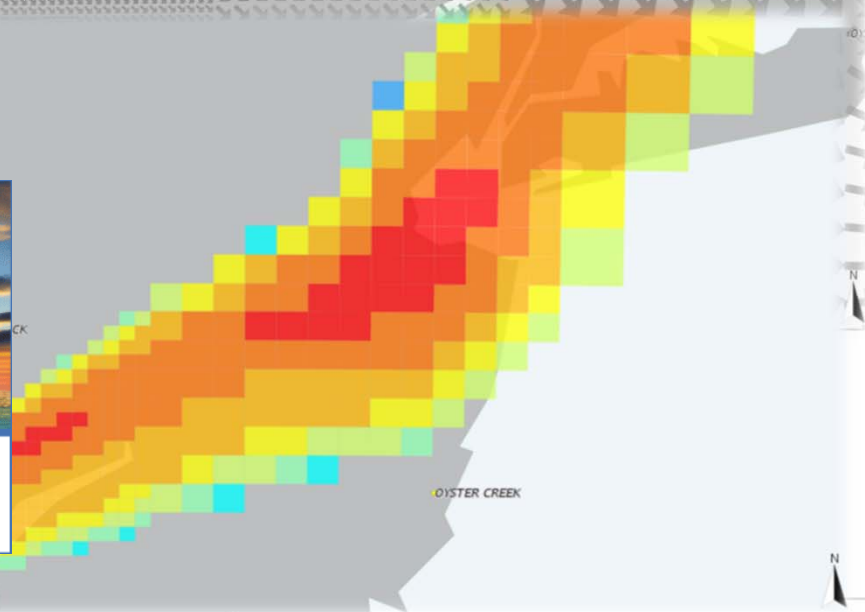
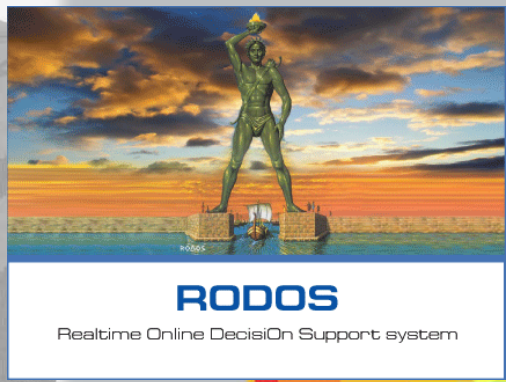

JRODOS Dispersion Model of the PB2 ST-SBO Source Term

- 400 x 400 km meshed map.
- 24 hours calculation.
- No emergency counter measures taken into account.
- Source term taken from ASTEC simulation environment release results.

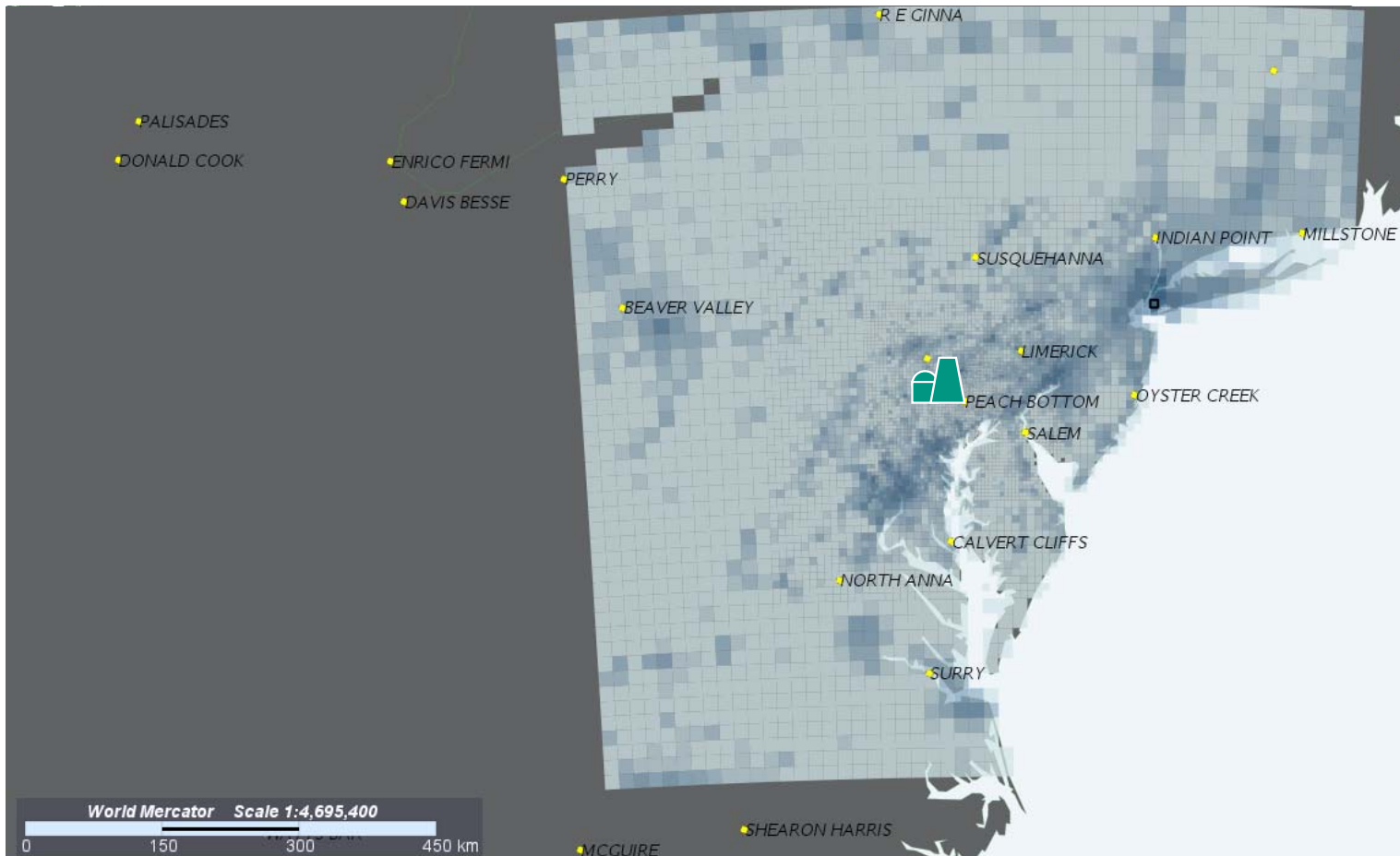

Selected Isotopes for JRODOS source term

Short term lived isotopes

Isotope	Half-life
Kr-88	2.8 h
Sr-91/Y-91m	9.5 h/0.8 h
Sr-92/Y-92	2.7 h/3.7 h
Y-93	10.5 h
Zr-97/Nb-97	17 h/1.2 h
Ru-105/Rh-105	4.4 h/35.5 h
I-133	20.8 h
I-134	0.9 h
I-135	6.6 h
Xe-135	9.1 h
Ce-143	1.4 d

Medium term lived isotopes

Isotope	Half-life
Zr-95/Nb-95	64 d/35 d
Mo-99	2.8 d
Ru-103	39 d
Sb-127	3.8 d
I-131	8.0 d
Te-131m	1.2 d
Te-132/I-132	3.2 d/2.3 h
Xe-133	5.2 d
Xe-133m	2.2 d
Ba-140/La-140	12.8 d/1.7 d
Ce-141	32 d
Ce-143	1.4 d
Nd-147	11.1 d

Long term lived isotopes

Isotope	Half-life
Kr-85	10.7 y
Sr-90	28.6 y
Ru-106	1.0 y
Ag-110m	0.7 y
Sb-125	2.8 y
Cs-134	2.1 y
Cs-137	30.1 y
Ce-144	284 d
Eu-154	8.6 y

Red volatile isotopes which their almost total release expected.

Orange semivolatiles shows high level of release.

Blue is low volatile class which in the upper and colder section of the vessel their retention is expected.

Black is for non-volatile isotopes.

Statistic Sampling of Source Term with JRODOS 1/2

- Selecting weather conditions and region of interest.
 - Worst case scenario = Delivering as many doses as possible to the society
 - Highest population density cells were selected as region of interest:

When?
Where?

Manhattan District
Long Island (Brooklyn)

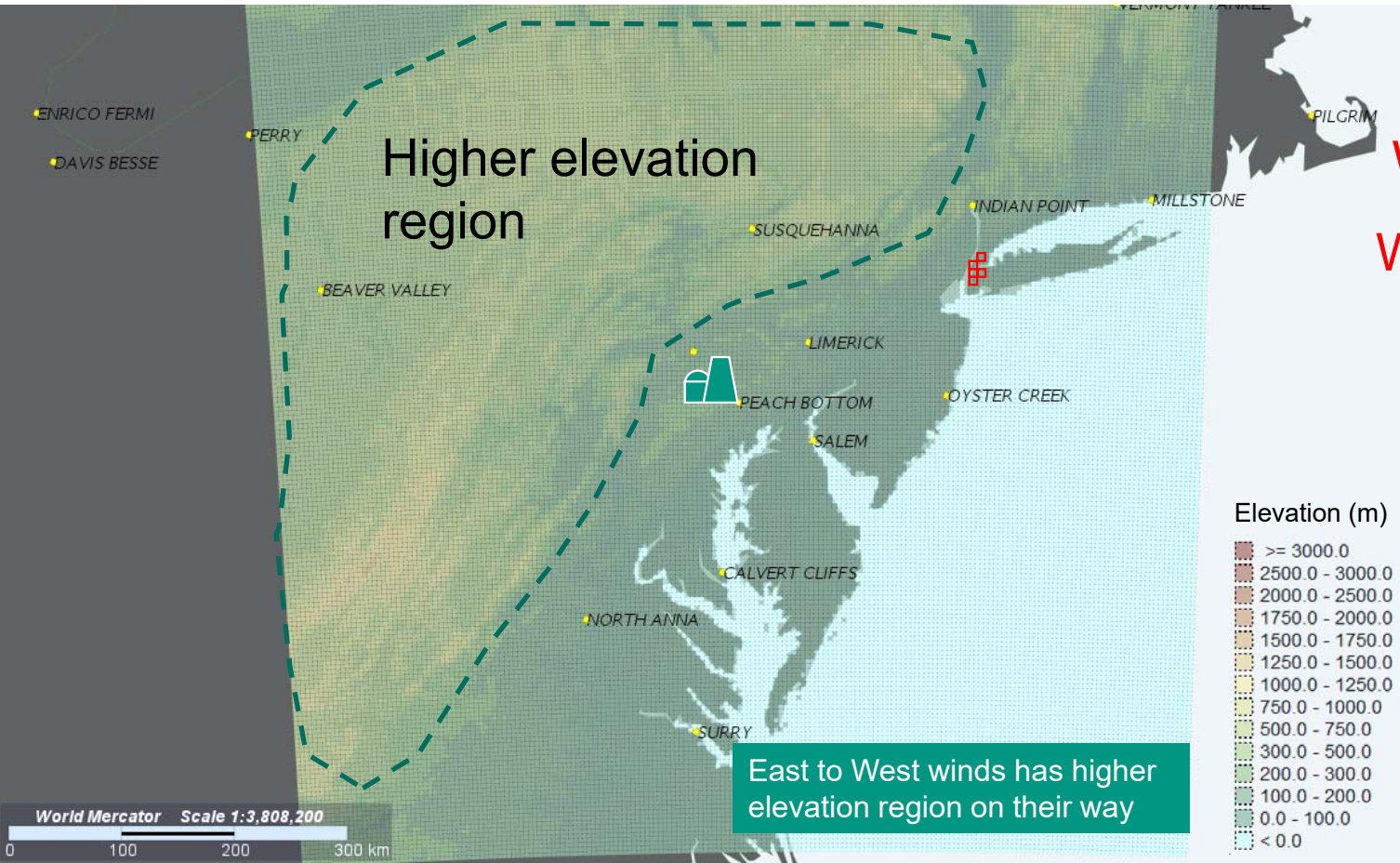

Statistic Sampling of Source Term with JRODOS 2/2

Total Effective Gamma Dose Rate, All Nuclides

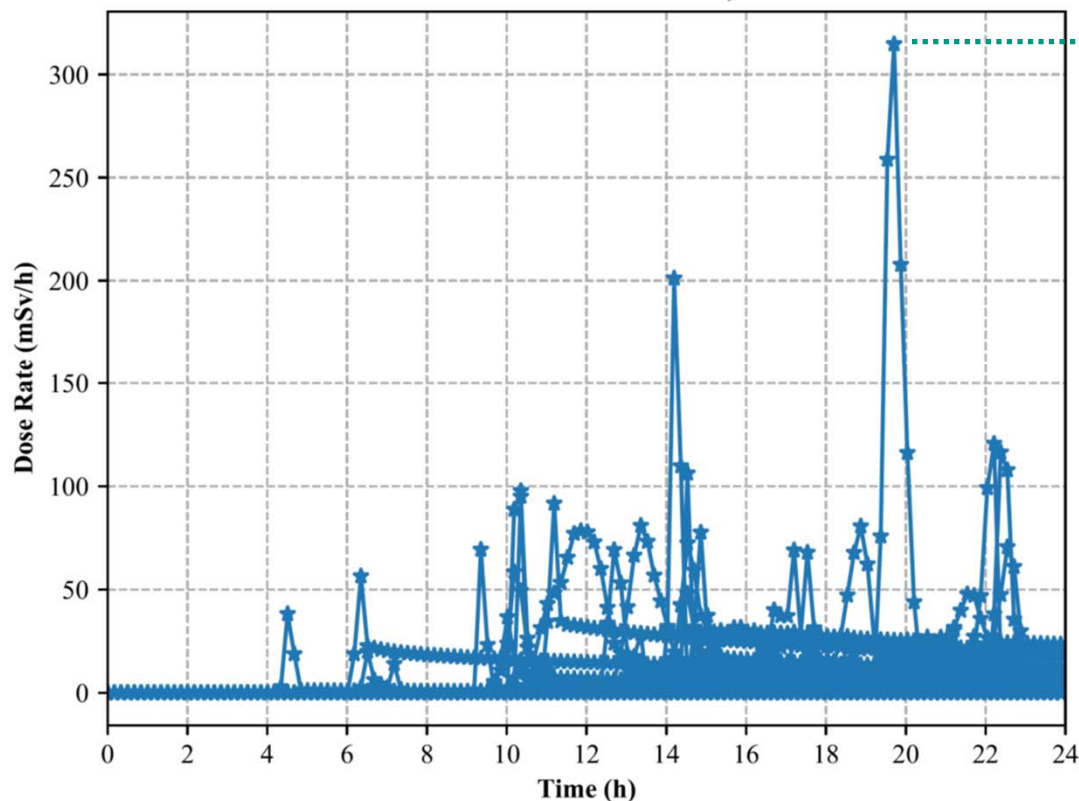

24h calculation each day for 1 Year (01.01.2021-31.12.2021)

Highest dose rate was recorded:

Cell = 5606

Value = 314.79 mSv/h

Release Start Date = 2021.06.20 02:12 AM

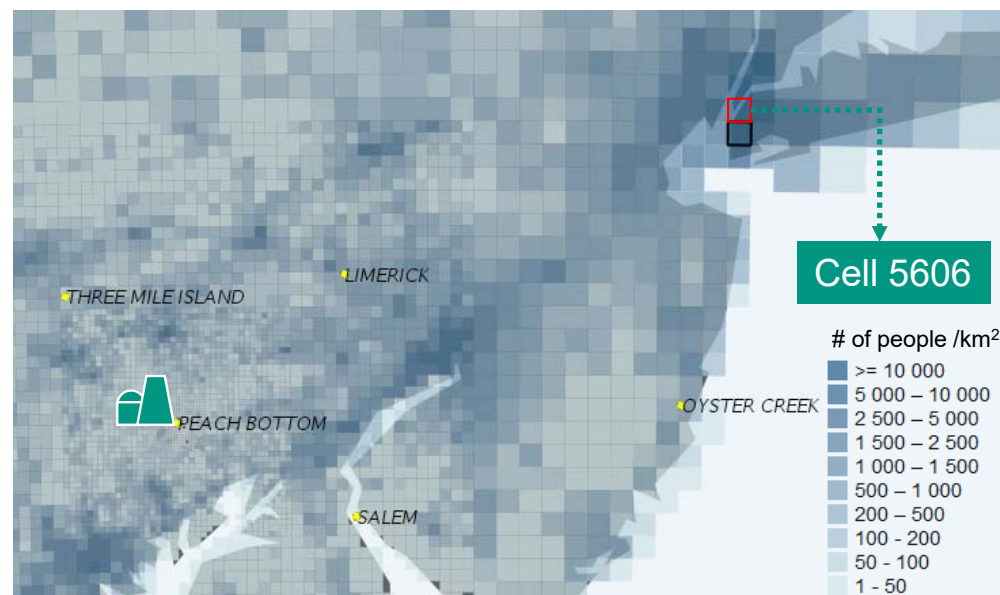

Simulation of JRODOS on Worst Case Scenario

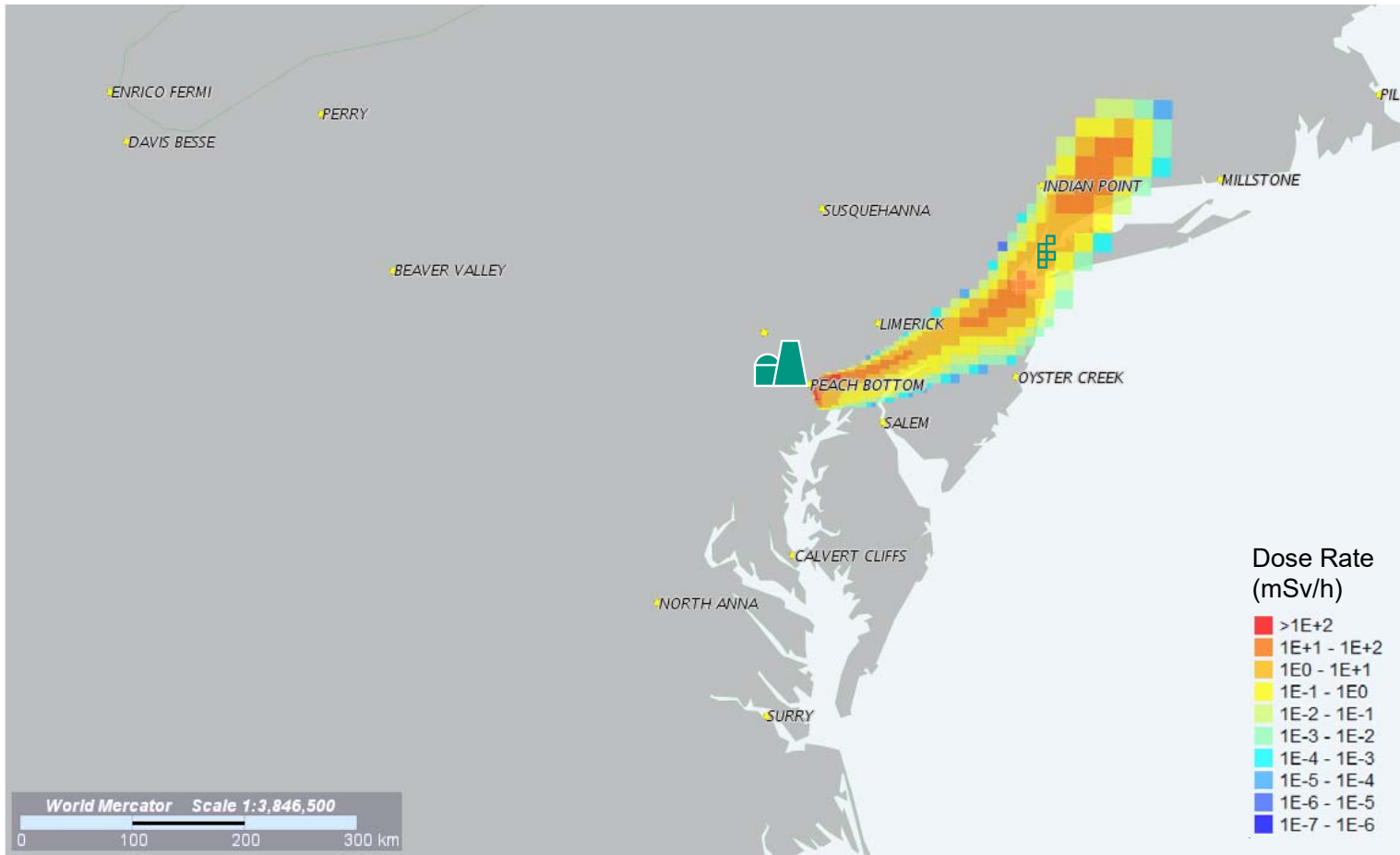

- **Release Start Date** = 2021.06.20 02:12 AM
- Weather conditions of the release date was employed.
- **Simulation Duration** = 24 hours
- Between interested cell points highest dose rate was recorded **314.79 mSv/hr**

U.S. annual limit for whole body total effective dose (10 CFR 20)

Radiation worker

50 mSv/yr

Member of public

1 mSv/yr

Germany annual limit for whole body total effective dose (BfS)

Radiation worker

20 mSv/yr

Member of public

1 mSv/yr

Thank You for Your Attention

Contact: onur.murat@partner.kit.edu

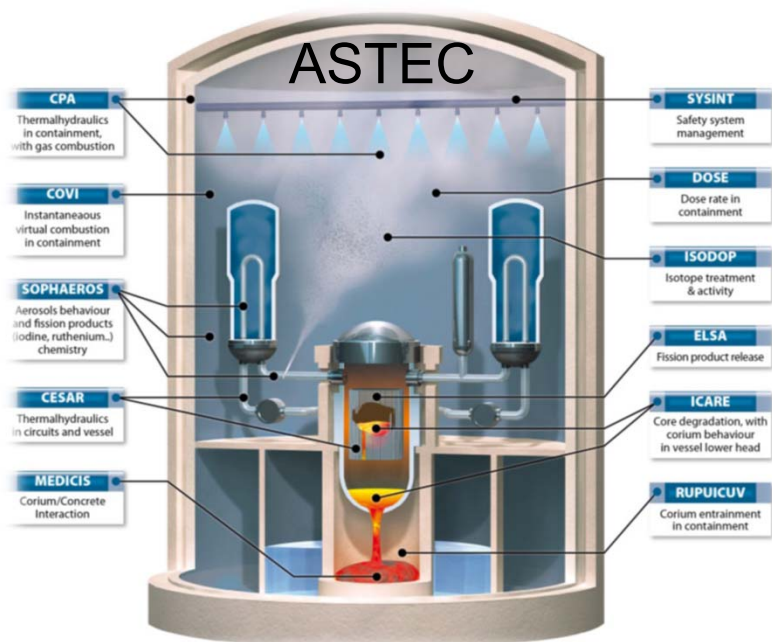

RODOS

Realtime Online DecisiOn Support system