

# REQUIREMENTS FOR AN INDUCTIVE VOLTAGE ADDER AS DRIVER FOR A KICKER MAGNET WITH SHORT CIRCUIT TERMINATION

J. Ruf, M. J. Barnes, T. Kramer, CERN, Geneva, Switzerland  
 M. Sack, KIT, Karlsruhe, Germany

## Abstract

At CERN pulse generators based on Thyatron switches and SF6 gas filled pulse forming lines, used for driving kicker magnets, are to be replaced with semiconductor technology. Preliminary investigations show the inductive voltage adder is suitable as a pulse generator for this application. To increase the magnetic field without raising the system voltage, a short-circuit termination is often applied to a kicker magnet. Because of the electrical length of a transmission line magnet, wave propagation needs to be considered. To allow for the wavefront reflected from the short-circuit termination back to the generator, a novel approach for an inductive adder architecture has been investigated. It is based on a modified generator interface, circulating the current back into the load, until the stored energy is absorbed at the end of the pulse. This approach allows for a smaller magnetic core size compared to a conventional design with a matched load. Moreover, it enables more energy-efficient operation involving smaller storage capacitors. This paper summarizes the conceptual design features and furthermore gives an overview of the parameter space for possible applications at CERN.

## INTRODUCTION

Currently, kicker magnets at CERN are predominantly driven by pulse generators based on thyatron switches and pulse forming lines (PFL) or pulse forming networks (PFN). A pulse generator based on a PFL or a PFN represents a matched source with an impedance matching the characteristic impedance of the kicker magnet.

The voltage divider formed by the impedance of a matched source and the matched load impedance causes a reduction of the driving voltage by a factor of two and hence, requires the driving voltage to be twice the voltage applied to the kicker magnet. The insulation of some of the cables used as pulse forming lines comprises SF6 gas which is known to be harmful to the environment [1], and, hence, should be replaced in the near future. Thyatron switches sometimes exhibit spontaneous turn on, which can lead to miskicks and damage to accelerator components, moreover, they are becoming increasingly difficult to source [2]. Some kicker magnets are specified to be terminated in a short-circuit. Compared to a termination with a matched resistor, this leads to a doubling of the current flowing through the kicker magnet and thereby the magnetic field for a given system impedance and magnet length. Hence, the advantages are a doubling of the kick strength in relation to the voltage seen by the kicker magnet, as well as savings on space along the beam line. In the frame of a feasibility study the replacement of the existing PFL generators by an appropriate voltage source with low

inner impedance, while keeping the design of the short circuit kicker magnets, is currently under investigation.

## MATCHED SOURCE VS. LOW IMPEDANCE SOURCE

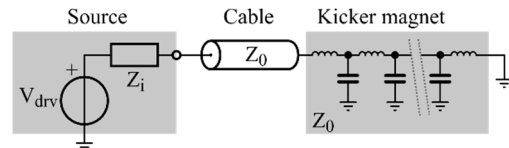

Figure 1: Simplified circuit: matched source ( $Z_i = Z_0$ ) and low impedance voltage source ( $Z_i \approx 0$ ).

Figure 1 shows a transmission-line kicker magnet connected to either a matched source or a low impedance voltage source by a cable with the characteristic impedance  $Z_0$ . The transmission-line kicker magnet is the type of kicker magnet generally used at CERN [2]. It consists of inductive segments formed by parallel conductors and ferrite cores, interleaved with capacitance to ground to resemble the equivalent circuit of a transmission line with a specified characteristic impedance  $Z_0$ . The two kicker systems mentioned above exhibit considerable differences regarding energy flow. With the matched source, energy reflected at the short circuit termination is continually absorbed by the inner impedance of the source, and simultaneously resupplied by the internal voltage source  $V_{drv}$ . The voltage source with low inner impedance initially feeds energy into the kicker magnet and the connecting cable. The energy is stored inductively and kept constant during the pulse flat-top. Finally, the energy is extracted by the source at the end of the pulse. This approach has the advantage, that only the energy stored in the inductance has to be supplied by the source. Moreover, it opens the possibility to later recuperate this energy.

## WAVE PROPAGATION

Figure 2 shows the simplified schematic of the idealized kicker system. The pulse generator is represented by a low impedance pulsed voltage source. For circuit simulation the kicker magnet and the connecting cable are modelled as ideal lossless transmission lines with the characteristic impedance  $Z_0$  and the single transit times  $\tau_c$  and  $\tau_k$ , respectively.

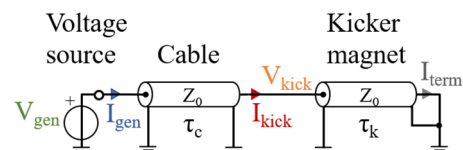

Figure 2: Schematic of the idealized kicker system.

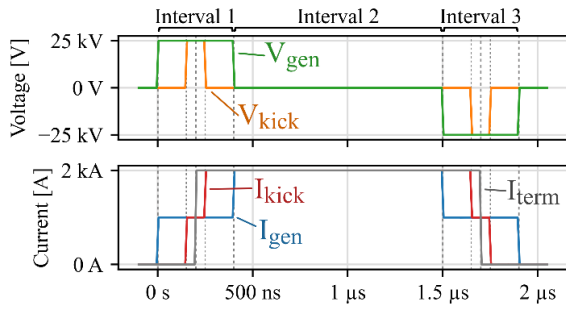

Figure 3: Circuit simulation of the schematic in Fig. 2, with  $\tau_c=150$  ns,  $\tau_k=50$  ns, pulse length (FWHM): 1.5  $\mu$ s,  $Z_0=25$   $\Omega$ ,  $\hat{V}_{gen}=25$  kV,  $V_{gen}$  rise/fall times: 10 ns.

Figure 3 shows the simulated voltage at the output of the pulse generator  $V_{gen}$  and the input to the kicker magnet  $V_{kick}$  as well as the currents flowing through the pulse generator  $I_{gen}$ , into the input of the kicker magnet  $I_{kick}$  and through the short-circuit termination  $I_{term}$ . The course of the pulse can be divided into 3 intervals shown at the top of Fig. 3: To start the pulse at the beginning of interval 1, the pulse generator outputs a voltage that travels as a wave from the generator towards the load i.e., the kicker magnet and its connecting cable. Energy is fed into the load and is stored there both capacitively and inductively. As the traveling voltage wave reaches the short-circuit termination in the middle of interval 1, it is reflected with an inverted sign and travels back towards the generator. The capacitively stored energy is converted to inductively stored energy as the ingoing and reflected voltage waves cancel out and the current doubles. In interval 2 the energy inductively stored in the load is maintained for the duration of the pulse. To achieve this, once the reflected wave reaches the generator at the end of interval 1, it switches its output to  $V_{gen} = 0$  V so there is no more energy exchange between the source and the load. interval 3 is equivalent to interval 1 but with inverted signs, in order to extract the stored energy from the load.

### INDUCTIVE ADDER

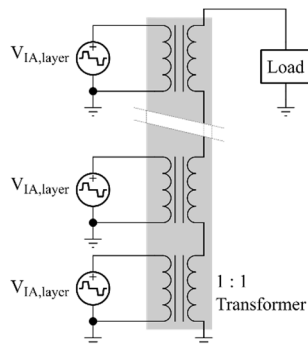

Figure 4: Basic schematic diagram of an inductive adder.

The low impedance voltage source can be implemented using an inductive adder topology. Figure 4 shows the basic schematic of an inductive adder. It consists of multiple layers, each comprised of a voltage source connected to the primary winding of an 1:1 output transformer.

The secondary windings of the output transformers are connected in series resulting in the output voltage being the sum of the primary voltages in the ideal case. The advantages of the inductive adder topology include a modular design and ground-referenced layers. [3]

### Influence of Core Saturation on Pulse Length

In an inductive adder, the voltage-time-integral over the output voltage of a layer  $V_{IA,layer}$  causes an increase of the magnetic field  $B_c(t)$  in the core of the output transformer as given in Eq. (1). Therefore, with an inductive adder driving a matched load, the saturation of the magnetic cores with a cross sectional area  $A_{Fe}$  limits the pulse length. [4]

$$B_c(t) = \frac{\int V_{IA,layer}(t)dt}{A_{Fe}} + B_c(0) \quad (1)$$

Figure 5 shows the output voltage  $V_{IA,layer}(t)$  of one layer of an inductive adder driving a kicker magnet with a short circuit termination and the corresponding normalized magnetic field  $B_c(t)$  in the core of the layer.  $B_c(t)$  increases during interval 1, remains constant during interval 2 and returns to 0 during interval 3.

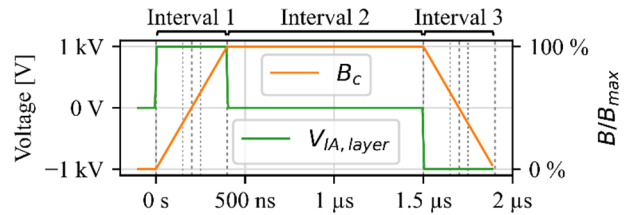

Figure 5: Inductive adder driving a kicker magnet with a short circuit termination (simulation).

As a consequence, in the lossless case, the required size of the magnetic cores is not determined by the length of the pulse, but the sum of the transit times of the kicker magnet  $\tau_k$  and the connecting cable  $\tau_c$ . This potentially enables the use of smaller, cheaper magnetic cores and longer pulses.

Table 1: Selected Parameters for Applications at CERN PS Complex

Parameter	Range
Output voltage	18.5 kV .. 40 kV
Output current (final current after doubling by the s/c-termination)	1.2 kA .. 5.3 kA
Pulse generator impedance	6.25 $\Omega$ .. 25 $\Omega$
Single transit time of kicker magnet	33 ns .. 248 ns
Flattop duration	0.7 $\mu$ s .. 2.6 $\mu$ s

### Parameter Space for Applications at CERN

Analysis of the existing CERN installations in the PS complex resulted in the range of parameters shown in Table 1 for kicker systems that are operated with a short circuit termination and involve the use of SF6 gas.

## INACCURACY IN SWITCHING TIME

In the previous considerations, for the switching of the generator's output voltage, ideal timings have been assumed, matching both the transit times and rise/fall times of the wave traveling through the load. Inaccuracies in these timings lead to additional undesired energy exchange between the pulse generator and the load. The main design parameter for a kicker magnet is the deflection angle  $\theta$  of a charged particle. In the ideal case it is proportional to the flux  $\Phi_{kicker}(t)$  in the kicker magnet for a given design of a transmission line type kicker magnet. As shown in Eq. (2), neglecting losses, the flux  $\Phi_{kicker}(t)$  in the kicker magnet is given by the time integral over the difference between the voltages at the magnet's input and output ports,  $V_{m,in}(t)$  and  $V_{m,out}(t)$  respectively [2]:

$$\Phi_{kicker}(t) = \int (V_{m,in}(t) - V_{m,out}(t)) \propto \theta \quad (2)$$

For a kicker magnet terminated in an ideal short circuit, the voltage at the magnet's output  $V_{m,out}(t)$  is zero.

### Effect of Jitter in Switching Time

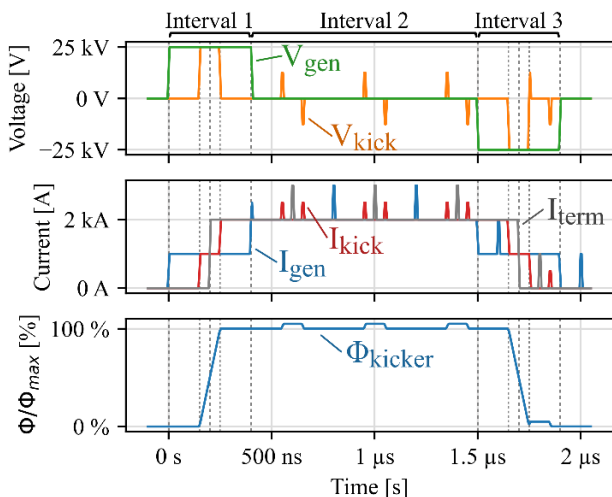

Figure 6: Simulation: jitter in switching time.

Figure 6 shows a circuit simulation where the switching of the output voltage of the generator to  $V_{gen} = 0\text{ V}$  at the end of interval 1 is delayed by 5 ns after the arrival of the reflected wave at the generator. This causes additional energy to be fed into the load and leads to a unipolar voltage and current spike traveling through the load. It is reflected repeatedly both at the generator and the short circuit termination. While the spike is traveling through the kicker magnet, it causes an undesired increase in the flux  $\Phi_{kicker}(t)$  in the magnet. Hence, exact timing of the switching moment is crucial.

### Effects of Rise/Fall Times

With the load behaving as an ideal transmission line with a short circuit termination, the absolute rise and fall times of the output voltage of the pulse generator do not cause perturbations in the flux of the kicker magnet if the slopes

of the generator output voltage waveform  $V_{gen}(t)$  are matched. In the simulation shown in Fig. 7 the rise time of the output voltage  $V_{gen}(t)$  at the beginning of interval 1 is 20 ns while the rest of the rise/fall times are 10 ns. The switching processes are centred on the ideal times. This mismatch of the slope of the returning wave at the end of interval 1 and the slope of  $V_{gen}(t)$  causes a bipolar and symmetric disturbance in the wave traveling through the load. Because of this bipolar and symmetric nature, the disturbance in the wave only causes perturbations in the flux  $\Phi_{kicker}(t)$  as it passes the input terminals of the magnet. Hence, the impact of mismatch in rise/fall times are well mitigated by the integrating behaviour of the kicker magnet.

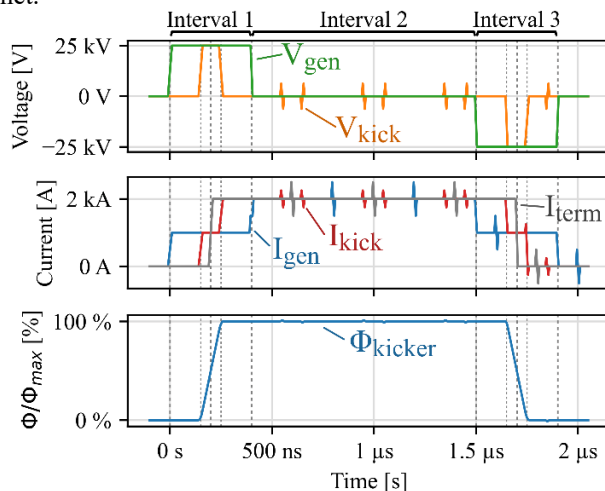

Figure 7: Simulation: mismatch in rise/fall times.

## CONCLUSION

Driving a kicker magnet terminated with a short circuit with a low impedance voltage source is a promising new approach for a more compact pulse generator design. A combination of a kicker magnet with a short circuit termination and a low impedance voltage source requires a specific control scheme for the applied voltage. Thereby, the generator initially injects energy into the load and finally absorbs it at the end of the pulse. With an inductive adder as pulse generator, in the lossless case, the maximum achievable pulse length is not limited by the size of the magnetic cores. Discussion of inaccuracies in the generator's switching times revealed, that exact timing of the switching moment is important. In contrast, the impact of mismatch in rise/fall times are well mitigated by the integrating behaviour of the kicker magnet.

## ACKNOWLEDGEMENTS

This work has been sponsored by the Wolfgang Gentner Programme of the German Federal Ministry of Education and Research.

## REFERENCES

- [1] Umwelt Bundesamt, <https://www.umweltbundesamt.de/themen/verbot-des-klimaschaedlichen-sf6-in>

- [2] M. J. Barnes, “Kicker Systems”, Proceedings of the CAS–CERN Accelerator School, vol. 5/2018, CERN, Geneva, Switzerland, CERN-2018-008-SP, 2018.
- [3] D. Woog, “Inductive Adder for the FCC Injection Kicker System”, Ph.D. thesis, Institute for Accelerator Science and Electromagnetic Fields, Darmstadt, Technische Universität, 2020. <http://tuprints.ulb.tu-darmstadt.de/11726>
- [4] J. Holma, M. J. Barnes, “Preliminary design of an inductive adder for CLIC damping rings”, in *Proc. of IPAC’11*, San Sebastián, Spain, Sep. 2011, paper THPO032, pp. 3409-3411.