

Improvements of simplified hourly models for the energy assessment of buildings: The application of EN ISO 52016 in Italy

Original

Improvements of simplified hourly models for the energy assessment of buildings: The application of EN ISO 52016 in Italy / De Luca, Giovanna; Bianco Mauthe Degerfeld, Franz; Ballarini, Ilaria; Corrado, Vincenzo. - In: ENERGY REPORTS. - ISSN 2352-4847. - ELETTRONICO. - 8:(2022), pp. 7349-7359. [10.1016/j.egy.2022.05.120]

Availability:

This version is available at: 11583/2970677 since: 2022-09-20T16:09:41Z

Publisher:

Elsevier

Published

DOI:10.1016/j.egy.2022.05.120

Terms of use:

openAccess

This article is made available under terms and conditions as specified in the corresponding bibliographic description in the repository

Publisher copyright

(Article begins on next page)



Improvements of simplified hourly models for the energy assessment of buildings: The application of EN ISO 52016 in Italy

Giovanna De Luca*, Franz Bianco Mauthe Degerfeld, Ilaria Ballarini, Vincenzo Corrado

Politecnico di Torino, Department of Energy "Galileo Ferraris", TEBE Research Group., Corso Duca degli Abruzzi 24, 10129 Torino, Italy



ARTICLE INFO

Article history:

Received 21 January 2022
Received in revised form 28 April 2022
Accepted 16 May 2022
Available online xxxx

Keywords:

Simplified hourly model
EN ISO 52016-1
Building energy performance
Thermal energy need
Validation

ABSTRACT

The Italian National Annex (NA) to EN ISO 52016-1 is aimed at improving the simplified hourly calculation method of the building thermal performance assessment by introducing different modelling options. The present work deepens the influence of the Italian NA improved method on the thermal energy needs for heating and cooling of a residential building-type in two different climate zones. In particular, the Italian NA improved options are applied one-at-the-time, and their effect is evaluated in comparison with the EN ISO 52016-1 standard method. The use of solar angle and time dependent correction factors for the total solar energy transmittance of glazing proved to be the most sensitive modelling option, among those analysed. Negligible variations were instead reported for the other tested options.

© 2022 Published by Elsevier Ltd. This is an open access article under the CC BY-NC-ND license (<http://creativecommons.org/licenses/by-nc-nd/4.0/>).

1. Introduction

In the last decade, different calculation methods were developed to address the issue of improving the building energy efficiency. According to the required level of accuracy or detail, a wide range of models for the determination of the building energy performance are available. To overcome the low accessibility to detailed input data, which are usually required by the detailed dynamic models, standardised calculation methods were introduced. Among them, the EN ISO 52016-1 technical standard (European Committee for Standardization, 2017a), developed under CEN Mandate M/480 (European Commission, 2010), provides a simplified hourly calculation method that allows to take into account the effect of dynamic interactions, challenging the need for too detailed input data from the user (van Dijk, 2019). To address this challenge, the hourly calculation method is based on assumptions and simplifications selected as to guarantee a balance between the accuracy and the simplicity of the assessment.

Besides the assumptions generally adopted for the calculation of the building thermal loads (European Committee for Standardization, 2017b), the EN ISO 52016-1 hourly method introduces other simplifications regarding different aspects of the building energy performance assessment. These include the use of constant convective and radiative surface resistances derived

from the EN ISO 13789 (European Committee for Standardization, 2017c), a simplified model for the distribution of mass in the building components, and time- and solar angle-independent glazing solar properties for the transparent building envelope components. Nevertheless, errors in the predictions of building energy consumption can be generated by these modelling assumptions. Thus, it is of primary relevance to validate the standardised hourly method and its modelling simplifications, also considering its possible application in legislative context (e.g., checks of the compliance with the energy performance requirements), which is currently under discussion in all Member States. Therefore, further assessments need to be performed to investigate the effects related to the various modelling assumptions.

1.1. Validation studies of the EN ISO 52016-1 hourly model

Since the release of the technical standard in 2017, the effect of the model simplifications on the accuracy of the calculation method has been the central topic of a growing, but not yet sufficient, body of literature, in which the EN ISO 52016-1 method has been compared to detailed numerical simulation models. Among the simplifications introduced, the research of Ballarini et al. (2020) showed that, for a single family house in northern Italy, the main cause of the differences in the results between the standard hourly method and the detailed dynamic calculation of EnergyPlus was found in the use of constant h -values for the surface convective and radiative heat transfer coefficients. Similarly, the EN ISO 52016-1 modelling assumption related to the definition and the temporal discretisation of the external

* Corresponding author.

E-mail addresses: giovanna.deluca@polito.it (G.D. Luca), franz.bianco@polito.it (F. Bianco Mauthe Degerfeld), ilaria.ballarini@polito.it (I. Ballarini), vincenzo.corrado@polito.it (V. Corrado).

Nomenclature**Quantities**

<i>b</i>	temperature adjustment factor
<i>EP</i>	energy performance kWh m ⁻²
<i>F</i>	correction/reduction/view factor
<i>F_o</i>	Fourier number
<i>g</i>	total solar energy transmittance
<i>H</i>	heat transfer coefficient/conductance W m ⁻² K ⁻¹
<i>I</i>	solar irradiance W m ⁻²
<i>N_{cn}</i>	number of nodes
<i>p</i>	pressure Pa
<i>R</i>	thermal resistance m ² K W ⁻¹
<i>U</i>	thermal transmittance W m ⁻² K ⁻¹
<i>x</i>	thickness m

Greek symbols

κ	areal heat capacity kJ m ⁻² K ⁻¹
Φ	heat flux W m ⁻²
θ	temperature °C

Subscripts/Superscripts

av	average
C	cooling
c	convection
diff	diffuse
dir	beam
door	door
ext	external
floor	floor
gl	global
gl,n	global at normal incidence
H	heating
int	internal
<i>j</i>	layer identification number
mr	mean radiant
nd	need
obst	obstacle
op	operative
<i>pli</i>	node identification number
re	external radiation
ref	reference
roof	roof
sky	sky
<i>t</i>	timestep
v	water vapour
W	window
wall	wall
wall,int	internal wall
<i>ztc</i>	conditioned thermal zone identification number
<i>ztu</i>	unconditioned thermal zone identification number

Acronyms

DGU	Double-Glazed Unit
EPB	Energy Performance of Buildings
IWEC	International Weather for Energy Calculations

NA	National Annex
R-C	Resistive-Capacitive node
SHGC	Solar Heat Gain Coefficient

convective heat transfer coefficients resulted to lead to significant inaccuracies in De Luca et al. (2021a,b). In particular, the Authors deepened the effects of the main modelling assumptions of the standard hourly method related to the energy balance on the indoor and outdoor surfaces for a residential and an office buildings archetype, sited in three different Italian cities. The analysed modelling options were applied to a full detailed dynamic model of EnergyPlus, and their effect on the thermal energy needs for heating and cooling (De Luca et al., 2021a), as well as on the indoor temperatures (De Luca et al., 2021b) were evaluated.

Zakula et al. (2019), analysing the simplification introduced by the EN ISO 52016-1 hourly method on the modelling of the transparent envelope components, underlined the significance of using fixed windows solar properties; this assumption, in fact, led to relevant differences in the results between the standard method and the detailed hourly method applied in TRNSYS (Transient System Simulation Tool) for ten Croatian reference buildings. These results were then confirmed by the same Authors, by extending the analysis and applying it to more than 147 thousand case studies (Zakula et al., 2021). Similar results were found by Magni et al. in Magni et al. (2022). The authors applied both constant and variable windows thermal properties (total solar energy transmittance and thermal resistance) in the EN ISO 52016-1 calculation and compared the outcomes obtained implementing the TRNSYS model. The results emphasised the considerable deviation resulting from the application of constant windows thermal properties. In fact, the use of these latter led to consistent differences in the heating demand for an office building, while the discrepancies between the two models are significantly reduced if variable properties are considered (from 40% to 5%).

To date, a few research have analysed the effect of the simplified mass distribution approach in the building components introduced by the EN ISO 52016-1 technical standard. Summa et al. (2022) have studied the variation in the indoor ambient temperature, as well as in the indoor surface temperatures, related to the variation in the mass distribution in the external walls for a room in a highly insulated residential building. Specifically, they have tested four different structures characterised by the same level of thermal insulation, but with different mass positions (i.e., four out of the five mass distribution classes specified by the EN ISO 52016-1 technical standard). The Authors observed that the extent of the errors in the prediction of both indoor temperature and surface temperatures vary according to the assumed mass distribution when compared to the results of the detailed dynamic method of TRNSYS; the highest discrepancies were found for the construction characterised by the massive layer placed on the outer side. Differently, high discrepancies between the indoor surface temperatures calculated with the EN ISO 52016-1 and the finite difference conduction model implemented in EnergyPlus were instead highlighted by De Luca et al. (2021c) for the structures characterised by the main massive layer placed on the inner side when stressed by sinusoidal internal constraints.

1.2. National annexes to EN ISO 52016-1 technical standard

To ensure the compliance with the requirements of robustness, unambiguity, and transparency, all the technical standards developed under mandate M/480 (European Commission, 2010)

follow specific rules (Van Dijk et al., 2016); they also provide a discrete flexibility that allows specific choices based on the national or regional context (European Committee for Standardization, 2014) through the “National Annex” approach (EPB Center, 2022). In fact, all EPB standards contain a legislative annex (Annex A) – providing a template to be used to specify the national or regional choices (European Committee for Standardization, 2017a) – and an informative annex (Annex B), which provides default choices for all options, boundary conditions and input data presented in Annex A. However, these choices are based on the expert awareness, and not on studies involving national preferences and limitations (EPB Center, 2022). Each Member State can thus replace the default choices for the assessment of the energy performance in the context of their building regulations, and is obligated to describe the deviations of the national choices from the default ones (European Parliament and Council of the European Union, 2018) by means of National Annexes (NA) or National Data Sheets. Therefore, National Annexes may contain information on those data and options, such as modelling options, parameters, and boundary conditions, where alternatives are given in the EPB-standards (examples of the type of choices are presented in Van Dijk and Hogeling (2019)), and may refer to national standards in place of other EPB standards (EPB Center, 2022). This is the case of the Italian National Annex to the EN ISO 52016-1 standard (Comitato Termotecnico Italiano, 2021), currently at the final drafting stage, which introduces improved options on different aspects of the building energy performance assessment. In particular, an improved modelling procedure that takes into account the characteristics and mass distribution of the component layer was introduced for the resistive–capacitive nodes determination. Moreover, hourly variations of the sky temperature and of the total solar energy transmittance of the glazed components were introduced. The coupling of the thermally conditioned zones was also specified.

To date, the introduction of the aforementioned modelling procedures was evaluated in a few researches, therefore it is essential to widen current knowledge of the modelling techniques implemented in the Italian NA. In the study of Mazzarella et al. (2020), the improved conduction model introduced by the Italian NA was compared to the exact analytical solution, and it showed better results with respect to the standard model in terms of internal and external heat flux amplitude and phase difference. Similarly, De Luca et al. (2021c) compared the standard and the improved Italian NA conduction model to the finite difference solution algorithm implemented in EnergyPlus. In this study, the improved conduction model proved to predict the indoor surface temperatures with a high level of accuracy. The same Authors also analysed the effect of the algorithm introduced by the Italian NA for the calculation of the total solar energy transmittance of glazed components (De Luca et al., 2021a) on the thermal energy needs for space heating and cooling of two building archetypes in three Italian cities. The study demonstrated that this improved algorithm allows to predict the annual energy needs with a deviation lower than 10% compared to the full detailed dynamic model of EnergyPlus, for the considered case studies and cities. A sensitivity analysis to the Italian NA improved algorithms was performed by Bianco Mauthe Degerfeld et al. (2020) for a residential existing building in Rome (Italy), while a parametric analysis to evaluate the influence of the NA improved method was performed for an existing office building (Bianco Mauthe Degerfeld et al., 2021). Considerable variations in the thermal energy need for space heating were observed for both NA improved models applied separately and for their combined application in the considered case studies. Finally, Palladino et al. (2021) compared the currently adopted calculation method in Italy (quasi-steady state model) with the simplified hourly method as transposed in the Italian national standard, in terms of thermal energy needs of three reference nearly-zero energy building (nZEB) case studies.

1.3. Aim of the research

The present study attempts to investigate the effects of the improved methods and assumptions of the Italian National Annex on the EN ISO 52016-1 calculation method. In particular, these effects are evaluated through a parametric analysis of the thermal energy needs for heating and cooling of a residential building archetype, sited in two different Italian climatic zones. The research is thus intended to address the evaluation of the proposed procedures to contribute to the enhancement of the Italian standardisation activity. Although the body of literature on the evaluation of the EN ISO 52016-1 hourly method and its National Annexes has been growing in the recent years, there are not yet sufficient data to generalise the findings, as the existing works are generally based on specific case studies. For this purpose, the present paper is intended to broaden this investigation field, which includes also other works of the Authors (Bianco Mauthe Degerfeld et al., 2020, 2021). In particular, the analysis was extended to different building geometry and use, and – compared to previous studies – more detailed investigations were performed to address the aims of the research. Furthermore, in the present work the effect of the Italian National Annex modelling options on the computational effort of the calculation was also addressed, since it has not been sufficiently investigated yet. Moreover, the outcomes of the EN ISO 52016-1 simplified hourly model are compared with those of a detailed dynamic simulation (performed with EnergyPlus) as well, in order to understand the causes of discrepancy between the two models, and to expand the literature on the topic of the validation of the simplified hourly methods.

The article was structured as follows: in Section 2, the improved modelling options introduced by the Italian National Annex are described and compared to the standard method of EN ISO 52016-1; Section 3 provides the methodology, concerning the calculation model comparison and the parametric analysis, and presents the case study; Section 4 deals with the results and the discussion of the main findings.

2. Theory

As introduced in Section 1, the EN ISO 52016-1 hourly method (European Committee for Standardization, 2017a) provides for different assumptions and simplifications regarding different aspects of the building energy performance assessment. To increase the accuracy of the standard hourly method, the Italian NA (Comitato Termotecnico Italiano, 2021) instead introduces improved options regarding the modelling of the conduction heat transfer (Section 2.1), the extra thermal radiation to the sky (Section 2.2), the shortwave radiation heat transfer (Section 2.3), and the coupling of thermally conditioned zones (Section 2.4). The improved modelling options are described in the following sections, and the differences between the standard and the improved Italian NA methods are highlighted as well. These improved methods were previously described in Bianco Mauthe Degerfeld et al. (2021); however, they are here presented for the sake of clarity of the application section.

The improved options presented were evaluated in the present study, except for the coupling of thermally conditioned zones, which will be instead analysed in a future work.

2.1. Heat conduction model (NA-Cond)

Agreeing to the thermal–electrical analogy, both the European standard and the improved Italian NA heat conduction models assume a discretisation of the opaque building envelope components into different resistive–capacitive nodes (R–C), which are

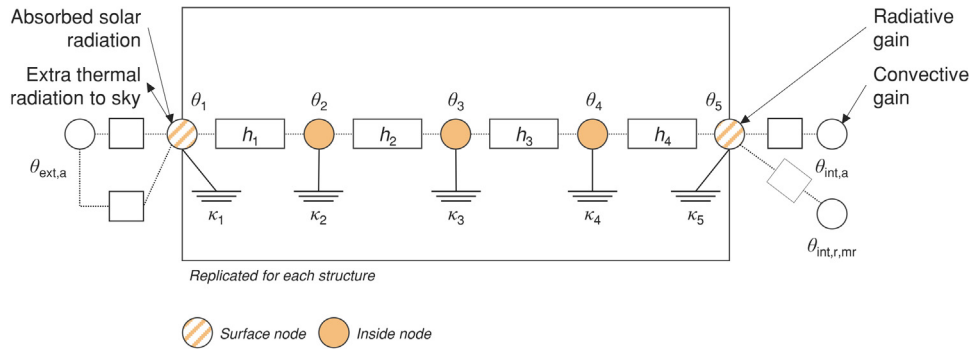

Fig. 1. R-C model for an opaque building component according to EN ISO 52016-1.

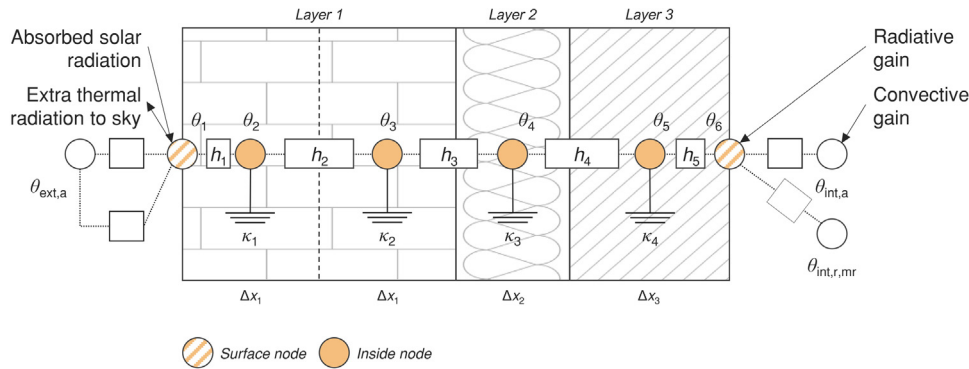

Fig. 2. R-C model for an opaque building component of an example of stratigraphy according to the Italian National Annex to EN ISO 52016-1.

characterised by a heat capacity (κ_{pli} , with pli from 1 to 5) and are interconnected by internode conductances (h_{pli} , with pli from 1 to 4). According to the EN ISO 52016-1 heat conduction model, the components are discretised into up to five R-C nodes, regardless of neither the specific layers of the component nor their thermal properties. An illustration of the R-C model is presented in Fig. 1.

Two are surface nodes, placed on the internal and external surfaces, while the other nodes are placed inside the construction component. Five mass distribution classes are introduced in European Committee for Standardization (2017a), and are defined in function of the mass position inside the component, as follows: class I (mass concentrated on the internal side), class E (mass concentrated on the external side), class IE (mass divided over the internal and the external side), class D (equally distributed mass), and class M (mass concentrated inside). Each opaque building envelope component is assumed to belong to one of these classes. The component total areal heat capacity is distributed over the R-C nodes according to the assumed mass distribution class, while fixed ratios of the total thermal resistances are associated to each internode conductance.

A more detailed approach for the opaque component discretisation into R-C nodes, which takes into account the thermal properties of the structure layers, is instead introduced in the Italian NA (Fig. 2) and validated by Mazzarella et al. (2020).

Differently from the standard method, the improved NA introduces a specific procedure for the definition of the R-C nodes number and their position inside the structure. According to the improved conduction model, each layer is discretised into at least one node, and the number of nodes in each layer (Ncn_i) is calculated through a comparison between the Fourier number for the layer (Fo_j) and a reference value (Fo_{ref}) assumed equal to 0,5, as defined in Eq. (1). A portion of the layer thickness (Δx_j), of the layer heat capacity ($\kappa_{pli,j}$), and of the layer thermal resistance ($R_{pli,j}$) is associated to each node, as defined in Eqs. (2), (3) and (4), respectively. Each node is placed in the middle of its

associated portion of the layer. As defined in Eq. (5), the definition of the internode conductance is performed considering half of the thermal resistances of the adjacent nodes.

$$Ncn_j = \max \left[1; \text{int} \left(\left(\frac{Fo_{ref}}{Fo_j} \right)^{\frac{1}{2}} + 0,999999 \right) \right] \quad (1)$$

$$\Delta x_j = \frac{d_j}{Ncn_j} \quad (2)$$

$$\kappa_{pli,j} = \rho_j \cdot c_j \cdot \Delta x_j \quad (3)$$

$$R_{pli,j} = \frac{\Delta x_j}{\lambda_j} \quad (4)$$

$$h_{pli,j} = \frac{1}{\frac{R_{pli-1,j}}{2} + \frac{R_{pli,j}}{2}} \quad (5)$$

2.2. Solar gains through windows (NA-Fw)

As far as the heat flow rate due to solar radiation entering into the zone through windows is concerned, both the European standard and the improved Italian NA methods assume the total transmitted solar radiation into the zone to be all short wavelength radiation. Throughout the simulation period, a weighted time average of total solar energy transmittance is assumed, calculated as reported in Eq. (6), where $g_{gl,n}$ is the total solar energy transmittance at normal incidence, and F_w is the correction factor that takes into account the angle dependence of g .

$$g_{gl} = F_w \cdot g_{gl,n} \quad (6)$$

The solar properties of the windows are considered time independent in EN ISO 52016-1, and the F_w factor is assumed constant and equal to 0,9. On the other hand, a solar angle dependent F_w

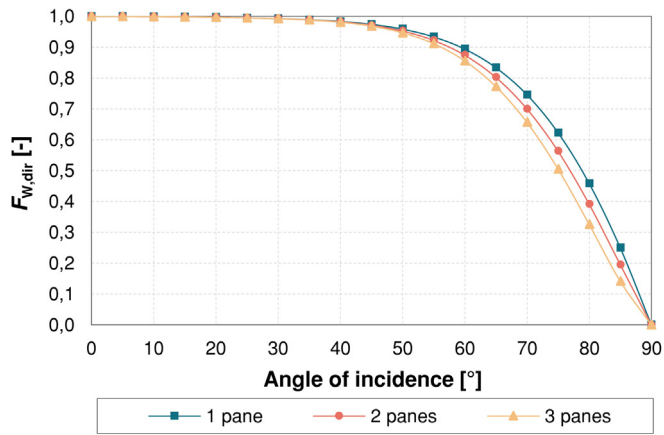

Fig. 3. Angle dependence of $F_{W,dir}$ for different glazings according to Karlsson and Roos formulation (Karlsson and Roos, 2000).

is considered in the Italian NA, and it is calculated according to Eq. (7),

$$F_W = \frac{F_{W,diff} \cdot I_{sol,diff,t} + F_{W,dir} \cdot I_{sol,dir,t} \cdot F_{sh,obst,t}}{I_{sol,diff,t} + I_{sol,dir,t} \cdot F_{sh,obst,t}} \quad (7)$$

where, $F_{W,diff}$ and $F_{W,dir}$ are the correction factors, respectively, for the diffuse and for the beam incident solar irradiance on a window, $I_{sol,diff,t}$ and $I_{sol,dir,t}$ are, respectively, the diffuse and the beam incident solar irradiance at timestep t , and $F_{sh,obst,t}$ is the reduction factor for the beam incident solar irradiance due to external obstacles at timestep t . The $F_{W,diff}$ correction factor is assumed equal to 0,8 over the calculation period, while the $F_{W,dir}$ correction factor is calculated on a time-step basis according to the empirical model introduced by Karlsson and Roos (2000). According to this formulation, the $F_{W,dir}$ depends on the angle of incidence of beam incidence solar irradiance, and on the type of glazing considered (number of panes). The solar-angle dependence of the correction factor is presented in Fig. 3 for a single glazing (1 pane), a double- (2 panes) and a triple-glazed unit (3 panes).

2.3. Extra thermal radiation to the sky (NA-Sky)

The longwave radiation heat transfer between a surface and the sky is considered in both the European standard and the improved Italian NA models by means of the extra thermal radiation to the sky (Φ_{sky}), as follows (Eq. (8)),

$$\Phi_{sky} = F_{sky} \cdot h_{re} \cdot \Delta\theta_{sky} \quad (8)$$

where, F_{sky} is the surface view factor to the sky, h_{re} is the external radiative surface heat transfer coefficient, and $\Delta\theta_{sky}$ is the difference between the outdoor air temperature and the apparent sky temperature. The apparent sky temperature is determined by applying a direct model (Evangelisti et al., 2019) in both methods. A direct correlation between the air and the sky temperature is considered in the standard method; in particular, a constant difference between the apparent sky and the air temperatures is assumed (European Committee for Standardization, 2017a). Referring to an intermediate climatic zone, the difference between the outdoor air temperature and the apparent sky temperature is assumed to be equal to 11 °C. On the other hand, the Italian NA proposes a correlation based on the partial pressure of water vapour (Aubinet, 1994). The apparent sky temperature is calculated as in Eq. (9), where $p_{v,e}$ is the partial pressure of water vapour (Pa).

$$\theta_{sky} = 18 - 51,6 \cdot e^{-p_{v,e}/1000} \quad (9)$$

2.4. Coupling of thermally conditioned zones

The standard hourly method of EN ISO 52016-1 performs a multi-zone calculation without thermal coupling between zones, i.e., it does not take into account any heat transfer between thermally conditioned zones, neither by thermal transmission nor by ventilation or infiltration. The heat transfer between conditioned zones is instead considered in the Italian NA. In particular, the heat flow through internal partitions between adjacent thermal zones is calculated by considering an equivalent thermal resistance and an outdoor surface temperature (seen from the thermal zone being calculated) for each partition. As for the air flow exchange, if the air flow is considered to pass from a thermal zone “A” to a thermal zone “B” (mono-directional air flow), the calculation is done first for zone “A”, then its air temperature is used to solve the thermal balance of zone “B”. If instead the air flow is considered to be bi-directional, zone “A” and “B” are assumed to be a single thermal zone.

3. Materials and methods

3.1. Methodology workflow

A case-study approach was used to facilitate the achievement of the research goals. The methodology applied is based on a first phase, consisting in the comparison between the EN ISO 52016-1 standard method and a full detailed dynamic calculation model, and a second phase in which the effect of the improved options introduced by the Italian National Annex is evaluated.

The calculation model comparison phase consists in the creation of a full detailed dynamic energy model, by means of the EnergyPlus (U.S. Department of Energy, 2022a) calculation engine, and an energy model implementing the EN ISO 52016-1 standard method for the considered case study. A set of consistency options are applied to both models to make their results comparable, as described in Section 3.3. Then, the results in terms of thermal energy needs for space heating and cooling are compared. In particular, the percentage variation of the monthly and/or annual energy needs is evaluated. Although the comparison of the EN ISO 52016-1 hourly method with the full detailed dynamic model of EnergyPlus is not the main focus of the present work, it is worth understanding the causes of deviation between the two models. For this reason, additional simulations are performed to evaluate the effect of specific modelling options or driving forces in reducing the deviations between the calculation models. The additional simulations performed for the considered case study are presented in Section 3.4.

In the second phase, each improved modelling options described in Section 2 (named with the IDs used, i.e., NA-Cond, NA- F_W , and NA-Sky) is implemented one-at-the-time to the energy model of the EN ISO 52016-1 standard method (which will be referred as “test models”), and the variation of the results of each simulation is assessed in comparison with the European EN ISO 52016-1 method (which will be referred as “standard model”) results. Moreover, a test model implementing all the NA improved methods is evaluated as well (named NA).

The simulations referred to the full detailed dynamic model were performed through the Python applicative pyEp (pyEp 0.9.4.4, 2022), which implements the Ptolemy EnergyPlus’s external interface; the standard and the test model simulations were instead performed by means of the EPB Center Excel spreadsheet (EPB Center, 2022), which was modified and implemented for the sake of the current study.

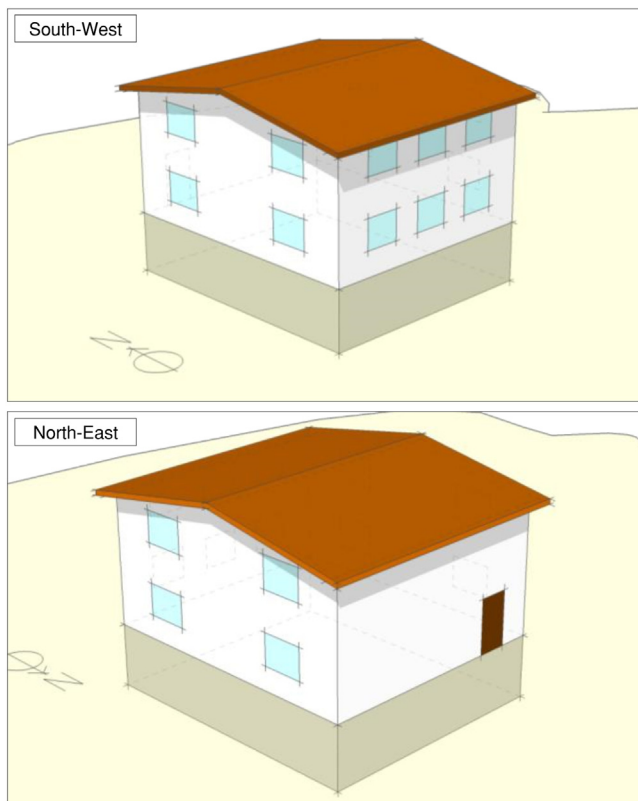

Fig. 4. 3D visualisation of the case study. South-West (upper) and North-East (lower) orientation.

3.2. Case study

The considered case study is an archetype of a two-storey single family, representative of the existing single-family house building stock in Northern Italy, built between 1977 and 1990 (Italian Ministry of Economic Development (MISE), 2018). It is characterised by two conditioned storeys, for a net floor area and volume of 198 m² and 537 m³, respectively, and an unconditioned basement (Fig. 4).

The East-, South- and West-oriented façades are characterised by windows for a total transparent surface of 7,6, 10,8 and 7,6 m², respectively. The North-oriented façade presents an opaque door of 2,4 m². The external vertical components are hollow-bricks walls with a partially insulated air-gap ($U_{\text{wall}} = 0,76 \text{ W m}^{-2} \text{ K}^{-1}$, $\kappa_{\text{wall}} = 256 \text{ kJ m}^{-2} \text{ K}^{-1}$), while the windows are characterised by a double glazing unit (DGU) with wooden frame ($U_{\text{W}} = 2,8 \text{ W m}^{-2} \text{ K}^{-1}$, $g = 0,75$). The opaque door is made of a double wooden panel ($U_{\text{door}} = 1,70 \text{ W m}^{-2} \text{ K}^{-1}$, $\kappa_{\text{door}} = 74 \text{ kJ m}^{-2} \text{ K}^{-1}$). As far as the horizontal components are concerned, the roof is a scarcely insulated pitched slab ($U_{\text{roof}} = 1,14 \text{ W m}^{-2} \text{ K}^{-1}$, $\kappa_{\text{roof}} = 270 \text{ kJ m}^{-2} \text{ K}^{-1}$), while the floor adjacent to the unconditioned basement is characterised a barely insulated slab ($U_{\text{floor}} = 0,98 \text{ W m}^{-2} \text{ K}^{-1}$, $\kappa_{\text{floor}} = 306 \text{ kJ m}^{-2} \text{ K}^{-1}$). The internal vertical partitions ($\kappa_{\text{wall,int}} = 120 \text{ kJ m}^{-2} \text{ K}^{-1}$) and the intermediate slab ($\kappa_{\text{floor,int}} = 306 \text{ kJ m}^{-2} \text{ K}^{-1}$) were modelled for the sake of internal mass. In the EN ISO 52016-1 energy models (standard and test model), the envelope components were assumed to belong to the I, E, and IE mass distribution classes, for the roof, the floor adjacent to the unconditioned basement, and the external walls, respectively. Neither external obstacles nor solar shading devices were considered. The building was modelled as a single thermal zone.

A standardised user behaviour regarding occupancy, heat gains and natural ventilation was considered. In particular, the scheduled hourly values were derived from the EN 16798-1 standard (European Committee for Standardization, 2019). A continuously operating heating and cooling system was considered to evaluate the thermal energy needs for heating and cooling of the case study. A dead-band thermostat set-point was assumed, equal to 20 °C and 26 °C for heating and cooling, respectively. The case study was supposed to be located in Milan (Northern Italy), and Palermo (Southern Italy). The evaluations were carried out using the International Weather for Energy Calculations (IWEC) data file (U.S. Department of Energy, 2022b) for the two cities.

3.3. Modelling consistency options

As introduced in Section 3.1, several consistency options were applied to the EnergyPlus simulation and to the EN ISO 52016-1 standard method as to make their results comparable. In particular, the applied consistency options are described as follows.

- Weather data. The IWEC data file (U.S. Department of Energy, 2022b) for the considered cities were used in both the EnergyPlus and the EN ISO 52016-1 energy models. The required weather data in the EN ISO 52016-1 model were derived from the EnergyPlus model, in terms of external dry bulb temperature and partial pressure of water vapour, as well as the direct and diffuse solar irradiance incident on each surface (orientation and tilt-angle), and incident solar angles.
- Convection and radiative fractions of internal heat sources. In all models, the heat flow from internal sources was assumed 40% convective and 60% radiative, while fully convective heating and cooling systems. In the EnergyPlus baseline model, the so called “Ideal Load Air System” (U.S. Department of Energy, 2020) was considered, while the so called “Basic System” (European Committee for Standardization, 2017a) was assumed in the standard and in the test models.
- Set-points temperatures. Heating and cooling set-points for all models are referred to the operative temperature.
- Internal partitions. In both models, the internal partitions were explicitly modelled in terms of exposed area. In particular, 314 and 198 m² exposed areas were considered for internal walls and floor, respectively.
- Furniture heat capacity applied to the air node. The standard value indicated in the EN ISO 52016-1 (10 kJ m⁻² K⁻¹) was modelled in the EnergyPlus tool by means of the “Zone Sensible Heat Capacity Multiplier Parameter” (U.S. Department of Energy, 2020).
- Temperatures of the unconditioned basement. In the EN ISO 52016-1 models, the effect of an adjacent unconditioned zone was taken into account by replacing the temperature of the outdoor environment by the temperature of the thermally unconditioned zone. For the determination of the basement temperature, a constant temperature adjustment factor (b_{ztu}) equal to 0,5 was assumed in the present work. For the sake of the consistency between the EN ISO 52016-1 models and the EnergyPlus model, in the latter the unconditioned zone was modelled by assuming a fictitious conditioned thermal zone characterised by adiabatic external envelope components, with the exception of the slab adjacent to the conditioned space. The temperature in the basement ($\theta_{ztu,t}$) at each calculation time-step was set by means of the EnergyPlus Energy Management System (U.S. Department of Energy, 2020), and it was calculated as specified in the EN ISO 52016-1 technical standard (European Committee for Standardization, 2017a),

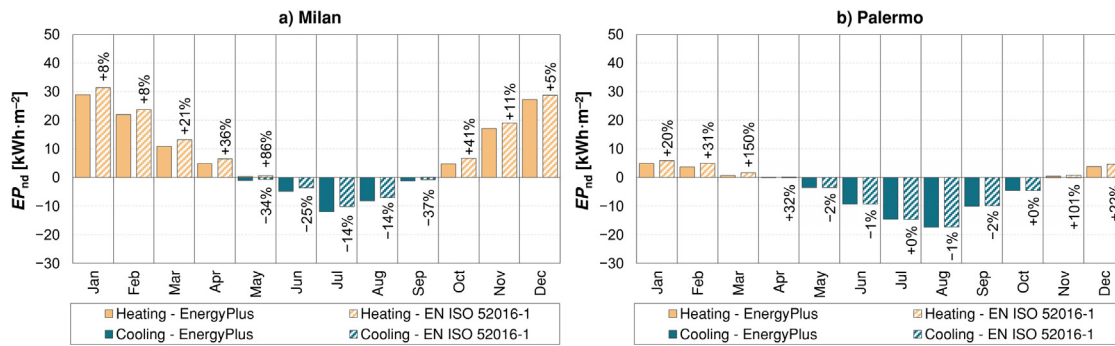

Fig. 5. Monthly thermal energy needs of the building from the standard and the full detailed model for Milan (a) and Palermo (b).

$$\theta_{z_{tu},t} = \theta_{\text{int,op,ztc},t-1} - b_{z_{tu}} \cdot (\theta_{\text{int,op,ztc},t-1} - \theta_{\text{ext},t}) \quad (10)$$

where, $\theta_{\text{int,op,ztc},t-1}$ is the operative temperature of the conditioned zone (at the previous timestep), $\theta_{\text{ext},t}$ is the outdoor air temperature, and $b_{z_{tu}}$ is the temperature adjustment factor. In both models, no heat gains were considered in the unconditioned zone, as well as no distinction was done between the air and the operative temperature.

3.4. Additional simulations for the calculation model comparison

As introduced in Section 3.1, different additional simulations were performed for understanding the causes of discrepancy between the EN ISO 52016–1 standard method and the full detailed dynamic method of EnergyPlus. These includes simulations in which different modelling parameters are made consistent between the two models, as well as simulations in which different driving forces are added or removed to analyse the effects related to their modelling. The considered additional simulations (named as “AddSim-*n*”) are briefly described as follows, and are summarised in Table 1.

1. AddSim-1: consistency between external convective heat transfer coefficients. The original EnergyPlus model is modified, and constant coefficients (h_c) are considered – derived from the EN ISO 6946 technical standard (European Committee for Standardization, 2018) and implemented in the standard model,
2. AddSim-2: consistency between internal convective heat transfer coefficients. As in the AddSim-1 simulation, constant coefficients (European Committee for Standardization, 2018) are implemented in the EnergyPlus model,
3. AddSim-3: consistency between external and internal convective heat transfer coefficients (AddSim-1 plus AddSim-2 simulations),
4. AddSim-4: consistency of the apparent sky temperature between models. The simplified determination of the apparent sky temperature of the EN ISO 52016–1 standard method is implemented in the EnergyPlus model,
5. AddSim-5: removal of solar radiation. To analyse the effect of the different modelling of solar absorption and solar gains, the solar radiation driving force is removed in both the EN ISO 52016–1 and the EnergyPlus model,
6. AddSim-6: removal of unconditioned thermal zones. The effect of the modelling of the unconditioned thermal zone is assessed by making the floor adjacent to the unconditioned thermal zone as an adiabatic component in both the models.

For AddSim-1, AddSim-2, AddSim-3 and AddSim-4, the related modified EnergyPlus models are compared to the original EN ISO 52016–1 standard model; for AddSim-5 and AddSim-6, the comparison is instead performed between the modified EnergyPlus and the modified standard models.

4. Results and discussions

4.1. Standard EN ISO 52016- 1 model vs. EnergyPlus

In the present section, the thermal energy needs for space heating and cooling resulting from the standard method are compared with the results of the full detailed dynamic method of EnergyPlus for the case study in Milan and in Palermo (Fig. 5). The EN ISO 52016-1 standard method generally tends to overestimate the thermal energy need for heating, with respect to the detailed model; on the other hand, the thermal energy need for cooling is generally lower. This trend is shown in both the Italian climatic zones. In winter months, the standard method overestimates the thermal energy need for heating of around 10% in Milan (e.g., 8% in January and February, and 6% in December), while higher values are reported in Palermo (e.g., 20%, 31% and 22% in January, February, and December, respectively). Higher discrepancies are instead reported in the mid-season months, both in Milan and Palermo. As far as the thermal energy need for cooling is concerned, a general underestimation of around 20% is reported in Milan. On the other hand, a good agreement between the standard and the full detailed method is reported for Palermo, on both a monthly and a yearly basis. In fact, the thermal energy needs for space cooling amount to 59,5 and 59,9 kWh m⁻² for the standard and the detailed method, respectively, with a percentage difference of -1%. A difference of 34% is reported instead for the space heating need on a yearly basis. As for Milan, the standard model overestimates the thermal energy need for heating by 12% (129,9 compared to 115,9 kWh m⁻²), while a -18% difference is reported for cooling (22,5 compared to 27,4 kWh m⁻²).

As introduced in Section 3.1, additional simulations (described in Section 3.4) were performed for the building in Milan to assess the causes of deviation between the EN ISO 52016–1 standard method and the full detailed dynamic model of EnergyPlus. The results of the considered simulations in terms of annual thermal energy needs for heating and cooling are reported in Table 2.

Among the considered simulations, the option that shows the highest effect to reduce deviation between results is the consistency of the convective external and internal heat transfer coefficients in both models (AddSim-3). This simulation leads to a good agreement between the models. In fact, the predicted energy need for heating increases in the EnergyPlus simulation (considering constant convective coefficient), while the cooling one decreases, achieving a difference of 1% and 27% for heating and cooling, respectively, compared to the standard model. In the same way, a good agreement between the two models was achieved by the contribution of the solar radiation incident on the opaque and transparent envelope components (AddSim-5). In fact, negligible differences result especially in the thermal energy needs for heating (-3% in Milan).

Table 1
Modifications applied to the energy models for comparison purposes.

Simulation ID	EnergyPlus model	EN ISO 52016-1 model
AddSim-1	Constant external $h_{c,s}$	None
AddSim-2	Constant internal $h_{c,s}$	None
AddSim-3	Constant external and internal $h_{c,s}$	None
AddSim-4	Constant difference between apparent sky and outdoor air temperatures	None
AddSim-5	No solar radiation	No solar radiation
AddSim-6	Adiabatic floor	Adiabatic floor

Table 2
Annual thermal energy needs for the additional simulation in Milan.

Simulation ID	Calculation method	$EP_{H,nd}$		$EP_{C,nd}$	
		(kWh m ⁻²)	(%) ^a	(kWh m ⁻²)	(%) ^a
AddSim-1	EnergyPlus model	129,0		16,7	
	EN ISO 52016-1 model	129,9	+1%	22,5	+35%
AddSim-2	EnergyPlus model	123,7		29,1	
	EN ISO 52016-1 model	129,9	+5%	22,5	-23%
AddSim-3	EnergyPlus model	130,6		17,7	
	EN ISO 52016-1 model	129,9	-1%	22,5	+27%
AddSim-4	EnergyPlus model	113,3		28,9	
	EN ISO 52016-1 model	129,9	+15%	22,5	-22%
AddSim-5	EnergyPlus model	188,4		0,0	
	EN ISO 52016-1 model	183,4	-3%	0,1	0
AddSim-6	EnergyPlus model	103,1		32,2	
	EN ISO 52016-1 model	107,9	+5%	25,8	-20%

^aPercentage variation of the EN ISO 52016-1 model compared to the EnergyPlus model.

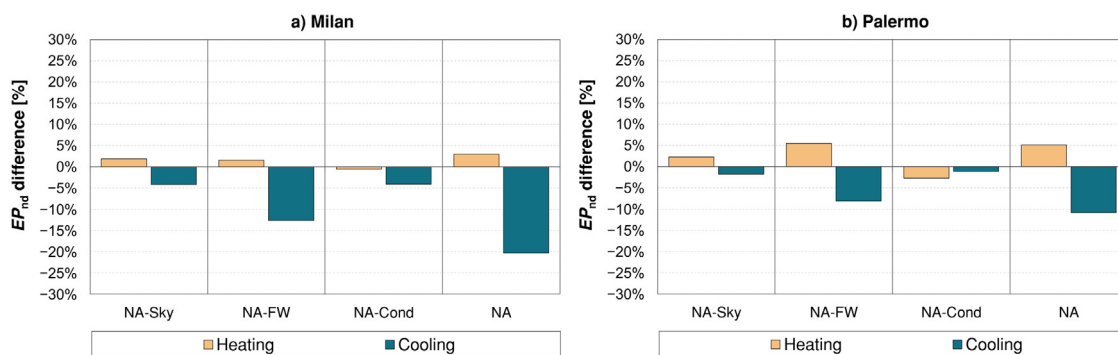

Fig. 6. Percentage variation of the thermal energy needs due to the implementation of the NA options compared to the EN ISO 52016 1 standard method for Milan (a) and Palermo (b).

4.2. Improved Italian NA options vs EN ISO 52016- 1 standard method

In the present section, the effects of the improved options introduced by the Italian NA are evaluated. In particular, the percentage variation of the thermal energy needs for heating and cooling due to the implementation of the improved methods compared to the original approach are presented in Fig. 6 for the considered case study in Milan and Palermo. Generally, the same trend of variation can be highlighted in both climatic zones, even if at different extents. Moreover, analysing each improved option, the use of a solar angle and time dependent correction factor for the determination of the total solar energy transmittance of glazing leads to the highest variation in the simulation results, while little variations are reported for the other improved methods.

As far as the determination of the apparent sky temperature is concerned (NA-Sky), the implementation of a correlation based on the partial pressure of water vapour leads to an increase of the thermal energy need for heating, and a decrease of the thermal energy need for cooling, in both climatic zones. In particular, the annual thermal energy needs for heating increase by 1,9%

and 2,3% in Milan and in Palermo, respectively; on the other hand, a higher variation is reported for the space cooling need in Milan (-4,2%). These variations in the annual thermal energy needs for space heating and cooling can be explained by analysing the profiles of the temperature differences between the apparent sky and the outdoor air, presented in Figs. 7 and 8, for Milan and Palermo, respectively. In particular, the green and the black lines represent the hourly temperature difference, respectively for the NA and the standard model; instead, the grey dashed line represents the annual average temperature difference for the NA model. As shown in the figures, the NA average difference between the apparent sky and the air temperature is higher than the reference value of 11 °C (i.e., equal to 13,2 °C for Milan, and 12,0 °C for Palermo), assumed in the EN ISO 52016-1 standard method. Thus, an increase in the temperature differences (so a decrease of the apparent sky temperatures) leads to an increase of the heat flux exchanged between the surfaces and the sky. Moreover, the higher difference between the apparent sky and the air temperature leads to higher variations in the results for the building in Milan than in Palermo.

Similar outcomes are reported for the correction factor of the total solar energy transmittance of glazing (NA-F_w). In fact, also

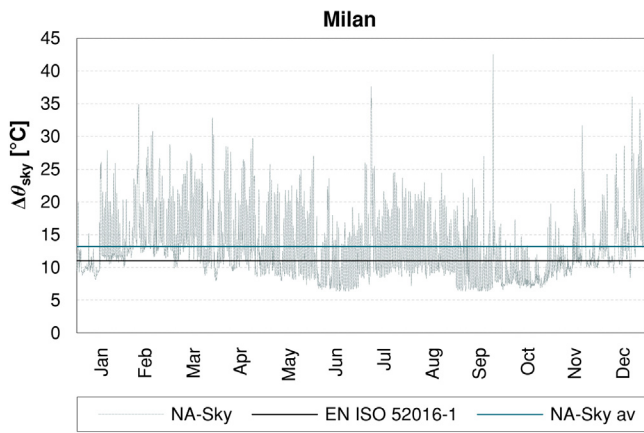

Fig. 7. Outdoor air and apparent sky temperature difference in Milan. (For interpretation of the references to colour in this figure legend, the reader is referred to the web version of this article.)

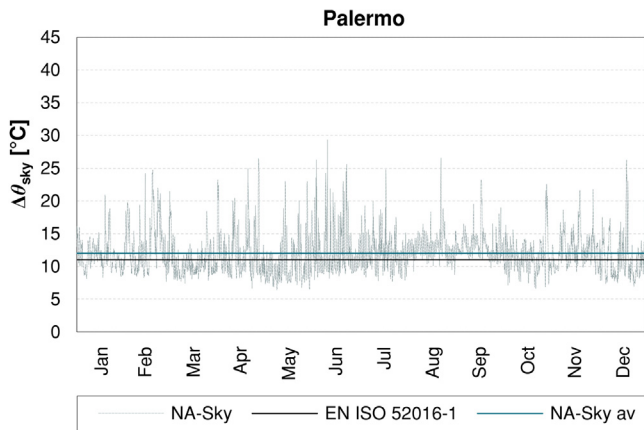

Fig. 8. Outdoor air and apparent sky temperature difference in Palermo. (For interpretation of the references to colour in this figure legend, the reader is referred to the web version of this article.)

in this case, the thermal energy needs for heating are subject to an increase with respect to the standard method, and a decrease is instead shown for cooling. Nevertheless, the extent of the variation due to the implementation of this improved method is the highest among the tested improvements. In fact, a decrease of 12,6% is reported for the thermal energy need for cooling in Milan, and of 8,1% in Palermo; the thermal energy needs for heating, instead, increase by 1,5 and 5,5%, in Milan and in Palermo, respectively. As for the NA-Sky test, these results can be explained by analysing the differences in the monthly average F_{W} correction factors between the standard and the improved method. In particular, the monthly average F_{W} values are reported in Figs. 9 and 10 for different orientations, respectively for Milan and Palermo. The Italian NA formulation entails the use of a F_{W} correction factor equal to 0,8 in absence of incident beam solar radiation on the windows, while a 0,9 reference value is assumed over the calculation period in the standard method. Instead, the F_{W} values in presence of beam incident solar radiation on the windows varies according to the window orientation, and to the climate zone. In Milan, the monthly average F_{W} values are lower than the 0,9 reference value over the whole year for all orientations, except for the South-oriented windows. For this orientation, the monthly average values for the correction factors are close to the reference value in the winter months (e.g., the F_{W} average values are equal

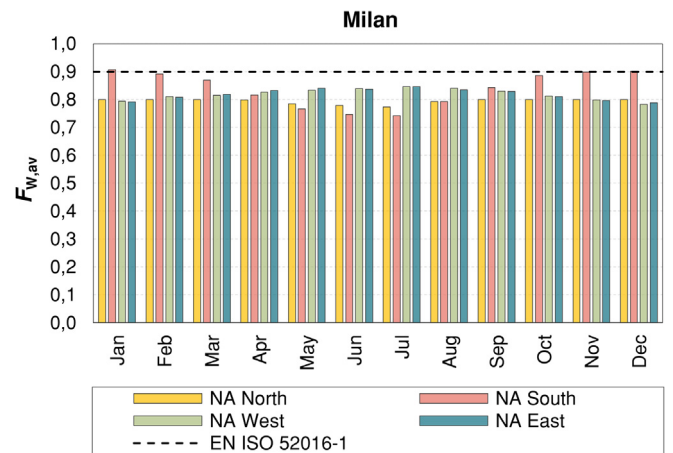

Fig. 9. Monthly average correction factor of the total solar energy transmittance (F_{W}) for different exposures in Milan.

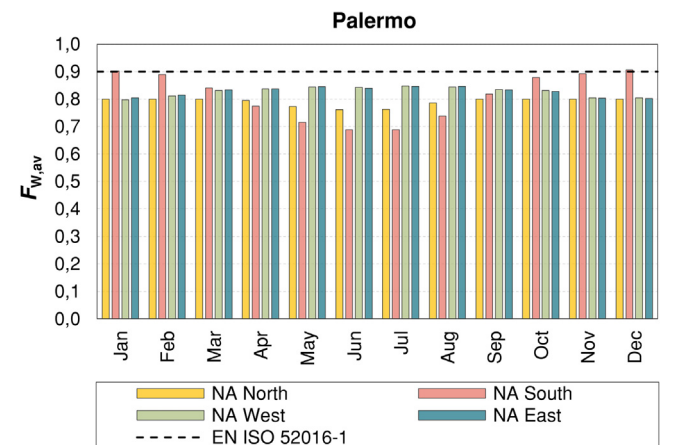

Fig. 10. Monthly average correction factor of the total solar energy transmittance (F_{W}) for different exposures in Palermo.

to 0,91 in January, 0,89 in February, and to 0,90 in November and December), while consistently lower values are reached in the summer months (e.g., 0,74 in July). For East- and West-oriented windows, the correction factors reach the maximum monthly average values in the summer months, specifically in July (equal to 0,85 for both East- and West-orientations), while values of around 0,80 are reported in the winter and intermediate months. The same trend of the F_{W} correction factors monthly average can be highlighted in Palermo, even if lower values with respect to what is reported for Milan. Thus, these trends lead to the reported increases in the thermal energy needs for space heating and decreases in thermal energy needs for cooling. In fact, the NA formulation leads to an underrating of the solar heat gains with respect to the standard method (lower F_{W} values).

A general opposite trend is highlighted for the implementation of the improved conduction model (NA-Cond). This in fact leads to decreases in the thermal energy needs for both heating and cooling. Nevertheless, almost negligible variations are reported in the thermal energy needs for heating in Milan (-0,5%), and in the thermal energy needs for cooling in Palermo (-1,1%). The variation in the thermal energy needs for cooling and for heating in Milan and Palermo are instead comparable with the results of the NA-Sky simulations.

Table 3
Computational time vs. thermal energy needs variation for Milan.

Simulation ID	Computational time		$ EP_{H,nd} \text{ variation} $	$ EP_{C,nd} \text{ variation} $
	(min)	(%)	(%)	(%)
Standard model	8,1	–	–	–
NA-Sky	8,9	+10%	2%	4%
NA-Fw	10,3	+27%	2%	13%
NA-Cond	29,8	+268%	1%	4%
NA	33,0	+307%	3%	20%

Finally, the implementation of all the improved options (NA) leads to considerable variation especially in the thermal energy needs for cooling (i.e., –20,3% and –10,8% in Milan and Palermo, respectively). Variations within 5% are instead reported for the thermal energy needs for heating in both climatic zones.

4.3. Computational time

In Section 4.2, the variation in the thermal energy needs due to the implementation of the improved Italian National Annex modelling options was assessed, and negligible variations were highlighted for some of the tested options. Thus, to correctly address the evaluation of the implementation of the proposed procedures it is worth understating their influence on the complexity of the calculation and on the computational time. Therefore, an analysis of the variation in the computational time is presented in Table 3 for Milan, compared to the absolute variation in the thermal energy needs for space heating and cooling. The NA-Sky simulation leads to negligible variations in both thermal energy needs (2% and 4% for space heating and cooling, respectively) and computational time (from 8,1 to 8,9 min). A moderate increase in the computational time is instead reported for the NA-Fw simulation (10,3 min, +27%); however, such an increase can be considered since it is linked to a consistent variation in the thermal energy needs, especially for space cooling (+13%). On the other hand, the NA-Cond simulation takes a consistently higher computational time (from 8,1 to 29,8 min, +268%) in the face of almost negligible variations in the thermal energy needs (lower than 4% for both space heating and cooling). Therefore, its implementation should be carefully evaluated in order to guarantee the simplicity of the assessment, as well as to avoid increases in the computational time. Lastly, the simulation characterised by all the NA options (i.e., NA) leads to higher variations in both computational time (mainly related to the implementation of the improved conduction model) and thermal energy needs.

5. Conclusions

In the present work, the main causes of deviation between the EN ISO 52016–1 hourly method and the full detailed dynamic method of EnergyPlus were investigated. Moreover, the improvements to the standard method introduced by the Italian National Annex were evaluated as well. For both analyses, the differences in the prediction of the thermal energy needs for heating and cooling were assessed for a residential building-type in two different Italian climatic zones. The main findings of the present research are presented as follows.

Concerning the comparison between the simplified and the full detailed method, the results highlighted a general overestimation of the thermal energy need for heating by the former method, while the thermal energy need for cooling are generally underestimated. To identify the possible causes of deviation between the two models, additional simulations were performed. From these analyses, the following considerations can be drawn.

- The use of constant surface heat transfer coefficients was detected as one of the main causes for the differences in the outcomes between the EN ISO 52016–1 model and the full detailed dynamic model of EnergyPlus. This result is consistent with the findings of other research studies, such as Ballarini et al. (2020) and De Luca et al. (Magni et al., 2022; De Luca et al., 2021c,b),
- The discrepancies between the simplified and the detailed method were also found to be influenced by the different modelling of solar heat gains, as previously stated by De Luca et al. (2019); however, this explanation should not be limited to the different modelling of the solar gains through windows, as it is also related to the modelling of the thermal capacity of the building.

With regard to the evaluation of the improved modelling options introduced by the Italian National Annex to EN ISO 52016–1 hourly method, it can be summarised that:

- The use of solar angle and time dependent correction factors for the total solar energy transmittance of glazing proved to be the most sensitive modelling option, among those analysed, on the thermal energy needs of the considered case study in both climatic zones. This finding complements the results of the existing works on this issue (Zakula et al., 2019, 2021; Magni et al., 2022).
- The other tested options, i.e., the apparent sky temperature determination by means of a correlation based on the partial pressure of water vapour, and a conduction model more in line with the physical characteristics of the layers composing the structure, showed little – or almost negligible – variations. Thus, the use of such detailed approaches should be evaluated to achieve a balance between the accuracy in the outcomes and the simplicity of the assessment in terms of both required input data and computational time. In fact, in the present research it was proven that the improved NA conduction model leads to significant increases in the computational effort in the face of a slight variation in the thermal energy needs. For the considered case study, the use of a more simplified approach may be thus preferable.

Since the Italian National Annex is currently under a drafting stage, the opportunity to expand the Italian NA should be addressed through the evaluation of other improved options. A particular focus should be placed on the aspects of the building energy performance assessment that proved to cause a decrease in the accuracy of the EN ISO 52016–1 hourly method, such as the use of constant heat transfer coefficients.

Future works will be focused on the evaluation of the effect of the Italian National Annex modelling options on other buildings; to assess whether the improved NA modelling options are appropriate for specific applications, different building uses, levels of thermal insulation, windows-to-wall ratios, etc., will be considered. Moreover, other improved options, such as a more detailed definition of the external convective heat transfer coefficients, will be assessed as well to increase the accuracy of the simplified EN ISO 52016–1 hourly method while guaranteeing the simplicity of the building energy performance assessment.

CRediT authorship contribution statement

Giovanna De Luca: Software, Formal analysis, Writing – original draft, Visualization. **Franz Bianco Mauthe Degerfeld:** Software, Formal analysis, Writing – original draft. **Ilaria Ballarini:** Conceptualization, Methodology, Validation, Writing – review & editing, Supervision. **Vincenzo Corrado:** Conceptualization, Methodology, Validation, Writing – review & editing, Supervision.

Declaration of competing interest

The authors declare that they have no known competing financial interests or personal relationships that could have appeared to influence the work reported in this paper.

Acknowledgement

The research for this paper was performed by implementing a tool developed by the EPB Center and made available within a cooperation agreement with the Department of Energy of Politecnico di Torino.

References

- Aubinet, M., 1994. Longwave sky radiation parametrizations. *Sol. Energy* 53 (2), 147–154.
- Ballarini, I., Costantino, A., Fabrizio, E., Corrado, V., 2020. A methodology to investigate the deviations between simple and detailed dynamic methods for the building energy performance assessment. *Energies* 13 (23), 6217.
- Bianco Mauthe Degerfeld, F., Ballarini, I., De Luca, G., Corrado, V., 2021. The application of the EN ISO 52016 standard and its Italian national annex to assess the heating and cooling needs of a reference office building. *E3S Web Conf.* 312, 06003.
- Bianco Mauthe Degerfeld, F., Ballarini, I., De Luca, G., P. Tootkaboni, M., Corrado, V., 2020. Sensitivity analysis of the thermal energy need of a residential building assessed by means of the EN ISO 52016 simplified dynamic method. *E3S Web Conf.* 197, 02012.
- Comitato Termotecnico Italiano, 2021. Draft of Italian national annex to EN ISO 15216-1. <https://www.cti2000.it/index.php?controller=documenti&action=schedaAllMsg&id=62539&tipodoc=4>, restricted document.
- De Luca, G., Bianco Mauthe Degerfeld, F., Ballarini, I., Corrado, V., 2021a. The effect of the external driving forces modelling on the calculated building energy need through the use of dynamic simulation. In: *Proceedings of Building Simulation 2021: 17th Conference of IBPSA. 1st–4th 2021, Brugge, Belgium.* (in press).
- De Luca, G., Bianco Mauthe Degerfeld, F., Ballarini, I., Corrado, V., 2021b. Accuracy of simplified modelling assumptions on external and internal driving forces in the building energy performance simulation. *Energies* 14 (20), 6841.
- De Luca, G., Bianco Mauthe Degerfeld, F., Ballarini, I., Corrado, V., 2021c. Validation of the simplified heat conduction model of EN ISO 52016-1. *J. Phys. Conf. Ser.* 2069 (1).
- De Luca, G., Tootkaboni, M.P., Ballarini, I., Corrado, V., 2019. Comparison between the EN ISO 52016-1 hourly calculation method and a fully detailed dynamic simulation. In: *Proceedings of Building Simulation Applications 2020, Bozen-Bolzano (South Tyrol, Italy), June (2019) 19–21*, pp. 291–298.
- EPB Center, <https://epb.center/>. (Accessed 8 January 2022).
- European Commission, 2010. Mandate M480, Mandate to CEN, CENELEC and ETSI for the elaboration and adoption of standards for a methodology calculating the integrated energy performance of buildings and promoting the energy efficiency of buildings, in accordance with the terms set in the recast of the Directive on the energy performance of buildings (2010/31/EU) of 14th 2010.
- European Committee for Standardization, 2014. Energy performance of buildings – Basic principles for the set of EPB standards (CEN/TS 16628).
- European Committee for Standardization, 2017a. Energy performance of buildings – energy needs for heating and cooling, internal temperatures and sensible and latent heat loads – Part 1: Calculation procedures (EN ISO 52016-1).
- European Committee for Standardization, 2017b. Energy performance of buildings – Sensible and latent heat loads and internal temperatures – Part 1: Generic calculation procedures (EN ISO 52017-1).
- European Committee for Standardization, 2017c. Thermal performance of buildings – Transmission and ventilation heat transfer coefficients – Calculation method (EN ISO 13789).
- European Committee for Standardization, 2018. Building components and building elements – thermal resistance and thermal transmittance – calculation methods (EN ISO 6946).
- European Committee for Standardization, 2019. Energy performance of buildings – ventilation for buildings – Part 1: Indoor environmental input parameters for design and assessment of energy performance of buildings addressing indoor air quality, thermal environment, lighting and acoustics – module M1-6 (EN 16798-1).
- European Parliament, Council of the European Union, 2018. Directive (EU) 2018/844 of the European Parliament and of the Council of 30 2018 amending directive 2010/31/EU on the energy performance of buildings and directive 2012/27/EU on energy efficiency. *Off. J. Eur. Union* 2018, 156.
- Evangelisti, L., Guattari, C., Asdrubali, F., 2019. On the sky temperature models and their influence on buildings energy performance: A critical review. *Energy Build.* 183, 607–625.
- Italian Ministry of Economic Development (MiSE), 2018. Updating of the application of the calculation methodology to derive cost-optimal energy performance requirements (2010/31/EU directive, Art. 5), in Italian. In Italian.
- Karlsson, J., Roos, A., 2000. Modelling the angular behaviour of the total solar energy transmittance of windows. *Sol. Energy* 69 (4), 312–329.
- Magni, M., Ochs, F., Streicher, W., 2022. Comprehensive analysis of the influence of different building modelling approaches on the results and computational time using a crosscompared model as a reference. *Energy Build.* 259, 111859.
- Mazzarella, L., Scoccia, R., Colombo, P., Motta, M., 2020. Improvement of EN ISO 52016-1: 2017 hourly heat transfer through a wall assessment: The Italian national annex. *Energy Build.* 210, 109758.
- Palladino, D., Iatauro, D., Signoretti, P., 2021. Application of hourly dynamic method for nZEB buildings in Italian context: Analysis and comparisons in national calculation procedure framework. *E3S Web Conf.* 312, 02006.
- pyEp 0.9.4.4, 2022. Available online: <https://pypi.org/project/pyEp/>. (Accessed 8 January 2022).
- Summa, S., Remia, G., Di Perna, C., 2022. Comparative and sensitivity analysis of numerical methods for the discretization of opaque structures and parameters of glass components for EN ISO 52016-1. *Energies* 15, 1030.
- U.S. Department of Energy, 2020. EnergyPlus™ Version 9.4.0 Documentation: Engineering Reference. National Renewable Energy Laboratory, Golden, CO, USA.
- U.S. Department of Energy, 2022a. Energyplus™ version 9.4.0. <https://energyplus.net/>. (Accessed 8 January 2022).
- U.S. Department of Energy, 2022b. Energyplus weather data. <https://energyplus.net/weather>. (Accessed 8 January 2022).
- van Dijk, D., 2019. EN ISO 52016-1: The new International Standard to calculate building energy needs for heating and cooling, internal temperature and heating and cooling loads. In: *Proceedings of Building Simulation 2019: 16th Conference of IBPSA. Rome (Italy), September (2019) 1–4*, pp. 4061–4068.
- Van Dijk, D., Hogeling, J., 2019. The new EN ISO 52000 family of standards to assess the energy performance of buildings put in practice. *E3S Web Conf.* 111, 04047.
- Van Dijk, D., Spiekman, M., Hoes-Van Oeffelen, L., 2016. EPB standard EN ISO 52016: Calculation of the building's energy needs for heating and cooling, internal temperatures and heating and cooling load. *REHVA J.* May 2016, 18–22.
- Zakula, T., Badun, N., Ferdelji, N., Ugrina, I., 2021. Framework for the ISO 52016 standard accuracy prediction based on the in-depth sensitivity analysis. *Appl. Energy* 298, 117089.
- Zakula, T., Bagaric, M., Ferdelji, N., Milovanovic, B., Mudrinic, S., Ritosa, K., 2019. Comparison of dynamic simulations and the ISO 52016 standard for the assessment of building energy performance. *Appl. Energy* 254, 113553.