



University Institute of Lisbon

Department of Information Science and Technology

**Efficient Cloud-based
Cellular Planning Algorithms
for 3G and 4G Networks**

Rodrigo Ramalho de Lobato Cortesão

A Dissertation presented in partial fulfillment of the Requirements
for the Degree of
Master in Telecommunications and Computer Engineering

Supervisor

Prof. Dr. Pedro Joaquim Amaro Sebastião, Assistant Professor
ISCTE-IUL

Co-Supervisor

Prof. Dr. Lúcio Studer Ferreira, Assistant Professor
Universidade Lusíada de Lisboa

October 2019

Resumo

Nas implementações de redes móveis grande escala, o planeamento otimizado e rápido dos recursos de rádio é uma tarefa fundamental. Os serviços em *cloud* permitem a implementação eficiente e escalável de padrões e algoritmos. Nesta dissertação, é apresentado um sistema de planeamento baseado em *cloud* para redes 3G e 4G, fazendo recurso à Amazon Web Services (AWS) para implementação em *cloud*. Este sistema extrai dados de configuração e desempenho da rede, o que permite estimar com precisão a cobertura das células, identificar células vizinhas e planear de forma eficiente os *Scrambling Codes* (SC) em redes UMTS e *Physical Cell Identity* (PCI) em redes LTE. Este sistema está integrado no Metric, uma ferramenta de planeamento e monitorização de *Software-as-a-Service*, propriedade da Multivision, permitindo uma alocação fácil e eficiente dos recursos da rede.

A operação do sistema é demonstrada num pequeno cenário canónico para SCs, um pequeno cenário realista de um cluster de células pertencentes a uma rede LTE, onde se pretende planear os seus PCIs. O algoritmo executa um planeamento ótimo deste cluster em menos de 0,6 segundos. Para um cenário 3G realista com 12 484 células não planeadas, a alocação dos SCs é realizada com eficiência, levando menos de 8 segundos e garantindo que não existem colisões entre as células vizinhas de primeira ordem.

Palavras-chave: Cloud, SON, SC, PCI, Metric, Recursos, UMTS, LTE

Abstract

In mobile network deployments of growing size, the optimum and fast planning of radio resources are a key task. Cloud services enable efficient and scalable implementation of procedures and algorithms. In this dissertation, a cloud-based planning system for 3G and 4G networks is presented, using Amazon Web Services (AWS) for cloud implementation. It extracts configuration and performance data from the network, enabling to accurately estimate cells coverage, identify neighbouring cells and optimally plan Scrambling Codes (SC) in an UMTS network and Physical Cell Identity (PCI) in LTE networks. This system is integrated in a Software-as-a-Service monitoring and planning tool Metric, owned by Multivision, allowing for an easy and efficient allocation of the network resources.

The system operation is demonstrated in a small canonical scenario for SCs, a small realistic scenario of PCIs cluster planning, taking less than 0,6 seconds to perform the planning. For a realistic 3G scenario with 12 484 unplanned cells, the planning of SCs is efficiently achieved, taking less than 8 seconds, and guaranteeing no collisions between first order neighbouring cells.

Keywords: Cloud, SON, SC, PCI, Metric, Resources, UMTS, LTE

Acknowledgements

Firstly, I would like to thank Prof. Dr. Pedro Sebastião for introducing me to this new challenge, for the follow-up and trust he always showed in me. I also want to thank for all the advice given throughout the dissertation. To Prof. Dr. Lúcio Ferreira, I want to thank for the tireless support that he has always been available to provide. I want to thank for all the motivation and encouragement given throughout the project, as well as the constant involvement during the development of the dissertation.

To Multivision, I would like to thank for the availability, for the opportunity and contribution to this dissertation, in particular to Engineer Nuno Valente, who has always been available to discuss new ideas and provide technical knowledge, to give a broader and futuristic vision to the project and its needs.

I would like to thank my parents for all their support, not only during my academic career, but also throughout all stages of my life, for the love, strength and trust they have always placed in me.

I want to thank my girlfriend, Miriam Batista, for all the love she has always given me, all the help given in this past year, but especially for knowing that she will always be my safe haven. I want to thank you for all the patience and dedication you have with me. All the love and affection you give me, I hope you feel it in return.

To my colleagues António Raimundo, João Martins, Mariana Barros, João Monge and João Pavia I want to thank for all the companionship and help you gave me. In particular, I want to thank Daniel Fernandes for all the support he has given me, not only throughout my academic career but also for his friendship.

To my longtime friends, I want to thank for all your friendship, trust and support.

This work is part of the OptiNET-5G project, co-funded by CENTRO2020/Portugal2020/ European Union (project 023304).

Contents

Resumo	iii
Abstract	v
Acknowledgements	vii
List of Figures	xiii
List of Algorithms	xv
Symbols	xviii
Abbreviations	xxi
1 Introduction	1
1.1 Motivation and Context	1
1.2 Objectives	2
1.3 Research Questions	2
1.4 Main contributions	3
1.5 Organization of the document	4
2 State of the Art	5
2.1 UMTS	6
2.1.1 System Architecture	6
2.1.2 Radio Interface	7
2.1.3 Physical Layer	7
2.1.3.1 Transport Channels Mapping	8
2.1.3.2 Spreading and Modulation	8
2.1.4 Services	10
2.2 LTE	11
2.2.1 System Architecture	11
2.2.2 Radio Interface	11
2.2.3 Physical Layer	12
2.2.4 Transport Channels Mapping and Modulation	13
2.2.5 Services	14
2.3 Radio Resource Management	14

2.3.1	Cellular Networks	14
2.3.2	Neighbours Definition	16
2.3.3	Collisions and confusions	17
2.3.4	Scrambling Codes	18
2.3.5	Physical Cell Identity	20
2.3.5.1	Physical Channels and Signals	21
2.3.6	Radio Resource Allocation	25
2.3.7	Related Work	26
2.4	Networks Management	27
2.4.1	Self Organized Networks	27
2.4.2	Tools	28
2.4.3	Metric	29
2.4.4	Cloud Services	33
3	Efficient Planning Algorithms	35
3.1	Network Architecture and Planning Pattern	35
3.2	Neighbours Identification	38
3.2.1	Geographical Identification of Neighbours	38
3.2.2	Coverage-based Identification of Neighbours	39
3.3	Planning of 3G Radio Resources	41
3.3.1	Overview	41
3.3.2	Scrambling Codes Planning Algorithm	42
3.4	Planning of 4G Radio Resources	46
3.4.1	Overview	46
3.4.2	Physical Cell Identity Planning Algorithm	47
3.5	Evaluation Metrics	50
4	Implementation and Integration	53
4.1	Implementation using cloud AWS	53
4.1.1	Used Technologies	53
4.1.2	Work Pattern	54
4.2	Integration in Metric	57
5	Scenarios and Results	59
5.1	Evaluation Scenarios	59
5.1.1	3G Canonical Scenario	59
5.1.2	3G Realistic Scenario	61
5.1.3	LTE Canonical Scenario	62
5.2	Results and Discussion	63
5.2.1	3G Planning Results for Canonical Scenario	63
5.2.2	3G Planning Results for the Realistic Scenario	66
5.2.3	LTE Planning Results for the Canonical Scenario	68
5.2.4	Implementation discussion	69
6	Conclusions and Future Work	71

6.1	Main Conclusions	71
6.2	Future Work	72
	Appendices	81
A	Publications	83
A.1	Scrambling Code Planning for UMTS Cellular Networks, Conftele2019	85
A.2	Cloud-based Implementation of a SON Automatic Planning System: a proof-of-concept for UMTS, WPMC2019	90

List of Figures

2.1	UMTS Architecture	6
2.2	Transport Channels Mapping	8
2.3	Relation between scrambling and spreading	9
2.4	Channelisation tree	9
2.5	LTE architecture	12
2.6	Multiple access technologies frequency comparison.	12
2.7	Radio Access Network protocol architecture.	13
2.8	Downlink transport channels mapping to Physical Layer.	14
2.9	Uplink transport channels mapping to Physical Layer.	14
2.10	Types of cells.	15
2.11	Distance between cells.	16
2.12	Example of neighbourhood tiers.	16
2.13	Real network cells coverage.	17
2.14	Collision situation.	18
2.15	Confusion situation.	18
2.16	Scrambling codes set division.	19
2.17	Relation between scrambling and spreading.	19
2.18	Example of a 50% PCFICH collision for a 20MHz system.	23
2.19	Reference signal collisions.	24
2.20	SON cycle.	28
2.21	Metric layers.	30
2.22	Metric map environment.	31
2.23	Cloud services overview.	33
3.1	Planning Model.	36
3.2	Neighbourhood tiers.	40
3.3	Antennas propagation and example of neighbours interference.	41
3.4	SCs processing module.	42
3.5	PCIs processing module.	46
4.1	Cloud-base work pattern for cellular network monitoring and planning.	55
4.2	SC planning interface in Metric.	58
5.1	Layout of the 3G canonical scenario.	60
5.2	Part of the 3G realistic scenario.	62

List of Figures

5.3	LTE cluster scenario.	63
5.4	SC grouping per site.	66

List of Tables

2.1	Number of resource blocks per symbol depending on bandwidth. . .	22
2.2	Mobile communication network planning tools.	32
5.1	List of available SCs groups of two cells.	61
5.2	Client specifications.	61
5.3	Analysis of Evaluation Metrics for 3G Canonical Scenario.	66
5.4	Evaluation Metrics analysis for 3G Realistic Scenario.	67
5.5	Evaluation Metrics comparison for SQL implementation and developed system.	67
5.6	Analysis of Evaluation Metrics for 4G Canonical Scenario.	69

List of Algorithms

1	Division of cells by frequency	44
2	Definition of unavailable SCs	44
3	Find the best possible group of SCs for site	45
4	PCI interference calculation	48
5	Number of Collisions in 3G	50

Symbols

k	Resource Element Group
N_{RB}^{DL}	Number of resource blocks per symbol
N_{sc}^{RB}	Number of subcarriers per resource block
ϕ	Latitude
R	Earth radius
d	Distance
I_{PCI}	PCI Interference Level between two neighbours
I_{neigh}	Interference between two neighbours
C_{sum}	Number of collisions for PCI
I_{total}	Total interference between two neighbours
N_{3G_1st}	Number of collisions to 1 st order neighbours in 3G
N_{3G_2nd}	Number of collisions to 2 nd order neighbours in 3G
$N_{4G_collisions}$	Number of collisions in 4G
P_c	Percentage of collisions
T_{comp}	Required computation time

Abbreviations

1G	First Generation
2G	Second Generation
3G	Third Generation
3GPP	Third Generation Partnership Project
4G	Fourth Generation
5G	Fifth Generation
BS	Base Station
CDMA	Code Division Multiple Access
CM	Configuration Management
CN	Core Network
DL	DownLink
DQPSK	Dual Channel Phase Shift Keying (DQPSK)
DT	Drive Test
EPC	Evolved Packet Core
E-UTRAN	Evolved Universal Terrestrial Radio Access Network
ECGI	E-UTRAN Cell Global Identifier
FDD	Frequency Division Duplex
FDMA	Frequency Division Multiple Access
GGSN	Gateway General Packet Radio System Support Node
G-MSC	Gateway Mobile Switching Center
GPRS	General Packet Radio Service
GSM	Global System for Mobile Communications
HLR	Home Location Register
HSS	Home Subscriber Server

ISDN	I ntegrated S ervices D igital N etwork
LTE	L ong T erm E volution
MAC	M edium A ccess C ontrol
MS	M obile S tation
MSC	M obile S witching C enter
MME	M obility M anagement E ntity
OFDMA	O rthogonal F requency D ivision M ultiple A ccess
OVSF	O rthogonal V ariable S preading F actor
PCI	P hysical C ell I dentify
PDN-GW	P acket D ata N etwork G ateway
PLMN	P ublic L and M obile N etwork
PM	P erformance M anagement
PN	P ublic N etworks
PSC	P rimary S crambling C ode
PSS	P rimary S ynchronization S ignal
PSTN	P ublic S witched T elephone N etwork
QAM	Q uadrature A mplitude M odulation
QPSK	Q uadrature P hase S hift K eying
QoE	Q uality o f E xperience
RAN	R adio A ccess N etwork
RNC	R adio N etwork C ontroller
RNS	R adio N etwork S ubsystem
RRM	R adio R esource M anagement
RSI	R oot S equence I ndex
SaaS	S oftware a s a S ervice
SC	S crambling C odes
SC-FDMA	S ingle C arrier F requency D ivision M ultiple A ccess
SGSN	S erving G eneral P acket R adio S ervice S upport N ode
S-GW	S erving G ateway
SON	S elf O rganized N etwork
SSC	S econdary S crambling C ode

SSS	S econdary S ynchronization S ignal
TDD	T ime D ivision D uplex
TDMA	T ime D ivision M ultiple A ccess
TFCI	T ransport F ormat C ombination I ndicator
TFI	T ransport F ormat I ndicator
VBA	V isual B asic for A pplications
UE	U ser E quipment
UL	U p L ink
UMTS	U niversal M obile T elecommunications S ystem
USIM	U niversal S ubscriber I ntity M odule
UTRA	U MTS T errestrial R adio A ccess
UTRAN	U MTS T errestrial R adio A ccess N etwork
VoIP	V oice o ver I nternet P rotocol

Chapter 1

Introduction

1.1 Motivation and Context

The consumption of mobile data has been growing exponentially, leading to a considerable expansion of mobile communication networks infrastructures. For a correct operation of the network and to provide a good quality of service, as well as experience, it is necessary that telecommunications systems are in constant development.

This development means that the systems involved are becoming faster and more autonomous. Therefore, in the current context of the operation of third generation (3G) and fourth generation (4G) mobile communication networks, the constant optimization of existing models is essential, in order to bring the network planning and the reality that is lived closer. For this, it is necessary to maintain an efficient work of identification and detection in the network.

One of the challenges in network planning and maintenance is the correct allocation of Scrambling Codes (SC) in Universal Mobile Telecommunications System (UMTS) and Physical Cell Identity (PCI) in Long Term Evolution (LTE) without interference between cells. In collaboration with Multivision, this is the problem that is intended to be solved, creating metrics and implementation rules that do the planning of these codes and do not allow the overlap between them.

1.2 Objectives

This is a proposal that aims to optimize the planning and maintenance of the network, making it faster and more efficient, taking into account its needs. Using data such as the coverage area of the cells and the available codes, the best ones for each cell are calculated. This optimization aims to provide the best SCs and PCIs available on the network, minimizing collisions between cells, allowing to increase the speed with which the planning of UMTS and LTE telecommunications network is carried out. This allows to optimize resources, in this case the SCs and PCIs, providing the user a better quality of experience, which might increase profit.

These implementations aim to add ease and speed in the planning of SCs and PCIs in the network through implementation in Metric. Metric is a network planning and management tool created and marketed by Multivision (Portuguese SME in Telecom Business area). This, can also be used to optimize the network in order to find and solve errors in which cells overlap the codes, which leads to interference between cells.

1.3 Research Questions

- Which is the optimal allocation of SCs and PCIs to cells that minimizes the interference?
- Is it possible to reuse SCs and PCIs more closely if there are obstacles in the way (e.g., mountain, buildings, etc...)? Is it, therefore, possible to reduce the number of resources (SCs and PCIs) used?
- By reducing the minimum reuse distance of SCs, will it be possible to obtain a good planning without interference between cells?
- Is it necessary to replan the next cells when adding a new cell?
- Can we have a local solution for only the new cells to introduce (or replan)? Or do we need always to provide a new global solution?

1.4 Main contributions

The developed work, resulted in various contributions:

- Market-ready planning system integrated in Metric.
- Two published conference papers:
 - Scrambling Code Planning for UMTS Cellular Networks, in ConfTele 2019.
 - Cloud-based Implementation of a SON Automatic Planning System: a proof-of-concept for UMTS, in WPMC2019.
- One submitted journal paper for IEEAccess: Cloud-based Implementation of a SON Radio Resources Planning System for Mobile Networks and Integration in SaaS Metric.
- Contribution for deliverable:
 1. Multivision, "Módulos de otimização", Entregável D4.1, Projeto OptiNet5G, fev. 2019
 2. Multivision, "Funcionamento dos módulos de otimização", Entregável D4.2, Projeto OptiNet5G, fev. 2019
 3. Multivision, " Relatório de testes e avaliação de cada um dos módulos", Entregável D6.1, Projeto OptiNet5G, abr. 2019
 4. Multivision, " Relatório de testes e avaliação de integração dos módulos", Entregável D6.2, Projeto OptiNet5G, abr. 2019
 5. Multivision, " Teste e avaliação final e aceitação do protótipo produzido", Entregável D6.3, Projeto OptiNet5G, set. 2019

1.5 Organization of the document

1. The first chapter - **Introduction** - presents the motivation and the context for the choice of this dissertation, as well as the proposed objectives and the document organization.
2. The second chapter - **State of the Art** - starts by describing the UMTS and LTE systems, including the System Architecture, the Radio Interface and the Physical Layer, describing the Transport Channels Mapping and types of modulation used. The Radio Resource Management presented, describing Cellular Networks, defining Neighbours, Scrambling Codes and the Physical Cell Identity. An overview of existing planning tools for cellular networks is also presented and a detailed description of the Metric platform.
3. The third chapter - **Efficient Planning Algorithms**, presents the network architecture and the planning pattern of the developed system. The developed and used system to define neighbours in the network and the algorithms for the 3G and 4G radio resource planning are presented. Finally the evaluation metrics for the algorithms are presented.
4. The fourth chapter - **Implementation and Integration** - the used technologies for the implementation of the system are presented. The work pattern is described in more detail and the integration in Metric is specified.
5. The fifth chapter - **Scenarios and Results** - describes the evaluation scenarios for 3G and 4G networks and presents the results and discussion for the implementation.
6. The sixth chapter - **Conclusions and Future Work** - contains the final conclusions of this work and proposals for future work are presented.

Chapter 2

State of the Art

This chapter deals with the literature review of the key concepts of this dissertation. Mobile communication systems have been constantly evolving. The first generation (1G) of mobile communications was analogue, having as voice the main service. The second generation (2G) came with the need to give house to the exponential rise of mobile communication users, with a more efficient cellular technology. Global System for Mobile Communications (GSM), which is the 2G, had to meet some criteria, such as having a good speech quality, low operation and implementation costs and support for international roaming [1]. As the search for data services raised, the need for the 3G of mobile system, with higher throughput appeared. The fourth generation (4G) of mobile communication systems is an improvement to the prior, giving more speed, higher bandwidth and consequently more transmission rate and more quality of experience in several services. Finally, the fifth generation (5G) comes with the promess to make mobile communications even faster and also more reliable [2]. As this thesis focuses both on the 3G and 4G systems, a more detailed explanation about this systems is given in the following sections. In this chapter, the 3G and 4G networks are focused, as this are the ones affected by the work developed.

2.1 UMTS

2.1.1 System Architecture

Universal Mobile Telecommunication System (UMTS), developed by 3rd Generation Partnership Project (3GPP) represents the third generation of mobile communication systems. It allows a maximum data transfer of 2 Mbps.

In Figure 2.1 is observed the architecture of the UMTS system.

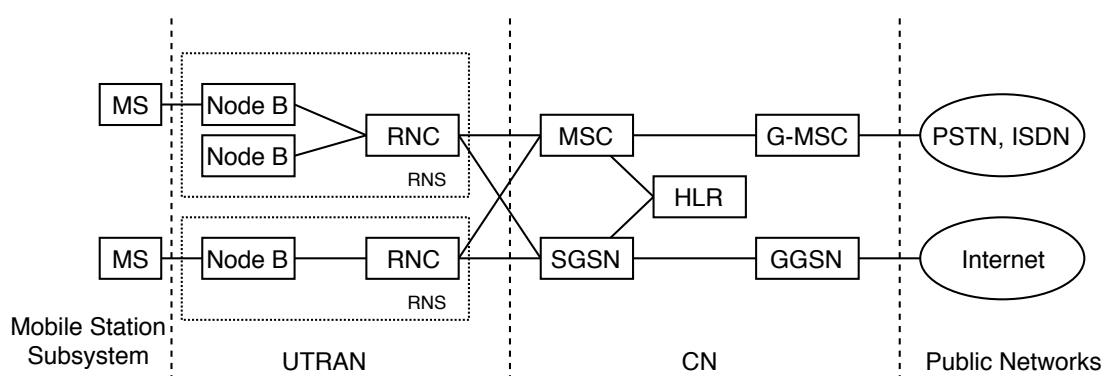

FIGURE 2.1: UMTS Architecture

UMTS introduces some new structures [3, 4, 5, 6]:

- **Public Networks (PN):** structure that has as its components the Public Switched Telephone Network (PSTN) and Integrated Services Digital Network (ISDN).
- **Core Network (CN):** structure that includes some elements previously known from GSM, those are Mobile Switching Center (MSC) and Home Location Register (HLR), but also introduces some new elements, such as Serving General Packet Radio Service Support Node (SGSN), with a function similar to MSC, but normally used for packet switching services. Gateway Mobile Switching Center (G-MSC) is the element that connects UMTS Public Land Mobile Network (PLMN) with public networks related to circuit switch connections, such as telephony services. Gateway General Packet

Radio System Support Node (GGSN) is similar to G-MSC, although it is related to services as packet data, having as an example the Internet.

- **UMTS Terrestrial Radio Access Network (UTRAN):** composed by one or more Radio Network Subsystem (RNS). Each RNS has as its elements, one Radio Network Controller (RNC) and one or more Node B. RNC controls the Mobile Station (MS) connections and the radio resources that are in its domain and Node B.
- **Mobile Station Subsystem:** composed by the Mobile Station (MS), which usually is the end-user device.

2.1.2 Radio Interface

UMTS uses Time Division Duplex (TDD) and Frequency Division Duplex (FDD) to ensure bidirectional communication.

In situations where it uses TDD, it guarantees multiple access through Frequency Division Multiple Access (FDMA) and Code Division Multiple Access (CDMA). When bi-directionality is guaranteed through FDD, multiple access is ensured by CDMA.

CDMA brings some benefits over the systems used in 3G networks. The main advantages are increased spectral efficiency using CDMA in conjunction with Quadrature Phase Shift Keying (QPSK) modulation, the fact that adjacent cells can use the same frequency, handover enhancements, and increased security [7, 8].

2.1.3 Physical Layer

The Physical Layer is one of the various elements that compose the UMTS system. This part of the system helps to distinguish cellular systems, it is completely different from the GSM physical layer as it uses CDMA instead of Time Division Multiple Access (TDMA) and distinct frequencies.

2.1.3.1 Transport Channels Mapping

Data is carried through the radio interface, so there is the need to map the data from transport channels to the physical channels. That is done by combining the Transport Format Indicator (TFI) from transport channels to the Transport Format Combination Indicator (TFCI) on the physical layer [3]. The transport channels mapping to physical channels may be observed in Figure 2.2.

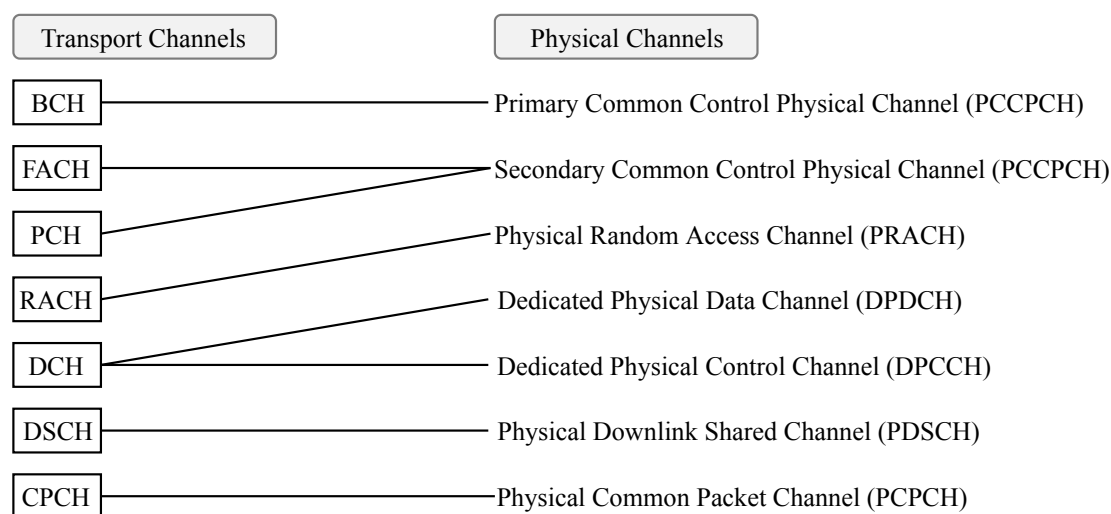

FIGURE 2.2: Transport Channels Mapping

2.1.3.2 Spreading and Modulation

In the process of signal transmission, an important part is the spreading. Part of the process of spreading is the channelization and scrambling. The main function of scrambling is to separate base stations or terminals from each other. In Figure 2.3 it is represented an example of spreading and despreading processes.

In UTRAN, transmissions that come from a single user are separated through channelisation codes. In the downlink (DL) it is used to distinct the many connections of a specified sector. In the uplink (UL) it has the objective of separate the various dedicated channels (physical and control channels). Channelisation codes are based on Orthogonal Variable Spreading Factor (OVSF). This codes are obtained from the channelisation tree, which can be observed in Figure 2.4. This process increases the transmission bandwidth [3].

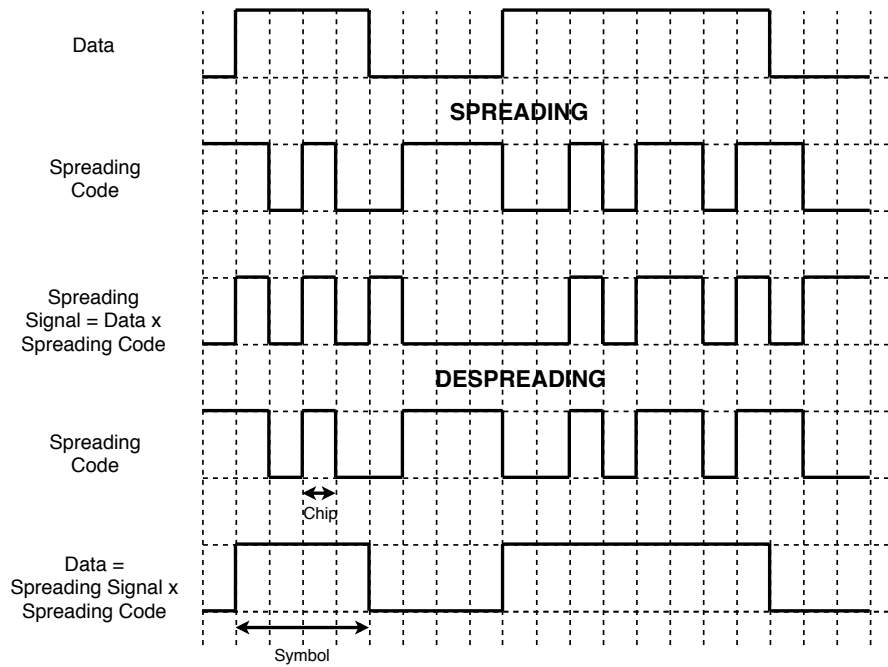

FIGURE 2.3: Relation between scrambling and spreading

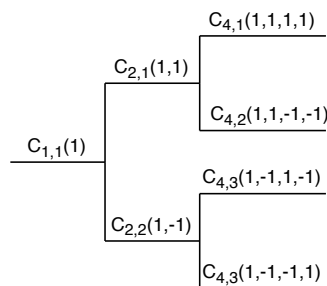

FIGURE 2.4: Channelisation tree

The modulation used on UMTS for downlink is QPSK with time-multiplexed control. The uplink uses two different Dual Channel Phase Shift Keying (DQPSK) to avoid interference on the audio service. This is accomplished by applying to the In-phase input the DQPSK modulator, the coded user data and controlling the encoded data with a distinct code to the quadrature input to the modulator [3].

There are two types of transport channels: Dedicated Transport Channels and Common Transport Channels. The Dedicated Transport Channels carry information of the actual service for a specified user and control information from higher layers. This channel bears soft handover and fast power control and has a high

rate of data exchange. There are six types of Common Transport Channels for UMTS Terrestrial Radio Access (UTRA). These channels do not support soft handover, although some might have fast power control. One example of a common transport channel is the Broadcast Channel and Forward Access Channel [3].

2.1.4 Services

Based on [3, 4] UMTS brought new features to communications and improved others that already existed. Some of the promises of UMTS were the 2 Mbps bit rate (in 3GPP Release of 1999) and 10 Mbps (in Release 5), this is on theoretical way, on practice these bit rates are lower. With higher bit rates, lower delays were also one of the promises and also the ability to have voice and data services simultaneously. Of course, the inter-operation with preexisting networks, such as GSM and GPRS were also one of the insurances given by 3GPP.

It is possible to divide UMTS services into three classes: person-to-person circuit switched services, person-to-person packet switched services and content-to-person services. Person-to-person circuit switched services, are speech and video telephony services. Although these start on circuit switched services, they can later be considered packet switched services. These services must have low delay, otherwise Quality of Experience (QoE) will degrade. Person-to-person packet switched services, include multimedia, Voice over Internet Protocol (VoIP) and multiplayer games. Although delay should remain low, here it is possible to divide services into categories. For example, in the case of multiplayer games, if it is a real time game, the delay must be very low, but if it is a strategy game where there is no immediate interaction with other users, delay requirements are more relaxed. Content-to-person services, such as, browsing, audio and video streaming and content download might require higher bit rates than some of the other services mentioned before.

2.2 LTE

2.2.1 System Architecture

Long Term Evolution (LTE) is the fourth generation of mobile communications systems. In Figure 2.5 it is represented the architecture of the LTE system. According to [9] this system has some new structures, comparing with the previous one:

- **Evolved Packet Core (EPC):** The main component of this structure is the Mobility Management Entity (MME), which makes the control of this structure. The Serving Gateway (S-GW) is responsible for packet routing and allocates its resources having MME requests as a basis. Home Subscriber Server (HSS) is the database that contains user data and subscriptions. Packet Data Network Gateway (PDN-GW) performs traffic filtering and gating activities and is the responsible for establishing communications between External Networks and the EPC.
- **Evolved Universal Terrestrial Radio Access Network (E-UTRAN):** This structure contains eNodeB, which is a radio base station that controls the radio related functions. Activities related to Radio Resource Management (RRM) and handover are also responsibility of eNodeB.
- **User Equipment:** It represents the user's device that is used for communications. Universal Subscriber Identity Module (USIM) is also part of this structure.

2.2.2 Radio Interface

In LTE, both TDD and FDD are used as duplexing modes, although in FDD mode it needs a channel separation in order to reduce the interference between the UL and the DL traffic [10]. In cases where two distinct carrier frequencies are used

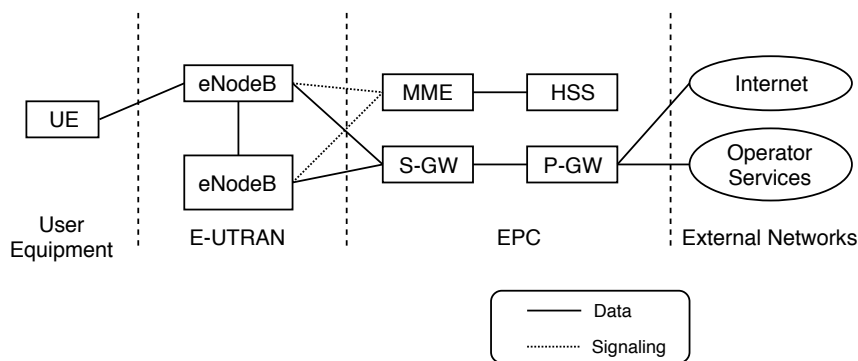

FIGURE 2.5: LTE architecture

for the DL and UL, the duplexing mode used is FDD, this way the eNodeB and the UE may transmit simultaneously.

The requirements and equipment of DL (from eNodeB to UE) and UL (from UE to eNodeB) services are different, therefore the technology used is also distinct. In DL, Orthogonal Frequency Division Multiple Access (OFDMA) is used to provide multiple access. In UL direction, Single-carrier Frequency Division Multiple Access (SC-FDMA) is the technology used to guarantee multiple access. The frequency domain allowed to improve spectral efficiency and minimize inter-symbol interference [11]. In Figure 2.6 it is possible to observe the two schemes of OFDMA DL and SC-FDMA UL, allowing to understand the frequency differences.

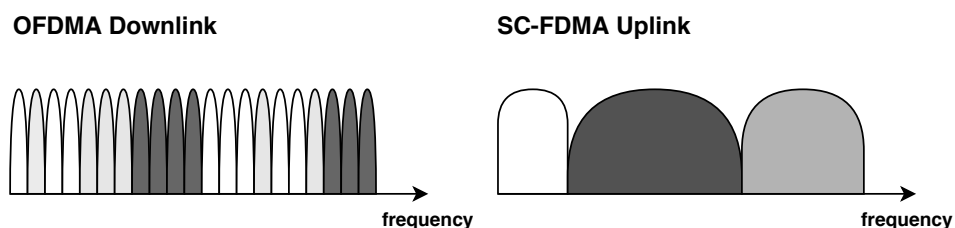

FIGURE 2.6: Multiple access technologies frequency comparison.

2.2.3 Physical Layer

As in UMTS, in LTE the Physical Layer is one of the crucial elements that are part of the LTE system. In Figure 2.7 it is possible to observe the protocol stack

in LTE and that the services provided by the Physical Layer come in form of a transport channel via the Medium Access Control (MAC) sub-layer. Some of the many functions of the Physical Layer are modulation and demodulation of physical channels and the transport channels mapping [12].

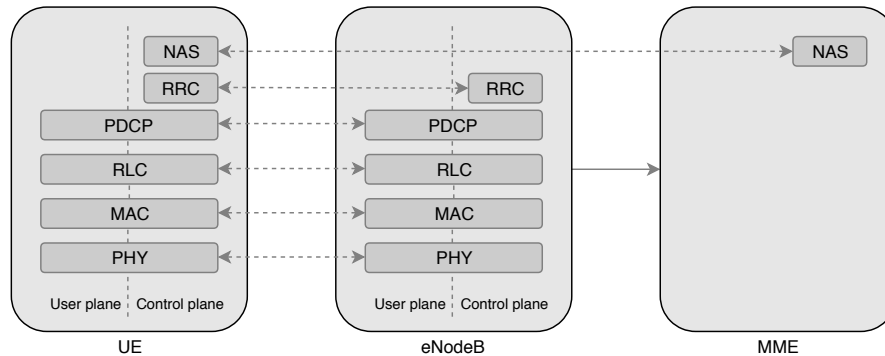

FIGURE 2.7: Radio Access Network protocol architecture.

The Physical Layer has also the duty to make the management of resources, by allocating shared resources [13].

2.2.4 Transport Channels Mapping and Modulation

In LTE, differently to UMTS, there is no Dedicated Channel as there are only common transport channels and these are what makes the articulation between the MAC layer and the Physical Layer. Each transport channel is mapped into the corresponding physical channel [12].

When the communication direction is downlink, the used physical channel is the Physical Downlink Shared Channel and the broadcast channel is mapped to the Physical Broadcast Channel. In the uplink direction, it is used the Physical Uplink Shared Channel and to carry the Random Access Channel, the Physical Random Access Channel is used [13]. The mapping from downlink transport channels to physical channels may be observed in Figure 2.8.

The mapping from uplink transport channels to physical channels is represented in Figure 2.9.

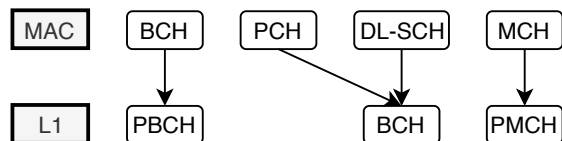

FIGURE 2.8: Downlink transport channels mapping to Physical Layer.

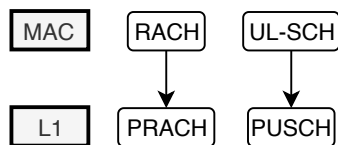

FIGURE 2.9: Uplink transport channels mapping to Physical Layer.

For the uplink and downlink physical channels, QPSK, 16 Quadrature Amplitude Modulation (QAM) and 64 QAM modulations can be used [14].

2.2.5 Services

In LTE systems, there is a greater focus on packet switching, which is one of the main characteristics of this system compared to previous ones. Thus, any voice service is supported by Voice over IP (VoIP). Initially LTE committed to provide transfer speeds of 100 Mbps. However, with the evolution to LTE-Advanced, it became possible to reach downlink speeds of 1 Gbps and a latency of 10 ms [15, 16].

2.3 Radio Resource Management

2.3.1 Cellular Networks

In a cellular network, a cell can be defined as the geographical area that is covered by a Base Station (BS) [17], therefore, a cell represents the geographical coverage of a BS. There are different types of cells and each of them has different coverage area, depending on the output and the environment where it is installed, for example in cities there are a lot of users and obstructions so it is necessary to have a larger number of BSs which cover a smaller area and in the countryside there are less users and less obstacles, so it is possible to have less BSs that cover a greater area.

The choice depends on the situation and on how many subscribers it is necessary to cover as each BS as limit of calls at the same time. If the BS is near that limit and a user starts a new call, it will hand off the mobile user to another BS that is in the users range. It is therefore important that the mobile device can clearly distinguish the different BSs that are within its reach [18]. In Figure 2.10 it is possible to observe a representation of the size of each type of outdoor cells.

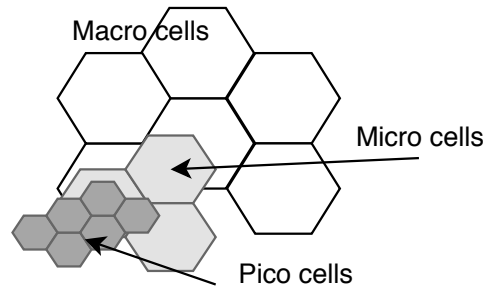

FIGURE 2.10: Types of cells.

The various types of cells and some of their characteristics are [18, 19]:

- **Macro Cells:** Also known as cover cells, these cells have a range between 5 km and 32 km. These are intended to provide coverage of large areas and are therefore required to be installed at a height where it has a range of vision for the area it must cover. They use lower frequencies in order to provide a larger service area. Usually used in suburban, city and rural areas.
- **Micro Cells:** These are known as capacity cells and have a range between 1 km and 2 km and aim to provide a higher signal strength. These are usually used in city blocks, shopping centers or temporary events.
- **Pico Cells:** These cells are normally used in high rise buildings, hotels or car parks. They have a reach of 0.1 km and a small capacity.
- **Fento Cells:** These are indoor cells for home or office use.

2.3.2 Neighbours Definition

The definition of neighbourhood can be made in various ways. The default distance approach to be considered neighbour defines that if any cell that is at the specified distance or closer to the base cell is considered neighbour. This is a simple approach, where there is only one list of neighbours for each cell. In Figure 2.11 two BSs are presented, each other belonging to a different cell, cell i and cell j . The radius of each cell is represented as R_i and R_j . If the distance (L_{ij}) is lower than the default distance, it is considered a neighbour [20].

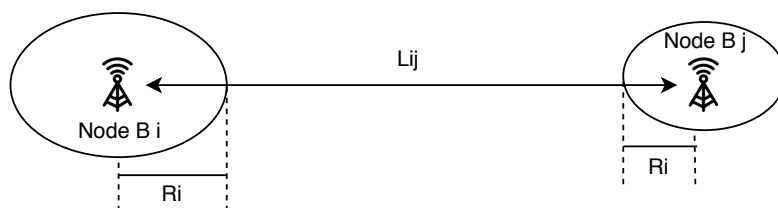

FIGURE 2.11: Distance between cells.

In Figure 2.12 the tiers method is illustrated. Although this method also only depends on the geography of the network, it is able to provide a more rigorous neighbours planning, being that it is possible to define levels of neighbourhood, by tiers, which are defined by distances.

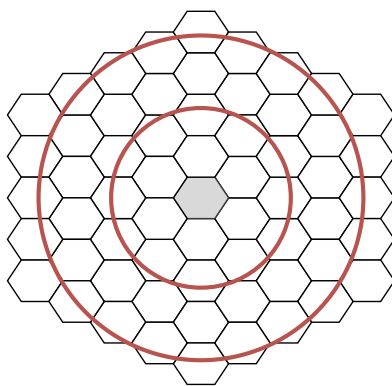

FIGURE 2.12: Example of neighbourhood tiers.

In Figure 2.12, these tiers are represented in red, the closest they are from the base cell (represented in grey), the more they are considered as interfering neighbours. Each tier, defines a specific order of neighbourhood, being that the tier closest to the base cell defines the 1st order neighbourhood. Therefore, in this

option, any cell inside the red circle is a neighbour of the base cell. Depending on the number of the tier, that is the order of the neighbour (i.e., if it is inside the first tier it is a first order neighbour and inside the second tier, a second order neighbour).

It is also possible to define neighbours in a more realistic way using the coverage of each cell [21], although it demands more processing capacity and time, as well as real network data. This is a more realistic approach as it uses real network data, antenna's information, as well calibrated propagation models to perform an accurate simulation of the cells reach. This method can only be used in networks that contain the necessary information (which does not always happen). In Figure 2.13, is represented a part of a real network cells coverage, extracted from Metric's algorithms.

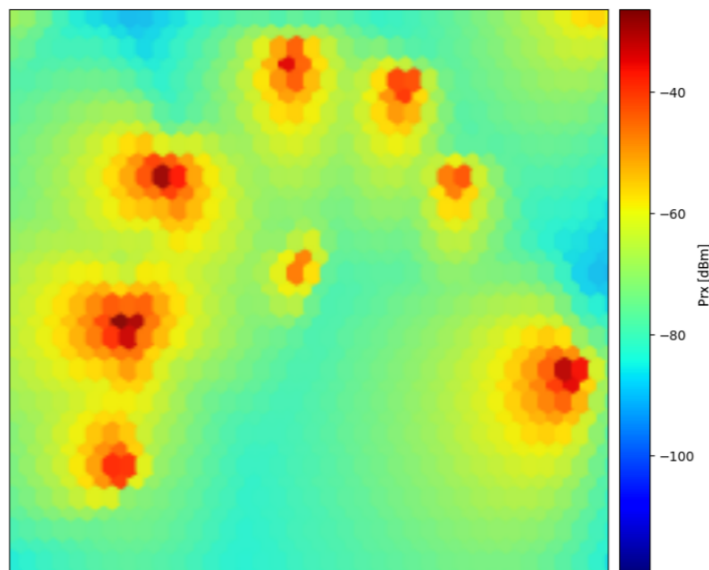

FIGURE 2.13: Real network cells coverage.

2.3.3 Collisions and confusions

A robust and precise identification of neighbours is necessary to avoid the most common problems that occurs in the planning of radio resources [22]:

- **Collision:** In a collision, two neighbouring cells with the same frequency share the same resource. An UE that is in one of the cells, does not know

which to communicate with. This may cause the handover to fail, interrupting the service. Figure 2.14 illustrates a collision.

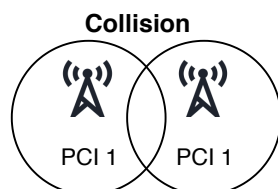

FIGURE 2.14: Collision situation.

- **Confusion:** Confusions happen when two neighbours of one cell share the same resource. This way, the serving cell is not able to clearly indicate to which cell the UE should be handed over. As in the situation of a collision, the service can also be interrupted. In Figure 2.15 is illustrated a situation of confusion.

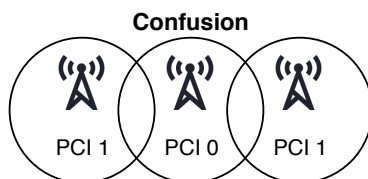

FIGURE 2.15: Confusion situation.

Therefore, the most important rule is to avoid collisions. Although in a real network it may be difficult, confusions should also be avoided.

2.3.4 Scrambling Codes

Scrambling Codes (SC) are a radio resource, which have the the function to make a distinction between different MSs or different BSs. In the uplink, long (38400 chips) and short (256 chips) codes are used and are assigned by higher layers and are responsible to distinct different MSs. In the downlink, only long scrambling codes are used, in order to separate different BSs from the point of view of the MSs. In the case of two channels, in the range of a MS, are using the same spreading code, it is strictly necessary for them to use different SCs, only this way the MS can

differentiate the two channels and choose the right receiver in the unscrambling process [23, 24].

According to [25] there are 8192 Primary Scrambling Codes (PSC) used, these are divided into 512 sets which means each set has 16 scrambling codes as can be seen in Figure 2.16. Each PSC has a set of Secondary Scrambling Codes (SSC) associated.

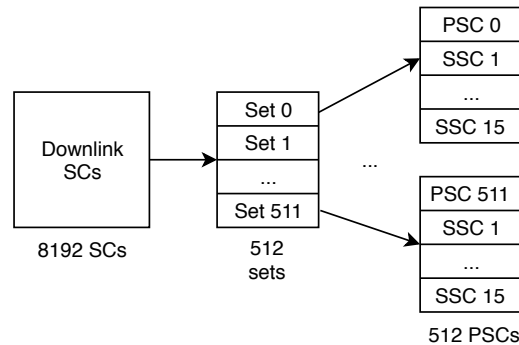

FIGURE 2.16: Scrambling codes set division.

Each BS in the cellular network must have an assigned PSC. In fact, the SSC may not be assigned as the PSC is the one that is fully required to transmit on some physical channels like Common Control Physical Channel. Therefore, most of the time planners do not consider SSCs. If the planning of SCs is done in an efficient way, cell search time is reduced and synchronization process too [14]. The scrambling process does not modify the signal bandwidth, making only the signals separable. As the chip rate is acquired in the channelization process, scrambling does not affect the symbol rate. In Figure 2.17 it is possible to observe how scrambling fits in the spreading process.

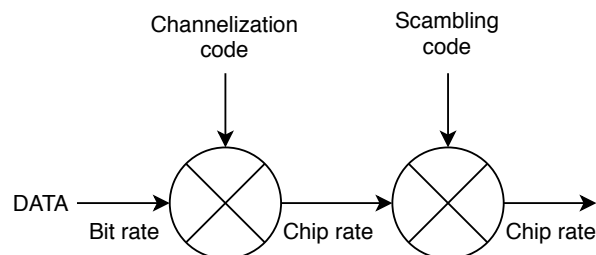

FIGURE 2.17: Relation between scrambling and spreading.

In DL, there are only 512 available PSCs and in the UL the 8192 PSCs are available for resource planning. The reason there are fewer in the DL direction is the cell search procedure, as it would become overly expensive [3] for MSs. In this dissertation, the focus is the planning of the DL PSCs, as these are the ones that require more careful planning. Therefore, PSCs are referred only as SCs. Since in this case the number of SCs is very limited, it is usual in urban environments to reuse SCs, so it is important to establish a reliable list of 1st and 2nd order neighbours, so that it is possible to avoid collisions.

2.3.5 Physical Cell Identity

In the LTE system there are three different types of identification among cells. In order to identify a cell within a certain network, the E-UTRAN Cell Identity (ECI) is used, the E-UTRAN Cell Global Identifier (ECGI) has the purpose to identify a cell anywhere in the world. Finally the Physical Cell Identity (PCI) is a key-value in the performance of the network as it is the responsible to distinguish a cell from its neighbours. A robust PCI planning is a key factor to have a healthy network that provides a good Quality of Service (QoS) to its clients, so PCI is a fundamental parameter for the correct configuration of an LTE radio network [26]. It can be seen as the cell identifier in the Physical Layer.

The PCI is a code number with values between 0 and 503 [27] and as in the SCs, it is used in the process of scrambling, in order to minimize, as much as possible, the interference between neighbouring cells by, for example, making the identification of cells during the handover [15]. The automatic configuration of PCIs, as well as the detection of new neighbouring cells, are a key part of the objectives proposed by the SON, described by the 3GPP. [28].

The PCI value can be deduced from the combination of the Primary Synchronization Signal (PSS) and the Secondary Synchronization Signal (SSS). The first has its value between 0 and 2, and the second between 0 and 167, which gives 504 possible combinations, as shown in Equation 2.1:

$$PCI = PSS + 3SSS \quad (2.1)$$

As this number is limited, it is required for the PCIs to be reused in the network. Therefore, due to its reusability, a PCI can not be seen as an unique identifier, for that purpose exists the ECGI. The reason why PCI is used instead of the ECGI is that ECGI comes with a higher complexity and time-consuming processing of its detection and decoding. As the SCs did in UMTS, the main function of PCIs is to separate base stations that transmit in the same frequency within the LTE system from the UE point of view [29].

2.3.5.1 Physical Channels and Signals

Regarding the LTE network planning, there are some channels and signals that directly interfere with resource management, more precisely with the allocation of PCIs. The channels that have the most influence or dependence are the downlink control channels [30]:

- Physical Control Format Indicator Channel (PCFICH): This channel is considered as one of the most important, as if the UE does not decode the PCFICH value, it will not be possible to decode some of the other channels. The PCFICH has the main function of informing the UE of the received signal format, indicating the number of OFDM symbols used by the Physical Downlink Control Channel (PDCCH). This is transmitted in the first OFDM symbol of each subframe and carries the Control Format Indicator (CFI). The sequence belonging to PCFICH value is mapped into four Resource Element Groups (REG). In order to make a correct mapping, the position of each of the REG is obtained as follows:

– REG (0):

$$k = \bar{k} \quad (2.2)$$

– REG (1):

$$k = \bar{k} + \lfloor \frac{N_{RB}^{DL}}{2} \rfloor \times \frac{N_{sc}^{RB}}{2} \quad (2.3)$$

– REG (2):

$$k = \bar{k} + \lfloor \frac{2N_{RB}^{DL}}{2} \rfloor \times \frac{N_{sc}^{RB}}{2} \quad (2.4)$$

– REG (3):

$$k = \bar{k} + \lfloor \frac{3N_{RB}^{DL}}{2} \rfloor \times \frac{N_{sc}^{RB}}{2} \quad (2.5)$$

where $\bar{k} = \frac{N_{sc}^{RB}}{2} \times (N_{ID}^{cell} \bmod 2N_{RB}^{DL})$, N_{sc}^{RB} represents the number of subcarriers per resource block, N_{ID}^{cell} is the PCI and N_{RB}^{DL} is the number of resource blocks per symbol, which depends on the system bandwidth. The possible values for N_{RB}^{DL} may be observed in Table 2.1.

Bandwidth (MHz)	N_{RB}^{DL}
1.4	6
3	15
5	25
10	50
15	75
20	100

TABLE 2.1: Number of resource blocks per symbol depending on bandwidth.

Therefore, it is possible to perceive that the position of the PCFICH depends directly on the bandwidth used by the system, as well as the value of the PCI. Thus, based on the value of \bar{k} , it can be stated that for a bandwidth of 20 Mhz, the value of PCFICH will overlap (at least partially) at intervals of 50 PCIs, while for a 10 Mhz bandwidth every 25 PCIs as illustrated in Figure 2.18.

- Physical Downlink Control Channel (PDCCH): The main function of this channel is to transmit the Downlink Control Information (DCI) to the UE, such as resource allocation for data on the Physical Downlink Shared Channel (PDSCH).

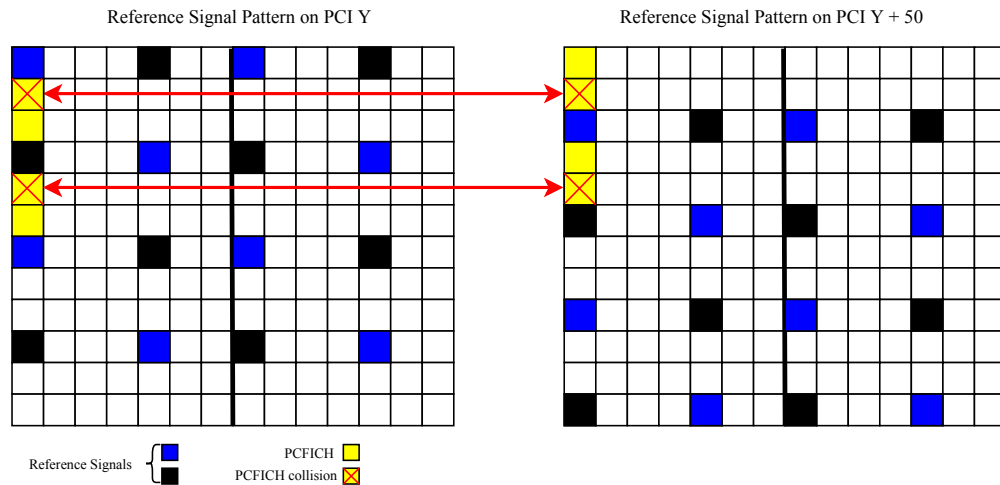

FIGURE 2.18: Example of a 50% PCFICH collision for a 20MHz system.

- Physical Hybrid ARQ Indicator Channel (PHICH): This channel carries the HARQ ACK / NACK signal, giving status information of the Hybrid ARQ, i.e., whether the transport block has been correctly received.

Focusing on the signals that have the greatest influence or dependence on the PCI value, these are also downlink:

- Cell-Specific Reference Signal (CRS): This signal has the main purpose of allowing a correct demodulation of the signal. This is possible by calculating the radio channel transfer function. This signal is used in the process of cell search and initial acquisition. Another function of the PCI is to provide information about the CRS location along the frequency axis, which has a direct influence on its position. It is therefore necessary to take into account, when planning PCIs, overlaps in CRS values (i.e. in their position), which may cause lower throughput. The CRS position is influenced by the PCI used on each cell [31]. It is important to know this position when planning the network cells PCIs to avoid collisions and possible losses in QoS, reducing the QoE. An example of a RS collision between two ports may be observed in Figure 2.19.

In order to avoid collisions in the reference signals, two neighboring cells must respect the following rules:

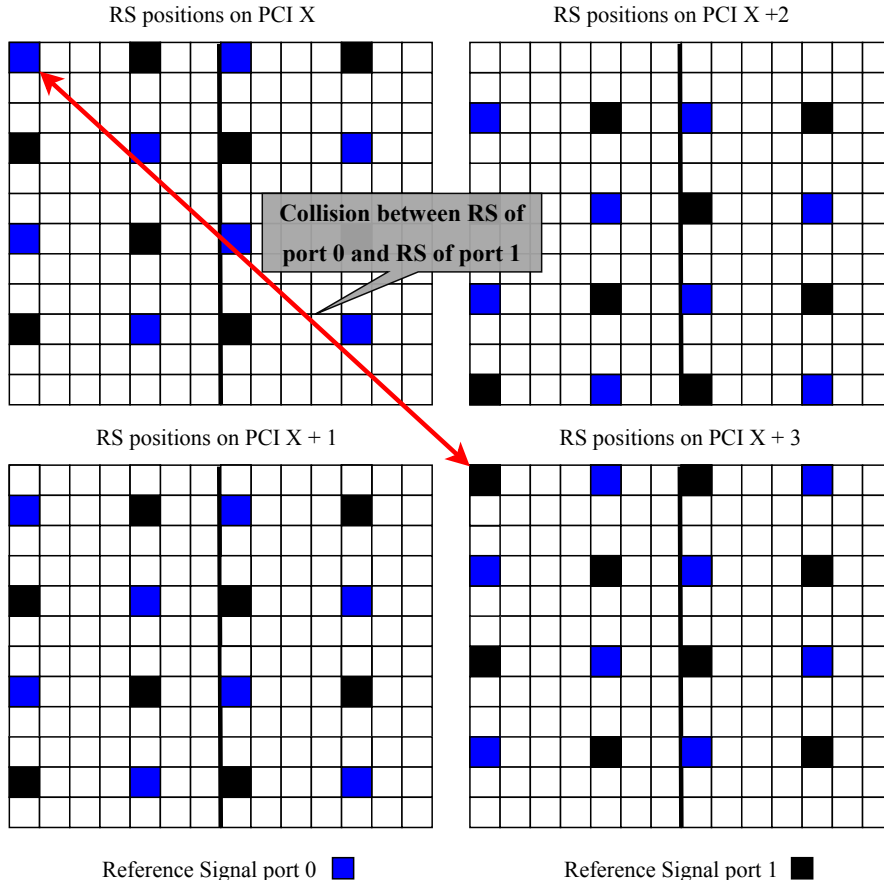

FIGURE 2.19: Reference signal collisions.

- **MOD3:** In downlink, for an interval of 3 PCIs, when using 2 or 4 antenna ports, there will be a collision in CRS position. Therefore, for adjacent cells, the frequency shift value, should be different:

$$v_{shift,i} = PCI_i \bmod 3 \quad (2.6)$$

- **MOD6:** This rule is applied the same way as the first, although it is used when only one antenna port is utilized. This way, for an interval of 6 PCIs, there will be a RS collision to be avoided between neighbours:

$$v_{shift,i} = PCI_i \bmod 6 \quad (2.7)$$

- **MOD30:** Just like in downlink, for each 3 or 6 PCIs there is a collision in the RS, in uplink, for each 30 PCIs, the RS pattern is the same:

$$v_{shift,i} = PCI_i \bmod 30 \quad (2.8)$$

This happens because the Physical Uplink Shared Channel (PUSCH) transports the Demodulation Reference Signal (DMRS) and this is built having basis in the Zadoff-Chu sequences, which are divided in groups of 30, existing 30 different base sequences that can be used. These sequences should differ between neighbours.

- **PSS:** This signal has the function of synchronizing frequency as well as time. It has values between 0 and 2.
- **SSS:** It is also responsibility of this signal to time synchronize as well as determine which mode, FDD or TDD, and the Cyclic Prefix (CP) to use. It has values between 0 and 167.

2.3.6 Radio Resource Allocation

The planning of radio resources might be performed in several ways, being only dependent on the one that performs it. That is, different network operators have different ways of making the PCI planning, giving different results as well. There are two main strategies:

- **Random planning:** In this type of planning there is not a specific grouping or strategy to allocate resources. A reuse pattern is also not followed.
- **Ordered planning:** This type of planning is mainly based on clusters, as neighbouring sites are grouped. In order to make the planning, the total of resources are also divided into specific groups and each cluster has a limited number of groups assigned. For each site a group of PCIs is used.

2.3.7 Related Work

There are network planning and optimization tools such as those mentioned in Section 2.4.2 that help in the configuration of the network, but not all of them perform the planning of SCs or PCIs, often being a process done manually, which brings errors and a high time spent. Huawei's GENEX U-Net Radio Planning Tool [32] is a tool that makes planning of SCs easier, however it is always necessary to manually configure some values such as the minimum reuse distance and other network limitations. There are also several algorithms for the planning of the network available in the literature. In [33], the algorithm is capable of allocating SCs by detecting collisions in two distinct forms: using the reuse distance to find neighbours and by avoiding the N^{th} tier neighbour SCs clashes. In the case this algorithm finds a collision, it assigns a new SC to that BS. This is an effective way to allocate SCs, although, this algorithm assigns random SCs to the cells, which in urban areas can cause errors. [20], proposes two types of SCs planning, through graph colouring and by cluster reuse. This is an interesting approach, although, this method showed that depending on the network characteristics, sometimes it is not able to plan SCs.

In [34], a PCI distribution system based on a query mechanism is presented. This method needs to receive a list of PCI and interact with the BS to get its list of neighbours. Through the developed processes it is able to assign PCI, having the disadvantage of requiring direct contact to the BS. In the paper [35], a graph coloring model is presented to formulate the assignment of PCIs. In [36], an algorithm is presented for situations where several femto cells are used in a short space, in order to avoid collisions and confusions in the distribution of PCIs.

2.4 Networks Management

2.4.1 Self Organized Networks

Telecommunications networks are becoming more complex as new technologies and generations of communication systems are introduced. It is therefore essential that it becomes increasingly easier to plan and maintain the network, such as its configuration and optimization. This is only possible by making the networks more autonomous, that is, without constant intervention by man. In this way, the concept of Self Organized Networks (SON) arises, where the objective is to facilitate all the previously mentioned processes, which brings several benefits to the operators [37]. SONs represent an important part of what BS functionalities are, making it possible to coordinate between BSs that previously not possible, making important automated configurations such as Cell ID, which was used to be done by professionals manually [38]. The main features that define a SON, according to [22, 26] are:

- **Self-Planning:** In this part the new nodes settings are performed (site location and hardware specifications). Other tasks are comprised in this part of the process, as selecting neighbour base stations and transport parameters.
- **Self-Deployment:** This category has the function to make the preparation, installation, authentication and verification of the new base stations on the network. Although this process demands some manual process, the goal of SON is to minimize this effort and make this deployment "Plug&Play".
- **Self-Optimization:** When the first planning of the network is made it is not always possible to predict if new sites will be deployed or if new buildings will be built nearby. This part of the process is a repetitive cycle, in order to detect problems and check the network performance. Radio parameter optimization (neighbour cells or interference control) and transport parameter optimization are some of the tasks of this category.

- **Self-Healing:** These are the daily tasks to maintain the network operational, including failure recovery and network monitoring.

In Figure 2.20 it is possible to observe the cycle of the various components that are part of a SON.

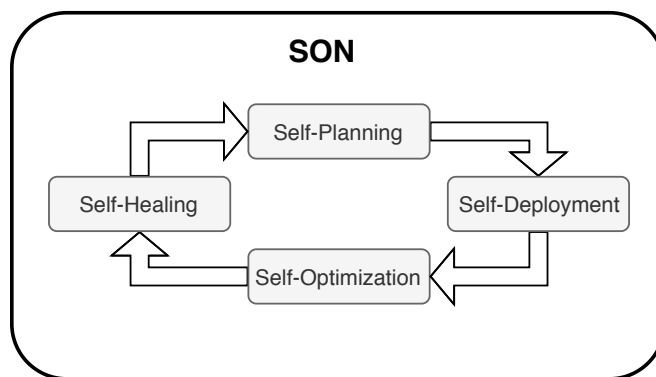

FIGURE 2.20: SON cycle.

2.4.2 Tools

The telecommunications industry is constantly evolving, bringing new tools with new features. Here, some of the tools currently available on the market for the management of mobile networks, are presented:

- **ASSET:** Property of TEOCO, is a radio planning tool that provides Radio Frequency (RF) coverage and capacity, and also neighbour planning for cellular networks [39].
- **Atoll:** Is a multi-technology platform by owned Forsk, developed for optimization and network design. It is possible to use predictions and live network data to help in the process of planning [40].
- **Capesso:** Also property of TEOCO, this is an automatic cell planning tool that delivers predictions and Drive Test (DT) data to provide a good source for optimization [41].

- **Excel:** Is a worksheet editor with a high calculation and graphic building capacity. Through Visual Basic for Applications (VBA) it is possible to provide better capacity to automated tasks [42].
- **Mentor:** A solution for Radio Access Network (RAN) analytics and optimization, providing geo-location algorithms and measurements [43].
- **XCAL:** Property of Accuver, this is a DT Tool that intends to, in real time, troubleshoot, monitor, maintain and optimize wireless voice and data network performance [44].
- **MUSA:** This planning tool was created to post-process DTs. With this tool it is possible to make the planning of PCI and Root Sequence Index (RSI) [45].

2.4.3 Metric

Metric [46] is owned by Multivision, is a (Software-as-a-Service) SaaS available commercially and is the planning tool that is intended to improve with the presented work. Metric is a SON solution for telecommunications networks. It is based in a pay-per-use and one-to-many model by the contracted costumers, based on one set of data definitions and common code. The way Metric operates can be divided in layers, as it is demonstrated in Figure 2.21.

This service has the main advantage of being delivered over the web, making it possible for users to access it through a wide variety of devices, fixed or mobile, taking collaboration to another level. Metric works with various technologies, such as 2G, 3G and 4G, being a multi-technology service and multi-data sources, all together in one environment. Data can be visualized in maps, tables or reports, failures are identified (for example cells overshooting or problems with neighbours lists), and it is also possible to upload data. All of this is possible by making use of proprietary algorithms implemented in Performance Management (PM), Configuration Management (CM) and DTs. The main goals of Metric are to ease the network management, optimization and the aggregation of data in a single

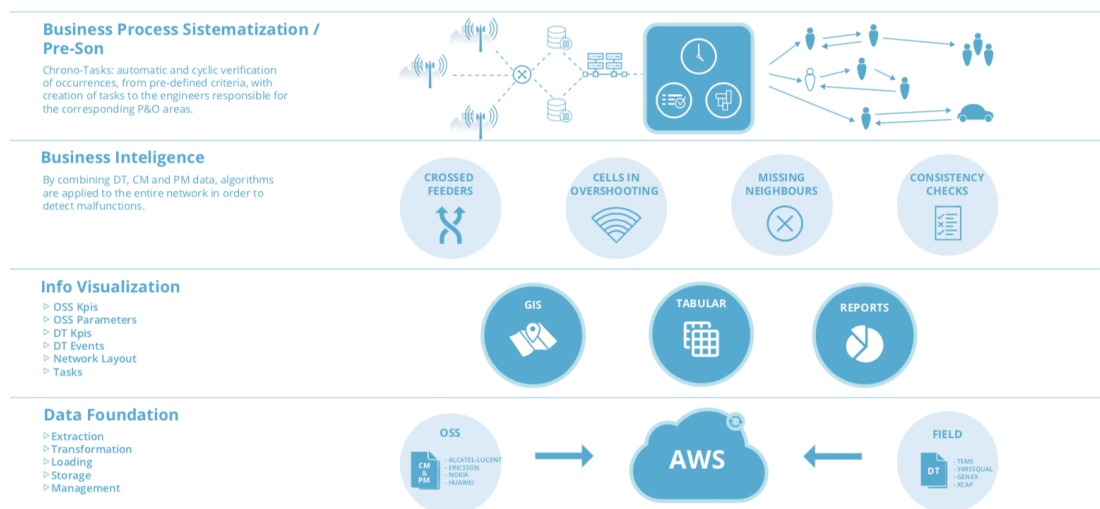

FIGURE 2.21: Metric layers.

platform, being that Metric is based on a set of distinct modules. Regarding the allocation of resources, only a previous SQL-based implementation of SC planning, which used only distances between cells to perform the planning (this was not implemented in Metric), was used to assist Metric whenever a client needed to plan its SCs. Regarding the planning of PCIs, Metric was not able to perform. Using Metric, the client only has to specify its requirements when planning the network for the first time. On a pay-per-use basis and in a one-to-many model by all contracted costumers, it is based on a set of data definitions and common code. This service is delivered over the web and it can be accessed by any fixed or mobile device. Some of the major benefits of this platform are:

- Lower costs;
- Frequent new features;
- Upgrades included;
- Non-technical configuration;
- Subscription-based payment method.

In Figure 2.22 is it possible to observe Metric map page. There are other environments where the user can work, each of them having specific purposes.

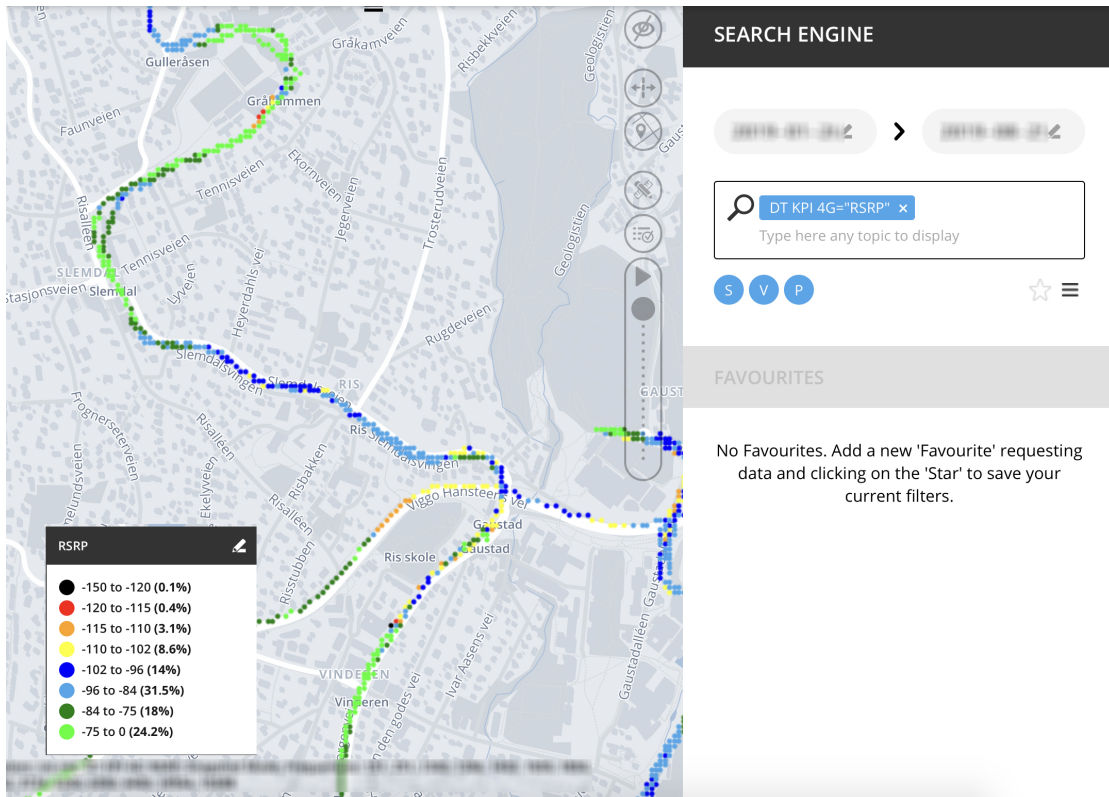

FIGURE 2.22: Metric map environment.

The already referred environments are:

- **Task Manager:** The main goal of this feature is to plan the daily tasks, by creating and assigning them. A summary of the tasks status is presented, giving a real time understanding of the team performance. For each user, an overview of how many tasks from each type are under his responsibility is shown. All tasks and corresponding interactions (comments, attachments) are registered and can be consulted at any time.
- **File manager:** From this feature, file managing is achievable, as information from the last 10 years is available. Data upload can be done automatically or manually. Using keywords it is possible to search the DTs log. In this part the user is aware of the integrity of the data for each of the days, through present signage (blue ball means that the data was well imported and red ball means that data is missing for that day).

- **Map:** In this module, it is possible to analyze and solve various aspects of the network with the aid of a graphic mapping. Here, there are three types of visualization: terrain, streets or satellite. In this map, having a simple and clear design, the cells are represented, being possible to obtain information relative to each one. Through the search field it is easy to have access to various events (handover failures and blocked calls) as well as the exact location. It is also possible to access CM information. The neighbours of each of the cells are easily represented, giving a general overview or by carrier. Crossed sectors are also mapped and listed.
- **Tabular:** As the name suggests, in this module, data is represented in tables. As in the Map section, the user can search for keywords or parameters and the information is available on a table. This is an easier way to analyze some information.
- **Reports:** In this section, the network performance can be visualized in an Executive Report, which is automatically done. These reports facilitate project monitoring and can be shared with other team members.

In Table 2.2 it is possible to analyze what each of the tools above mentioned can perform.

	Planning	Monitoring	KPIs	DTs
ASSET	✓	X	X	X
Atoll	✓	X	X	X
Capesso	✓	X	X	X
Metric	✓	✓	✓	✓
Excel	X	✓	✓	X
Mentor	X	✓	X	X
XCAL	X	✓	X	✓
MUSA	✓	X	X	✓

TABLE 2.2: Mobile communication network planning tools.

2.4.4 Cloud Services

Cloud computing is one of the most discussed topics in the technical and economic world. It offers common computing services, such as storage, processing or networking, over the Internet. This type of service provides scalability, in order to quickly adapt to the needs of the client, enhanced collaboration with the help of shared storage and reliability. There is still a lack of standards in cloud services, as each provider makes use of different protocols and technologies. Another main benefits of cloud computing, when comparing to traditional computing are the fact that cloud is built on a flexible infrastructure, automation as it is managed by the provider, it has lesser costs, as there are no costs with hardware and it is a pay-per-use of computing resources and is accessible by any device [47]. An overview of various cloud services may be observed in Figure 2.23.

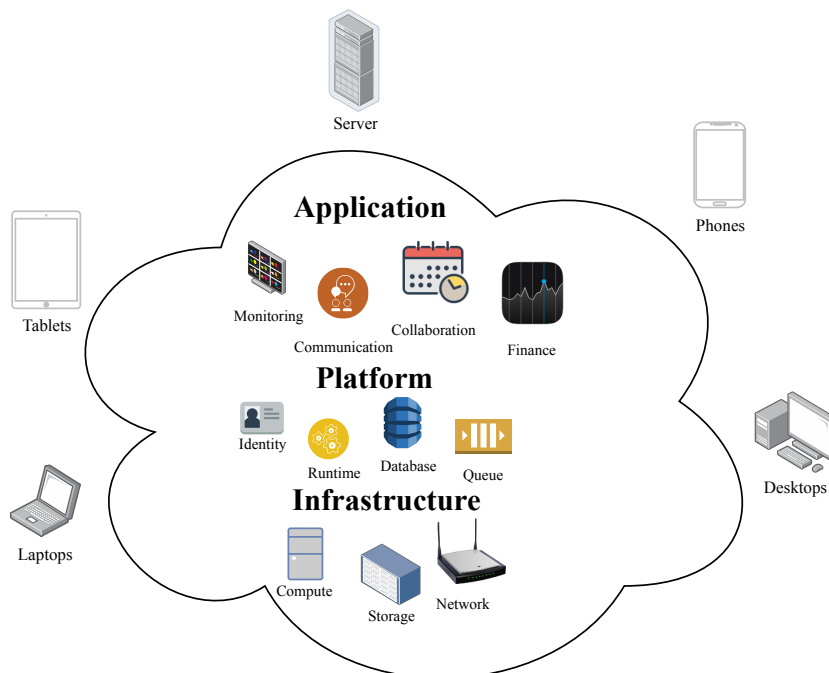

FIGURE 2.23: Cloud services overview.

This type of service is widely used in information systems, this paradigm has been extended to more demanding systems such as telecommunication networks. There are many cloud services providers, Amazon Web Services (AWS) [48], are property of Amazon, provide a large range of Infrastructure-as-a-Service (IaaS),

which is an instant computing infrastructure, and Platform as a Service (PaaS), that allows the user to develop, run, and manage applications without the complexity of building and maintaining the infrastructure, including Elastic Cloud Compute (EC2) and Simple Storage Service (S3). Google Cloud [49] also includes IaaS and PaaS services, using Google-provided modular web services, always focusing on the security of information. Microsoft Azure [50] appeared later to cloud services but has the advantage of taking their software, such as Office and Windows Server, and apply it for the cloud. Software-as-a-Service is another possible service in which licensed software is provided based on a subscription.

Chapter 3

Efficient Planning Algorithms

In this chapter, the used and developed algorithms are described. Firstly, the network architecture and planning pattern are presented. In Section 3.2, the developed algorithm for neighbours identification is presented in Section 3.2.1, as well as the used algorithm, in Section 3.2.2. The developed algorithms for planning 3G and 4G networks resources are also presented in this chapter, in Section 3.3 and Section 3.4, respectively. Finally the evaluation metrics used, are analyzed.

3.1 Network Architecture and Planning Pattern

The architectural framework that supports the novel proposed resource network-planning pattern is presented in Figure 3.1, for both SCs and PCIs. Although the structure followed is nearly similar, there are a few key differences in the planning of SCs and PCIs. The architectural framework is composed of four distinct layers and starts with the users. In a mobile network, users, through their devices (Mobile Terminals - MT), make an abundant use of mobile services, which generates aggregate traffic supported by the Radio Access Network (RAN). The RAN layer is composed by the BSs that support the generated traffic, each BS covering a service area (a BS and its covered area is called a cell). Above the RAN, there is a control layer, the Operations Support System (OSS) that allows to configure and

monitor network elements, making its management. In this particular situation we intend to correctly manage the limited resources available on the network, as this is a key factor to the correct operation of the cellular network. It is through the data provided in the monitoring that this level of control is based, which follows the framework represented in Figure 3.1, in order to monitor, plan and optimize cellular network resources, enabling interaction with the OSS, via cloud services.

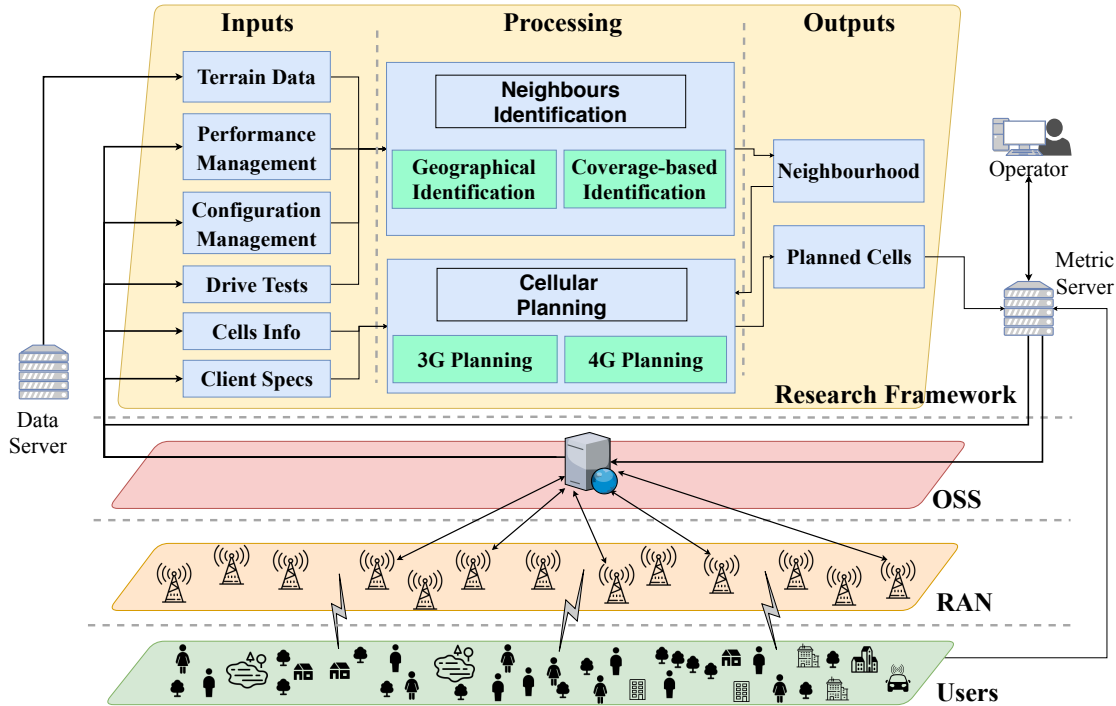

FIGURE 3.1: Planning Model.

Using Metric, the network planning engineer is able to trigger the Cellular Planning service, allowing the proposed work pattern to extract and process information and run the associated algorithms. The various steps of this pattern are detailed in the next sections. The required inputs, identified in Figure 3.1 and its description for the planning of radio resources (both SCs and PCIs) are:

- **Terrain Data:** This input has two different providers, from the API of *OpenTopography* [51] it is requested the terrain morphology (for example, elevation). Next, it is necessary to add information about the height of the buildings that may exist in each area. This information is request through de Overpass API, that gathers data from *OpenStreetMap*. This allows to realistically create the propagation environment.

- **Performance Management:** Here, the specifications of each antenna is obtained, as its model, height and azimuth. This represents an important input, as it will be essential to know the specifications of the BS.
- **Configuration Management:** Information of the network configurations, as cell reach, is gathered from this input. These are the parameters that can be configurable in the network.
- **Drive Tests:** Data related to DTs is stored directly in Metric. Considering a certain area, the DTs are used to make the calibration of the used propagation model.
- **Cells' information,** including its name, site it belongs to, position (latitude and longitude), UTRA Absolute Radio Frequency Channel Number (UARFCN) or Evolved-UTRA Absolute Radio Frequency (EARFCN) and used SC or PCI. This is a file that has information about each cell of the network. Also includes the list of sites to be planned.
- **Client specifications,** identifying the SCs or PCIs site and frequency strategies, as well as the reference frequency (UARFCN or EARFCN) to be used in the planning and the intended distribution of SCs.

The processing module of the planning model, contains:

- **Neighbours Definition:** In this module, the neighbours of each cell are identified. There are two possible methods to do this, through the Geographical Identification and the Coverage-based Identification, both specified in Section 3.2.
- **Cellular Planning:** This module is responsible for the planning of the cellular network, more specifically, SCs in 3G (Section 3.3) and PCIs in 4G networks (Section 3.4).

The developed system has outputs, for both SCs' and PCIs' planning:

- The resources (either SCs or PCIs) allocated to each cell, i.e., the SC allocated to each cell in 3G networks and for 4G networks, the PCI of each cell.
- A file containing the number of collisions to 1st and 2nd order neighbours, in the case of SCs planning and the number of collisions to the most interfering cells, in the case of PCIs planning.

3.2 Neighbours Identification

The identification of neighbours, represented in Figure 3.1, can be implemented following two different approaches. One of the approaches is the Geographical Identification of Neighbours, which is used in networks, such as UMTS, that do not require a detailed neighbouring planning. The Coverage-based Identification of Neighbours is a more accurate method, that identifies a precise list of neighbours for each cell. This type of methodology is used in LTE networks. In this approach it is necessary to have various information about the network itself, which sometimes is not possible. In this case, the Geographical Identification of Neighbours is also used.

3.2.1 Geographical Identification of Neighbours

The neighbours identification algorithm is easily adjustable to be used on other networks and it can be helpful on other planning algorithms. These algorithm is mainly based in the tiers method, referred in 2.3.2, although bringing other features to optimise the planning, making it separable between different frequencies. As input it must have the distance of the first tier of neighbourhood, d_{1st_neighb} and the distance of the second tier of neighbourhood d_{2nd_neighb} , if these are not specified it automatically assumes d_{1st_neighb} to be 35 km and d_{2nd_neighb} as $2 \times d_{1st_neighb}$. For each cell (so-called base cell), 1st and 2nd order neighbours are identified. First, distances from the base-cell to the remaining cells of the network are calculated.

Through the Haversine formula [8], with Equation 3.1, 3.2 and 3.3, it is possible to calculate the distance between two points on the Earth surface as follows,

$$a = \text{sen}^2\left(\frac{\Delta\phi}{2}\right) + \cos(\phi_1) \times \cos(\phi_2) \times \text{sen}^2\left(\frac{\Delta\lambda}{2}\right) \quad (3.1)$$

$$c = 2 \times \text{arctan}_2(\sqrt{a}, \sqrt{1-a}) \quad (3.2)$$

$$d = R \times c \quad (3.3)$$

where ϕ_1 and ϕ_2 are the latitude of each point, $\Delta\lambda$ is the difference between the two points longitude, and R is the Earth radius. This way, given a maximum distance to be considered neighbour, d_{neighb} , it is possible to calculate each of the neighbours. Using this, the algorithm builds lists of 1st and 2nd order neighbours, registering, for each neighbour, its distance and the used SC, as this method is used in 3G networks.

The algorithm divides the neighbours by frequency, making it easier to plan the SCs afterwards. So a site that transmits on two distinct frequencies as two different sets of neighbours, one for each UARFCN. As cells may be co-located, this calculation of neighbours is made per-position and not per-cell, so that repeated sets of neighbours may not exist. Resuming, this type of neighbour planning may be observed in Figure 3.2, as layers of neighbours are used. In this case, we use the two layers of neighbours already described: 1st and 2nd order neighbours [52].

3.2.2 Coverage-based Identification of Neighbours

Another approach is the coverage-based identification of neighbours, based on the Standard Propagation Model (SPM), that is calibrated using Drive Tests (DTs) [53]. This propagation model is an extension of Okumura-Hata propagation model, however, it allows the input of certain values such as diffraction loss and elevation,

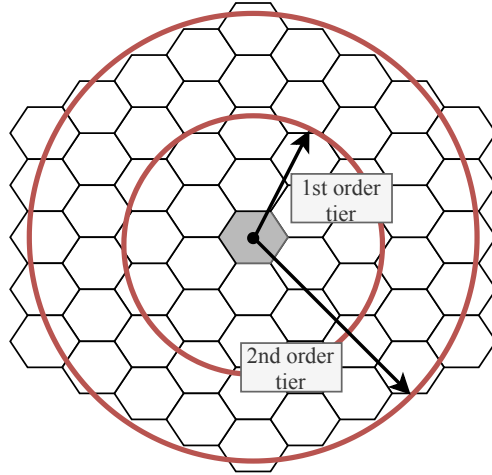

FIGURE 3.2: Neighbourhood tiers.

obtaining results closer to reality. For each cell, an estimation of the received signal is made in its coverage area, resulting in a propagation grid of the received signal level at each geolocated pixel. This processing module, as can be seen in Figure 3.1, needs several inputs to work correctly and provide realistic results: terrain data; cells, performance and configuration management information and DTs.

In this module, based on the propagation grids of the cell coverage estimation module, the neighbourhood is defined for each cell of the network. From the propagation grid of each cell, neighbouring and interfering cells are analyzed. Using another developed algorithm, the list of neighbours is established. Two interfering cells are any two cells in which each others signals reach the same location (referred as pixels). However, two interfering cells are not necessarily neighbours. For two cells to be considered neighbours, they have to be interfering and have a received signal level, P_{rx} , higher than -120 dBm in the same pixel. A count is also made of the number of pixels in which the cells interfere, in order to classify the degree of neighbourhood; this because the more interfering, the more they interfere and with more power intensity. A collision happens when two neighbouring cells use the same resource. Knowing the most interfering cells, it is possible to properly avoid collisions between neighbouring cells.

Neighbours are not classified as 1st order neighbours or 2nd order neighbours as in the Geographical Identification of Neighbours. Here, neighbours are directly

defined by the interference that two cells have. Therefore, are considered neighbours, those who interfere directly with a base cell with a power intensity higher than -120 dBm. This way, a precise and effective neighbourhood is established for each one of the cells, in order to allow a correct re-utilization of the resources of the network.

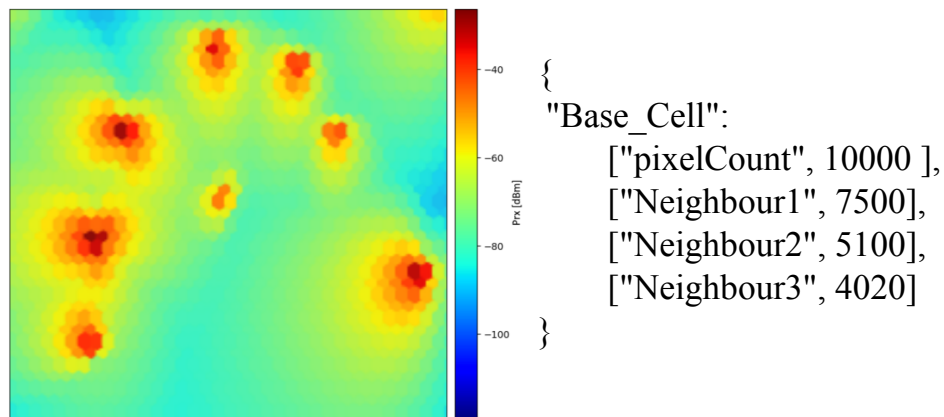

FIGURE 3.3: Antennas propagation and example of neighbours interference.

Analyzing Figure 3.3, it is possible to understand that each antenna coverage (cell) is represented by pixels, each pixel containing information about the level of the received signal. In order to establish levels of neighbourhood, a count is made for the number of pixels in which two cells interfere with a signal higher than -120 dBm. For example, if a cell has a total coverage ("*pixelCount*") of 2000 pixels and a neighbour covers 500 pixels with a power higher than -120 dBm, then it has a coverage interference of 25%.

3.3 Planning of 3G Radio Resources

3.3.1 Overview

The planning is decomposed in two modules, one for 3G and another for 4G, as represented in Figure 3.1. For 3G, the processing module is detailed in Figure 3.4. In order to make the correct planning of SCs, there are two necessary inputs: the cells information and the client specifications, both imported from AWS. The

cells information is a critical input as without this information it is not possible to complete the planning and the client specifications represent an important input as the network layout must be consistent with the clients' pretensions.

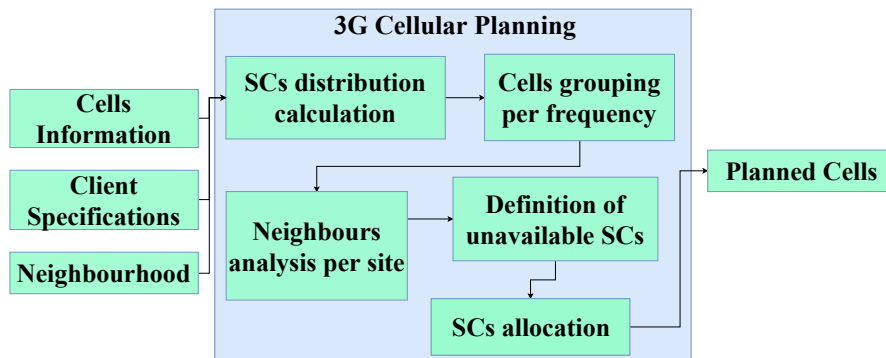

FIGURE 3.4: SCs processing module.

As can be seen in Figure 3.4, the processing modules used in this framework are the Neighbours Identification and the Cellular Planning. The Neighbourhood Identification module is responsible for identifying the neighbours for each of the cells of the network. For the SCs' planning we use a wider calculation of neighbours that does not require specific information of each cell or terrain data (Geographical Identification of Neighbours). The Cellular Planning module contains sub-processing modules that are responsible for different actions, all being necessary to successfully complete the SCs planning.

The final outputs of the SCs planning process are the planned cells information, the modified cells file (with the updated SCs for each cell) and collisions information, allowing to know if there were any problems with the network planning.

3.3.2 Scrambling Codes Planning Algorithm

In this module, we propose an algorithm capable of delivering an easy, effective and fast assignment of SCs to a set of cells. This type of action is necessary in an existing network, for example, for the deployment of a new BS or a whole site.

In the developed algorithm, there are two rules that are followed, in order to make a correct allocation of resources. The main rule is that two 1st order neighbours can not share the same SC. The second rule, consists on controlling the confusions, so it also tries to avoid that the SC of one cell is used by its 2nd order neighbours. In order to make a rigorous evaluation, metrics are defined, including the number of collisions of each cell with its 1st order neighbours (this number should be zero) and the number of collisions and distance to 2nd order neighbours. Collisions with 2nd order neighbours should always be avoided, although, in urban areas, due to the high density of cells, this rule may not be always applicable, so, in this case the algorithm assigns the SC used by the farthest 2nd order neighbour. In Figure 3.4, the Scrambling Codes Planning module consists in various sub-modules, each of them having a specific function:

1. **SCs distribution calculation:** Depending on the client specifications, SCs sets are built. This sets may be composed of consecutive SCs (e.g., 2, 3 and 4 for a 3 cells site) or discrete (10, 18 and 26), always having values between 0 and 511.
2. **Grouping of cells per frequency:** The SCs planning is made per frequency, that is, for an UMTS network that as a set of frequencies (UARFCN) available, the planning is made for each group of cells of each UARFCN. As each cell may use different frequencies, one site can actually have cells that use distinct UARFCNS. The planning for each of the cells that belong to a site but have distinct UARFCNs, is independent. The division of the set of unplanned cells may be observed in Algorithm 1.
3. **Neighbours analysis per site:** For the unplanned cells, an analysis of neighbours is made in the entire network. This, allows to identify the 1st order neighbours and 2nd order neighbours of each unplanned cell, and the ones that are further away from the base cell. This analysis is crucial for a precise SC planning. This analysis is performed using the output of the Geographical Identification of Neighbours, allowing to establish the neighbourhood orders.

Algorithm 1 Division of cells by frequency

Input: List of cells**Output:** Sub-networks by frequencies

```
1: procedure DIVISIONBYFREQUENCY(cellsList)
2:   divisionByFrequency  $\leftarrow$  Hashmap()  $\triangleright$  Key is frequency, value is list of
   cells
3:   for cell in cellsList do
4:     if divisionByFrequency contains cell.Frequency then
5:       divisionByFrequency(cell.Frequency) += cell
6:     else
7:       divisionByFrequency(cell.Frequency) = cell
```

4. **Definition of unavailable SCs:** As the neighbours of each unplanned cell are identified, it is possible to point a set of unavailable SCs, being those, the ones used by 1st order neighbours. The 2nd order neighbours SCs are also identified, as the algorithm should also try to avoid them. The production of the SCs lists used by neighbours is easily presented in Algorithm 2.

Algorithm 2 Definition of unavailable SCs

Input: List of unplanned cells**Output:** Unavailable SCs for each cell

```
1: procedure AVAILABLESCS(unplannedCells)
2:   for cell in unplannedCells do
3:     for neighbour in cell.firstOrderNeighbours do
4:       cell.usedByFirstOrderNeighbours += neighbour.SC
5:     for neighbour in cell.secondOrderNeighbours do
6:       if neighbour.SC not in cell.usedByFirstOrderNeighbours then
7:         cell.usedBySecondOrderNeighbours += neighbour.SC
```

5. **SCs allocation:** There are two possible situations when allocating SCs to cells (starting with the reference UARFCN, indicated by the client):

- (a) The most desirable situation is when it is possible to assign a set of SCs that is not being used by any of the 1st and 2nd order neighbours of the base cell. In this case, collisions of any kind are prevented. This may happen usually in rural areas, although, this is not likely to happen in urban areas, where the density of cells is much higher. Therefore, in a realistic scenario this situation is not the most usual.

- (b) The most realistic situation, and the one that we mainly intend to offer a solution, is that SCs must have to be reused between 2nd order neighbours. Once again, the SCs used by 1st order neighbours are always to be avoided by the base cell. In this situation, we try to assign the SC that is further always from the cell, minimizing the interference. In an extreme case, the algorithm finds the most further away 1st order neighbour, to reuse its SC. This type of situation where it is necessary to find the best possible group of SCs, may be analyzed in Algorithm 3.

Algorithm 3 Find the best possible group of SCs for site

Input: *SCsMap*, hashmap where key is group and value is the list of SCs of that group; *cellsToPlan*, an arraylist of the cells to plan; *distanceToSCs*, hashmap where the distance to every 2nd order neighbour SC is defined

Output: -

```

1: procedure FINDLESSBADGROUP(SCsMap, cellsToPlan)
2:   groupsDist  $\leftarrow$  hashmap() ▷ Empty hashmap
3:   for group in SCsMap do
4:     if group.size = cellsToPlan.size then
5:       for sc in group do
6:         if cellsToPlan.distanceToSCs contains sc &
           cellsToPlan.usedSCByFirstOrder not contains sc then
7:           for scAux in distanceToSCs do
8:             dist = distanceToSCs.scAux
9:             if dist < groupsDist.group then
10:              groupsDist.group = dist
11:            else
12:              groupsDist += (group, dist);
13:   entry  $\leftarrow$  int
14:   maxDist  $\leftarrow$  int
15:   for gr in groupsDist do
16:     if groupsDist.gr > maxDist then
17:       maxDist = groupsDist.gr;
18:       entry = gr;
19:   if entry not null then
20:     groupToUse = SCsMap.entry
21:     assignGroup(cellsToPlan, groupToUse)

```

The process of SCs allocation is described above to only one UARFCN, as SCs are assigned to the cells belonging to the reference UARFCN, the cells that

use other UARFCNs are planned next, as specified by the client. This planning, always depends on the client specifications and validations are always made.

3.4 Planning of 4G Radio Resources

3.4.1 Overview

The framework for PCIs' planning requires more demanding inputs, the Cells Information and the Client Specifications, that were already needed in the SCs' planning. In order to make a correct identification of neighbours, using the Coverage-based Identification of Neighbours, Drive Tests, Performance Management, Configuration Management and terrain data are necessary. In 3.5, are represented the processing modules developed to make a correct allocation of PCIs.

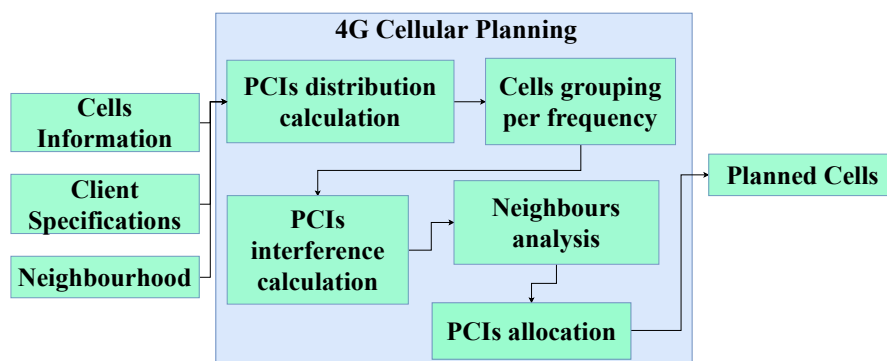

FIGURE 3.5: PCIs processing module.

This framework uses two different processing modules: the Neighbours Identification module and the Cellular Planning Module. In the Neighbours Identification Module, the Coverage-based Identification of Neighbours is used, being responsible of providing propagation grids of each cell of the network, containing the coverage estimation in every pixel (unity of area for geographical positions) of the antenna's service area, which may be represented in a heatmap. Using this propagation grids, it is possible to establish a neighbourhood for each cell. Only with a solid neighbourhood, it is possible to successfully complete the Cellular Planning module (4G planning).

3.4.2 Physical Cell Identity Planning Algorithm

As for the SCs, the main goal of the PCI planning module is to deliver an easy, fast and effective algorithm to allocate PCIs to a set of cells. In this case, the neighbours are estimated using the Coverage-based Identification of Neighbours, therefore 1st order neighbours and 2nd order neighbours are not used. Here, each cell has a set of neighbours, knowing what is the level of interference for each of them. The PCIs' planning follows the steps described in Figure 3.5:

1. **PCIs distribution calculation:** This module is similar to the one used in the SCs planning, although it calculates the used distribution of PCIs (consecutive or distributed), with values between 0 and 513.
2. **Cells' grouping per frequency:** The planning of PCIs is also performed by frequency, so the LTE network should also be divided per EARFCNs. Just like in UMTS, each site may have cells using different frequencies.
3. **Neighbours analysis:** From the Coverage-based Identification of Neighbours, it is possible to know, for a base cell, the number of pixels that cell covers and the number of pixels that each neighbour intersects with that cell. For the unplanned sites, all of the neighbours in the network are analyzed. The interference to each of the neighbours is calculated, allowing to know which are the most and less interfering ones, giving the geographical co-localization percentage of the base cell with its neighbours (I_{neigh}). This is a critical step to make the calculation of PCIs interference. Here, neighbours are those who interfere directly with the base cell with a power higher than -120 dBm. Knowing the interference between sites it is possible to make a robust planning of resources. The raw output from the Coverage-based Identification of Neighbours has the following format:

```
{  
  "Base_Cell":  
  ["pixelCount", 10000 ],  
  ["Neighbour1", 7500],
```

```
["Neighbour2", 5100],  
["Neighbour3", 4020]  
}
```

4. **PCIs interference calculation:** For each cell, the interference to each of the 514 PCIs is calculated. This calculation is made based on the interference to the set of neighbours of the base cell. The higher the interference to one neighbour, the higher the interference to the PCI it uses will be. If one cell has different neighbours using the same PCI, the interference to that PCI is cumulative. The calculation of the PCI interference depends on various values. This process is explained in Algorithm 4.

Algorithm 4 PCI interference calculation

Input: *cellsToPlan*, arraylist of cells to be planned, *pcisUsedByNeighs*, a JSON containing the PCI used by each neighbour

Output: *interferencePerPCI*, hashmap containing the interference for each PCI for each of the cells to plan

```
1: procedure ESTABLISHPCISINTERFERENCE(cellsToPlan,  
   pcisUsedByNeighs)  
2:   for pci in pciList do  
3:     mod3 = calculateMOD3(pci)  
4:     mod6 = calculateMOD6(pci)  
5:     mod30 = calculateMOD30(pci)  
6:     pcfich = calculatePCFICH (pci, cellsToPlan.cellBandwidth)  
7:     interfrLevel = 0  
8:     for pciNeigh in pcisUsedByNeighs do  
9:       pciInfo = pcisUsedByNeighs.pciNeigh  
10:      numberOfCollisions = 0  
11:      if mod3 = pciNeigh.mod3 then numberOfCollisions += 1  
12:      if mod6 = pciNeigh.mod6 then numberOfCollisions += 1  
13:      if mod30 = pciNeigh.mod30 then numberOfCollisions += 1  
14:      for reg in pcfich do  
15:        if pciNeigh.pcfich contains reg then numberOfCollisions +=  
16:        0.25  
16:        interfrLevel += (numberOfCollisions*0.25) * interfrToNeigh  
17:      interfrPerPCI.put(pci, interfrLevel)  
17:      return interfrPerPCI
```

In Chapter 2.3.5.1, the concept of PCFICH is presented, and its mapping is also demonstrated, through the use of the four REGs. PCFICH collisions

of neighboring cells can cause an increase in PCFICH block error rate and decoding failures. Therefore, there are 5 different levels of collisions between neighbouring cells in the PCFICH level:

- 0%: None of the REGs collides.
- 25%: Happens when two neighbouring cells collide in one of the REGs.
- 50%: When two cells collide in two distinct REGs.
- 75%: In situations where three REGs collide in adjacent cells.
- 100%: Situation of total collision, where the four REGs suffer collisions with adjacent cells.

When planning PCIs for an entire network, REGs collisions (or the entire PCFICH) should be reduced as much as possible, however, when planning only part of the network, this planning is already limited to the previous planning and it may be more difficult to avoid these collisions.

The calculus for the PCI interference level, accordingly with Algorithm 4, between two neighbours can be defined:

$$I_{PCI} = C_{sum} \times 0.25 \quad (3.4)$$

Where C_{sum} is the number of collisions, either, MOD3, MOD6, MOD30, being that the value of the PCFICH collision is also added. The total interference between two neighbours can be calculated:

$$I_{total} = I_{PCI} \times I_{neigh} \quad (3.5)$$

5. **PCIs allocation:** When planning PCIs there are no separate situations, as when using levels of interference, it is possible to know the interference that each PCI will cause on a specific cell. Being that the allocation of PCIs is made per site, it is necessary to make the calculation of the interference that each PCI will cause to the whole site, always depending on the neighbours.

As the reference UARFCN has its resources planned, the others will follow, depending on the client specifications.

3.5 Evaluation Metrics

Metrics are used to evaluate the quality of the radio resources planning. Defining metrics to evaluate each of the performed plannings is a very important step to rigorously evaluate the developed system. The calculation of the number of resources collisions, in this case when planning 3G resources (SCs), may be analyzed in Algorithm 5.

Algorithm 5 Number of Collisions in 3G

Input: *plannedCellsList*, a list of all new planned cells

Output:

```

1: procedure ASSINGNGROUP(plannedCellsList)
2:   firstOrderNeighbourCollisions  $\leftarrow$  null
3:   secondOrderNeighbourCollisions  $\leftarrow$  null
4:   for cell in plannedCells do
5:     for nC in c.firstOrderNeighbours do
6:       if c.SC = nC.SC & c.cellAbbrev = nC.cellAbbrev & c.frequency
       = nC.frequency then
7:         firstOrderNeighbourCollisions ++
8:     for cell in plannedCells do
9:       for nC in c.secondOrderNeighbours do
10:        if c.SC = nC.SC & c.cellAbbrev = nC.cellAbbrev & c.frequency
        = nC.frequency then
11:          secondOrderNeighbourCollisions ++

```

The metrics used for evaluation are:

- N_{3G_1st} and N_{3G_2nd} are, respectively, the number of collisions to 1st and 2nd order neighbours in the planning of 3G resources (SCs).
- $N_{4G_collisions}$, represents the number of collisions to the most interfering neighbours. These neighbours are those where I_{neigh} is higher than 40% and I_{PCI} higher than 50%, giving a total interference between the two neighbours, I_{neigh} , higher than 20%, accordingly with Equation 3.5.

- P_c is the percentage of collisions that the base cell has with its most interfering neighbours (in the case of UMTS, with 1st order neighbours).
- T_{comp} , represents the computation time required to perform the planning. This should be as lower as possible, considering the size of the planning, as this is a software where the clients expect to see results immediately.

Chapter 4

Implementation and Integration

In this chapter, the implementation of the system using cloud services, in this case, AWS is detailed, the technologies necessary for this implementation are also described. The work pattern, with AWS implemented, is also detailed, as well as the integration of this system in the SaaS Metric.

4.1 Implementation using cloud AWS

4.1.1 Used Technologies

The developed system is implemented using cloud services, more specifically, the AWS. Therefore, for the implementation of the SON radio resource planning system, both storage and processing AWS services are used [48]:

- **AWS *Lambda***: This service allows to run code without the need to provision or manage servers, whenever necessary. Only the consumed computing time requires payments, and it is possible to run code for any kind of backend service. It is also possible to run and scale the code with high availability. For each *Lambda*, a processing time of 15 minutes is allowed with a Random Access Memory (RAM) of 3008 MB and 500 MB of virtual storage.

- **AWS S3 bucket:** *Amazon Simple Storage Service (S3)* is an object storage service. High scalability, data availability, security and performance are provided by this service. Data can be configured and organized in order to meet the requirements of any type of project. Services such as IoT or big data analytics, which require a big amount of data storage, often use this service. The S3, has unlimited space and each file can have up to 5 TB.
- **AWS EC2:** The *Amazon Elastic Compute Cloud (AWS EC2)*, gives computational capacity in a secure and resizable way through cloud. This, was made in order to ease cloud computation.

There are other technologies used to implement the presented work in a serverless way, where the cloud provider (AWS) runs the server, and dynamically manages the allocation of machine resources. The programming language used to develop the algorithms is Java [54], as it provides portability, being that it is easily executed in various platforms and object oriented. JSON is widely used for data storage, as it allows to represent information in text format with fast access [55] and Tab Separated Values (TSV) files. Maven was used as an automation tool, allowing to manage, build, report and document the project from a central piece of information. It also allows to import useful projects to the developed algorithms, such as the Coverage-based Identification of Neighbours.

4.1.2 Work Pattern

A work pattern is proposed to monitor, plan and optimize cellular network resources. In the context of *utility computing*, the AWS is used, enabling the interaction with the cellular network's OSS. Each processing module has its needed information in a storage service (input) and also provides information for other processing modules (output). The work pattern implemented using the AWS is depicted in Figure 4.1.

The proposed work pattern is built combining one *EC2*, seven *S3 buckets* for processed data storage, and three *Lambdas*:

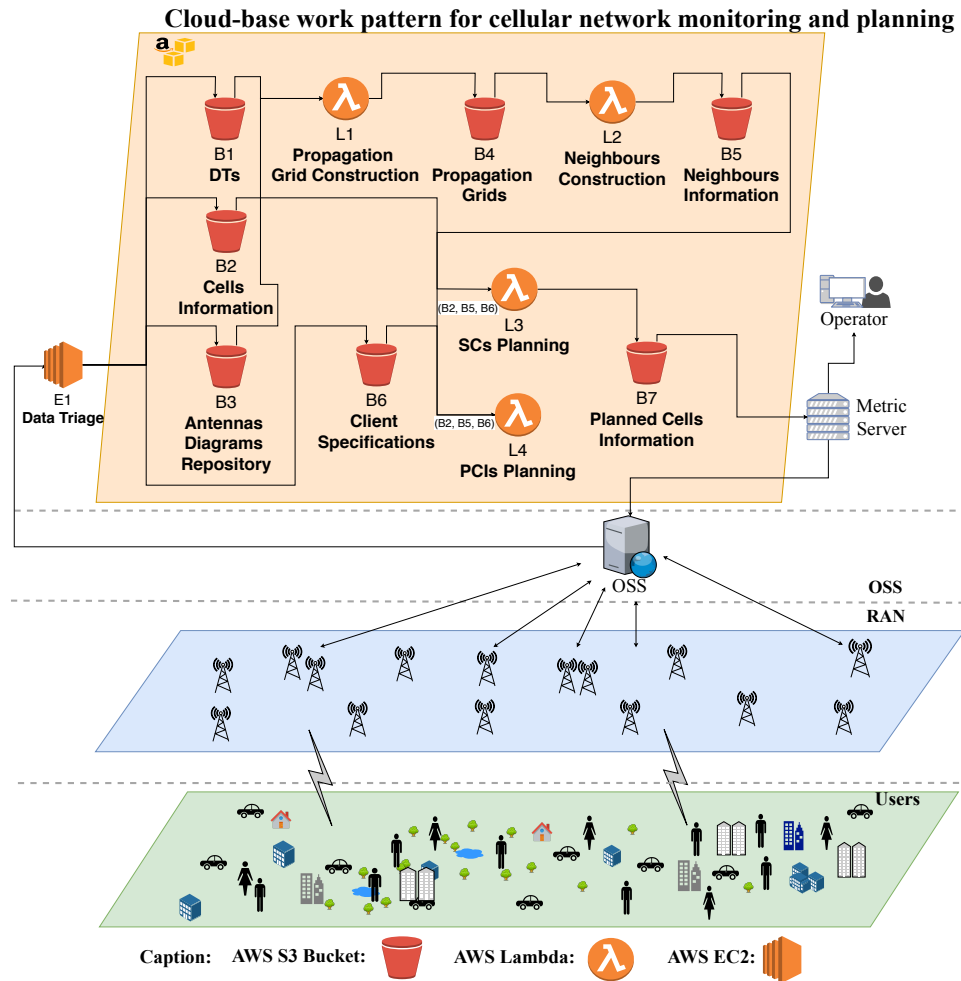

FIGURE 4.1: Cloud-based work pattern for cellular network monitoring and planning.

- **E1 - Data Triage:** This is used to process the raw data from the OSS. This allows to allocate the data to the adequate *S3 buckets*, in this case, **B1**, **B2**, **B3** and **B4**.
- **B1 - DTs:** All the data related with DTs is stored in this *bucket* in a JSON format, allowing for fast access.
- **B2 - Cells Information:** This *bucket* contains information about every deployed cell in the network. This data is in the format of TSV.
- **B3 - Antennas Diagrams Repository:** In this *bucket*, not only antennas diagrams (in MSI format) but also specifications and configurations are stored (JSON format).

- **L1 - Propagation Grid Construction:** The coverage estimation of each cell is performed in this *Lambda*, allowing to build propagation grids for each of them. This *Lambda* needs the information stored in **B1**, **B2** and **B3**. It stores the output in **B4**.
- **B4 - Propagation Grids:** The propagation grids of each cell provided by **L1** are stored in this *bucket*, in the JSON format.
- **L2 - Neighbours Construction:** In this *Lambda*, neighbours are identified. In the case of planning cells of UMTS systems, it uses the Geographical Identification of Neighbours, if it is planning resources of LTE networks, the used algorithm is the Coverage-based Identification of Neighbours. This step of the process collects the necessary data from **B4** and stores the output in **B5**.
- **B5 - Neighbours Information:** This *bucket* contains the neighbours information for each cell, result of the triggering of **L2**. All the neighbours information is in the format of JSON.
- **B6 - Client Specifications:** All client specifications are stored in this *bucket*. This data is represented in a TSV file.
- **L3 - SCs Planning:** This *Lambda* performs the required cellular planning of 3G radio resources, specifically SCs, for UMTS networks. In order to properly work, this *Lambda*, collects info from **B2**, **B5** and **B6**, storing the output in **B7**.
- **L4 - PCIs Planning:** This *Lambda* has a similar function of **L3** *Lambda*, although, this performs the planning for 4G radio resources, in this case, PCIs. It also collects the necessary inputs from **B2**, **B5** and **B6** and stores the output in **B7**.
- **B7 - Planned Cells Information:** The final planning of the network radio resources for each of the unplanned cells is stored in this *bucket*. The planned cells data is in the JSON format, allowing easy and fast access.

One *Lambda* is responsible for the estimation of coverage, building propagation grids. A second *Lambda* is used to identify cells' neighbour lists, using the propagation grids (if not available using the Geographical Identification of Neighbours). Finally, knowing each cells' neighbours, a final *Lambda* implements the cellular planning, in this case the SCs' planning algorithm, proposing for every unplanned cell a SC or the planning of PCIs.

4.2 Integration in Metric

The Scrambling Codes Planning and the Physical Cell Identity Planning algorithms are both integrated in Metric, being that the interface to the algorithmic planning of resources is the AWS. This integration is a new Metric SON feature, which did not previously exist. This feature allows the operator to perform a fast and efficient radio resources planning. This work pattern does not require repeated manual configurations of the planning specifications, because Metric has this information stored in AWS [56].

The integration of this work in Metric is done with the help of AWS. Therefore, it is necessary to make a connection directly with this web services. As the client makes the request for the cells resource planning, Metric uses AWS for all the processing. In order for this to work, the required connections between Metric and AWS were developed. To help this integration, the following Maven dependencies, which allow an easier connection to AWS, were used:

```
<dependency>
  <groupId>com.amazonaws</groupId>
  <artifactId>aws-\textit{Lambda}-java-core</artifactId>
  <version>1.2.0</version>
  <scope>compile</scope>
</dependency>
<dependency>
  <groupId>com.amazonaws</groupId>
  <artifactId>aws-java-sdk-s3</artifactId>
  <version>1.11.396</version>
  <scope>compile</scope>
</dependency>
```

```
<dependency>
  <groupId>com.amazonaws</groupId>
  <artifactId>aws-\textit{Lambda}-java-log4j2</artifactId>
  <version>1.1.0</version>
</dependency>
```

Giving the example of planning the SCs of a specified cell or a group of cells, the user only has to select the cell and type "Plan Scrambling Code" in the text box, triggering the work pattern. The option to plan the SC of the CANATA cell is clearly demonstrated in Figure 4.2, making it easier and quicker for the user to perform the network planning, which is not possible in most planning tools.

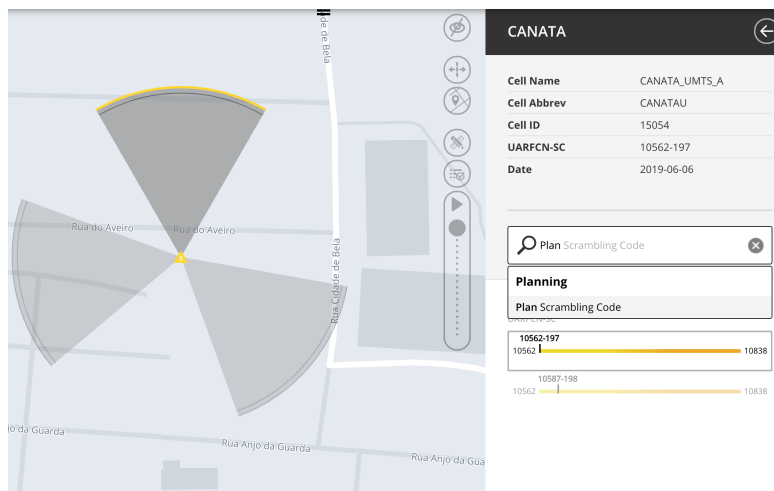

FIGURE 4.2: SC planning interface in Metric.

Although Metric does not have yet the capability to directly make network changes on the configuration level, this can be exported as vendor specific scripts, making it possible for the operator to directly enforce the changes in the network.

Chapter 5

Scenarios and Results

This chapter deals with the scenarios and obtained results from the developed system. In order to demonstrate the operation of this system, two canonical scenarios are used, being that one is extracted from a real network. To provide specific results for an entire network, this planning is also performed for a real 3G network. A detailed analysis of the results is made.

5.1 Evaluation Scenarios

In order to make an evaluation of the performance of the system, several tests were performed, always considering that this system is available on the market and must be in accordance with the clients expectations. In this section, some scenarios are used to demonstrate the system's efficiency, even in a real network deployment.

5.1.1 3G Canonical Scenario

A simple canonical scenario is defined, allowing to evaluate the proposed planning system and the correctness of its implementation. The scenario is depicted in Figure 5.1, it consists in 8 sites and 33 cells. All of the sites have its SCs planned,

except Site 1 (S1). This scenario has cells working on distinct UARFCN frequencies, 10562 and 10687, and some sites operate in two frequencies and others only operate with one. In order to ease the demonstration, the d_{1st_neighb} is 2500 m.

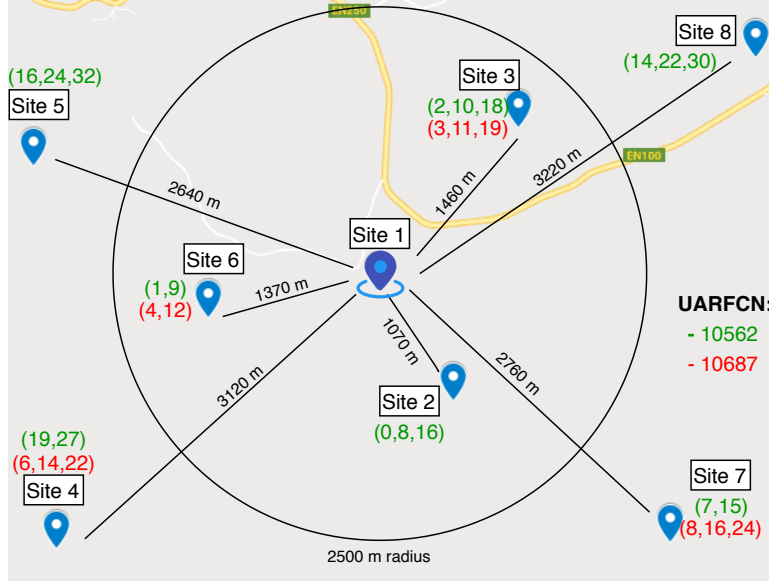

FIGURE 5.1: Layout of the 3G canonical scenario.

Some of the necessary information of this scenario is presented in Figure 5.1: the SCs used in each Site, being that the color represents the used UARFCN (green for 10562 and red for UARFCN 10687). The number number of SCs in one site also represents the number of cells that belong to that specific site, as one cell only has one SC (for example, S5 has 3 cells working in the 10562 UARFCN). The unplanned site of this scenario is S1 and contains two cells working in each of the UARFCNs.

The client specifications represent an important input, for a correct network planning, these are:

- The reference UARFCN is 10562;
- The SCs distribution is discrete (space by 8);

In order to force the algorithm to reuse SCs and find the best possible solution, the list of available SCs groups to two cells was reduced. The available groups to

plan are given in Table 5.1, being that if an unused SCs group by S1 first order neighbours was available, the algorithm would immediately choose it, being a simple solution.

TABLE 5.1: List of available SCs groups of two cells.

Group	SCs	Group	SCs
1	(0, 8)	5	(22, 30)
2	(2, 10)	6	(16, 24)
3	(8, 16)	7	(14, 22)
4	(19, 27)	8	(24, 32)

As the reference UARFCN is 10562, this is the first one to be planned, for others UARFCN (in this case only 10687), the group to be chosen should follow the Frequency Interval given in Table 5.2. This input helps to describe the network layout.

TABLE 5.2: Client specifications.

UARFCN	Reference	Frequency Interval
10562	1	0
10687	0	1

Analyzing Table 5.2 it is understood, as a client specification, that for the UARFCN 10687, the group of SCs to be used is the immediately next of the reference frequency, i.e., if the reference UARFCN (10562) uses group 1, the UARFCN 10687 will try to use group 2 (corresponding to the Frequency Interval). If due to neighbours interference it is not possible to use group 2, it finds the best one available.

5.1.2 3G Realistic Scenario

A realistic scenario, of a real cellular network is also evaluated. This is the entire network of a country, containing 3 719 sites and 12 484 cells, which operate in up to 5 distinct frequencies (UARFCNs). To perform this scenario, the whole network is considered for planning, i.e., all the cells have their SCs unplanned. In this case, all the 512 SCs are available for planning (depending on the neighbours).

Having as input, the real client specifications, which are similar to the ones used on the reference scenario (for the UARFCN allocation strategy, frequency interval and SCs distribution). In this case, in urban areas, a radius of 8 km is used to define the 1st order neighbourhood and the 2nd order neighbourhood radius is 15 km. In rural areas these radius are extended to 20 km and 30 km, respectively. This separation of values happens because in urban areas, cells tend to focus on capacity and have lesser coverage, as the network is more dense than in rural areas, where each cell covers a much bigger area. The visualization of a small part of the used scenario, a urban area, is represented in Figure 5.2, extracted from the Map feature of Metric.

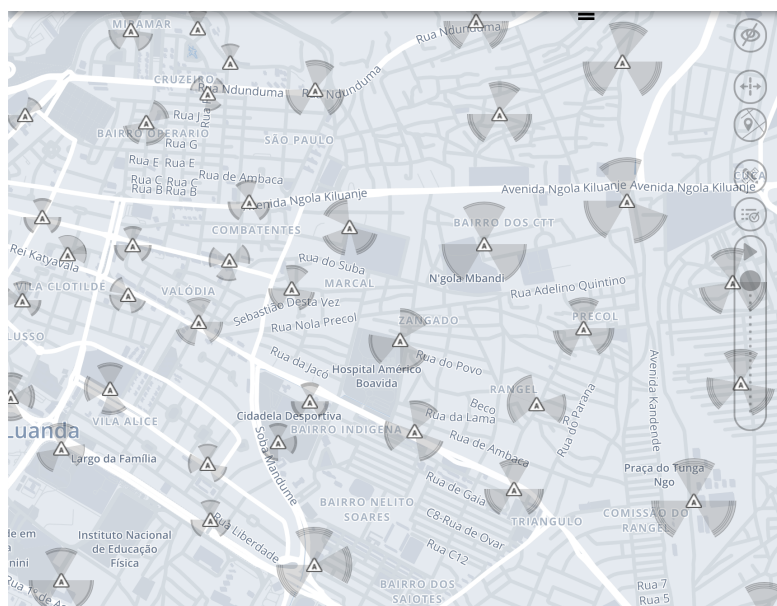

FIGURE 5.2: Part of the 3G realistic scenario.

5.1.3 LTE Canonical Scenario

The system also needs to be evaluated when the neighbours planning is performed with the Coverage-based Identification of Neighbours algorithm. Therefore, a small cluster scenario was used, extracted from a real network. The scenario layout may be observed in Figure 5.3, consisting of 9 sites and 23 cells. The PCIs allocated for this cluster are in the range of 1 to 19. In this case, we intend to plan the PCIs of Site 1 (S1), represented in blue, which has 3 cells, all of the PCIs

allocated to the cluster are already in use by the neighbours of this site, represented in green, so the PCIs must be reused. In Figure 5.3, for a clear understanding of the scenario, it is also possible to check the PCIs used by each cell of each site. It is important to notice that this scenario, extracted from a real network, only works with one EARFCN frequency.

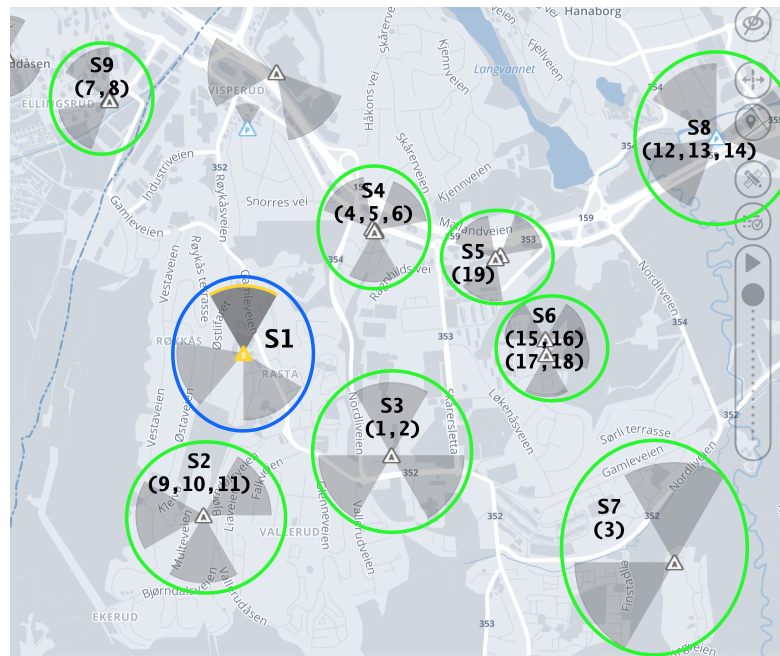

FIGURE 5.3: LTE cluster scenario.

5.2 Results and Discussion

5.2.1 3G Planning Results for Canonical Scenario

The developed system starts by identifying the 1st order neighbours of S1, for both of the UARFCN frequencies. Analyzing Figure 5.1, we can proceed with the analyzing of the processing modules:

1. **SCs distribution:** In this case, the SCs distribution is discrete (spaced by 8). The system knows this as it was specified in the client specifications file. If, this is not specified, the algorithm analyzes a random site, in order to obtain this information.

2. **Cells grouping by frequency:** Here, the analysis of cells frequency in each site is performed, allowing to build sub-networks to ease the planning.
 - (a) UARFCN 10562: This sub-network consists on all the sites of the scenario (S1, S2, S3, S4, S5, S6, S7 and S8).
 - (b) UARFCN 10687: This only contains S1, S3, S4, S6 and S7, as S2, S5 and S8 do not transmit in this frequency.

3. **Neighbours analysis:** Here for each of the sub-networks, an analysis of the unplanned site S1 neighbours is made (which can be easily followed by analyzing Figure 5.1):
 - (a) UARFCN 10562: The system identifies S2, S3 and S6 as 1st order neighbours of S1, as this are within the radius of d_{1st_neighb} , corresponding to 2500 m. As d_{2nd_neighb} is not specified, it automatically assumes to be $2 \times d_{first_neighb} = 5000m$. Thus, S4, S5, S7 and S8 are 2nd order neighbours of S1.
 - (b) UARFCN 10687: Following the same methodology as for UARFCN 10562, here the 1st order neighbours of S1 are identified as S3 and S6, being that S2 is excluded. The system identifies S4 and S7 as 2nd order neighbours of S1 (S5 and S8 are excluded).

4. **Definition of unavailable SCs:** The SCs used by 1st order neighbours are marked as unavailable, therefore from Table 5.1, the groups marked as unavailable for each UARFCN are:
 - (a) UARFCN 10562: SCs groups 1 (SCs 0 and 8 are used by S2), group 2 (SCs 2 and 10 used by S3), group 3 (SCs 8 and 16 used by S2) and group 6 (SC 16 used by S2) can not be used to plan this frequency of S1. Therefore, the available groups are 4, 5, 7 and 8.
 - (b) UARFCN 10687: The only unavailable group for this frequency is group 4.

5. **SCs allocation:** All SCs groups have SCs used within the 1st or 2nd order neighbours, so there is no SC available without collisions. It is necessary to find the SCs groups with less collisions and interference to neighbours.

- (a) UARFCN 10562: A SCs group must be found, of SCs not used by 1st order neighbours, and with lowest collisions. From Table 5.1, it can be seen that the groups without SCs used by 1st order neighbours are group 4 (of SCs 14 and 22), group 5 (22, 30), group 7 (19, 27) and group 8 (24, 32). From the 2nd order neighbours sites, the most distant of S1 is site S8. Thus, the chosen group shall have SCs among the ones used on that site, SCs 14, 22 and 30 (minimizing collisions). Group 4 (14, 22) and 5 (22, 30) are available, group 4 being chosen for reference frequency UARFCN 10562 as S5, which is closer than S8, uses the SC 30.
- (b) UARFCN 10687: As the frequency interval is assumed as 1 (given as input), for UARFCN 10687 the algorithm tries to use the group immediately after group 4, which is group 5 (22, 30). The algorithm makes a verification if any of the SCs on that group are used by the 1st order neighbours of S1 on 10687. If it finds that any of the SCs are already used, it discards the group and finds the best option. In this case, none of the SCs are used by any of the 1st order neighbours, being that only SC 22 is used by the farthest 2nd order neighbour, S4. Therefore, this group can be used and is the chosen one for this UARFCN.

Resuming, for the unplanned site S1, for the reference UARFCN (10562), as it is represented in Figure 5.4, the SCs group used is group 4 (SCs 14 and 22) and for UARFCN 10687, the group immediately next to the one used on the reference UARFCN is used, that is, group 5 (SCs 22 and 30).

In Table 5.3, it is possible to analyze the evaluation metrics previously defined in Section 3.5, allowing to perceive that for the 33 cells, there are none SCs collisions, with a computation time of 158ms. Therefore, this planning does not present collisions with 1st order neighbours and presents 3 collisions with 2nd order

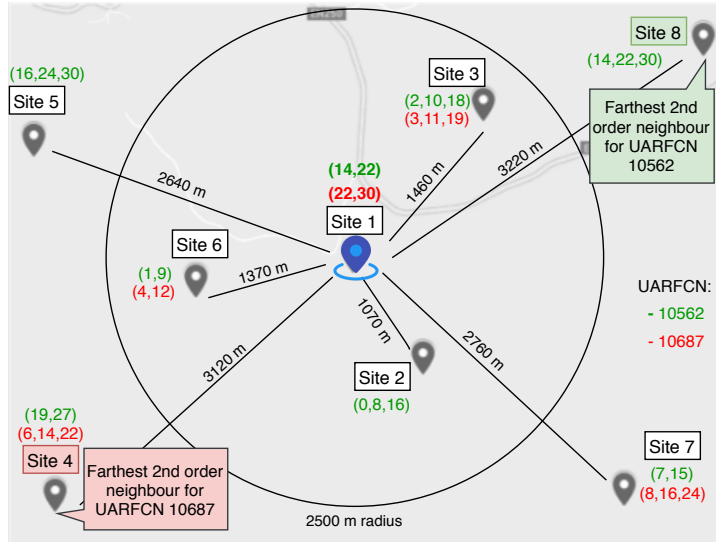

FIGURE 5.4: SC grouping per site.

neighbours, which were supposed to happen, as we forced the algorithm to choose SCs already used by 2nd order neighbours. The planning is good and the expected.

TABLE 5.3: Analysis of Evaluation Metrics for 3G Canonical Scenario.

UARFCN	Number of Cells	$N_{3G\ 1st}$	$N_{3G\ 2nd}$	P_c (%)	T_{comp} (ms)
10562	20	0	2	0.0	80
10687	13	0	1	0.0	78

5.2.2 3G Planning Results for the Realistic Scenario

Regarding the realistic scenario, composed of 12 484 unplanned cells, none of them remained unplanned, showing that the algorithm is robust to possible information failures of some cells (which is common in a real scenario). None has collisions with 1st order neighbours, evidencing the efficiency of the proposed algorithm. The algorithm takes less than 8 seconds to plan the network, revealing the speed with which any client is able to quickly and efficiently replan the entire network of a country.

This is the best way to understand the robustness and precision of this algorithm, as it forces it to plan a large number of cells, being necessary to solve collisions and manage them in the best way, always avoiding collisions with 1st order neighbours. In dense urban areas where a radius of 15 km contains more

than 3000 cells, many overlapping between them, this is an arduous task that requires a precise set of neighbours for each cell, otherwise the whole planning may be compromised. The evaluation metrics for this scenario are presented in Table 5.4, which allow to understand that there are no collisions between 1st order neighbours.

TABLE 5.4: Evaluation Metrics analysis for 3G Realistic Scenario.

UARFCN	Number of Cells	N_{3G_1st}	N_{3G_2nd}	P_c (%)	T_{comp} (s)
10562	5233	0	472	0.0	3.2
10587	4093	0	28	0.0	2.3
10612	1865	0	3	0.0	1.1
10637	883	0	0	0.0	0.51
3087	410	0	0	0.0	0.28
Total	12484	0	503	0.0	7.39

This performance is compared to an SQL-based implementation of SC planning. For the same scenario, it takes around 30 minutes to complete, having more than 400 collisions between 1st order neighbours, leading to a percentage of collisions (P_c) of 3%. This means that most likely, in urban areas, collisions exist, which leads to failures in the network. Some comparisons between the developed system and the SQL-based one, may be observed in Table 5.5.

TABLE 5.5: Evaluation Metrics comparison for SQL implementation and developed system.

	SQL-based	Developed system
Number of cells	12484	12484
N_{3G_1st}	437	0
N_{3G_2nd}	849	472
P_c (%)	3.5	0.0
T_{comp} (s)	1748.3	7.39

The gains of using the developed cloud-based implementation with the developed and used algorithms are evident. This is a major feature that provides the customer the freedom to plan or optimize their network with the assurance that it will only make it more effective and with better QoS.

5.2.3 LTE Planning Results for the Canonical Scenario

For this specific scenario, following Figure 3.5 processing modules, the following steps are performed:

1. **PCIs distribution calculation:** In this case, a consecutive spacing between PCIs within the same group is used. This way, groups of PCIs are not built, as any consecutive PCIs may form a group to be used in a site.
2. **Cells grouping per frequency:** There is only one EARFCN frequency in this network, 6200, corresponding to a downlink frequency of 796 Mhz. Therefore, to plan this cluster it is not necessary to make the cells grouping per frequency.
3. **Neighbours analysis:** For each site, the neighbours of all the cells belonging to that site are analyzed. For demonstration reasons, the three neighbours that have a bigger percentage of co-localization with the base site are represented in a JSON with the following format:

```
{
  "S1":
  ["pixelCount", 467662 ],
  ["Cell11_S4", 332169],
  ["Cell12_S2", 289411],
  ["Cell13_S6", 277604],
  ...
}
```

4. **PCIs interference calculation:** For each cell, a calculation of the interference of each PCI to that specific cell is performed. In this case, the most interfering PCI is 5, which is the one used by the most interfering site (S4) and the less interfering one is PCI 14, although PCI 2 also has minor interference. It is important to notice that the PCI interference depends on the neighbour interference and the PCI it uses, although a cell may be close to the base cell, it does not mean that both cover the same areas.

5. **PCIs allocation:** For S1, as all of the PCIs between 1 and 19 attributed to the cluster are already in use, it is necessary to reuse at least 3 PCIs. As S1 has 3 cells, the system finds the 3 consecutive PCIs that have the least interference with its neighbours and allocates them to the cells of S1. In this case, the system finds that the group (2, 3, 4) is the least interfering one and allocates it to the cells of S1.

The metrics are used to make an evaluation of the algorithm. In Table 5.6 it is possible to analyze the results for the PCIs' planning, where it is shown that the system is able to avoid collisions, even in large scenarios, as this is. This happens mainly because the Coverage-based Identification of Neighbours provides a tight and realist neighbourhood for each cell.

TABLE 5.6: Analysis of Evaluation Metrics for 4G Canonical Scenario.

EARFCN	Number of Cells	N_{4G} collisions	$P_c(\%)$	T_{comp} (s)
6200	23	0	0.0	0.57

5.2.4 Implementation discussion

Being a cloud-based system, all the computing time and resources are not allocated on local machines, allowing their resources to be allocated to other processes that may be needed. This allows system flexibility and mobility, being that it is available anywhere. Implementing this system on AWS contributed greatly to making it more reliable and always available on any device. When working with sensitive data, such as planning and maintaining cellular networks data, security is one of the priorities, which is also better with cloud services, where 94% of companies have seen improved security when using cloud services [57]. All of these factors have been taken into account in order to develop a product that can ensure good customer use as well as facilitate its maintenance. It is important to refer, once again, the difference of time consumption between the developed cloud-based system and the previous SQL-based implementation, which led to an improvement of less 99% of time consumption for a scenario of 12484 cells, as the SQL system took 1748,3s and the developed systems takes only 7,39s.

This system also represents an innovation in the context of SON, enabling effective planning of network radio resources, namely SCs and PCIs, without any manual intervention on it. If human intervention is not required, the probability of finding errors decreases. Thus, by relating AWS to the implementation of this system, each *Lambda* makes a copy of the *bucket* contents and can fetch its inputs to a temporary file in the same space where it runs the *Lambda*.

Chapter 6

Conclusions and Future Work

6.1 Main Conclusions

The main objectives of this thesis were to develop a cloud-based system that allows an optimal planning of the resources of a cellular network. As this system is implemented in Metric SaaS, it also brings more value to this platform. In UMTS networks, this system focuses on the planning of SCs, which act as an identifier to each cell and in LTE networks, the aim is the correct allocation of PCIs, which has similar functions to SCs, although bringing more complexity. Both these resources are necessary for a good communication between the BS and the UE. Ultimately, this system adds ease and speed in the planning of SCs and PCIs.

Based on real OSS network configuration and performance data, it accurately estimates cells coverage, in two possible ways: the Geographical Identification of Neighbours (GIN) and the Coverage-based Identification of Neighbours (CbIN). The CbIN is used in more recent networks that allow an easy gathering of the necessary data. The GIN was developed for networks that are older or do not allow an easy access to the required data. Using either the options, neighbours are identified for each of the cells that belong to the network. Using CbIN, neighbours are those that reach the same location with a signal higher than -120 dBm, using GIN, the neighbourhoods are established using tiers, each tier defining a

neighbourhood level. Knowing all the neighbours of each cell, the system allocates the best resource to all the unplanned cells, always aiming at minimizing the interference in the network.

The system operation is demonstrated for a small canonical scenario for SCs and for PCIs a small realistic scenario is used. For the PCIs realistic scenario, for one site, the less interfering PCIs are found and allocated to its cells in under than 0.6 seconds. For a realistic scenario of an entire network, it outperforms an SQL-based implementation that takes 30 minutes to achieve poorer results. In fact, for 12484 unplanned cells, the planning of SCs takes less than 8 seconds, guaranteeing no collisions between 1st order neighbouring cells.

This work pattern has been integrated in SaaS Metric, which acts as an interface to the algorithmic planning of resources. It is shown that the implementation of this work in cloud services brings several benefits and is perfectly capable of performing the required processes, allowing the local system to be free for other necessary computing processes. The amount of cells to plan is only dependent on the user. As soon as the user requests the planning of cells, the system starts the necessary procedures, allowing the user to experiment a real time planning of the network. It is shown that with the robustness of this system, it is not necessary to plan surrounding cells, as it is possible to plan small cluster scenarios, or even a 1 site scenario. This system, being integrated in Metric, brings new features to this tool, making it more attractive to the market.

6.2 Future Work

The exponential growth of cellular networks and its infrastructures were a motivation for the development of this system, although it possible to improve or expand this system with some future work:

- An interesting topic would be to produce the results visually, in order to allow the user a more intuitive way to view results as to analyze viability in

small scenarios. As this is a backend software system, results are not easy to demonstrate.

- Expand the system to other technologies: In this dissertation, 3G and 4G cellular networks were addressed, although it is possible to expand this system to 2G BCCHs, despite being an older technologies it is still widely used in developing countries. It is also possible to adapt this system to 5G, in order to plan its resources.

References

- [1] J. Eberspächer, H. J. Vögel, C. Bettstetter, and C. Hartmann, *GSM - Architecture, Protocols and Services: Third Edition*. Wiley, 2008.
- [2] M. L. J. Vora, “Evolution of Mobile Generation Technology : 1G To 5G and Review of Upcoming Wireless Technology 5G,” *Scientific Journal Impact Factor*, vol. 2, no. 10, pp. 281–291, 2015.
- [3] H. Holma and Antti Toskala, *WCDMA for UMTS*. Wiley, 2008.
- [4] C. Kappler, *UMTS Networks and Beyond*. Wiley, 2009.
- [5] F. D. Prisco, “UMTS Architecture for Integrating Terrestrial and Satellite Systems,” *IEEE MultiMedia*, vol. 6, pp. 38–45, 1999.
- [6] C. Smith and D. Collins, *3G Wireless Networks*. McGraw-Hill, 2001.
- [7] M. D. Yacoub, *Wireless Technology: Protocols, Standards, and Techniques*. CRC Press, 2017.
- [8] M. Sauter, *From GSM to LTE-Advanced Pro and 5G*, 3rd ed. Wiley, 2017.
- [9] H. Holma and A. Toskala, *LTE for UMTS Evolution to LTE-Advanced*, 2nd ed. Wiley, 2011.
- [10] Electronicnotes, “LTE OFDM, OFDMA SC-FDMA & Modulation.” [Online]. Available: <https://www.electronics-notes.com/articles/connectivity/4g-lte-long-term-evolution/ofdm-ofdma-scdma-modulation.php>

- [11] S. Sesia, I. Toufik, and M. Baker, *LTE - The UMTS Long Term Evolution*, 2nd ed. Wiley, 2011.
- [12] E. Dahlman, P. Stefan, and J. Skold, *4G LTE/LTE-Advanced for Mobile Broadband*. AP, 2011.
- [13] H. Holma and A. Toskala, *LTE for UMTS - OFDMA and SC-FDMA based radio access*. Wiley, 2009.
- [14] 3GPP, “TS 136 211 - V14.2.0 - LTE; Evolved Universal Terrestrial Radio Access (E-UTRA); Physical channels and modulation (3GPP TS 36.211 version 14.2.0 Release 14),” 3GPP, Tech. Rep., 2017.
- [15] C. Cox, *An Introduction to LTE*. Wiley, 2012.
- [16] J. G. Rémy and C. Letamendia, *LTE Services*. Wiley, 2014, vol. 9781848217.
- [17] “Cellular Network.” [Online]. Available: <http://www.telecomabc.com/c/cellular.html>
- [18] P. Telecommunications, “Mobile Base Stations.” [Online]. Available: <http://mobilenetworkguide.com.au/>
- [19] L. Song and J. Shen, *Evolved Cellular Network Planning and Optimization for UMTS and LTE*. CRC Press, 2011, vol. 91.
- [20] Y.-H. Jung and Y. H. Lee, “Scrambling Code Planning for 3GPP W-CDMA Systems,” in *IEEE VTS 53rd Vehicular Technology Conference, Spring 2001. Proceedings (Cat. No.01CH37202)*. Korea Advanced Institute of Technology Department of EECS, 2001, pp. 2431–2434.
- [21] P. Pina, D. Fernandes, D. Clemente, G. Soares, and P. Sebastião, “Cloud-based Implementation of an Automatic Pixel-based Neighbour Identification System for Cellular Networks,” *WPMC2019*, pp. — — —, 2019.
- [22] J. E. Ramiro and K. E. Hamied, *Self-organizing networks*. Wiley, 2012.

- [23] M. Panico, I. Francalanci, G. Bini, and M. Ludovico, “Method for the assignment of scrambling codes to cells of a CDMA cellular mobile communications network,” 2007.
- [24] “Scrambling Codes.” [Online]. Available: http://www.sharetechnote.com/html/Handbook_UMTS_ScramblingCode.html
- [25] B. Gi and K. Byoung-Hoon, *Scrambling Techniques for CDMA Communications*. Kluwer Academic Publishers, 2002.
- [26] S. Hämäläinen, H. Sanneck, and C. Sartori, *LTE Self-Organising Networks (SON)*. Wiley, 2012. [Online]. Available: www.wiley.com.
- [27] 3GPP, “3GPP TS 36.300,” 3GPP, Tech. Rep. Release 11, 2010.
- [28] ———, “TS 132 521 - V9.0.0 - Self-Organizing Networks (SON) Policy Network Resource Model (NRM),” 3GPP, Tech. Rep., 2010.
- [29] R. Kreher and K. Gaenger, *LTE Signaling, Troubleshooting, and Optimization*. Wiley, 2010.
- [30] A. Perez, “LTE and LTE Advanced: 4G Network Radio Interface,” in *LTE and LTE Advanced: 4G Network Radio Interface*. Wiley, 2015, ch. 7, pp. 177–239.
- [31] 3GPP, “ETSI TS 136 211 V10.0.0 (2011-01) Technical Specification,” 3GPP, Tech. Rep., 2014.
- [32] “GENEX U-Net.” [Online]. Available: <https://pt.scribd.com/presentation/52172846/GENEX-U-Net-Functions-and-Application>
- [33] H. Hafez and A. Rabie, “Scrambling Code Planning and Optimization for UMTS System,” *IEEE WCNC*, 2014.
- [34] Y. Liu, W. Li, H. Zhang, and L. Yu, “Distributed PCI assignment in LTE based on consultation mechanism,” *2010 6th International Conference on Wireless Communications, Networking and Mobile Computing, WiCOM 2010*, pp. 1–4, 2010.

- [35] F. Ahmed and O. Tirkkonen, "Self organized physical cell ID assignment in multi-operator heterogeneous networks," *IEEE Vehicular Technology Conference*, 2015.
- [36] J. Oppolzer and R. Bestak, "Physical Cell Identifier assignment in LTE-advanced networks," *Proceedings of 2012 5th Joint IFIP Wireless and Mobile Networking Conference, WMNC 2012*, pp. 70–74, 2012.
- [37] I. Poole, "Self Organising Networks, SON." [Online]. Available: <https://www.radio-electronics.com/info/cellulartelecomms/self-organising-networks-son/basics-tutorial.php>
- [38] J. Acharya, L. Gao, and S. Gaur, *Heterogeneous Networks in LTE-Advanced*. Wiley, 2014, vol. 9781118511.
- [39] TEOCO, "ASSET - Radio Network Planning Tool for GSM, UMTS, LTE and 5G." [Online]. Available: <http://www.teoco.com/products/planning-optimization/asset-radio-planning/>
- [40] Forsk, "Atoll overview." [Online]. Available: <https://www.forsk.com/atoll-overview>
- [41] TEOCO, "Capesso." [Online]. Available: <https://www.teoco.com/wp-content/uploads/CAPESSO-Brochure.pdf>
- [42] "Excel VBA." [Online]. Available: <https://corporatefinanceinstitute.com/resources/excel/study/excel-vba/>
- [43] "Mentor (RAN Optimization & Analytics)." [Online]. Available: <http://www.teoco.com/products/planning-optimization/mentor-ran-optimization/>
- [44] "XCAL." [Online]. Available: http://accuver.com/acv_products/xcal/
- [45] "MUSA." [Online]. Available: <https://pt.scribd.com/document/354035128/20130618-Musa-Ada-Lte-Pci-Rsi-Planning-New>
- [46] "Metric." [Online]. Available: <https://www.metric.pt>

- [47] G. Lin, D. Fu, J. Zhu, and G. Dasmalchi, “Cloud computing: IT as a service,” *IT Professional*, vol. 11, no. 2, pp. 10–13, 2009.
- [48] “Amazon Web Services.” [Online]. Available: <https://aws.amazon.com>
- [49] “Google Cloud.” [Online]. Available: <https://cloud.google.com>
- [50] “Microsoft Azure.” [Online]. Available: <https://azure.microsoft.com>
- [51] “OpenTopography.” [Online]. Available: <https://opentopography.org>
- [52] R. Cortesão, L. Ferreira, P. Sebastião, D. Fernandes, D. Clemente, and G. Soares, “Scrambling Code Planning for UMTS Cellular Networks,” *ConfTele2019*, 2019.
- [53] D. Fernandes, L. S. Ferreira, M. Nozari, P. Sebastiao, F. Cercas, and R. Dinis, “Combining Drive Tests and Automatically Tuned Propagation Models in the Construction of Path Loss Grids,” in *IEEE International Symposium on Personal, Indoor and Mobile Radio Communications, PIMRC*, vol. 2018-Septe, 2018, pp. 1161–1162.
- [54] “Java.” [Online]. Available: <https://docs.oracle.com/javase/7/docs/technotes/guides/language/>
- [55] “JavaScript Object Notation.” [Online]. Available: <https://www.json.org>
- [56] R. Cortesão, L. Ferreira, P. Sebastião, D. Fernandes, D. Clemente, and G. Soares, “Cloud-based Implementation of a SON Automatic Planning System : a proof-of-concept for UMTS,” *WPMC2019*, 2019.
- [57] RapidScale, “Cloud Computing Stats - Security and Recovery,” RapidScale, Tech. Rep., 2015.

Appendices

Appendix A

Publications

The accepted articles at the ConfTele2019 and WPMC2019 conferences are presented in this appendix.

A.1 Scrambling Code Planning for UMTS Cellular Networks, Conftele2019

Scrambling Code Planning for UMTS Cellular Networks

Rodrigo Cortesão^{¶*}, Lúcio Studer Ferreira^{‡†}, Pedro Sebastião[¶], Daniel Fernandes[¶],
Diogo Clemente[¶] and Gabriela Soares[‡]

[¶]ISCTE-IUL / Instituto de Telecomunicações, Av. das Forças Armadas 376, 1600-077 Lisbon, Portugal

[‡]Multivision - Consultoria, Rua Soeiro Pereira Gomes, Lote N^o 1, 3^oC, Lisbon, Portugal

[†]INESC-ID/Universidade Lusfada, Rua da Junqueira, 188-198, Lisbon, Portugal

*Email: rrlco@iscte-iul.pt

Abstract—In mobile network deployments of growing size, the optimum and fast planning of radio resources are a key task. An adequate distribution and reuse of the limited resources that the network has at its disposal is needed, which includes, in UMTS, the allocation of Scrambling Codes (SCs) to cells. An algorithm for SC planning is proposed. This algorithm aims to guarantee a rigorous, simple and fast planning of SCs, that aims to reduce interference among cells. The algorithm is demonstrated with an example of a small reference scenario. For a realistic scenario with 12 484 cells, the planning of SCs of a new site, with 6 cells of two different frequencies, takes less than a second and guarantees no collision between cells.

Index Terms—scrambling codes, UMTS, algorithm

I. INTRODUCTION

The consumption of mobile data has been growing exponentially [1], leading to a considerable expansion of mobile communication networks infrastructures. For a correct operation of the network and to provide a good quality of service, as well as experience, it is necessary that telecommunications systems are in constant development. This development means that the systems involved are becoming faster and more autonomous. Therefore, in the current context of the operation of 3G mobile communication networks, the constant optimization of existing models is essential, in order to bring the network planning and the reality that is lived closer.

Cellular networks work on a shared environment, which requires an efficient reuse of resources. This demands strict planning as well as constant optimization and maintenance. In the context of Self Organized Networks (SON), some of the challenges are the correct network planning, maintenance and optimization [2], such as the correct allocation of Scrambling Codes (SC) in Universal Mobile Telecommunications System (UMTS) without interference between cells. In collaboration with Multivision [3], this is the problem that is intended to be solved, creating an algorithm that does the planning of SCs and does not allow the overlap between them. The goal of the present work is to implement this algorithm in a platform owned by Multivision, denominated Metric [4], which is a Software-as-a-Service (SaaS).

The remaining sections of this paper are organized as follows: Section II presents a background which provides a brief framework necessary for the theme presented in this article. In Section III, the proposed algorithm for SCs planning

is presented, describing it as well as its parameters and the evaluation methods. In Section IV, evaluation scenarios developed to make a rigorous evaluation of the algorithm presented, are introduced. Section V presents the results obtained for the evaluation scenarios. Finally, some conclusions are presented in Section VI, as well as the future work.

II. BACKGROUND

UMTS presents the 3rd generation of mobile communication systems [5]. UMTS carrier frequencies are designated by a UTRA Absolute Radio Frequency Channel Number (UARFCN), which is a number used to define channel frequency in an easy and unambiguous fashion.

In Code Division Multiple Access (CDMA), the process of codes attribution has two different phases, and therefore two different codes, with distinct purposes. In spreading, the channelization codes intend to align signals to an equal chip rate, which is larger than the symbol rate (one symbol is represented by multiple chips). The Scrambling Codes have the same function in two different cases: in downlink, they are used to distinguish different eNodeBs using the same UARFCN, in the point of view of the Mobile Station (MS); in uplink, to distinguish various MSs from the eNodeB point of view. This article addresses downlink SCs. In the case of two channels that are in the range of a MS, using the same spreading code, it is strictly necessary for them to use different SCs, as only this way the MS can differentiate the two channels. SCs do not modify the signal bandwidth (chip rate is not altered) as they are operated on top of spreading, only making eNodeB signals distinguishable [5], [6].

In UMTS, there are 8192 available SCs, divided into 512 groups of 16 scrambling codes. The first SC of each group is the Primary Scrambling Code (PSC), and the 15 others are the Secondary Scrambling Codes (SSC). In order to make a correct planning, it is only needed to plan the allocation of PSCs, as these are the ones that make the distinction between cells [7]. Therefore, in the downlink, there are only 512 available SCs for planning.

UMTS is a cellular system, where a cell corresponds to the service area covered by an eNodeB antenna. A site is a geographic location where multiple eNodeBs of different UARFCNs may be located, each having its antenna pointed

towards a given direction, these cells being designated as sectors. Typically, these are deployed on various layers, existing a layer of large macro-cells that provide coverage, having a layer below of smaller micro-cells that provide capacity, also existing pico-cells, used to provide capacity for specific spots.

For each UARFCN, the allocation of SCs is a key planning issue, in order to guarantee that the MS's reception from a cell is not interfered by neighbouring ones. A first issue is the way SCs are distributed within the cells of a site. Two strategies of grouping are often used, by consecutive or discrete, i.e., spaced by a given value, as depicted in Figure 1.

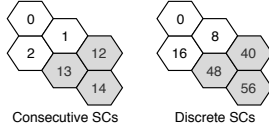

Fig. 1. Examples of SCs grouping strategy

For sites with cells of different UARFCNs, operators define a SC strategy, to relate the allocation of SC groups. A reference UARFCN frequency is identified to be used in the planning. Once one site is planned for the reference frequency, for the other frequencies, the corresponding SC group is selected based on the SC UARFCN strategy specification. The SC strategies per site and UARFCN are client specifications. The algorithm must be robust to accept any of these specifications.

As the number of available SCs is limited, in a large cellular deployment, SCs may need to be reused for an operating UARFCN. The distance between cells using the same SC shall be sufficiently large to guarantee that no interference (collisions) between neighbours occurs.

III. PLANNING OF CELLS' SCRAMBLING CODES

An algorithm is proposed for an easy and effective assignment of SCs to a subset of cells of a cellular deployment. Such a case occurs, for example, when a new site is deployed in an existing network.

A maximum distance of neighbours, d_{first_neighb} , is defined, to identify a 1st order neighbourhood of cells. A conservative approach could be to consider the maximum range of macro cells in UMTS (35 km), but it may vary, depending on the scenario. For a given cell (so-called based cell), the 1st order neighbourhood identifies the set of cells that are within d_{first_neighb} . The range of the 2nd order neighbourhood, d_{second_neighb} , is predefined as $2d_{first_neighb}$, although it can be modified by the user as well as d_{first_neighb} .

The algorithm has one rule: the SC of one cell can not be used by its 1st order neighbours. Metrics are defined to make a rigorous evaluation of the algorithm, such as the number of collisions to 1st order neighbours (which must be zero) and the number of collisions and distance to 2nd order neighbours. This last type of collisions may happen, however it has to be with the neighbour that is further away from the base cell minimizing the interference, therefore the distance to the 2nd order neighbours is also verified.

The algorithm aims to plan SCs of unplanned cells. This algorithm was implemented using Java and it extracts from Metric the needed information for each cell, returning the best SC group for each of the unplanned sites. The bridge used between the algorithm and Metric is the Amazon Web Services (AWS) as all the information needed is extracted from there and the outputs are uploaded to AWS using AWS Simple Storage Service (S3). The algorithm was also implemented as an AWS function, using AWS Lambda, which is a scalable service that runs code only when necessary. In order to make a rigorous and fast allocation of SCs, the neighbours calculation and the SCs planning algorithms were divided into two different algorithms that can be used together.

A. Neighbours Calculation Algorithm

The neighbours calculation algorithm is easily adjustable to be used on other networks and it can be helpful on other planning algorithms. As input it must have d_{first_neighb} and d_{second_neighb} , if these are not specified it automatically assumes d_{first_neighb} to be 35 kilometers and d_{second_neighb} as $2d_{first_neighb}$.

For each cell (so-called base cell), 1st and 2nd order neighbours are identified. First, distances from the base-cell to the remaining cells of the network are calculated. Through the Haversine formula [8], with Expressions 1, 2 and 3, it is possible to calculate the distance between two points on the Earth surface as follows,

$$a = \text{sen}^2\left(\frac{\Delta\phi}{2}\right) + \cos(\phi_1) \times \cos(\phi_2) \times \text{sen}^2\left(\frac{\Delta\lambda}{2}\right) \quad (1)$$

$$c = 2 \times \arctan2(\sqrt{a}, \sqrt{1-a}) \quad (2)$$

$$\text{distance} = R \times c \quad (3)$$

where ϕ and λ are the cells' latitude and longitude, and R is the Earth radius. This way, given a maximum distance to be considered neighbour, d_{neighb} , it is possible to calculate each of the neighbours. Using this, the algorithm builds lists of 1st and 2nd order neighbours, registering, for each neighbour, its distance and the used SC.

The algorithm divides the neighbours by frequency, making it easier to plan the SCs afterwards. So a site that transmits on two distinct frequencies as two different sets of neighbours, one for each UARFCN. As cells may be co-located, this calculation of neighbours is made per-position and not per-cell, so that repeated sets of neighbours may not exist.

B. SCs Planning Algorithm

The developed algorithm for the SCs allocation per site is modelled in Figure 2. All the inputs are directly gathered from AWS, and then processed. It has the following:

- Neighbours information, which is the output from the neighbours calculation algorithm.
- Cells' information, including its name, site it belongs to, position (latitude and longitude), UARFCN and used SC.

This is a file that has information about each cell of the network. Also includes the list of sites to be planned.

- Client specifications, identifying the SCs site and UARFCN strategies, as well as the reference UARFCN frequency to be used in the planning and the intended distribution of SCs.

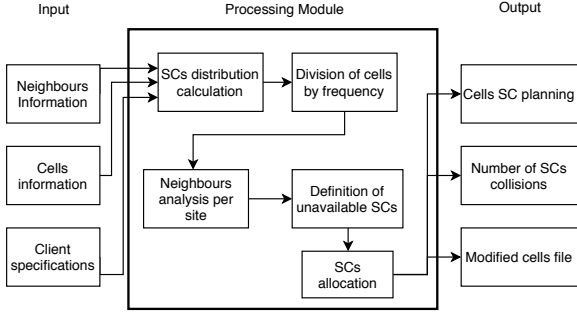

Fig. 2. Planning Model

The main procedures taken by the developed algorithm are described in detail next.

1) *SCs distribution calculation*: Depending on the client specification (discrete or consecutive), the algorithm builds the set of SCs to use, always with values between 0 and 511.

2) *Division of cells by frequency*: One site may have various cells that use different frequencies. As long the frequency is different, cells might use the same SCs (depending on the client specifications). In this step, the network cells are divided by frequencies (UARFCN), allowing to make a planning for each frequency individually by creating sub-networks of different frequencies.

3) *Neighbours analysis per site*: For each of the unplanned site, an analysis of its neighbours is performed, allowing to know which are the unavailable and the ones farthest from the base cell.

4) *Definition of unavailable SCs*: For each unplanned cell, the set of unavailable SCs (the ones used by 1st order neighbours) is identified.

5) *SCs allocation*: To make the planning of the SCs, there are two possible situations. The first one happens when there is still an available group that is not assigned to any of the 1st and 2nd order neighbours. This is the most desirable situation for planning as it prevents any kind of collision. However, in urban areas, it is difficult to happen due to the high density of cells. This process usually happens for the reference frequency.

The second situation, and the most realistic, is that it is necessary to reuse a group of SCs (or at least one SC) that already belongs to some 2nd order neighbour, as SCs used by 1st order neighbours are always to be avoided. In this case, the most distant SC group is assigned, as described by Algorithm 1.

Once SCs are allocated for the reference frequency, cells using different UARFCN are planned following the client's SC UARFCN strategy. As output, a SC is indicated for each unplanned cell, together with information of the number of

Algorithm 1 Find the best possible group of SCs for site

Input: $SCsMap$, hashmap key is group, value is its the list of SCs; $cellsToPlan$, an arraylist of the cells to plan

```

1: procedure FINDLESSBADGROUP( $scramblingCodesMap$ ,  $cellsToPlan$ )
2:    $groupsDist \leftarrow hashmap()$   $\triangleright$  Empty hashmap
3:   for  $group$  in  $SCsMap$  do
4:     if  $group.size = cellsToPlan.size$  then
5:       for  $sc$  in  $group$  do
6:         if  $cellsToPlan.distanceToSCs$  contains  $sc$  &  $cellsToPlan.usedSCByFirstOrder$  not contains  $sc$  then
7:           for  $scAux$  in  $distanceToSCs$  do
8:              $dist = distanceToSCs.scAux$ 
9:             if  $dist < groupsDist.group$  then
10:               $groupsDist.group = dist$ 
11:            else
12:               $groupsDist += (group, dist)$ ;
13:           $entry \leftarrow int$ ;  $maxDist \leftarrow int$ 
14:          for  $gr$  in  $groupsDist$  do
15:            if  $groupsDist.gr > maxDist$  then
16:               $maxDist = groupsDist.gr$ ;
17:             $entry = gr$ ;
18:           $assignGroup(cellsToPlan, groupToUse)$ 
  
```

collisions with 1st and 2nd order neighbours of the newly planned cells and the updated cells information file.

IV. EVALUATION SCENARIOS

The reference scenario is depicted in Figure 3, with 8 sites, all having planned SCs except Site 1, for both 10562 and 10687 UARFCN frequencies in the 2.1 GHz band. In this scenario, d_{first_neighb} is considered 2500 meters and d_{second_neighb} is 3500 meters.

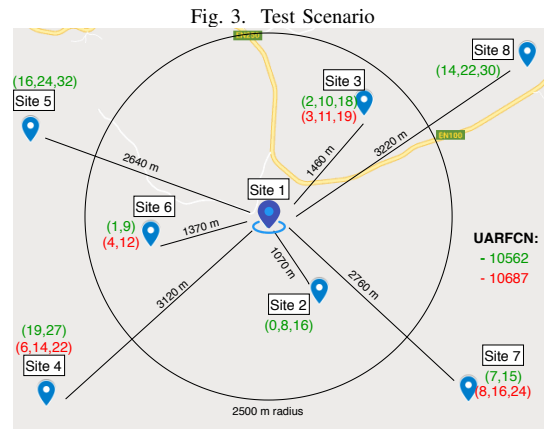

Fig. 3. Test Scenario

In Figure 3, the used SCs by each site are presented. Each cell uses one SC, the number of SCs indicating the number of cells of a given site. Some sites only operate in one frequency (UARFCN). In the scenario, the unplanned Site 1 (S1) has two cells on each UARFCN.

Another necessary inputs are the client specifications, indicating the reference frequency, as well as SC strategy per site and UARFCN. The reference UARFCN is 10562, being the first to be planned. Cells of any site operating in the same UARFCN must have SCs spaced by 8 as it is understood from the existing planning of the planned sites. Unplanned site S1 has two cells, the list of available groups of two SCs being given in Table I. The list is small enough to force the algorithm to reuse at least one SC from its neighbours. In fact, if an unused SC group would be available, the algorithm would directly choose it, which is a simple solution.

TABLE I
LIST OF AVAILABLE SCs GROUPS OF TWO CELLS

Group	SCs	Group	SCs
1	(0, 8)	5	(22, 30)
2	(2, 10)	6	(16, 24)
3	(8, 16)	7	(19, 27)
4	(14, 22)	8	(24, 32)

The reference UARFCN is 10562, and for a different UARFCN, the SC group to be used must be the next one, compared to the reference frequency. This is an important client specification as it describes the network layout.

A real scenario is also considered for evaluation. It corresponds to an UMTS network of 1719 sites, with 1 to 3 cells operating in up to 5 different frequencies, an universe of 12484 cells. From these, 44 cells are unplanned. The whole universe of 512 SCs is considered for planning (depending on the neighbours), and the SC site and UARFCN allocation strategy is similar to the one of the reference scenario.

V. RESULTS

The algorithm starts by identifying the 1st order neighbours of site S1, for each of the operating frequencies, based on UARFCN. By analyzing Figure 3, it is noticed that for the UARFCN 10562, S2, S3 and S6 are 1st order neighbours of S1, as they are within d_{first_neighb} . The other sites, S4, S5, S7 and S8 are 2nd order neighbours of S1 as they are between d_{first_neighb} and d_{second_neighb} meters of distance. Regarding UARFCN 10687, S2, S5 and S8 do not operate in this frequency, not being neighbours of S1, as shown in Figure 3. Therefore, the 1st order neighbours are S3 and S6, and the 2nd order neighbours are S4 and S7.

Once the neighbours are identified, the planning algorithm must select, for S1, the SC group with less collisions for UARFCN 10562. All SC groups have SCs used within the 1st or 2nd order neighbours, so there is no SC available without collisions. A SCs group must be found, of SCs not used by 1st order neighbours, and with lowest collisions. From Table I, it can be seen that the groups without SCs used by 1st order neighbours are group 4 (of SCs 14 and 22), group 5 (22, 30), group 7 (19, 27) and group 8 (24, 32). From the 2nd order neighbours sites, the most distant of S1 is site S8. Thus, the chosen group shall have SCs among the ones used on that site, SCs 14, 22 and 30 (minimizing collisions). Group 4 (14, 22) and 5 (22,30) are available, group 4 being chosen for

reference frequency UARFCN 10562 as S5, which is closer than S8, uses the SC 30.

As the frequency interval is assumed as 1 (given as input), for UARFCN 10687 the algorithm tries to use the group immediately after group 4, which is group 5 (22, 30). The algorithm makes a verification if any of the SCs on that group are used by the 1st order neighbours of S1 on 10687. If it finds that any of the SCs are already used, it discards the group and finds the best option. In this case, none of the SCs are used by any of the 1st order neighbours, being that only SC 22 is used by the farthest 2nd order neighbour, S4. Therefore, this group can be used and is the chosen one for this UARFCN.

Resuming, for the unplanned site S1, for the reference UARFCN (10562), the SCs group used is group 4 (SCs 14 and 22) and for UARFCN 10687, the group immediately next to the one used on the reference UARFCN is used, that is, group 5 (SCs 22 and 30). This planning does not present collisions with 1st order neighbours and presents 3 collisions with 2nd order neighbours, which were supposed to happen. The planning is good and the expected.

Regarding the real scenario, none of 12484 the cells of the network remained unplanned, and none has collisions with 1st and 2nd order neighbours, evidencing the efficiency of the proposed algorithm, taking 918 milliseconds to optimize the SCs (3GHz processor, 72 000 MIPS).

The final output is uploaded to AWS S3, making it easy to access on Metric.

VI. CONCLUSIONS AND FUTURE WORK

In this paper a new SCs planning algorithm is proposed. It satisfies any possible customer's specifications in terms of rules of allocation of SCs to the cells of a site, and for different frequencies. In order to minimize interference, the algorithm weights 1st and 2nd order neighbours' distances, selecting the most distantly used SC group. For a realistic scenario with 12484 cells, the planning of SCs of a new site, with 6 cells of two different frequencies, takes less than half a second and guarantees no collision between cells. The future work is to implement this algorithm on Metric and evaluate its performance in planning an entire network.

VII. ACKNOWLEDGMENT

This work is part of the OptiNET-5G project, co-funded by Centro2020, Portugal2020, European Union (project 023304).

REFERENCES

- [1] D. Webster, "Cisco Visual Networking Index (VNI)," Cisco, Tech. Rep., 2017.
- [2] S. Hämäläinen, H. Sanneck, and C. Sartori, *LTE Self-Organising Networks (SON)*. Wiley, 2012. [Online]. Available: www.wiley.com.
- [3] "Multivision." [Online]. Available: <http://www.multivision.pt>
- [4] "Metric." [Online]. Available: <https://www.metric.pt>
- [5] H. Holma and Antti Toskala, *WCDMA for UMTS*. Wiley, 2008.
- [6] M. D. Yacoub, *Wireless Technology: Protocols, Standards, and Techniques*. CRC Press, 2017.
- [7] B. Gi and K. Byoung-Hoon, *Scrambling Techniques for CDMA Communications*. Kluwer Academic Publishers, 2002.
- [8] N. R. Chopde and M. K. Nichat, "Landmark based shortest path detection by using Dijkstra Algorithm and Haversine Formula," *International Journal of Engineering Research and Applications*, vol. 3, no. 2, 2013.

A.2 Cloud-based Implementation of a SON Automatic Planning System: a proof-of-concept for UMTS, WPMC2019

Cloud-based Implementation of a SON Automatic Planning System: a proof-of-concept for UMTS

Rodrigo Cortesão^{*¶}, Daniel Fernandes^{*}, Diogo Clemente^{*},
Gabriela Soares[†], Pedro Sebastião^{*} and Lúcio S. Ferreira^{†‡§}

^{*}ISCTE-IUL / Instituto de Telecomunicações, Av. das Forças Armadas 376, 1600-077 Lisbon, Portugal

[†]Multivision - Consultoria, Rua Soeiro Pereira Gomes, Lote N^o1, 3^oC, Lisbon, Portugal

[‡]ISTEC, A. das Linhas de Torres 179, 1750-142 Lisboa, Portugal

[§]Universidade Lusfada de Lisboa INESC-ID/, Rua da Junqueira 188-198, Lisbon, Portugal

[¶]Email: rrlco@iscte-iul.pt

Abstract—In mobile network deployments of growing size, the optimum and fast planning of radio resources are a key task. Cloud services enable efficient and scalable implementation of procedures and algorithms. In this paper, a proof of concept implementation of a cloud-based network planning work pattern using Amazon Web Services is presented. It extracts configuration and performance data from the network, enabling to accurately estimate cells coverage, identify neighbouring cells and optimally plan Scrambling Codes (SC) in an UMTS network. It was integrated in a SaaS monitoring and planning tool. The system operation is demonstrated for a small canonical scenario. For a realistic scenario with 12 484 unplanned cells, the planning of SCs is efficiently achieved, taking less than 8 seconds, and guaranteeing no collisions between first order neighbouring cells.

Index Terms—cloud services, monitoring, cellular planning, UMTS, scrambling codes

I. INTRODUCTION

Mobile data has been growing exponentially [1], requiring a continuous densification and evolution of network infrastructures to guarantee a good quality of service. On the other side, the availability of cloud-based services makes available elastic and on-demand processing, storage and networking resources. Cellular networks have demanding requirements in terms of capacity and latency, being composed of thousands of cells that share the wireless medium. Some of the challenges are the correct network planning, maintenance and optimization in a Self Organized Network context [2]. Self Organized Networks (SONs) aim to make the network planning autonomous, that is, without constant intervention by man. In this way, the concept of SON arises, where the objective is to facilitate all numerous processes, which brings several benefits to the operators [3]. SONs represent an important part of what base station functionalities are, making it possible to coordinate between base stations that were previously not possible, making important automated configurations such as Cell ID, which was previously done by professionals manually [4]. There are four main components in the SONs context: Self-Planning, Self-Deployment, Self-Healing and Self-Optimization. In this work, not only Self-Planning is addressed but also Self-Healing, as when the network is performing poorly, it proposes its planning in the affected zones.

The current work presents a novel cloud-based work pattern for planning cellular networks, implemented using Amazon Web Services (AWS) [5]. It is a SON implementation, where the cloud services enable a serverless automatic network planning and monitoring. Cloud services make available storage, computation and networking resources elastically and on demand. Widely used in information systems, this paradigm has been extended to more demanding systems such as telecommunication networks. This work proposes a solution that presents a platform for the control and management of cloud-based network resources, which is different from a Cloud Radio Access Network (C-RAN).

This system enables a holistic vision of the network and an efficient implementation of optimization algorithms. As proof-of-concept, the classical challenge of allocating Scrambling Codes in Universal Mobile Telecommunications System (UMTS) is addressed. Scrambling Codes (SC) have the main function to distinct base stations. In the downlink, only long scrambling codes (38400 chips) are used. In the case of two channels, in the range of a Mobile Station (MS), are using the same spreading code, it is strictly necessary for them to use different scrambling codes, only this way the MS can differentiate the two channels and choose the right receiver in the unscrambling process [6]. There are 8192 SCs, these are divided into 512 sets which means each set has 16 scrambling codes. Only the first SC of each set is required for planning, therefore there are 512 available SCs to plan the network. By making a correct allocation of SCs to cells, we aim at minimizing interference between cells. This pattern and associated algorithms are efficiently implemented in the Metric [7] Software-as-a-Service (SaaS).

The remaining paper is structured as follows. Section II presents some related work, such as the tool we intend to improve and also others that are available in the market. Section III addresses the network monitoring and planning pattern followed. Section IV details the processing modules of this pattern. The implementation in AWS and integration in Metric is described in Section V. Canonical and realistic evaluation scenarios are described in Section VI, while results are presented in Section VII. Finally, conclusions are drawn in Section VIII.

II. CELLULAR PLANING TOOLS

There are a wide variety of tools for planning network resources. Atoll [8] is a multi-technology platform owned by Forsk, developed for optimization and network design. It is possible to use predictions and live network data to help in the process of planning. Huawei's GENEX U-Net Radio Planning Tool [9] is a tool that makes planning of SCs easier, however it is always necessary to manually configure some values such as the minimum reuse distance and other network limitations. The need of manually configure values, both in Atoll and Huawei's tool, brings errors and a high time spent.

Several algorithms for planning are also available in the literature. An algorithm capable of allocate and detect collisions of SCs in two ways: through the reuse distance and through avoiding the N^{th} Tier Neighbour Clashes [10]. In the event of a collision, a new SC is assigned. Although this may be an effective way to allocate SCs, in urban areas where the presence of base stations is dense it can have some errors. Two types of SC planning are proposed by [11], through cluster reuse and through graph coloring. This method showed that sometimes it is not able to plan SCs, depending on the network characteristics.

Metric [7], which is the tool that we intend to improve, is a commercially available SaaS, from Multivision. On a pay-per-use basis and in a one-to-many model by all contracted costumers, it is based on one set of data definitions and common code. This service is delivered over the web and it can be accessed by any fixed or mobile device. Metric is multi-technology as it works with 2G, 3G and 4G networks and multi-data sources, which are all together in one environment. It is also multi-vendor. Through proprietary algorithms, Configuration Management, Performance Management, and DTs, data can be visualized through maps or tables, failures are identified (such as crossed sectors, overshooting cells, incorrect or missing neighbours lists). It aims to ease the network management and optimization. Metric is the platform where the developed system is already implemented. There is a SQL-based implementation of SC planning that only uses distances between cells to plan SCs, not implemented in Metric, that is used to assist Metric whenever a client needs to plan its SCs. Using Metric, the client only has to specify its requirements when planning the network for the first time.

III. NETWORK MONITORING AND PLANNING PATTERN

The architectural framework that supports the proposed planning system is described next. In a mobile network, users make an abundant use of mobile services, which generates aggregate traffic in the Radio Access Network (RAN) cells. Above the RAN, there is a control layer, the Operations Support System (OSS) that allows to configure and monitor network elements. In this particular situation we intend to correctly manage the resources available on the network, which are limited. It is through the data provided in monitoring that this level of control is based, which follows the framework represented in Figure 1, in order to monitor, plan and optimize cellular network resources. To enable interaction with the

OSS, the system is based on cloud. This framework uses three different processing modules and this modules may use as input, the output of another modules. The Cell Coverage Estimation module is responsible to provide propagation grids of each cell of the network, containing the coverage estimation in every pixel (unity of area for geographical positions) of the antennas service area, which may be represented in a heatmap. Using this propagation grids, it is possible to establish a neighbourhood for each cell (Neighbourhood Establishment Module). Only with a solid neighbourhood, it is possible to successfully complete the Cellular Planning module (SCs planning).

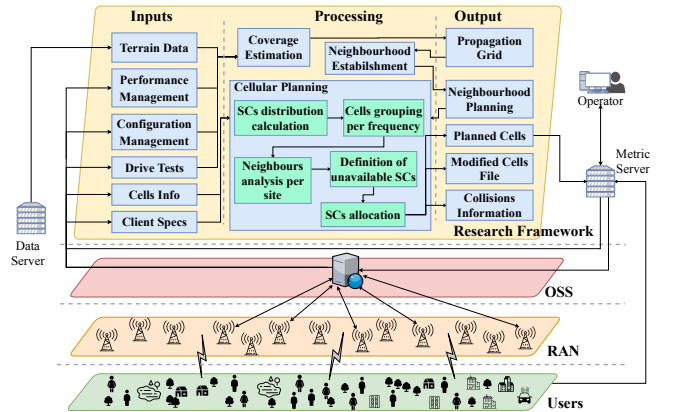

Fig. 1. Work pattern followed.

Via Metric, the network planning engineer may run the Cellular Planning service, triggering the work pattern to extract and process information and run the associated algorithms. The various steps of this pattern are detailed in the next sections.

IV. PROCESSING MODULES

A. Coverage Estimation

A module for estimation of cell coverage is used, based on a propagation model [12] that is calibrated with Drive Tests (DT's). For each cell, a grid of received signal levels for geolocated pixels around the cell is generated. As can be seen in Figure 1, in order to work correctly and provide accurate propagation grids of cells, this algorithm needs several inputs, such as DT's, information about each cell and terrain altimetry data, which is obtained directly from OpenTopography [13]. In Figure 2 is an example of a propagation grid of one cell.

B. Neighbourhood Establishment

In this module, based on the propagation grids of the cell coverage estimation module, the neighbourhood is defined for each cell of the network. From the propagation grid of each cell, neighbouring and interfering cells are analyzed. Using another developed algorithm, the list of neighbours is established. Two interfering cells are any two cells in which each others signals reach the same location (referred as pixels). However, two interfering cells are not necessarily neighbours. For two cells to be considered neighbours, they have to be

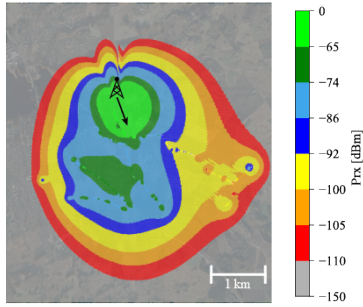

Fig. 2. Propagation grid of the received signal.

interfering and have a received signal level, P_{rx} , higher than -120 dBm in the same pixel. A count is also made of the number of pixels in which the cells interfere, in order to classify the degree of neighbourhood; this because the more interfering, the more they interfere and with more power intensity. A collision happens when two neighbouring cells use the same resource, in this case, the same SC. Knowing the most interfering cells, it is possible to properly avoid SC collisions between neighbouring cells.

There are two types of neighbours: 1st order neighbours and 2nd order neighbours. The 1st order neighbours are those that interfere directly with a base cell with a power intensity higher than -120 dBm and the 2nd order ones are those that interfere directly, also with a power intensity higher than -120 dBm, with the 1st order neighbours of the base cell.

This way, a precise and effective neighbourhood is established for each one of the cells, in order to allow a correct re-utilization of the resources of the network, in this case of SCs.

C. Cellular Planning

For the development of this module, an algorithm is proposed for an easy and effective assignment of SCs to a subset of cells of a cellular deployment. Such a case occurs, for example, when a new site is deployed in an existing network.

The algorithm has one main rule: the SC of one cell can not be used by its 1st order neighbours. Metrics are defined to make a rigorous evaluation of the algorithm, such as the number of collisions to 1st order neighbours (which should be zero) and the number of collisions and level of interference to 2nd order neighbours. This last type of collisions may happen, however it has to be with the neighbour that is less interfering to the base cell, minimizing the interference, therefore the level of interference to the 2nd order neighbours is also verified.

In Figure 1, the various modules developed for the Cellular Planning are represented. Each one of them has a specific function and is crucial for a correct allocation of resources, in this case SCs. All the inputs necessary for cellular planning are directly gathered from AWS, and then processed. It has the following:

- Neighbours information, which is the output from the neighbours establishment algorithm. This algorithm previously needs the cell coverage estimation module.

- Cells' information, including its name, site it belongs to, position (latitude and longitude), UARFCN and used SC. This is a file that has information about each cell of the network. Also includes the list of sites to be planned.
- Client specifications, identifying the SCs site and UARFCN strategies, as well as the reference UARFCN frequency to be used in the planning and the intended distribution of SCs.

The steps taken for cellular planning, depicted in Figure 1 are detailed next:

- 1) *SCs distribution calculation*: SCs sets are built, always with values between 0 and 511. Depending on the client specification, it may be of consecutive SCs (e.g., 0, 1 and 2 for a 3 cells site) or discrete (0, 8 and 16).
- 2) *Grouping of cells per frequency*: An UMTS network has available a set of frequencies (UARFCNs), each cell operating on a specific one. In this step, cells are grouped per frequency, a planning being made for each group of frequencies. In fact, one site may have cells using different frequencies.
- 3) *Neighbours analysis per site*: For each unplanned site, an analysis of its neighbours is performed, allowing to know which are 1st order neighbours, 2nd order neighbours and the ones less interfering of the base cell. This analysis is crucial for a precise SC planning.
- 4) *Definition of unavailable SCs*: For each unplanned cell, a set of unavailable SCs is identified, being the ones used by 1st order neighbours.
- 5) *SCs allocation*: To allocate SCs to cells, two situations are possible:
 - a) The first one happens when there is still an available group of SCs that is not assigned to any of the 1st and 2nd order neighbours of the base cell. This is the most desirable situation for planning as it prevents any kind of collision. However, in urban areas, it is difficult to happen due to the high density of cells.
 - b) The second situation, and the most realistic, is that it is necessary to reuse a group of SCs (or at least one SC) that already belongs to some 2nd order neighbour, as SCs used by 1st order neighbours are always to be avoided. In this case, the less interfering SC group is assigned.
- 6) Once SCs are allocated for the reference frequency, cells using different UARFCNs are planned following the client's SC UARFCN strategy. As output, a SC is indicated for each unplanned cell, together with information of the number of collisions with 1st and 2nd order neighbours of the newly planned cells and the updated cells information file.

V. IMPLEMENTATION

A work pattern is proposed to monitor, plan and optimize cellular network resources. In the context of *utility computing*, the Amazon Web Services (AWS) are used, enabling

the interaction with the cellular network’s Operation Support System (OSS). The work pattern implemented using the AWS is depicted in Figure 3.

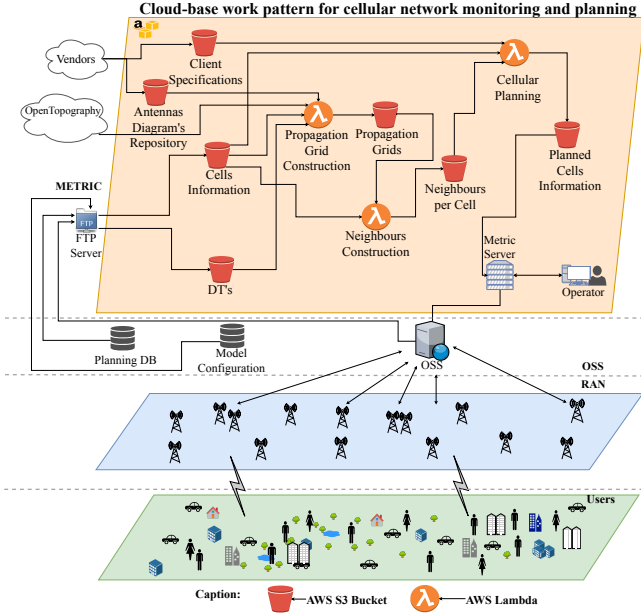

Fig. 3. Cloud-based work pattern for cellular network monitoring and planning.

In this work pattern, both storage and processing services are used. Each processing module has its needed information in a storage service (input) and also provides information for other processing modules (output). Therefore there are two main services that are used:

- **AWS Lambda:** Allows to run code whenever necessary, without provisioning or managing servers. The service is only paid for the consumed computing time. It is possible to run code for any kind of backend service, running and scaling the code with high availability.
- **AWS S3: Amazon Simple Storage Service (S3)** is an object storage service. This service offers data availability with high scalability, security and performance. It is possible to organize and configure the data in order to meet the necessary requirements for each type of project. This type of storage is very often used in IoT and big data analytics as this require a big amount of data storage.

The proposed work pattern is built combining seven S3 buckets for processed data storage, and three Lambdas, which process specific data of S3 buckets, storing their outputs in other buckets. One Lambda is responsible for the estimation of coverage, building propagation grids. A second Lambda is used to identify cells’ neighbour lists, using the propagation grids. Finally, knowing each cells’ neighbours, a third Lambda implements the cellular planning, in this case the SCs’ planning algorithm, proposing for every unplanned cell a SC.

Each one of the described algorithms is implemented in Java. The whole work pattern has then been integrated in Metric, using AWS, which acts as an interface to the algorithmic

planning of resources. This represents a new Metric feature that did not exist, allowing the operator to perform a fast and efficient SCs planning. Using this work pattern the operator does not have to repeatedly manually configure the planning specifications, as Metric already has information about them stored in AWS. In order to plan SCs, it is as simple as selecting a cell or group of sites and ask Metric to plan its SCs. In Figure 4 it is possible to observe the option to plan the SC of CANATA cell. This makes it easy and quick for the operator to do cell planning, which is not allowed in most tools.

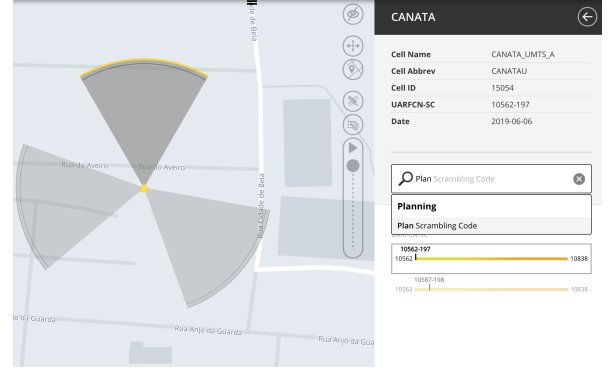

Fig. 4. SC planning interface in Metric.

The final output, containing the information of SCs per cell, is uploaded to AWS S3 in the format of JavaScript Object Notation (JSON). The Cells Information file is updated in order to always keep the data up to date as well as the Metric platform, so that the operator can always view the cells information updated. Metric has not yet the capability to make network configuration changes. Still, the configuration can be exported as vendor specific scripts that the operator may run directly enforce the changes in the respective cells.

VI. EVALUATION SCENARIOS

A. Canonical scenario

In order to evaluate the performance of proposed planning system, and to show the functional correctness of the implemented algorithm, a simple canonical scenario is defined as it is depicted in Figure 5, being composed of 8 sites, all having planned SCs except Site 1, for both 10562 and 10687 UARFCN frequencies. In this scenario, in order to ease the demonstration, it was established that the maximum range, for a received power of -120 dBm, is 2500 meters in the cells of Site 1 (S1), Site 2 (S2), Site 3 (S3) and Site 6 (S6). The other Sites, have short range cells of 100 meters. This way, it is safe to be assumed that in a radius of 2500 meters, d_{first_neighb} , all the cells inside are 1st order neighbours and the rest of them are 2nd order neighbours (which will be detailed in Section VII).

In Figure 5, the cells information, as the used SCs by each site and its UARFCN are presented, being that SCs for UARFCN 10562 are in green and for UARFCN 10687 are in red. Each cell uses one SC, the number of SCs indicating the

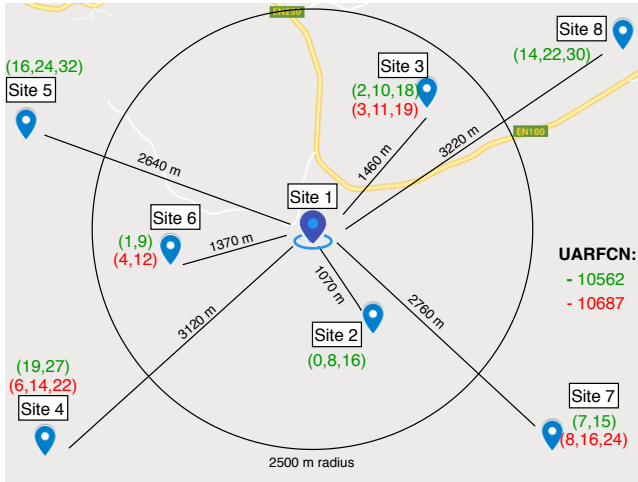

Fig. 5. Layout of the canonical scenario.

number of cells of a given site. Some sites only operate in one frequency (UARFCN). In the scenario, the unplanned (S1) has two cells on each UARFCN.

Other necessary inputs are the client specifications, indicating the reference frequency, as well as SC strategy per site and UARFCN. The reference UARFCN is 10562, being the first to be planned. Cells of any site operating in the same UARFCN must have SCs spaced by 8 as it is understood from the existing planning of the planned sites. Unplanned site S1 has two cells, the list of available groups of two SCs being given in Table I. The list is small enough to force the algorithm to reuse at least one SC from its neighbours. In fact, if an unused (by S1 neighbours) SC group would be available, the algorithm would directly choose it, which is a simple solution.

TABLE I
LIST OF AVAILABLE SCs GROUPS OF TWO CELLS

Group	SCs	Group	SCs
1	(0, 8)	5	(22, 30)
2	(2, 10)	6	(16, 24)
3	(8, 16)	7	(14, 22)
4	(19, 27)	8	(24, 32)

The reference UARFCN is 10562, and for a different UARFCN, the SC group to be used must be the next one, compared to the reference frequency. This is an important client specification as it describes the network layout.

B. Realistic Scenario

A realistic scenario is also considered for evaluation. It corresponds to a real UMTS network of an entire country, 3719 sites. Each site has 1 to 5 cells operating in up to 5 different frequencies (UARFCNs), a total of 12 484 cells.

In this scenario, the SC's of all cells are unplanned. The whole universe of 512 SCs is available for planning (depending on the neighbours). The client specifications, the SC site and UARFCN allocation strategy, is similar to the one of the

reference scenario, so it uses discrete SCs with an gap of 8 between consecutive SCs on the same group.

VII. RESULTS

A. Canonical scenario

The system starts by building the propagation grids for each of the cells of the network. After that the network neighbourhood is established for all of the cells, allowing to identify the 1st order neighbours of site S1, for each of the operating frequencies, based on UARFCN. By analyzing Figure 5, it is noticed that for the UARFCN 10562, S2, S3 and S6 are 1st order neighbours of S1, as they are within the range of its antennas, reaching these sites with a received power higher than -120 dBm, thus having more interference. The other sites, S4, S5, S7 and S8 are 2nd order neighbours of S1 as S4 and S5 are in the range of S6, S8 is in the range of S3 and S7 is in the range of S2. Since all 2nd order neighbours transmit with the same power, the further they are from S1's 1st order neighbours, the less interference there is. Regarding UARFCN 10687, S2, S5 and S8 do not operate in this frequency, not being neighbours of S1, as shown in Figure 5. Therefore, the 1st order neighbours are S3 and S6, and the 2nd order neighbour is S4 as it is in the range of S6 (S5 does not operate in this frequency).

Once the neighbours are identified, the planning algorithm must select, for S1, the SC group with less collisions for UARFCN 10562. All SC groups have SCs used within the 1st or 2nd order neighbours, so there is no SC group available without collisions. A SCs group must be found, of SCs not used by 1st order neighbours, and with lowest collisions. From Table I, it can be seen that the groups without SCs used by 1st order neighbours in UARFCN 10562 are group 4 (of SCs 19 and 27), group 5 (22, 30), group 7 (14, 22) and group 8 (24, 32). It is now necessary to find the less interfering site of the 2nd order neighbours. The algorithm evaluates the interference of S4 and S5 with S6, S8 with S3 and S7 with S2. The one that has less interference is the site that the algorithm chooses to try to reuse its SCs. Knowing that S2, S3 and S6 all have the same range of 2500 meters for a -120 dBm signal and S4, S5, S7 e S8 also have the same range of 100 meters for a -120 dBm signal, it is possible to demonstrate with distances which is the less interfering. Based on Figure 5, it is possible to observe that S4 is further away from S6 than S5. S7 is also further away to S2 than S8 from S3. Between S4 and S7, the one that is further away from its 1st order neighbour is S4. Therefore the chosen Site to reuse SCs is S4. Analyzing the possible SCs in Table I, it is possible to conclude that group 4 is the best group to use as it reuses the SCs of S4.

As the frequency interval is assumed as 1 (given as input), for UARFCN 10687 the algorithm tries to use the group immediately after group 4, which is group 5 (22, 30). The algorithm makes a verification if any of the SCs on that group are used by the 1st order neighbours of S1 on 10687. If it finds that any of the SCs are already used, it discards the group and finds the best option. In this case, none of the SCs are used by any of the 1st order neighbours, being that only SC 22 is used

by the less interfering 2nd order neighbour, S4. Therefore, this group can be used and is the chosen one for this UARFCN.

It is important to note that the type of demonstration of how the algorithm finds the best SCs group for each site followed was only possible because the various sites have the same range (S1, S2, S3 and S6 have 2500 meters and S4, S5, S7 and S8 have 100 meters range). Otherwise, as in a real scenario, the demonstration could not be done on the basis of distances, as it would no longer be accurate. This scenario was developed in order to demonstrate the efficiency of the algorithm as well as to facilitate its demonstration. In Figure 6 may be observed the whole scenario with the newly planned SCs of S1.

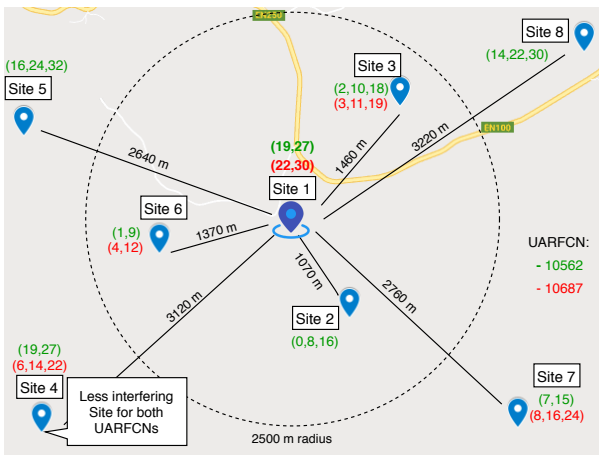

Fig. 6. SC grouping per planned site.

Resuming, for the unplanned site S1, for the reference UARFCN (10562), the SCs group used is group 4 (SCs 19 and 27) and for UARFCN 10687, the group immediately next to the one used on the reference UARFCN is used, that is, group 5 (SCs 22 and 30). This planning does not present collisions with 1st order neighbours and presents 3 collisions with 2nd order neighbours, which were supposed to happen. The planning is good and the one we expected for this scenario.

B. Realistic scenario

Regarding the realistic scenario, composed of 12484 unplanned cells, none of them remained unplanned, showing that the algorithm is robust to possible information failures of some cells (which is common in a real scenario). None has collisions with 1st order neighbours, evidencing the efficiency of the proposed algorithm. The algorithm takes less than 8 seconds to plan the network, revealing the speed with which any client is able to quickly and efficiently replan the entire network of a country.

This is the best way to understand the robustness and precision of this algorithm, as it forces it to plan a large number of cells, being necessary to solve collisions and manage them in the best way, always avoiding collisions with 1st order neighbours. In dense urban areas where a radius of 15 km contains more than 5000 cells, many overlapping

between them, this is an arduous task that requires a precise set of neighbours for each cell, otherwise the whole planning may be compromised.

This performance is compared to an SQL-based implementation of SC planning. For the same scenario, it takes around 30 minutes to complete. The gains of using a cloud-based implementation are evident. This is a major feature that provides the customer the freedom to plan or optimize their network with the assurance that it will only make it more effective and with better Quality of Service (QoS).

VIII. CONCLUSIONS

In this paper, a proof of concept implementation of a cloud-based AWS network planning work pattern is presented. Based on real OSS network configuration and performance data, it accurately estimates cells coverage, identifies neighbouring cells and optimally plans SCs in a UMTS network. The system operation is demonstrated for a small canonical scenario. For a realistic scenario, it outperforms an SQL-based implementation that takes 30 minutes to achieve poorer results. In fact, for 12 484 unplanned cells, the planning of SCs takes less than 8 seconds, guaranteeing no collisions between first order neighbouring cells. This work pattern has been integrated in SaaS Metric, which acts as an interface to the algorithmic planning of resources. As future work, this system shall be extended to 2G BCCHs and 4G PCIs planning.

ACKNOWLEDGMENT

This work is part of the OptiNET-5G project, co-funded by Centro2020, Portugal2020, European Union (project 023304).

REFERENCES

- [1] D. Webster, "Cisco Visual Networking Index (VNI)," Cisco, Tech. Rep., 2017.
- [2] S. Hämäläinen, H. Sanneck, and C. Sartori, *LTE Self-Organising Networks (SON)*. Wiley, 2012. [Online]. Available: www.wiley.com.
- [3] I. Poole, "Self Organising Networks, SON." [Online]. Available: <https://www.radio-electronics.com/info/cellulartelecomms/self-organising-networks-son/basics-tutorial.php>
- [4] J. Acharya, L. Gao, and S. Gaur, *Heterogeneous Networks in LTE-Advanced*. Wiley, 2014, vol. 97811185111.
- [5] Amazon, "Amazon Web Services." [Online]. Available: <https://aws.amazon.com>
- [6] M. Panico, I. Francalanci, G. Bini, and M. Ludovico, "Method for the assignment of scrambling codes to cells of a CDMA cellular mobile communications network," 2007.
- [7] "Metric." [Online]. Available: <https://www.metric.pt>
- [8] Forsk, "Atoll overview." [Online]. Available: <https://www.forsk.com/atoll-overview>
- [9] "GENEX U-Net." [Online]. Available: <https://pt.scribd.com/presentation/52172846/GENEX-U-Net-Functions-and-Application>
- [10] H. Hafez and A. Rabie, "Scrambling Code Planning and Optimization for UMTS System," *IEEE WCNC*, 2014.
- [11] Y.-H. Jung and Y. H. Lee, "Scrambling Code Planning for 3GPP W-CDMA Systems," in *IEEE VTS 53rd Vehicular Technology Conference, Spring 2001. Proceedings (Cat. No.01CH37202)*. Korea Advanced Institute of Technology Department of EECS, 2001, pp. 2431–2434.
- [12] D. Fernandes, L. S. Ferreira, M. Nozari, P. Sebastiao, F. Cercas, and R. Dinis, "Combining Drive Tests and Automatically Tuned Propagation Models in the Construction of Path Loss Grids," in *IEEE International Symposium on Personal, Indoor and Mobile Radio Communications, PIMRC*, vol. 2018-Sept, 2018, pp. 1161–1162.
- [13] "OpenTopography." [Online]. Available: <https://opentopography.org>