

# Delooping the functor calculus tower

Julien Ducoulombier

Victor Turchin

## Abstract

We study a connection between mapping spaces of bimodules and of infinitesimal bimodules over an operad. As main application and motivation of our work, we produce an explicit delooping of the manifold calculus tower associated to the space of smooth maps  $D^m \rightarrow D^n$  of discs,  $n \geq m$ , avoiding any given multisingularity and coinciding with the standard inclusion near the boundary  $\partial D^m$ . In particular, we give a new proof of the delooping of the space of disc embeddings in terms of little discs operads maps with the advantage that it can be applied to more general mapping spaces. As a spin-off result we discover a homotopy recurrence relation on the components of the little discs operads.

## Contents

<b>1</b>	<b>Introduction</b>	<b>2</b>
1.1	Functor calculus on a closed disc for non-singular mapping spaces . . . . .	2
1.2	Action of the little discs operad and a few more examples of mapping spaces . . . . .	3
1.3	(Truncated) operads, bimodules, infinitesimal bimodules . . . . .	4
1.3.1	$\Sigma$ -sequences, operads, bimodules, infinitesimal bimodules. . . . .	4
1.3.2	Truncated objects. . . . .	6
1.4	Taylor tower on a closed disc and the little discs operad: Main Theorem 1 . . . . .	7
1.5	Generalized delooping results: Main Theorems 2 and 3 . . . . .	9
<b>2</b>	<b>Homotopy theory</b>	<b>10</b>
2.1	$\Sigma$ and $\Lambda$ sequences . . . . .	11
2.2	Operads . . . . .	11
2.3	Bimodules . . . . .	13
2.4	Infinitesimal bimodules . . . . .	14
2.5	Topological spaces: products, subspaces, quotients, mapping spaces . . . . .	15
<b>3</b>	<b>Cofibrant replacements</b>	<b>16</b>
3.1	Boardman-Vogt resolution for bimodules . . . . .	17
3.1.1	Boardman-Vogt resolution in the $\Lambda$ setting. . . . .	21
3.2	Boardman-Vogt resolution for infinitesimal bimodules . . . . .	22
3.2.1	Boardman-Vogt resolution in the $\Lambda$ setting. . . . .	25
<b>4</b>	<b>Coherence</b>	<b>27</b>
4.1	Definition of coherence and strong coherence . . . . .	27
4.2	Boardman-Vogt resolution as a homotopy colimit . . . . .	32
<b>5</b>	<b>Fulton-MacPherson operad <math>\mathcal{F}_m</math></b>	<b>35</b>
5.1	Infinitesimal bimodule $\mathcal{IF}_m$ . . . . .	36
5.2	Projection map $\mathcal{IF}_m \rightarrow \mathcal{F}_m$ . . . . .	37
5.3	Fulton-MacPherson operad is strongly coherent . . . . .	39
5.4	Bimodule $\mathcal{BF}_m$ . . . . .	41

<b>6</b>	<b>Map between the towers</b>	<b>43</b>
6.1	An alternative cofibrant replacement of $O$ as $O$ -Ibimodule . . . . .	43
6.1.1	Homeomorphism between $\mathcal{I}b^\wedge(O)$ and $\overline{\mathcal{I}b}^\wedge(O)$ . . . . .	46
6.2	Construction of the map . . . . .	49
6.3	Alternative proof of Main Theorem 1 . . . . .	51
<b>7</b>	<b>Proof of Main Theorems 2 and 3</b>	<b>51</b>
7.1	Main Theorem 2. Special case: $O$ is doubly reduced . . . . .	51
7.2	Main Theorem 2. General case: $O$ is weakly doubly reduced . . . . .	57
7.3	Explicit maps . . . . .	60
7.4	Main Theorem 3 . . . . .	61
<b>A</b>	<b>Appendix</b>	<b>62</b>
A.1	A convenient category of topological spaces . . . . .	62
A.2	Proof of Theorem 2.1 . . . . .	63
A.3	Cellular cosheaves . . . . .	65

# 1 Introduction

## 1.1 Functor calculus on a closed disc for non-singular mapping spaces

The calculus of functors on manifolds was invented by T. Goodwillie and M. Weiss in order to study spaces of smooth embeddings [Wei99, GW99]. The approach is universal and in particular can be applied to the study of more general spaces of maps between smooth manifolds avoiding any given type  $\mathcal{S}$  of multisingularity. The idea of this method goes back to Smale’s study of immersions [Sma59] and to the Gromov  $h$ -principle [Gro86], that suggest replacing the space of maps avoiding any given singularity with the space of sections of a jet bundle. In case the singularity condition depends on more than one point, one can consider similar spaces of sections of multijet bundles over configuration spaces of points in the source manifold. By doing so one should take into account that points in configurations can collide or be forgotten. The manifold calculus keeps track of all these data in a homotopy invariant way. The  $k$ -th approximation in this method is obtained by restricting the number of points in configurations to be  $\leq k$ .

For  $m \leq n$ , and any given multisingularity  $\mathcal{S}$ , specified by a multijet condition, see [Vas92], consider the space  $\text{Map}_\partial^{\mathcal{S}}(D^m, D^n)$  of smooth maps  $D^m \rightarrow D^n$  avoiding  $\mathcal{S}$  and coinciding with the standard inclusion of discs  $i: D^m \subset D^n$  near the boundary  $\partial D^m$ . The multisingularity  $\mathcal{S}$  must be *closed* in the sense that if  $f$  is a limit of  $\mathcal{S}$ -singular maps, then  $f$  should also be  $\mathcal{S}$ -singular. Examples of such mapping spaces are the spaces  $\text{Emb}_\partial(D^m, D^n)$  and  $\text{Imm}_\partial(D^m, D^n)$  of embeddings and immersions, respectively. As another example, one can consider the space  $\text{Imm}_\partial^{(\ell)}(D^m, D^n)$  of non- $\ell$ -equal immersions,  $\ell \geq 2$ , i.e. immersions  $f: D^m \hookrightarrow D^n$  for which any subset of  $\ell$  points in  $D^m$  has more than one point in the image. One obviously has  $\text{Imm}_\partial^{(2)}(D^m, D^n) = \text{Emb}_\partial(D^m, D^n)$ . Self-tangency would be another example of a possible forbidden multi-singularity, or one can consider any mixed condition on self-intersection and singularity type at intersection points.

Let  $\mathcal{O}_\partial(D^m)$  be the category of open subsets of  $D^m$  containing the boundary  $\partial D^m$ . For any contravariant functor  $F: \mathcal{O}_\partial(D^m) \rightarrow \text{Top}$  to topological spaces, that sends isotopy equivalences to weak homotopy equivalences, the functor calculus assigns a *Taylor tower* of polynomial approximations to  $F$ :

$$\begin{array}{ccccccc}
 & & F & & & & (1) \\
 & \swarrow & \downarrow & \searrow & \swarrow & \searrow & \\
 T_0F & \longleftarrow & T_1F & \longleftarrow & T_2F & \longleftarrow & T_3F \longleftarrow \dots
 \end{array}$$

We say that the tower (1) *converges to F* (or simply *converges*) if the natural map  $F \rightarrow T_\infty F$  to the limit of the tower is a weak equivalence of functors (by this we mean objectwise weak equivalence). In practice we are usually concerned with the convergence of the Taylor tower (1) evaluated on  $U = D^m$ .

To study the space  $\text{Map}_\partial^{\mathbb{S}}(D^m, D^n)$ , we consider the functor  $\text{Map}_\partial^{\mathbb{S}}(-, D^n)$  assigning to  $U \in \mathcal{O}_\partial(D^m)$

$$U \mapsto \text{Map}_\partial^{\mathbb{S}}(U, D^n)$$

the space of  $\mathbb{S}$ -non-singular maps  $U \rightarrow D^n$  coinciding with  $i: D^m \subset D^n$  near  $\partial D^m$ . One of the main results of the embedding calculus [GK15] is that it can be always applied when codimension is at least three:

$$T_\infty \text{Emb}_\partial(D^m, D^n) \simeq \text{Emb}_\partial(D^m, D^n), \quad n - m \geq 3. \quad (2)$$

Note that even though the multi-singularity condition is expressed using only two points, we still need to go to the limit of the tower, which takes into account configurations of arbitrary large number of points, in order to recover the initial embedding space.

Unfortunately, for other types of  $\mathbb{S}$  the question of convergence of the Goodwillie-Weiss tower has not yet been studied. In particular one does not have any results for non- $\ell$ -equal immersions with  $\ell \geq 3$ . One should mention that for general mapping spaces, the methods of the embedding calculus do not work and the question of convergence appears to be very hard. Besides the Goodwillie-Weiss calculus method, one also has the Vassiliev theory of discriminants that was used to study such spaces [Vas92]. However, for embedding spaces the discriminant method has a more restricted range where it is applicable  $n \geq 2m + 2$  compared to the calculus approach, which works for the range  $n \geq m + 3$ . Thus one still anticipates that for general mapping spaces avoiding any given multisingularity  $\mathbb{S}$ , the calculus method works and in particular can be applied in cases where the discriminant theory cannot. In particular we hope that the delooping result that we produce in this paper will encourage more studies in this direction.

## 1.2 Action of the little discs operad and a few more examples of mapping spaces

The spaces  $\text{Map}_\partial^{\mathbb{S}}(D^m, D^n)$  are naturally algebras over the little  $m$ -discs operad  $\mathcal{B}_m$ . Recall that an element  $b \in \mathcal{B}_m(k)$  is a configuration of  $k$  discs  $D_i^m, i = 1 \dots k$ , with disjoint interiors in the unit disc  $D^m$ , where each disc is the image of a linear map  $L_i: D^m \hookrightarrow D^m$ , which is a composition of translation and rescaling. Given such  $b$  and  $f_i \in \text{Map}_\partial^{\mathbb{S}}(D^m, D^n), i = 1 \dots k$ , the action in question is defined as follows:  $b(f_1, \dots, f_k) \in \text{Map}_\partial^{\mathbb{S}}(D^m, D^n)$  is the map  $D^m \rightarrow D^n$ , which is the standard inclusion on  $D^m \setminus \cup_{i=1}^k D_i^m$ , and is  $\hat{L}_i \circ f_i \circ L_i^{-1}$  on  $D_i^m$ , where  $\hat{L}_i: \mathbb{R}^n \rightarrow \mathbb{R}^n$  is the obvious extension of  $L_i$ , so that it is also a composition of translation and rescaling.

A typical example of a  $\mathcal{B}_m$ -algebra is an iterated  $m$ -loop space. Moreover, by the celebrated May-Boardman-Vogt recognition principle, under the condition  $\pi_0 X$  is a group, any  $\mathcal{B}_m$ -algebra  $X$  is weakly equivalent to an  $m$ -loop space  $\Omega^m Y$  [May72, BV73]. In this paper we give an explicit  $m$ -delooping of the tower  $T_\bullet \text{Map}_\partial^{\mathbb{S}}(D^m, D^n)$ . Before doing this, consider several other examples to which our delooping construction applies.

Define  $\text{Emb}_\partial^{fr}(D^m, D^n)$  as the space of framed embeddings  $D^m \hookrightarrow D^n$ , i.e. embeddings with trivialization of the normal bundle standard near  $\partial D^m$ . Define also  $\overline{\text{Emb}}_\partial(D^m, D^n)$  as the homotopy fiber of the inclusion  $\text{Emb}_\partial(D^m, D^n) \hookrightarrow \text{Imm}_\partial(D^m, D^n)$  over  $i: D^m \subset D^n$ . As another example we consider  $\overline{\text{Emb}}_\partial(D^m, D^n)^\mathbb{Q}$  – rationalization of  $\overline{\text{Emb}}_\partial(D^m, D^n)$ . The common feature of these three examples  $\text{Emb}_\partial^{fr}(D^m, D^n), \overline{\text{Emb}}_\partial(D^m, D^n), \overline{\text{Emb}}_\partial(D^m, D^n)^\mathbb{Q}$  is that they are all algebras over  $\mathcal{B}_{m+1}$ . For the first example, this has been shown by R. Budney [Bud07]. For the second one, see [Sak14, Tur10]. The third example was considered in [FTW17]: as a consequence of the above, it is an algebra over  $\mathcal{B}_{m+1}^\mathbb{Q}$  and thus over  $\mathcal{B}_{m+1}$  by restriction. The idea of this little discs action in one higher dimension is that embeddings can be shrunken and pulled one through another as in the proof of the commutativity of the monoid  $\pi_0 \text{Emb}_\partial(D^1, D^3)$  of isotopy classes of classical long knots.

Finally, define  $\overline{\text{Imm}}_{\partial}^{(\ell)}(D^m, D^n)$  as the homotopy fiber of the inclusion  $\text{Imm}_{\partial}^{(\ell)}(D^m, D^n) \hookrightarrow \text{Imm}_{\partial}(D^m, D^n)$  over  $i: D^m \subset D^n$ . When  $\ell \geq 3$ , this space is not a  $\mathcal{B}_{m+1}$ -algebra as pulling non- $\ell$ -equal immersions one through another might create self-intersections of higher degree, but it is still a  $\mathcal{B}_m$ -algebra. The pair of spaces  $(\overline{\text{Imm}}_{\partial}^{(\ell)}(D^m, D^n), \overline{\text{Emb}}_{\partial}(D^m, D^n))$  is actually an algebra over the *extended Swiss cheese operad*  $\mathcal{ESC}_{m,m+1}$  considered in [Wil17]. Informally this means that both non- $\ell$ -equal immersions can be shrunken and pulled through embeddings and embeddings can be shrunken and pulled through immersions. It would be interesting to find a relative delooping of this pair of spaces that would account to this extended Swiss cheese action. The relative delooping with respect to the action of the usual Swiss cheese operad [Vor99] has been obtained (modulo convergence of the tower and our Main Theorem 1) by the first author in [Duc18].

Recent developments in the manifold calculus of functors allows one to express the tower (1) in terms of derived mapping spaces of (truncated) infinitesimal bimodules over  $\mathcal{B}_m$  [AT14, Tur13]. The main result of this paper – we show that in certain cases, as in all examples above, these towers admit an explicit  $m$ -th or  $(m+1)$ -th delooping in terms of derived mapping spaces of (truncated) bimodules over  $\mathcal{B}_m$  or of (truncated) operads. This approach will translate many difficult geometrical problems to a not necessarily easy, but definitely interesting algebraic framework. Also the obtained deloopings are more highly connected than the initial spaces, which will allow the use of rational homotopy theory to study them. As a particular example, the delooping of  $\overline{\text{Emb}}_{\partial}(D^m, D^n)$ ,  $n - m \geq 3$ , produced earlier by Boavida de Brito and Weiss in [BdBW18] and the deloopings of  $T_{\infty}\overline{\text{Emb}}_{\partial}(D^m, D^n)^{\mathbb{Q}}$  and of  $T_k\overline{\text{Emb}}_{\partial}(D^m, D^n)^{\mathbb{Q}}$ , that follow from our work, see (14)-(15), were recently used in [FTW17] to produce a complete rational understanding of the spaces  $\overline{\text{Emb}}_{\partial}(D^m, D^n)$ ,  $n - m \geq 3$ , and the towers  $T_k\overline{\text{Emb}}_{\partial}(D^m, D^n)$ ,  $n - m \geq 2$ .

In case the tower (1) does not converge, one can still consider the induced map  $\pi_0 F(D^m) \rightarrow \pi_0 T_k F(D^m)$ . According to our delooping result for  $F = \text{Map}_{\partial}^{\mathbb{S}}(-, D^n)$  (or any other functor considered in this subsection), this map produces an invariant of isotopy classes of  $\mathbb{S}$ -non-singular maps that takes values in an (abelian) group. Such invariants can be of interest. For example, in the classical case of knots in a three-dimensional space  $\text{Emb}_{\partial}(D^1, D^3)$ , this map was shown to be an integral additive Vassiliev invariant of order  $\leq k - 1$ , and it is conjectured to be the universal one of this type [BCKS17].

### 1.3 (Truncated) operads, bimodules, infinitesimal bimodules

In this subsection we recall some standard definitions from the theory of operads and fix notation. This will be necessary to formulate our main results.

#### 1.3.1 $\Sigma$ -sequences, operads, bimodules, infinitesimal bimodules.

By a  $\Sigma$ -sequence we mean a family of topological spaces  $M = \{M(n), n \geq 0\}$ , endowed with a right action of the symmetric group  $M(n) \times \Sigma_n \rightarrow M(n)$ . We denote the category of  $\Sigma$ -sequences by  $\Sigma\text{Seq}$ . This category is endowed with a monoidal structure  $(\Sigma\text{Seq}, \circ, \#)$ , where  $\circ$  is the composition product [Fre09], and

$$\#(n) = \begin{cases} *, & n = 1; \\ \emptyset, & n \neq 1. \end{cases}$$

An *operad* is a monoid with respect to this structure. Explicitly, the structure of an operad is determined by the operadic compositions:

$$\circ_i : O(n) \times O(m) \longrightarrow O(n + m - 1), \quad \text{with } 1 \leq i \leq n, \quad (3)$$

and the unit element  $*_1 \in O(1)$ , satisfying compatibility with the action of the symmetric group, associativity, commutativity and unit axioms. A map between two operads should respect the operadic compositions. We denote by  $\text{Operad}$  the categories of operads.

**Example 1.1.** Our two main examples of operads are the little discs operad  $\mathcal{B}_m$  and the Fulton-MacPherson operad  $\mathcal{F}_m$ , which is equivalent to  $\mathcal{B}_m$ , see [Sal01]. We assume that the reader is familiar with these two examples. Main properties of  $\mathcal{F}_m$  are recalled at the beginning of Section 5.

**Example 1.2.** We can also consider rationalizations  $\mathcal{B}_n^{\mathbb{Q}}, \mathcal{F}_n^{\mathbb{Q}}$  of  $\mathcal{B}_n$  and  $\mathcal{F}_n$ , respectively, see [FTW17]. One has natural maps  $\mathcal{B}_n \rightarrow \mathcal{B}_n^{\mathbb{Q}}, \mathcal{F}_n \rightarrow \mathcal{F}_n^{\mathbb{Q}}$ .

**Example 1.3.** Framed little discs operad  $\mathcal{B}_n^{fr}$  and framed Fulton-MacPherson operad  $\mathcal{F}_n^{fr}$  [Sal01]. One has natural inclusions  $\mathcal{B}_n \rightarrow \mathcal{B}_n^{fr}, \mathcal{F}_n \rightarrow \mathcal{F}_n^{fr}$ .

A *left module*, *right module*, and *bimodule over an operad*  $O$  is a symmetric sequence  $M$  endowed with the structure of a left module, right module, or bimodule, respectively, over the monoid (= operad)  $O$ . Explicitly, the structure of a bimodule is given by a family of maps

$$\begin{aligned} \gamma_r : M(n) \times O(m_1) \times \cdots \times O(m_n) &\longrightarrow M(m_1 + \cdots + m_n), & \text{right action,} \\ \gamma_l : O(n) \times M(m_1) \times \cdots \times M(m_n) &\longrightarrow M(m_1 + \cdots + m_n), & \text{left action,} \end{aligned} \quad (4)$$

satisfying compatibility with the action of the symmetric group, associativity and unity axioms (see [AT14, Fre09]). In particular, the spaces  $O(0)$  and  $M(0)$  are  $O$ -algebras and there is a map of algebras  $\gamma_0 : O(0) \rightarrow M(0)$ . A map between  $O$ -bimodules should respect these operations. We denote by  $\text{Bimod}_O$  the category of  $O$ -bimodules. Thanks to the unit in  $O(1)$ , the right action can equivalently be defined by a family of continuous maps

$$\circ^i : M(n) \times O(m) \longrightarrow M(n + m - 1), \quad \text{with } 1 \leq i \leq n.$$

For the rest of the paper, we also use the following notation:

$$\begin{aligned} x \circ^i y &= \circ^i(x; y) & \text{for } x \in M(n) \text{ and } y \in O(m), \\ x(y_1, \dots, y_n) &= \gamma_l(x; y_1; \dots; y_n) & \text{for } x \in O(n) \text{ and } y_i \in M(m_i). \end{aligned}$$

**Example 1.4.** Given a map of operads  $O \rightarrow P$ , the target operad  $P$  becomes a bimodule over  $O$ . For example, one has inclusions of operads  $\mathcal{B}_m \rightarrow \mathcal{B}_n$  and  $\mathcal{F}_m \rightarrow \mathcal{F}_n$ , which are induced by the coordinate inclusion  $\mathbb{R}^m \subset \mathbb{R}^n$ ,  $n \geq m$ . Composing these maps with those from Examples 1.2 and 1.3, we get operad maps  $\mathcal{B}_m \rightarrow \mathcal{B}_n^{\mathbb{Q}}, \mathcal{B}_m \rightarrow \mathcal{B}_n^{fr}$ , and  $\mathcal{F}_m \rightarrow \mathcal{F}_n^{\mathbb{Q}}, \mathcal{F}_m \rightarrow \mathcal{F}_n^{fr}$ ,  $n \geq m$ . As a consequence for  $n \geq m$ , the sequences  $\mathcal{B}_n, \mathcal{B}_n^{\mathbb{Q}}, \mathcal{B}_n^{fr}$  are bimodules over  $\mathcal{B}_m$  and  $\mathcal{F}_n, \mathcal{F}_n^{\mathbb{Q}}, \mathcal{F}_n^{fr}$  are bimodules over  $\mathcal{F}_m$ .

**Example 1.5.** For  $n \geq 1, \ell \geq 2$ , consider the sequences of spaces  $\{\mathcal{B}_n^{(\ell)}(j), j \geq 0\}$ , where  $\mathcal{B}_n^{(\ell)}(j)$  is the configuration space of  $j$  discs in a unit disc  $D^n$ , defined as images of maps  $L_i : D^n \rightarrow D^n$ , each one being a composition of translation and rescaling, satisfying the *non- $\ell$ -overlapping condition*: no  $\ell$  of them share a point in their interiors. One obviously has  $\mathcal{B}_n^{(2)} = \mathcal{B}_n$ . The sequence  $\mathcal{B}_n^{(\ell)}$  is a bimodule over  $\mathcal{B}_n$ , see [DT15], and thus a bimodule over  $\mathcal{B}_m$  by restriction. It is called *bimodule of non- $\ell$ -overlapping discs*.

**Example 1.6.** For any  $m \leq n$  and any multisingularity  $\mathbb{S}$ , the sequence

$$\text{Map}^{\mathbb{S}}(\sqcup_{\bullet} D^m, D^n) = \{\text{Map}^{\mathbb{S}}(\sqcup_j D^m, D^n), j \geq 0\}$$

is a bimodule over  $\mathcal{B}_m$  by taking pre- and post-composition. Here  $\text{Map}^{\mathbb{S}}(\sqcup_j D^m, D^n)$  denotes the space of smooth  $\mathbb{S}$ -non-singular maps  $\sqcup_j D^m \rightarrow D^n$ . In fact it is a  $\mathcal{B}_n$ - $\mathcal{B}_m$  bimodule, i.e. it has a left action of  $\mathcal{B}_n$  and a right action of  $\mathcal{B}_m$ , which commute with each other. But we are interested only in its  $\mathcal{B}_m$ -bimodule restriction.

Finally, recall the notion of *infinitesimal bimodule*, which is less standard. To the best of our knowledge it appeared first in [MV09] with this name, see also [AT14]. In the literature it is sometimes called *weak*, *abelian*, or *linear bimodule* [DH12, Tur14]. An *infinitesimal bimodule* over  $O$ , or  *$O$ -Ibimodule*, is a sequence  $N \in \Sigma\text{Seq}$  endowed with operations

$$\begin{aligned} \circ_i : O(n) \times N(m) &\rightarrow N(n+m-1) \quad \text{for } 1 \leq i \leq n, & \text{infinitesimal left action,} \\ \circ^i : N(m) \times O(n) &\rightarrow N(n+m-1) \quad \text{for } 1 \leq i \leq n, & \text{infinitesimal right action,} \end{aligned} \tag{5}$$

satisfying unit, associativity, commutativity and compatibility with the symmetric group axioms, see [AT14]. We denote by  $\text{Ibimod}_O$  the category of infinitesimal bimodules. The infinitesimal right action is equivalent to the usual right action, but it is not the case for the left action. In fact the existence of a left action does not imply the existence of an infinitesimal left action, nor does the existence of an infinitesimal left action imply the existence of a left action.

**Example 1.7.** Given a map of operads  $\eta : O \rightarrow P$ , the sequence  $P$  inherits a structure of an infinitesimal bimodule over  $O$ : for  $x \in O$ ,  $y \in P$ , one defines  $x \circ_i y := \eta(x) \circ_i y$  and  $y \circ^i x := y \circ_i \eta(x)$ . For example,  $\mathcal{B}_n, \mathcal{B}_n^{\mathcal{Q}}, \mathcal{B}_n^{fr}$  are infinitesimal bimodules over  $\mathcal{B}_m$  and  $\mathcal{F}_n, \mathcal{F}_n^{\mathcal{Q}}, \mathcal{F}_n^{fr}$  are infinitesimal bimodules over  $\mathcal{F}_m$ .

**Example 1.8.** As we mentioned earlier, the structure of a bimodule and that of an infinitesimal bimodule do not imply one another. However, if  $M$  is a bimodule over an operad  $O$  and one has a map of  $O$ -bimodules  $\eta : O \rightarrow M$ , then  $M$  is also an infinitesimal bimodule over  $O$ . Since the right operations and the right infinitesimal operations are the same, we just need to define the left infinitesimal operations:

$$\begin{aligned} \circ_i : O(n) \times M(m) &\longrightarrow M(n+m-1); \\ (x; y) &\longmapsto \gamma_1(x; \underbrace{\eta(*_1), \dots, \eta(*_1)}_{i-1}, y, \underbrace{\eta(*_1), \dots, \eta(*_1)}_{n-i}). \end{aligned}$$

For example, one has the obvious inclusion  $\mathcal{B}_n \rightarrow \mathcal{B}_n^{(\ell)}$ , making  $\mathcal{B}_n^{(\ell)}$  into an infinitesimal bimodule over  $\mathcal{B}_n$  and also over  $\mathcal{B}_m$  by restriction. As another example, one also has the inclusion  $\mathcal{B}_m \rightarrow \text{Map}^{\mathcal{S}}(\sqcup_{\bullet} D^m, D^n)$ , making  $\text{Map}^{\mathcal{S}}(\sqcup_{\bullet} D^m, D^n)$  into a  $\mathcal{B}_m$ -Ibimodule.

Note that Example 1.7 is a particular case of Example 1.8.

**Example 1.9.** For  $m \leq n$ , a multisingularity  $\mathcal{S}$ , and a compact subset  $K \subset D^n$  in the interior of the unit disc, define the space  $\text{Map}^{\mathcal{S}}((\sqcup_j D^m) \sqcup K, D^n)$  of maps

$$f : (\sqcup_j D^m) \sqcup K \rightarrow D^n,$$

such that  $f|_{\sqcup_j D^m}$  is smooth  $\mathcal{S}$ -non-singular,  $f|_K$  is a composition of translation and rescaling and  $f(K)$  lies in the interior of  $D^n$  and is disjoint from  $f(\sqcup_j D^m)$ . Then the sequence of spaces

$$\text{Map}^{\mathcal{S}}((\sqcup_{\bullet} D^m) \sqcup K, D^n) = \left\{ \text{Map}^{\mathcal{S}}((\sqcup_j D^m) \sqcup K, D^n), j \geq 0 \right\}$$

has a structure of a  $\mathcal{B}_m$ -Ibimodule defined similarly by pre- and post-composition. One should also notice that contrary to the previous examples, this sequence is not a  $\mathcal{B}_m$ -bimodule.

### 1.3.2 Truncated objects.

For any  $k \geq 0$ , we also consider the categories  $\text{T}_k\Sigma\text{Seq}$ ,  $\text{T}_k\text{Operad}$ ,  $\text{T}_k\text{Bimod}_O$ ,  $\text{T}_k\text{Ibimod}$  of  *$k$ -truncated sequences*,  *$k$ -truncated operads*,  *$k$ -truncated bimodules*, and  *$k$ -truncated infinitesimal bimodules*, respectively. A  *$k$ -truncated object* is a finite sequence of spaces  $\{M(j), 0 \leq j \leq k\}$  with all the corresponding operations:  $\Sigma$ -action, unit  $*_1$ , compositions (3), (4), (5), in the range where applicable, and satisfying the same compatibility



axioms: associativity, commutativity, unity, and  $\Sigma$ -compatibility. For example, for  $k$ -truncated operads, we require  $\Sigma$ -action, unit  $*_1 \in O(1)$ , and compositions (3) with  $n \leq k$ ,  $m \leq k$ ,  $n + m - 1 \leq k$ . For  $k$ -truncated bimodules, besides the  $\Sigma$ -action, we require right action (4) with  $n \leq k$ ,  $m_1 + \dots + m_n \leq k$ , and left action (4) with  $m_1 + \dots + m_n \leq k$ . For  $k$ -truncated Ibimodules, besides the  $\Sigma$ -action we require compositions (5) with  $m \leq k$  and  $n + m - 1 \leq k$ . In particular, infinitesimal left compositions  $\circ_i: O(n) \times N(m) \rightarrow N(n + m - 1)$  with  $m = 0$  and  $n = k + 1$  are allowed.

One has obvious truncation functors, that abusing notation we always denote by  $T_k$ :

$$\begin{aligned} T_k: \Sigma\text{Seq} &\rightarrow T_k\Sigma\text{Seq}, & T_k: \text{Operad} &\rightarrow T_k\text{Operad}, \\ T_k: \text{Bimod}_O &\rightarrow T_k\text{Bimod}_O, & T_k: \text{Ibimod}_O &\rightarrow T_k\text{Ibimod}_O. \end{aligned}$$

## 1.4 Taylor tower on a closed disc and the little discs operad: Main Theorem 1

Recent developments in the manifold calculus allows one to describe the Taylor tower in terms of derived mapping spaces of truncated right modules or infinitesimal bimodules [AT14, BdBW13, Tur13]. In case of the closed disc and a contravariant  $F: \mathcal{O}_\partial(D^m) \rightarrow \text{Top}$  of certain ‘‘context-free’’ nature, one has

$$\begin{aligned} T_\infty F(D^m) &\cong \text{Ibimod}_{\mathcal{B}_m}^h(\mathcal{B}_m, Ib(F)); \\ T_k F(D^m) &\cong T_k \text{Ibimod}_{\mathcal{B}_m}^h(T_k \mathcal{B}_m, T_k Ib(F)), \quad k \geq 0, \end{aligned} \tag{6}$$

where  $\text{Ibimod}_{\mathcal{B}_m}^h(-, -)$  and  $T_k \text{Ibimod}_{\mathcal{B}_m}^h(-, -)$  denote the derived mapping spaces of infinitesimal bimodules and of  $k$ -truncated infinitesimal bimodules, respectively;  $Ib(F)$  is a  $\mathcal{B}_m$ -Ibimodule naturally assigned to  $F$ . The table below relates the functors considered in Subsections 1.1-1.2 and the corresponding to them Ibimodules described in Subsection 1.3.

$F$	$\overline{\text{Emb}}_\partial(-, D^n)$	$\overline{\text{Emb}}_\partial(-, D^n)^\mathbb{Q}$	$\text{Emb}_\partial^{fr}(-, D^n)$	$\overline{\text{Imm}}_\partial^{(\ell)}(-, D^n)$	$\text{Map}_\partial^S(-, D^n)$	$\text{Map}_\partial^S(-, D^n \setminus K)$
$Ib(F)$	$\mathcal{B}_n$	$\mathcal{B}_n^\mathbb{Q}$	$\mathcal{B}_n^{fr}$	$\mathcal{B}_n^{(\ell)}$	$\text{Map}^S(\sqcup_\bullet D^m, D^n)$	$\text{Map}^S((\sqcup_\bullet D^m) \sqcup K, D^n)$

In particular, for  $n - m \geq 3$  the convergence of the tower (2) together with (6) allows one to describe the spaces  $\text{Emb}_\partial(D^m, D^n)$ ,  $\overline{\text{Emb}}_\partial(D^m, D^n)$ , and  $\text{Emb}_\partial^{fr}(D^m, D^n)$  as spaces of derived maps of infinitesimal bimodules. For example, one has

$$\overline{\text{Emb}}_\partial(D^m, D^n) \simeq \text{Ibimod}_{\mathcal{B}_m}^h(\mathcal{B}_m, \mathcal{B}_n), \quad \text{with } n - m \geq 3. \tag{7}$$

This equivalence is a generalization of Sinha’s cosimplicial model [Sin06] for the space  $\overline{\text{Emb}}_\partial(D^1, D^n)$  of knots, with  $n \geq 4$ . Indeed, in the latter case  $\mathcal{B}_1$  can be replaced by the associative operad. The right-hand side of (7) becomes the homotopy totalization of a cosimplicial object as an infinitesimal bimodule over the associative operad is the same thing as a cosimplicial object.

In fact equivalence (6) was proved in [AT14] only for  $F = \overline{\text{Emb}}_\partial(-, D^n)$ , but the argument works for all functors of context-free nature as all the examples above. Note that for all the functors  $F$  from the table above except the last one, the space  $F(D^m)$  is a  $\mathcal{B}_m$ -algebra, see Subsection 1.2. Note also that all the corresponding infinitesimal bimodules  $Ib(F)$  appear as  $\mathcal{B}_m$ -bimodules endowed with a map from  $\mathcal{B}_m$ , see Example 1.8. Moreover, the first three ones are operads, see Example 1.7, and exactly for the first three functors  $F(D^m)$  is a  $\mathcal{B}_{m+1}$ -algebra. As our main result, the theorem below, shows that this connection is not random.

**Main Theorem 1.** *Let  $\eta: \mathcal{B}_m \rightarrow M$  be a morphism of  $\mathcal{B}_m$ -bimodules, and also assume that  $M(0) = *$ . Then one has an equivalence of towers:*

$$T_k \text{Ibimod}_{\mathcal{B}_m}^h(T_k \mathcal{B}_m, T_k M) \simeq \Omega^m T_k \text{Bimod}_{\mathcal{B}_m}^h(T_k \mathcal{B}_m, T_k M), \quad k \geq 0, \tag{8}$$

implying at the limit  $k = \infty$ :

$$\text{Ibimod}_{\mathcal{B}_m}^h(\mathcal{B}_m, M) \simeq \Omega^m \text{Bimod}_{\mathcal{B}_m}^h(\mathcal{B}_m, M). \tag{9}$$

Here  $\text{Bimod}^h(-, -)$  and  $T_k \text{Bimod}^h(-, -)$  denote the derived mapping spaces of bimodules and of  $k$ -truncated bimodules, respectively. The basepoint for the loop spaces above is  $T_k \eta$  and  $\eta$ , respectively. By a *tower* we mean a sequence of spaces  $X_\bullet$  together with morphisms

$$X_0 \leftarrow X_1 \leftarrow X_2 \leftarrow X_3 \leftarrow \cdots,$$

which are usually assumed to be fibrations. A morphism  $X_\bullet \rightarrow Y_\bullet$  of towers is a sequence of maps  $X_k \rightarrow Y_k$  which make all the corresponding squares commute. Two towers are said to be equivalent if there is a zigzag of morphisms between them, which are all objectwise weak homotopy equivalences.

Main Theorem 1 has the following immediate corollary.

**Theorem 1.10.** *Let  $\eta: \mathcal{B}_m \rightarrow P$  be a map of operads, where  $P(0) = *$  and  $P(1) \simeq *$ . Then one has an equivalence of towers:*

$$T_k \text{Ibimod}_{\mathcal{B}_m}^h(T_k \mathcal{B}_m, T_k P) \simeq \Omega^{m+1} T_k \text{Operad}^h(T_k \mathcal{B}_m, T_k P), \quad k \geq 1, \quad (10)$$

implying at the limit  $k = \infty$ :

$$\text{Ibimod}_{\mathcal{B}_m}^h(\mathcal{B}_m, P) \simeq \Omega^{m+1} \text{Operad}^h(\mathcal{B}_m, P). \quad (11)$$

As before for the basepoint in the loop spaces one takes  $T_k \eta$  and  $\eta$ , respectively. This theorem follows from Main Theorem 1 and also the fact that for any map of topological operads  $O \rightarrow P$ , with  $P(1) \simeq *$ , one has an equivalence of towers

$$T_k \text{Bimod}_O^h(T_k O, T_k P) \simeq \Omega T_k \text{Operad}^h(T_k O, T_k P),$$

see [Duc19]. In the case of non- $\Sigma$  operads and  $k = \infty$ , this has been shown earlier by Dwyer and Hess [DH12].

For  $m = 1$ , Theorems 1 and 1.10 were proved earlier by Dwyer-Hess [DH12] and the second author [Tur14]. To be precise this was proved for the associative operad, which is equivalent to  $\mathcal{B}_1$ . Recently another proof appeared in [BDL19]. This result is sometimes referred as the *concrete* topological version of Deligne's Hochschild cohomology conjecture. For Deligne's conjecture, now theorem, and its topological version see [MS04a, MS04b, Vor00] and references in within.

Several years ago Dwyer and Hess announced that they proved (9) and (11). Their approach used the fact that  $\mathcal{B}_m$  is a homotopy Boardmann-Vogt tensor product of  $m$  copies of  $\mathcal{B}_1$  [FV15], which allowed them to peel off the  $m$  deloopings one after another. As we explain in the introduction, this delooping result has many applications and is centrally important for the manifold functor calculus. Having a different proof would be helpful in understanding this connection between algebra and geometry. Also their approach could be useful in describing the partial deloopings of the tower. We hope that they will fix technical difficulties and their proof will finally appear.

In our approach we get deloopings (8) and (9) in one step by taking explicit cofibrant replacements of the source objects which we replace to be the Fulton-MacPherson operad  $\mathcal{F}_m$  and its truncations instead of  $\mathcal{B}_m$ . An advantage of our approach is that we get delooping of all the stages of the tower and not only of their limits.

Theorem 1.10 produces an  $(m+1)$ -delooping of  $T_\bullet \overline{\text{Emb}}_\partial(D^m, D^n)$  and  $T_\bullet \overline{\text{Emb}}_\partial(D^m, D^n)^\mathbb{Q}$ . In particular, one has

$$\overline{\text{Emb}}_\partial(D^m, D^n) \simeq \Omega^{m+1} \text{Operad}^h(\mathcal{B}_m, \mathcal{B}_n), \quad n \geq m+3; \quad (12)$$

$$T_k \overline{\text{Emb}}_\partial(D^m, D^n) \simeq \Omega^{m+1} T_k \text{Operad}^h(T_k \mathcal{B}_m, T_k \mathcal{B}_n), \quad n \geq m. \quad (13)$$

These results were first proved by Boavida de Brita and Weiss [BdBW18, Wei19]. Their method did not use (7) and also could not be applied in a general situation and in particular to any other examples considered above. Specifically it cannot be used to get the following deloopings that follow from our work:

$$T_\infty \overline{\text{Emb}}_\partial(D^m, D^n)^\mathbb{Q} \simeq \Omega^{m+1} \text{Operad}^h(\mathcal{B}_m, \mathcal{B}_n^\mathbb{Q}), \quad n \geq m; \quad (14)$$

$$T_k \overline{\text{Emb}}_\partial(D^m, D^n)^\mathbb{Q} \simeq \Omega^{m+1} T_k \text{Operad}^h(T_k \mathcal{B}_m, T_k \mathcal{B}_n^\mathbb{Q}), \quad n \geq m, \quad (15)$$



Nonetheless, Theorem 1.10 cannot be applied to produce an  $(m+1)$ -delooping of the space  $\text{Emb}_{\partial}^{fr}(D^m, D^n)$  or of the polynomial approximations  $T_{\bullet}\text{Emb}_{\partial}^{fr}(D^m, D^n)$ . Indeed,  $\mathcal{B}_n^{fr}(1)$  is the orthogonal group  $O(n)$ , which is not contractible. In fact it is easy to show that the inclusion  $\mathcal{B}_n \rightarrow \mathcal{B}_n^{fr}$  induces an equivalence of towers

$$T_k \text{Operad}^h(T_k \mathcal{B}_m, T_k \mathcal{B}_n) \simeq T_k \text{Operad}^h(T_k \mathcal{B}_m, T_k \mathcal{B}_n^{fr}), k \geq 1.$$

Thus,  $\text{Operad}^h(\mathcal{B}_m, \mathcal{B}_n^{fr})$  cannot be an  $(m+1)$ -delooping of  $\text{Emb}_{\partial}^{fr}(D^m, D^n)$ ,  $n - m \geq 3$ . It has recently been shown by T. Willwacher and the authors in [DTW18] that

$$\text{Emb}_{\partial}^{fr}(D^m, D^n) \simeq \Omega^{m+1}(\text{Operad}^h(\mathcal{B}_m, \mathcal{B}_n) // SO(n)), n \geq m + 3;$$

$$T_k \text{Emb}_{\partial}^{fr}(D^m, D^n) \simeq \Omega^{m+1}(T_k \text{Operad}^h(T_k \mathcal{B}_m, T_k \mathcal{B}_n) // SO(n)).$$

For other approaches of delooping the spaces of disc embeddings and related problems, see also [Bud12, MS18, Mos02, Sak14].

### 1.5 Generalized delooping results: Main Theorems 2 and 3

To prove (11) we replace the little discs operad by the Fulton-MacPherson operad  $\mathcal{F}_m$ , which, if we ignore its arity zero operation, is cofibrant. Each component  $\mathcal{F}_m(k)$  is a manifold with corners whose interior is the configuration space  $C(k, \mathbb{R}^m)$  of  $k$  distinct points in  $\mathbb{R}^m$  quotiented out by translations and rescalings. On the other hand, again ignoring degeneracies,  $\mathcal{F}_m$  has a natural cofibrant replacement  $\mathcal{IF}_m$  as  $\mathcal{F}_m$ -bimodule, whose components  $\mathcal{IF}_m(k)$  are also manifolds with corners with interior  $C(k, \mathbb{R}^m)$ , see [Tur13] and also Subsection 5.1. Thus this quotient by translations and rescalings kills exactly  $(m+1)$  degrees of freedom and suggests the delooping (11). Similarly, for (9), the spaces  $C(k, \mathbb{R}^m)$  quotiented only by translations must admit a natural compactification  $\mathcal{BF}_m(k)$ , so that the sequence  $\mathcal{BF}_m$  forms a cofibrant replacement of  $\mathcal{F}_m$  as  $\mathcal{F}_m$ -bimodule, see Subsection 5.4. Now, translations of  $\mathbb{R}^m$  have  $m$  degrees of freedom, which explains that we only get  $m$ -th delooping in (9). This idea that lost degrees of freedom correspond to deloopings has been successfully put to use by the second author in [Tur14] for the case  $m = 1$  of the associative operad. Our work and the techniques that we use are inspired from [Tur14]. However, instead of these geometrical cofibrant replacements of  $\mathcal{F}_m$  in the categories of bimodules and infinitesimal bimodules, we use combinatorial ones of the Boardman-Vogt type. We sketch briefly the geometrical approach in Subsection 6.3. A crucial thing is the construction of the delooping map between the towers, which appears more natural in this geometrical approach. The geometrical approach required more work, so instead we used the Boardman-Vogt type resolutions which are easier to define. In fact we conjecture that they are homeomorphic to the geometric ones, see Section 5. As an outcome we were able to prove a more general result, which implies Main Theorem 1.

**Main Theorem 2.** *Let  $O$  be a coherent,  $\Sigma$ -cofibrant, well-pointed, and weakly doubly reduced ( $O(0) = *$ ,  $O(1) \simeq *$ ) operad, and let  $\eta: O \rightarrow M$  be an  $O$ -bimodules map, with  $M(0) = *$ . Then one has an equivalence of towers:*

$$T_k \text{Ibimod}_O^h(T_k O, T_k M) \simeq \text{Map}_*(\Sigma O(2), T_k \text{Bimod}_O^h(T_k O, T_k M)), k \geq 0, \quad (16)$$

implying at the limit  $k = \infty$ :

$$\text{Ibimod}_O^h(O, M) \simeq \text{Map}_*(\Sigma O(2), \text{Bimod}_O^h(O, M)). \quad (17)$$

Here  $\text{Map}_*(-, -)$  denotes the space of pointed maps, and  $T_k \text{Bimod}_O^h(T_k O, T_k M)$ ,  $\text{Bimod}_O^h(O, M)$  are pointed in  $T_k \eta$  and  $\eta$ , respectively. The property of being *coherent* is expressed in terms of a certain homotopy recurrence relation on the components of  $O$ , see Definition 4.4. To have equivalence of towers (16) only up to stage  $k$ , it is enough for an operad to be *k-coherent*, meaning that the recurrence relation works only up to arity  $k$ , see Definition 4.4.

Theorems 4.9, 5.1 and Lemma 4.8 imply that any operad equivalent to the little discs operad  $\mathcal{B}_d$ ,  $0 \leq d \leq \infty$ , is coherent. It would be interesting to find other coherent operads, as so far these are the only examples that we know. In fact we showed that for any weakly doubly reduced,  $\Sigma$ -cofibrant, and well-pointed (but not necessarily coherent) operad  $O$ , one has a naturally defined map from the right-hand side to the left-hand side of (16). Then we were able to determine homotopy conditions of *coherence* on  $O$  that ensure that this map is a weak equivalence. It would be interesting to understand what this map measures, what is exactly its nature, and whether there are similar algebraic settings producing analogous maps.

As an attempt to understand better this phenomenon, in the very last Subsection 7.4 we formulate and sketch a proof of a more general statement – Main Theorem 3, which shed some light at least on the algebraic side of this problem. The property of being coherent is really a condition on an infinitesimal bimodule rather than on an operad. In case  $N$  is a coherent  $O$ -bimodule endowed with a map  $N \rightarrow O$ , Main Theorem 3 describes the space  $\text{Ibimod}_O^h(N, M)$  similarly to the right-hand side of (17) as a space of based maps from a space  $C_N$  depending on  $O$  and  $N$  to the space  $\text{Bimod}_O^h(O, M)$ . We do not see any immediate geometrical application of this more general result, but it is interesting from the algebraic viewpoint. This more general result must have much more examples since coherent infinitesimal bimodules must be easier to construct than coherent operads.

### Acknowledgements.

The second author is grateful to G. Arone, M. Kontsevich, and P. Lambrechts, discussions with whom brought him to the problem solved in the paper (Main Theorem 1 and Theorem 1.10). The authors are indebted to B. Fresse for answering numerous questions on the homotopy theory. The authors also thank G. Arone, T. Banach, C. Berger, P. Boavida de Brito, P. Gaucher, K. Hess, D. Nardin, D. Sinha, M. Weiss, and D. Yetter for communication. Finally, the authors acknowledge University of Paris 13 and Kansas State University for generous support that allowed a one month visit by Ducoulombier to KSU. The first author is partially supported by the grant ERC-2015-StG 678156 GRAPHCPX while the second author is partially supported by the Simons Foundation collaboration grant, award ID: 519474.

## 2 Homotopy theory

In this section we build up the necessary homotopy background. We describe the model structure for the categories of  $\Sigma$  and  $\Lambda$ -sequences, operads, bimodules, infinitesimal bimodules, and the truncated versions of all these structures. In fact we consider two model structures for these algebraic objects: projective and Reedy. The projective one is obtained by transferring the projective model structure from  $\Sigma$ -sequences and the Reedy model structure is obtained by transferring the Reedy structure from  $\Lambda$ -sequences. There are a few reasons why we want to use both structures. The projective one is more common, for example it is the one used in the manifold calculus in particular for equivalence (6). Also in the projective structure the construction of the derived mapping spaces is more explicit: since all objects are fibrant we do not need to worry about the fibrant replacements, which on the contrary are difficult to make explicit in the Reedy structure.<sup>1</sup> The advantage of the Reedy structure is that it simplifies the proof of Main Theorem 2. Using it makes the proof more elegant in the case when the operad  $O$  is doubly reduced ( $O(0) = O(1) = *$ ). Also the generalization from the strictly to weakly doubly reduced case ( $O(0) = *$ ,  $O(1) \simeq *$ ) relies on certain homotopy properties of the Reedy model structure (Theorems 2.1, 2.3 (iii)) that we were not able to check for the projective structure. Having both structures available could be handy for a possible future work. A detailed study of the projective and Reedy model structures for (infinitesimal) bimodules is done in the work [DFT19] by B. Fresse and the authors.

<sup>1</sup>In fact in [DFT19, Section 3.1.1] B. Fresse and the authors produce an explicit Reedy fibrant replacement in the categories of (infinitesimal) bimodules. However, if we compare explicit derived mapping spaces, in the projective structure they still appear to be smaller.

## 2.1 $\Sigma$ and $\Lambda$ sequences

Following [Fre17], we denote by  $\Lambda$  the category whose objects are finite sets  $\underline{n} = \{1, \dots, n\}$ ,  $n \geq 0$ , and morphisms are injective maps between them. The category  $\Sigma \subset \Lambda$  is the subcategory of isomorphisms of  $\Lambda$ . By a  $\Sigma$ -sequence, respectively  $\Lambda$ -sequence, we understand a functor  $\Sigma^{op} \rightarrow \text{Top}$ , respectively  $\Lambda^{op} \rightarrow \text{Top}$ . The categories of  $\Sigma$  and  $\Lambda$ -sequences are denoted by  $\Sigma\text{Seq} = \text{Top}^{\Sigma^{op}}$  and  $\Lambda\text{Seq} = \text{Top}^{\Lambda^{op}}$ , respectively. Let  $\Sigma_{>0} \subset \Sigma$  and  $\Lambda_{>0} \subset \Lambda$  be the full subcategories of non-empty sets. We similarly define the categories  $\Sigma_{>0}\text{Seq}$ ,  $\Lambda_{>0}\text{Seq}$  of  $\Sigma_{>0}$  and  $\Lambda_{>0}$ -sequences. One has obvious adjunctions

$$(-)_{>0}: \Sigma\text{Seq} \rightleftarrows \Sigma_{>0}\text{Seq}: (-)_+;$$

$$(-)_{>0}: \Lambda\text{Seq} \rightleftarrows \Lambda_{>0}\text{Seq}: (-)_+;$$

where  $M_{>0}$  is obtained from  $M$  by forgetting its arity zero component, and  $N_+$  is obtained from  $N$  by defining  $N_+(0) = *$  and keeping all the other components the same.

Similarly to Subsection 1.3.2 we also consider the categories  $T_k\Lambda$ ,  $T_k\Sigma$ ,  $T_k\Lambda_{>0}$ ,  $T_k\Sigma_{>0}$  as full subcategories of  $\Sigma$  and  $\Lambda$  of objects with  $\leq k$  elements, and we consider the diagram categories of  $k$ -truncated sequences  $T_k\Lambda\text{Seq}$ ,  $T_k\Sigma\text{Seq}$ , etc.

The categories  $\Sigma\text{Seq}$ ,  $\Sigma_{>0}\text{Seq}$ ,  $T_k\Sigma\text{Seq}$ ,  $T_k\Sigma_{>0}\text{Seq}$  being diagram categories are endowed with the so called *projective model structure* [Hir03, Section 11.6], [Fre17, Section II.8.1]. For this model structure, a map  $M \rightarrow N$  is a weak equivalence, respectively a fibration, if it is an objectwise weak homotopy equivalence, respectively an objectwise Serre fibration. This model structure is cofibrantly generated, and all the objects are fibrant in it.

The categories  $\Lambda\text{Seq}$ ,  $\Lambda_{>0}\text{Seq}$ ,  $T_k\Lambda\text{Seq}$ ,  $T_k\Lambda_{>0}\text{Seq}$  are endowed with the so called *Reedy model structure*. The idea is that they are also diagram categories with the source category of generalized Reedy type [BM11], [Fre17, Section II.8.3]. For a (possibly truncated)  $\Lambda$ -sequence  $X$ , we denote by  $M(X)$  the (truncated)  $\Sigma$ -sequence defined as

$$M(X)(r) = \lim_{\substack{u \in \text{Mor}_{\Lambda}(\underline{i}, \underline{r}) \\ i < r}} X(i) \quad (18)$$

and called *matching object* of  $X$ . By [Fre17, Proposition II.8.3.2], it can equivalently be defined as

$$M(X)(r) = \lim_{\substack{u \in \text{Mor}_{\Lambda^+}(\underline{i}, \underline{r}) \\ i < r}} X(i), \quad (19)$$

where  $\Lambda^+$  is the subcategory of  $\Lambda$  consisting of order-preserving maps. Thus (19) is a limit over a so called subcubical diagram (see Subsection 4.1). For  $\Lambda_{>0}$  and  $T_k\Lambda_{>0}$ -sequences we slightly modify (18), (19) by excluding  $i = 0$  in the diagram of the limit.

According to [BM11], [Fre17, Section II.8.3], the categories  $\Lambda\text{Seq}$ ,  $\Lambda_{>0}\text{Seq}$ ,  $T_k\Lambda\text{Seq}$ ,  $T_k\Lambda_{>0}\text{Seq}$  are endowed with the cofibrantly generated model structure for which weak equivalences are objectwise weak homotopy equivalences, fibrations are morphisms  $M \rightarrow N$  for which any induced map  $M(r) \rightarrow M(M)(r) \times_{M(N)(r)} N(r)$  is a Serre fibration in every arity where defined. As shown in [Fre17, Theorem II.8.3.20], a morphism of  $\Lambda$ ,  $\Lambda_{>0}$ ,  $T_k\Lambda$ ,  $T_k\Lambda_{>0}$  sequences is a cofibration if and only if it is a cofibration as a morphism of  $\Sigma$ ,  $\Sigma_{>0}$ ,  $T_k\Sigma$ ,  $T_k\Sigma_{>0}$ -sequences, respectively.

## 2.2 Operads

Abusing notation we also denote by  $\Lambda$  the operad defined as

$$\Lambda(r) = \begin{cases} *, & r = 0 \text{ or } 1; \\ \emptyset, & r \geq 2. \end{cases} \quad (20)$$

One can easily see that a right module over this operad is the same thing as a  $\Lambda$ -sequence. Note that a left  $\Lambda$ -module is simply a  $\Sigma$ -sequence  $M$  for which  $M(0)$  is pointed.

Recall that an operad  $O$  is called *reduced* if  $O(0) = *$ . Since  $O$  contains the operad  $\Lambda$ , any right  $O$  module is automatically a  $\Lambda$ -sequence. Thus any bimodule or infinitesimal bimodule over  $O$  including  $O$  itself is also a  $\Lambda$ -sequence. The reduced operads will also be called  *$\Lambda$ -operads*. We denote by  $\Lambda\text{Operad}$  the category of reduced operads. We also use notation  $\Sigma\text{Operad}$  for the category of all operads, and  $\Sigma_{>0}\text{Operad}$  for the category of operads whose arity zero component is empty.

One has an adjunction

$$\tau: \Sigma\text{Operad} \rightleftarrows \Lambda\text{Operad}: \iota, \quad (21)$$

where  $\iota$  is the obvious inclusion and  $\tau$  is the *unitarization* functor [FTW18], which collapses the arity zero component to a point and takes the other components to the quotient induced by this collapse.

The category  $\Sigma\text{Operad}$  is endowed with the so called *projective model structure* transferred from  $\Sigma\text{Seq}$  along the adjunction

$$\mathcal{F}_{Op}^\Sigma: \Sigma\text{Seq} \rightleftarrows \Sigma\text{Operad}: \mathcal{U}^\Sigma, \quad (22)$$

where  $\mathcal{U}^\Sigma$  is the forgetful functor, and  $\mathcal{F}_{Op}^\Sigma$  is the free functor, see [BM03]. “Transferred” means that a morphism  $P \rightarrow Q$  of operads is a weak equivalence, respectively a fibration, if and only if it is a weak equivalence, respectively a fibration, as a morphism of  $\Sigma$ -sequences.

The category  $\Lambda\text{Operad}$  is endowed with the so called *Reedy model structure* transferred from  $\Lambda_{>0}\text{Seq}$  along the adjunction

$$\mathcal{F}_{Op}^\Lambda: \Lambda_{>0}\text{Seq} \rightleftarrows \Lambda\text{Operad}: \mathcal{U}^\Lambda, \quad (23)$$

see [Fre17, Section II.8.4]. An important property of  $\mathcal{F}_{Op}^\Lambda$  is that  $\mathcal{F}_{Op}^\Lambda(X)_{>0} = \mathcal{F}_{Op}^\Sigma(X)$ : the free  $\Lambda$ -operad generated by a  $\Lambda_{>0}$ -sequence  $X$  in positive arities is the free operad generated by the  $\Sigma_{>0}$ -sequence  $X$ . Using this fact it has been shown in [Fre17, Theorem II.8.4.12] that a morphism  $P \rightarrow Q$  of  $\Lambda$ -operads is a cofibration if and only if  $P_{>0} \rightarrow Q_{>0}$  is a cofibration of operads in the projective model structure.

The projective and Reedy model structures on the categories of (reduced)  $k$ -truncated operads  $T_k\Sigma\text{Operad}$  and  $T_k\Lambda\text{Operad}$  are defined similarly by transferring the model structure along the corresponding adjunction

$$\mathcal{F}_{Op}^{T_k\Sigma}: T_k\Sigma\text{Seq} \rightleftarrows T_k\Sigma\text{Operad}: \mathcal{U}^{T_k\Sigma},$$

$$\mathcal{F}_{Op}^{T_k\Lambda}: T_k\Lambda_{>0}\text{Seq} \rightleftarrows T_k\Lambda\text{Operad}: \mathcal{U}^{T_k\Lambda}.$$

It has been shown in [FTW18] that the adjunction (21) and its truncated versions are Quillen. Moreover, for any pair of reduced ( $k$ -truncated) operads  $P$  and  $Q$ , one has

$$\Sigma\text{Operad}^h(\iota P, \iota Q) \simeq \Lambda\text{Operad}^h(P, Q), \quad (24)$$

respectively,

$$T_k\Sigma\text{Operad}^h(\iota P, \iota Q) \simeq T_k\Lambda\text{Operad}^h(P, Q), \quad (25)$$

see [FTW18, Theorems 1&1’]. The equivalences (24)-(25) are immediately derived from the fact that for a cofibrant replacement  $WP$  of  $\iota P$ , the natural map  $\tau WP \rightarrow P$  is an equivalence.

Because of the equivalences (24)-(25) we do not distinguish between the two derived mapping spaces and simply write  $\text{Operad}^h(-, -)$ ,  $T_k\text{Operad}^h(-, -)$ .

We notice for future use that the truncation functor  $T_k: \Lambda\text{Operad} \rightarrow T_k\Lambda\text{Operad}$  preserves cofibrations because  $T_k: \Sigma_{>0}\text{Operad} \rightarrow T_k\Sigma_{>0}\text{Operad}$  does so; and it preserves fibrations because  $T_k: \Lambda_{>0}\text{Seq} \rightarrow T_k\Lambda_{>0}\text{Seq}$  preserves fibrations.

We also need the following fact about  $\Lambda$  operads. Recall that an operad  $O$  is *weakly doubly reduced* if it is reduced and  $O(1) \simeq *$ , and it is *doubly reduced* or *strictly doubly reduced* if  $O(0) = O(1) = *$ .

**Theorem 2.1.** *For any weakly doubly reduced operad  $O$  there exists a zigzag of weak equivalences of reduced operads*

$$O \xleftarrow{\cong} WO \xrightarrow{\cong} W_1O,$$

where both  $WO$  and  $W_1O$  are Reedy cofibrant and  $W_1O$  is doubly reduced.

*Idea of the proof.* In case  $O$  is  $\Sigma$ -cofibrant and well-pointed (the case that we need), one can take  $WO$  to be the Boardmann-Vogt resolution of  $O_{>0}$  to which we add a point in arity zero. The operad  $W_1O$  is obtained from  $WO$  by the *second unitarization*: collapsing the arity one component to a point and quotienting the other components according to the equivalence relation that this collapse produces. The complete proof is given in Appendix A.2.  $\square$

### 2.3 Bimodules

Let  $O$  be a topological operad. In this subsection we denote by  $\Sigma\text{Bimod}_O$  the category of all  $O$  bimodules. In case  $O$  is reduced ( $O(0) = *$ ), we denote by  $\Lambda\text{Bimod}_O$  the category of reduced  $O$  bimodules, i.e. bimodules  $M$  with  $M(0) = *$ . One has a similar unitarization-inclusion adjunction

$$\tau: \Sigma\text{Bimod}_O \rightleftarrows \Lambda\text{Bimod}_O: \iota, \quad (26)$$

where  $\iota$  is the inclusion functor, and  $\tau$  is its adjoint – it collapses the arity zero component to a point, and adjusts the other components according to the equivalence relation induced by this collapse. We also have the free-forgetful adjunctions

$$\mathcal{F}_B^\Sigma: \Sigma\text{Seq} \rightleftarrows \Sigma\text{Bimod}_O: \mathcal{U}^\Sigma; \quad (27)$$

$$\mathcal{F}_B^\Lambda: \Lambda_{>0}\text{Seq} \rightleftarrows \Lambda\text{Bimod}_O: \mathcal{U}^\Lambda. \quad (28)$$

Explicitly,  $\mathcal{F}_B^\Sigma(X) = O \circ X \circ O$ , and  $\mathcal{F}_B^\Lambda(Y) = O \circ_\Lambda Y \circ_\Lambda O$ . Here  $\Lambda$  is considered as an operad (20) and we use the following standard notation that will be also useful for us in the sequel.

**Notation 2.2.** For an operad  $P$ , its right module  $M$  and its left module  $N$ , we define  $M \circ_P N$  as the coequalizer of  $M \circ P \circ N \rightrightarrows M \circ N$ , where the upper arrow is induced by the right  $P$ -action on  $M$  (i.e. the operation  $M \circ P \rightarrow M$ ) and the lower arrow is induced by the left  $P$ -action on  $N$  (i.e. the operation  $P \circ N \rightarrow N$ ).

One can easily see that as a bimodule over  $O_{>0}$ ,

$$\mathcal{F}_B^\Lambda(Y)_{>0} = O_{>0} \circ Y \circ O_{>0},$$

it is a free  $O_{>0}$ -bimodule generated by  $Y$ .

The three adjunctions above have also their truncated counterparts:

$$\tau: T_k \Sigma\text{Bimod}_O \rightleftarrows T_k \Lambda\text{Bimod}_O: \iota, \quad (29)$$

$$\mathcal{F}_B^{T_k \Sigma}: T_k \Sigma\text{Seq} \rightleftarrows T_k \Sigma\text{Bimod}_O: \mathcal{U}^{T_k \Sigma}, \quad (30)$$

$$\mathcal{F}_B^{T_k \Lambda}: T_k \Lambda_{>0}\text{Seq} \rightleftarrows T_k \Lambda\text{Bimod}_O: \mathcal{U}^{T_k \Lambda}. \quad (31)$$

Here  $T_k \Sigma\text{Bimod}_O$  (respectively,  $T_k \Lambda\text{Bimod}_O$ ) are the categories of (reduced)  $k$ -truncated bimodules over  $O$ .

In case  $O$  is  $\Sigma$ -cofibrant and well-pointed, the categories  $\Sigma\text{Bimod}_O$  and  $T_k \Sigma\text{Bimod}_O$  admit a cofibrantly generated model structure transferred from  $\Sigma\text{Seq}$ ,  $T_k \Sigma\text{Seq}$  along the adjunctions (27) and (30) respectively, see [Duc19] and also [Fre09, Section 14.3]. We use the following results from [DFT19].

**Theorem 2.3.** ([DFT19, Theorems 3.1, 3.5, 3.6])

- (i) *For a  $\Sigma$ -cofibrant, well-pointed, and reduced topological operad  $O$ , the categories  $\Lambda\text{Bimod}_O$  and  $T_k \Lambda\text{Bimod}_O$ ,  $k \geq 0$ , admit a cofibrantly generated model structure transferred from  $\Lambda_{>0}\text{Seq}$  and  $T_k \Lambda_{>0}\text{Seq}$ , respectively, along the adjunctions (28) and (31), respectively. (We call them Reedy model structures.)*

- (ii) A morphism  $M \rightarrow N$  of reduced ( $k$ -truncated)  $O$ -bimodules is a cofibration in this model structure if and only if  $M_{>0} \rightarrow N_{>0}$  is a cofibration of  $O_{>0}$ -bimodules in the projective model structure.
- (iii) In case  $O$  is a Reedy cofibrant operad, the model structure on  $\Lambda\text{Bimod}_O$  is left proper relative to the class of  $\Sigma$ -cofibrant reduced bimodules.

**Theorem 2.4.** ([DFT19, Proposition 3.10, Theorem 3.11]) For a reduced, well-pointed, and  $\Sigma$ -cofibrant operad  $O$ , the adjunctions (26) and (29) are Quillen adjunctions. Moreover, for any pair  $M, N \in \Lambda\text{Bimod}_O$  (respectively,  $M, N \in T_k\Lambda\text{Bimod}_O, k \geq 0$ ), one has

$$\Sigma\text{Bimod}_O^h(\iota M, \iota N) \simeq \Lambda\text{Bimod}_O^h(M, N), \quad (32)$$

respectively,

$$T_k\Sigma\text{Bimod}_O^h(\iota M, \iota N) \simeq T_k\Lambda\text{Bimod}_O^h(M, N). \quad (33)$$

Because of the equivalences (32)-(33), we do not distinguish between the two versions of derived mapping spaces (projective and Reedy), and simply write  $\text{Bimod}_O^h(-, -)$  and  $T_k\text{Bimod}_O^h(-, -)$ . For the proof of the main theorem we use the Reedy version as it makes the proof easier. Finally, in the  $\Lambda$ -case one has the expected comparison theorem.

**Theorem 2.5.** ([DFT19, Theorem 3.7]) For any weak equivalence  $\phi: O_1 \xrightarrow{\cong} O_2$  of reduced,  $\Sigma$ -cofibrant, and well-pointed operads, one has Quillen equivalences

$$\phi_B^!: \Lambda\text{Bimod}_{O_1} \rightleftarrows \Lambda\text{Bimod}_{O_2}: \phi_B^*, \quad (34)$$

$$\phi_B^!: T_k\Lambda\text{Bimod}_{O_1} \rightleftarrows T_k\Lambda\text{Bimod}_{O_2}: \phi_B^*, \quad (35)$$

where  $\phi_B^*$  is the restriction functor and  $\phi_B^!$  is the induction one.

## 2.4 Infinitesimal bimodules

For a reduced topological operad  $O$  whose components  $O(k), k \geq 0$ , are cofibrant spaces, we consider two model structures on  $\text{Ibimod}_O$  and  $T_k\text{Ibimod}_O$ : projective and Reedy. In order to distinguish between the two and also to be consistent with the notation in the previous subsections, the category  $\text{Ibimod}_O$  (respectively,  $T_k\text{Ibimod}_O$ ) with the projective model structure is denoted by  $\Sigma\text{Ibimod}_O$  (respectively,  $T_k\Sigma\text{Ibimod}_O$ ) and the same category with the Reedy model structure is denoted by  $\Lambda\text{Ibimod}_O$  (respectively,  $T_k\Lambda\text{Ibimod}_O$ ).

The projective one is transferred from  $\Sigma\text{Seq}$  (respectively,  $T_k\Sigma\text{Seq}$ ) along the free-forgetful adjunctions:

$$\mathcal{F}_{Ib}^\Sigma: \Sigma\text{Seq} \rightleftarrows \Sigma\text{Ibimod}_O: \mathcal{U}^\Sigma; \quad (36)$$

$$\mathcal{F}_{Ib}^{T_k\Sigma}: T_k\Sigma\text{Seq} \rightleftarrows T_k\Sigma\text{Ibimod}_O: \mathcal{U}^{T_k\Sigma}, \quad k \geq 0. \quad (37)$$

For the category of right modules over an operad with cofibrant components, such model structure is constructed in [Fre09, Proposition 14.1.A]. Our case is very similar. Indeed, the structure of a right module is the same thing as a functor  $F(O) \rightarrow \text{Top}$  from a certain topologically enriched category  $F(O)$  to  $\text{Top}$  [AT14, Definition 4.1, Proposition 4.3]. Thus the category of right modules is essentially a diagram category  $\text{Top}^{F(O)}$ , where the category  $F(O)$  has cofibrant all morphism spaces. Similarly, the category  $\text{Ibimod}_O$  can be described as a diagram category  $\text{Top}^{\tilde{\Gamma}(O)}$ , where  $\tilde{\Gamma}(O)$  is also a topologically enriched category assigned to  $O$  with the same properties [AT14, Definition 4.7, Proposition 4.9]. Thus we can again consider the projective model structure for the enriched version of the diagram categories [BB17, Theorem 4.1].

The Reedy model structure is transferred from  $\Lambda\text{Seq}$  (respectively,  $T_k\Lambda\text{Seq}$ ) along the adjunctions:

$$\mathcal{F}_{Ib}^\Lambda: \Lambda\text{Seq} \rightleftarrows \Lambda\text{Ibimod}_O: \mathcal{U}^\Lambda; \quad (38)$$



$$\mathcal{F}_{Ib}^{T_k\Lambda} : T_k\Lambda\text{Seq} \rightleftarrows T_k\Lambda\text{Ibimod}_O : \mathcal{U}^{T_k\Lambda}, \quad k \geq 0. \quad (39)$$

One can easily check that for a  $\Lambda$ -sequence  $X$  (respectively,  $T_k\Lambda$ -sequence  $X$ ), the sequence  $\mathcal{F}_{Ib}^\Lambda(X)$  (respectively,  $\mathcal{F}_{Ib}^{T_k\Lambda}(X)$ ) as a ( $k$ -truncated)  $O_{>0}$ -Ibimodule is freely generated by the ( $k$ -truncated)  $\Sigma$ -sequence  $X$ . We use the following results from [DFT19].

**Theorem 2.6.** ([DFT19, Theorems 5.1 and 5.4])

- (i) For any reduced topological operad  $O$  with cofibrant components, the category of  $O$ -Ibimodules (respectively,  $k$ -truncated  $O$ -Ibimodules,  $k \geq 0$ ) admits a cofibrantly generated model structure transferred from  $\Lambda\text{Seq}$  (respectively,  $T_k\Lambda\text{Seq}$ ) along (38) (respectively, (39)).
- (ii) A map  $\alpha : M \rightarrow N$  of ( $k$ -truncated)  $O$ -Ibimodules is a cofibration in this (Reedy) model structure if and only if  $\alpha$  is a cofibration of  $O_{>0}$ -Ibimodules in the projective model structure.

**Theorem 2.7.** ([DFT19, Theorem 5.9])

- (i) For any reduced topological operad  $O$  with cofibrant components, one has Quillen equivalences:

$$id : \Sigma\text{Ibimod}_O \rightleftarrows \Lambda\text{Ibimod}_O : id; \quad (40)$$

$$id : T_k\Sigma\text{Ibimod}_O \rightleftarrows T_k\Lambda\text{Ibimod}_O : id. \quad (41)$$

- (ii) As a consequence, for any pair of ( $k$ -truncated)  $O$ -Ibimodules  $M$  and  $N$ , one has an equivalence of mapping spaces:

$$\Sigma\text{Ibimod}_O^h(M, N) \simeq \Lambda\text{Ibimod}_O^h(M, N), \quad (42)$$

$$T_k\Sigma\text{Ibimod}_O^h(M, N) \simeq T_k\Lambda\text{Ibimod}_O^h(M, N), \quad (43)$$

respectively.

Because of the equivalences (42)-(43), we do not distinguish between the two mapping spaces and simply write  $\text{Ibimod}_O^h(-, -)$  and  $T_k\text{Ibimod}_O^h(-, -)$ . For the proof of the main theorem we use the Reedy version of the derived mapping space. Here is the comparison theorem in the  $\Lambda$  case.

**Theorem 2.8.** ([DFT19, Theorem 5.6]) For any weak equivalence  $\phi : O_1 \xrightarrow{\cong} O_2$  of reduced well-pointed operads with cofibrant components, one has Quillen equivalences

$$\phi_{Ib}^! : \Lambda\text{Ibimod}_{O_1} \rightleftarrows \Lambda\text{Ibimod}_{O_2} : \phi_{Ib}^*, \quad (44)$$

$$\phi_{Ib}^! : T_k\Lambda\text{Ibimod}_{O_1} \rightleftarrows T_k\Lambda\text{Ibimod}_{O_2} : \phi_{Ib}^*, \quad (45)$$

where  $\phi_{Ib}^*$  is the restriction functor and  $\phi_{Ib}^!$  is the induction one.

## 2.5 Topological spaces: products, subspaces, quotients, mapping spaces

In [Fre17], B. Fresse uses the category of simplicial sets as the underlying category of  $\Lambda$ -operads. However, his methods are easily adaptable to other model categories [Fre17, Section II.8.4]. Throughout the paper by the category  $\text{Top}$  of spaces we understand the category of  $k$ -spaces (compactly generated possibly non-Hausdorff spaces). The model category structure on  $\text{Top}$  is defined in [Hov99, Section 2.4], where it is denoted by  $\mathbf{K}$ . This category is cartesian closed [Lew78, Appendix A], [Vog71], which implies that for any  $X, Y, Z \in \text{Top}$ , one has homeomorphisms:

$$\text{Map}(X \times Y, Z) \cong \text{Map}(X, \text{Map}(Y, Z)), \quad (46)$$

which is not in general true in the category  $\text{AllTop}$  of all topological spaces. We freely use the homeomorphism (46) and its based and/or equivariant versions. We also use the homeomorphism (and its based/equivariant versions):

$$\text{Map}(X, \prod_i Y_i) \cong \prod_i \text{Map}(X, Y_i), \quad (47)$$

which holds in  $\text{AllTop}$  as well, and the fact that for any equivalence relation  $\sim$  on any  $k$ -space  $X$ , the natural inclusion

$$\text{Map}(X/\sim, Y) \subset \text{Map}(X, Y) \quad (48)$$

is a homeomorphism on its image, see Lemma A.1. The latter fact is not true in general in  $\text{AllTop}$ , see [Mat].

As a particular case of Lemma A.1 or rather of its pointed version, in  $\text{Top}$  for any inclusion  $X_0 \subset X$  and any pointed space  $(Y, *)$ , the space of pointed maps is homeomorphic to the space of maps of pairs:

$$\text{Map}_*(X/X_0, Y) \cong \text{Map}((X, X_0), (Y, *)),$$

which is also used at several occasions in the paper.

We warn the reader that here and everywhere throughout the paper the products, subspaces, and more generally limits, as well as mapping spaces should be taken with the kellyfication of their standard product, subspace, or compact-open topologies. The quotients and any colimits of  $k$ -spaces are always  $k$ -spaces and kellyfication is not necessary. Basic properties of the category  $\text{Top}$  of  $k$ -spaces are recalled in Appendix A.1.

### 3 Cofibrant replacements

In order to construct the towers (16) whose stages are derived mapping spaces, we need explicit cofibrant replacements for bimodules and infinitesimal bimodules. We use the Boardman-Vogt resolution, which has been introduced in [BV68] for topological operads and adapted to bimodules by the first author in [Duc18, Duc19]. In Subsection 3.1 we recall this construction and then adjust it to the  $\Lambda$  setting. In the second Subsection 3.2 we construct a Boardman-Vogt type resolution for infinitesimal bimodules.

In order to fix notation, a *planar tree*  $T$  is a finite planar tree with one output edge on the bottom and input edges on the top. The output and input edges are considered to be half-open, i.e. connected only to one vertex in the body of the tree. The vertex connected to the output edge, called the *root* of  $T$ , is denoted by  $r$ . Each edge in the tree is endowed with an orientation from top to bottom. Let  $T$  be a planar tree:

- ▶ The set of its vertices and the set of its edges are denoted by  $V(T)$  and  $E(T)$  respectively. The set of its inner edges  $E^{int}(T)$  is formed by the edges connecting two vertices. Each edge or vertex is joined to the root by a unique path composed of edges.
- ▶ According to the orientation of the tree, if  $e$  is an inner edge, then its vertex  $t(e)$  toward the root is called the *target vertex* whereas the other vertex  $s(e)$  is called the *source vertex*.
- ▶ The input edges are called *leaves* and they are ordered from left to right. Let  $in(T) := \{l_1, \dots, l_{|T|}\}$  denote the ordered set of leaves with  $|T|$  the number of leaves.
- ▶ The set of incoming edges of a vertex  $v$  is ordered from left to right. This set is denoted by  $in(v) := \{e_1(v), \dots, e_{|v|}(v)\}$  with  $|v|$  the number of incoming edges. The unique output edge of  $v$  is denoted by  $e_0(v)$ .
- ▶ The number  $|v|$  of incoming edges for a vertex  $v$  will be called the *arity* of  $v$ , whereas the total number of adjacent edges at  $v$  will be called the *valence* of  $v$ .

A *labelled planar tree* is a pair  $(T; \sigma)$  where  $T$  is a planar tree and  $\sigma : \{1, \dots, |T|\} \rightarrow in(T)$  is a bijection labelling the leaves of  $T$ . Such an element is denoted by  $T$  if there is no ambiguity about the bijection  $\sigma$ . We denote by  $\mathbf{tree}_k$  the set of labelled planar trees with  $k$  leaves. The bijection  $\sigma$  can be interpreted as an element in the symmetric group  $\Sigma_k$ . By convention, the  $k$ -corolla is the tree with one vertex and  $k$  leaves, indexed by the identity permutation. By  $\mathbf{tree}_k^{\geq 1}$ , respectively,  $\mathbf{tree}_k^{\geq 2}$ , we denote the subset of  $\mathbf{tree}_k$  all of whose vertices have arity  $\geq 1$ , respectively,  $\geq 2$ .

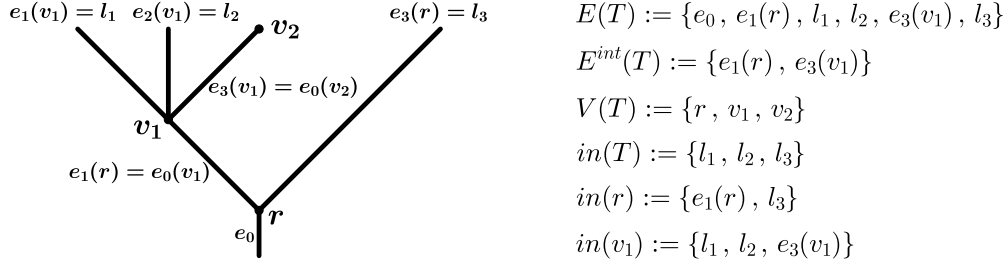

Figure 1: Example of a planar tree.

### 3.1 Boardman-Vogt resolution for bimodules

Below we present a functorial cofibrant replacement for bimodules over an operad. The main difference with the similar resolution for operads is that vertices in the trees could now be of two types: pearls labeled by elements of the bimodule and usual internal vertices labeled by elements of the operad. Also instead of edges being assigned numbers from  $[0, 1]$ , such numbers are assigned to the usual internal vertices. We need the following combinatorial set of trees.

#### Definition 3.1. The set of trees with section

Let  $\mathbf{stree}_k$  be the set of pairs  $(T; V^p(T))$  where  $T \in \mathbf{tree}_k$ , and  $V^p(T)$  is a subset of  $V(T)$ , called the *set of pearls*. Each path joining a leaf or a univalent vertex with the root passes through a unique pearl. The set of pearls forms a horizontal section cutting the tree  $T$  into two parts. Elements in  $\mathbf{stree}_k$  are called (planar labelled) *trees with section*.

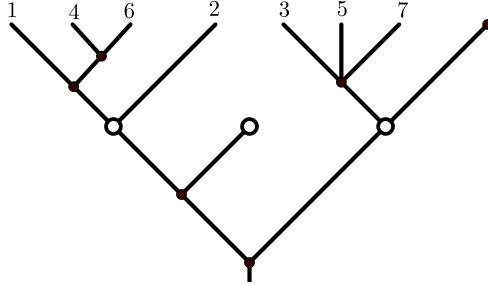

Figure 2: A tree with section.

**Construction 3.2.** From an  $O$ -bimodule  $M$ , we build an  $O$ -bimodule  $\mathcal{B}_O^\Sigma(M)$ . When  $O$  is understood we simply denote it by  $\mathcal{B}^\Sigma(M)$ . The superscript  $\Sigma$  indicates that we construct a cofibrant replacement of a bimodule in the projective model structure. The points of  $\mathcal{B}^\Sigma(M)(k)$ ,  $k \geq 0$ , are equivalence classes  $[T; \{t_v\}; \{a_v\}]$ , where  $T \in \mathbf{stree}_k$  and  $\{a_v\}_{v \in V(T)}$  is a family of points labelling the vertices of  $T$ . The pearls are labelled by points in  $M$  with the corresponding arity, whereas the other vertices are labelled by points in the operad  $O$  again assuming that the arity is respected. Furthermore,  $\{t_v\}_{v \in V(T) \setminus V^p(T)}$  is a family of real numbers in the interval  $[0, 1]$  indexing the vertices which are not pearls. If  $e$  is an inner edge above the section, then  $t_{s(e)} \geq t_{t(e)}$ . Similarly, if  $e$  is an inner edge below the section, then  $t_{s(e)} \leq t_{t(e)}$ . In other words, the closer a vertex is to a pearl, the smaller is the corresponding number. The space  $\mathcal{B}^\Sigma(M)(k)$  is the quotient of the sub-space of

$$\coprod_{T \in \mathbf{stree}_k} \prod_{v \in V^p(T)} M(|v|) \times \prod_{v \in V(T) \setminus V^p(T)} [O(|v|) \times [0, 1]] \quad (49)$$

determined by the restrictions on the families  $\{t_v\}$ . The equivalence relation is generated by the following conditions:

i) If a vertex is labelled by  $*_1 \in O(1)$ , then locally one has the identification

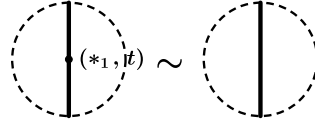

ii) If a vertex is indexed by  $a \cdot \sigma$ , with  $\sigma \in \Sigma$ , then

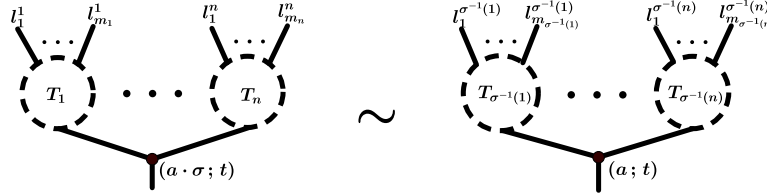

iii) If two consecutive vertices, connected by an edge  $e$ , are indexed by the same real number  $t \in [0, 1]$ , then  $e$  is contracted using the operadic structure of  $O$ . The vertex so obtained is indexed by the real number  $t$ .

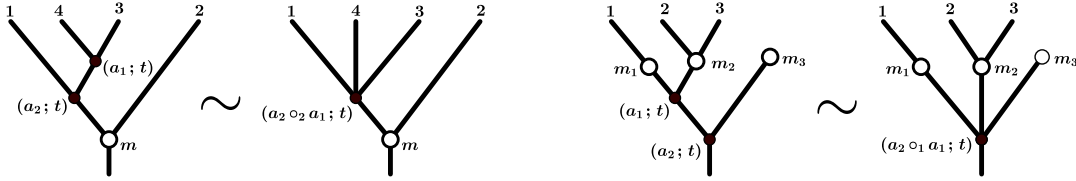

iv) If a vertex above the section is indexed by 0, then its output edge is contracted by using the right module structures. Similarly, if a vertex below the section is indexed by 0, then all its incoming edges are contracted by using the left module structure. In both cases the new vertex becomes a pearl.

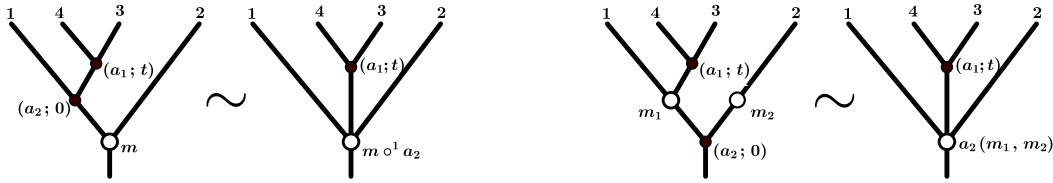

v) If a univalent pearl is indexed by a point of the form  $\gamma_0(x)$ , with  $x \in O(0)$ , then we contract its output edge by using the operadic structure of  $P$ . In particular, if all the pearls connected to a vertex  $v$  are univalent and of the form  $\gamma_0(x_v)$ , then the vertex is identified to the pearled corolla with no input.

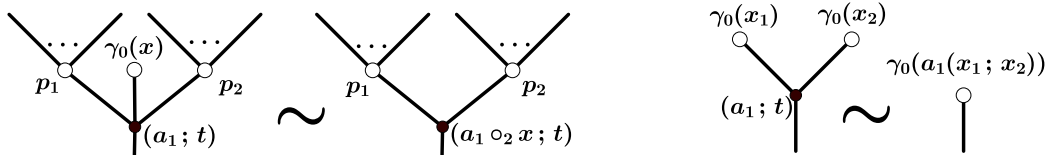

Let us describe the  $O$ -bimodule structure. Let  $a \in O(n)$  and  $[T; \{a_v\}; \{t_v\}]$  be a point in  $\mathcal{B}^\Sigma(M)(m)$ . The composition  $[T; \{a_v\}; \{t_v\}] \circ^i a$  consists in grafting the  $n$ -corolla labelled by  $a$  to the  $i$ -th incoming edge of  $T$  and indexing the new vertex by 1. Similarly, let  $[T^i; \{a_v^i\}; \{t_v^i\}]$  be a family of points in the spaces  $\mathcal{B}^\Sigma(M)(m_i)$ . The left module structure over  $O$  is defined as follows: each tree of the family is grafted to a leaf of the  $n$ -corolla labelled by  $a$  from left to right. The new vertex, coming from the  $n$ -corolla, is indexed by 1.

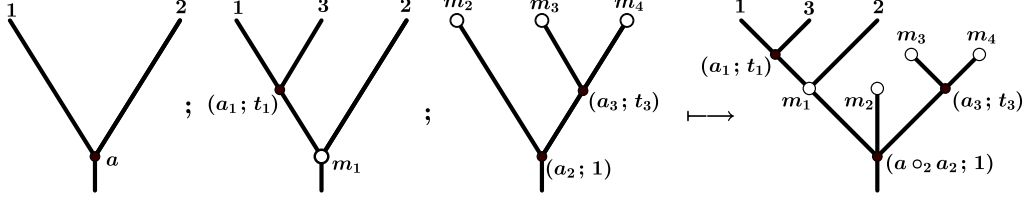

Figure 3: Illustration of the left module structure.

One has an obvious inclusion of  $\Sigma$ -sequences  $\iota: M \rightarrow \mathcal{B}^\Sigma(M)$ , where each element  $m \in M(k)$  is sent to a  $k$ -corolla labelled by  $m$ , whose only vertex is a pearl. Furthermore, the following map:

$$\mu: \mathcal{B}^\Sigma(M) \rightarrow M; [T; \{t_v\}; \{a_v\}] \mapsto [T; \{0_v\}; \{a_v\}], \quad (50)$$

is defined by sending the real numbers indexing the vertices other than the pearls to 0. The element so obtained is identified to the perled corolla labelled by a point in  $M$ . It is easy to see that  $\mu$  is an  $O$ -bimodule map.

**Remark 3.3.** Each component  $\mathcal{B}^\Sigma(M)(k)$  can also be defined as a coend over a category whose objects are trees slightly more general than those in  $\mathbf{stree}_k$ . Namely, one should also allow trees with univalent vertices below the section. The morphisms in this category are generated by section preserving isomorphisms of trees, additions of a bivalent vertex in the middle of any edge, edge contractions between two non-pearl vertices or between a vertex above the section and a pearl, and finally by contractions of all the edges in between a vertex (possibly of arity zero) below the section and pearls above it. In the latter case this vertex becomes a pearl. Compare with Remark 3.5.

In order to get resolutions for truncated bimodules, one considers a filtration in  $\mathcal{B}^\Sigma(M)$  according to the number of *geometrical inputs* which is the number of leaves plus the number of univalent vertices above the section. A point in  $\mathcal{B}^\Sigma(M)$  is said to be *prime* if the real numbers indexing the vertices are strictly smaller than 1. Otherwise, a point is said to be *composite*. Such a point can be decomposed into *prime components* as shown in Figure 4. More precisely, the prime components are obtained by removing the vertices indexed by the real number 1.

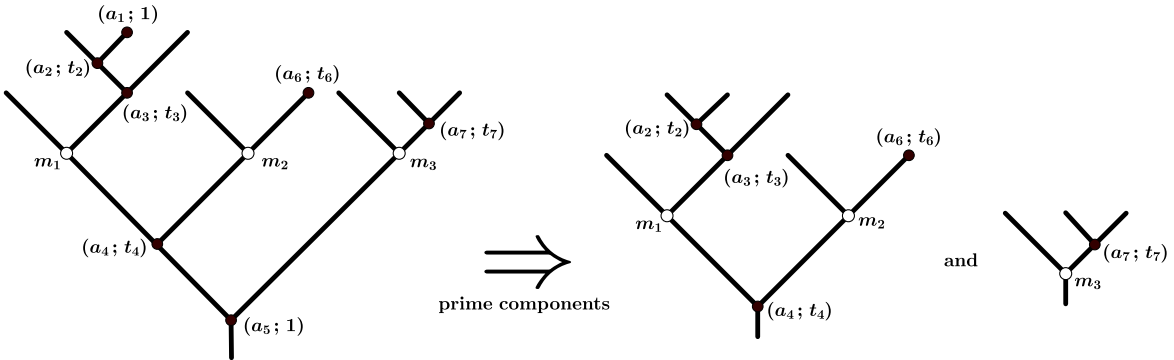

Figure 4: A composite point and its prime components.

A prime point is in the  $k$ -th filtration term  $\mathcal{B}_k^\Sigma(M)$  if the number of its geometrical inputs is at most  $k$ . Similarly, a composite point is in the  $k$ -th filtration term if its all prime components are in  $\mathcal{B}_k^\Sigma(M)$ . For instance, the composite point in Figure 4 is in the filtration term  $\mathcal{B}_6^\Sigma(M)$ . For each  $k$ ,  $\mathcal{B}_k^\Sigma(M)$  is a bimodule over  $O$  and one has the following filtration of  $\mathcal{B}^\Sigma(M)$ :

$$\mathcal{B}_0^\Sigma(M) \longrightarrow \mathcal{B}_1^\Sigma(M) \longrightarrow \cdots \longrightarrow \mathcal{B}_{k-1}^\Sigma(M) \longrightarrow \mathcal{B}_k^\Sigma(M) \longrightarrow \cdots \longrightarrow \mathcal{B}^\Sigma(M). \quad (51)$$

The term  $\mathcal{B}_0^\Sigma(M)$  is non-empty only in arity zero, where it is the pushout in the category of  $O$ -algebras of the free  $O$ -algebra generated by  $M(0)$  with  $O(0)$  along the free  $O$ -algebra generated by  $O(0)$ :

$$\mathcal{B}_0^\Sigma(M) = O(0) \coprod_{\mathcal{F}_B^\Sigma(O(0))} \mathcal{F}_B^\Sigma(M(0)).$$

**Theorem 3.4** (Theorem 2.12 in [Duc18]). *Assume that  $O$  is a well-pointed  $\Sigma$ -cofibrant topological operad, and  $M$  is a  $\Sigma$ -cofibrant  $O$ -bimodule for which the arity zero left action map  $\gamma_0: O(0) \rightarrow M(0)$  is a cofibration. Then, the objects  $\mathcal{B}^\Sigma(M)$  and  $T_k \mathcal{B}_k^\Sigma(M)$  are cofibrant replacements of  $M$  and  $T_k M$  in the categories  $\Sigma \text{Bimod}_O$  and  $T_k \Sigma \text{Bimod}_O$ , respectively. In particular the maps  $\mu$  and  $T_k \mu|_{T_k \mathcal{B}_k^\Sigma(M)}$  are weak equivalences.*

**Remark 3.5.** There is a slightly different construction of the Boardman-Vogt replacement for bimodules in which we allow univalent vertices below the section. Its advantage is that it works even when  $\gamma_0: O(0) \rightarrow M(0)$  is not a cofibration. The disadvantage is that this replacement combinatorially is much more complicated. For example, its filtration zero term  $\mathcal{B}_0^\Sigma(M)$  consists of trees with no vertices above the section. In the case  $M = O$  and  $O$  is doubly reduced to which we want to apply this construction, even to obtain  $\mathcal{B}_0^\Sigma(M)$ , we need an infinite sequence of cell attachments, see construction below, which makes it too clumsy to apply for the proof of our Main Theorem 2.

The idea of the proof of this theorem is that each map  $\mathcal{B}_{k-1}^\Sigma(M) \rightarrow \mathcal{B}_k^\Sigma(M)$ ,  $k \geq 0$  is a cofibration being obtained as a possibly infinite sequence of so called cell attachments – a procedure that we explain below. Here by  $\mathcal{B}_{-1}^\Sigma(M)$  we mean the free bimodule  $\mathcal{F}_B^\Sigma(\emptyset)$  generated by the empty sequence. It is  $O(0)$  in arity zero and empty otherwise.

The inclusion of  $O$  bimodules  $M \rightarrow M'$  is called a cell attachment if there is a cofibration of  $\Sigma$ -sequences  $\partial X \rightarrow X$  (in practice  $\partial X$  is also cofibrant) and a morphism of  $\Sigma$ -sequences  $\partial X \rightarrow M$  inducing an  $O$  bimodules map  $\mathcal{F}_B^\Sigma(\partial X) \rightarrow M$ , so that  $M'$  is obtained as the following pushout in the category of  $O$ -bimodules:

$$M' = M \coprod_{\mathcal{F}_B^\Sigma(\partial X)} \mathcal{F}_B^\Sigma(X).$$

We warn the reader that here and almost everywhere in the text  $\partial$  does not mean boundary in the usual sense, but just a subset. However, because of the notation, we call it *boundary* sometimes and the complement  $X \setminus \partial X$  is called *interior* of the cell  $X$ . The main reason for this notation is that because for the main example of the Fulton-MacPherson operad, in all the constructions, the corresponding subsets are expected to be actual boundaries of manifolds. It is not proved, but conjectured.

The prime elements in  $\mathcal{B}^\Sigma(M)$  span free cells that are attached in certain order. Note that the prime components for the  $k$ -th filtration term always have arity  $\leq k$ . This means that  $\mathcal{B}_k^\Sigma(M)$  is obtained by a sequence of “cell-attachments” where we always attach cells of arity  $\leq k$ . Consequently, one has the following equivalences:

$$T_k \text{Bimod}_O^h(T_k M; T_k M') \simeq T_k \text{Bimod}_O(T_k \mathcal{B}_k^\Sigma(M); T_k M') \cong \text{Bimod}_O(\mathcal{B}_k^\Sigma(M); M'), \quad (52)$$

where the last one is a homeomorphism.



**Example 3.6.** Let us describe a bit more explicitly the above cell attachments in the special case  $O(0) = O(1) = *$  and  $M = O$ . Since  $O(1) = *$ , thanks to relation (i), trees with bivalent non-pearl vertices do not appear. First we get in this case

$$\mathcal{B}_{-1}^{\Sigma}(O) = \mathcal{B}_0^{\Sigma}(O) = \mathcal{F}_B^{\Sigma}(\emptyset),$$

which means that there is no prime elements with zero geometrical inputs. To go from  $\mathcal{B}_0^{\Sigma}(O)$  to  $\mathcal{B}_1^{\Sigma}(O)$  we need to attach 2 cells, the first one corresponds to the pearled 1-corolla, attached in arity 1, and the second one corresponds to the tree , attached in arity zero. In general the cofibration  $\mathcal{B}_{k-1}^{\Sigma}(O) \rightarrow \mathcal{B}_k^{\Sigma}(O)$  is a composition of  $k+1$  cell attachments, where at the first step we attach a cell whose interior consists of prime elements labelled by trees of arity  $k$  with no univalent vertices, then we attach a cell whose interior consists of prime elements labelled by trees of arity  $k-1$  with exactly one univalent vertex, and so on, at the  $(i+1)$ -th step we attach a cell whose interior consists of prime elements labelled by trees of arity  $(k-i)$  with exactly  $i$  univalent vertices, etc. Note that each time the generating sequence is concentrated in one arity.

### 3.1.1 Boardman-Vogt resolution in the $\Lambda$ setting.

Now we adjust the above construction to produce Reedy cofibrant replacements of bimodules. We assume that our operad  $O$  and a bimodule  $M$  over it are reduced:  $O(0) = M(0) = *$ . As a  $\Sigma$ -sequence, we set

$$\mathcal{B}_O^{\Lambda}(M) := \mathcal{B}_{O_{>0}}^{\Sigma}(M_{>0})_+.$$

When  $O$  is understood, we also write  $\mathcal{B}^{\Lambda}(M)$ . The superscript  $\Lambda$  is to emphasize that we get a cofibrant replacement in the Reedy model structure. The map  $\mu: \mathcal{B}^{\Lambda}(M) \rightarrow M$  is extended to arity zero in the obvious way.

The arity zero left action  $\gamma_0: O(0) \rightarrow \mathcal{B}^{\Lambda}(M)(0)$  sends a point to a point  $*_0 \mapsto *_0^{\mathcal{B}}$ . The positive arity left action on positive arity components is defined in the same way as for  $\mathcal{B}_{O_{>0}}^{\Sigma}(M_{>0})$ . For the positive arity left action on the components of  $\mathcal{B}^{\Lambda}(M)$ , some of which are of arity zero, one uses the associativity of the left  $O$ -action to get

$$x(*_0^{\mathcal{B}}, y_1, \dots, y_{k-1}) = (x \circ_1 *_0)(y_1, \dots, y_{k-1}),$$

where  $x \in O(k)$ ,  $y_1, \dots, y_{k-1} \in \mathcal{B}^{\Lambda}(M)$ .

The right action by the positive arity components is defined as it is on  $\mathcal{B}_{O_{>0}}^{\Sigma}(M_{>0})$ . The right action by  $*_0 \in O(0)$  is defined in the obvious way as the right action by  $*_0$  on  $a$  in the vertex  $(a, t)$  connected to the leaf labelled by  $i$  as illustrated in the Figure 5.

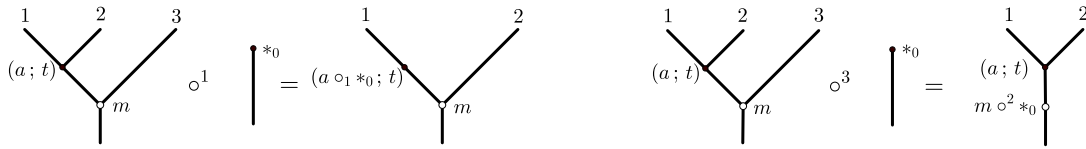

Figure 5: Illustration of the right action by  $*_0$ .

Note that since  $O_{>0}$  and  $M_{>0}$  have empty arity zero components, in the union (49) we can consider only trees whose all vertices have arity  $\geq 1$ . We denote this set by  $\mathbf{stree}_k^{\geq 1}$ . Moreover, if  $O$  is doubly reduced – the case that we mostly use for the proof of Main Theorem 2, we can in addition assume that all non-pearl vertices are of arity  $\geq 2$  (thanks to relation (i) of Construction 3.2). The corresponding set is denoted by  $\mathbf{stree}_k^{\geq 2}$ .

The filtration (51) in  $\mathcal{B}_{O_{>0}}^{\Sigma}(M_{>0})$  induces filtration

$$\mathcal{B}_0^{\Lambda}(M) \longrightarrow \mathcal{B}_1^{\Lambda}(M) \longrightarrow \dots \longrightarrow \mathcal{B}_{k-1}^{\Lambda}(M) \longrightarrow \mathcal{B}_k^{\Lambda}(M) \longrightarrow \dots \longrightarrow \mathcal{B}^{\Lambda}(M), \quad (53)$$

where  $\mathcal{B}_k^\Lambda(M)$  is the  $k$ -th filtration term of  $\mathcal{B}_{O_{>0}}^\Sigma(M_{>0})$  plus  $*_0^B$ . In particular, the zeroth term  $\mathcal{B}_0^\Lambda(M)$  has only a point in arity zero and is empty in all the other arities. Note also that when we go from  $(k-1)$ -th to  $k$ -th filtration term we only attach cells of arity exactly  $k$  as the number of geometrical inputs in prime components is equal to their arity by the lack of arity zero vertices. (In case  $O$  is doubly reduced there is exactly one cell attached at this step.) Such attachments affect only components of arity  $\geq k$ . As a consequence,  $T_k \mathcal{B}_k^\Lambda(M) = T_k \mathcal{B}^\Lambda(M)$ .

**Proposition 3.7.** *Assume that  $O$  is a reduced well-pointed  $\Sigma$ -cofibrant topological operad, and  $M$  is a reduced  $\Sigma$ -cofibrant  $O$ -bimodule. Then, the objects  $\mathcal{B}^\Lambda(M)$  and  $T_k \mathcal{B}^\Lambda(M)$  are cofibrant replacements of  $M$  and  $T_k M$  in the categories  $\Lambda \text{Bimod}_O$  and  $T_k \Lambda \text{Bimod}_O$ , respectively. In particular the maps  $\mu$  and  $T_k \mu$  are weak equivalences.*

*Proof.* Follows from Theorem 3.4 applied to  $O_{>0}$  and  $M_{>0}$  and Theorem 2.3 (ii).  $\square$

For  $M'$  reduced and Reedy fibrant  $O$ -bimodule, one similarly has

$$T_k \text{Bimod}_O^h(T_k M; T_k M') \simeq T_k \text{Bimod}_O(T_k \mathcal{B}^\Lambda(M); T_k M') \cong \text{Bimod}_O(\mathcal{B}_k^\Lambda(M); M'), \quad (54)$$

where again the last equivalence is a homeomorphism.

**Example 3.8.** In case  $O$  is doubly reduced, the only trees with section that contribute to  $\mathcal{B}^\Lambda(M)$  are those that have pearls of arity  $\geq 1$ , and all the other vertices of arity  $\geq 2$ . In particular, for  $k=1$  there is only one such tree  $\circ$ . And one has  $\mathcal{B}^\Lambda(M)(1) = M(1)$ . For  $k=2$ , here is the space of trees:

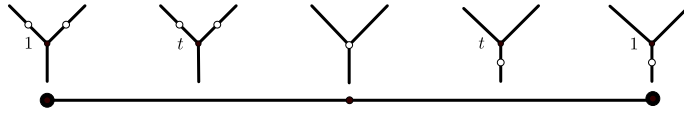

The corresponding space  $\mathcal{B}^\Lambda(M)(2)$  is the union of two mapping cylinders corresponding to the maps

$$\gamma_l: O(2) \times M(1) \times M(1) \rightarrow M(2), \quad \gamma_r: M(1) \times O(2) \rightarrow M(2),$$

which are glued together along the target space  $M(2)$ . For the case  $M = O$ , we get  $\mathcal{B}^\Lambda(O)(1) = *$ ,  $\mathcal{B}^\Lambda(O)(2) = O(2) \times [-1, 1]$  (as both maps above are essentially identity maps).

### 3.2 Boardman-Vogt resolution for infinitesimal bimodules

The constructions of the Boardman-Vogt resolutions for bimodules and infinitesimal bimodules are similar to each other. Consequently, we refer the reader to [Duc18, Section 2.3] for a proof of Theorem 3.12 (see also [BM06] for the operadic case and Appendix A.2 that gives a proof of a similar statement). First, we introduce the set of trees used to define the Boardman-Vogt resolution.

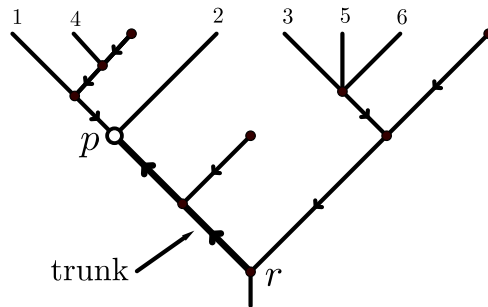

Figure 6: Example of a pearled tree with its orientation toward the pearl.

**Definition 3.9. The set of pearled trees**

Let  $\mathbf{ptree}_k$  be the set of pairs  $(T; p)$  where  $T \in \mathbf{tree}_k$  and  $p \in V(T)$  is a distinguished vertex called the *pearl*. The path between the root  $r$  and the pearl  $p$  will be called the trunk of  $(T; p)$ . Elements in  $\mathbf{ptree}_k$  are called *pearled trees*. Such a tree is endowed with another orientation toward the pearl. By abuse of notation, if  $e$  is an inner edge of a pearled tree, then  $s(e)$  and  $t(e)$  denote respectively the source and the target vertices according to the orientation toward the pearl. If there is no ambiguity about the pearl, we denote by  $T$  the pearled tree  $(T; p)$ .

**Construction 3.10.** From an  $O$ -Ibimodule  $M$ , we build an  $O$ -Ibimodule  $\mathcal{I}b^\Sigma_O(M)$ . When  $O$  is understood we also write  $\mathcal{I}b^\Sigma(M)$ . The points of  $\mathcal{I}b^\Sigma(M)(k)$  are equivalence classes  $[T; \{t_v\}; \{a_v\}]$  with  $T \in \mathbf{ptree}_k$  and  $\{a_v\}_{v \in V(T)}$  is a family of points labelling the vertices of  $T$ . The pearl is labelled by a point in  $M$  whereas the other vertices are labelled by points in the operad  $O$  always assuming that the arity is respected. Furthermore,  $\{t_v\}_{v \in V(T) \setminus \{p\}}$  is a family of real numbers in the interval  $[0, 1]$  indexing the vertices other than the pearl. If  $e$  is an inner edge, then  $t_{s(e)} \geq t_{t(e)}$  according to the orientation toward the pearl. In other words, closer to the pearl is a vertex, smaller is the corresponding real number. The space  $\mathcal{I}b^\Sigma(M)(k)$  is the quotient of the sub-space of

$$\coprod_{T \in \mathbf{ptree}_k} M(|p|) \times \prod_{v \in V(T) \setminus \{p\}} [O(|v|) \times [0, 1]]$$

determined by the restrictions on the families of real numbers  $\{t_v\}$ . The equivalence relation is generated by the axioms (i) and (ii) of Construction 3.2 and also the following conditions:

iii) If two consecutive vertices, connected by an edge  $e$ , are indexed by the same real number  $t \in [0, 1]$ , then  $e$  is contracted by using the operadic structure. The vertex so obtained is indexed by the real number  $t$ .

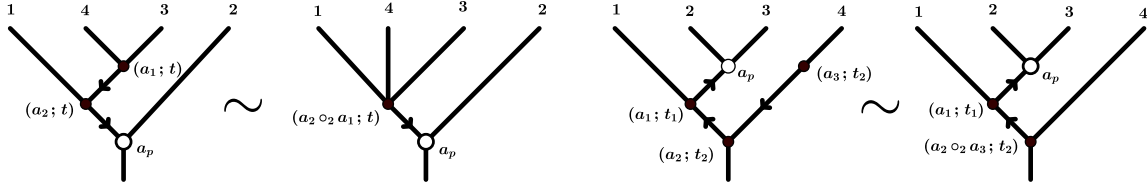

Figure 7: Illustration of the relation (iii).

iv) If a vertex is indexed by 0, then its output edge (according to the orientation toward the pearl) is contracted by using the infinitesimal bimodule structure. The obtained vertex becomes a pearl.

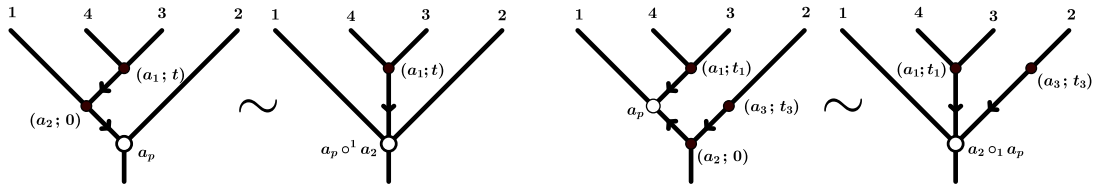

Figure 8: Examples of the relation (iv).

Let us describe the  $O$ -Ibimodule structure. Let  $a \in O(n)$  and  $[T; \{a_v\}; \{t_v\}]$  be a point in  $\mathcal{I}b^\Sigma(M)(m)$ . The composition  $[T; \{a_v\}; \{t_v\}] \circ^i a$  consists in grafting the  $n$ -corolla labelled by  $a$  to the  $i$ -th incoming edge of  $T$  and indexing the new vertex by 1. Similarly, the composition  $a \circ_i [T; \{a_v\}; \{t_v\}]$  consists in grafting the pearled tree  $T$  to the  $i$ -th incoming edge of the  $n$ -corolla labelled by  $a$  and indexing the new vertex by 1.

One has an obvious inclusion of  $\Sigma$ -sequences  $\iota': M \rightarrow \mathcal{I}b^\Sigma(M)$  sending an element  $m \in M(k)$  to the pearled  $k$ -corolla labelled by  $m$ . One also has a map

$$\mu' : \mathcal{I}b^\Sigma(M) \rightarrow M ; [T ; \{t_v\} ; \{a_v\}] \mapsto [T ; \{0_v\} ; \{a_v\}], \quad (55)$$

defined by sending the real numbers indexing the vertices other than the pearl to 0. The element so obtained is identified to the pearled corolla labelled by a point in  $M$ . By construction,  $\mu'$  is an  $O$ -Ibimodule map.

**Remark 3.11.** Each component  $\mathcal{I}b^\Sigma(M)(k)$  can also be defined as a coend over a category whose objects set is  $\mathbf{ptree}_k$ . The morphisms in this category are generated by pearl preserving isomorphisms of trees, additions of a bivalent vertex in the middle of any edge, and edge contractions.

In order to get resolutions for truncated infinitesimal bimodules, one considers a filtration in  $\mathcal{I}b^\Sigma(M)$  according to the number of geometrical inputs, which is the number of leaves plus the number of univalent vertices other than the pearl. A point in  $\mathcal{I}b^\Sigma(M)$  is said to be prime if the real numbers labelling its vertices are strictly smaller than 1. Besides, a point is said to be composite if one of its vertex is labelled by 1. Such a point can be associated to a prime component. More precisely, the prime component of a composite point is obtained by removing all the vertices indexed by 1 as illustrated in Figure 9.

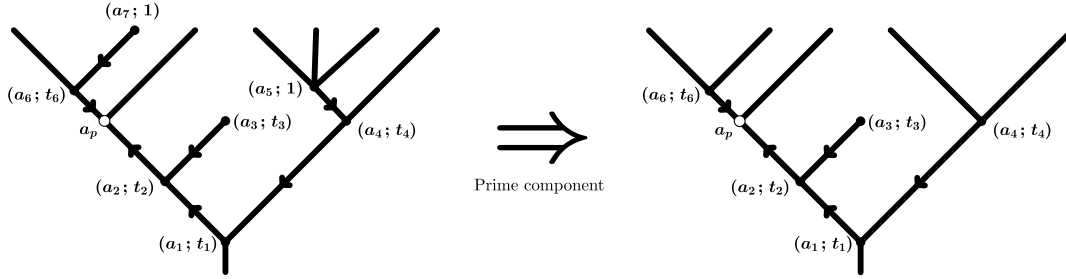

Figure 9: Illustration of a composite point in  $\mathcal{I}b^\Sigma(M)$  together with its prime component.

A prime point is in the  $k$ -th filtration term  $\mathcal{I}b_k^\Sigma(M)$  if the number of its geometrical inputs is smaller than  $k$ . Similarly, a composite point is in the  $k$ -th filtration term if its prime component is in the  $k$ -th filtration term. For each  $k \geq 0$ ,  $\mathcal{I}b_k^\Sigma(M)$  is an  $O$ -Ibimodule and they define a filtration in  $\mathcal{I}b^\Sigma(M)$ :

$$\mathcal{I}b_0^\Sigma(M) \longrightarrow \mathcal{I}b_1^\Sigma(M) \longrightarrow \dots \longrightarrow \mathcal{I}b_{k-1}^\Sigma(M) \longrightarrow \mathcal{I}b_k^\Sigma(M) \longrightarrow \dots \longrightarrow \mathcal{I}b^\Sigma(M). \quad (56)$$

**Theorem 3.12.** *Let  $O$  be a well-pointed operad and  $M$  be an  $O$ -Ibimodule. If  $O$  and  $M$  are  $\Sigma$ -cofibrant, then  $\mathcal{I}b^\Sigma(M)$  and  $\mathbb{T}_k \mathcal{I}b_k^\Sigma(M)$  are cofibrant replacements of  $M$  and  $\mathbb{T}_k M$  in the categories  $\Sigma \mathbf{Ibimod}_O$  and  $\mathbb{T}_k \Sigma \mathbf{Ibimod}_O$ , respectively. In particular the maps  $\mu'$  and  $\mathbb{T}_k \mu' |_{\mathbb{T}_k \mathcal{I}b_k^\Sigma(M)}$  are weak equivalences.*

*Proof.* The proof is similar to that of [Duc18, Theorem 2.10] for bimodules (see also [BM06] for operads). The main idea is that  $\mathcal{I}b_0^\Sigma(M)$  is cofibrant and every inclusion  $\mathcal{I}b_{k-1}^\Sigma(M) \rightarrow \mathcal{I}b_k^\Sigma(M)$  is a cofibration obtained as a sequence of cell attachments. To see that, one notices first that  $\mathcal{I}b_0^\Sigma(M) = \mathcal{F}_{1b}^\Sigma(M(0))$ , where abusing

notation  $M(0)$  denotes the sequence 
$$\begin{cases} M(0), & k = 0; \\ \emptyset, & k \geq 1. \end{cases}$$

Here we mean again that an  $O$ -Ibimodule  $N'$  is obtained from  $N$  by a *cell attachment* if  $N'$  is obtained from  $N$  by a pushout in  $O$ -Ibimodules:

$$N' = N \coprod_{\mathcal{F}_{1b}^\Sigma(\partial X)} \mathcal{F}_{1b}^\Sigma(X),$$

where  $\partial X \rightarrow X$  is again a cofibration of  $\Sigma$ -sequences and the map  $\mathcal{F}_{1b}^\Sigma(\partial X) \rightarrow N$  is induced by a map  $\partial X \rightarrow N$  of  $\Sigma$ -sequences.  $\square$

**Example 3.13.** In case  $O$  is doubly reduced  $O(0) = O(1) = *$ , the cofibration  $\mathcal{I}b_{k-1}^\Sigma(M) \rightarrow \mathcal{I}b_k^\Sigma(M)$  is a sequence of  $k+1$  cell attachments similarly to the case of bimodules, see Example 3.6. At the first step one attaches a cell whose interior consists of prime elements of arity  $k$  with no univalent non-pearl vertices; at the second step one attaches a cell whose interior consists of prime elements of arity  $k-1$  having exactly one univalent non-pearl; so on; at the  $(i+1)$ -th step one attaches a cell of prime elements of arity  $k-j$  with  $j$  univalent non-pearl vertices.

Similarly to the case of bimodules, one has the following equivalences of mapping spaces

$$\mathrm{T}_k \mathrm{Ibimod}_O^h(\mathrm{T}_k M; \mathrm{T}_k M') \simeq \mathrm{T}_k \mathrm{Ibimod}_O(\mathrm{T}_k \mathcal{I}b_k^\Sigma(M); \mathrm{T}_k M') \cong \mathrm{Ibimod}_O(\mathcal{I}b_k^\Sigma(M); M'). \quad (57)$$

The last equivalence, which is a homeomorphism, follows from the fact that  $\mathcal{I}b_k^\Sigma(M)$  is obtained by attaching cells only of arity  $\leq k$ .

### 3.2.1 Boardman-Vogt resolution in the $\Lambda$ setting.

Now we assume that our operad  $O$  is reduced and we adapt the above construction to produce Reedy cofibrant replacements of  $O$ -Ibimodules. As a  $\Sigma$ -sequence, we set

$$\mathcal{I}b_O^\Lambda(M) := \mathcal{I}b_{O_{>0}}^\Sigma(M).$$

When  $O$  is understood, we also write  $\mathcal{I}b^\Lambda(M)$ .

The sequence  $\mathcal{I}b^\Lambda(M)$  is an  $O_{>0}$ -Ibimodule by construction. It is also an infinitesimal bimodule over  $O$  in which the composition with the one point topological space  $O(0)$  is defined as follows:

$$\begin{aligned} \circ^i : \mathcal{I}b_{>0}^\Sigma(M)(n) \times O(0) &\longrightarrow \mathcal{I}b_{>0}^\Sigma(M)(n-1); \\ [T; \{t_v\}; \{a_v\}]; *_0 &\longmapsto [T; \{t_v\}; \{a'_v\}], \end{aligned}$$

where the family  $\{a'_v\}$  is given by

$$a'_v := \begin{cases} a_v \circ^j *_0 & \text{if the } i\text{-th leaf of } T \text{ corresponds to the } j\text{-th incoming edge of } v = p, \\ a_v \circ_j *_0 & \text{if the } i\text{-th leaf of } T \text{ corresponds to the } j\text{-th incoming edge of } v \neq p, \\ a_v & \text{otherwise.} \end{cases}$$

One can easily see that the  $O_{>0}$ -Ibimodule map (55) induces a map

$$\mu' : \mathcal{I}b^\Lambda(M) \rightarrow M, \quad (58)$$

which respects the  $\Lambda$  action and thus is an  $O$ -Ibimodules map.

We define a filtration in  $\mathcal{I}b^\Lambda(M)$  exactly as the one on  $\mathcal{I}b_{O_{>0}}^\Sigma(M)$ , see (56):

$$\mathcal{I}b_0^\Lambda(M) \longrightarrow \mathcal{I}b_1^\Lambda(M) \longrightarrow \dots \longrightarrow \mathcal{I}b_{k-1}^\Lambda(M) \longrightarrow \mathcal{I}b_k^\Lambda(M) \longrightarrow \dots \longrightarrow \mathcal{I}b^\Lambda(M). \quad (59)$$

It is easy to see that the right action by  $O(0)$  defined above preserves this filtration, because when acting on the prime components it only decreases their arity. As a consequence it is a filtration of  $O$ -Ibimodules. Note that when we pass from  $\mathcal{I}b_{k-1}^\Lambda(M)$  to  $\mathcal{I}b_k^\Lambda(M)$  we only attach celled of arity exactly  $k$ , as the number of geometrical inputs for the prime component is exactly the arity by the lack of the arity zero non-pearl vertices. (In case  $O$  is doubly reduced, there is exactly one cell attached at this step.) As a consequences  $\mathrm{T}_k \mathcal{I}b_k^\Lambda(M) = \mathrm{T}_k \mathcal{I}b^\Lambda(M)$ .

**Proposition 3.14.** *Assume that  $O$  is a reduced  $\Sigma$ -cofibrant topological operad, and  $M$  is a  $\Sigma$ -cofibrant  $O$ -Ibimodule. Then, the objects  $\mathcal{I}b^\Lambda(M)$  and  $\mathrm{T}_k \mathcal{I}b^\Lambda(M)$  are cofibrant replacements of  $M$  and  $\mathrm{T}_k M$  in the categories  $\Lambda \mathrm{Ibimod}_O$  and  $\mathrm{T}_k \Lambda \mathrm{Ibimod}_O$ , respectively. In particular the maps  $\mu'$  and  $\mathrm{T}_k \mu'$  are weak equivalences.*

*Proof.* Follows from Theorem 2.6 (ii) and Theorem 3.12 applied to the operad  $O_{>0}$ . □

Assuming that  $M'$  is a Reedy fibrant  $O$ -Ibimodule, we get:

$$\mathrm{T}_k \mathrm{Ibimod}_O^h(\mathrm{T}_k M; \mathrm{T}_k M') \simeq \mathrm{T}_k \mathrm{Ibimod}_O(\mathrm{T}_k \mathcal{I}b^\wedge(M); \mathrm{T}_k M') \cong \mathrm{Ibimod}_O(\mathcal{I}b_k^\wedge(M); M'). \quad (60)$$

The last equivalence, which is a homeomorphism, follows from the fact that  $\mathcal{I}b_k^\wedge(M)$  as an  $O_{>0}$ -Ibimodule is obtained by attaching cells only of arity  $\leq k$ .

**Example 3.15.** Assuming that  $O$  is doubly reduced  $O(0) = O(1) = *$ , one has  $\mathcal{I}b^\wedge(O)(0) = * = \mathring{\uparrow}$ . As illustrated in Figure 10, each point in the space  $\mathcal{I}b^\wedge(O)(1)$  has a representative element of the form  $[T; \{t_v\}; \{a_v\}]$  in which  $T$  is a pearled tree having two vertices such that the pearl is univalent and connected to the first incoming edge of the root. In other words, a point is determined by a pair  $(\theta; t)$ , with  $\theta \in O(2)$  and  $t \in [0, 1]$ , satisfying the relation  $(\theta_1; 0) \sim (\theta_2; 0)$  due to the axiom (iv) of Construction 3.10 and the condition  $O(1) = *$ , see Figure 10. As a consequence,  $\mathcal{I}b^\wedge(O)(1)$  is homeomorphic to the cone of the space  $O(2)$ , denoted  $C(O(2))$ .

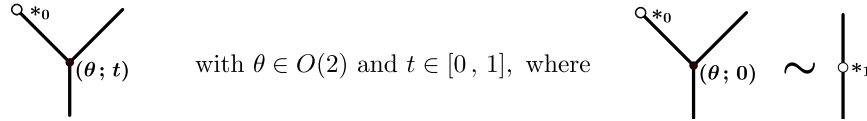
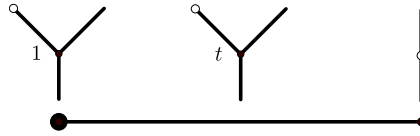
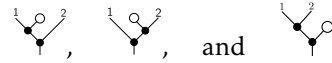

Figure 10: Illustration of points in  $\mathcal{I}b^\wedge(O)(1)$ .

**Example 3.16.** Let again  $O$  be doubly reduced. To visualize better the spaces  $\mathcal{I}b^\wedge(M)(k)$ , it helps to look at the space of non-planar pearled trees with  $k$  labelled leaves, whose non-pearls have arity  $\geq 2$  (the pearl can be of any arity) and are labelled by numbers in  $[0, 1]$  respecting the inequalities  $t_{s(e)} \geq t_{t(e)}$  from Construction 3.10. For example, for  $k = 0$ , it is just one point  $* = \mathring{\uparrow}$ . For  $k = 1$ , it is the closed interval:



For  $k = 2$ , it is a union of 3 triangles corresponding to the trees



and , as illustrated in Figure 11.

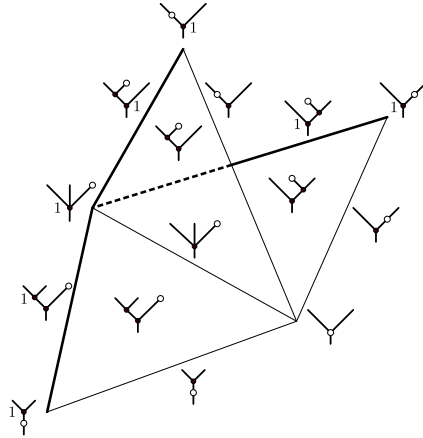

Figure 11: Visualizing the space of trees associated to  $\mathcal{I}b^\wedge(M)(2)$ . The left leaf in each tree is labelled by 1, and the right one by 2.



To each cell of this complex corresponding to a pearled tree  $T$ , one can assign the space of possible labelling of the vertices of  $T$  by  $M$  and  $O$  as in Construction 3.10. This assignment is a cellular cosheaf, and the realization of this cosheaf is exactly the space  $\mathcal{I}b^\Lambda(M)(k)$ , see Appendix A.3. Note that the part corresponding to the lower filtration term  $\partial\mathcal{I}b^\Lambda(M)(k) := \mathcal{I}b_{k-1}^\Lambda(M)(k)$  is the union of the trees having at least one point labelled by 1. For  $k = 1$ , it is the part corresponding to the left point of the interval. For  $k = 2$ , it is the union of the left edges of the triangles that are drawn by fat lines.

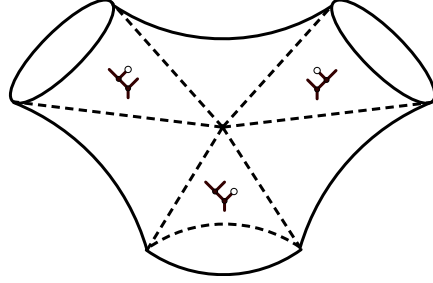
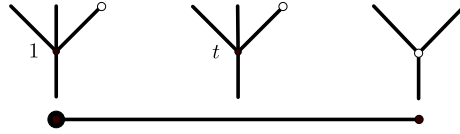

Figure 12: The fiber of the map  $\mathcal{I}b^\Lambda(\mathcal{F}_m)(2) \rightarrow \mathcal{F}_m(2)$ .

**Example 3.17.** As illustration to the two previous examples above, for the Fulton-MacPherson operad  $O = M = \mathcal{F}_m$ , one has  $\mathcal{I}b^\Lambda(\mathcal{F}_m)(0) = *$ ,  $\mathcal{I}b^\Lambda(\mathcal{F}_m)(1) = C(\mathcal{F}_m(2)) = C(S^{m-1}) = D^m$ . To describe  $\mathcal{I}b^\Lambda(\mathcal{F}_m)(2)$ , consider the projection  $\mu': \mathcal{I}b^\Lambda(\mathcal{F}_m)(2) \rightarrow \mathcal{F}_m(2) = S^{m-1}$ . One can easily see that it is a fibration, whose fiber is an  $(m+1)$ -disc split into the union of three cones of  $D^m$  and a cone of  $S^m$  with three holes, see Figure 12. The three cones of  $D^m$  correspond to the three triangles in Figure 11. Left sides of the triangles correspond to the bases of the cones. The shared side for each triangle corresponds to the side face. And the right sides correspond to the axes of the cones. The complement to these 3 cones is the part of  $\mathcal{I}b^\Lambda(\mathcal{F}_m)(2)$  corresponding to the segment



Note that any preimage of the map  $\mathcal{F}_m(3) \rightarrow \mathcal{F}_m(2)$ ,  $x \mapsto x \circ_3 *_0$ , that forgets the last point is an  $m$ -disc with two disc-shaped holes. The boundary of the first hole corresponds to the limit configurations when point 3 collides with 1; the boundary of the second hole corresponds to the case when 3 collides with 2; and the outer boundary corresponds to the case when 3 escapes to infinity, or, equivalently, 1 and 2 collide. It is easy to see that the part of this  $(m+1)$ -disc lying in  $\partial\mathcal{I}b^\Lambda(\mathcal{F}_m)(2)$  is exactly its boundary. As a fibration over  $S^{m-1}$ , the lower cone, that corresponds to the lower triangle in Figure 11, does not move, while the two other cones rotate one around the other.

## 4 Coherence

In the first subsection we give definition of coherence in terms of homotopy colimit and in the second subsection we explain what this definition implies on the level of the Boardman-Vogt resolution.

### 4.1 Definition of coherence and strong coherence

In this subsection we explain the property of being *coherent* for an operad used in Main Theorem 2. We also define a slightly stronger, but easier to check property of *strong coherence*.

**Notation 4.1.** For a category  $C$ , its full subcategory of non-terminal objects is denoted by  $\partial C$ .

**Definition 4.2.** (i) For any  $k \geq 0$ , the category  $\Psi_k$  is defined to have as objects non-planar pearled trees with  $k$  leaves labelled bijectively by the set  $\underline{k}$ , whose pearl can have any arity  $\geq 0$ , and the other vertices are of arity  $\geq 2$ . The morphisms in  $\Psi_k$  are inner edge contractions.

(ii) For each  $\Psi_k$ , we denote by  $c_k$  its terminal object – the pearled  $k$ -corolla, and by  $c'_k$ ,  $k \geq 2$ , the tree with 2 vertices: a pearled root of arity one, whose only outgoing edge is attached to the other vertex of arity  $k$ .

(iii) We denote by  $\Psi'_k$ ,  $k \geq 2$ , the subcategory of  $\Psi_k$  of all morphisms except the morphism  $c'_k \rightarrow c_k$ .

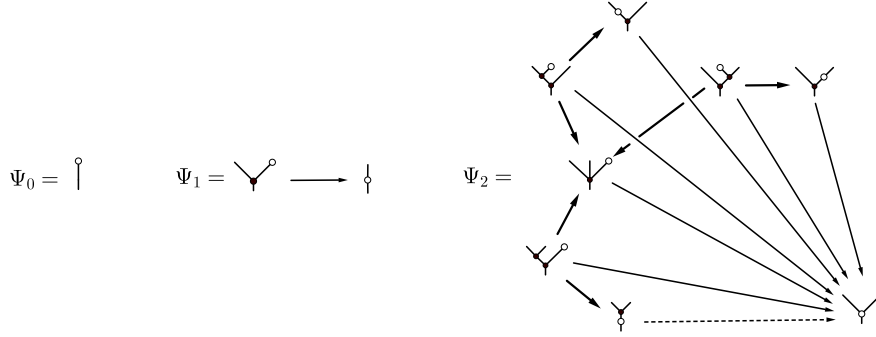

Figure 13: Categories  $\Psi_0$ ,  $\Psi_1$ ,  $\Psi_2$ . Morphism  $c'_2 \rightarrow c_2$  is shown by a dotted arrow. We do not put labels on the leaves: for  $\Psi_0$ , its only graph has no leaves; for  $\Psi_1$ , trees have only one leaf that must be labelled by 1; for  $\Psi_2$ , the left leaf in each tree is labelled by 1 and the right one by 2.

**Definition 4.3.** For a topological operad  $O$ , an  $O$ -bimodule  $M$ , and  $k \geq 0$ , define a  $\Psi_k$  shaped diagram

$$\begin{aligned} \rho_k^M: \Psi_k &\longrightarrow \text{Top}; \\ T &\longmapsto M(|p|) \times \prod_{v \in V(T) \setminus \{p\}} O(|v|). \end{aligned}$$

On morphisms it is defined by choosing a planar representative of each pearled tree, and then using the operadic composition and  $O$ -action on  $M$  for each edge contraction. The choice of planar representatives does not matter in the sense that the obtained diagrams are objectwise homeomorphic.

**Definition 4.4.** (i) A diagram  $\rho: \Psi_k \rightarrow \text{Top}$ ,  $k \geq 2$ , is called *coherent*, if the natural map

$$\text{hocolim}_{\partial \Psi_k} \rho \longrightarrow \text{hocolim}_{\Psi'_k} \rho \tag{61}$$

is a weak equivalence.

(ii) A topological operad  $O$  is called *coherent*, respectively, *k-coherent*, if the diagrams  $\rho_i^O$  are coherent for all  $i \geq 2$ , respectively, for all  $i$  in the range  $2 \leq i \leq k$ .

Note that by definition any weakly doubly reduced operad is 1-coherent. In the next section we show that for a strictly doubly reduced operad  $O$ , and its any infinitesimal bimodule  $M$ , one has two homeomorphisms

$$\mathcal{I}b^\wedge(M)(k) \cong \text{hocolim}_{\Psi_k} \rho_k^M \quad \text{and} \quad \partial \mathcal{I}b^\wedge(M)(k) = \mathcal{I}b_{k-1}^\wedge(M)(k) \cong \text{hocolim}_{\partial \Psi_k} \rho_k^M.$$

Thus, informally speaking, an operad is coherent if making some small hole in the interior of  $\mathcal{I}b^\wedge(O)(k)$ , for any  $k \geq 2$ , makes it weakly collapsible to the boundary  $\partial \mathcal{I}b^\wedge(O)(k)$ .

**Definition 4.5.** For a pearled tree  $T$ , the *arity of its trunk* is the arity of the pearl  $p'$  in the tree  $T'$  obtained from  $T$  by contracting all edges of its trunk to one vertex  $p'$ .

For example the arity of the trunk for the pearled tree from Figure 6 is four.

**Definition 4.6.** For  $k \geq 2$ , define:

(i)  $\Psi_k^U$  as a full subcategory of  $\Psi_k$  of objects that have no morphism to  $c'_k$ . It consists of trees whose trunk has arity  $\geq 2$ .

(ii)  $\Psi_k^L$  as a full subcategory of  $\Psi_k$  whose elements can be reached (by a morphism) from objects that have a morphism to  $c'_k$ . It consists of trees either with a pearled root, or with a univalent pearl and a trunk that has only two vertices.

(iii)  $\Psi_k^{UL} := \Psi_k^U \cap \Psi_k^L$ . Explicitly, its objects have either a pearled root of arity  $\geq 2$ , or a trunk with two vertices: a univalent pearl and a root of arity  $\geq 3$ .

The letter  $U$  stays for *upper*, and the letter  $L$  stays for *lower*. We think about  $\Psi_k^U$  and  $\Psi_k^L$  as respectively, upper and lower parts of the category  $\Psi_k$ . For instance, in Figure 13,  $\Psi_2^U$  is the union of two upper squares,  $\Psi_2^L$  is the lower square while  $\Psi_2^{UL}$  is the central edge: it has only two objects and a morphism between them.

**Definition 4.7.** (i) A diagram  $\rho: \Psi_k \rightarrow \text{Top}$  is called *strongly coherent* if the natural map

$$\text{hocolim}_{\partial\Psi_k^U} \rho \longrightarrow \rho(c_k) \quad (62)$$

is a weak equivalence.

(ii) A topological operad  $O$  is called *strongly coherent*, respectively, *strongly  $k$ -coherent*, if the diagrams  $\rho_i^O$  are strongly coherent for all  $i \geq 2$ , respectively, for all  $i$  in the range  $2 \leq i \leq k$ .

**Lemma 4.8.** *The properties of an operad to be coherent,  $k$ -coherent, strongly coherent, strongly  $k$ -coherent are preserved by weak equivalences.*

*Proof.* A weak equivalence  $O \rightarrow O'$  induces a weak equivalence of diagrams  $\rho_k^O \rightarrow \rho_k^{O'}$ , which induces equivalences of homotopy colimits.  $\square$

**Theorem 4.9.** (i) *If a diagram  $\rho: \Psi_k \rightarrow \text{Top}$ ,  $k \geq 2$ , is strongly coherent, then it is coherent.*

(ii) *If an operad is strongly coherent, respectively, strongly  $k$ -coherent, then it is coherent, respectively,  $k$ -coherent.*

Obviously, (ii) follows from (i), so we need to show only (i). The part (i) is a consequence of the following proposition.

To recall, for a diagram  $F: C \rightarrow \text{Top}$ , its homotopy colimit is  $\text{hocolim}_C F := |(- \downarrow C)| \otimes_C F(-)$ .

**Proposition 4.10.** *For any  $\rho: \Psi_k \rightarrow \text{Top}$ ,  $k \geq 2$ , one has*

(i) *the natural inclusion*

$$\text{hocolim}_{\partial\Psi_k^U} \rho \coprod_{\text{hocolim}_{\partial\Psi_k^{UL}} \rho} \text{hocolim}_{\partial\Psi_k^L} \rho \xrightarrow{\cong} \text{hocolim}_{\partial\Psi_k} \rho \quad (63)$$

*is a homeomorphism;*

(ii) *the natural inclusion*

$$\text{hocolim}_{\Psi_k^U} \rho \coprod_{\text{hocolim}_{\partial\Psi_k^{UL}} \rho} \text{hocolim}_{\partial\Psi_k^L} \rho \xrightarrow{\cong} \text{hocolim}_{\Psi_k} \rho \quad (64)$$

*is a homotopy equivalence.*

Indeed, this shows that both sides of (61) are described as a union of an upper and a lower parts. By proposition above, their lower parts are always equivalent, while the equivalence of upper parts is exactly the property of being strongly coherent (as the terminal object of  $\Psi_k^U$  is  $c_k$ , one gets  $\text{hocolim}_{\Psi_k^U} \rho \simeq \rho(c_k)$ ).

*Proof of Proposition 4.10.* (i) follows from the fact that  $\partial\Psi_k$  is a union of  $\partial\Psi_k^U$  and  $\partial\Psi_k^L$ , and there is no morphism from the objects of their intersection  $\partial\Psi_k^{UL}$  outside this subcategory.

To prove (ii) we construct a deformation retraction of the target in (64) onto its source. Figure 14 is an example how the deformation retraction looks like in case  $k = 2$ . For this purpose, we introduce the following notation:

- ▶ A *cubical category*  $C_i, i \geq 0$ , is the  $i$ -th power of the category  $\{0 \rightarrow 1\}$  with 2 objects and 1 morphism between them.
- ▶ A *subcubical category* is  $\partial C_i, i \geq 0$ , see Notation 4.1.
- ▶ An *almost cubical category* is the category  $C'_i, i \geq 1$ , obtained from  $C_i$  by removing only one morphism  $\tau' \rightarrow \tau$  to its terminal object. The objects  $\tau$  and  $\tau'$  are called *almost terminal* and *subterminal* objects of  $C'_i$ , respectively.

Note that  $\tau' \rightarrow \tau$  must be indecomposable, meaning that all coordinates of  $\tau'$  except exactly one are 1s.

Cubical and subcubical categories are well-known objects. The realization  $|C_i|$  is the  $i$ -dimensional cube, and  $|\partial C_i|$  is the barycentric subdivision of an  $(i - 1)$ -simplex.

Let us describe  $|C'_i|$ . We call *front face* the  $(i - 1)$ -subcube of  $|C_i|$ , whose terminal object is  $\tau'$ . The parallel to it  $(i - 1)$ -subcube containing  $\tau$  gets called *back face*. One can easily see that  $|C'_i|$  is the cube  $|C_i|$  minus the interior of the pyramid  $P$  with apex  $\tau$  and base the front face, and minus the interiors of all faces of  $P$  that contain the edge  $(\tau', \tau)$ .

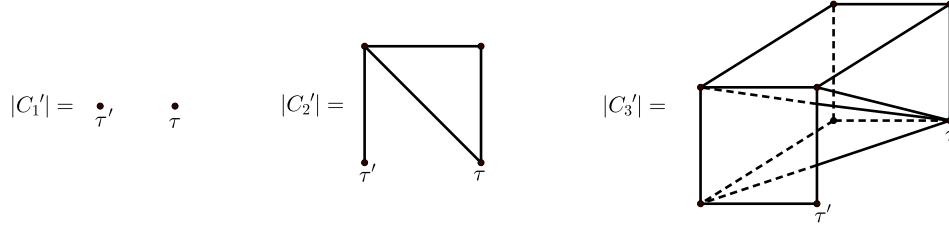

Define projection  $p: |C'_i| \rightarrow |C'_i|$  as the identity map on the front face and as the stereographic projection from  $\tau'$  to the union of faces in the boundary of the cube  $|C_i|$  that do not contain  $\tau'$ . One can easily see that the homotopy

$$H(t) = (1 - t) \cdot id + t \cdot p \tag{65}$$

defines a deformation retraction from  $|C'_i|$  onto the union of  $|\partial C_i|$  and the back face.

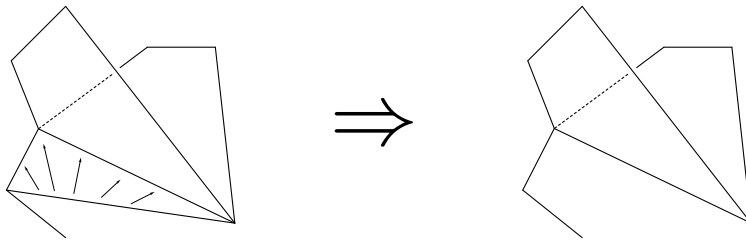

Figure 14: Deformation retraction of  $\text{hocolim}_{\partial\Psi'_2} \rho$  onto  $\text{hocolim}_{\Psi'_2} \rho \coprod_{\text{hocolim}_{\partial\Psi'_2} \rho} \text{hocolim}_{\partial\Psi'_2} \rho$ .

Now we apply this construction to prove our proposition. We will define a deformation retraction  $H$  from  $|\Psi'_k|$  onto  $|\Psi_k^U| \coprod_{|\partial\Psi_k^{UL}|} |\partial\Psi_k^L|$ . The reader can easily see that our retraction can be extended to homotopy

colimits. For any tree  $T \in \Psi_k$ , the category  $(T \downarrow \Psi_k) \subset \Psi_k$  is cubical with initial object  $T$ , terminal object  $c_k$ , and the dimension of the cube being the number of internal edges of  $T$ . If there is no map  $T \rightarrow c'_k$ , i.e.  $T \in \Psi_k^U$ , then  $T \downarrow \Psi'_k$  is the same cube lying entirely in  $\Psi_k^U$ , and we define  $H$  as the constant identity on  $|T \downarrow \Psi'_k| \subset |\Psi'_k|$ . If there is a map  $T \rightarrow c'_k$ , then  $T \downarrow \Psi'_k$  is almost cubical, whose almost terminal object is  $c_k$  and subterminal object is  $c'_k$ . Note that  $|T \downarrow \Psi'_k| \cap |\Psi_k^U|$  is its back face and  $|T \downarrow \Psi'_k| \cap |\partial \Psi_k^L|$  is its subcubical part. Define  $H$  on  $|T \downarrow \Psi'_k| \subset |\Psi'_k|$  by formula (65). One has  $|\Psi'_k| = \bigcup_{T \in \Psi_k} |T \downarrow \Psi'_k|$ . It is easy to see that  $H$  is compatibly defined on all such pieces of  $|\Psi'_k|$  and produces the required deformation retraction.  $\square$

**Remark 4.11.** (i) Being coherent does not imply being strongly coherent. Two non-equivalent spaces might become weakly equivalent after attaching the same space. For example, let  $T$  be an open tubular neighborhood of a non-trivial knot  $K$  in  $S^3$ , and let  $S^1 \subset \partial T$  be a circle bounding a disc  $D^2$  that transversely intersects  $K$ . Then attaching this disc  $D^2$  to  $S^1$  and to  $S^3 \setminus T$  produces in both cases a contractible space even though the initial inclusion  $S^1 \subset S^3 \setminus T$  is not an equivalence.

(ii) Note, however, that if the map (61) is a weak equivalence, then by the Exactness Axiom (and Proposition 4.10), the map (62) must induce isomorphism for any homology and cohomology theory.

**Example 4.12.** Let us check that the Fulton-MacPherson operad  $\mathcal{F}_2$  is strongly 2-coherent. The category  $\partial \Psi_2^U$  is as follows:

$$\partial \Psi_2^U = \left\{ \begin{array}{c} \text{Y} \longleftarrow \text{Y} \longrightarrow \text{Y} \longleftarrow \text{Y} \longrightarrow \text{Y} \end{array} \right\}$$

Thus, one has to check that the map

$$\text{hocolim} \left( \mathcal{F}_2(2) \xleftarrow{pr_1} \mathcal{F}_2(2) \times \mathcal{F}_2(2) \xrightarrow{o_1} \mathcal{F}_2(3) \xleftarrow{o_2} \mathcal{F}_2(2) \times \mathcal{F}_2(2) \xrightarrow{pr_1} \mathcal{F}_2(2) \right) \longrightarrow \mathcal{F}_2(2) \quad (66)$$

is an equivalence. Here,  $pr_1$  is the projection to the first factor. The natural maps from each entry to  $\mathcal{F}_2(2)$  are: identity for the leftmost and rightmost ones;  $pr_1$  from both  $\mathcal{F}_2(2) \times \mathcal{F}_2(2)$ ; the map forgetting the second point  $x \mapsto x \circ_2 *_0$ , for  $\mathcal{F}_2(3)$ . As shown in Figure 15, the space  $\mathcal{F}_2(3)$  is homeomorphic to a solid torus minus two open solid tori that turn one around the other.

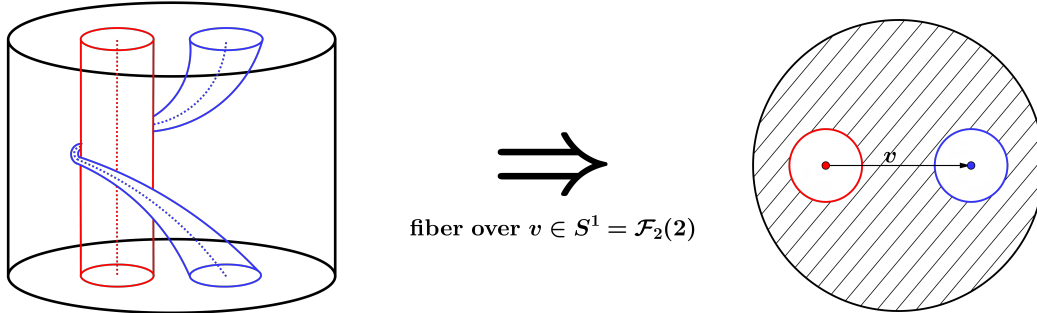

Figure 15: Illustration of  $\mathcal{F}_2(3)$  together with the fiber over  $v \in \mathcal{F}_2(2)$ .

Indeed, the map  $\mathcal{F}_2(3) \rightarrow \mathcal{F}_2(2)$  is a fiber bundle. If  $v \in \mathcal{F}_2(2) = S^1$ , then the fiber over  $v$  consists of (possibly infinitesimal) configurations of 3 points in which the direction between the points 1 and 3 is fixed to be  $v$ . The boundary of  $\mathcal{F}_2(3)$  has three connected components, that all are tori. One inner boundary torus corresponds to configurations, where 2 collided with 1, the other one to configurations, where 2 collided with 3. The outside boundary torus represents limit configurations in which the point 2 escapes to infinity or, equivalently, the points 1 and 3 are infinitesimally close one to another. On the other hand, the inclusions  $o_1$  and  $o_2$  in the diagram (66) produce the two inner boundary tori. Taking homotopy colimit corks in these two holes in  $\mathcal{F}_2(3)$ . As a result the homotopy colimit above is homeomorphic to  $S^1 \times D^2 \simeq \mathcal{F}_2(2)$ .

To compare, if we were to check that  $\mathcal{F}_2$  is 2-coherent, one would need to verify that the map

$$\mathrm{hocolim}_{\partial\Psi_2} \rho_2^{\mathcal{F}_2} \longrightarrow \mathrm{hocolim}_{\Psi_2^U} \rho_2^{\mathcal{F}_2} \coprod_{\mathrm{hocolim}_{\partial\Psi_2^{UL}} \rho_2^{\mathcal{F}_2}} \mathrm{hocolim}_{\partial\Psi_2^L} \rho_2^{\mathcal{F}_2} \quad (67)$$

is a weak equivalence. The first space  $\mathrm{hocolim}_{\partial\Psi_2} \rho_2^{\mathcal{F}_2}$  is homeomorphic to  $S^1 \times S^2$ , obtained from  $\mathrm{hocolim}_{\partial\Psi_2^U} \rho_2^{\mathcal{F}_2} \cong S^1 \times D^2$ , described above, by ‘‘corking’’ with a solid torus the outside part of the boundary of  $\mathcal{F}_2(3)$ . The right-hand side of (67) is homeomorphic to  $S^1$  times the space  $D^3$  from which one removes the interior of the lower cone, see Figure 12.

**Example 4.13.** The operad  $\mathcal{B}_0$ , denoted by  $\Lambda$  in this paper, is obviously strongly coherent. In Section 5 we prove that the Fulton-MacPherson operad  $\mathcal{F}_m$  and, therefore, the little discs operad  $\mathcal{B}_m$  are strongly coherent,  $m \geq 1$ . Since the homotopy colimits commute, one has that  $\mathcal{B}_\infty$  is also strongly coherent. This statement is equivalent to the fact that the categories  $\partial\Psi_k^U$ ,  $k \geq 2$ , are contractible, which is not obvious, but can be checked directly. Unfortunately, these are the only examples of coherent operads that we know.

## 4.2 Boardman-Vogt resolution as a homotopy colimit

Recall Subsection 3.2, where the Boardman-Vogt resolution  $\mathcal{I}b^\Lambda(M)$  of an  $O$ -Ibimodule is defined. Elements of  $\mathcal{I}b^\Lambda(M)(k)$  are triples  $[T; \{a_v\}, \{t_v\}]$ , where  $T \in \mathbf{ptree}_k^{\geq 1}$  is a planar pearled tree, whose non-pearl vertices have arity  $\geq 1$ ; its leaves are labelled by a permutation  $\sigma \in \Sigma_k$ ;  $\{a_v\}$  is a collection of elements in  $M$  and  $O$  labelling the vertices of  $T$ ; and  $\{t_v\}$  is an admissible collection of numbers in  $[0, 1]$  labelling  $V(T) \setminus \{p\}$ . It will be convenient sometimes to assume that the pearl is also labelled by 0. ‘‘Towards the pearl orientation’’ of edges enables the set  $V(T)$  of vertices of  $T$  with a ‘‘toward the pearl’’ poset structure, for which the pearl  $p$  is the minimal element. The space  $H(T) \subset [0, 1]^{V(T)}$  of admissible labels is the space of pointed order-preserving maps  $V(T) \rightarrow [0, 1]$ . *Pointed* means  $p \mapsto 0$ ; *order preserving* translates into a set of inequalities

$$t_{s(e)} \geq t_{t(e)},$$

for any internal edge  $e \in E^{\mathrm{int}}(T)$ . For example, for the tree

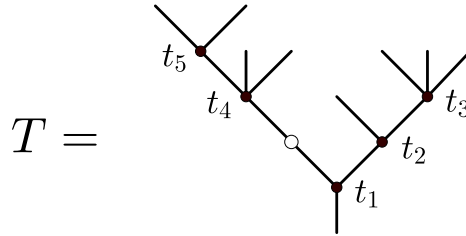

the polytope  $H(T)$  is given by the inequalities  $0 \leq t_1, t_2, t_3, t_4, t_5 \leq 1$ ,  $t_1 \leq t_2 \leq t_3$  and  $t_4 \leq t_5$ .

In case  $O$  is doubly reduced, the set  $\mathbf{ptree}_k^{\geq 1}$  can be replaced by its subset  $\mathbf{ptree}_k^{\geq 2}$  of trees, whose non-pearl vertices have arity  $\geq 2$ . One has an obvious projection  $\pi_k: \mathbf{ptree}_k^{\geq 2} \rightarrow \Psi_k$ , that forgets the planar structure. We say that an element  $x \in \mathcal{I}b^\Lambda(M)(k)$  is labelled by  $T_0 \in \Psi_k$  if  $x$  has a representative  $[T; \{a_v\}, \{t_v\}]$  with  $\pi_k(T) = T_0$ . Recall also that we denote by  $\partial\mathcal{I}b^\Lambda(M)(k)$  the  $(k-1)$ -th filtration term  $\mathcal{I}b_{k-1}^\Lambda(M)(k)$ .

Since  $\Psi_k$  is a poset,  $T \downarrow \Psi_k$  is viewed below as a subcategory of  $\Psi_k$ .

**Theorem 4.14.** *For a doubly reduced topological operad  $O$ , and an  $O$ -Ibimodule  $M$ , one has a natural homeomorphism:*

$$\delta_k: \mathrm{hocolim}_{\Psi_k} \rho_k^M \longrightarrow \mathcal{I}b^\Lambda(M)(k), \quad k \geq 0. \quad (68)$$

Moreover,

(i) it sends homeomorphically  $\text{hocolim}_{\partial\Psi_k} \rho_k^M$  onto  $\partial\mathcal{I}b^\Lambda(M)(k)$ ;

(ii) for any  $T \in \Psi_k$ , it sends homeomorphically  $\text{hocolim}_{T \downarrow \Psi_k} \rho_k^M$  onto the subspace of elements labelled by the trees from  $T \downarrow \Psi_k$ .

*Proof.* By definition, our homotopy colimit is a quotient space

$$\text{hocolim}_{\Psi_k} \rho_k^M = \left( \coprod_{T \in \Psi_k} |T \downarrow \Psi_k| \times \rho_k^M(T) \right) / \sim. \quad (69)$$

We will define  $\delta_k$  on each summand of (69):

$$\delta_T: |T \downarrow \Psi_k| \times \rho_k^M(T) \longrightarrow \mathcal{I}b^\Lambda(M)(k).$$

Recall that

$$\rho_k^M(T) = M(|p|) \times \prod_{v \in V(T) \setminus \{p\}} O(|v|).$$

Recall also that for defining  $\rho_k^M$  we need to choose a planar representative for each  $T \in \Psi_k$ . Abusing notation we denote by  $T$  this planar tree. (Because of the relation (ii) of Construction 3.10 this choice does not matter.) Thus an element  $a \in \rho_k^M(T)$  is a collection of labels  $\{a_v\}$  of vertices of  $T$ . For  $(x, a) \in |T \downarrow \Psi_k| \times \rho_k^M(T)$ , we set

$$\delta_T(x, a) = [T; a, f_T(x)], \quad (70)$$

where  $f_T$  is a continuous map

$$f_T: |T \downarrow \Psi_k| \longrightarrow H(T)$$

from the cube  $|T \downarrow \Psi_k|$  to the polytope  $H(T)$  of admissible labels of  $T$ . The maps  $f_T$ ,  $T \in \Psi_k$ , are defined below. (Note that both polytopes have the same dimension  $d = |E^{\text{int}}(T)| = |V(T) \setminus \{p\}|$ .) In other words, the idea of our homeomorphism is to replace the labelling by elements from the polytopes  $H(T)$  with the labelling from the cubes  $|T \downarrow \Psi_k|$ ,  $T \in \Psi_k$ . Figure 16 gives an example of such cube and Figure 17 describes the image of the vertices of this cube in  $H(T)$  by the map  $f_T$  that we are going to construct.

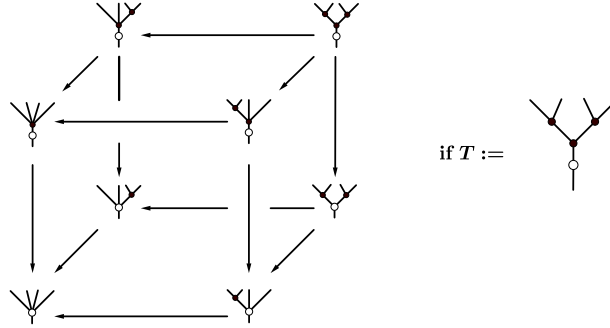

Figure 16: The cube  $T \downarrow \Psi_4$  associated to the planar pearled tree  $T$ .

To make the maps  $\delta_T$ ,  $T \in \Psi_k$ , compatible with the relations of homotopy colimit (69), for each morphism  $T \xrightarrow{\alpha} T'$  in  $\Psi_k$ , the following square must commute:

$$\begin{array}{ccc} |T' \downarrow \Psi_k| & \xrightarrow{f_{T'}} & H(T') \\ \downarrow & & \downarrow \alpha^* \\ |T \downarrow \Psi_k| & \xrightarrow{f_T} & H(T) \end{array} \quad (71)$$



Indeed, this would send the relations of the homotopy colimit to relations (iii) and (iv) of Construction 3.10. The left vertical arrow here is a subcubical inclusion (induced by an inclusion of cubical posets); the right vertical arrow  $\alpha^*$  is the precomposition with the map of vertices  $\alpha_*: V(T) \rightarrow V(T')$  induced by the edge contraction  $\alpha$ . The cube  $|T \downarrow \Psi_k|$  is a union of  $d!$  simplices of dimension  $d$  corresponding to the maximal chains in  $T \downarrow \Psi_k$ . We will define  $f_T$  on each vertex of the cube, and then extend inside each such simplex linearly. Note also that if all the functions  $f_{T'}$ ,  $T' \in (T \downarrow \Psi_k)$ ,  $T' \neq T$ , are already (compatibly) defined, then the only freedom to extend this map to a map on the whole cube  $|T \downarrow \Psi_k|$  would be the choice of  $z_T := f_T(T) \in H(T)$  the image of the initial element  $T$  of this cube.

Choose any collection  $z = \{z_{T'}\}$  of points  $z_{T'} \in H(T')$ ,  $T' \in \Psi_k$ . For any  $T \in \Psi_k$  and any  $T \xrightarrow{\alpha} T'$ , define  $f_T^z(T') := \alpha^*(z_{T'})$ , and then extend  $f_T^z$  on the maximal simplices of  $|T \downarrow \Psi_k|$  by linearity. As a result, the compatibility of the face inclusions (71) is satisfied, and thus by means of (70) these  $f_T^z$  determine a continuous map  $\delta_k^z: \text{hocolim}_{\Psi_k} \rho_k^M \rightarrow \mathcal{I}b^\wedge(M)(k)$ . For  $\delta_k^z$  to be a homeomorphism, all the maps  $f_T^z: |T \downarrow \Psi_k| \rightarrow H(T)$ ,  $T \in \Psi_k$ , must be homeomorphisms.

For any  $T \in \Psi_k$ , define  $MAX(T) \subset V(T) \setminus \{p\}$  as the set of maximal elements of  $V(T) \setminus \{p\}$  with respect to the ‘‘toward the pearl’’ partial order. We then define

$$z_{T'}: V(T') \rightarrow [0, 1]; \quad v \mapsto \begin{cases} 1 - \frac{1}{2^{d(v;p)}}, & \text{if } v \notin MAX(T'); \\ 1, & \text{otherwise,} \end{cases} \quad (72)$$

where  $d(v; p)$  is the distance between  $v$  and  $p$ , i.e. the number of edges in the path between them. We claim that for this collection of  $z_{T'} \in H(T')$ ,  $T' \in \Psi_k$ , each map  $f_T := f_T^z$  is a homeomorphism. The proof is by induction over the dimension  $d$  of the cubes. If  $d = 0$ , i.e.  $T$  is a pearled corolla, both  $|T \downarrow \Psi_k|$  and  $H(T)$  are points and the statement is obvious. Now, consider any  $d \geq 1$ . There are two cases.

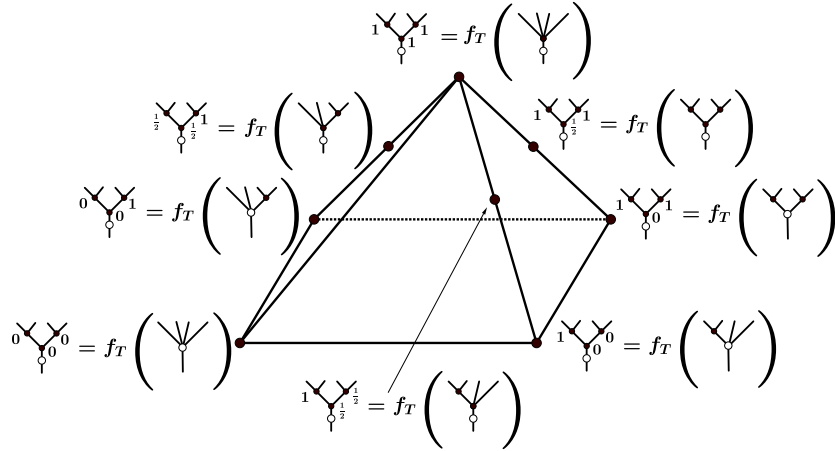

Figure 17: The image of the vertices in the polytope  $H(T)$  associated to the cube in Figure 16.

**Case 1:** The pearl  $p$  of  $T$  is adjacent to more than one inner edge. In this case the polytope  $H(T)$  is a product of polytopes

$$H(T) = \prod_i H(T_i),$$

where  $T_i$  is a pearled tree obtained from  $T$  by cutting off all the internal edges adjacent to  $p$  (together with all the subtrees not containing  $p$ ) except one. On the other hand, the cube  $|T \downarrow \Psi_k|$  also factors into a similar product (of subcubes this time). Since our formula for  $z_{T'}: V(T') \rightarrow [0, 1]$  uses only the distance to the pearl, the map  $f_T$  respects this factorization. By induction, for smaller cubes the map is a homeomorphism, therefore it is so for their product.

**Case 2:** The pearl  $p$  of  $T$  is connected to only one inner vertex  $v_0$ . We call  $e := (p, v_0)$  the *distinguished edge* of  $T$ . In this case  $H(T)$  is a pyramid  $P$  with base  $H(T/e)$ , that corresponds to  $t_{v_0} = 0$ , and with the apex  $A$  corresponding to  $t_{v_0} = 1$ , which forces the constant labelling  $(V(T) \setminus \{p\}) \rightarrow 1$ , see Figure 17. By the induction hypothesis, the  $(d-1)$ -subcube  $|T/e \downarrow \Psi_k| \subset |T \downarrow \Psi_k|$  is sent homeomorphically to the base of  $P$ . Let  $T_1 \in T \downarrow \Psi_k$  be the tree obtained from  $T$  by contracting its all non-distinguished edges. By definition of  $f_T$ , one has  $f_T(T_1) = A$  is the apex of the pyramid. Each of the remaining  $(2^{d-1} - 1)$  trees  $T' \in (T \downarrow \Psi_k)$ ,  $T' \neq T_1$ ,  $T' \notin (T/e \downarrow \Psi_k)$ , is sent in the middle of the side edge of  $P$  between the apex  $A$  and the vertex  $f_T(T'/e)$  of the base cube:

$$f_T(T') = \frac{1}{2}(f_T(T'/e) + f_T(T_1)).$$

This formula is a consequence of our choice of  $z_{T'}$ , see (72), and also the fact that the function  $f_T(T_1): (V(T) \setminus \{p\}) \rightarrow [0, 1]$  is constantly one.

To convince ourselves that  $f_T$  is a homeomorphism from a cube to a pyramid, one can pull the apex  $A$  down along the side edge of constant labels (the only one that does not have a vertex from  $f_T(T \downarrow \Psi_k)$  in the middle):

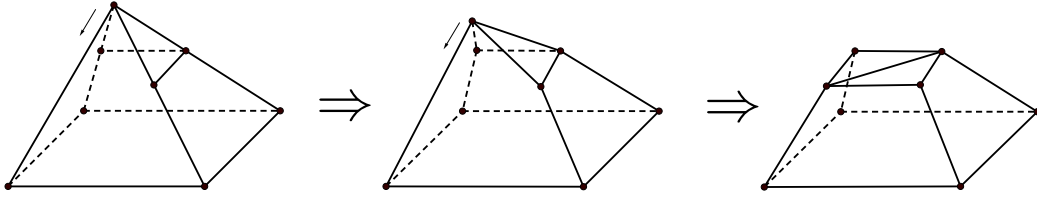

For the statement (i) of the theorem, recall that  $\partial \mathcal{I}b^\wedge(M)(k)$  consists of points  $[T; \{a_v\}; \{t_v\}]$  for which at least one  $t_v = 1$ . We get that (i) follows from the fact that any tree  $T \in \Psi_k$  except the terminal one  $c_k$  has a non-empty set  $MAX(T)$  and also from our choice of  $z$ , see (72). To verify (ii) we note that all the elements in the image of  $\delta_T$  are labelled by  $T$ , and one also has

$$\delta_k \left( \text{hocolim}_{T \downarrow \Psi_k} \rho_k^M \right) = \bigcup_{T' \in (T \downarrow \Psi_k)} \text{Im } \delta_{T'}.$$

□

**Remark 4.15.** The constructed homeomorphism  $\delta_k$  sends the subspace

$$\text{hocolim}_{\Psi_k^U} \rho_k^M \prod_{\text{hocolim}_{\partial \Psi_k^{UL}} \rho_k^M} \text{hocolim}_{\partial \Psi_k^L} \rho_k^M, \quad k \geq 2,$$

to the subspace denoted  $\partial' \mathcal{I}b^\wedge(M)(k) \subset \mathcal{I}b^\wedge(M)(k)$ , which has all the points in the boundary  $\partial \mathcal{I}b^\wedge(M)(k)$  plus all the elements labelled by pearled trees from  $\Psi_k^U$ . Thus by Proposition 4.10 (ii), a doubly reduced operad  $O$  is  $k$ -coherent if and only if for any  $i$  in the range  $2 \leq i \leq k$ , the inclusion  $\partial \mathcal{I}b^\wedge(O)(i) \subset \partial' \mathcal{I}b^\wedge(O)(i)$  is a weak equivalence.

## 5 Fulton-MacPherson operad $\mathcal{F}_m$

The Fulton-MacPherson operad  $\mathcal{F}_m$  is a well known model of the little discs operad  $\mathcal{B}_m$ . In case  $m = 1$ ,  $\mathcal{F}_1$  is the Stasheff  $A_\infty$  operad:  $\mathcal{F}_1(k)$  is a disjoint union of  $k!$  associahedra  $A_{k-2}$  [Sta63], [Sin04, Theorem 4.19]. It appeared first in a work by Getzler-Jones [GJ94] and also in papers by Kontsevich [Kon99, Kon03] and by Markl [Mar99]. Since then it had a countless number of applications in mathematical physics and topology. Here are some of them [CFT02, Kon01, Sal01, Sin04, Sin09, Tur13, LV14]. In this section we provide one more application of this operad, which together with Main Theorem 2 completes the proof of Main Theorem 1.

**Theorem 5.1.** *For any  $m \geq 1$ , the Fulton-MacPherson operad  $\mathcal{F}_m$  is strongly coherent.*

In the first three subsections we prove this theorem. In the last subsection we outline an alternative construction of a Reedy cofibrant replacement of  $\mathcal{F}_m$  as a bimodule over itself. We denote it by  $\mathcal{BF}_m$ . It is used in Subsection 6.3, where we explain the initial geometrical idea for the delooping result. In the following, we recall the main properties of  $\mathcal{F}_m$ . We refer the reader to [LV14, Section 5], where this operad and the conventions below about infinitesimal configurations are explained in full detail.

- ▶  $\mathcal{F}_m(0) = \mathcal{F}_m(1) = *$  and  $\mathcal{F}_m(k)$ , with  $k \geq 2$ , is a manifold with corners whose interior is the configuration space  $C(k; \mathbb{R}^d)$ , of  $k$  distinct points in  $\mathbb{R}^d$ , quotiented out by translations and rescalings.
- ▶ The strata of  $\mathcal{F}_m(k)$ , with  $k \geq 2$ , are encoded by non-planar rooted trees with  $k$  leaves (labelled by  $1, \dots, k$ ) whose all internal vertices are of valence  $\geq 3$ . The codimension of the stratum encoded by a tree  $T$  is  $|V(T)| - 1$ . The closure of the stratum encoded by  $T$  is homeomorphic to  $\prod_{v \in V(T)} \mathcal{F}_m(|v|)$ . We denote this closure by  $\mathcal{F}_m(T)$ . It is a manifold with corners whose interior is the stratum we started with.
- ▶ By construction,  $\mathcal{F}_m$  is an operad in compact semi-algebraic sets, see [LV14].

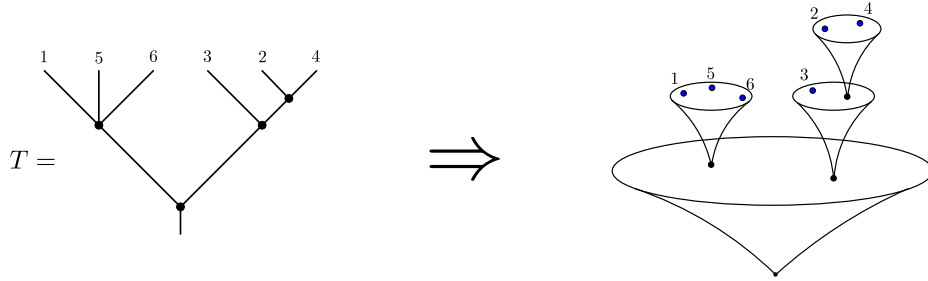

Figure 18: A tree  $T$  together with an element in the interior of  $\mathcal{F}_m(T)$ . It represents an infinitesimal configuration in a stratum of  $\mathcal{F}_m(6)$ : points 1, 5, and 6 collided together, and so did 2, 3, and 4. But the distance between the points 2 and 4 is infinitesimally small compared to the distance between 2 and 3.

In order to prove that the Fulton-MacPherson operad is strongly coherent, we consider an alternative cofibrant replacement of the Fulton-MacPherson operad in the category  $\Lambda \text{bimod}_{\mathcal{F}_m}$  that uses compactification of configuration spaces. Similarly to the Fulton-MacPherson operad, the components of the infinitesimal bimodule so obtained are manifolds with corners. By studying the geometry of its stratification, we prove Theorem 5.1.

## 5.1 Infinitesimal bimodule $\mathcal{IF}_m$

In this subsection, we describe a different model of a Reedy cofibrant replacement of  $\mathcal{F}_m$  as an infinitesimal bimodule over  $\mathcal{F}_m$ . We denote this model by  $\mathcal{IF}_m$ . In case  $m = 1$ , the component  $\mathcal{IF}_1(k)$  is a disjoint union of  $k!$  cyclohedra  $C_k$  [BT94, LTV10]. Similarly to the Fulton-MacPherson operad  $\mathcal{F}_m$ , the components of  $\mathcal{IF}_m$  are also obtained as Axelrod-Singer-Fulton-MacPherson compactifications of configuration spaces (see [Sin04]), but this time we don't quotient out by any kind of translations or rescalings. More precisely, we view those spaces as configuration spaces of  $(k + 1)$  points in  $S^m = \mathbb{R}^m \cup \{\infty\}$ , where the  $(k + 1)$ st point is fixed to be  $\infty$ , and then we take the compactification in question.

Explicitly,  $\mathcal{IF}_m$  is described in the work of the second author [Tur13]. In order to see that the obtained spaces have the structure of an infinitesimal bimodule over  $\mathcal{F}_m$ , one should parametrize the strata from the "flat" point of view. That is, instead of looking at how points approach  $\infty$ , one should look at how the points are located with respect to each other when they escape to infinity (for details see [Tur13]). Here are the main properties of  $\mathcal{IF}_m$ .

- Each  $\mathcal{IF}_m(k)$ , with  $k \geq 0$ , is a smooth manifold with corners, whose interior is  $C(k; \mathbb{R}^m)$ .
- The strata of  $\mathcal{IF}_m(k)$  are encoded by non-planar pearled trees with  $k$  labelled leaves. Their pearl could be of any valence  $\geq 1$ , while all the other vertices must be of valence  $\geq 3$ . The codimension of a stratum encoded by a pearled tree  $T$  is  $|V(T)| - 1$ .
- The closure of the stratum encoded by  $(T, p)$ , denoted by  $\mathcal{IF}_m(T)$ , is homeomorphic to

$$\mathcal{IF}_m(|p|) \times \prod_{v \in V(T) \setminus \{p\}} \mathcal{F}_m(|v|).$$

Another important property for us is that  $\mathcal{IF}_m$  is an infinitesimal bimodule over  $\mathcal{F}_m$  in the category of semi-algebraic compact spaces. Figure 19 gives an example of an infinitesimal configuration in which points 2, 6, 7, 1, 8 escape to infinity; the points 3, 4 and 5 stay inside  $\mathbb{R}^m$  (the shaded disc in the figure corresponds to the pearl of the tree), but 4 and 5 collide. Also while escaping to infinity 2, 6, 7 stay close to each other, and the same happen with the pair 1 and 8.

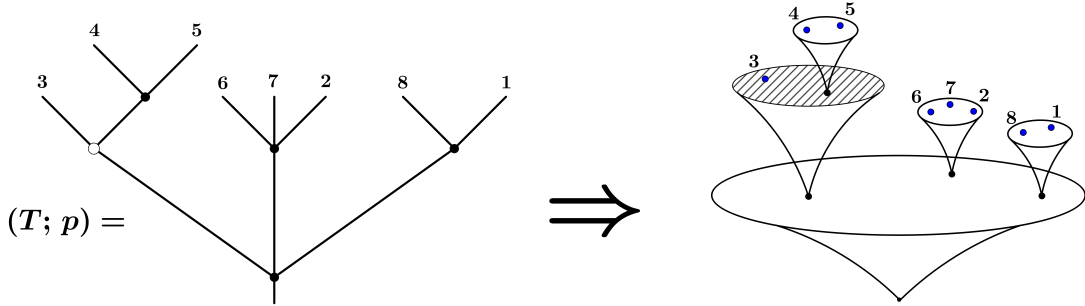

Figure 19: A pearled tree  $(T; p)$  together with an element in the interior of  $\mathcal{IF}_m(T)$ .

**Remark 5.2.** We believe that  $\mathcal{IF}_m$  and  $\mathcal{Ib}^\wedge(\mathcal{F}_m)$  are homeomorphic as  $(\mathcal{F}_m)_{>0}$ -Ibimodules. Example 3.17 and the projection that we study in the next subsection show that this is the case for the arities  $k \leq 2$ . If true, this would be similar to the fact that the Boardman-Vogt resolution of  $(\mathcal{F}_m)_{>0}$  as operad is homeomorphic to  $(\mathcal{F}_m)_{>0}$ , see [Sal01, Proposition 3.7].

## 5.2 Projection map $\mathcal{IF}_m \rightarrow \mathcal{F}_m$

In this subsection we want to understand a little bit better the geometry of  $\mathcal{IF}_m$ . The interior of  $\mathcal{IF}_m$  is  $C(k; \mathbb{R}^m)$ . It turns out that the natural quotient map of interiors can be extended to a smooth map

$$\mu_{\mathcal{I}} : \mathcal{IF}_m(k) \longrightarrow \mathcal{F}_m(k), \quad \text{with } k \geq 0.$$

These maps turn out to respect the infinitesimal bimodule structure over  $\mathcal{F}_m$  making  $\mathcal{IF}_m$  into a Reedy cofibrant replacement of  $\mathcal{F}_m$  as  $\mathcal{F}_m$ -Ibimodule. Moreover, by construction, these maps are semi-algebraic. In the following subsection, we will be using not only the statement of Proposition 5.3, but also the description of the stratified structure of the preimages given in the proof.

**Proposition 5.3.** *Let  $\mu_{\mathcal{I}} : \mathcal{IF}_m(k) \longrightarrow \mathcal{F}_m(k)$  be the map described above. For any point  $x \in \mathcal{F}_m(k)$ , with  $k \geq 2$ , the preimage  $\mu_{\mathcal{I}}^{-1}(x)$  is an  $(m+1)$ -dimensional disc.*

*Proof.* Let  $T$  be a tree encoding a stratum of  $\mathcal{F}_m(k)$ , with  $k \geq 2$ . Then, the preimage under  $\mu_{\mathcal{I}}$  of this stratum consists of the strata of  $\mathcal{IF}_m(k)$  indexed by pearled trees  $(T'; p)$  of one of the four types:

- Type I. Tree  $(T'; p)$  is obtained by putting a pearl in one of the vertices of  $T$ .

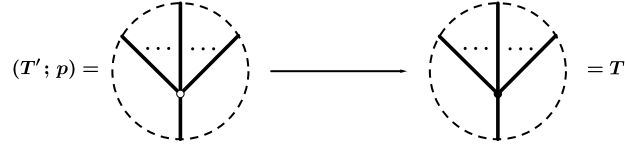

► Type II. Tree  $(T'; p)$  is obtained by putting a pearl in the middle of one of the edge of  $T$ .

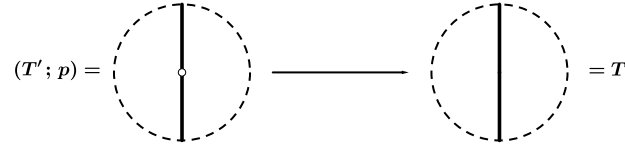

► Type III. Tree  $(T'; p)$  is obtained by attaching a univalent pearl to a vertex of  $T$ .

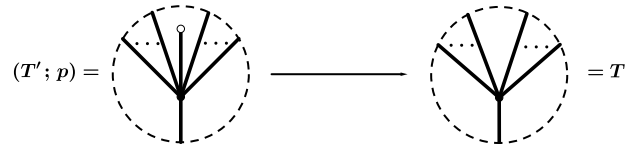

► Type IV. Tree  $(T'; p)$  is obtained by attaching a univalent pearl to the middle of an edge of  $T$ .

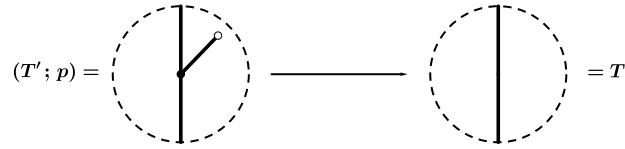

The figures above show how locally  $(T'; p)$  differs from  $T$ . Outside the dotted circles  $(T'; p)$  and  $T$  are identical.

Consider a point  $x \in \mathcal{F}_m(k)$ , with  $k \geq 2$ . We want to analyze the contribution to the preimage  $\mu_T^{-1}(x)$  of the strata above and show that these contributions glue together into a closed  $(m+1)$ -disc. To start with, let us consider  $x$  in the interior of  $\mathcal{F}_m(k)$ , or in other words let it lie in the stratum encoded by the  $k$ -corolla:

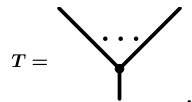

The part of the preimage of  $x$  of Type I is the part in the interior of  $\mathcal{IF}_m(k)$ , labelled by the pearled  $k$ -corolla. This part is an open  $(m+1)$ -ball (it is the set  $\mathbb{R}^m \times \mathbb{R}_+$  of translations and rescalings). This part is exactly the interior of the preimage disc. The Type II preimage lies in the strata labelled by the pearled trees

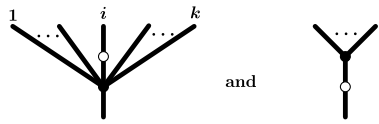

There are  $k+1$  such trees. The preimage corresponding to each of these trees is homeomorphic to the interior of  $\mathcal{IF}_m(1)$ , which is an open  $m$ -disc. Their closures are  $k+1$  disjoint closed  $m$ -discs, whose boundary spheres are the Type IV preimages corresponding respectively to the pearled trees

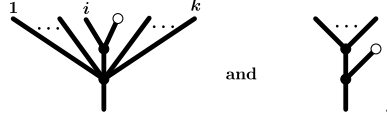

We are left to analyze the Type III preimage, corresponding to the pearled tree



Note that this preimage is the same as the interior part of the preimage under the map  $\mathcal{F}_m(k+1) \rightarrow \mathcal{F}_m(k)$  that forgets the last point, and is  $\mathbb{R}^m$  minus  $k$  points. The compactification of this part is a closed  $m$ -disc minus  $k$  disjoint open sub-discs. There are  $k+1$  spheres in the boundary, which are exactly the Type IV preimages. Note that the Type II, III, and IV preimages all together form an  $m$ -sphere. On the other hand, by using the methods developed by D.Sinha in [Sin04], one can show that  $\mu_{\mathcal{I}}^{-1}(x)$  is a manifold with corners, whose boundary is a sphere stratified as above. This manifold with corners must be contractible since any topological manifold with boundary is homotopy equivalent to its interior. But then, by the topological  $h$ -cobordism theorem, which is true for all dimensions,  $\mu_{\mathcal{I}}^{-1}(x)$  must be homeomorphic to a closed disc. (The topological  $h$ -cobordism theorem is a combination of many deep results in the theory of manifolds due to Smale, Freedman and Perelman. For our purposes we only need that these preimages are contractible, which as we have seen follows from the fact that their interiors are contractible being open  $(m+1)$ -balls.)

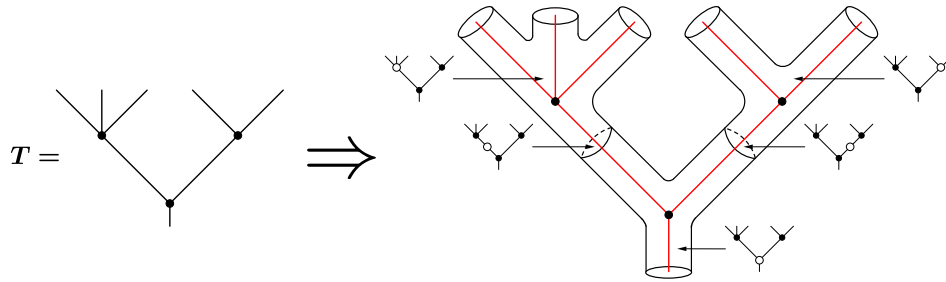

Figure 20: The preimage  $\mu_{\mathcal{I}}^{-1}(x)$  with  $x$  in the stratum indexed by  $T$ .

Now, consider the general case  $x \in \mathcal{F}_m(k)$ , where  $x$  lies in the stratum indexed by any tree  $T$ . We claim that  $\mu_{\mathcal{I}}^{-1}(x)$  is a union of  $|V(T)|$  closed  $(m+1)$ -discs glued with each other along  $m$ -discs lying in their boundary spheres, so that  $\mu_{\mathcal{I}}^{-1}(x)$  looks like a tubular neighborhood of the tree  $T$  embedded in  $\mathbb{R}^{m+1}$ . The interior of those  $(m+1)$ -discs are Type I parts of the preimage (one disc for each pearled Type I tree  $(T'; p)$ ). The  $m$ -discs are Type II preimages. Their boundary  $(m-1)$ -spheres are Type IV preimages. The parts of the boundaries of  $(m+1)$ -discs, that look like  $m$ -discs with holes, are Type III preimages. Figure 20 gives an example of a tree  $T$  and how the corresponding preimage  $\mu_{\mathcal{I}}^{-1}(x)$  looks like.  $\square$

**Remark 5.4.** It was shown in [LV14] that the map  $\pi: \mathcal{F}_m(k+1) \rightarrow \mathcal{F}_m(k)$ , that forgets one of the points, is a semi-algebraic fiber bundle, whose fibers are closed  $m$ -discs with  $k$  holes. We believe that our map  $\mu_{\mathcal{I}}: \mathcal{IF}_m(k) \rightarrow \mathcal{F}_m(k)$  is also a semi-algebraic fiber bundle (that contains  $\pi$  as a subbundle). Moreover, we expect that this bundle is topologically trivial.

### 5.3 Fulton-MacPherson operad is strongly coherent

This subsection is devoted to the proof of Theorem 5.1. Recall definitions and notation from Subsection 4.1. Because the projection  $\mu_{\mathcal{I}}: \mathcal{IF}_m \rightarrow \mathcal{F}_m$  is a weak equivalence of infinitesimal bimodules, it induces an equivalence of diagrams  $\rho_k^{\mathcal{IF}_m} \rightarrow \rho_k^{\mathcal{F}_m}$ ,  $k \geq 0$ . Thus it is enough for us to prove strong coherence of the

diagrams  $\rho_k^{\mathcal{IF}_m}$ ,  $k \geq 2$ . We note also that for any pearled tree  $T \in \Psi_k$ , the functor  $\rho_k^{\mathcal{IF}_m}$  assigns a space, which is nothing but the stratum of  $\mathcal{IF}_m$  labelled by  $T$ :

$$\rho_k^{\mathcal{IF}_m}(T) = \mathcal{IF}_m(T).$$

**Proposition 5.5.** *The following natural map*

$$\operatorname{hocolim}_{\partial\Psi_k^U} \rho_k^{\mathcal{IF}_m} \longrightarrow \operatorname{colim}_{\partial\Psi_k^U} \rho_k^{\mathcal{IF}_m}$$

is a weak equivalence.

*Proof.* Let  $C$  be a small category. We consider the category  $\operatorname{Top}^C$  of diagrams of shape  $C$  with its *projective model structure*, in which weak equivalences and fibrations are, respectively, objectwise weak equivalences and objectwise fibrations [Hir03, Section 11.6]. In case  $F : C \rightarrow \operatorname{Top}$  is cofibrant, the natural map

$$\operatorname{hocolim}_C F \longrightarrow \operatorname{colim}_C F$$

is a weak equivalence [Hir03, Theorem 11.6.8 (2)]. To prove our proposition we need to show that  $\rho_k^{\mathcal{IF}_m} \Big|_{\partial\Psi_k^U}$  is a cofibrant diagram.

An example of a cofibrant diagram is a functor of the form  $X \times \operatorname{hom}_C(c; -)$ , where  $c \in C$  and  $X$  is a cofibrant space. The cofibrancy (left lifting property) follows from the fact (Yoneda lemma) that

$$\operatorname{Nat}_C(X \times \operatorname{hom}_C(c; -), F) = \operatorname{Map}(X; F(c)).$$

In case  $X \hookrightarrow Y$  is a cofibration of spaces, one similarly gets that the natural transformation

$$X \times \operatorname{hom}_C(c; -) \longrightarrow Y \times \operatorname{hom}_C(c; -)$$

is a cofibration in  $\operatorname{Top}^C$ . More generally, since a pushout of a cofibration is a cofibration, we get that the right vertical map in any pushout diagram of the form

$$\begin{array}{ccc} X \times \operatorname{hom}_C(c; -) & \longrightarrow & F \\ \downarrow & & \downarrow \\ Y \times \operatorname{hom}_C(c; -) & \longrightarrow & F' \end{array} \quad (73)$$

is a cofibration. Here  $F \in \operatorname{Top}^C$  is any diagram of shape  $C$ , and the upper horizontal map is obtained from some  $f : X \rightarrow F(c)$  applying the Yoneda lemma. This type of a map  $F \hookrightarrow F'$  will be called *cellular inclusion*. In what follows, a diagram of shape  $C$  is said to be *cellular cofibrant* if it is obtained from the constantly empty diagram by a finite sequence of cellular inclusions.

Obviously, being cellular cofibrant implies being cofibrant. Let us now show that  $\rho_k^{\mathcal{IF}_m} \Big|_{\partial\Psi_k^U}$  is cellular cofibrant. To do it, we show first that  $\rho_k^{\mathcal{IF}_m} \in \operatorname{Top}^{\Psi_k}$  is cellular cofibrant. For this purpose, we take the "skeleton filtration"

$$\emptyset \subset F_{(kd-k)} \rho_k^{\mathcal{IF}_m} \subset F_{(kd-k+1)} \rho_k^{\mathcal{IF}_m} \subset \cdots \subset F_{(kd)} \rho_k^{\mathcal{IF}_m} = \rho_k^{\mathcal{IF}_m},$$

where  $F_{(j)} \rho_k^{\mathcal{IF}_m}$  assigns to a planar pearled tree  $T$  the union of strata in  $\mathcal{IF}_m(T)$  of dimension  $\leq j$ . Then each inclusion  $F_{(kd-i-1)} \rho_k^{\mathcal{IF}_m} \hookrightarrow F_{(kd-i)} \rho_k^{\mathcal{IF}_m}$  can be seen as a sequence of cell inclusions: we consecutively attach strata labelled by trees  $T$  with  $i$  internal vertices different from the pearl. For such cell inclusion (see (73)), the corresponding cofibration  $X \hookrightarrow Y$  in this case is  $\partial\mathcal{IF}_m(T) \hookrightarrow \mathcal{IF}_m(T)$  (recall that  $\mathcal{IF}_m(T)$  is a manifold with corners, and  $\partial\mathcal{IF}_m(T)$  is its boundary). The element  $c$  is the tree  $T$  itself, and the corresponding attachment map  $X \rightarrow F(c)$  is the identity map.



**Lemma 5.6.** *In case  $T = c_k$  or  $c'_k$ , the poset  $T \downarrow \partial\Psi_k^U$  is empty; for any other  $T \in \Psi_k$ , the poset  $T \downarrow \partial\Psi_k^U$  has an initial element.*

*Proof of Lemma 5.6.* Indeed,  $c_k$  is the terminal element and does not have any morphism to  $\partial\Psi_k^U$ . Similarly with  $c'_k$ : besides the identity map, it only has a morphism to  $c_k$ . If  $T \in \partial\Psi_k^U$ , the initial element is  $T$  itself. Finally, for  $T \notin \Psi_k^U$  and  $T \neq c'_k$ , the poset  $T \downarrow \partial\Psi_k$  is non-empty, but it has an initial element as shown in Figure 21.

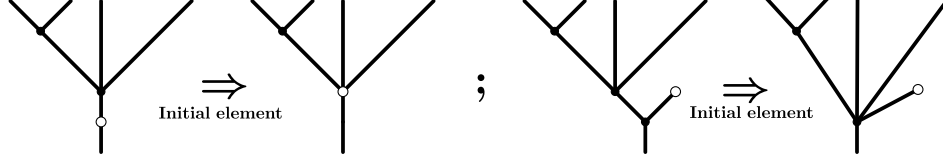
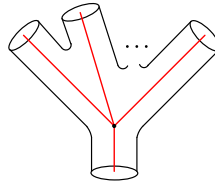

Figure 21: Examples of planar pearled trees together with their initial elements. □

This property implies that any functor of the form  $X \times \text{hom}_{\Psi_k}(T; -)$  when restricted on  $\partial\Psi_k^U$  is either constantly empty (in case  $T$  is  $c_k$  or  $c'_k$ ) or is  $X \times \text{hom}_{\partial\Psi_k^U}(T_{min}; -)$ , where  $T_{min}$  is the initial element of the set  $T \downarrow \partial\Psi_k^U$ . As a consequence, any cellular cofibrant  $G \in \text{Top}^{\Psi_k}$  remains cellular cofibrant when restricted on  $\partial\Psi_k^U$ . This proves our proposition. □

From now on, it is easy to see that  $\text{colim}_{\partial\Psi_k^U} \rho_k^{\mathcal{IF}_m}$ , denoted by  $A(k)$  for shortness, is a subspace of  $\mathcal{IF}_m(k)$ , which, as a consequence of Lemma 5.6, is the union of all its (open) strata except those labelled by  $c_k$  and  $c'_k$ . The first one is the interior of  $\mathcal{IF}_m(k)$ , and the second one is part of its boundary. To finish the proof of the strong coherence we are left to show that the inclusion  $A(k) \subset \mathcal{IF}_m(k)$  is an equivalence, or, equivalently, the projection  $\mu_{\mathcal{I}}|_{A(k)}: A(k) \rightarrow \mathcal{F}_m(k)$  is one. The latter map is a semi-algebraic map between compact spaces and, as we will see, has contractible preimages, which implies that the map is an equivalence [Lac69, Corollary 1.3] and [DK88, Corollary 2]. Indeed,  $\mu_{\mathcal{I}}$  sends the open strata encoded by  $c_k$  and  $c'_k$  in the interior of  $\mathcal{F}_m(k)$ . Thus for  $x \in \partial\mathcal{F}_m(k)$ ,  $\mu_{\mathcal{I}}^{-1}(x) \subset A(k)$  and is a closed  $(m+1)$ -disc by Proposition 5.3. On the other hand, if  $x$  is in the interior of  $\mathcal{F}_m(k)$ , then  $\mu_{\mathcal{I}}^{-1}(x)$  is a manifold with corners which looks like a tubular neighborhood of a  $k$ -corolla in  $\mathbb{R}^{m+1}$ :



See the proof of Proposition 5.3. The part lying in the stratum encoded by  $c_k$  is the interior, and the part encoded by  $c'_k$  is the bottom (open)  $m$ -disc. Thus,  $\mu_{\mathcal{I}}^{-1}(x) \cap A(k)$  is homeomorphic to a closed  $m$ -disc, and therefore is contractible. We conclude that  $\mu_{\mathcal{I}}|_{A(k)}$  is a weak equivalence. This finishes the proof of Theorem 5.1.

## 5.4 Bimodule $\mathcal{BF}_m$

As we mentioned in the introduction, our initial idea for the proof of Main Theorem 1 was to use geometrical cofibrant replacements of  $\mathcal{F}_m$  as an infinitesimal bimodule and as a bimodule over itself. This geometrical replacement as Ibimodule was described in Subsection 5.1 and it was used for the proof of the strong coherence of  $\mathcal{F}_m$ . For the completeness of the picture, in this subsection we outline the idea of the construction

of the geometrical bimodule replacement  $\mathcal{BF}_m$  of  $\mathcal{F}_m$ . For  $m = 1$ , the component  $\mathcal{BF}_1(k)$  is expected to be a disjoint union of  $k!$  multiplihedra  $M_{k-1}$  [Sta63]. Similarly to  $\mathcal{IF}_m$  which is conjectured to be homeomorphic to  $\mathcal{I}b^\wedge(\mathcal{F}_m)$  as an  $(\mathcal{F}_m)_{\geq 0}$ -bimodule, and also similarly to the operad  $(\mathcal{F}_m)_{>0}$  itself, which is known to be homeomorphic to its operadic Boardman-Vogt replacement [Sal01], we conjecture that  $\mathcal{BF}_m$  is homeomorphic to  $\mathcal{B}^\wedge(\mathcal{F}_m)$  as an  $(\mathcal{F}_m)_{>0}$ -bimodule, implying that all the components  $\mathcal{B}^\wedge(\mathcal{F}_m)(k)$ ,  $k \geq 0$ , are naturally topological manifolds with boundary.

The components  $\mathcal{BF}_m(k)$ , with  $k \geq 1$ , of this hypothetical bimodule should be obtained as compactification of the spaces  $C(k; \mathbb{R}^m)$  quotiented out by translations only. For example,  $\mathcal{BF}_m(1) = *$  and  $\mathcal{BF}_m(2) = S^{m-1} \times [0, +\infty] \cong \mathcal{F}_m(2) \times [-1, 1]$ , compare with Example 3.8. Here are the main properties that one expects:

- ▶  $\mathcal{BF}_m(0) = *$  and  $\mathcal{BF}_m(k)$ , with  $k \geq 1$ , is a smooth manifold with corners, whose interior is  $C(k; \mathbb{R}^m)$  quotiented out by translations.
- ▶ The strata of  $\mathcal{BF}_m(k)$ , with  $k \geq 1$ , are encoded by non-planar trees with section having  $k$  labelled leaves, whose pearls have arity  $\geq 1$ , and all the other vertices are of arity  $\geq 2$ . The codimension of the stratum encoded by a tree with section  $(T; V^p(T))$  is  $|V(T) \setminus V^p(T)|$ .
- ▶ The closure of the stratum encoded by  $(T, V^p(T))$ , denoted by  $\mathcal{BF}_m(T)$ , is homeomorphic to

$$\prod_{p \in V^p(T)} \mathcal{BF}_m(|p|) \times \prod_{v \in V(T) \setminus V^p(T)} \mathcal{F}_m(|v|).$$

Similarly to the infinitesimal bimodule case, one should expect that  $\mathcal{BF}_m$  is a bimodule over  $\mathcal{F}_m$  in the category of semi-algebraic compact spaces. As example, Figure 22 shows a limit configuration in which points 1, 2, 3 have finite non-zero distance to each other. Furthermore, points 4 and 5 collided whereas the distance between 1 and 4 is infinity.

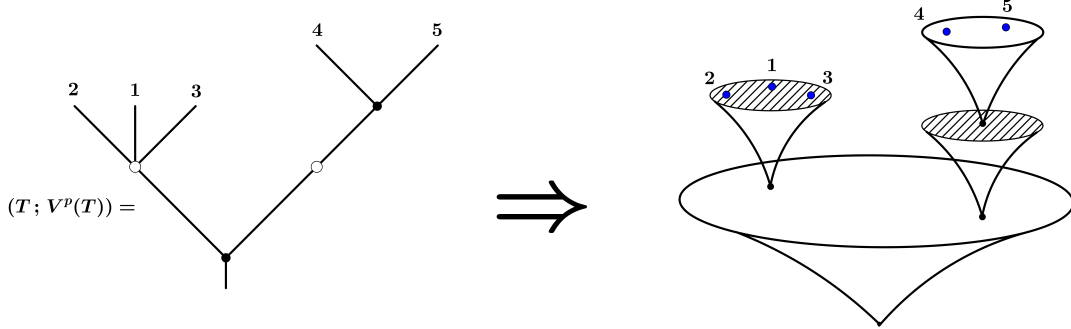

Figure 22: A tree with section  $(T; V^p(T))$  together with an element in the interior of  $\mathcal{BF}_m(T)$ .

One expects that the obvious projections

$$C(k, \mathbb{R}^m) / (\text{translations}) \longrightarrow C(k, \mathbb{R}^m) / (\text{translations} + \text{rescalings}).$$

extend to maps

$$\mu_B: \mathcal{BF}_m(k) \rightarrow \mathcal{F}_m(k)$$

that respect the  $\mathcal{F}_m$ -bimodule structure and thus turn  $\mathcal{BF}_m$  into a Reedy cofibrant replacement of  $\mathcal{F}_m$  as a bimodule over itself.

## 6 Map between the towers

The goal of this section is to construct a map between the towers from Main Theorem 2. The first two subsections are heavily combinatorial. If the reader at any moment feels bored, lost, or annoyed, they are strongly encouraged to look at the last and short Subsection 6.3, which gives a geometrical insight for the constructions of Subsections 6.1-6.2.

### 6.1 An alternative cofibrant replacement of $O$ as $O$ -Ibimodule

In Section 3, we give a functorial way to get cofibrant replacements in the categories of bimodules and infinitesimal bimodules over an operad  $O$ . This allows us to understand the mapping spaces of both towers in (16). However, in order to get an explicit map between the two towers, we need a refined version of this replacement for  $O$  as  $O$ -Ibimodule. The replacements  $\overline{\mathcal{I}b}^\Sigma(O)$  and  $\overline{\mathcal{I}b}^\Lambda(O)$  that we produce in this section topologically are not very much different from the replacements  $\mathcal{I}b^\Sigma(O)$  and  $\mathcal{I}b^\Lambda(O)$ , see for example Theorem 6.3, but combinatorially they are more involved being split in much more smaller pieces.

First, we give a general construction.

**Construction 6.1.** Let  $N$  be an  $O$ -Ibimodule, and  $M$  an  $O$ -bimodule endowed with an  $O$ -bimodules map  $\mu: M \rightarrow O$  and a basepoint  $*_1^M \in M(1)$ , such that  $\mu(*_1^M) = *_1 \in O(1)$ . From these data, we will construct an  $O$ -Ibimodule  $N \ltimes M$ . The sequence  $N \ltimes M$  is defined as a quotient of  $N \circ_O M$ , see Notation 2.2. To recall  $N \circ_O M$  itself is a quotient of  $N \circ M$  by

- i) the relation equalizing the right  $O$ -action on  $N$  and the left  $O$ -action on  $M$ :

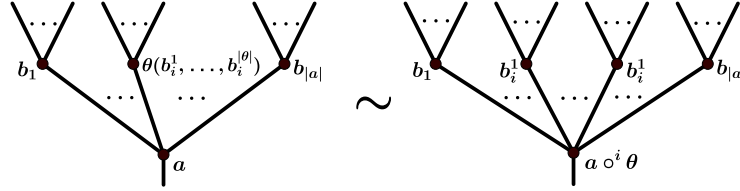

In particular, if  $\theta \in O(0)$  is an arity zero element and  $\gamma_0: O(0) \rightarrow M(0)$  is the arity zero left action, the above relation looks as follows:

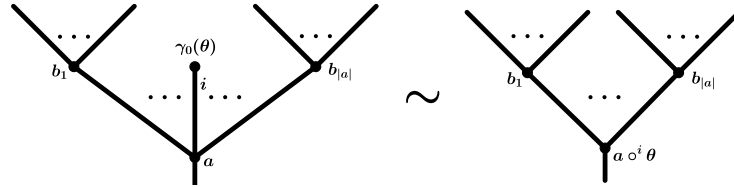

We impose one additional relation on  $N \circ_O M$ .

- ii) For  $\theta \in O$ ,  $a \in N$ , and  $b_1, \dots, b_{|\theta|+|a|-1} \in M$ , and setting  $i' = |b_1| + \dots + |b_{i-1}| + 1$ :

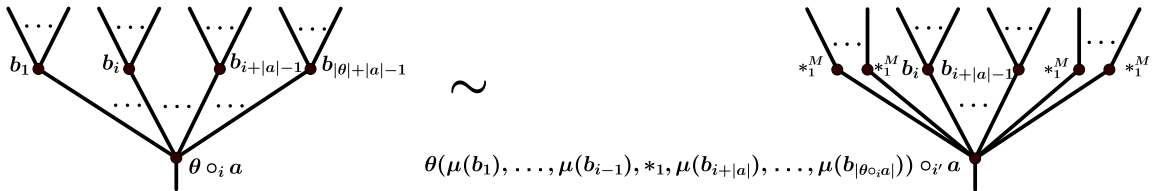

Elements of  $N \ltimes M$  will be denoted as  $[a\{b_1, \dots, b_{|a|}\}; \sigma]$ , where  $a \in N$ ,  $b_1, \dots, b_{|a|} \in M$ ,  $\sigma \in \Sigma_{|b_1| + \dots + |b_{|a|}|}$ , where  $\sigma$  is the labelling of the leaves. The infinitesimal left  $O$ -action on  $N \ltimes M$  is defined as follows:

$$\begin{aligned} \circ_i : \quad O(n) \times N \ltimes M(m) &\longrightarrow N \ltimes M(n+m-1); \\ \theta; [a\{b_1, \dots, b_{|a|}\}; \sigma] &\longmapsto [(\theta \circ_i a) \underbrace{\{\ast_1^M, \dots, \ast_1^M\}}_{i-1}, b_1, \dots, b_{|a|}, \underbrace{\{\ast_1^M, \dots, \ast_1^M\}}_{n-i}]; id_{\Sigma_n} \circ_i \sigma]. \end{aligned}$$

It is easy to see that the formula above enables  $N \circ_O M$  with a well-defined infinitesimal left  $O$ -action. By construction,  $N \circ_O M$  has a right  $O$ -action. It is also straightforward that the relation (ii) respects both these actions and forces the compatibility between them, thus turning  $N \ltimes M$  into an  $O$ -bimodule.

Assuming that  $O$  is reduced, we will be interested in two particular cases:

$$\overline{\mathcal{I}b}^\Sigma(O) := \mathcal{I}b^\Lambda(O) \ltimes \mathcal{B}^\Sigma(O) \quad \text{and} \quad \overline{\mathcal{I}b}^\Lambda(O) := \mathcal{I}b^\Lambda(O) \ltimes \mathcal{B}^\Lambda(O). \quad (74)$$

In both cases we choose the basepoint  $\ast_1^\mathcal{B} \in \mathcal{B}^\Sigma(O)(1)$  and  $\ast_1^\mathcal{B} \in \mathcal{B}^\Lambda(O)(1)$  to be the pearled 1-corolla labelled by  $\ast_1 \in O(1)$ .

Similarly to the previous section, we introduce a filtration in  $\overline{\mathcal{I}b}^\Sigma(O)$  and  $\overline{\mathcal{I}b}^\Lambda(O)$  according to the number of geometrical inputs. We start with  $\overline{\mathcal{I}b}^\Sigma(O)$ . We say that an element is prime if it is not obtained as a result of the  $O$ -action (other than by the action of  $\ast_1 \in O(1)$ ). Let  $x = [a\{b_1, \dots, b_{|a|}\}; \sigma]$  be an element in  $\overline{\mathcal{I}b}^\Sigma(O)$ . Recall that  $a \in \mathcal{I}b^\Lambda(O)$  can be seen as a pearled tree whose all vertices (except the pearl) have arity  $\geq 1$  and are labelled by elements of  $O$  and non-pearl vertices in addition are labelled by numbers in  $[0, 1]$ . Similarly,  $b_i \in \mathcal{B}^\Sigma(O)$  are trees with a section without restriction on the arity of their vertices (except that vertices below the section must have arity  $\geq 1$ ), and whose all vertices are labelled by elements in  $O$  and in addition non-pearls are labelled by numbers in  $[0, 1]$ . Such an element is prime if the two conditions hold:

- the root of  $a$  is a pearl or if it is not a pearl, it is labelled by a number strictly smaller than 1.
- the vertices of  $b_i$ ,  $i = 1, \dots, |a|$ , above the section are all labelled by numbers strictly smaller than 1.

The first condition means that  $x$  is not an image of a non-trivial left  $O$ -action, and the second one means that  $x$  is not an image of a non-trivial right action. If one of the conditions above does not hold, the element is composite. In the latter case, one can assign to  $x$  its prime component by removing the root of  $a$  (in case it is labelled by 1) together with all  $b_i$ , such that the  $i$ -th leaf of  $a$  is directly connected to the root; and, in addition, by removing all vertices from the (non-removed) elements  $b_j$ ,  $j = 1, \dots, |a|$ , that are above the section and are labelled by 1. Figure 23 gives an example of an element and its prime component.

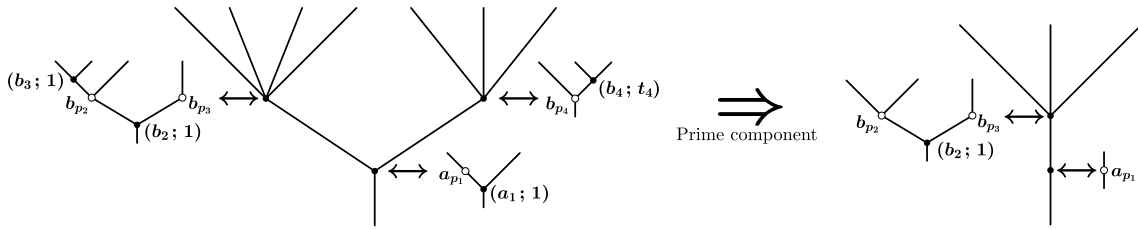

Figure 23: Illustration of a composite point in  $\overline{\mathcal{I}b}^\Sigma(O)$  together with its prime component.

A prime point  $x$  is in the  $k$ -th filtration term  $\overline{\mathcal{I}b}_k^\Sigma(O)$  if its number of geometrical inputs (which is the arity of  $x$  plus the total number of univalent vertices of all  $b_i$ ) is smaller than  $k$ . Similarly, a composite point is in the  $k$ -th filtration term if its prime component is in  $\overline{\mathcal{I}b}_k^\Sigma(O)$ . For instance, the composite point in Figure 23 is an element in the third filtration term. Finally,  $\overline{\mathcal{I}b}_k^\Sigma(O)$  is an infinitesimal bimodule over  $O$  and one has the following filtration in  $\overline{\mathcal{I}b}^\Sigma(O)$ :

$$\overline{\mathcal{I}b}_0^\Sigma(O) \longrightarrow \overline{\mathcal{I}b}_1^\Sigma(O) \longrightarrow \dots \longrightarrow \overline{\mathcal{I}b}_{k-1}^\Sigma(O) \longrightarrow \overline{\mathcal{I}b}_k^\Sigma(O) \longrightarrow \dots \longrightarrow \overline{\mathcal{I}b}^\Sigma(O) \quad (75)$$

**Theorem 6.2.** *Assume that  $O$  is reduced well-pointed and  $\Sigma$ -cofibrant. The objects  $\overline{\mathcal{I}b}^\Sigma(O)$  and  $T_k \overline{\mathcal{I}b}_k^\Sigma(O)$  are cofibrant replacements of  $O$  and  $T_k O$  in the categories  $\Sigma \text{Ibimod}_O$  and  $T_k \Sigma \text{Ibimod}_O$ , respectively.*

*Proof.* We start by checking that the two objects are weakly equivalent to  $O$  and  $T_k O$  respectively. More precisely, we prove that the map  $O(j) \rightarrow \overline{\mathcal{I}b}_k^\Sigma(O)(j)$  sending a point  $\theta \in O$  to the point  $[a\{b_1, \dots, b_{|a|}\}; id]$ , where  $a$  is a pearled corolla labelled by  $\theta$  while all  $b_i = *_1^B$ , is a deformation retract for any  $k \geq j$ . (Note that the image of this map lies in the  $j$ -th filtration term  $O(j) \rightarrow \overline{\mathcal{I}b}_j^\Sigma(O)(j)$ .)

For this purpose, we introduce a map of sequences  $c: O \rightarrow \mathcal{B}^\Sigma(O)$  sending a point  $\theta \in O$  to the point  $[T; \{t_v\}; \{x_v\}]$  in which  $T$  is a planar tree with section such that the root is indexed by the pair  $(\theta; 1)$  while the other vertices are bivalent pearls labelled by the unit  $*_1 \in O(1)$ . We check that the map  $c$  is a homotopy equivalence whose homotopy inverse is the bimodule map  $\mu$ , see (55). We start by contracting the output edges of univalent vertices above the section using the homotopy below. A vertex  $v$  in a tree  $T$  is said *vertically connected to a leaf* if there is a path from  $v$  to a leaf that always goes upward.

$$h: \quad \mathcal{B}^\Sigma(O) \times [0; 1] \quad \longrightarrow \quad \mathcal{B}^\Sigma(O);$$

$$[T; \{t_v\}; \{x_v\}]; t \quad \longmapsto \quad [T; \{t \cdot t_{D(v)} + (1-t) \cdot t_v\}; \{x_v\}],$$

where  $D(v) = v$  for a vertex below the section or a pearl. Otherwise,  $D(v)$  is the first vertex (possibly itself) vertically connected to a leaf in the path joining  $v$  to its closest pearl. By convention, if such vertex does not exist, then  $D(v)$  is the closest pearl and  $t_{D(v)}$  is fixed to be 0. This homotopy pulls down and thus removes all the vertices above the section that are not vertically connected to a leaf. Note that this homotopy preserves filtration.

Applying relation (v) of Construction 3.2, we obtain that the sequence  $\mathcal{B}^\Sigma(O)$  is homotopy equivalent to a sub-sequence (sequence of subobjects)  $\mathcal{B}^\Lambda(O)$  formed by points without univalent vertices. Note that any such element of arity  $i$  lies in the  $i$ -th filtration term, thus for the further retraction we do not need it to preserve filtration.

Then, we contract all the vertices above the section using the homotopy which brings the parameters to 0. Using the axiom (iv) of Construction 3.2, we get that the sequence  $\mathcal{B}^\Sigma(O)$  is homotopy equivalent to the sub-sequence formed by points without vertices above the section and such that the pearls are indexed by the unit  $*_1$ . Finally, we bring the parameters below the section to 1. This proves that  $c$  is a homotopy equivalence. Furthermore, the reader can check that  $T_k c: T_k O \rightarrow T_k \mathcal{B}_k^\Sigma(O)$  is a well defined homotopy equivalence since we contract first the univalent vertices. We denote by  $H$  the homotopy retraction so obtained.

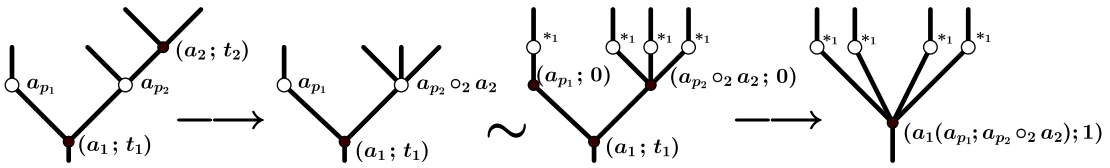

Figure 24: Illustration of the homotopy retraction  $H$ .

We extend the homotopy  $H$  to the sequence  $\overline{\mathcal{I}b}^\Sigma(O)$  by sending a pair  $([a\{b_1, \dots, b_{|a|}\}; \sigma]; t)$  to the element  $[a\{H(b_1; t), \dots, H(b_{|a|}; t)\}; \sigma]$ . This proves that this sequence is weakly equivalence to the sub-sequence formed by points in which the elements  $b_i$  are in the image of  $c$ . In other words, each  $b_i$  is a result of a left  $O_{>0}$  action on the elements  $*_1^B$ . Applying relation (i) of Construction 6.1, this left action can be replaced to the right action on  $a$ . Therefore, the sequence  $\overline{\mathcal{I}b}^\Sigma(O)$  is homotopy equivalent to the sub-sequence formed by points  $[a\{b_1, \dots, b_{|a|}\}; id]$  in which the elements  $b_i = *_1^B$  are corollas indexed by the unit  $*_1$ . Finally, we bring the parameters indexing the vertices of the pearled tree  $a$  to 0. We get that  $\overline{\mathcal{I}b}^\Sigma(O)$  is homotopy equivalent to  $O$ . The reader can check that the same argument works for the truncated case since the homotopy  $H$  for each arity  $j$  preserves the  $k$ -th filtration term,  $k \geq j$ .

The proof of the cofibrancy is obtained similarly by showing that each inclusion in the filtration (75) is a sequence of cell attachments, thus a cofibration, see Appendix A.2 for a proof of a similar statement.  $\square$

### 6.1.1 Homeomorphism between $\mathcal{I}b^\Lambda(O)$ and $\overline{\mathcal{I}b}^\Lambda(O)$ .

Now we will look at the semi-direct product  $\overline{\mathcal{I}b}^\Lambda(O) = \mathcal{I}b^\Lambda(O) \ltimes \mathcal{B}^\Lambda(O)$ . First thing to notice is that if in the general construction of  $N \ltimes M$  one has  $M(0) = *$ , then  $N \circ_O M$  as a symmetric sequence is the same as  $N \circ_{O_{>0}} M_{>0}$ . As a consequence, for the elements  $[a\{b_1, \dots, b_{|a|}\}; \sigma] \in \overline{\mathcal{I}b}^\Lambda(O)$ , one can assume that all  $b_i$  are of positive arity. Note also that  $\mathcal{B}^\Lambda(O)$  can be viewed as an  $(O \circ_{O_{>0}})$ -subbimodule of  $\mathcal{B}^\Sigma(O)$  (as being spanned by trees with section without univalent vertices). Thus,  $\overline{\mathcal{I}b}^\Lambda(O)$  is also an infinitesimal  $O_{>0}$ -subbimodule of  $\overline{\mathcal{I}b}^\Sigma(O)$ . We consider the filtration in  $\overline{\mathcal{I}b}^\Lambda(O)$  induced by this inclusion and filtration (75):

$$\overline{\mathcal{I}b}_0^\Lambda(O) \longrightarrow \overline{\mathcal{I}b}_1^\Lambda(O) \longrightarrow \dots \longrightarrow \overline{\mathcal{I}b}_{k-1}^\Lambda(O) \longrightarrow \overline{\mathcal{I}b}_k^\Lambda(O) \longrightarrow \dots \longrightarrow \overline{\mathcal{I}b}^\Lambda(O). \quad (76)$$

Theorem 6.2 tells us that  $\overline{\mathcal{I}b}^\Sigma(O)$  is a cofibrant replacement of  $O$  as  $O$ -Ibimodule. In the Reedy setting the same statement holds, moreover we actually have a homeomorphism.

**Theorem 6.3.** *For any reduced operad  $O$ , there is a filtration preserving homeomorphism of  $O$ -Ibimodules  $\gamma: \mathcal{I}b^\Lambda(O) \rightarrow \overline{\mathcal{I}b}^\Lambda(O)$ .*

*Proof.* We will build the homeomorphism  $\gamma$  explicitly. Let  $[T; \{a_v\}; \{t_v\}]$  be a point in  $\mathcal{I}b^\Lambda(O)$  and let  $[a\{b_1, \dots, b_{|a|}\}; \sigma]$ , where  $\sigma$  is the permutation labelling the leaves of  $T$ , be its image under  $\gamma$  that we are going to construct. The elements  $a, b_1, \dots, b_{|a|}$  are obtained by taking two cuts in  $[T; \{a_v\}; \{t_v\}]$ . The part below the lower cut produces  $a \in \mathcal{I}b^\Lambda(O)$ , and the connected pieces above the lower cut produce  $b_i$ s. The second cut determines the position of the sections in  $b_i \in \mathcal{B}^\Lambda(O)$ . Both cuts are horizontal in the sense that the path from any leaf to the root must meet each cut exactly once. The lower cut should go above the pearl and thus above all the vertices on the trunk (the path between the pearl and the root). In general position such cut passes only through edges and does not pass through vertices. But if it does, then the vertices on the lower cut can be both considered as ones below the cut (and thus belonging to  $a$ ), or as ones above it (and thus belonging to  $b_i$ ). If we decide to put such vertex below the cut, it would mean that  $a$  is an image of a non-trivial right  $O$ -action; if we put such vertex above, then the corresponding  $b_i$  is an image of a non-trivial left  $O$ -action. The equalizing condition (i) of Construction 6.1 between the left and right actions, would imply that either way produces the same element in  $\overline{\mathcal{I}b}^\Lambda(O)$ . For the upper cut, if it goes through a vertex, then the vertex becomes a pearl of the corresponding  $b_i$ , if it goes through an edge, then in  $b_i$  one replaces this edge by a pearled 1-corolla labelled by  $*_1 \in O(1)$ .

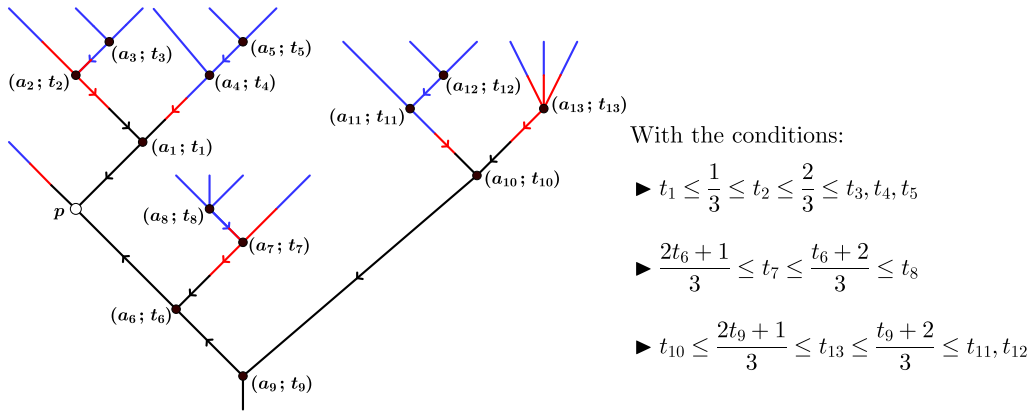

Figure 25: Example of a point in  $\mathcal{I}b^\Lambda(O)$ .

Let  $v$  be a vertex of  $T$  labelled by  $(a_v, t_v)$ . For the pearl  $p$  in the formulas below, we set  $t_p = 0$ . Let  $j(v)$  be the closest to  $v$  vertex on the trunk. We say that  $v$

- is below the first cut if  $t_v < \frac{2t_{j(v)}+1}{3}$ ,
- is on the first cut if  $t_v = \frac{2t_{j(v)}+1}{3}$ ,
- is between the two cuts if  $\frac{2t_{j(v)}+1}{3} < t_v < \frac{t_{j(v)}+2}{3}$ ,
- is on the second cut if  $t_v = \frac{t_{j(v)}+2}{3}$ ,
- is above the second cut if  $t_v > \frac{t_{j(v)}+2}{3}$ .

For a vertex  $j(v)$  on the trunk, we simply divide the segment  $[t_{j(v)}, 1]$  into 3 equal intervals to determine where the 2 cuts pass. Note in particular that these formulas ensure that all the vertices of the trunk are below the first cut. As illustration of this construction, we consider an example in Figure 25.

For every vertex on the first cut we decide whether it is above or below the cut, and then move slightly the cut accordingly. As explained above, the resulting element is always the same regardless of our choice. The point  $a = [T_a; \{a_v^0\}; \{t_v^0\}]$  is given by the subtree  $T_a$  of  $T$  having the vertices  $v$  below the first cut. The points  $\{a_v^0\}$  labelling the vertices of  $T_a$  are the same and the set of real numbers  $\{t_v^0\}$  indexing its vertices is defined by an increasing linear bijection  $\left[ t_{j(v)}, \frac{2t_{j(v)}+1}{3} \right] \rightarrow [t_{j(v)}, 1]$ . Explicitly,  $t_v^0 := 3t_v - 2t_{j(v)}$ .

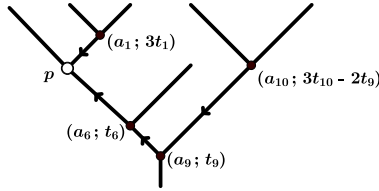

Figure 26: The point  $a$  associated to Figure 25.

For the points  $b_j = [T_j; \{b_v^j\}; \{t_v^j\}] \in \mathcal{B}^\Lambda(O)$ , their corresponding trees are the pieces above the first cut. The pearls of  $T_j$  are the vertices on the upper cut. If the upper cut crosses an edge, as explained above, we create a pearl labelled by  $*_1 \in O(1)$ . Besides these new vertices that we label by  $*_1$ , all the other vertices will be labelled by the same elements  $b_v^j = a_v \in O$ . The numbers  $t_v^j$  are determined as follows: if  $v$  is between the two cuts, one uses the decreasing linear bijection  $\left[ \frac{2t_{j(v)}+1}{3}, \frac{t_{j(v)}+2}{3} \right] \rightarrow [0, 1]$ . If  $v$  is above the second cut, one uses the increasing linear bijection  $\left[ \frac{t_{j(v)}+2}{3}, 1 \right] \rightarrow [0, 1]$ . Explicitly,

$$t_v^j := \begin{cases} \frac{3t_v - t_{j(v)} - 2}{1 - t_{j(v)}}, & \text{if the vertex } v \text{ is above the section;} \\ \frac{3t_v - t_{j(v)} - 2}{t_{j(v)} - 1}, & \text{if the vertex } v \text{ is below the section.} \end{cases}$$

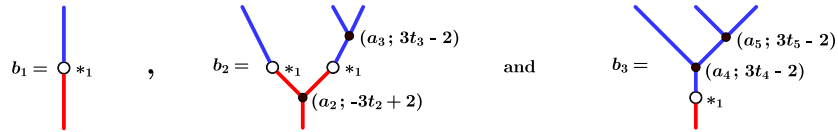

Figure 27: The points  $b_1$ ,  $b_2$  and  $b_3$  associated to Figure 25.



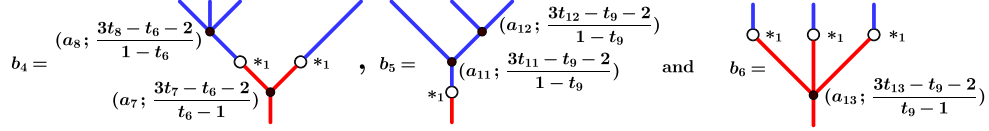

Figure 28: The points  $b_4$ ,  $b_5$  and  $b_6$  associated to Figure 25.

One can easily see that our map  $\gamma$  is well defined and bijective. In particular, one would not need to divide by zero: because of the condition  $t_{s(e)} \geq t_{t(e)}$  on the numbers labelling the vertices and relation (iii) of Construction 3.10, a vertex of the trunk labelled by 1 can only be connected to leaves or other vertices on the trunk. To check that this map is continuous, one can do it first for its inverse map  $\gamma^{-1}$ . Note that its inverse can be similarly defined by “forgetting” the two sections – instead of dividing by numbers that can tend to zero, we will be multiplying by such numbers. Thus the map  $\gamma^{-1}$  is continuous and bijective. We check first that it is a homeomorphism for the commutative operad  $Comm$ . In the latter case  $\mathcal{I}b^\Lambda(Comm)(k)$  is the space of non-planar pearled trees, whose vertices are labelled by numbers and non-pearled vertices have arity  $\geq 2$ . It is a cell complex, and the map  $\gamma_{Comm}^{-1}: \overline{\mathcal{I}b}^\Lambda(Comm)(k) \rightarrow \mathcal{I}b^\Lambda(Comm)(k)$  is a cellular refinement. On the other hand, both spaces  $\overline{\mathcal{I}b}^\Lambda(O)(k)$  and  $\mathcal{I}b^\Lambda(O)(k)$  can be obtained as realizations of cellular cosheaves on  $\overline{\mathcal{I}b}^\Lambda(Comm)(k)$  and  $\mathcal{I}b^\Lambda(Comm)(k)$ , respectively, see Appendix A.3. Moreover, the first cosheaf is homeomorphic to the pullback of the second one obtained along the homeomorphism (refinement)  $\gamma_{Comm}^{-1}$ . We remark, however, that in case  $O(1) \neq *$ , the value of the cocheaf on a cell of  $\mathcal{I}b^\Lambda(Comm)(k)$  is not merely given by the product of  $O(|v|)$ s, but will also account for forgotten under the map  $\mathcal{I}b^\Lambda(O)(k) \rightarrow \mathcal{I}b^\Lambda(Comm)(k)$  bivalent vertices and labelled by the elements of  $O(1)$ . However, one can still apply Lemma A.4 to conclude that the map  $\gamma^{-1}$  is a homeomorphism of realizations of cellular cosheaves. □

**Example 6.4.** Let  $O$  be doubly reduced. Then  $\overline{\mathcal{I}b}^\Lambda(O)(0)$  and  $\overline{\mathcal{I}b}^\Lambda(O)(1)$  have exactly the same combinatorial decomposition as  $\mathcal{I}b^\Lambda(O)(0)$  and  $\mathcal{I}b^\Lambda(O)(1)$ , respectively, see Example 3.16. This is so because all the corresponding pearled trees of arity  $\leq 1$  have all their vertices on the trunk. There are exactly two pearled trees of arity 2 that have a vertex outside the trunk:  $\downarrow_{\circ}^{\circ}$ ,  $\downarrow_{\circ}^{\circ}$ . The corresponding strata of  $\mathcal{I}b^\Lambda(O)(2)$  are subdivided in two in  $\overline{\mathcal{I}b}^\Lambda(O)(2)$ ; the other strata in  $\overline{\mathcal{I}b}^\Lambda(O)(2)$  remain the same, see Figure 29.

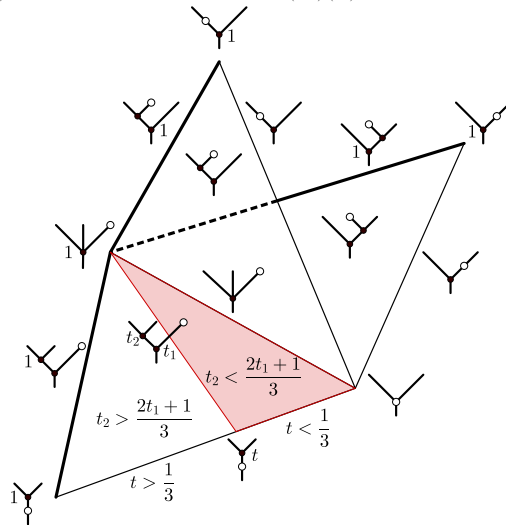

Figure 29: Visualising the space of trees associated to  $\overline{\mathcal{I}b}^\Lambda(O)(2)$ .

## 6.2 Construction of the map

**Theorem 6.5.** *Given a map  $\mathcal{O} \rightarrow M$  of  $O$ -bimodules, where  $O$  is a doubly reduced,  $\Sigma$ -cofibrant topological operad, one has a natural morphism between the towers*

$$\xi_k: \text{Map}_*(\Sigma O(2), \text{T}_k \text{Bimod}_O^h(\text{T}_k O, \text{T}_k M)) \rightarrow \text{T}_k \text{Ibimod}_O^h(\text{T}_k O, \text{T}_k M), \quad k \geq 0, \quad (77)$$

producing at the limit  $k = \infty$ :

$$\xi: \text{Map}_*(\Sigma O(2), \text{Bimod}_O^h(O, M)) \rightarrow \text{Ibimod}_O^h(O, M), \quad (78)$$

which is an equivalence of towers (respectively, equivalence up to stage  $k$ ), provided  $M(0) = *$  and  $O$  is coherent (respectively,  $k$ -coherent).

In this subsection we describe this map  $\xi_\bullet$  explicitly. The theorem is proved in Subsection 7.1. Let us start with a general construction.

**Construction 6.6.** Let  $O$ ,  $M$ , and  $N$  be as in Construction 6.1 of  $N \ltimes M$ . Namely,  $N$  is an  $O$ -Ibimodule,  $M$  is an  $O$ -bimodule endowed with a map  $\mu: M \rightarrow O$  and a basepoint  $*_1^M \in M(1)$  such that  $\mu(*_1^M) = *_1 \in O(1)$ . Let in addition assume that  $O$  is reduced ( $O(0) = \{*_0\}$ ) and one is given a map  $\mu': N \rightarrow O$  of  $O$ -Ibimodules. Assume also that  $K$  is an  $O$ -bimodule endowed with an  $O$ -bimodules map  $\eta: O \rightarrow K$ .

Define  $\partial N(1)$  as the image of the infinitesimal left  $O$ -action  $\circ_1: O(2) \times N(0) \rightarrow N(1)$ . We will construct a map

$$\xi: \text{Map}_*(N(1)/\partial N(1), \text{Bimod}_O(M, K)) \rightarrow \text{Ibimod}_O(N \ltimes M, K). \quad (79)$$

(Note that these are actual mapping spaces, not the derived ones.) Here the basepoint for the space  $\text{Bimod}_O(M, K)$  is  $\eta \circ \mu$ .

Consider the maps

$$\tau_i: N(n) \xrightarrow{j_i} N(1) \xrightarrow{g} N(1)/\partial N(1), \quad 1 \leq i \leq n,$$

where

$$\begin{aligned} j_i: N(n) &\longrightarrow N(1); \\ x &\longmapsto \left( \dots \left( \left( \dots \left( x \circ^n *_0 \right) \dots \right) \circ^{i+1} *_0 \right) \dots \right) \circ^{i-1} *_0 \end{aligned}$$

Equivalently,  $j_i$  is the  $\Lambda$ -map corresponding to the inclusion

$$\underline{1} \hookrightarrow \underline{n}, \quad 1 \mapsto i.$$

Let  $g \in \text{Map}_*(N(1)/\partial N(1), \text{Bimod}_O(M, K))$ , for any element  $[a\{b_1, \dots, b_{|a|}\}; \sigma] \in N \ltimes M$ , we set

$$\xi(g)\left([a\{b_1, \dots, b_{|a|}\}; \sigma\right) = \mu'(a)\left(g(\tau_1(a))(b_1), \dots, g(\tau_{|a|}(a))(b_{|a|})\right) \cdot \sigma. \quad (80)$$

**Lemma 6.7.** *The formula (80) produces a well-defined and continuous map (79).*

*Proof.* Let us check first that (80) produces the same result for different representatives of the same element in  $N \ltimes M$ :

- (80) respects the symmetric group action and the permutation of the  $b_i$ 's as inputs in  $a$  by construction;
- (80) respects the relation (i) of Construction 6.1 because  $\mu': N \rightarrow O$  respects the right  $O$ -action and  $g(t): M \rightarrow K$  respects the left  $O$ -action for any  $t \in N(1)/\partial N(1)$ ;
- (80) respects relation (ii) of Construction 6.1 because  $j_i(a) \in \partial N(1)$  if  $a$  is a result of an infinitesimal left action by some  $x \in O(\ell)$ ,  $\ell \geq 2$ , and  $i$  labels a leaf connected directly to  $x$ .

As a result  $\xi(g): N \ltimes M \rightarrow K$  is a well-defined map of  $\Sigma$  sequences. To see that it is an  $O$ -Ibimodules map, we need to check that it respects the  $O$ -action:

- (80) respects the right  $O$ -action, because each  $g(t): M \rightarrow K$  respects the right action.
- (80) respects the infinitesimal left action by the construction of this action on  $N \ltimes M$  and  $K$  and also because we have again  $\tau_i(a) \in \partial N(1)$  for the corresponding inputs of  $a$ .

Now, let us check that  $\xi$  is continuous. The space  $\text{Ibimod}_O(N \ltimes M, K)$  is topologized as a subspace in the product

$$\prod_{k \geq 0} \text{Map}(N \ltimes M(k), K(k)).$$

Thus, it is enough to check that the projection to each factor is continuous. By Lemma A.1, for a quotient space  $X/\sim$ , the mapping space  $\text{Map}(X/\sim, Y)$  is a subspace of  $\text{Map}(X, Y)$ . The space  $N \ltimes M(k)$  is a quotient of  $N \circ M(k)$ . Thus we should check that the corresponding map to  $\text{Map}(N \circ M(k), K(k))$  is continuous. On the other hand

$$\text{Map}\left(\bigsqcup_{\alpha} X_{\alpha}, Y\right) = \prod_{\alpha} \text{Map}(X_{\alpha}, Y),$$

and  $N \circ M(k)$  is a disjoint union of the components whose elements have the form  $[a\{b_1, \dots, b_{|a|}\}; \sigma]$ , where the arities of  $a$ ,  $b_i$ s, and the shuffle permutation  $\sigma$  are fixed. Thus we are again reduced to show that the projection to each corresponding factor is continuous. But for any such component  $X_{\alpha}$  of  $N \circ M(k)$ , it is an easy exercise that the explicit formula (80) defines a continuous map in the corresponding mapping space  $\text{Map}(X_{\alpha}, K(k))$ . □

Now, let  $O$  and  $M$  be as in Theorem 6.5. We apply Construction 6.6 to  $\overline{\mathcal{I}b}^{\Sigma}(O) = \mathcal{I}b^{\Lambda}(O) \ltimes \mathcal{B}^{\Sigma}(O)$  and  $\overline{\mathcal{I}b}^{\Lambda}(O) = \mathcal{I}b^{\Lambda}(O) \ltimes \mathcal{B}^{\Lambda}(O)$ . Let also  $M \rightarrow M^f$  be a Reedy fibrant replacement of  $M$  as  $O$ -bimodule, which is automatically a Reedy fibrant replacement as  $O$ -Ibimodule. Recall from Example 3.15 that  $\mathcal{I}b^{\Lambda}(O)(1) = C(O(2))$ . It is also easy to see that  $\partial \mathcal{I}b^{\Lambda}(O)(1)$  is the base of this cone.

**Corollary-Definition 6.8.** *One has well-defined and continuous maps*

$$\xi_k^{\Sigma}: \text{Map}_*(\Sigma O(2), \text{T}_k \text{Bimod}_O(\text{T}_k \mathcal{B}_k^{\Sigma}(O), \text{T}_k M)) \rightarrow \text{T}_k \text{Ibimod}_O(\text{T}_k \overline{\mathcal{I}b}_k^{\Sigma}(O), \text{T}_k M), \quad k \geq 0, \quad (81)$$

producing at the limit  $k = \infty$ :

$$\xi^{\Sigma}: \text{Map}_*(\Sigma O(2), \text{Bimod}_O(\mathcal{B}^{\Sigma}(O), M)) \rightarrow \text{Ibimod}_O(\overline{\mathcal{I}b}^{\Sigma}(O), M); \quad (82)$$

and maps

$$\xi_k^{\Lambda}: \text{Map}_*(\Sigma O(2), \text{T}_k \text{Bimod}_O(\text{T}_k \mathcal{B}_k^{\Lambda}(O), \text{T}_k M^f)) \rightarrow \text{T}_k \text{Ibimod}_O(\text{T}_k \overline{\mathcal{I}b}_k^{\Lambda}(O), \text{T}_k M^f), \quad k \geq 0, \quad (83)$$

producing at the limit  $k = \infty$ :

$$\xi^{\Lambda}: \text{Map}_*(\Sigma O(2), \text{Bimod}_O(\mathcal{B}^{\Lambda}(O), M^f)) \rightarrow \text{Ibimod}_O(\overline{\mathcal{I}b}^{\Lambda}(O), M^f), \quad (84)$$

which realize the maps (77) and (78).

The maps  $\xi_k^{\Sigma}$  and  $\xi_k^{\Lambda}$  are defined as truncations of  $\xi^{\Sigma}$  and  $\xi^{\Lambda}$ , the latter being produced by Construction 6.6.

### 6.3 Alternative proof of Main Theorem 1

In this subsection we explain our initial geometric approach for the delooping. The main reason we present it here, it gives some insight on Constructions 6.1 and 6.6 as well as on the proof of Main Theorem 2 given in the next section.

Recall Subsections 5.1 and 5.4, where the infinitesimal bimodule  $\mathcal{IF}_m$  and the bimodule  $\mathcal{BF}_m$  are defined. Thanks to the maps  $\mu_I: \mathcal{IF}_m \rightarrow \mathcal{F}_m$  and  $\mu_B: \mathcal{BF}_m \rightarrow \mathcal{F}_m$  of (infinitesimal) bimodules, Constructions 6.1 and 6.6 can be applied. Elements of the  $\mathcal{F}_m$ -Ibimodule  $\mathcal{IF}_m \times \mathcal{BF}_m$  are configurations of points in  $\mathbb{R}^m$  labelled by elements from  $\mathcal{BF}_m$ . When points collide, the labels get multiplied by means of the left  $\mathcal{F}_m$ -action on  $\mathcal{BF}_m$ . Points can escape to infinity, the labels in the latter case (by the last relation (ii) of Construction 6.1) get shrunken in size by means of the projection  $\mu_B: \mathcal{BF}_m \rightarrow \mathcal{F}_m$ , which is a quotient by rescalings. The space  $\mathcal{IF}_m(1) \cong D^m$  is obtained as compactification of  $C(1, \mathbb{R}^m) = \mathbb{R}^m$ . Thus,  $\mathcal{IF}_m(1)/\partial\mathcal{IF}_m(1) \cong \mathbb{R}^m \cup \{\infty\} \cong S^m$  is the one-point compactification of  $\mathbb{R}^m$ . The map  $\xi$  has also a geometrical description

$$\begin{aligned} \xi: \Omega^m \text{Bimod}_{\mathcal{F}_m}(\mathcal{BF}_m, M^f) &\cong \text{Map}_*(\mathbb{R}^m \cup \{\infty\}, \text{Bimod}_{\mathcal{F}_m}(\mathcal{BF}_m, M^f)) \\ &\longrightarrow \text{Ibimod}_{\mathcal{F}_m}(\mathcal{IF}_m \times \mathcal{BF}_m, M^f). \end{aligned} \quad (85)$$

Let  $g \in \text{Map}_*(\mathbb{R}^m \cup \{\infty\}, \text{Bimod}_{\mathcal{F}_m}(\mathcal{BF}_m, M^f))$  and let  $a \in \mathcal{IF}_m(k)$  and  $b_1, \dots, b_k \in \mathcal{BF}_m$ . For simplicity, let us assume that  $a = (a_1, \dots, a_k) \in C(k, \mathbb{R}^m) \subset \mathcal{IF}_m(k)$  is in the interior. Then the map  $\xi$  applies  $g(a_i)$  to each  $b_i$ , and then get them multiplied by means of the left action by  $\mu_I(a) \in \mathcal{F}_m(k)$ :

$$\xi(g)([a\{b_1, \dots, b_k\}; \sigma]) = \mu_I(a)(g(a_1)(b_1), \dots, g(a_k)(b_k)) \cdot \sigma.$$

Our initial idea of the proof was to use the map (85) and to show that it is an equivalence. One would need to show that  $\mathcal{IF}_m \times \mathcal{BF}_m$  is homeomorphic to  $\mathcal{IF}_m$  as an  $(\mathcal{F}_m)_{>0}$ -Ibimodule. One has a map  $\zeta: \mathcal{IF}_m(1) \times \mathcal{BF}_m(k) \rightarrow \mathcal{IF}_m \times \mathcal{BF}_m(k)$ ,  $(a, b) \mapsto a\{b\}$ . Note that both the source and the target are manifolds of the same dimension  $mk$ . An important step in the proof is to show that  $\mathcal{IF}_m \times \mathcal{BF}_m(k)$  private the interior of the image of  $\zeta$  deformation retracts on the boundary  $\partial(\mathcal{IF}_m \times \mathcal{BF}_m(k))$ .

Eventually we realized that this geometrical construction of  $\times$  works in a more general context and in particular can be nicely applied to the Boardman-Vogt type replacements. We reiterate that we conjecture that  $\mathcal{IF}_m$  and  $\mathcal{BF}_m$  are homeomorphic to  $\mathcal{I}b^\Lambda(\mathcal{F}_m)$  and  $\mathcal{B}^\Lambda(\mathcal{F}_m)$ , respectively, as (infinitesimal)  $(\mathcal{F}_m)_{>0}$ -bimodules, and thus the construction that we finally use should not be much different from the initial geometrical one.

## 7 Proof of Main Theorems 2 and 3

In the first subsection we prove Main Theorem 2 in the special case of a strongly doubly reduced operad  $O$ , which is Theorem 6.5. In the second subsection, using homotopy theory methods, we complete the proof of our theorem by generalizing it to the case of any weakly doubly reduced operad. In the third subsection we describe different explicit maps realizing the equivalence of the theorem. In the last subsection we formulate and sketch a proof of a more general statement – Main Theorem 3.

### 7.1 Main Theorem 2. Special case: $O$ is doubly reduced

To prove Theorem 6.5, we constructed in Subsection 6.2 an explicit map of towers:

$$\xi_k^\Lambda: \text{Map}_*(\Sigma O(2), \text{T}_k \text{Bimod}_O(\text{T}_k \mathcal{B}^\Lambda(O), \text{T}_k M^f)) \rightarrow \text{T}_k \text{Ibimod}_O(\text{T}_k \overline{\mathcal{I}b}^\Lambda(O), \text{T}_k M^f), \quad (86)$$

where  $M \xrightarrow{\cong} M^f$  is a Reedy fibrant replacement of  $M$  as  $O$ -bimodule. In this subsection we show that if  $O$  is  $k$ -coherent, (86) is a weak equivalence. The proof is by induction over  $k$ . To simplify notation, the source of

$\xi_k^\Lambda$  will be denoted by

$$T_k \mathcal{B} := \text{Map}_*(\Sigma O(2), T_k \text{Bimod}_O(T_k \mathcal{B}^\Lambda(O), T_k M^f)),$$

and the target by

$$T_k \mathcal{I} := T_k \text{Ibimod}_O(T_k \overline{\mathcal{I}b}^\Lambda(O), T_k M^f).$$

Without loss of generality and also to simplify notation, we will be assuming that  $M$  is already Reedy fibrant  $M = M^f$ .

**Initialization:**  $k = 0$  and  $1$ . For  $k = 0$ , it is easy to see that  $T_0 \mathcal{B} = T_0 \mathcal{I} = *$ , because  $\mathcal{B}^\Lambda(O)(0) = \overline{\mathcal{I}b}^\Lambda(O)(0) = M(0) = *$ . For  $k = 1$ , the map  $\xi_1^\Lambda$  is always a homeomorphism, that's why the condition of 1-coherence is vacuous. Indeed,  $\mathcal{B}^\Lambda(O)(1) = *$ , see Example 3.8, and the space

$$T_1 \text{Bimod}_O(T_1 \mathcal{B}^\Lambda(O), T_1 M) \cong \text{Map}(*, M(1)) = M(1).$$

Thus,  $T_1 \mathcal{B} \cong \text{Map}_*(\Sigma O(2), M(1))$ , where  $M(1)$  is pointed at  $*_1^M := \eta(*_1)$  (recall that one has a map  $\eta: O \rightarrow M$  of  $O$ -bimodules). One also has  $\overline{\mathcal{I}b}^\Lambda(O)(1) \cong C(O(2))$  is the cone with the base  $\partial \overline{\mathcal{I}b}^\Lambda(O)(1) \cong O(2)$ , see Examples 3.15 and 6.4. Therefore,  $T_1 \mathcal{I}$  is a space of maps

$$\overline{\mathcal{I}b}^\Lambda(O)(1) \rightarrow M(1)$$

with prescribed behavior on  $\partial \overline{\mathcal{I}b}^\Lambda(O)(1)$ . Let  $\theta_{\circ_1} *_0^{\mathcal{I}} \in \partial \overline{\mathcal{I}b}^\Lambda(O)(1)$ , where  $\theta \in O(2)$ , and  $*_0^{\mathcal{I}}$  is the only point of  $\overline{\mathcal{I}b}^\Lambda(O)(0)$ . For any map of 1-truncated  $O$ -Ibinodules  $f: T_1 \overline{\mathcal{I}b}^\Lambda(O) \rightarrow T_1 M$ , one has

$$f(\theta_{\circ_1} *_0^{\mathcal{I}}) = \theta_{\circ_1} f(*_0^{\mathcal{I}}) = \theta_{\circ_1} *_0^M = \theta_{\circ_1} \eta(*_0) = \theta(\eta(*_0), \eta(*_1)) = \eta(\theta(*_0, *_1)) = \eta(*_1) = *_1^M.$$

The first equality is because  $f$  respects the infinitesimal left  $O$  action by  $\theta$ ; the second and third ones are because  $M(0)$  has only one point  $*_0^M$ ; the fourth one is the definition of the infinitesimal left  $O$  action on  $M$ , see Example 1.8; the fifth one is because  $\eta$  respects the left  $O$  action by  $\theta$ ; the sixth one is because  $O(1) = *$ .

Thus,  $T_1 \mathcal{I}$  is also homeomorphic to  $\text{Map}_*(\Sigma O(2), M(1))$ . Note that all elements of  $\overline{\mathcal{I}b}^\Lambda(O)(1)$  have the form  $[a\{*_1^{\mathcal{B}}\}, id] = a\{*_1^{\mathcal{B}}\}$ , where  $a \in \mathcal{I}b^\Lambda(O)(1) = C(O(2))$  and  $*_1^{\mathcal{B}}$  is the only point of  $\mathcal{B}^\Lambda(O)(1)$ . Given  $g \in T_1 \mathcal{B} \cong \text{Map}_*(\Sigma O(2), M(1))$ , one has that  $\xi_1^\Lambda(g) \in T_1 \mathcal{I}$  sends

$$a\{*_1^{\mathcal{B}}\} \mapsto \mu'(a)(g(\tau_1(a))(*_1^{\mathcal{B}})) = g(a)(*_1^{\mathcal{B}}).$$

One has  $\mu'(a) = *_1$  is the only element in  $O(1)$ , so we can ignore its action; and  $\tau_1(a) = a$ . Finally,  $g(a)(*_1^{\mathcal{B}})$  is exactly the image of the element  $a \in \mathcal{I}b^\Lambda(O)(1) = C(O(2))$  under the map

$$C(O(2)) \rightarrow \Sigma O(2) \xrightarrow{g} M(1).$$

This completes the proof that  $\xi_1^\Lambda$  is a homeomorphism.

**Induction step.** Assuming that the map  $\xi_{k-1}^\Lambda$  is an equivalence and that  $O$  is  $k$ -coherent, we show that  $\xi_k^\Lambda$  is a weak equivalence.

**Proposition 7.1.** *The maps between the stages of the towers  $\pi_k^{\mathcal{I}}: T_k \mathcal{I} \rightarrow T_{k-1} \mathcal{I}$ ,  $\pi_k^{\mathcal{B}}: T_k \mathcal{B} \rightarrow T_{k-1} \mathcal{B}$  are Serre fibrations.*

We prove this proposition at the end of this subsection.

One has a morphism of fiber sequences

$$\begin{array}{ccccc} F_1 & \longrightarrow & T_k \mathcal{B} & \xrightarrow{\pi_k^{\mathcal{B}}} & T_{k-1} \mathcal{B} \\ \downarrow & & \downarrow \xi_k^\Lambda & & \downarrow \xi_{k-1}^\Lambda \\ F & \longrightarrow & T_k \mathcal{I} & \xrightarrow{\pi_k^{\mathcal{I}}} & T_{k-1} \mathcal{I} \end{array} \quad , \quad (87)$$

where  $F_1$  is the fiber over some  $g \in T_{k-1}\mathcal{B}$ , and  $F$  is the fiber over  $\xi_{k-1}^\Lambda(g)$ . Since  $\xi_{k-1}^\Lambda$  is an equivalence by induction hypothesis, to prove that  $\xi_k^\Lambda$  is so, it is enough to show that the map between the fibers  $F_1 \rightarrow F$  is an equivalence for any choice of  $g$ . We will describe the fibers  $F$  and  $F_1$  as certain spaces of section extensions.

For a Serre fibration  $\pi: E \rightarrow B$ , denote by  $\Gamma(\pi; B)$  the space of global sections of  $\pi$ . For  $A \subset B$ , and a partial section  $s: A \rightarrow E$ , denote by  $\Gamma_s(\pi; B, A)$  the space of sections  $f: B \rightarrow E$ , which extend  $s$ , i.e.  $f|_A = s$ .

In order to avoid heavy notation, below, every map induced (or determined) by  $g$  is denoted by  $g_*$ . It should not be understood as a name of a map, but rather as a label “made by  $g$ ”. We will be always explicit a map between which spaces is discussed to avoid any confusion.

The fiber  $F$  is a space of  $\Sigma_k$ -equivariant maps

$$f: \overline{\mathcal{I}b}^\Lambda(O)(k) \rightarrow M(k) \quad (88)$$

satisfying two conditions. First, it is determined by  $g$  on all non-prime elements, i.e. on  $\partial\overline{\mathcal{I}b}^\Lambda(O)(k)$  — one applies  $\xi_{k-1}^\Lambda(g)$  on their prime component and then the  $O$ -action to see what their image in  $M(k)$  should be. Secondly, it should respect the  $\Lambda$ -structure, i.e. the right action by  $O(0)$ . The first condition means that the upper triangle in the square below must commute:

$$\begin{array}{ccc} \partial\overline{\mathcal{I}b}^\Lambda(O)(k) & \xrightarrow{g_*} & M(k) \\ \downarrow & \searrow f & \downarrow \\ \overline{\mathcal{I}b}^\Lambda(O)(k) & \xrightarrow{g_*} & M(M)(k) \end{array} \quad (89)$$

And the second condition translates that the lower triangle in (89) must commute. Here, the right arrow is the matching map, which is a fibration as we assumed that  $M$  is Reedy fibrant. The lower map is a composition

$$\overline{\mathcal{I}b}^\Lambda(O)(k) \rightarrow M(\overline{\mathcal{I}b}^\Lambda(O))(k) \xrightarrow{g_*} M(M)(k),$$

where the first arrow is the matching map, and the second one is  $M(g)(k)$ .

Consider the pullback of the right map of (89) along its lower one. We get a fibration of  $\Sigma_k$ -spaces

$$\pi: E \rightarrow \overline{\mathcal{I}b}^\Lambda(O)(k).$$

Since  $\overline{\mathcal{I}b}^\Lambda(O)(k)$  is  $\Sigma_k$ -cofibrant, and the property of being Serre fibration is local,

$$\pi/\Sigma_k: E/\Sigma_k \rightarrow \overline{\mathcal{I}b}^\Lambda(O)(k)/\Sigma_k$$

is still a Serre fibration. It is easy to see that  $F$  is the space of section extensions:

$$F = \Gamma_{g_*}(\pi/\Sigma_k; \overline{\mathcal{I}b}^\Lambda(O)(k)/\Sigma_k, \partial\overline{\mathcal{I}b}^\Lambda(O)(k)/\Sigma_k), \quad (90)$$

where by  $g_*$  we denote the section  $\partial\overline{\mathcal{I}b}^\Lambda(O)(k)/\Sigma_k \rightarrow E/\Sigma_k$  induced by the upper map of (89).

The points of  $F_1$  can similarly be described as the space of  $\Sigma_k$ -equivariant maps

$$f_1: \mathcal{I}b^\Lambda(O)(1) \times \mathcal{B}^\Lambda(O)(k) \rightarrow M(k) \quad (91)$$

making the two triangles in the diagram

$$\begin{array}{ccc} \partial(\mathcal{I}b^\Lambda(O)(1) \times \mathcal{B}^\Lambda(O)(k)) & \xrightarrow{g_*} & M(k) \\ \downarrow & \searrow f_1 & \downarrow \\ \mathcal{I}b^\Lambda(O)(1) \times \mathcal{B}^\Lambda(O)(k) & \xrightarrow{g_*} & M(M)(k) \end{array} \quad (92)$$

commute, where

$$\partial(\mathcal{I}b^\Lambda(O)(1) \times \mathcal{B}^\Lambda(O)(k)) = \partial\mathcal{I}b^\Lambda(O)(1) \times \mathcal{B}^\Lambda(O)(k) \bigcup \mathcal{I}b^\Lambda(O)(1) \times \partial\mathcal{B}^\Lambda(O)(k).$$

We use this notation later in this subsection. Here,  $\partial\mathcal{B}^\Lambda(O)(k) = \mathcal{B}_{k-1}^\Lambda(O)(k) \subset \mathcal{B}^\Lambda(O)(k)$  is the subspace of non-prime elements.

On the first part of the boundary the upper map of (92) is the composition

$$\partial\mathcal{I}b^\Lambda(O)(1) \times \mathcal{B}^\Lambda(O)(k) \xrightarrow{pr_2} \mathcal{B}^\Lambda(O)(k) \xrightarrow{\mu} O(k) \xrightarrow{\eta} M(k).$$

On the second part, this map

$$\mathcal{I}b^\Lambda(O)(1) \times \partial\mathcal{B}^\Lambda(O)(k) \xrightarrow{g^*} M(k)$$

is determined by the fact that for any  $x \in \mathcal{I}b^\Lambda(O)(1)$ , the map  $g(x)$  is a map of  $(k-1)$ -truncated  $O$ -bimodules and thus can be uniquely extended to a map of  $O$ -bimodules  $\mathcal{B}_{k-1}^\Lambda(O) \rightarrow M$ , see (54).

Now let  $\tilde{g} \in F_1$ . Its arity  $\leq (k-1)$  part is  $g$ , and the arity  $k$  part is  $f_1$  which makes commute (92). Define the subspace  $\partial_1 \overline{\mathcal{I}b}^\Lambda(O)(k) \subset \overline{\mathcal{I}b}^\Lambda(O)(k)$  to contain  $\partial \overline{\mathcal{I}b}^\Lambda(O)(k)$  together with all the elements of the form  $[a\{b_1, \dots, b_{|a|}\}; \sigma]$ ,  $|a| \geq 2$ . We claim that the arity  $k$  part of  $\xi_k^\Lambda(\tilde{g}) \in F$  is uniquely determined by  $g$  on  $\partial_1 \overline{\mathcal{I}b}^\Lambda(O)(k)$ . Indeed,  $\xi_k^\Lambda(\tilde{g})$  sends  $[a\{b_1, \dots, b_{|a|}\}; \sigma]$  to

$$\mu'(a)(\tilde{g}(\tau_1(a))(b_1), \dots, \tilde{g}(\tau_{|a|}(a))(b_{|a|})) \cdot \sigma = \begin{cases} \mu'(a)(g(\tau_1(a))(b_1), \dots, g(\tau_{|a|}(a))(b_{|a|})) \cdot \sigma & |a| \geq 2; \\ f_1(a, b_1) & |a| = 1. \end{cases} \quad (93)$$

by the fact that  $|b_i| \leq k-1$  for all  $i = 1 \dots |a|$  if  $|a| \geq 2$ , and in case  $|a| = 1$  one has  $\mu'(a) = *_1$  and thus its action can be ignored.

Thus  $\xi_k^\Lambda$  sends  $F_1$  onto the subspace of  $F$  described as the space of  $\Sigma_k$ -equivariant maps (88) making the diagram

$$\begin{array}{ccc} \partial_1 \overline{\mathcal{I}b}^\Lambda(O)(k) & \xrightarrow{g^*} & M(k) \\ \downarrow & \nearrow f & \downarrow \\ \overline{\mathcal{I}b}^\Lambda(O)(k) & \xrightarrow{g^*} & M(M)(k) \end{array} \quad (94)$$

commute. We claim that this subspace of  $F$  is exactly the image of  $F_1$  and moreover  $\xi_k^\Lambda|_{F_1}$  is a homeomorphism on its image. To prove it we construct the inverse. Let  $\zeta$  be the map

$$\zeta: \begin{array}{ccc} \mathcal{I}b^\Lambda(O)(1) \times \mathcal{B}^\Lambda(O)(k) & \longrightarrow & \overline{\mathcal{I}b}^\Lambda(O)(k); \\ (a, b) & \longmapsto & a\{b\}. \end{array}$$

Let us check that

$$\zeta(\partial(\mathcal{I}b^\Lambda(O)(1) \times \mathcal{B}^\Lambda(O)(k))) \subset \partial_1 \overline{\mathcal{I}b}^\Lambda(O)(k). \quad (95)$$

Recall that  $\partial \overline{\mathcal{I}b}^\Lambda(O)(k)$  consists of elements  $[a\{b_1, \dots, b_{|a|}\}; \sigma]$ , for which either  $a$  is the image of the arity  $\geq 2$  infinitesimal left  $O$ -action, or one of  $b_i$  is the image of the arity  $\geq 2$  right  $O$ -action. As a consequence

$$\zeta(\partial\mathcal{I}b^\Lambda(O)(1) \times \mathcal{B}^\Lambda(O)(k)) \subset \partial \overline{\mathcal{I}b}^\Lambda(O)(k) \subset \partial_1 \overline{\mathcal{I}b}^\Lambda(O)(k).$$

One has

$$\partial\mathcal{B}^\Lambda(O)(k) = \partial_l \mathcal{B}^\Lambda(O)(k) \cup \partial_r \mathcal{B}^\Lambda(O)(k),$$

where  $\partial_l$ , respectively  $\partial_r$ , is the image of the arity  $\geq 2$  left, respectively right,  $O$ -action. One similarly has

$$\zeta(\mathcal{I}b^\Lambda(O)(1) \times \partial_r \mathcal{B}^\Lambda(O)(k)) \subset \partial \overline{\mathcal{I}b}^\Lambda(O)(k).$$



Using relation (i) of Construction 6.1 (right-left action equalizing), we get

$$\zeta\left(\mathcal{I}b^\Lambda(O)(1)\times\partial_1\mathcal{B}^\Lambda(O)(k)\right)\subset\partial_1\overline{\mathcal{I}b}^\Lambda(O)(k).$$

Given  $f$  that makes commute (94), we define  $f_1 := f \circ \zeta$ . Using (93) for the case  $|a| = 1$  and (95), one easily checks that this assignment produces the inverse of  $\xi_k^\Lambda|_{F_1}$ .

We get that  $F_1 \cong \xi_k^\Lambda(F_1) \subset F$  can also be described as a space of section extensions similarly to (90), and the inclusion  $F_1 \rightarrow F$  in these terms is described as

$$\Gamma_{g_*}\left(\pi/\Sigma_k; \overline{\mathcal{I}b}^\Lambda(O)(k)/\Sigma_k, \partial_1\overline{\mathcal{I}b}^\Lambda(O)(k)/\Sigma_k\right) \hookrightarrow \Gamma_{g_*}\left(\pi/\Sigma_k; \overline{\mathcal{I}b}^\Lambda(O)(k)/\Sigma_k, \partial\overline{\mathcal{I}b}^\Lambda(O)(k)/\Sigma_k\right). \quad (96)$$

The theorem now follows from a lemma and a proposition.

**Lemma 7.2.** *Given a Serre fibration  $\pi: E \rightarrow B$ , cofibrant inclusions  $X \subset Y \subset Z$  with  $X$  cofibrant, and with  $X \subset Y$  a weak equivalence, for any partial section  $s: Y \rightarrow E$ , the natural inclusion*

$$\Gamma_s(\pi; Z, Y) \hookrightarrow \Gamma_s(\pi; Z, X)$$

*is a weak equivalence.*

**Proposition 7.3.** *If  $O$  is a doubly reduced and  $k$ -coherent operad, the inclusion  $\partial\overline{\mathcal{I}b}^\Lambda(O)(k) \hookrightarrow \partial_1\overline{\mathcal{I}b}^\Lambda(O)(k)$  is a weak equivalence.*

To finish the proof of the theorem we notice that both spaces  $\partial\overline{\mathcal{I}b}^\Lambda(O)(k)$  and  $\partial_1\overline{\mathcal{I}b}^\Lambda(O)(k)$  are  $\Sigma_k$ -cofibrant. Therefore, their quotients by  $\Sigma_k$  are equivalent to their homotopy quotients and by Proposition 7.3 these quotients are equivalent to each other. We then apply Lemma 7.2 to conclude that the map  $F_1 \rightarrow F$  is an equivalence.  $\square$

*Proof of Lemma 7.2.* One has a morphism of fiber sequences:

$$\begin{array}{ccccc} \Gamma_s(\pi; Z, Y) & \longrightarrow & \Gamma(\pi; Z) & \longrightarrow & \Gamma(\pi; Y) \\ \downarrow & & \parallel & & \downarrow \simeq \\ \Gamma_s(\pi; Z, X) & \longrightarrow & \Gamma(\pi; Z) & \longrightarrow & \Gamma(\pi; X) \end{array} \quad (97)$$

Since  $X \hookrightarrow Y$  is a trivial cofibration, the right arrow is a trivial fibration. As a consequence, the left arrow, i.e. map between the fibers, is also an equivalence.  $\square$

*Proof of Proposition 7.3.* Instead of the initial Definition 4.4 of  $k$ -coherence, we will be using equivalent to it condition that the maps

$$\partial\mathcal{I}b^\Lambda(O)(i) \hookrightarrow \partial'\mathcal{I}b^\Lambda(O)(i), \quad 2 \leq i \leq k,$$

are equivalences, see Remark 4.15. Recall also the homeomorphism

$$\gamma_k: \mathcal{I}b^\Lambda(O)(k) \xrightarrow{\cong} \overline{\mathcal{I}b}^\Lambda(O)(k) \quad (98)$$

constructed in Subsubsection 6.1.1. Since  $\gamma_k$  is filtration preserving, it sends  $\partial\mathcal{I}b^\Lambda(O)(k)$  homeomorphically onto  $\partial\overline{\mathcal{I}b}^\Lambda(O)(k)$ . Denote by  $\partial_1\mathcal{I}b^\Lambda(O)(k) := \gamma_k^{-1}\left(\partial_1\overline{\mathcal{I}b}^\Lambda(O)(k)\right)$ . We claim that  $\partial'\mathcal{I}b^\Lambda(O)(k)$  is a deformation retract of  $\partial_1\mathcal{I}b^\Lambda(O)(k)$ , which implies the statement of our proposition. To recall,  $\partial'\mathcal{I}b^\Lambda(O)(k)$  consists of two (non-disjoint) types of elements:

- ▶ elements in  $\partial\mathcal{I}b^\Lambda(O)(k)$ ;
- ▶ elements labelled by pearled trees from  $\Psi_k^U$

Recall Definitions 4.5, 4.6. The trees from  $\Psi_k^U$  are exactly those whose trunk has arity  $\geq 2$ . The trees from  $\Psi_k \setminus \Psi_k^U$ , i.e. trees whose trunk has arity one, are of two types: either its root is pearled and has arity one, or its root has arity two and it is connected to a univalent pearl:



In both cases there is only one non-pearl vertex, that we denote by  $W$ , connected to the root. The elements of  $\partial_1 \mathcal{I}b^\Lambda(O)(k)$  are of three (non-disjoint) types:

- ▶ elements in  $\partial \mathcal{I}b^\Lambda(O)(k)$ ;
- ▶ elements labelled by pearled trees from  $\Psi_k^U$ ;
- ▶ elements labelled by pearled trees from  $\Psi_k \setminus \Psi_k^U$ , and whose only non-pearl vertex  $W$  connected to the root  $r$  is labelled by  $t_W \leq \frac{2t_r+1}{3}$  (as before, if  $r = p$ , we set  $t_r = 0$ ).

Indeed, elements of  $\partial_1 \mathcal{I}b^\Lambda(O)(k)$  are either from  $\partial \mathcal{I}b^\Lambda(O)(k)$  (first type) or are preimages under  $\gamma_k$  of  $[a\{b_1, \dots, b_{|a|}\}; \sigma]$ , with  $|a| \geq 2$ . The latter type of elements are those in  $\mathcal{I}b^\Lambda(O)(k)$  for which the lower cut of the homeomorphism  $\gamma_k$  either crosses at least two edges or, as a limit case, at least one vertex. If an element in  $\mathcal{I}b^\Lambda(O)(k)$  is labelled by a tree  $T \in \Psi_k^U$  whose trunk has arity  $\geq 2$ , this condition is always satisfied. If it is labelled by a tree  $T \in \Psi_k \setminus \Psi_k^U$  whose trunk has arity one, this condition is satisfied only if the lower cut goes through or above  $W$ , which is exactly given by the inequality of the type 3 points.

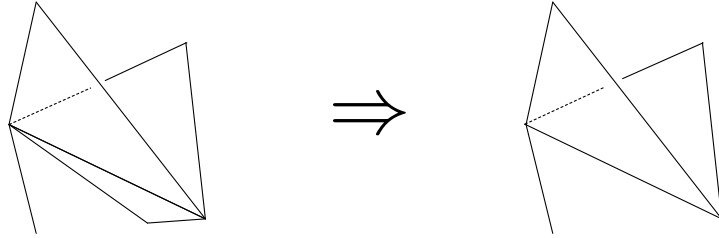

Figure 30: Deformation retraction of  $\partial_1 \mathcal{I}b^\Lambda(O)(2)$  onto  $\partial' \mathcal{I}b^\Lambda(O)(2)$ .

We define a deformation retraction  $H$  of  $\partial_1 \mathcal{I}b^\Lambda(O)(k)$  onto  $\partial' \mathcal{I}b^\Lambda(O)(k)$  as follows.  $H$  is set to be identity on the elements of  $\partial_1 \mathcal{I}b^\Lambda(O)(k)$  of the first and second type, and it is defined as

$$H[T; \{a_v\}; \{t_v\}] = [T; \{a_v\}; \{h(t, t_v)\}]$$

on the elements of the third type. Let

$$t_{max} := \text{Max}_{v \in V(T)}(t_v).$$

one has  $t_r \leq t_W \leq t_{max} \leq 1$ . In particular if  $t_{max} = 1$  or  $t_W = t_r$  the homotopy  $h(t, -)$  is the constant identity since such element lies already in  $\partial' \mathcal{I}b^\Lambda(O)(k)$ . In general, for any  $t \in [0, 1]$ ,  $h(t, -)$  is linear on  $[t_W, t_{max}]$  and  $h(t, t_r) = t_r$ . It starts by pulling the left end  $t_W$  toward the root:

$$h(t, t_W) = t_W + t(t_r - t_W),$$

while expanding the length of the image of  $[t_W, t_{max}]$ :

$$h(t, t_{max}) - h(t, t_W) = (1 + t)(t_{max} - t_W);$$

in case  $h(t, t_{max})$  reaches 1, the homotopy stops. It is easy to compute that the latter case happens when  $t_{max} - t_W \geq \frac{1-t_r}{2}$ , and this happens at

$$t = \frac{1 - t_{max}}{t_{max} - 2t_W + t_r}.$$

Otherwise the homotopy continues until  $t = 1$ , in which case the edge  $(r, W)$  gets contracted. The condition  $t_W \leq \frac{2t_r+1}{3}$  implies  $1 - t_W \geq \frac{2}{3}(1 - t_r) > \frac{1-t_r}{2}$ . Thus when  $t_{max}$  approaches 1, the homotopy gets closer and closer to the constant identity. We conclude that the homotopy  $H$  is continuously defined. Figure 30 shows how the retraction works for  $k = 2$ , compare with Figure 29. □

*Proof of Proposition 7.1.* We need a lemma which is an easy exercise. (Hint: use Lemma A.3.)

**Lemma 7.4.** *Let  $G$  be a finite group. Consider the projective model structure in  $\text{Top}^G$ . If  $X \hookrightarrow Y$  is a cofibration in  $\text{Top}^G$  with  $X$  cofibrant, and  $E \rightarrow B$  is a fibration in  $\text{Top}^G$ , then the following map is a Serre fibration*

$$\text{Map}_G(Y, E) \rightarrow \text{Map}_G(Y, B) \times_{\text{Map}_G(X, B)} \text{Map}_G(X, E).$$

One has two pullback squares:

$$\begin{array}{ccc} \mathbb{T}_k \mathcal{I} & \longrightarrow & \text{Map}_{\Sigma_k}(\overline{\mathcal{I}b^\Lambda}, M) \\ \downarrow & & \downarrow \\ \mathbb{T}_{k-1} \mathcal{I} & \longrightarrow & \text{Map}_{\Sigma_k}(\overline{\mathcal{I}b^\Lambda}, M(M)) \times_{\text{Map}_{\Sigma_k}(\partial \overline{\mathcal{I}b^\Lambda}, M(M))} \text{Map}_{\Sigma_k}(\partial \overline{\mathcal{I}b^\Lambda}, M) \end{array}$$
  

$$\begin{array}{ccc} \mathbb{T}_k \mathcal{B} & \longrightarrow & \text{Map}_{\Sigma_k}(\mathcal{I}b^\Lambda(1) \times \mathcal{B}^\Lambda, M) \\ \downarrow & & \downarrow \\ \mathbb{T}_{k-1} \mathcal{B} & \longrightarrow & \text{Map}_{\Sigma_k}(\mathcal{I}b^\Lambda(1) \times \mathcal{B}^\Lambda, M(M)) \times_{\text{Map}_{\Sigma_k}(\partial(\mathcal{I}b^\Lambda(1) \times \mathcal{B}^\Lambda), M(M))} \text{Map}_{\Sigma_k}(\partial(\mathcal{I}b^\Lambda(1) \times \mathcal{B}^\Lambda), M) \end{array}$$

Here for shortness,  $\overline{\mathcal{I}b^\Lambda}$ ,  $\mathcal{B}^\Lambda$ ,  $\mathcal{I}b^\Lambda(1)$ ,  $M$ ,  $M(M)$  stay for  $\overline{\mathcal{I}b^\Lambda}(O)(k)$ ,  $\mathcal{B}^\Lambda(O)(k)$ ,  $\mathcal{I}b^\Lambda(O)(1)$ ,  $M(k)$ ,  $M(M)(k)$ , respectively. By Lemma 7.4, the right arrows in the squares are Serre fibrations. Since fibrations are preserved by pullbacks, the left arrows are also fibrations. □

## 7.2 Main Theorem 2. General case: $O$ is weakly doubly reduced

We need to recall some general facts on the homotopy theory of undercategories. We thank B. Fresse for providing us the three lemmas below. The last Lemma 7.7, which follows from Lemmas 7.5 and 7.6, is crucial for the proof of Main Theorem 2.

Given a model category  $C$ , and  $c \in C$ , the undercategory  $(c \downarrow C)$  is endowed with a model structure, in which a morphism is a weak equivalence, fibration, or cofibration if it is one in  $C$ , see [Hir03, Section 7.6.4]. Given a morphism  $f: c_1 \rightarrow c_2$ , one has an adjunction

$$f^!: (c_1 \downarrow C) \rightleftarrows (c_2 \downarrow C): f^*, \tag{99}$$

where  $f^*$  is the precomposition with  $f$ , and  $f^!$  sends  $c_1 \rightarrow x$  to  $c_2 \rightarrow c_2 \sqcup_{c_1} x$ . The following lemma is well-known, see for example [Rez02, Proposition 2.5] or [MP12, Proposition 16.2.4].

**Lemma 7.5.** *In case  $C$  is a left proper model category, and  $f: c_1 \rightarrow c_2$  is a weak equivalence, the adjunction (99) is a Quillen equivalence.*

Now, given a Quillen adjunction

$$L: C \rightleftarrows D: R \quad (100)$$

between two model categories,  $c \in C$ ,  $d \in D$ , and a map

$$\phi: c \rightarrow Rd, \quad (101)$$

one has an adjunction

$$\hat{L}: (c \downarrow C) \rightleftarrows (d \downarrow D): \hat{R}, \quad (102)$$

where  $\hat{R}$  sends  $d \rightarrow d_1$  to the composition  $c \xrightarrow{\phi} Rd \rightarrow Rd_1$ , and  $\hat{L}$  sends  $c \rightarrow c_1$  to the pushout map  $d \rightarrow d \sqcup_{Lc} Lc_1$ , where  $Lc \rightarrow d$  is the adjunct of  $\phi$ .

**Lemma 7.6.** *If (100) is a Quillen equivalence,  $c$  is cofibrant,  $d$  is fibrant, (101) is a weak equivalence, and  $D$  is left proper, then the adjunction (102) is a Quillen equivalence.*

*Proof.* First, note that since  $c$  is cofibrant,  $d$  is fibrant, and (100) is a Quillen equivalence, the adjunct of (101), i.e. the map  $Lc \rightarrow d$  is a weak equivalence. Let  $S$  be the fibrant replacement functor in  $D$ . We need to show two conditions. The first one is that for any cofibration  $c \rightarrow c_1$ , the map  $c_1 \rightarrow RS(d \sqcup_{Lc} Lc_1)$  is a weak equivalence. (The second condition is formulated and checked at the end.) This map factors as

$$c_1 \rightarrow RSLc_1 \rightarrow RS(d \sqcup_{Lc} Lc_1),$$

where the first map is an equivalence because  $c_1$  is cofibrant and (100) is a Quillen equivalence; the second map is a weak equivalence, because  $R$  preserves equivalences between fibrant objects (being right adjoint in a Quillen adjunction) and the map

$$Lc_1 \rightarrow d \sqcup_{Lc} Lc_1$$

is an equivalence being a pushout of a weak equivalence  $Lc \rightarrow d$  along a cofibration  $Lc \rightarrow Lc_1$  (using left properness of  $D$ ).

For any map  $c \rightarrow c_1$ , let  $c \rightarrow \hat{Q}c_1 \xrightarrow{\sim} c_1$  denote its canonical factorization into a cofibration and a trivial fibration. In other words,  $\hat{Q}$  is the cofibrant replacement functor in  $c \downarrow C$ . The second condition that we need to check is that for any morphism  $d \rightarrow d_1$  with fibrant target, the map  $d \sqcup_{Lc} L\hat{Q}Rd_1 \rightarrow d_1$  is an equivalence. Consider the composition

$$L\hat{Q}Rd_1 \rightarrow d \sqcup_{Lc} L\hat{Q}Rd_1 \rightarrow d_1.$$

The first map here is an equivalence, because it is a pushout of a weak equivalence  $Lc \rightarrow d$  along a cofibration  $Lc \rightarrow L\hat{Q}Rd_1$  (and  $D$  is left proper). The composition of the two  $L\hat{Q}Rd_1 \rightarrow d_1$  is an equivalence, because  $\hat{Q}Rd_1$  is cofibrant,  $d_1$  is fibrant,  $\hat{Q}Rd_1 \rightarrow Rd_1$  is an equivalence (and (100) is a Quillen equivalence). By two out of three axiom, the map  $d \sqcup_{Lc} L\hat{Q}Rd_1 \rightarrow d_1$  is also an equivalence.  $\square$

**Lemma 7.7.** *In case (100) is a Quillen equivalence between left proper model categories,  $R$  preserves weak equivalences, and (101) is a weak equivalence, then for any  $c \in C$ ,  $d \in D$ , (102) is a Quillen equivalence.*

*Proof.* Let  $Q$  denote the cofibrant replacement functor in  $C$  and  $S$  denote the fibrant replacement functor in  $D$ . One has a composition of adjunctions:

$$(Qc \downarrow C) \rightleftarrows (c \downarrow C) \rightleftarrows (d \downarrow D) \rightleftarrows (Sd \downarrow D).$$

The left and right ones are Quillen equivalences by Lemma 7.5. The composition of the three is a Quillen equivalence by Lemma 7.6 (here we use that  $R$  preserves weak equivalences as one needs  $Rd \rightarrow RSd$  to be a weak equivalence). Applying twice the two out of three property of Quillen equivalences, we get that the middle adjunction is also a Quillen equivalence.  $\square$

**Proposition 7.8.** *Let  $\phi: W \xrightarrow{\cong} W_1$  be a weak equivalence of Reedy cofibrant operads.*

(i) *The adjunction*

$$\hat{\phi}_B^!: (W \downarrow \Lambda\text{Bimod}_W) \rightleftarrows (W_1 \downarrow \Lambda\text{Bimod}_{W_1}): \hat{\phi}_B^* \quad (103)$$

*is a Quillen equivalence.*

(ii) *Let  $\eta: W \rightarrow M$  be a cofibration in  $\Lambda\text{Bimod}_W$ , then there exists a  $W_1$ -bimodule  $M_1$  endowed with a map  $\eta_1: W_1 \rightarrow M_1$  of  $W_1$ -bimodules, and an equivalence  $M \xrightarrow{\cong} M_1$  of  $W$ -bimodules, such that the square*

$$\begin{array}{ccc} W & \xrightarrow{\eta} & M \\ \simeq \downarrow \phi & & \downarrow \simeq \\ W_1 & \xrightarrow{\eta_1} & M_1 \end{array} \quad (104)$$

*commutes.*

*Proof.* (i) The adjunction (103) is induced by the map  $\phi$  and the restriction-induction adjunction

$$\phi_B^!: \Lambda\text{Bimod}_W \rightleftarrows \Lambda\text{Bimod}_{W_1}: \phi_B^*,$$

which is a Quillen equivalence by Theorem 2.5. By Theorem 2.3 (iii), the categories  $\Lambda\text{Bimod}_W$  and  $\Lambda\text{Bimod}_{W_1}$  are left proper relative to  $\Sigma$ -cofibrant objects. For simplicity Lemmas 7.5-7.7 were formulated for left proper model categories, but similar statements hold also in the relative case. To apply Lemma 7.5 to the case  $C$  is  $\Lambda\text{Bimod}_W$  or  $\Lambda\text{Bimod}_{W_1}$ , one needs to assume that  $c_1$  and  $c_2$  are  $\Sigma$ -cofibrant. To apply Lemma 7.6 to the adjunction (103) one needs  $Lc$  and  $d$  to be  $\Sigma$ -cofibrant. As a consequence, to apply an analogue of Lemma 7.7 to the adjunction (103), one needs to assume that  $c$ ,  $Qc$ ,  $LQc$ ,  $d$ , and  $Sd$  are  $\Sigma$ -cofibrant. One has  $c = W$  and  $d = W_1$  as cofibrant operads they are also  $\Sigma$ -cofibrant by [BM03, Proposition 4.3]. We choose for  $Qc$  the Boardman-Vogt resolution  $\mathcal{B}_W^\Lambda(W)$  of  $W$  as a bimodule over itself. It is  $\Sigma$ -cofibrant by the same argument as the proof of Lemma A.2 – one takes a filtration by the number of vertices. Similarly one proves that  $LQc = \phi_B^!(\mathcal{B}_W^\Lambda(W))$  is  $\Sigma$ -cofibrant. Elements of  $\phi_B^!(\mathcal{B}_W^\Lambda(W))$  are trees with vertices labelled by  $W$  and  $W_1$  and by numbers in  $[0, 1]$ . Only vertices assigned 1 are labelled by  $W_1$ . To prove the  $\Sigma$ -cofibrancy, one should consider a double filtration by the total number of vertices and also by the number of vertices that are not labelled by 1. Finally for  $Sd$  one can choose the functorial Reedy fibrant replacement  $W_1^f$  of  $W_1$  as an operad. It has automatically the structure of a Reedy fibrant  $W_1$ -bimodule. Since  $W_1 \rightarrow W_1^f$  is a cofibration of operads,  $W_1^f$  is a cofibrant operad and therefore is  $\Sigma$ -cofibrant.

(ii) One can take  $M_1 := \hat{\phi}_B^!(M)$ . The map  $M \rightarrow \hat{\phi}_B^*(\hat{\phi}_B^!(M)) = M_1$  is a weak equivalence, because  $W \rightarrow M$  is a cofibrant object in  $W \downarrow \Lambda\text{Bimod}_W$  and the adjunction (103) is a Quillen equivalence. The square (104) commutes because the natural map  $M \rightarrow M_1$  is a morphism in the under category  $W \downarrow \Lambda\text{Bimod}_W$ .  $\square$

We are now ready to finish the proof of Main Theorem 2. For a weakly doubly reduced operad  $O$ , one has a zigzag of equivalences

$$O \xleftarrow{\cong} WO \xrightarrow{\cong} W_1O$$

from Theorem 2.1 in which  $WO$  and  $W_1O$  are Reedy cofibrant. Given a map  $\eta: O \rightarrow M$  of  $O$ -bimodules, one has a zigzag of derived mapping spaces of bimodules:

$$\begin{aligned} \text{Bimod}_O^h(O, M) &\simeq \text{Bimod}_{WO}^h(O, M) \simeq \text{Bimod}_{WO}^h(WO, M) \simeq \\ &\text{Bimod}_{WO}^h(WO, M^c) \simeq \text{Bimod}_{W_1O}^h(W_1O, M_1^c) \simeq \text{Bimod}_{W_1O}^h(W_1O, M_1^c), \end{aligned} \quad (105)$$

where  $M^c$  is obtained by taking the canonical factorization  $WO \rightarrow M^c \xrightarrow{\cong} M$  (in the category of  $WO$ -bimodules) into a cofibration and a trivial fibration of the map  $WO \rightarrow M$ , and  $M_1^c$  is obtained from  $M^c$  using Proposition 7.8(ii). The first and the last equivalences are by Theorem 2.5; the second, third, and fourth by

replacing the source and/or target by an equivalent object. One has a similar zigzag for Ibimodules mapping spaces:

$$\begin{aligned} \text{Ibimod}_O^h(O, M) &\simeq \text{Ibimod}_{WO}^h(O, M) \simeq \text{Ibimod}_{WO}^h(WO, M) \simeq \\ &\text{Ibimod}_{WO}^h(WO, M^c) \simeq \text{Ibimod}_{WO}^h(W_1O, M_1^c) \simeq \text{Ibimod}_{W_1O}^h(W_1O, M_1^c). \end{aligned} \quad (106)$$

By Theorem 6.5, the generalized delooping (78) holds for the right-most mapping spaces of (105) and (106). Therefore it holds for the left-most mapping spaces as well. The truncated case is obtained by the same zigzag.  $\square$

### 7.3 Explicit maps

In this subsection we want to emphasize the fact that there are explicit maps realizing the equivalences of Main Theorem 2.

In case of a doubly reduced operad  $O$ , in Subsection 6.2 besides the maps  $\xi_\bullet^\Lambda$  that realize the equivalences (77-78) of Theorem 6.5, we also constructed maps  $\xi_\bullet^\Sigma$ , see (81-82). The fact that  $\xi_\bullet^\Sigma$  are equivalences follows easily from Theorems 2.4 and 2.7 (ii) and the fact that  $\xi_\bullet^\Lambda$  are ones. This can also be shown directly, but the proof is more tedious than in the case of  $\xi_\bullet^\Lambda$ . According to Examples 3.6 and 3.13 one would need to consider a double filtration in  $\mathcal{B}^\Sigma(O)$  and  $\overline{\mathcal{I}b}^\Sigma(O)$ , as the inclusion from the  $(k-1)$ st filtration term to the  $k$ -th one for both of them is a sequence of  $(k+1)$  cell attachments, and then to compare the mapping spaces for each term of this double filtration. This has been done for the associative operad by the second author in [Tur14, Part II].

The maps  $\xi_\bullet^\Lambda$  and  $\xi_\bullet^\Sigma$  can also be generalized to the case of any weakly doubly reduced operad, but in the latter case one would need to replace  $\Sigma O(2)$  by the homotopy equivalent space  $\mathcal{I}b^\Lambda(O)(1)/\partial\mathcal{I}b^\Lambda(O)(1)$ . Figure 31 shows how typical elements in  $\mathcal{I}b^\Lambda(O)(1)$  and  $\partial\mathcal{I}b^\Lambda(O)(1)$  look like.

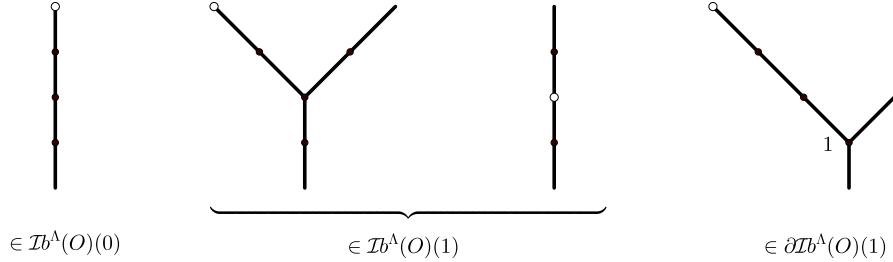

Figure 31: Examples of elements in  $\mathcal{I}b^\Lambda(O)(0)$ ,  $\mathcal{I}b^\Lambda(O)(1)$ ,  $\partial\mathcal{I}b^\Lambda(O)(1)$ .

We claim that the obtained maps

$$\begin{aligned} \xi_k^\Sigma: \text{Map}_* \left( \mathcal{I}b^\Lambda(O)(1)/\partial\mathcal{I}b^\Lambda(O)(1), \text{T}_k \text{Bimod}_O \left( \text{T}_k \mathcal{B}_k^\Sigma(O), \text{T}_k M \right) \right) \\ \longrightarrow \text{T}_k \text{Ibimod}_O \left( \text{T}_k \overline{\mathcal{I}b}_k^\Sigma(O), \text{T}_k M \right), \quad k \geq 0, \end{aligned}$$

producing at the limit  $k = \infty$ :

$$\xi^\Sigma: \text{Map}_* \left( \mathcal{I}b^\Lambda(O)(1)/\partial\mathcal{I}b^\Lambda(O)(1), \text{Bimod}_O \left( \mathcal{B}^\Sigma(O), M \right) \right) \longrightarrow \text{Ibimod}_O \left( \overline{\mathcal{I}b}^\Sigma(O), M \right);$$

and maps

$$\begin{aligned} \xi_k^\Lambda: \text{Map}_* \left( \mathcal{I}b^\Lambda(O)(1)/\partial\mathcal{I}b^\Lambda(O)(1), \text{T}_k \text{Bimod}_O \left( \text{T}_k \mathcal{B}^\Lambda(O), \text{T}_k M^f \right) \right) \\ \longrightarrow \text{T}_k \text{Ibimod}_O \left( \text{T}_k \overline{\mathcal{I}b}^\Lambda(O), \text{T}_k M^f \right), \quad k \geq 0, \end{aligned}$$

producing at the limit  $k = \infty$ :

$$\xi^\Lambda : \text{Map}_* \left( \mathcal{I}b^\Lambda(O)(1)/\partial\mathcal{I}b^\Lambda(O)(1), \text{Bimod}_O(\mathcal{B}^\Lambda(O), M^f) \right) \longrightarrow \text{Ibimod}_O(\overline{\mathcal{I}b}^\Lambda(O), M^f)$$

realize the equivalences of Main Theorem 2. We failed to find a direct proof of this statement, but it follows easily from the fact that the maps  $\xi_\bullet^\Lambda$  and  $\xi_\bullet^\Sigma$  are functorially defined, and thus can be shown to commute with the zigzags (105) and (106) from the previous subsection.

## 7.4 Main Theorem 3

Even though we constructed an explicit map that proves equivalence (17) of Main Theorem 2, this map still seems mysterious. On the other hand, the result of this theorem and its underlying construction has an easy generalization that we present below. It shed some light on the algebraic nature of this construction.

Recall Definitions 4.3, 4.4, and 4.7.

**Definition 7.9.** An infinitesimal bimodule  $N$  over a weakly doubly reduced operad  $O$  is called (*strongly*) *coherent* if each diagram  $\rho_i^N$ ,  $i \geq 2$ , is (strongly) coherent.

Let  $C_N$  denote the mapping cone of the infinitesimal left action map  $\circ_1 : O(2) \times N(0) \rightarrow N(1)$  pointed in the apex of the cone. Note that  $C_N$  is determined by the 1-truncation  $T_1N$  of  $N$ .

**Main Theorem 3.** *Let  $O$  be a weakly doubly reduced,  $\Sigma$ -cofibrant, and well-pointed topological operad, let  $\mu : N \rightarrow O$  be a map of  $O$ -bimodules,  $\eta : O \rightarrow M$  be a map of  $O$ -bimodules, and  $M(0) = *$ . If  $N$  is coherent, then one has an equivalence of towers*

$$T_k \text{Ibimod}_O^h(T_k N, T_k M) \simeq \text{Map}_*(C_N, T_k \text{Bimod}_O^h(T_k O, T_k M)), k \geq 0, \quad (107)$$

implying at the limit  $k = \infty$ :

$$\text{Ibimod}_O^h(N, M) \simeq \text{Map}_*(C_N, \text{Bimod}_O^h(O, M)). \quad (108)$$

The left-hand sides in (108) and (107) are pointed in  $\eta \circ \mu$  and  $T_k(\eta \circ \mu)$ .

*Sketch of the proof.* First prove it in the case of a strictly doubly reduced operad  $O$ , then generalize it to the weakly doubly reduced case. (One has to use the fact that the model category  $\Lambda\text{Ibimod}_O$  is right proper for any  $O$ , which is a consequence of the fact that  $\text{Top}$  is so and pullbacks in  $\Lambda\text{Ibimod}_O$  are obtained objectwise.)

For the strictly doubly reduced case, one has  $\mathcal{I}b^\Lambda(N)(1)/\partial\mathcal{I}b^\Lambda(N)(1) = C_N$  (compare with Example 3.15). On the other hand, one can show that  $\overline{\mathcal{I}b}^\Lambda(N) := \mathcal{I}b^\Lambda(N) \rtimes \mathcal{B}^\Lambda(O)$  is homeomorphic to  $\mathcal{I}b^\Lambda(N)$  (which is analogous to Theorem 6.3). By the general Construction 6.6, one gets a map

$$\text{Map}_*(C_N, \text{Bimod}_O(\mathcal{B}^\Lambda(O), M^f)) \rightarrow \text{Ibimod}_O(\overline{\mathcal{I}b}^\Lambda(N), M^f),$$

which similarly to the argument in Subsection 7.1 is proved to be an equivalence provided  $N$  is coherent.  $\square$

This result implies Main Theorem 2 by taking  $N = O$ . Note that in case  $N$  is strongly coherent, each  $N(k)$ ,  $k \geq 2$ , can be expressed from  $N(0), \dots, N(k-1)$  by means of a homotopy colimit (62). However, the structure of a  $k$ -truncated infinitesimal bimodule can not be recovered from the  $(k-1)$ -truncation. It would be interesting to find more examples of (strongly) coherent infinitesimal bimodules, and to explore further their connection with the manifold functor calculus.



# A Appendix

## A.1 A convenient category of topological spaces

Below we recall basic properties of the category  $\text{Top}$  of  $k$ -spaces from [Lew78, Appendix A] and [Hov99, Section 2.4], where this category is denoted by  $\mathbf{K}$ .

For any topological space  $X$ , its kellyfication  $kX$  is the refinement space of  $X$  in which  $U \subset X$  is open if and only if for any continuous map  $f: K \rightarrow X$  with a compact source,  $f^{-1}(U)$  is open in  $K$ . The (identity) map  $kX \rightarrow X$  is continuous and induces a bijective map of the sets of singular chains, therefore it is a weak homotopy equivalence. A space  $X$  is called *k-space* if  $kX = X$ . One has an adjunction

$$i: \text{Top} \rightleftarrows \text{AllTop}: k \quad (109)$$

between the category  $\text{Top}$  of  $k$ -spaces and the category  $\text{AllTop}$  of all topological spaces. (Here  $i$  is the inclusion functor.) Both categories admit a cofibrantly generated model structures, where in both cases equivalences are weak homotopy equivalences, the set of generating cofibrations is  $\{S^{n-1} \hookrightarrow D^n\}_{n \geq 0}$  and that of generating acyclic cofibrations is  $\{D^n \hookrightarrow D^n \times [0, 1]\}_{n \geq 0}$ . With respect to these model structures, the adjunction (109) is a Quillen equivalence [Hov99, Theorem 2.4.23]. Limits in  $\text{Top}$  are kellyfication of the usual limits. Colimits are the usual colimits since any usual colimit of  $k$ -spaces is always a  $k$ -space. It follows from this adjunction, that a map  $X \rightarrow kY$  from a  $k$ -space  $X$  to the kellyfication of another space is continuous if and only if the composition  $X \rightarrow kY \rightarrow Y$  is so.

The category  $\text{Top}$  is a so called *convenient* topological category [Ste67, Vog71]: it contains all CW-complexes, it is complete and cocomplete, and it is cartesian closed meaning that for any  $X, Y, Z \in \text{Top}$  one has homeomorphisms:

$$\text{Map}(X, \text{Map}(Y, Z)) \cong \text{Map}(X \times Y, Z) \cong \text{Map}(Y, \text{Map}(X, Z)). \quad (110)$$

From (110) we get that for any  $Y, Z \in \text{Top}$  one has adjunctions

$$(-) \times Y: \text{Top} \rightleftarrows \text{Top}: \text{Map}(Y, -); \quad (111)$$

$$\text{Map}(-, Z): \text{Top} \rightleftarrows \text{Top}^{op}: \text{Map}(-, Z). \quad (112)$$

The first adjunction (111) implies that the product  $(-) \times Y$  distributes over colimits:

$$\left( \text{colim}_I X_i \right) \times Y \cong \text{colim}_I (X_i \times Y),$$

which is a prerequisite to define the theory of operads on the monoidal category  $(\text{Top}, \times, *)$ ; and one also gets that  $\text{Map}(Y, -)$  preserves limits:

$$\text{Map}\left(Y, \lim_I Z_i\right) \cong \lim_I \text{Map}(Y, Z_i).$$

From the second adjunction (112),  $\text{Map}(-, Z)$  converts colimits to limits:

$$\text{Map}\left(\text{colim}_I X_i, Z\right) \cong \lim_I \text{Map}(X_i, Z). \quad (113)$$

**Lemma A.1.** *For any  $k$ -spaces  $X$  and  $Y$ , and any equivalence relation  $\sim$  on  $X$ , the natural inclusion map  $\text{Map}(X/\sim, Y) \hookrightarrow \text{Map}(X, Y)$  is a homeomorphism on its image.*

*Proof.* Consider the pushout diagram

$$(X/\sim)^\delta \leftarrow X^\delta \rightarrow X, \quad (114)$$

where  $(-)^\delta$  is the discretization functor. The colimit of (114) is  $X/\sim$ . Applying (113) to this diagram, the left-hand side is  $\text{Map}(X/\sim, Y)$ , while the right-hand side is exactly the image subspace in  $\text{Map}(X, Y)$ .  $\square$

Recall again that the mapping spaces and subspaces in this lemma (and everywhere throughout the paper) are taken with the kellyfication of the standard compact-open and subspace topologies. In  $\text{AllTop}$  the inclusion map  $\text{Map}(X/\sim, Y) \hookrightarrow \text{Map}(X, Y)$  may not even be a weak homotopy equivalence on its image, see example [Mat].

## A.2 Proof of Theorem 2.1

Without loss of generality, one can assume that the operad  $O$  is well-pointed and  $\Sigma$ -cofibrant. (If not, one can replace  $O$  by  $|C_\bullet O| \times \mathcal{B}_\infty$ , where  $C_\bullet O$  is the simplicial operad of singular chains on  $O$ , and  $|-|$  denotes the realization functor. The operad  $|C_\bullet O|$  is well pointed and has cofibrant components. By taking the objectwise product with  $\mathcal{B}_\infty$ , the resulting operad is  $\Sigma$ -cofibrant.) Define an operad  $WO$  as the Boardman-Vogt resolution of  $O_{>0}$ , see [BV68], in positive arities and as a point in arity 0. Composition with  $*_0^W \in WO(0)$  is defined in the same way as the right action of  $*_0$  on  $\mathcal{B}^\wedge(M)$  and on  $\mathcal{I}b^\wedge(M)$ , see Section 3.

The operad  $W_1O$  is obtained from  $WO$  by collapsing the arity one component  $WO(1)$  to a point and quotienting out the other components by the induced relations.

Recall that  $WO(k)$  is the space

$$WO(k) = \left( \coprod_{T \in \text{tree}_k^{\geq 1}} [0,1]^{E^{\text{int}}(T)} \times \prod_{v \in V(T)} O(|v|) \right) / \sim. \quad (115)$$

The relations are: relation (ii) of Construction 3.2; analogue of relation (i) of Construction 3.2:

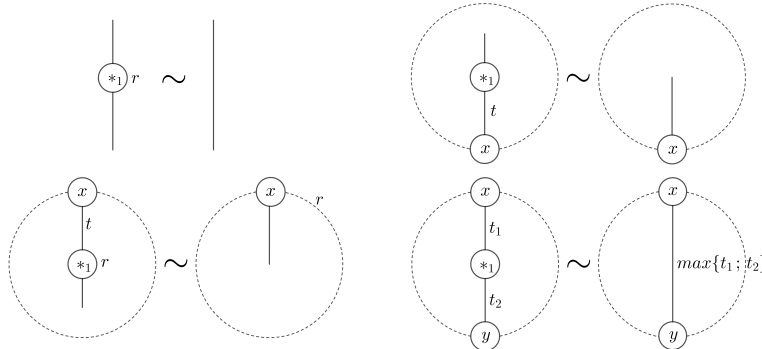

(the relations with dotted circles are “local” in the sense that the trees outside the dotted circles are the same for left and right sides); and composition relations:

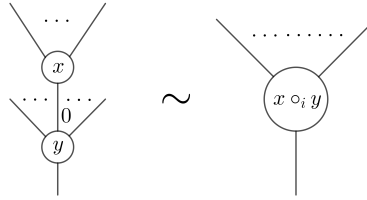

To pass to  $W_1O$ , one adds the local relations from Figure 32.

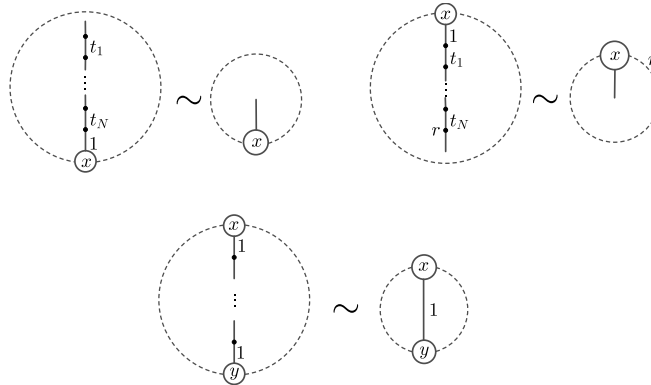

Figure 32: Additional relations in  $W_1O$ .

We need to show that the quotient map  $WO(k) \rightarrow W_1O(k)$  is a weak equivalence. For  $k = 0$ , both spaces are singletons. For  $k = 1$ , the second space is a point, while the first one is homotopy equivalent to  $O(1)$  therefore is also contractible. We concentrate below on the case  $k \geq 2$ . We also need to show that  $WO$  and  $W_1O$  are Reedy cofibrant operads, or, equivalently, that  $WO_{>0}$  and  $W_1O_{>0}$  are cofibrant in the projective model structure, see Subsection 2.2 or [Fre17, Theorem II.8.4.12]. The cofibrancy of  $WO_{>0}$  is guaranteed by the fact that  $O_{>0}$  is well-pointed and  $\Sigma$ -cofibrant, see [BV68].

Consider an increasing filtration  $F_iWO(k)$ , respectively  $F_iW_1O(k)$ , in  $WO(k)$ , respectively  $W_1O(k)$ , by the number  $i$  of vertices of the trees in  $\mathbf{tree}_k^{\geq 1}$ . The map

$$WO(k) \rightarrow W_1O(k) \tag{116}$$

preserves this filtration. One also has  $F_1WO(k) = F_1W_1O(k) = O(k)$ ,  $k \geq 2$ . The following lemma implies that (116) is a weak homotopy equivalence.

**Lemma A.2.** *For any weakly doubly reduced, well-pointed, and  $\Sigma$ -cofibrant operad  $O$ , the inclusions*

$$F_{i-1}WO(k) \rightarrow F_iWO(k) \text{ and } F_{i-1}W_1O(k) \rightarrow F_iW_1O(k) \tag{117}$$

are trivial  $\Sigma_k$ -cofibrations,  $i \geq 2$ ,  $k \geq 2$ .

*Proof.* This fact for the Boardman-Vogt resolutions (first inclusion in (117)) was proved by Berger-Moerdijk in [BM06]. Below we recall their argument and then adapt it to the case of the second inclusion in (117).

For any tree  $(T, id) \in \mathbf{tree}_k^{\geq 1}$  with exactly  $i$  vertices, denote by  $Aut(T) \subset \Sigma_k$  the group of automorphisms of  $T$ . Define  $O(T) := \prod_{v \in V(T)} O(|v|)$  and  $H(T) := [0, 1]^{E^{int}(T)}$ . Define also  $O^-(T) \subset O(T)$  as the subset of elements for which at least one coordinate is  $*_1 \in O(1)$ ; and  $H^-(T) \subset H(T)$  as the subset for which at least one coordinate is  $0 \in [0, 1]$ .

**Lemma A.3** (Equivariant pushout-product lemma - Lemma 2.5.2 in [BM06]). *Let  $\Gamma$  be a discrete group. Consider the projective model structure on  $\mathbf{Top}^\Gamma$ . Let  $A \hookrightarrow B$  and  $X \hookrightarrow Y$  be  $\Gamma$ -equivariant cofibrations. If one of them is a  $\Gamma$ -cofibration, the pushout-product map  $A \times Y \cup B \times X \hookrightarrow B \times Y$  is a  $\Gamma$ -cofibration. Moreover, the latter is trivial if  $A \hookrightarrow B$  or  $X \hookrightarrow Y$  is.*

Berger-Moerdijk showed that for  $O$  well-pointed and  $\Sigma$ -cofibrant, the inclusion  $O^-(T) \subset O(T)$  is an  $Aut(T)$ -cofibration and  $H^-(T) \subset H(T)$  is a trivial  $Aut(T)$ -equivariant cofibration. From Lemma A.3 it follows that the inclusion

$$(H(T) \times O(T))^- := H^-(T) \times O(T) \bigcup H(T) \times O^-(T) \subset H(T) \times O(T)$$

is a trivial  $Aut(T)$ -cofibration. As a consequence, the inclusion

$$(H(T) \times O(T))^- \times_{Aut(T)} \Sigma_k \subset (H(T) \times O(T)) \times_{Aut(T)} \Sigma_k \tag{118}$$

is a trivial  $\Sigma_k$ -cofibration. On the other hand, it is easy to see that  $F_iWO(k)$  is obtained from  $F_{i-1}WO(k)$  by taking pushout along cofibrations (118) over all (non-planar) trees  $T$  with  $k$  leaves and  $i$  vertices (all of arity  $\geq 1$ ).

Let us adapt this argument to the second inclusion in (117). For any tree  $T$  as above, define  $\tilde{H}^-(T) \subset H(T)$  as the set of points having at least one coordinate  $0 \in [0, 1]$  plus the points (markings of the edges) that would appear in relations of Figure 32. It is easy to see that  $\tilde{H}^-(T)$  is a union of some codimension 0 and 1 faces of the cube  $H(T)$ . Therefore  $\tilde{H}^-(T) \subset H(T)$  is an  $Aut(T)$ -equivariant cofibration, trivial in case all vertices of  $T$  have arities  $\geq 2$ . On the other hand, by the usual pushout product lemma ( $\Gamma = 1$  in Lemma A.3), the  $Aut(T)$ -cofibration  $O^-(T) \subset O(T)$  is trivial in case  $T$  has at least one vertex of arity 1. Thus every inclusion

$$\tilde{H}^-(T) \times O(T) \bigcup H(T) \times O^-(T) \subset H(T) \times O(T)$$

is a trivial  $Aut(T)$ -cofibration and we conclude similarly that  $F_{i-1}W_1O(k) \hookrightarrow F_iW_1O(k)$  is a trivial  $\Sigma_k$ -cofibration.  $\square$

To prove that the operad  $W_1 O_{>0}$  is cofibrant, we consider a different filtration in  $W_1 O_{>0}$ . We say that an element  $x \in W_1 O_{>0}$  is prime if all edges of  $x$  are assigned length  $< 1$ . To any  $x \in W_1 O_{>0}$  one can assign the set of its prime components by splitting the underline tree into subtrees cutting all edges of length 1. We say that  $x$  is in the  $i$ -th filtration term  $W_1^{(i)} O_{>0}$  if all its prime components have  $\leq i$  vertices. Each term  $W_1^{(i)} O_{>0}$  is an operad. Moreover, each inclusion  $W_1^{(i-1)} O_{>0} \subset W_1^{(i)} O_{>0}$  is an operadic cofibration. Indeed, it is obtained as a sequence of free (operadic) cell attachments along  $\Sigma_k$ -cofibrations:

$$(\partial H(T) \times O(T)) \Big| \bigcup H(T) \times O^-(T) \Big| \times_{Aut(T)} \Sigma_k \subset (H(T) \times O(T)) \times_{Aut(T)} \Sigma_k,$$

where  $\partial H(T)$  is the boundary of the cube  $H(T)$ , and  $T$  is a tree with  $i$  internal vertices (each of arity  $\geq 1$ ) and with  $k \geq 2$  leaves. (It is easy to see that by the same argument  $W O_{>0}$  is obtained as a sequence of cell attachments. Moreover  $W_1 O_{>0}$  is obtained from  $W O_{>0}$  by collapsing to a point all its arity  $k = 1$  cells.)

### A.3 Cellular cosheaves

In this section we explain what we mean by a *cellular cosheaf* and its *realization*. Given a CW-complex  $X$ , we consider the poset structure on the set  $I$  of its cells generated by relations  $i < j$  if the interior of a cell  $i$  has a non-empty intersection with the boundary of a cell  $j$ . Denote by  $d: I \rightarrow \mathbb{N}$  the associated dimension function, which is obviously order-preserving. One has

$$X = \left( \bigsqcup_{i \in I} D^{d(i)} \right) \Big| \sim,$$

where  $\sim$  says how the boundary of each disc  $D^{d(i)}$  is attached to the  $(d(i) - 1)$ -skeleton of  $X$ .

Viewing  $I$  as a category, we say that a *cellular cosheaf* on  $X$  is a contravariant functor  $\mathcal{F}: I \rightarrow \text{Top}$ . Thus for any  $i < j$ , one gets a map  $\mathcal{F}(j) \rightarrow \mathcal{F}(i)$ .

By *realization* of a cellular cosheaf  $\mathcal{F}$  we understand the space

$$|\mathcal{F}| := \left( \bigsqcup_{i \in I} \mathcal{F}(i) \times D^{d(i)} \right) \Big| \sim,$$

where  $\sim$  is generated by  $(a_1, x_1) \sim (a_2, x_2)$  with  $x_1 \in D^{d(i)}$ ,  $x_2 \in \partial D^{d(j)}$ ,  $a_1 \in \mathcal{F}(i)$ ,  $a_2 \in \mathcal{F}(j)$ ,  $i < j$ ,  $x_1 \sim x_2$ , and  $a_2 \mapsto a_1$  by the map  $\mathcal{F}(i < j): \mathcal{F}(j) \rightarrow \mathcal{F}(i)$ .

In case a CW-complex  $Y$  is a cellular refinement of  $X$  along a homeomorphism  $f: Y \rightarrow X$ , the poset  $J$  of cells of  $Y$  admits a poset map  $f_*: J \rightarrow I$ , which assigns to a cell of  $Y$  the cell of  $X$  in which interior it lies.

One can also define the cellular cosheaf  $f^* \mathcal{F}$  on  $Y$  as the composition  $f^* \mathcal{F}: J \xrightarrow{f_*} I \xrightarrow{\mathcal{F}} \text{Top}$ .

The following lemma is easy to check.

**Lemma A.4.** *If  $f: Y \xrightarrow{\cong} X$  is a cellular refinement,  $\mathcal{F}$  is a cellular cosheaf on  $X$ , then one has a homeomorphism  $|f^* \mathcal{F}| \cong |\mathcal{F}|$ .*

## References

- [AT14] Gregory Arone and Victor Turchin, *On the rational homology of high dimensional analogues of spaces of long knots*, *Geometry and Topology* **18** (2014), 1261–1322.
- [BB17] M. A. Batanin and C. Berger, *Homotopy theory for algebras over polynomial monads*, *Theory Appl. Categ.* **32** (2017), 148–253.

- [BCKS17] Ryan Budney, James Conant, Robin Koytcheff, and Dev Sinha, *Embedding calculus knot invariants are of finite type*, *Algebr. Geom. Topol.* **17** (2017), no. 3, 1701–1742.
- [BdBW13] Pedro Boavida de Brito and Michael Weiss, *Manifold calculus and homotopy sheaves*, *Homology Homotopy Appl.* **15** (2013), no. 2, 361–383.
- [BdBW18] ———, *Spaces of smooth embeddings and configuration categories*, *Journal of Topology*, Issue 1 **18** (2018), 65–143.
- [BDL19] M. A. Batanin and F. De Leger, *Grothendieck’s homotopy theory, polynomial monads and delooping of spaces of long knots*, to appear in the *Journal of Noncommutative Geometry* (2019).
- [BM03] C. Berger and I. Moerdijk, *Axiomatic homotopy theory for operads*, *Comment. Math. Helv.* **78** (2003), 805–831.
- [BM06] ———, *The Boardman-Vogt resolution of operads in monoidal model categories*, *Topology* **45** (2006), no. 5, 807–849.
- [BM11] ———, *On an extension of the notion of Reedy category*, *Math. Z.* **269** (2011), no. 3-4, 977–1004.
- [BT94] R. Bott and C. Taubes, *On the self-linking of knots*, *J. Math. Phys.* **35** (1994), no. (10), 5247–5287.
- [Bud07] Ryan Budney, *Little cubes and long knots*, *Topology* **46** (2007), no. 1, 1–27. MR 2288724 (2008c:55015)
- [Bud12] ———, *An operad for splicing*, *J. Topol.* **5** (2012), no. 4, 945–976.
- [BV68] J. M. Boardman and R. M. Vogt, *Homotopy-everything H-spaces*, *Bull. Amer. Math. Soc.* **74** (1968), 1117–1122. MR 0236922
- [BV73] J.M. Boardman and R.M. Vogt, *Homotopy invariant algebraic structures on topological spaces*, *Lecture Notes in Mathematics*, Vol. 347, Springer-Verlag, Berlin, 1973.
- [CFT02] A.S. Cattaneo, G. Felder, and L. Tomassini, *From local to global deformation quantization of poisson manifolds*, *Duke Math. J.* **115** (2002), no. 2, 329–352.
- [DFT19] Julien Ducoulombier, Benoit Fresse, and Victor Turchin, *Projective and Reedy model category structures for (infinitesimal) bimodules over an operad*, arXiv:1911.03890 (2019).
- [DH12] W. Dwyer and K. Hess, *Long knots and maps between operads*, *Geometry and topology* **16** (2012), 919–955.
- [DK88] J. Dydak and G. Kozłowski, *A generalization of the Vietoris-Begle theorem.*, *Proc. Amer. Math. Soc.* **103** (1988), no. 1, 209–212.
- [DT15] N. Dobrinskaya and V. Turchin, *Homology of non-k-overlapping discs*, *Homology, Homotopy, and Applications* **17** (2015), 261–290.
- [DTW18] J. Ducoulombier, V. Turchin, and T. Willwacher, *On the delooping of (framed) embedding spaces*, arXiv:1811.12816 (2018).
- [Duc18] J. Ducoulombier, *From maps between coloured operads to Swiss-Cheese algebras*, *Annales de l’Institut Fourier* **68** (2018), 661 – 724.
- [Duc19] ———, *Delooping derived mapping spaces of bimodules over an operad*, *Journal of Homotopy and relative structure.* **14** (2019), ,411–453.
- [Fre09] Benoit Fresse, *Modules over operads and functors*, *Lecture Notes in Mathematics*, Vol. 1967, Springer-Verlag, Berlin, 2009.

- [Fre17] ———, *Homotopy of operads and Grothendieck-Teichmüller groups. Part 2*, Mathematical Surveys and Monographs, vol. 217, American Mathematical Society, Providence, RI, 2017, The applications of (rational) homotopy theory methods. MR 3616816
- [FTW17] Benoit Fresse, Victor Turchin, and Thomas Willwacher, *The rational homotopy of mapping spaces of  $E_n$  operads*, arXiv:1703.06123 (2017).
- [FTW18] ———, *The homotopy theory of operad subcategories*, J. Homotopy Relat. Struct. **13**, Issue 4 (2018), 689–702.
- [FV15] Z. Fiedorowicz and R. M. Vogt, *An additivity theorem for the interchange of  $E_n$  structures*, Adv. Math. **273** (2015), 421–484.
- [GJ94] E. Getzler and J.D.S Jones, *Operads, homotopy algebra and iterated integrals for double loop spaces*, arXiv:hep-th/9403055 (1994).
- [GK15] T. G. Goodwillie and J. R. Klein, *Multiple disjunction for spaces of smooth embeddings*, Journal of Topology **8** (2015), 651–674.
- [Gro86] Mikhael Gromov, *Partial differential relations*, Ergebnisse der Mathematik und ihrer Grenzgebiete (3) [Results in Mathematics and Related Areas (3)], vol. 9, Springer-Verlag, Berlin, 1986.
- [GW99] Thomas G. Goodwillie and Michael Weiss, *Embeddings from the point of view of immersion theory. II*, Geom. Topol. **3** (1999), 103–118. MR 1694808 (2000c:57055b)
- [Hir03] Philip S. Hirschhorn, *Model categories and their localizations*, Mathematical Surveys and Monographs, vol. 99, American Mathematical Society, Providence, RI, 2003.
- [Hov99] Mark Hovey, *Model categories*, Mathematical Surveys and Monographs, vol. 63, American Mathematical Society, Providence, RI, 1999.
- [Kon99] M. Kontsevich, *Operads and motives in deformations quantization*, Lett. Math. Phys. **48** (1999), 35 – 72.
- [Kon01] ———, *Deformation quantization of algebraic varieties*, EuroConférence Moshé Flato 2000, Part III (Dijon), Letters in Mathematical Physics **56** (2001), no. 3, 271 – 294.
- [Kon03] ———, *Deformation quantization of poisson manifolds*, Lett. Math.Phys. **66** (2003), 157 – 216.
- [Lac69] R. C. Lacher, *Cell-like mappings. I*, Pacific J. Math. **30** (1969), 717 – 731.
- [Lew78] Lemoine G. Lewis, *The stable category and generalized Thom spectra*, Thesis (Ph.D., The University of Chicago), 1978.
- [LTV10] Pascal Lambrechts, Victor Turchin, and Ismar Volić, *Associahedron, cyclohedron and permutohedron as compactifications of configuration spaces*, Bull.Belg. Math.soc. Simon Stevin **17** (2010), no. no.2, 303–332.
- [LV14] P. Lambrechts and I. Volic, *Formality of the little  $n$ -discs operad*, Mem. Amer. Math. Soc. **239** (2014).
- [Mar99] M. Markl, *A compactification of a real configuration space as an operadic completion*, J. Algebra **215** (1999), 185–204.
- [Mat] MathOverflow, *Mapping space from a quotient space*, <https://mathoverflow.net/questions/274994/>.
- [May72] J. P. May, *The geometry of iterated loop spaces*, Lecture Notes in Mathematics, Vol. 271, Springer-Verlag, Berlin-New York, 1972.
- [Mos02] Jacob Mostovoy, *Short ropes and long knots*, Topology **41** (2002), no. 3, 435–450.

- [MP12] J. P. May and K. Ponto, *More concise algebraic topology. Localization, completion, and model categories*, Chicago Lectures in Mathematics, University of Chicago Press, Chicago, IL, 2012.
- [MS04a] James E. McClure and Jeffrey H. Smith, *Cosimplicial objects and little  $n$ -cubes. I*, Amer. J. Math. **126** (2004), no. 5, 1109–1153. MR 2089084 (2005g:55011)
- [MS04b] ———, *Operads and cosimplicial objects: an introduction*, Axiomatic, enriched and motivic homotopy theory, NATO Sci. Ser. II Math. Phys. Chem., vol. 131, Kluwer Acad. Publ., Dordrecht, 2004, pp. 133–171.
- [MS18] Syunji Moriya and Keiichi Sakai, *The space of short ropes and the classifying space of the space of long knots*, Algebraic and Geometric Topology **18** (2018), 2859–2873.
- [MV09] Vladimir Merkulov and Bruno Vallette, *Deformation theory of representation of prop(erad)s I*, J. Reine Angew. Math. **534** (2009), 51–106.
- [Rez02] C. Rezk, *Every homotopy theory of simplicial algebras admits a proper model*, Topology and its Applications, Issue 1 **119** (2002), 65–94.
- [Sak14] Keiichi Sakai, *Deloopings of the spaces of long embeddings*, Fund. Math. **227** (2014), no. 1, 27–34.
- [Sal01] P. Salvatore, *Configuration spaces with summable labels*, Cohomological methods in homotopy theory, Progr. Math., vol. 196, Birkhäuser, Basel, 2001, p. 375–395.
- [Sin04] Dev P. Sinha, *Manifold-theoretic compactifications of configuration spaces*, Selecta Math. (N.S.) **10** (2004), no. 3, 391–428. MR 2099074 (2005h:55015)
- [Sin06] ———, *Operads and knot spaces*, J. Amer. Math. Soc. **19** (2006), no. 2, 461–486.
- [Sin09] ———, *The topology of spaces of knots: cosimplicial models*, Amer. J. Math. **131** (2009), no. 4, 945–980. MR 2543919 (2010m:57033)
- [Sma59] Stephen Smale, *The classification of immersions of spheres in Euclidean spaces*, Ann. of Math. **69** (1959), no. 2, 327–344.
- [Sta63] James Dillon Stasheff, *Homotopy associativity of  $H$ -spaces. I, II*, Trans. Amer. Math. Soc. **108** (1963), 293–312.
- [Ste67] Norman Steenrod, *A convenient category of topological spaces*, Michigan Math. J. **14** (1967), 133–152.
- [Tur10] Victor Turchin, *Hodge-type decomposition in the homology of long knots*, J. Topol. **3** (2010), no. 3, 487–534. MR 2684511 (2012a:57035)
- [Tur13] ———, *Context-free manifold calculus and the Fulton-MacPherson operad*, Algebraic and Geometric Topology **13** (2013), 1243–1271.
- [Tur14] ———, *Delooping totalization of a multiplicative operad*, J. Homotopy Relat. Struct. **9** (2014), no. 2, 349–418. MR 3258687
- [Vas92] Victor A. Vassiliev, *Complements of discriminants of smooth maps: topology and applications*, Translations of Mathematical Monographs, vol. 98, American Mathematical Society, Providence, RI, 1992, Translated from Russian by B. Goldfarb.
- [Vog71] Rainer M. Vogt, *Convenient categories of topological spaces for homotopy theory*, Arch. Math. (Basel) **22** (1971), 545–555.
- [Vor99] Alexander A. Voronov, *The Swiss-cheese operad*, Homotopy invariant algebraic structure (Baltimore, MD, 1998), Contemp. Math., vol. 239, Amer. Math. Soc., Providence, RI, 1999, pp. 365–373.



- [Vor00] ———, *Homotopy Gerstenhaber algebras*, Conférence Moshé Flato 1999, Vol. II (Dijon), Math. Phys. Stud., vol. 22, Kluwer Acad. Publ., Dordrecht, 2000, pp. 307–331.
- [Wei99] Michael Weiss, *Embeddings from the point of view of immersion theory. I*, Geom. Topol. **3** (1999), 67–101. MR 1694812 (2000c:57055a)
- [Wei19] ———, *Truncated operads and simplicial spaces*, Tunisian J. Math. **1** (2019), 109–126.
- [Wil17] Thomas Willwacher, *(Non-)formality of the extended Swiss Cheese operads*, arXiv:1706.02945 (2017).

Julien Ducoulombier: Department of Mathematics, ETH Zurich, Ramistrasse 101, Zurich, Switzerland  
E-mail address: [julien.ducoulombier@math.ethz.ch](mailto:julien.ducoulombier@math.ethz.ch)

Victor Turchin: Department of Mathematics, Kansas State University, Manhattan, KS 66506, USA  
E-mail address: [turchin@ksu.edu](mailto:turchin@ksu.edu)