

## Article

# Comparison of Two Energy Management System Strategies for Real-Time Operation of Isolated Hybrid Microgrids

Luis Santiago Azuara-Grande \* , Santiago Arnaltes , Jaime Alonso-Martinez   
and Jose Luis Rodriguez-Amenedo 

Department of Electrical Engineering, Universidad Carlos III de Madrid, 28911 Leganes, Spain; arnalte@ing.uc3m.es (S.A.); jalonsom@ing.uc3m.es (J.A.-M.); amenedo@ing.uc3m.es (J.L.R.-A.)

\* Correspondence: lazuara@ing.uc3m.es

**Abstract:** The propagation of hybrid power systems (solar–diesel–battery) has led to the development of new energy management system (EMS) strategies for the effective management of all power generation technologies related to hybrid microgrids. This paper proposes two novel EMS strategies for isolated hybrid microgrids, highlighting their strengths and weaknesses using simulations. The proposed strategies are different from the EMS strategies reported thus far in the literature because the former enable the real-time operation of the hybrid microgrid, which always guarantees the correct operation of a microgrid. The priority EMS strategy works by assigning a priority order, while the optimal EMS strategy is based on an optimization criterion, which is set as the minimum marginal cost in this case. The results have been obtained using MATLAB/Simulink to verify and compare the effectiveness of the proposed strategies, through a dynamic microgrid model to simulate the conditions of a real-time operation. The differences in the EMS strategies as well as their individual strengths and weaknesses, are presented and discussed. The results show that the proposed EMS strategies can manage the system operation under different scenarios and help power system operator obtain the optimal operation schemes of the microgrid.

**Keywords:** energy management system; battery energy storage system; hybrid systems; optimization; microgrid; renewable energy

**Citation:** Azuara-Grande, L.S.; Arnaltes, S.; Alonso-Martinez, J.; Rodriguez-Amenedo, J.L. Comparison of Two Energy Management System Strategies for Real-Time Operation of Isolated Hybrid Microgrids. *Energies* **2021**, *14*, 6770. <https://doi.org/10.3390/en14206770>

Academic Editors: Mohamed Benbouzid and Pierluigi Siano

Received: 8 September 2021

Accepted: 15 October 2021

Published: 17 October 2021

**Publisher's Note:** MDPI stays neutral with regard to jurisdictional claims in published maps and institutional affiliations.



**Copyright:** © 2021 by the authors. Licensee MDPI, Basel, Switzerland. This article is an open access article distributed under the terms and conditions of the Creative Commons Attribution (CC BY) license (<https://creativecommons.org/licenses/by/4.0/>).

## 1. Introduction

Isolated hybrid microgrids plays a key role for reducing the cost of energy in remote areas without a good grid infrastructure [1,2]. Securing cost-effective electricity is a challenge for isolated communities and installations without access to a strong electric grid. Such communities and installations traditionally rely on engine or turbine generator sets (gensets) that are highly reliable but typically produce power at a much higher cost than a large utility [2].

Nowadays, a better model that combines newly cost-effective renewable energy sources such as wind or sun with conventional diesel or gas generation is emerging. Such hybrid microgrids employ energy storage to improve stability and further reduce costs. Recent technological advances in integrating photovoltaic (PV) and diesel power plants and the decreasing cost of PV installation have increased interest in hybrid microgrids. Conventional power generation using diesel is expensive because the fuel must be transported to remote locations; in addition, diesel gensets are relatively small and thus less efficient than large-scale conventional coal, gas, or nuclear power plants. Thus, solar energy-based electricity generation is highly competitive with diesel-powered electricity generation [3].

The sharp reduction in the cost of wind and solar energy as well as the lower energy storage costs relative to fuel prices make hybrid microgrids well suited for various applications, including individual buildings, resorts, mine sites, remote villages, and small islands. Wind or solar energy reduces reliance on gensets, which reduces fuel consumption and, to

a lesser extent, maintenance costs. Moreover, gensets can support renewable energy and follow the load demand. Sophisticated digital controls tie the hybrid microgrid together. Energy storage enhances system economics and helps gensets respond smoothly to significant output fluctuations from the renewable resources while maintaining a consistent voltage and frequency [2].

Battery energy storage systems (BESSs) can be used to provide a spinning reserve in hybrid microgrids. If a PV array is shaded and power from the solar power plant drops, then a BESS takes over the grid and supplies electricity until one or more diesel gensets are fully ramped up. This advanced concept allows gensets to be switched off during peak irradiation and thus increases the penetration of renewable energy in hybrid microgrids. The PV array is dimensioned accordingly to fulfil electricity needs during peak generation and charge the BESS [4,5].

Within the boundaries of a microgrid, all supply, storage, and demand-side resources can be combined and managed using an energy management system (EMS). In some cases, the EMS is a purpose-built application, and in other cases, it is simply scaled down and adapted from an existing version. A microgrid EMS is designed to maintain balanced and stable operation using numerous other systems and technologies, including remote sensors, switches, inverters, and load control devices. The effectiveness of a microgrid EMS in maintaining stable operation is largely determined by the sophistication of its process automation programming as well as its degree of control over the full range of energy assets and processes within the microgrid. An effective EMS for isolated hybrid microgrids (solar–diesel–battery) is necessary to ensure optimal energy utilization and sustainability to the maximum extent [6,7].

Numerous algorithms have been proposed for microgrid EMSs in the literature. In the study of Kanchev et al. [8], a unit commitment based microgrid EMS is proposed, which comprises a multi-objective function seeking simultaneous minimization of fuel consumption and pollutant emissions. Leonori et al. [9] used a machine learning algorithm to solve the EMS. In the study of Jimeno et al. [10], the EMS was based on a multiagent system, and Celli et al. [11] applied neural networks to construct an EMS. Askarzadeh [12] proposed a memory-based genetic algorithm to optimize power generation. Also, Chen et al. [13] proposed a genetic algorithm optimisation. Azizivahed et al. [14] developed the shuffled frog leaping algorithm, which is a metaheuristic optimization method for the energy dispatch. Palma-Behnke et al. [15] proposed an EMS based on a rolling horizon strategy. An optimal power flow based EMS with multi-objective function considering simultaneous minimization of operation cost, emission, and use of ESS is proposed in [16]. Also, Shi et al. [17] formulated the EMS of a microgrid as an optimal power flow problem. Multiple studies have optimized microgrid operation using model predictive control (MPC) and economic MPC (EMPC) [18–20]. Arcos-Aviles et al. [21] presented the design of a fuzzy logic controller to be embedded in an EMS. Some researchers [22–24] have developed an EMS strategy based on a finite state machine that cover all the operating modes. Further, Teleke et al. [25] proposed an EMS strategy using rule-based control. Other researchers [26,27] have proposed using power management control techniques for microgrids with energy storage. Also, some authors who used HOMER to analyse and optimize the renewable energy sources along with BESS in terms of cost and pollution for an off-grid hybrid energy system [28,29].

Most of the proposed EMS strategies in the literature are based on off-line applications as they have not been developed with specifications for the microgrid operation in real-time, neither considering the dynamic behavior of the microgrid. Given the intermittent nature of renewable energy resources involved, the constant variation in load demand and the multiple objectives that need to be satisfied, the EMS needs to find solutions quickly and continuously. Therefore, off-line applications are not representative of a real operation since the constant flow of data required to update the status of the generators in short periods of time is only available in a real-time operation. In this way, the EMS must be support real-time control of the electric power grid. And thus, guarantee the stability thanks to

continuous real-time monitoring and control of the isolated hybrid microgrid. The problem that needs to be solved regarding real-time operation is not related to computation time, since the EMS optimizations usually run at relatively long-time steps. The problem is to properly integrate an energy management strategy with the remaining controls of the microgrid that guarantee its stability, safely managing diesel consumption, PV curtailments and battery operation under unexpected load and PV resource changes, while staying as close as possible to optimal operation.

The objective of this study was to develop EMS strategies for the real-time operation of isolated hybrid microgrids so that they can be applied to real environments. Accordingly, two EMS strategies were developed using a dynamic model of the microgrid, simulating the conditions of a real-time operation. The first, called the priority EMS strategy, works by assigning a priority order, while the optimal EMS strategy responds to an optimization criterion, which is set to the minimum marginal cost in this case. An annual yield study was conducted to verify and compare the operations of a microgrid using both strategies. The paper is organised as follows: Section 2 presents the dynamic microgrid model and its main characteristics. Section 3 describes the priority EMS strategy, and Section 4 describes the optimal EMS strategy. Section 5 presents and discusses the simulation results of the annual yield study. Finally, Section 6 presents the conclusions regarding the proposed strategies.

## 2. Dynamic Microgrid Model

To make a fair comparison, a dynamic microgrid model with the same characteristics was used to compare the two proposed strategies. The model comprised a PV plant, three diesel gensets, and a BESS; Table 1 gives the characteristics, and Figure 1, shows the arrangement of this model. The characteristics and the arrangement of the dynamic microgrid model were obtained from an existing isolated hybrid microgrid located in Colombia. Moreover, the data on the solar irradiation and load demand were obtained from the same real system described above. The maximum and minimum load demands were 3.5 and 1 MW, respectively, as shown in Figure 2. Thus, it is a small isolated microgrid that provides electricity to a small population and its corresponding daily activities.

**Table 1.** Elements of the hybrid microgrid model.

<b>Diesel Gensets × 3</b>	<b>Values</b>
Rated power (kW)	2000
Minimum load (kW)	400
Spinning reserve (kW)	700
Fuel cost (€/MWh)	197
Hourly wearing cost (€/h)	1000
<b>PV Plant</b>	<b>Values</b>
AC power (kW)	4000
DC power (kWp)	5000
<b>BESS</b>	<b>Values</b>
Power (kW)	1200
Capacity (kWh)	4800
Roundtrip efficiency (%)	81
Degradation cost (€/MWh)	81

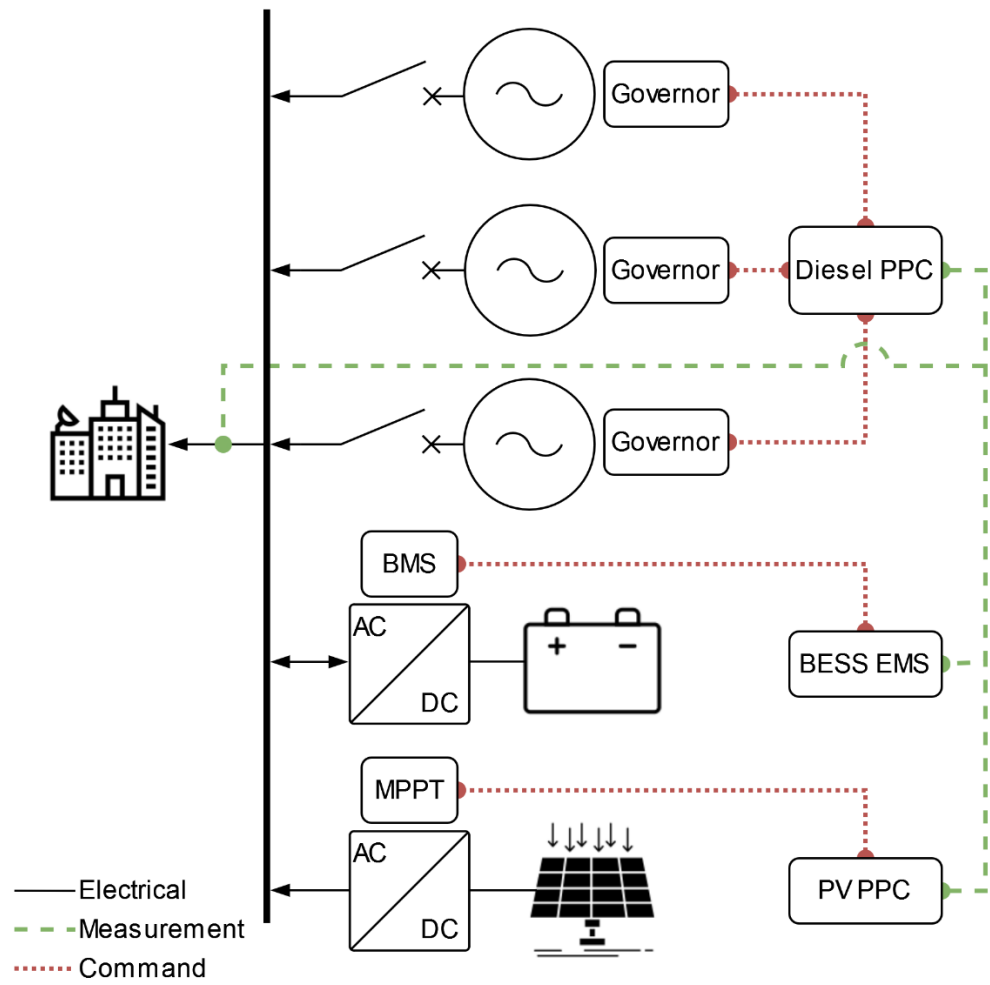

Figure 1. Configuration of an isolated hybrid microgrid.

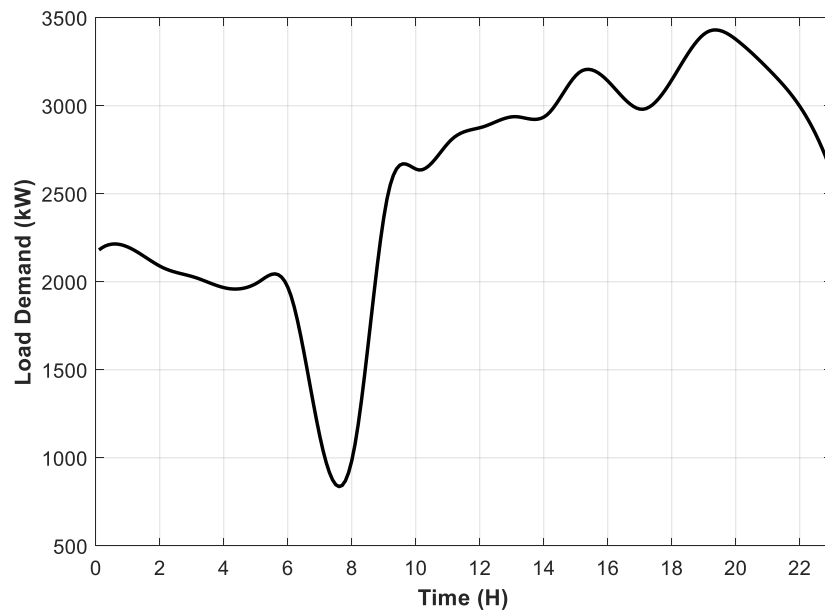

Figure 2. Load demand.

Simulation models for the synchronous generators of the diesel gensets, the PV plant and the BESS were obtained from the MATLAB/Simulink Simscape library. The dynamic

model of the microgrid allows to obtain continuous feedback from the generation units to the EMS controllers, simulating the conditions of a real-time operation.

### 3. Priority EMS Strategy

The priority EMS strategy is based on a decentralized architecture. The corresponding algorithm implements a fixed set of rules that describe the dispatch priority for each energy source present in the microgrid. Any change in the relative priorities of the energy sources would require completely rewriting of the algorithm. In this case, the dispatch priority rules of the EMS strategy are the following, in order:

- Minimize diesel power generation but keep each running genset above its technical minimum power setpoint if possible.
- Maximize PV power generation. Only curtail if strictly necessary.
- Charge the BESS only with excess energy and discharge it only if this reduces diesel consumption.

This set of rules is equivalent to minimizing the operating costs considering that diesel has the highest marginal cost, followed by BESS and PV. In this case, the economic value of the energy stored in the BESS is always constant. The energy is not saved for future use when it is more valuable; instead, it is stored and used as soon as the dispatch priority conditions are met. The priority EMS strategy is implemented using two local controllers: a diesel controller and a joint PV–BESS EMS controller. Communication between these two controllers is minimized to increase robustness. The only communication requirement is that the PV–BESS EMS controller needs the current diesel-generated power  $P_{\text{diesel}}$  and number of running gensets  $N_G$  as inputs. A degraded suboptimal operation mode can be implemented to guarantee system stability if the communication link between the controllers is down.

#### 3.1. Diesel Power Plant Controller

Diesel gensets regulate the voltage and frequency of the dynamic microgrid model, in the same way as in the real system, since the PV plant and the BESS do not have these control capabilities implemented. By controlling the voltage and frequency, the gensets bus becomes the slack bus of the microgrid, closing automatically the active and reactive power balances in the microgrid.

The diesel genset active power reference is therefore provided by a local governor that regulates generator speed, closing the active power balance of the microgrid and maintaining constant the frequency, which is modelled as automatic generation control (AGC) with an internal droop. While, on the other hand, the automatic voltage regulator (AVR) obtains the generator reactive power needed to maintain constant voltage and, thus, closing the reactive power balance of the microgrid [30]. In this way, the voltage and frequency regulation prevent the measurement of the demand active and reactive powers by the EMS, which is an additional advantage.

The diesel gensets also serve as microgrid power reserves. The controller accordingly turns the gensets on and off to keep the spinning reserve above a threshold value. Running a higher number of gensets increases the spinning reserves but also decreases efficiency because each genset is operating at a lower load. This is resolved with a fixed target minimum spinning reserve  $R_{\text{up}}^{\text{min}}$ , although the same algorithm can be used with a variable  $R_{\text{up}}^{\text{min}}$  that depends on the system load or PV generation. The current reserve  $R_{\text{up}}$  is computed from the number of running gensets  $N_G$ ; rated power for each individual genset  $P_G^{\text{max}}$ , which is assumed to be the same for all gensets; and current total power generated by the diesel gensets  $P_{\text{diesel}}$  following (1). If  $R_{\text{up}} < R_{\text{up}}^{\text{min}}$ , an additional genset is started:

$$R_{\text{up}} = N_G \cdot P_G^{\text{max}} - P_{\text{diesel}}, \quad (1)$$

To know when to stop gensets, the reserve  $R_{up}^{stop}$  in the case in which one running genset is stopped is computed as follows (2):

$$R_{up}^{stop} = (N_G - 1) \cdot P_G^{max} - P_{diesel} \tag{2}$$

Whenever  $R_{up}^{stop} > R_{up}^{min} + h_G$  a genset is stopped. A hysteresis term  $h_G$  is added to avoid starting and stopping gensets cyclically whenever the reserves are close to the minimum. Thus, the operation of the diesel gensets does not require any special functionality. Almost any existing diesel system can be integrated into this EMS strategy without modification. This is a welcome feature considering that diesel-based systems are currently being retrofitted with PV and/or BESSs to reduce diesel consumption.

### 3.2. PV-BESS EMS Controller

Figure 3 shows the PV-BESS EMS controller, which outputs the power setpoint for the battery  $P_{BESS}^{ref}$  and the curtailment signal for the PV plant  $P_{PV}^{lim}$ , which are expressed in terms of per unit of the rated power. A negative power value for the battery corresponds to charging. This controller aims to bring the total genset power  $P_{diesel}$  as close as possible to the current minimum  $P_{diesel}^{min}$  that is computed using Equation (3):

$$P_{diesel}^{min} = N_G P_G^{min} \tag{3}$$

This is achieved using an integral controller, whose output  $D^{ref}$  determines the operation of both the BESS and PV plant when it is translated to values for  $P_{BESS}^{ref}$  and  $P_{PV}^{lim}$  through an offset and two saturations, as shown in Figure 3.

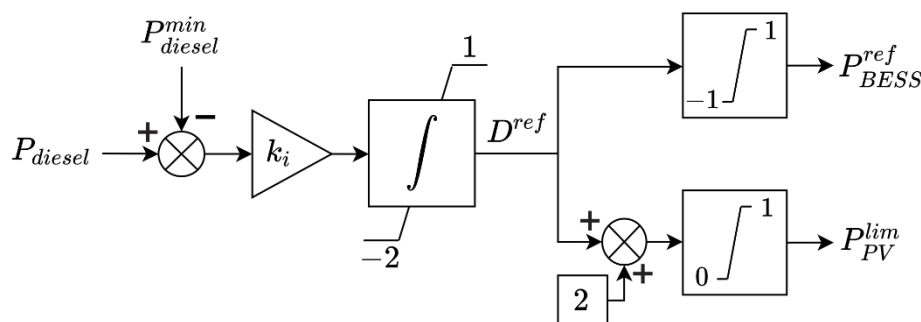

Figure 3. Priority EMS strategy.

Table 2 lists the different values for  $D^{ref}$ , their corresponding  $P_{BESS}^{ref}$  and  $P_{PV}^{lim}$  values, and a description of the resulting operating modes.

Table 2. Integral controller action and the corresponding power setpoints and limits.

$D^{ref}$	$P_{BESS}^{ref}$	$P_{PV}^{lim}$	Operation Mode
1	1	1	BESS max discharging, no PV curtailed
(0,1)	(0,1)	1	BESS discharging, no PV curtailed
0	0	1	No BESS, no PV curtailed
(-1,0)	(-1,0)	1	BESS charging, no PV curtailed
-1	-1	1	BESS max charging, no PV curtailed
(-2,-1)	-1	(0,1)	BESS max charging, PV curtailed
-2	-1	0	BESS max charging, no PV power

As an example, let us assume that the battery is empty, the load is constant, there is no PV generation, and  $P_{diesel} > P_{diesel}^{min}$  for a sufficiently long time so that  $D^{ref} = 1$ . Further, suppose the PV generation starts increasing, which causes the genset power generation to decrease. At some point,  $P_{diesel} < P_{diesel}^{min}$ , so  $D^{ref}$  starts decreasing. When  $D^{ref} < 0$ ,

the BESS starts charging, which should reduce the genset power generation back to its technical minimum. If this is not sufficient because excess PV power cannot be stored in the BESS (because of either power or capacity limits), eventually  $D^{\text{ref}}$  falls below  $-1$  and the excess PV power is curtailed. If the available PV power starts decreasing, at some point  $P_{\text{diesel}} > P_{\text{diesel}}^{\text{min}}$ , which causes  $D^{\text{ref}}$  to start increasing. First, the PV curtailment is released. If  $D^{\text{ref}}$  reaches  $-1$ , the PV operation goes back to maximum power point tracking. If  $D^{\text{ref}}$  reaches  $0$ , the energy stored in the BESS is released to the microgrid to bring the gensets to the minimum level of operation. The BESS power setpoint  $P_{\text{BESS}}^{\text{ref}}$  is sent to the battery management system (BMS), and thus, it is not necessarily applied as received. For example, if the battery is full or almost full, any attempt to charge it further is limited to the available maximum charging power by the BMS.

The integral gain  $k_i$  for the controller should be as high as possible to achieve efficient operation, although there is a stability limit due to the speed at which the battery setpoint and the PV limit are applied, as well as the genset controller dynamics. Both the battery and PV plant are usually capable of fast power dynamics, but the communication link may have a significant latency that should be considered.

The integration of the PV and BESS EMS controllers into a single scheme has the advantage of ensuring that there are no coordination problems between the two components. With separate controllers, either careful tuning of the controllers or additional communications would be required to guarantee that the dispatch priorities are always met. One disadvantage of this EMS strategy is the lack of forecasting of load demand and renewable power generation. The strategy can only deal with variations in real-time and cannot predict variations in advance. However, this makes this strategy quite simple as well as robust.

#### 4. Optimal EMS Strategy

The optimal EMS strategy is based on a centralized architecture. It optimizes the management of the dispatch based on the chosen variable, such as costs, emissions, or energy. Once the variable is selected, the EMS itself decides how to manage the dispatch. In this case, it is decided that the optimization is based on the marginal costs of each generation technology of the hybrid microgrid. The only inputs to the EMS are the marginal costs assigned by the power system operator to each generation technology; therefore, the objective of the EMS is to find the optimal solution to the problem.

The optimal operation of the microgrid is obtained using mixed-integer linear programming, and the optimization toolbox in MATLAB is used to solve the optimization problem. This EMS requires forecasting data (i.e., load demand and renewable generation) to anticipate future events. Although in this first step of the development of the control strategy, the forecasting of load demand and PV generation are without errors.

Accordingly, the problem is formulated as a rolling horizon control (RHC) scheme that periodically updates input data information from the dynamic microgrid model. The optimization problem is solved at each time step to determine the operating schedule of the system over a fixed time horizon, but only the first output from this plan is applied to the system. In the next time step, the process is repeated; in other words, a new optimization problem is solved with the time horizon shifted one step forward. The optimization problem takes into account the forecasting of future values based on available forecasts at each time step [31].

However, unlike other optimization strategies using RHC reported in the literature, the proposed optimal EMS strategy allows the solution of the optimization problem to be applied to real-time operation because, of the entire operation plan that is obtained from the optimization at each time step, only the first time-step output from BESS power reference is applied to the operation in real-time. Further, the PV plant power curtailment is still controlled by the priority EMS strategy, from which the BESS power reference has been eliminated at an output of the integral controller, as shown in Figure 4.

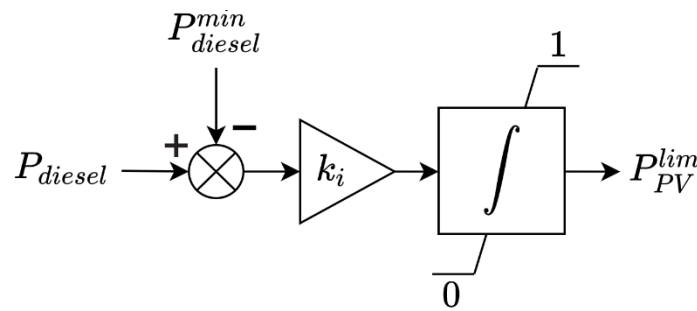

Figure 4. Integral controller scheme without the BESS.

Authors should discuss the results and how they can be interpreted from the perspective of previous studies and of the working hypotheses. The findings and their implications should be discussed in the broadest context possible. Future research directions may also be highlighted.

Thus, the main contribution of this strategy is the optimization of the BESS based on forecasting, while the entire microgrid, including the BESS, is operated in real-time through the dynamic model. This provides a great advantage for the better utilization of current and future energy resources. The objective function and the constraints of the optimization problem are represented by the following Equations (4)–(16):

#### 4.1. Objective Function

The objective function of the optimization problem is to obtain the total minimal marginal cost for a time horizon of N hours:

$$\text{Min} \sum_{t=1}^N \left( \begin{array}{l} ((N_1(t) + N_2(t) + N_3(t)) \cdot \text{Hourly Cost}) + \\ (P_{\text{Gen}}(t) \cdot \text{Fuel Cost}) + (\Delta\text{SoH}(t) \cdot \text{Degradation Cost}) \end{array} \right), \quad (4)$$

where the binary variables  $N_i$  indicate the on/off status for gensets ( $N_i = 1$ , on) and ( $N_i = 0$ , off),  $P_{\text{Gen}}$  represents the power output from running gensets, Hourly Cost is the hourly wearing cost for each genset, Fuel Cost represents the fuel cost, and Degradation Cost is the cost of cycling the BESS.

#### 4.2. Constraints

The constraints of the optimization problem are given below. The power balance is given by:

$$P_{\text{Load}}(t) = P_{\text{Gen}}(t) + P_{\text{PVF}}(t) + P_{\text{BESSD}}(t) - P_{\text{BESSC}}(t), \quad (5)$$

where  $P_{\text{Load}}$  is the load demand power,  $P_{\text{PVF}}$  is the final PV plant power output,  $P_{\text{BESSD}}$  is the BESS discharging power, and  $P_{\text{BESSC}}$  is the BESS charging power.

The PV plant curtailment is given by:

$$P_{\text{PVA}}(t) \geq P_{\text{PVF}}(t) \geq 0, \quad (6)$$

where  $P_{\text{PVA}}$  is the available PV plant power output.

The diesel genset limits are given by:

$$P_{\text{Max}} \cdot (N_1(t) + N_2(t) + N_3(t)) \geq P_{\text{Gen}}(t) \geq P_{\text{Min}} \cdot (N_1(t) + N_2(t) + N_3(t)), \quad (7)$$

where  $P_{\text{Max}}/P_{\text{Min}}$  are the upper and lower gensets thresholds, respectively.

The spinning reserve is given by:

$$(P_{\text{Max}} \cdot (N_1(t) + N_2(t) + N_3(t))) - P_{\text{Gen}}(t) \geq \text{SR} \cdot (N_1(t) + N_2(t) + N_3(t)), \quad (8)$$

where SR is the fixed spinning reserve required for gensets.



The number of diesel gensets turned on is given by:

$$(N_1(t) + N_2(t) + N_3(t)) \geq 1, \quad (9)$$

where the binary variables  $N_i$  are introduced to avoid the simultaneous shutdown of all gensets because at least one synchronous genset is required to generate the grid voltage and frequency control.

The battery state of charge (SoC) limits are given by:

$$\text{SoC}(t) = \text{SoC}(t-1) + (P_{\text{BESSC}}(t-1) \cdot \eta) - (P_{\text{BESSD}}(t-1)/\eta), \quad (10)$$

where SoC represents the SoC of the BESS and  $\eta$  is the BESS charge/discharge efficiency.

The battery SoC limits are given by:

$$\text{SoC}_{\text{Max}} \geq \text{SoC}(t) \geq \text{SoC}_{\text{Min}}, \quad (11)$$

where  $\text{SoC}_{\text{Max}}$  and  $\text{SoC}_{\text{Min}}$  are the upper and lower SoC limits, respectively.

The BESS mode is given by:

$$(N_{\text{Charge}}(t) + N_{\text{Discharge}}(t)) \leq 1, \quad (12)$$

where the binary variables  $N_{\text{Charge}}$  and  $N_{\text{Discharge}}$  are introduced to avoid simultaneous charge/discharge commands.

The BESS power limits are given by:

$$(P_{\text{BESSMax}} \cdot N_{\text{Charge}}(t)) \geq P_{\text{BESSC}}(t), \quad (13)$$

$$(P_{\text{BESSMax}} \cdot N_{\text{Discharge}}(t)) \geq P_{\text{BESSD}}(t), \quad (14)$$

where  $P_{\text{BESSMax}}$  is the upper BESS power threshold.

A simplified degradation model based on the battery energy throughput was used. Batteries have an initial capacity, generally called beginning-of-life (BoL) capacity. After a number of cycles (for lithium-ion batteries, typically around 5000 to 7000 cycles, depending on the operational depth of discharge (DoD) and C-rate according to the battery manufacturer's warranty curves), the battery reaches the end-of-life capacity (typically around 60–70% of the BoL capacity). Therefore, for each time step that a battery is used, the charge and discharge energy is summed until the energy for the total number of cycles is reached.

The battery state of health (SoH) is given by:

$$\text{SoH}(t) = \text{SoH}(t-1) - P_{\text{BESSC}}(t-1) - P_{\text{BESSD}}(t-1), \quad (15)$$

where SoH represents the state of health of the battery in terms of the remaining usable energy of the battery throughout its lifetime.

The battery SoH increase is given by:

$$\Delta\text{SoH}(t) = \text{SoH}(t-1) - \text{SoH}(t), \quad (16)$$

where  $\Delta\text{SoH}$  represents the reduction in the battery SoH.

The main disadvantages of this centralized architecture are as follows. First, a wide and reliable communication network is needed between the central optimizer and local controllers to send the power limits and receive measurements. Second, the forecasting and measurement data required for the real-time operation of the EMS increase or decrease depending on the forecasting period, which affects the calculation time and computational capacity. Finally, the equations that form the microgrid in the optimization problem must be formulated to accurately represent the real behaviour of the microgrid and all its elements (i.e., the diesel gensets, PV plant, and BESS).

## 5. Results and Discussion

Two simulations were performed for 8760 h (i.e., 1 year) through the dynamic micro-grid model to analyse the behaviour of both EMS strategies. The simulations took place over 1 year because the analysis of a short period may not be representative or cover a wide range of scenarios. For the optimal EMS, a time horizon of 24 h and a time interval of 1 hour have been used. Figures 5 and 6 show the simulation results for one day of week 9 and Figures 7 and 8 show two days of week 19 of the year.

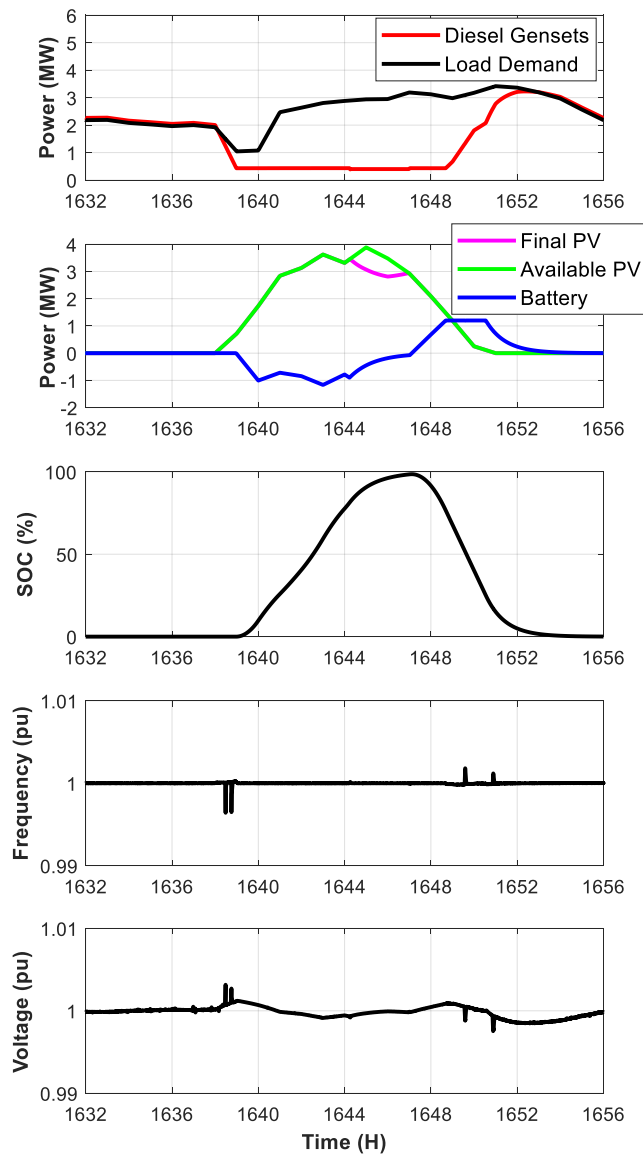

Figure 5. Microgrid operation for one day in summer using the priority EMS Strategy.

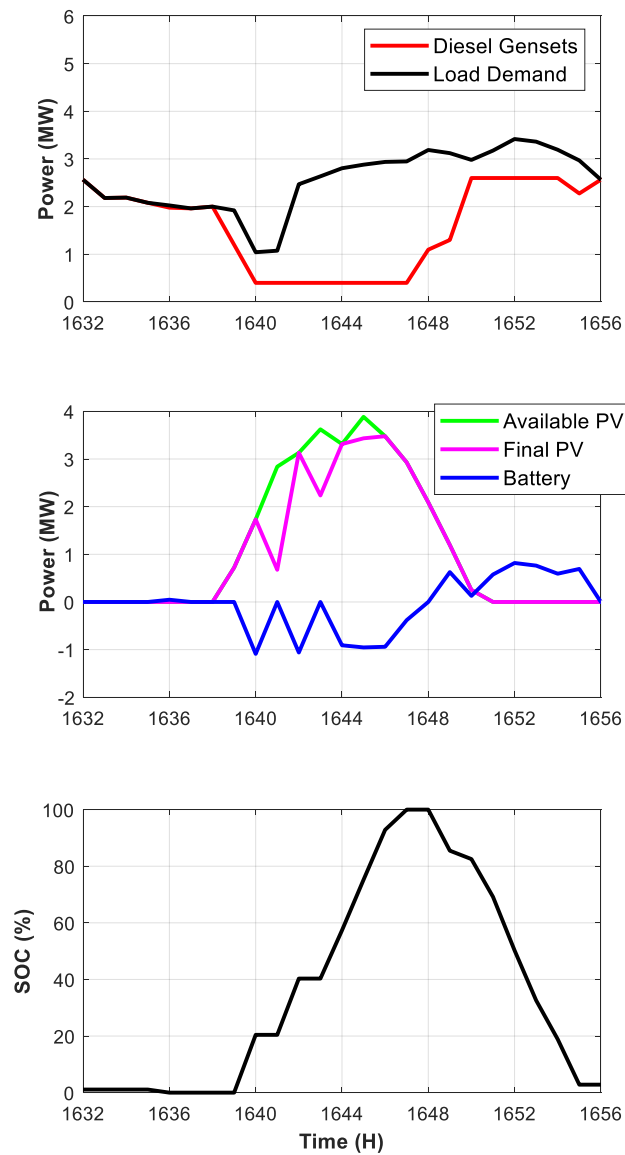

Figure 6. Microgrid operation for one day in summer using the optimal EMS Strategy.

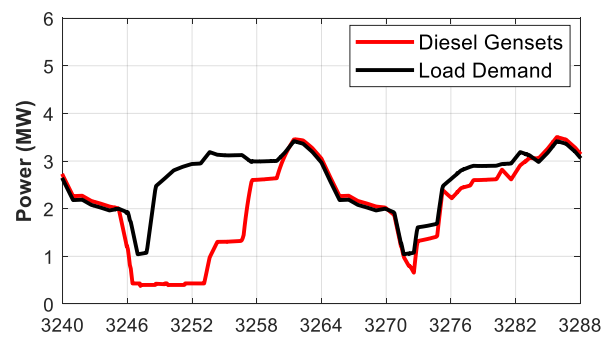

Figure 7. Cont.

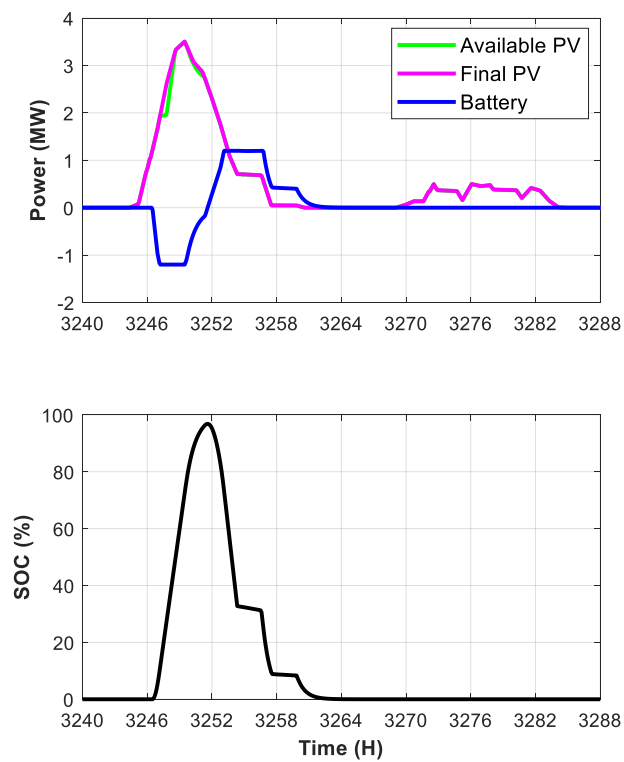

Figure 7. Microgrid operation for two days in winter using the priority EMS Strategy.

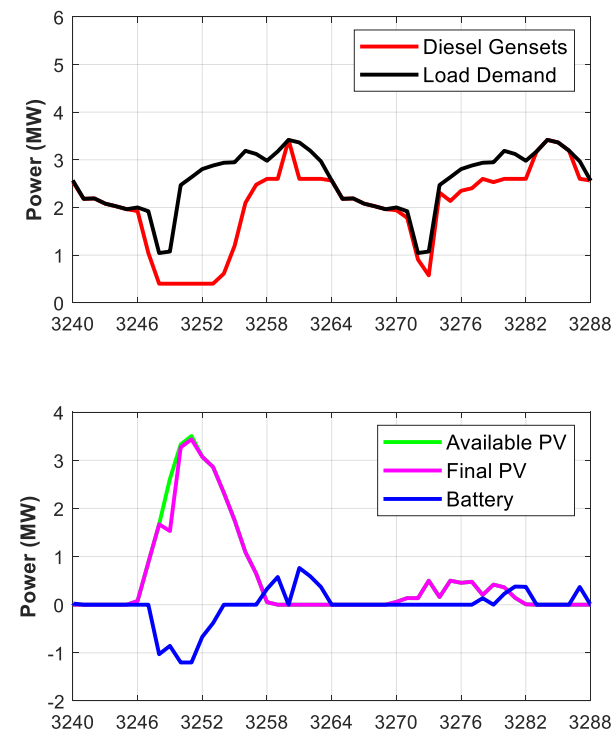
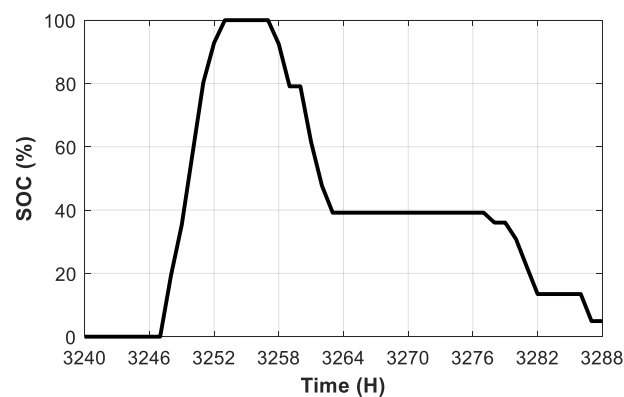

Figure 8. Cont.



**Figure 8.** Microgrid operation for two days in winter using the optimal EMS Strategy.

In week 9 (Figures 5 and 6), the optimal EMS strategy established a low discharge rate for the BESS to support the diesel gensets and not exceed the fixed spinning reserve limit to avoid turning on the next diesel genset. Thus, the diesel gensets ran at the spinning reserve limit longer than with the priority EMS strategy, as observed for the last hours of the day (1650–1656 h).

The lower discharge rate increased the availability of the BESS. By contrast, the priority EMS strategy discharged the BESS at maximum power as soon as the renewable energy decreased (1646–1651 h) to operate the diesel gensets at the minimum load. This reduced the availability of the BESS. In both strategies, the BESS was able to meet the demand if the required power was less than the nominal power of its converter or the BESS was not empty.

Figure 5 also includes the grid frequency and voltage profile which shows a frequency drop when the diesel gensets 2 and 3 are turned off at sunrise (at  $t = 1638$  h and  $1639$  h) and a frequency rise when the diesel gensets 2 and 3 are turned on at sunset (at  $t = 1649$  h and  $1651$  h). Those events also produce a disturbance in the voltage as shown in the figure.

In week 19 (Figures 7 and 8), the optimal EMS strategy did not completely discharge the BESS at the end of the day because the forecast data reported a lack of solar energy for the next 24 h. The next day, the BESS was discharged (3278–3288 h) to avoid the third genset being turned on during peak demand hours. By contrast, the priority EMS strategy completely discharged the BESS as soon as the solar energy decreased (3252–3260 h) without leaving any reserve capacity for the next day. Table 3 presents the accumulated values of the most representative variables for 8760 h for a numerical analysis of both EMS strategies.

**Table 3.** Results with accumulated values.

1 Year Simulation		Priority EMS	Optimal EMS
PV plant	Energy Total (kWh)	7,179,052	7,179,052
	Energy Final (kWh)	6,525,180	6,783,870
	Excess (kWh)	649,240	395,182
Diesel Gensets	Energy Total (kWh)	15,982,320	15,741,236
BESS	Energy Throughput (kWh)	956,947	1,038,597
	Energy In (kWh)	1,055,020	1,145,473
	Energy Out (kWh)	858,875	931,721
Load (kWh)		22,311,355	22,311,355
Total Costs of Energy (€)		3,226,029	3,185,149

The results in the Table 3 show that the optimal EMS strategy allows a higher penetration of renewable energy due to a better adjustment of the charging and discharging of the BESS, which reduces the diesel generation of the diesel gensets, because of the cost

of energy minimization. On the other hand, the priority EMS strategy produce a slightly worse result, although not that far from the optimal EMS strategy, leading to a slightly smaller penetration of renewable energy, thereby increasing the diesel generation, which in turn results in a slightly higher cost of energy. The reason for these results is that while in the priority EMS the battery discharging (if possible) has priority over the gensets loading, the optimal EMS considers the cost of the battery energy in the following hours to take the decision on when to discharge the battery.

## 6. Conclusions

Two novel EMS strategies were developed for an isolated hybrid microgrid that run online using a dynamic microgrid model, that simulates the conditions of a real-time operation. The simulation results quantified the differences between the strategies and showed their respective advantages and disadvantages.

The optimal EMS strategy allows better use of the BESS based on the forecasted load demand and renewable energy generation. Additionally, it increases renewable penetration and reduces diesel generation. The main drawback of the optimal EMS strategy is prediction errors, which can reduce the advantage. Furthermore, the centralized structure of this strategy makes it more complex and vulnerable to failures than the priority EMS strategy because continuous communication is required.

The priority EMS strategy performed worse than the optimal EMS strategy in terms of supplying energy, which slightly increased the total costs. However, the decentralized structure of this strategy simplifies the EMS scheme, which is integrated into each plant controller. Therefore, this strategy is modular and easily scalable.

In conclusion, the choice of EMS strategy depends on the specifications of the microgrid. If a power system requires a high level of reliability, the priority EMS strategy should be chosen because the increase in energy costs can be small compared with the consequences of an interruption in the power supply. By contrast, if all generation technologies of the microgrid are arranged at the same site, the optimal EMS strategy may be preferable because communication is not a significant issue.

Future works related to this topic could involve analysing the consequences of forecasting errors, which could eliminate the advantage of the optimal EMS strategy over the priority EMS strategy.

**Author Contributions:** L.S.A.-G.: Conceptualization, Software, Validation, Investigation, Writing—original draft, Visualization, Formal analysis, Investigation. S.A.: Conceptualization, Validation, Supervision, Writing—review & editing. J.A.-M.: Validation, Software, Supervision, Investigation, Resources, Writing—review & editing. J.L.R.-A.: Supervision, Writing—review & editing. All authors have read and agreed to the published version of the manuscript.

**Funding:** This work was supported by the Autonomous Community of Madrid under the PROMINT-CM project (S2018/EMT-4366).

**Institutional Review Board Statement:** Not applicable.

**Informed Consent Statement:** Not applicable.

**Data Availability Statement:** Not applicable.

**Conflicts of Interest:** The authors declare no conflict of interest.

## References

1. Al-Hammad, H.; Becker, T.; Bode, A.; Gupta, S.; Kreibiehl, S. *Renewable Energy in Hybrid Mini-Grids and Isolated Grids: Economic Benefits and Business Cases*; Fs\_Unep; Frankfurt School—UNEP Collaborating Centre for Climate and Sustainable Energy Finance: Frankfurt, Germany, 2015; p. 88.
2. IRENA. *Pacific Lighthouses: Hybrid Power Systems*; IRENA: Abu Dhabi, United Arab Emirates, 2013.
3. Saury, F.-X.; Tomlinson, C. *Hybrid Microgrids: The Time is Now*; Caterp. Inc.: Deerfield, IL, USA, 2016; pp. 1–12.
4. IRENA (International Renewable Energy Agency). *The Power to Change: Solar and Wind Cost Reduction Potential to 2025*; IRENA: Abu Dhabi, United Arab Emirates, 2016. Available online: [www.irena.org/publications](http://www.irena.org/publications) (accessed on 15 September 2021).

5. Nehrir, M.H.; Wang, C.; Strunz, K.; Aki, H.; Ramakumar, R.; Bing, J.; Miao, Z.; Salameh, Z. A Review of Hybrid Renewable/Alternative Energy Systems for Electric Power Generation: Configurations, Control, and Applications. *IEEE Trans. Sustain. Energy* **2011**, *2*, 392–403. [[CrossRef](#)]
6. Burr, M.T.; Zimmer, M.J.; Meloy, B.; Bertrand, J.; Levesque, W.; Warner, G.; McDonald, J.D. *Minnesota Microgrids: Barriers, Opportunities, and Pathways Toward Energy Assurance*; Minnesota Department of Commerce: St Paul, MN, USA, 2013.
7. Pourmousavi, S.A.; Nehrir, M.H.; Colson, C.M.; Wang, C. Real-Time Energy Management of a Stand-Alone Hybrid Wind-Microturbine Energy System Using Particle Swarm Optimization. *IEEE Trans. Sustain. Energy* **2010**, *1*, 193–201. [[CrossRef](#)]
8. Kanchev, H.; Colas, F.; Lazarov, V.; Francois, B. Emission Reduction and Economical Optimization of an Urban Microgrid Operation Including Dispatched PV-Based Active Generators. *IEEE Trans. Sustain. Energy* **2014**, *5*, 1397–1405. [[CrossRef](#)]
9. Leonori, S.; Martino, A.; Mascioli, F.M.F.; Rizzi, A. Microgrid Energy Management Systems Design by Computational Intelligence Techniques. *Appl. Energy* **2020**, *277*, 115524. [[CrossRef](#)]
10. Jimeno, J.; Anduaga, J.; Oyarzabal, J.; Gil de Muro, A. Architecture of a microgrid energy management system. *Eur. Trans. Electr. Power* **2011**, *21*, 1142–1158. [[CrossRef](#)]
11. Celli, G.; Pilo, F.; Pisano, G.; Soma, G.G. Optimal participation of a microgrid to the energy market with an intelligent EMS. In Proceedings of the 2005 International Power Engineering Conference, Singapore, 29 November–2 December 2005; p. 663.
12. Askarzadeh, A. A Memory-Based Genetic Algorithm for Optimization of Power Generation in a Microgrid. *IEEE Trans. Sustain. Energy* **2018**, *9*, 1081–1089. [[CrossRef](#)]
13. Chen, C.; Duan, S.; Cai, T.; Liu, B.; Hu, G. Smart energy management system for optimal microgrid economic operation. *IET Renew. Power Gener.* **2011**, *5*, 258–267. [[CrossRef](#)]
14. Azizivahed, A.; Arefi, A.; Ghavidel, S.; Shafie-Khah, M.; Li, L.; Zhang, J.; Catalao, J.P.S. Energy Management Strategy in Dynamic Distribution Network Reconfiguration Considering Renewable Energy Resources and Storage. *IEEE Trans. Sustain. Energy* **2020**, *11*, 662–673. [[CrossRef](#)]
15. Palma-Behnke, R.; Benavides, C.; Lanas, F.; Severino, B.; Reyes-Chamorro, L.; Llanos, J.; Saez, D. A Microgrid Energy Management System Based on the Rolling Horizon Strategy. *IEEE Trans. Smart Grid* **2013**, *4*, 996–1006. [[CrossRef](#)]
16. Conti, S.; Nicolosi, R.; Rizzo, S.A.; Zeineldin, H.H. Optimal Dispatching of Distributed Generators and Storage Systems for MV Islanded Microgrids. *IEEE Trans. Power Deliv.* **2012**, *27*, 1243–1251. [[CrossRef](#)]
17. Shi, W.; Xie, X.; Chu, C.-C.; Gadh, R. Distributed Optimal Energy Management in Microgrids. *IEEE Trans. Smart Grid* **2015**, *6*, 1137–1146. [[CrossRef](#)]
18. Olivares, D.E.; Canizares, C.A.; Kazerani, M. A Centralized Energy Management System for Isolated Microgrids. *IEEE Trans. Smart Grid* **2014**, *5*, 1864–1875. [[CrossRef](#)]
19. Solanki, B.V.; Bhattacharya, K.; Canizares, C.A. A Sustainable Energy Management System for Isolated Microgrids. *IEEE Trans. Sustain. Energy* **2017**, *8*, 1507–1517. [[CrossRef](#)]
20. Clarke, W.C.; Brear, M.J.; Manzie, C. Control of an isolated microgrid using hierarchical economic model predictive control. *Appl. Energy* **2020**, *280*, 115960. [[CrossRef](#)]
21. Arcos-Aviles, D.; Pascual, J.; Marroyo, L.; Sanchis, P.; Guinjoan, F. Fuzzy Logic-Based Energy Management System Design for Residential Grid-Connected Microgrids. *IEEE Trans. Smart Grid* **2018**, *9*, 530–543. [[CrossRef](#)]
22. Wang, J.; Zhao, C.; Pratt, A.; Baggu, M. Design of an advanced energy management system for microgrid control using a state machine. *Appl. Energy* **2018**, *228*, 2407–2421. [[CrossRef](#)]
23. Kafetzis, A.; Ziogou, C.; Panopoulos, K.; Papadopoulou, S.; Seferlis, P.; Voutetakis, S. Energy management strategies based on hybrid automata for islanded microgrids with renewable sources, batteries and hydrogen. *Renew. Sustain. Energy Rev.* **2020**, *134*, 110118. [[CrossRef](#)]
24. Saleh, M.; Esa, Y.; Mohamed, A. Centralized control for DC microgrid using finite state machine. In Proceedings of the 2017 IEEE Power & Energy Society Innovative Smart Grid Technologies Conference (ISGT), Washington, DC, USA, 23–26 April 2017; pp. 1–5.
25. Teleke, S.; Baran, M.E.; Bhattacharya, S.; Huang, A.Q. Rule-Based Control of Battery Energy Storage for Dispatching Intermittent Renewable Sources. *IEEE Trans. Sustain. Energy* **2010**, *1*, 117–124. [[CrossRef](#)]
26. Worku, M.Y.; Hassan, M.A.; Abido, M.A. Real Time Energy Management and Control of Renewable Energy based Microgrid in Grid Connected and Island Modes. *Energies* **2019**, *12*, 276. [[CrossRef](#)]
27. Merabet, A.; Ahmed, K.T.; Ibrahim, H.; Beguenane, R.; Ghias, A.M.Y.M. Energy Management and Control System for Laboratory Scale Microgrid Based Wind-PV-Battery. *IEEE Trans. Sustain. Energy* **2017**, *8*, 145–154. [[CrossRef](#)]
28. Kazem, H.A.; Al-Badi, H.A.S.; Al Busaidi, A.S.; Chaichan, M.T. Optimum design and evaluation of hybrid solar/wind/diesel power system for Masirah Island. *Environ. Dev. Sustain.* **2017**, *19*, 1761–1778. [[CrossRef](#)]
29. Shezan, S.; Julai, S.; Kibria, M.; Ullah, K.; Saidur, R.; Chong, W.T.; Akikur, R. Performance analysis of an off-grid wind-PV (photovoltaic)-diesel-battery hybrid energy system feasible for remote areas. *J. Clean. Prod.* **2016**, *125*, 121–132. [[CrossRef](#)]
30. Kundur, P.; Balu, N.J.; Lauby, M.G. *Power System Stability and Control*; McGraw-Hill Education: New York, NY, USA, 1994.
31. Mattingley, J.; Wang, Y.; Boyd, S. Receding Horizon Control. *IEEE Control Syst.* **2011**, *31*, 52–65. [[CrossRef](#)]