



TITLE:

De Novo Genome Assembly of the Japanese Wheat Cultivar Norin 61 Highlights Functional Variation in Flowering Time and Fusarium-Resistant Genes in East Asian Genotypes

AUTHOR(S):

Shimizu, Kentaro K; Copetti, Dario; Okada, Moeko; Wicker, Thomas; Tameshige, Toshiaki; Hatakeyama, Masaomi; Shimizu-Inatsugi, Rie; ... Sese, Jun; Nasuda, Shuhei; Handa, Hirokazu

CITATION:

Shimizu, Kentaro K ...[et al]. De Novo Genome Assembly of the Japanese Wheat Cultivar Norin 61 Highlights Functional Variation in Flowering Time and Fusarium-Resistant Genes in East Asian Genotypes. *Plant and Cell Physiology* 2021, 62(1): 8-27

ISSUE DATE:

2021-01





URL:

<http://hdl.handle.net/2433/276642>

RIGHT:

© The Author(s) 2021. Published by Oxford University Press on behalf of Japanese Society of Plant Physiologists.; This is an Open Access article distributed under the terms of the Creative Commons Attribution Non-Commercial License, which permits non-commercial re-use, distribution, and reproduction in any medium, provided the original work is properly cited.

De Novo Genome Assembly of the Japanese Wheat Cultivar Norin 61 Highlights Functional Variation in Flowering Time and *Fusarium*-Resistant Genes in East Asian Genotypes

Kentaro K. Shimizu ^{1,2,†,*}, Dario Copetti^{2,3,†}, Moeko Okada ^{2,†}, Thomas Wicker⁴, Toshiaki Tameshige^{1,5}, Masaomi Hatakeyama^{2,6}, Rie Shimizu-Inatsugi², Catharine Aquino⁶, Kazusa Nishimura⁷, Fuminori Kobayashi⁸, Kazuki Murata⁹, Tony Kuo^{10,11}, Emily Delorean¹², Jesse Poland¹², Georg Haberer¹³, Manuel Spannagl¹³, Klaus F. X. Mayer^{13,14}, Juan Gutierrez-Gonzalez ¹⁵, Gary J. Muehlbauer¹⁵, Cecile Monat ¹⁶, Axel Himmelbach¹⁶, Sudharsan Padmarasu¹⁶, Martin Mascher¹⁶, Sean Walkowiak^{17,18}, Tetsuya Nakazaki⁷, Tomohiro Ban¹, Kanako Kawaura¹, Hiroyuki Tsuji¹, Curtis Pozniak¹⁷, Nils Stein^{16,19}, Jun Sese^{10,20,*}, Shuhei Nasuda^{9,*} and Hirokazu Handa ^{8,21,*}

¹Kihara Institute for Biological Research, Yokohama City University, Yokohama, Japan

²Department of Evolutionary Biology and Environmental Studies, University of Zurich, Zurich, Switzerland

³Department of Environmental Systems Science, Molecular Plant Breeding, Institute of Agricultural Sciences, ETH Zurich, Zurich, Switzerland

⁴Department of Plant and Microbial Biology, University of Zurich, Zurich, Switzerland

⁵Department of Biology, Faculty of Science, Niigata University, Niigata, Japan

⁶Functional Genomics Center Zurich, Zurich, Switzerland

⁷Graduate School of Agriculture, Kyoto University, Kizugawa, Japan

⁸Division of Basic Research, Institute of Crop Science, NARO, Tsukuba, Japan

⁹Graduate School of Agriculture, Kyoto University, Kyoto, Japan

¹⁰National Institute of Advanced Industrial Science and Technology (AIST), Tokyo, Japan

¹¹University of Guelph, Centre for Biodiversity Genomics, Guelph, ON, Canada

¹²Department of Plant Pathology, Kansas State University, Manhattan, KS, USA

¹³Helmholtz Zentrum München—Research Center for Environmental Health, Neuherberg, Germany

¹⁴School of Life Sciences, Technical University Munich, Weihenstephan, Germany

¹⁵Department of Agronomy and Plant Genetics, University of Minnesota, Saint Paul, MN, USA

¹⁶Leibniz Institute of Plant Genetics and Crop Plant Research (IPK), Seeland, Germany

¹⁷Crop Development Centre, University of Saskatchewan, Saskatoon, SK, Canada

¹⁸Canadian Grain Commission, Grain Research Laboratory, Winnipeg, MB, Canada

¹⁹Department of Crop Science, Center of Integrated Breeding Research (CiBreed), Georg-August-University, Göttingen, Germany

²⁰Humanome Lab, Inc, Tokyo, Japan

²¹Laboratory of Plant Breeding, Graduate School of Life and Environmental Sciences, Kyoto Prefectural University, Kyoto, Japan

*Corresponding authors: Kentaro K. Shimizu, E-mail, kentaro.shimizu@uzh.ch; Fax, +41-44-635-47-80; Jun Sese, E-mail, sesejun@gmail.com; Fax, +81-50-5436-4563; Shuhei Nasuda, E-mail, nasuda.shuhei.Sz@kyoto-u.ac.jp; Fax, +81-75-753-6047; Hirokazu Handa, E-mail, hirokazu@kpu.ac.jp; Fax, +81-75-703-5604.

†These authors contributed equally to this work.

(Received 16 November 2020; Accepted 22 November 2020)

Bread wheat is a major crop that has long been the focus of basic and breeding research. Assembly of its genome has been difficult because of its large size and allohexaploid nature (AABBDD genome). Following the first reported assembly of the genome of the experimental strain Chinese Spring (CS), the 10+ Wheat Genomes Project was launched to produce multiple assemblies of worldwide modern cultivars. The only Asian cultivar in the project is Norin 61, a representative Japanese cultivar adapted to grow across a broad latitudinal range, mostly characterized by a wet climate and a short growing season. Here, we characterize the key aspects of its chromosome-scale genome assembly spanning 15 Gb with a raw scaffold N50 of 22 Mb. Analysis of the repetitive elements identified chromosomal regions unique to Norin

61 that encompass a tandem array of the pathogenesis-related 13 family. We report novel copy-number variations in the B homeolog of the florigen gene *FT1/VRN3*, pseudogenization of its D homeolog and the association of its A homeologous alleles with the spring/winter growth habit. Furthermore, the Norin 61 genome carries typical East Asian functional variants different from CS, ranging from a single nucleotide to multi-Mb scale. Examples of such variation are the *Fhb1* locus, which confers *Fusarium* head-blight resistance, *Ppd-D1a*, which confers early flowering, *Glu-D1f* for Asian noodle quality and *Rht-D1b*, which introduced semi-dwarfism during the green revolution. The adoption of Norin 61 as a reference assembly for functional and evolutionary studies will enable comprehensive

characterization of the underexploited Asian bread wheat diversity.

Keywords: Adaptation • Asian germplasm • Bread wheat • Genome assembly • Norin 61 • Polyploidy.

Accession numbers: The nucleotide sequence reported in this paper has been submitted to EBI database under the accession number GCA_904066035.1.

Introduction

About 35% of land plant species are estimated to be recent polyploids (Wood et al. 2009, Mayrose et al. 2011), and polyploid species are common in crops (Leitch and Leitch 2008). However, genome-scale studies of polyploid species have been challenging because of their large genome size and the high sequence similarity among homeologs; i.e. duplicated genes derived from genome duplication. Recent advances in sequencing and assembly algorithms have drastically improved the quality of genome assemblies, enabling improved genome-wide polymorphism analyses and transcriptomic analysis of allopolyploid species (Paape et al. 2018, Hu et al. 2020, Kuo et al. 2020). Assemblies of many polyploid species were reported with high contiguity (N50) values in the order of megabases [Mb; Avni et al. 2017, Hatakeyama et al. 2018, The International Wheat Genome Sequencing Consortium (IWGSC) 2018, Schreiber et al. 2018].

Bread wheat (*Triticum aestivum* L.), together with rice and maize, is a major crop that has a long tradition of cytogenetic, evolutionary and agricultural research (Dubcovsky and Dvorak 2007, Matsuoka 2011). However, its genome assembly has been one of the most difficult, yet sought-after challenges in genomics [The International Wheat Genome Sequencing Consortium (IWGSC) 2014] because of its allohexaploid nature and large size of about 16 Gb (Doležel et al. 2018). Kihara (1944) and McFadden and Sears (1944) independently discovered that bread wheat (AABBDD genome) originated from the allopolyploidization of domesticated emmer wheat *T. turgidum* (tetraploid AABB) with the wild species *Aegilops tauschii* (diploid DD). This polyploid speciation was inferred to have occurred near the Caspian Sea during the Neolithic period, around 8,000 years ago (Dubcovsky and Dvorak 2007, Matsuoka 2011). Neolithic crop species may have dispersed either by demic diffusion (associated with the spread of people and language) or by cultural diffusion (horizontal knowledge transfer without gene flow between human groups) (Stoneking 2016). A demic diffusion of agriculture, including *T. aestivum*, was proposed to have occurred from the Middle East toward Europe (Ammerman and Cavalli-Sforza 1971) and to have eventually continued its spread to America and Australia by the migration of European people in modern times. In its move toward East Asia, wheat may have integrated with preexisting farming systems in China through cultural diffusion (Li et al. 2007, Dodson et al. 2013, Barton and An 2014, Stevens and Fuller 2017) and

arrived at the eastern end, Japan, about 2,000 years ago (Ohta 2010, Fujita 2013).

Despite their significant contribution to the green revolution, recent studies suggest that traditional Asian bread wheat cultivars are still underutilized for breeding (Balfourier et al. 2019, Sansaloni et al. 2020). A principal component analysis of 188 worldwide accessions using DArTseq markers indicated that Japanese, West Asian, and European accessions were the furthest apart from each other, with the Chinese accessions lying on the edge between Japanese and West Asian accessions (Takenaka et al. 2018). The areas of wheat cultivation throughout Japan and China (except for the northern parts of both countries) are characterized by their wet environment and short growing seasons because of the rainy period in early summer and because of multiple cropping with rice (Yang et al. 2009). Early flowering cultivars with no or weak requirement for vernalization ('spring wheat') are typically sown in early winter to be harvested in early summer before the arrival of the rainy season and rice cropping. Important targets of wheat breeding in East Asia include early flowering (Fu et al. 2005, Tanio et al. 2005, Seki et al. 2011, Seki et al. 2013), semi-dwarfism (Kojima et al. 2017), resistance to preharvest sprouting (Himi et al. 2011), favorable quality for Asian type noodles and especially resistance to Fusarium head blight (FHB)—a severe threat in wet climates (Niwa et al. 2018).

The analysis of population genomic data and pangenomic analysis is critically important for demographic, evolutionary and breeding studies (Saisho and Purugganan 2007, Brohammer et al. 2018, Gutaker et al. 2020). In contrast to the extensive information from population genomic studies of rice and maize (van Heerwaarden et al. 2011, Wang et al. 2018, Gutaker et al. 2020), little is known about wheat, although it is one of the three species most widely grown and consumed. The first draft genome assembly of bread wheat released by the IWGSC was highly fragmented, with ≈ 10 kb of N50 statistics [The International Wheat Genome Sequencing Consortium (IWGSC) 2014]. In 2018, the first chromosome-scale assembly of the experimentally used landrace Chinese Spring (CS) [The International Wheat Genome Sequencing Consortium (IWGSC) 2018] was reported. The 10+ Wheat Genomes Project was launched to produce multiple high-quality *de novo* genome assemblies of worldwide modern cultivars, to be subsequently analyzed in a pangenomic context. The Japanese cultivar Komugi Norin 61 ('Komugi' means 'wheat' in Japanese, thus shortened to Norin 61) was the sole Asian cultivar represented in the project. The assembly data have been publicly released, and Walkowiak et al. (2020) analyzed the entire dataset.

Norin 61 is a representative Japanese cultivar of bread wheat that is characterized by broad adaptation and environmental robustness (Ishikawa 2010, Fujita 2013). It has been utilized for a broad range of molecular and physiological studies, including transgenic experiments and mutant screening (e.g. Taya et al. 1981, Ikeda et al. 2002, Matsuo et al. 2005, Kasajima et al. 2009, Shimada et al. 2009, Minoda 2010, Rikiishi and Maekawa 2010). It has also been used as a representative cultivar in studies of worldwide and regional variation (e.g. Fu et al. 2005, Tanio et al. 2005). Norin 61 was developed in 1935 and released in 1944. Its flour is mainly used as a soft red wheat for Japanese noodles, and

between 1950 and 1980 Norin 61 was most widely cultivated in Japan. It was still the third most widely grown cultivar in 2010. Norin 61 is grown in a broad region spanning from Kyushu to Kanto and partly in the northern island of Hokkaido (Ishikawa 2010). When grown in Sudan, it also demonstrated heat tolerance (Elbashir *et al.* 2017). The paternal parent is the cultivar Shinchunaga, which originated by pure-line selection from the landrace Nakanaga (alternatively pronounced as Chunaga). Shinchunaga is characterized by FHB resistance, early flowering, and high yield but is not semi-dwarf: its name 'naga' means long. The semi-dwarfism in Norin 61 was introduced from the maternal parent Fukuokakomugi 18. Norin 61 is genetically related to a large number of Japanese cultivars, including Shiroganekomugi, that are grown from Kyushu to Honshu islands, partly because its paternal parent Shinchunaga was widely used in the breeding programs by crossing with Japanese and Western cultivars (Fukunaga and Inagaki 1985, Kobayashi *et al.* 2016, Takenaka *et al.* 2018). Overall, the history and features of Norin 61 suggest that it could be established as the reference genotype for adaptation and breeding research in modern East Asian cultivars. In this article, we support this conclusion by examining the quality of the genome assembly, studying unique chromosomal regions and investigating known and novel functional variants of Norin 61.

Results

Genome assembly and scaffolding

The Norin 61 genome was sequenced using the Illumina short-read sequencing technology, combining different library formats and insert sizes. Most of the coverage was contributed by paired-end (PE) and mate-pair (MP) whole-genome shotgun (WGS) libraries and 10x Genomics linked reads and Hi-C data were produced to connect adjacent regions to hundreds of Mb-sized pseudomolecules (Table 1). After assembling an approximately 323-fold coverage of the WGS and linked-read data, the sequences were inspected for misassemblies and later scaffolded to chromosome-level pseudomolecules using POPSEQ and the Hi-C data (as described in Walkowiak *et al.* 2020, Supplementary Fig. S1).

Because the initial inspection of the assembly indicated that a key flowering gene (*FT-B1/VRN-B3*) was missing, the raw PE, MP and 10x Genomics linked-read data were reassembled. Two copies of the *FT-B1* chromosomal region were identified in two

short (≈ 19 kb each) contigs. Overall, approximately 755 Mb of sequences not present in the v1.0 assembly were added to chrUn (unplaced sequences). This updated assembly was labeled v1.1 and was used as the reference for all downstream analyses. The assembly spanned 14.9 Gb, having very high contiguity (L50 and N50, or half of the assembly, represented in 162 sequences spanning 21.9 Mb or more; Supplementary Table S1, Walkowiak *et al.* 2020). The vast majority of the assembly (14.1 Gb, 94.9% of the bases) was anchored to 21 chromosome pseudomolecules, leaving unanchored only 852 Mb of smaller sequences (96 kb N50). The data are available for download and BLAST search from IPK Gatersleben (<https://wheat.ipk-gatersleben.de/>) and from the National Institute of Genetics, Japan, (<https://shigen.nig.ac.jp/wheat/komugi/about/norin61GenomeSequence.jsp>), NCBI and EBI databases with the accession number GCA_904066035.1. Genes were annotated by projecting the CS annotation [The International Wheat Genome Sequencing Consortium (IWGSC) 2018], as described by Walkowiak *et al.* (2020).

Assembly validation

The completeness of the assembly was evaluated using three complementary methods. After alignment of six genome equivalents (part of PE700 data), 97.4% of the bases mapped to the assembly. Similarly, 97.4% of the read pairs mapped, and 86.2% were properly paired. Across the 14.9-Gb assembly, 98.5% of the positions were realigned to at least one read and 92.2% to at least four reads. We measured the degree of inclusion of the sequenced bases in the assembly using the comp function of the KAT tool (Mapleson *et al.* 2017). By comparing *k*-mers between the raw reads and the assembly, KAT estimated an overall assembly completeness of 97.8%. The *k*-mer distribution in the raw reads showed two peaks, at 21 and 40 (Fig. 1A). The copy numbers of the *k*-mers in the assembly (colored areas) and in the raw reads (curve profile) corresponded strongly. The homozygous and repeat peaks ($k = 21$ and 40, respectively) contained 96.3% and 70% of the read *k*-mers at the appropriate frequency in the assembly.

Walkowiak *et al.* (2020) reported that in the 10 reference-quality pseudomolecule assemblies (RQAs), >97% of plant single-copy orthologs (SCOs) were always present, implying a high level of completeness of the gene fraction across all RQAs. We inspected in more detail the representation of SCOs in the Norin 61 assembly and the gene annotation. In the assembly, <4% of the ultraconserved SCOs were either fragmented or

Table 1 Genomic DNA libraries and sequencing strategy for Norin 61

Library type	Insert size	Sequencing length	Platform	# of flow cells	Approximate coverage (×)
PCR-free PE470	450–470 bp	2 × 266 bp	HiSeq 2500v2	17	92
PCR-free PE700	700–800 bp	2 × 150 bp	HiSeq 2500v4	7	56
Nextera MP3kb	2–4 kb	2 × 150 bp	HiSeq 4000	4	43
Nextera MP6kb	5–7 kb	2 × 150 bp	HiSeq 4000	4	41
Nextera MP9kb	8–10 kb	2 × 150 bp	HiSeq 4000	4	63
10× Genomics Chromium	N/A	2 × 150 bp	HiSeq 4000	4	28
Hi-C	300 bp	2 × 100 bp	HiSeq 2500v2	4	5.2

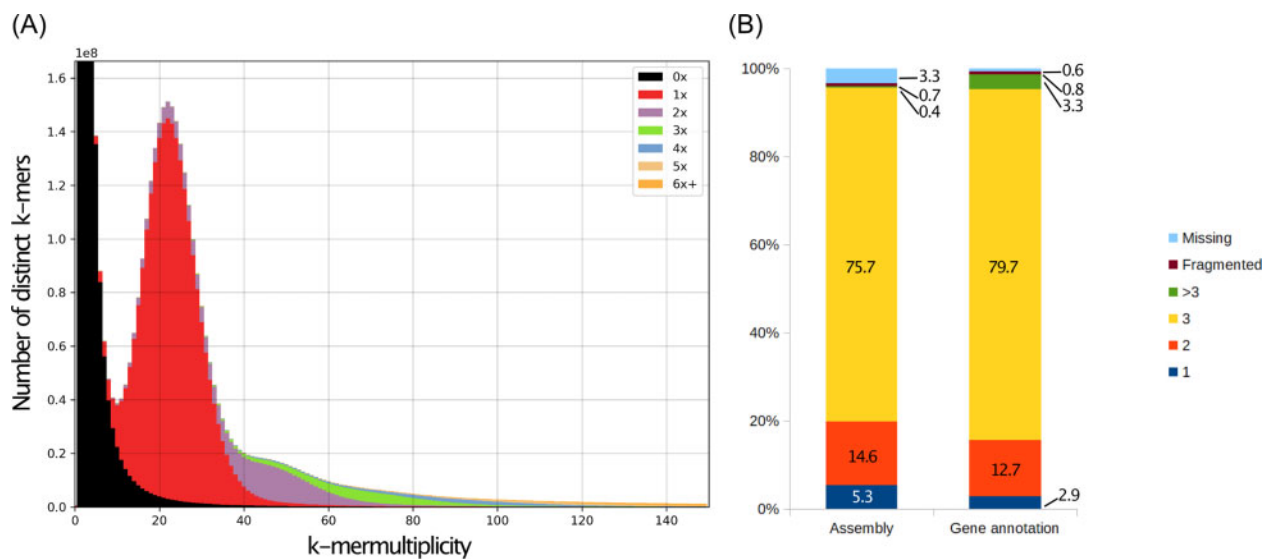

Fig. 1 Norin 61 assembly validation. (A) KAT plot comparing the sequence content in the raw reads (curve profile) and in the assembly (colored areas). The peak at $X \approx 21 \times$ contains the single-copy regions that are assembled in one copy (red area). The shoulder at $40\text{--}60 \times$ contains duplicated genomic sequences that are mostly assembled (as expected) in two copies. (B) Presence and copy number of universal SCOs in the Norin 61 assembly and gene annotation.

missing. Of the 1,383 complete SCOs, 1,090 (75.7%) were present in three copies. In the remaining 293 complete models, most were present in two copies (14.5% of the total) and only 5.3% in one copy (**Fig. 1B**). Similarly, the scan for SCOs on the gene annotation identified 1,421 of the 1,440 SCOs (98.7%), with the majority of genes being present three times. These data support that the majority of the SCOs are present in three copies, which is consistent with the genome allohexaploidy, and that some homeologs are absent.

The conserved, large-scale chromosomal structure of Norin 61

To inspect for possible large-scale rearrangements, we compared the karyotype of Norin 61 with that of CS after probing with three repetitive sequence probes. The hybridization showed a similar pattern in the two varieties, indicating a lack of any large-scale rearrangements in the genome of Norin 61 relative to CS. Six minor fluorescence in situ hybridization (FISH) polymorphisms were detected (**Fig. 2**): a gain of a terminal pSc119.2 signal on chromosome arm 1BS, a gain of terminal pSc119.2 signal on 1DS, a weaker terminal pTa535 signal on 2AS, a loss of terminal pSc119.2 signal on 3BS, a loss of terminal pSc119.2 signal on 4AL and a loss of terminal pTa713 signal on 6BL. Moreover, we did not identify any chromatin containing a large block of repetitive elements.

The uniform/consistent large-scale structure of Norin 61 and CS genomes was confirmed by genome-wide sequence alignment (**Supplementary Fig. S2**). The local inversions identified at the very end or in the middle of the chromosomes may be the result of the difficulty of assembling repetitive subtelomeric or centromeric regions. These analyses supported that the Norin 61 genome does not have the large-scale interchromosomal rearrangements observed in some other 10+ Wheat

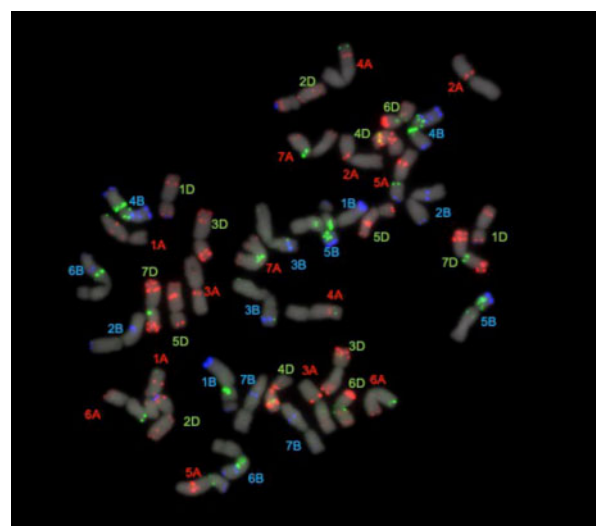

Fig. 2 Nondenaturing fluorescence in situ hybridization of a metaphase spread of Norin 61. A pseudocolored image of the stacked pictures taken with red (Oligo-pSc119.2-1; shown in blue), green (Oligo-pTa535; shown in red), near-infrared (Oligo-pTa713; shown in green) and blue (counterstaining with DAPI; shown in gray) filters.

Genomes Project cultivars. We next investigated the genomic variation at a smaller scale.

Unique chromosomal regions identified by the patterns of repetitive elements

The analysis of repetitive elements in the 10 genomes identified unique chromosomal segments that were considered candidates for foreign introgressions (Walkowiak et al. 2020, Zhou et al. 2020). Norin 61 contains 45 such segments that are unique among the 10 RQAs, span between 20 and 169 Mb in size and together account for 1.9 Gb (or 13.5%) of the assembly. The

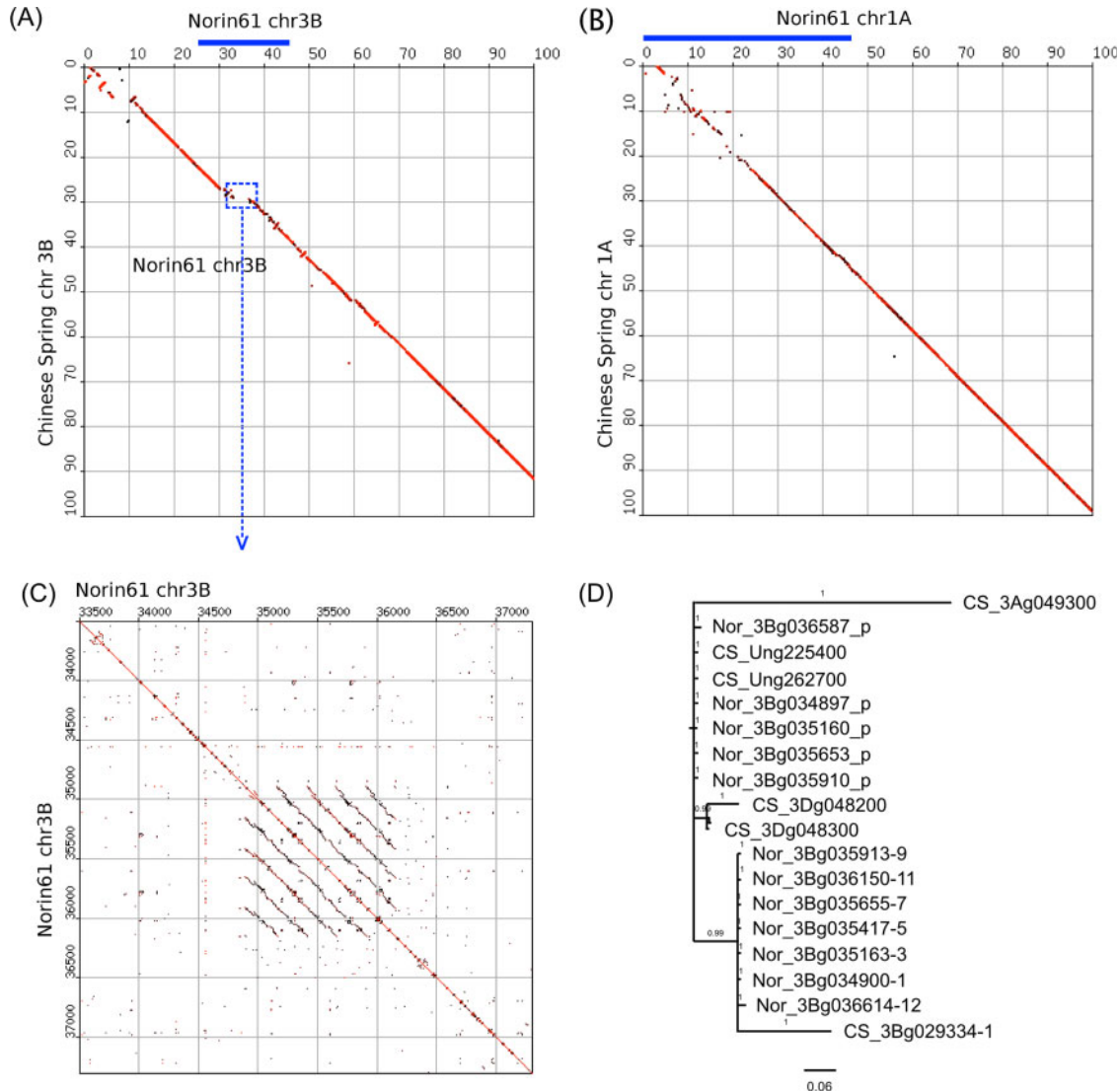

Fig. 3 Analysis of chromosomal introgression in Norin 61. (A) Dot plot comparison of the terminal 100 Mb of chromosome 3B from Norin 61 (horizontal) and CS. Norin 61 contains an introgression at approximately position 25–46 Mb (indicated with a blue bar). Discontinuity in the diagonal denotes lack of sequence conservation in that region, and Norin 61 contains a unique ≈ 3.9 Mb segment (shift to the right in the dashed blue rectangle). (B) Dot plot comparison of the terminal 100 Mb of chromosome 1A from Norin 61 (horizontal) and CS. The introgression was identified through the analysis of repetitive sequences and ranges between 0 and 47.7 Mb (indicated with a blue bar). Sequences are particularly diverse in the 5' terminal 25 Mb. (C) Self dot plot alignment of the 3.9 Mb 3B segment that is unique to Norin 61. The alignment of the segment with itself identifies a large array of five tandem repeats (series of parallel lines). (D) Phylogenetic analysis of proteins encoded by gene family 3B_25-46-1 whose members are identified in the repeat array shown in (C). Note that the individual genes cluster in two clades that cannot be further resolved because of the high similarity of the protein sequences.

candidate introgressed segments contain between 75 and 1,328 genes each (**Supplementary Table S2**). Overall, 20,225 wheat genes (17.0% of the 118,734 total genes) were annotated in the 45 regions. By comparing their coding sequences (CDSs) to the annotation for CS, we classified such genes as syntenic or private: 1,669 genes were private (i.e. lacked significant homology to genes in the corresponding syntenic region in CS—see Materials and Methods for a more complete definition of syntenic or private genes).

Typically, 6–8% of the genes annotated in the candidate regions for containing an introgression event were private, with a moderate enrichment in distal and centromeric regions

(**Supplementary Fig. S3A**). We identified 10 introgressions that contained over 10% private genes, in three of which the count reached 15% (**Supplementary Table S2**). Overall, the 45 regions contained a larger fraction of private genes than the genome-wide average (**Supplementary Fig. S3B**). This indicates that the gene content in the candidate regions for introgression differs considerably from that of the CS reference.

Two introgressions (chromosome 3B, 25–46.3 Mb, and chromosome 1A, 0–41.7 Mb) were of particular interest because their sequence conservation between Norin 61 and CS was very low (**Fig. 3A, B**). The 3B introgression spans about 21 Mb, contains 61 private genes and includes an ≈ 3.9 Mb

unique segment that is completely absent from CS (Fig. 3A). Structurally, this segment is composed of five direct sequence repeats arrayed in tandem, each one \approx 250 kb in size (Fig. 3C). The formation of this array is probably the result of recurrent unequal crossing-over events. The sequence identity between individual repeat units is $>$ 96%. Interestingly, 27 genes in the 3B introgression candidate belong to two large gene families—family 3B_25-46-1 and family 3B_25-46-2, which contain 12 and 15 members, respectively. All genes belonging to family 3B_25-46-1 are located on the unique 3.9 Mb, five of them inside the tandem repeat array. Because of repetitive nature of the region in Norin 61, genes cluster in two clades with high copy number, with most sequences within the clades being identical (Fig. 3D). Genes of this family encode short peptides of 84–88 amino acids that are rich in positively charged amino acids (Supplementary Fig. S4A). Because of their lack of homology to characterized sequences, their function is unclear. Family 3B_25-46-2 also encodes short sequences with cysteine-rich motifs and a signal peptide, named the *pathogenesis-related 13* (PR-13) gene family or thionins (Goyal and Mattoo 2014). The clade highlighted in Supplementary Fig. S4B contains 12 genes in Norin 61 in contrast to the six copies present in the CS region carrying the introgression on 3B (Supplementary Fig. S4B). The even distribution of Norin 61 and CS genes in the clade suggests that there was no preferential amplification of one or a few founder copies. Similar to the 3B introgression described above, we identified a cluster of putative PR-13 genes on the 1A introgression, which in Norin 61 also comprised a large number of gene copies (Supplementary Fig. S4C). The shorter branch lengths may suggest that the Norin 61 PR-13 copies could have amplified more recently than the CS homologs.

Identification of flowering-time-related genes and their variants

Flowering time is a major target of selection in wheat and other crop species (Eshed and Lippman 2019, Hyles et al. 2020). The gene family of *FLOWERING LOCUS T* (FT), which has been denoted as *Vrn3* or *Vrn-1* in wheat, plays a central role in its regulation (Kikuchi et al. 2009, Halliwell et al. 2016). By homology search, we mined Asian wheat homeologs of flowering-time related genes (Table 2), identifying 45 and 62 FT homeologs in the Norin 61 and CS assemblies, respectively (Table 2). The FT family members clustered in 12 subfamilies (Fig. 4A, Supplementary Fig. S5). Among these, FT1 and FT3 play important roles in controlling flowering time in grasses (Kikuchi et al. 2009, Halliwell et al. 2016). In both Norin 61 and CS, all three homeologs in the FT3 subfamily are present in a single copy. Its ortholog in barley, *HvFT3*, is colocalized with its major flowering-time locus *Ppd-H2* (Faure et al. 2007, Kikuchi et al. 2009). In the following section below, we will focus on the variation in the FT1 subfamily.

Norin 61 had two FT-B1 (the B-genome homeolog of FT1, synonymous to *Vrn-B3*) copies as described above. Nucleotide phylogeny of the FT1 subfamily demonstrated the close relatedness of the two copies, and we named FT-B1-1 and FT-B1-2 (Supplementary Fig. S6, Table 2). The two contigs containing the FT-B1 genes (contig 78046 and 91980, each about 19 kb)

were highly similar, only differing by a 48-bp tandem duplication (two copies in 78046, three in 91980) and two mismatches outside of the coding regions. To confirm the existence of multiple copies, we compared the resequencing coverage values of the three FT1 homeologs with that for *Adh-1*, a single-copy gene. The coverage of FT-A1, FT-D1 and three *Adh-1* homeologs was all comparable (Table 3). By contrast, increased coverage was found at both FT-B1 copies (Table 3), supporting its increased copy number.

Unexpectedly, we also noticed the higher coverage on the B homeolog of CS despite a single copy (TraesCS7B02G013100) was reported in the RefSeq v1.1 [The International Wheat Genome Sequencing Consortium (IWGSC) 2018]. When the improved CS assembly was interrogated (IWGSC RefSeq v2.0 and Alonge et al. 2020), we indeed identified three copies of FT-B1 on chromosome 7B (Supplementary Table S3), one of which showed a frameshift mutation (Fig. 4B). In the phylogenetic tree, the three CS FT-B1 copies clustered with the two Norin 61 copies of FT-B1 (Supplementary Fig. S6).

We next examined the Norin 61 FT-D1 (the D-genome homeolog of FT1, synonymous to *Vrn-D3*) and found that a 1-bp deletion introduced a frameshift in Norin 61. The predicted protein lacked the conserved segment B that is necessary for the function of FT proteins (Fig. 4B) (Ahn et al. 2006).

Several known haplotypes of the FT-A1 (the A-genome homeolog of FT1, synonymous to *Vrn-A3*) gene are suggested to be functional variations in tetraploid emmer wheat and in bread wheat (Nishimura et al. 2018, Chen et al. 2020). We examined the sequence variation among the 10+ Wheat Genomes Project wheat cultivars and found two alleles—*Vrn-A3b* and *Vrn-A3c* (Table 4). Both alleles were well represented (*Vrn-A3c* present in 4 of 11 RQAs and in 3 of 5 scaffold-level assemblies). This showed that these are common alleles in the cultivars used in the 10+ Wheat Genomes Project. Interestingly, there is an association of the *Vrn-A3* alleles and growth habit: all surveyed spring wheat cultivars except Cadenza tend to have the deletion allele *Vrn-A3b*, and all winter wheats except SY Mattis have the non-deletion allele *Vrn-A3c* ($\chi^2 = 6.1315$, $P = 0.01328$, Pearson's chi-squared test with Yates' continuity correction).

The photoperiod response is another key mechanism that regulates flowering. In wheat, it is mainly regulated by three homeologous genes: *Ppd-D1* (previously designated *Ppd1*), *Ppd-B1* (*Ppd2*) and *Ppd-A1* (*Ppd3*), each on their respective group-2 chromosome (Welsh et al. 1973, Scarth and Law 1983). *Ppd* genes encode pseudoresponse regulator (PRR) proteins that control the circadian clock. Because of a 2,089-bp deletion in the promoter region that includes the repressor (Turner et al. 2005, Beales et al. 2007), the *Ppd-D1a* allele confers early flowering with high expression of *Ppd-D1* itself and the downstream FT1/*Vrn3* genes. This allele has been widely used for breeding in southern Europe and the southern part of East Asia (Worland 1996, Guo et al. 2010). Consistent with previous polymerase chain reaction (PCR) genotyping (Seki et al. 2011), we confirmed the deletion characteristic for *Ppd-D1a* in Norin 61 in contrast to CS (Fig. 5). We did not use the CS *Ppd-B1* sequence for the comparison because of the increased copy

Table 2 Flowering time-related gene homologs between Norin 61 and CS

Accession	Reference			CS			Norin 61			Notes on potential extra copies in Norin 61
	Gene symbol	Reference	A	B	D	A	B	D		
TaFT1-1/VRN-3-1	Halliwell et al. (2016)	TraesCS7A02G115400	TraesCS7B02G013100	TraesCS7D02G111600	TraesNOR7A01G123700	NA	NA	TraesNOR7D01G129000	See main text. Copy number variation of the B homoeologs in Norin 61 as well as in CS	
TaFT2-1*	Halliwell et al. (2016)	TraesCS3A02G143100	TraesCS3B02G162000	TraesCS3D02G144500	TraesNOR3A01G166100	TraesNOR3B01G189800	TraesNOR3D01G160200			
TaFT3-1	Halliwell et al. (2016)	TraesCS1A02G338600	TraesCS1B02G351100	TraesCS1D02G340800	TraesNOR1A01G362800	TraesNOR1B01G382200	TraesNOR1D01G378400			
TaFT4-1	Halliwell et al. (2016)	TraesCS2A02G132300	TraesCS2B02G154800	TraesCS2D02G134200	TraesNOR2A01G150300	TraesNOR2B01G174600	TraesNOR2D01G153400			
TaFT5-1	Halliwell et al. (2016)	TraesCS5A02G546900	TraesCS4B02G379100	TraesCSU02G130900	TraesNOR5A01G583800	TraesNOR4B01G414800	TraesNORU01G040600	There might be multiple copies on the B genome of Norin 61		
TaFT5-2	Halliwell et al. (2016)	TraesCS5A02G546800	TraesCS4B02G380600	TraesCSU02G130800	TraesNOR5A01G583700	TraesNOR4B01G416300	TraesNORU01G040500	A second Norin 61D homoeolog was not annotated		
TaFT5-4	Halliwell et al. (2016)	NA	NA	TraesCSU02G130700	NA	NA	TraesNORU01G040400			
TaFT6-1	Halliwell et al. (2016)	TraesCS6A02G160200	TraesCS6B02G191200	TraesCS6D02G152500	TraesNOR6A01G175800	TraesNOR6B01G210900	TraesNOR6D01G177500			
TaFT7-1*	Halliwell et al. (2016)	TraesCS5A02G154600	TraesCS5B02G152800	TraesCS5D02G159500	TraesNOR5A01G167400	TraesNOR5B01G169100	TraesNOR5D01G173200			
TaFT8-1	Halliwell et al. (2016)	TraesCS2A02G536600	TraesCS2B02G511400	TraesCS2D02G538000	TraesNOR2A01G582200	TraesNOR2B01G557400	TraesNOR2D01G585300	High copy number		
TaFT8-2	Halliwell et al. (2016)	TraesCS2A02G485000	TraesCS2B02G567400	TraesCS2D02G485100	TraesNOR2A01G524400	TraesNOR2B01G619000	NA	High copy number		
TaFT8-3	Halliwell et al. (2016)	TraesCS2A02G536900	TraesCS3B02G015800	TraesCS2D02G538100	NA	TraesNOR3B01G017500	NA			
TaFT8-4	Halliwell et al. (2016)	TraesCS2A02G536700	TraesCSU02G045800	TraesCS3D02G011600	NA	TraesNOR3B01G017400	NA			
TaFT9-1	Halliwell et al. (2016)	TraesCS2A02G347000	TraesCS2B02G365300	TraesCS2D02G345700	TraesNOR2A01G378700	TraesNOR2B01G400600	TraesNOR2D01G376200			
New	Halliwell et al. (2016)	TraesCS2A02G346900	TraesCS2B02G365200	TraesCS2D02G345600	TraesNOR2A01G378600	TraesNOR2B01G400500	TraesNOR2D01G376100			
TaFT10-1	Halliwell et al. (2016)	TraesCS5A02G297300	TraesCS5B02G296600	TraesCS5D02G304400	TraesNOR5A01G314900	TraesNOR5B01G321800	TraesNOR5D01G327800			
TaFT11-1	Halliwell et al. (2016)	NA	TraesCS4B02G073800	TraesCS4D02G072300	NA	TraesNOR4B01G083000	TraesNOR4D01G076400			
TaFT12-1	Halliwell et al. (2016)	TraesCS6A02G214400	TraesCS6B02G244400	TraesCS6D02G197100	TraesNOR6A01G234900	TraesNOR6B01G268400	TraesNOR6D01G227500			
TaMFT1	Higuchi et al. (2013)	TraesCS7A02G229400	TraesCS7B02G195200	TraesCS7D02G230000	TraesNOR7A01G248800	TraesNOR7B01G154000	TraesNOR7D01G258900			
TaMFT2-1	Higuchi et al. (2013)	TraesCS3A02G006600	TraesCS3B02G010100	TraesCS3D02G004100	TraesNOR3A01G008900	TraesNOR3B01G009400	TraesNOR3D01G000600			
TaMFT2-2	Higuchi et al. (2013)	NA	TraesCS3B02G007400	NA	NA	TraesNOR3B01G009500	NA			
TaTFL1	Faure et al. (2007)	TraesCS5A02G128600	TraesCS5B02G127600	TraesCS5D02G136300	TraesNOR5B01G141700	TraesNOR5B01G141700	TraesNOR5D01G148800			
TaTFL2	Higuchi et al. (2013)	TraesCS4A02G409200	TraesCS4B02G307600	TraesCS4D02G305800	TraesNOR4A01G399300	TraesNOR4B01G335300	TraesNOR4D01G327600			
TaTFL3	Higuchi et al. (2013)	TraesCSU02G202000	TraesCS2B02G310700	TraesCS2D02G292000	TraesNOR2A01G323700	TraesNOR2B01G343700	TraesNOR2D01G320200			
Vrn-1	Yan et al. (2003), Danyluk et al. (2003) and Murai et al. (2003)	TraesCS5A02G391700	TraesCS5B02G396600	TraesCS5D02G401500	TraesNOR5A01G416600	TraesNOR5B01G433300	TraesNOR5D01G434800			
ZCCT-1 (Vrn2-1)	Yan et al. (2004)	TraesCS5A02G541300	TraesCS4B02G372700	TraesCS4D02G364500	TraesNOR5A01G578600	TraesNOR4B01G408300	TraesNORU01G034600			
ZCCT-2 (Vrn2-2)	Yan et al. (2004)	TraesCS5A02G541200	NA	TraesCS4D02G364400	TraesNOR5A01G578700	NA	TraesNORU01G034500			
TaGRP-2	Xiao et al. (2014)	TraesCS4A02G293000	TraesCS4B02G020300	TraesCS4D02G018500	TraesNOR4A01G307500	TraesNOR4B01G023800	TraesNOR4D01G020000			
TaVRT-2	Kane et al. (2005)	TraesCS7A02G175200	TraesCS7B02G080300	TraesCS7D02G176700	TraesNOR7A01G188500	TraesNOR7B01G090400	TraesNOR7D01G200800			

(continued)

Table 2 Continued

Accession	Gene symbol	Reference	CS			Norin 61			Notes on potential extra copies in Norin 61
			A	B	D	A	B	D	
	<i>TaGF-1</i>	Zhao et al. (2005)	TraesCS3A02G116300	TraesCS3B02G135400	TraesCS3D02G118200	TraesNOR3A01G128300	TraesNOR3B01G162100	TraesNOR3D01G131800	
	<i>WSOC-1</i>	Shitsukawa et al. (2007)	TraesCS4D02G341700	TraesCS4B02G346700	TraesCS5A02G515500	TraesNOR5A01G549300	TraesNOR4B01G377200	TraesNOR4D01G366500	A second Norin 61D homoeolog was not annotated
	<i>WPCL-1</i>	Mizuno et al. (2012) and Mizuno et al. (2016)	TraesCS3A02G526600	TraesCS3B02G594300	TraesCS3D02G531900	TraesNOR3A01G575200	TraesNOR3B01G660800	TraesNOR3D01G579900	
	<i>WCO-1</i>	Shimada et al. (2009)	TraesCS1A02G220300	TraesCS1B02G233600	TraesCS1D02G221800	TraesNOR1A01G240300	TraesNOR1B01G254700	TraesNOR1D01G249900	
	<i>TaHD-1 (CO-2)</i>	Nemoto et al. (2003)	TraesCS6A02G289400	TraesCS6B02G319500	TraesCS6D02G269500	TraesNOR6A01G314800	TraesNOR6B01G348100	TraesNOR6D01G304400	
	<i>TaPHYC</i>	Mizuno et al. (2012) and Mizuno et al. (2016)	TraesCS5A02G391300	TraesCS5B02G396200	TraesCS5D02G401000	TraesNOR5A01G416100	TraesNOR5B01G432800	TraesNOR5D01G434300	
	<i>Ppd-1 (PRR)</i>	Turner et al. (2005), and Beales et al. (2007)	TraesCS2A02G081900	NA	TraesCS2D02G079600	TraesNOR2A01G096300	NA	TraesNOR2D01G091900	There might be multiple copies of the B homoeologs in Norin 61 as well as in CS
	<i>TaAPI</i>	Murai et al. (2003)	TraesCS5A02G391700	TraesCS5B02G396600	TraesCS5D02G401500	TraesNOR5A01G416600	TraesNOR5B01G433300	TraesNOR5D01G434800	Splicing variant in CS. 61 was not annotated
	<i>TaAP2</i>	Ning et al. (2013)	TraesCS2A02G514200	TraesCS2B02G542400	TraesCS2D02G515800	TraesNOR2A01G556000	TraesNOR2B01G592300	TraesNOR2D01G559400	
	<i>TaACL12</i>	Zhao et al. (2006)	TraesCS7A02G260900	TraesCS7B02G158900	TraesCS7D02G261900	TraesNOR7A01G280100	TraesNOR7B01G185700	TraesNOR7D01G293000	A second Norin 61D homoeolog was not annotated
	<i>TaACL22</i>	Zhao et al. (2006)	TraesCS3A02G434900	NA	NA	TraesNOR3A01G466500	TraesNOR3B01G517700	TraesNOR3D01G458800	
	<i>TaACL33</i>	Zhao et al. (2006)	TraesCS3A02G435000	TraesCS3B02G470000	TraesCS3D02G428000	TraesNOR3A01G466400	TraesNOR3B01G517500	TraesNOR3D01G458600	
	<i>TaACL41</i>	Sharma et al. (2016)	TraesCS3A02G434400	TraesCS3D02G427700	TraesCS3B02G469700	TraesNOR3A01G465900	TraesNOR3B01G517500	TraesNOR3D01G458500	
	<i>TaACL42</i>	Zhao et al. (2006)	TraesCS3A02G432900	NA	TraesCS3D02G427900	TraesNOR3A01G466500	NA	TraesNOR3D01G457000	
	<i>TaAG1</i>	Meguro et al. (2003)	TraesCS1A02G125800	TraesCS1B02G144800	TraesCS1D02G127700	TraesNOR1A01G139600	TraesNOR1B01G161700	TraesNOR1D01G145300	Potential another copies on chr Un
	<i>WAG2/TaACL39</i>	Zhao et al. (2006)	TraesCS3A02G314300	TraesCS3B02G157500	TraesCS3D02G140200	TraesNOR3A01G153000	NA	TraesNOR3D01G155900	

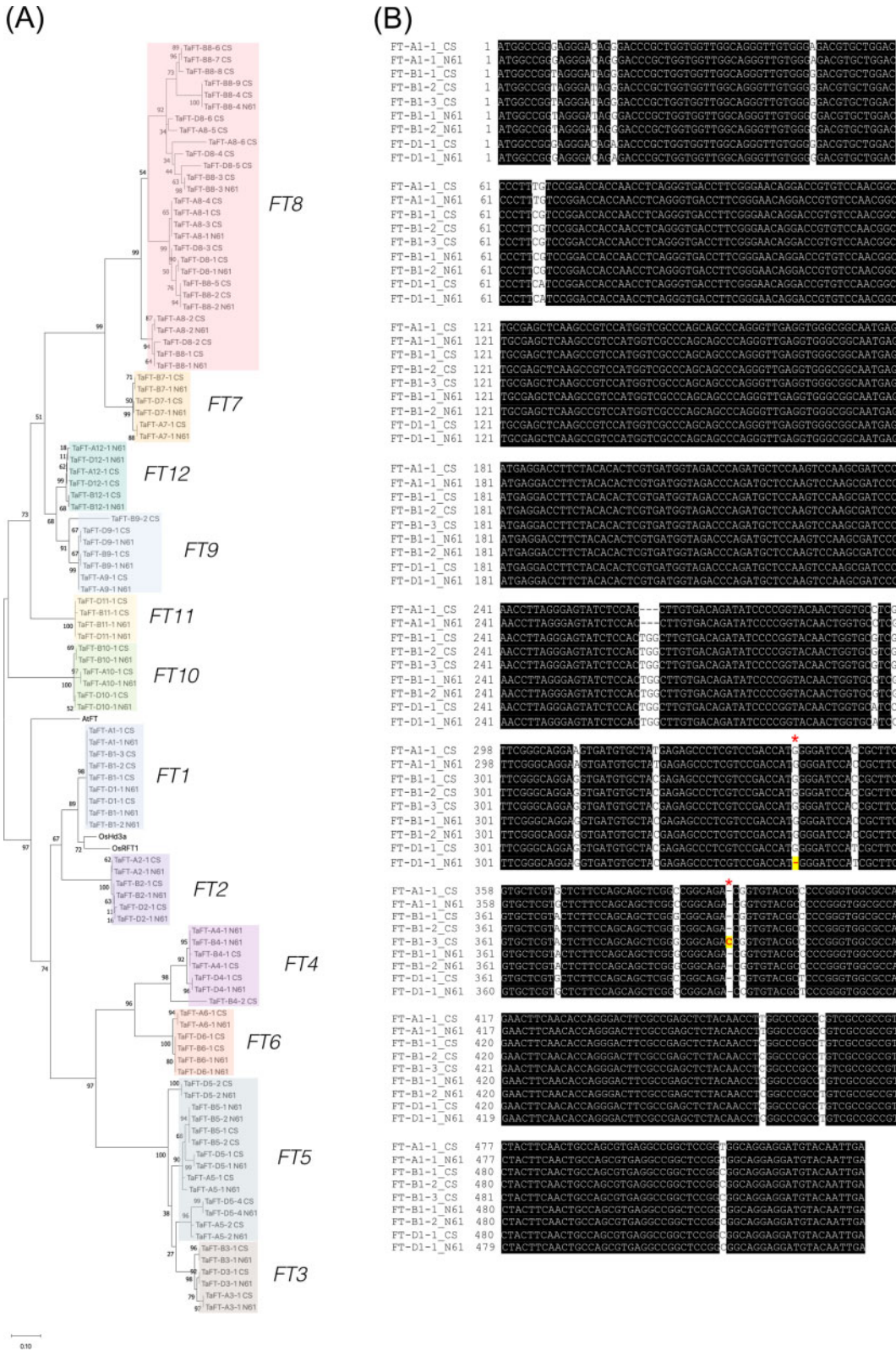

Downloaded from https://academic.oup.com/pcp/article/62/1/8/6006781 by Kyoto University user on 11 October 2022

Fig. 4 (A) Maximum-likelihood tree of 108 FT homologs based on amino acid sequences. The bootstrap values are shown on the branches. N61 and CS stand for Norin 61 and CS, respectively. (B) Multiple sequence alignment of FT1 genes on CS and N61. The red stars highlight the positions with the 1-bp deletion in FT-D1 of Norin 61 and the 1-bp insertion in FT-B1-3 of CS. The black boxes indicate the conserved sequences. The white regions show the SNPs or indels between sequences.

Table 3 Resequencing coverage of *Adh-1* and *FT1* loci on CS and Norin 61

Genotype	Gene	Homeolog coverage		
		A	B	D
CS	<i>Adh-1</i>	7.8	7.4	9.4
	<i>FT-B1</i>	9.7	22.8	8.9
Norin 61	<i>Adh-1</i>	9.1	9.7	8.0
	<i>FT-B1</i>	7.6	13.4	11.5
			14.3	

Compared with the *Adh-1* gene, the mean coverage of the *FT1* copies is less homogeneous (higher coverages are highlighted in bold), hinting at a possible collapse of multiple (even more than two) copies in the B homeolog in both the Norin and CS assemblies. The coverage values of the two Norin 61 *FT-B1* copies detected in the assembly are represented on two separate lines.

Table 4 Variation at *FT-A1* (also denoted as *Vrn-A3*) and the growth habit

Cultivar	<i>Vrn-A3</i>			Habit ^a
	Size	Type	Allele	
Norin 61	799	del	<i>Vrn-A3b</i>	Facultative spring
ArinaLrFor	830	Ins	<i>Vrn-A3c</i>	Winter
CS	799	Del	<i>Vrn-A3b</i>	Spring
Jaggar	830	Ins	<i>Vrn-A3c</i>	Winter
Julius	830	Ins	<i>Vrn-A3c</i>	Winter
LongReach Lancer	799	Del	<i>Vrn-A3b</i>	Spring
CDC Landmark	799	Del	<i>Vrn-A3b</i>	Spring
Mace	799	Del	<i>Vrn-A3b</i>	Spring
CDC Stanley	799	Del	<i>Vrn-A3b</i>	Spring
SY Mattis	799	Del	<i>Vrn-A3b</i>	Winter
PI190962 (spelt wheat)	830	Ins	<i>Vrn-A3c</i>	Winter
Cadenza	830	Ins	<i>Vrn-A3c</i>	Spring
Paragon	799	Del	<i>Vrn-A3b</i>	Spring
Robigus	830	Ins	<i>Vrn-A3c</i>	Winter
Claire	830	Ins	<i>Vrn-A3c</i>	Winter
Weebill 1	799	Del	<i>Vrn-A3b</i>	Spring

^aData from Walkowiak et al. (2020).

number in CS (Díaz et al. 2012). Although both Norin 61 and CS show a sensitive phenotype with *Ppd-A1b*, the two lines displayed independent indels in intronic and promoter regions of the *Ppd-A1* gene, as reported previously (Beales et al. 2007) (Fig. 5).

Syntenic analysis at the FHB-resistant loci

FHB resistance is a major target of breeding in East Asia and other regions that have relatively high humidity at harvest season. With multiple quantitative trait loci (QTLs) contributing to the resistance, Niwa et al. (2018) reported that Norin 61, Sumai 3, Ning 7840 and other related cultivars had several FHB-resistant QTLs, including *Fhb1*. Although the *TaPFT* gene encoding a pore-forming toxin-like protein was first suggested to be responsible for *Fhb1* (Rawat et al. 2016), the *TaHRC* gene encoding a nuclear protein was supported in subsequent studies (Li et al. 2019, Su et al. 2019). The CS chromosomal region containing *Fhb1* falls within a region (0–32.5 Mb on chromosome 3B) identified as an introgression candidate (Walkowiak et al. 2020). A comparison of the CS *Fhb1* region to the orthologous sequence in Norin 61 identified a ~340-kb region with very little sequence homology (Fig. 6A). The *Fhb1* region in the Norin 61 assembly showed very high sequence conservation with the bacterial artificial chromosome (BAC)-based contigs of CM-82036 derived from Sumai 3 (Schweiger et al. 2016) (Fig. 6B), providing at the same time an independent validation of the high quality of the Norin 61 assembly. The gene annotation of the Norin 61 orthologs (projected CS models, Walkowiak et al. 2020) identifies 20 protein-coding regions. However, given the remarkably low sequence conservation with CS at this locus, we annotated genes in the interval de novo and identified 50 additional genes (Fig. 6C). In contrast to the susceptible allele of CS and Clark, the Norin 61 assembly lacked the region, including the start codon in the third exon of the *TaHRC* gene (Fig. 6D, Supplementary Fig. S7), which is equivalent to resistant alleles of Ning 7840 and Sumai 3 (Li et al. 2019, Su et al. 2019). The occurrence of the deletion in the Norin

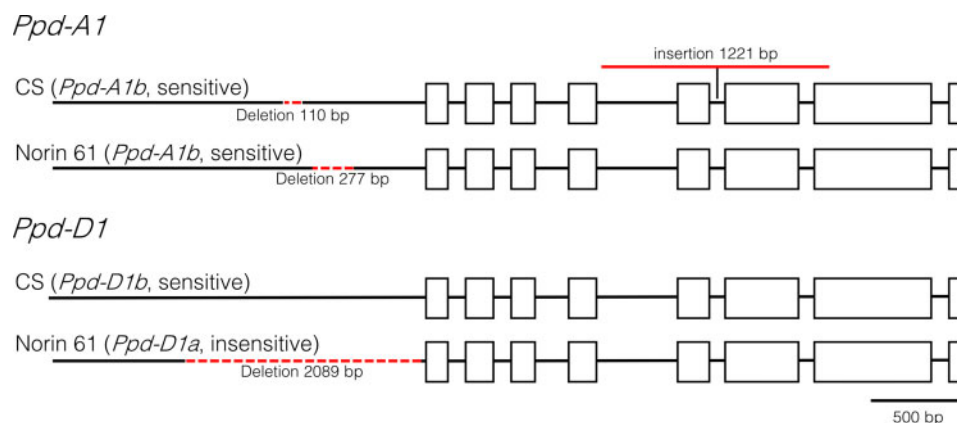

Fig. 5 Sequence features of *Ppd-1* genes with the 5-kb upstream region extracted from the CS and Norin 61 pseudomolecules. (A) Both CS and Norin 61 have the photoperiod-sensitive *Ppd-A1b* allele. Three insertions/deletions were detected. (B) The red region spans the 2,089-bp deletion of the *Ppd-D1a* allele of Norin 61 compared with the *Ppd-D1b* allele of CS. The boxes indicate CDSs. The red lines show the sequence polymorphisms between CS and Norin 61 assemblies.

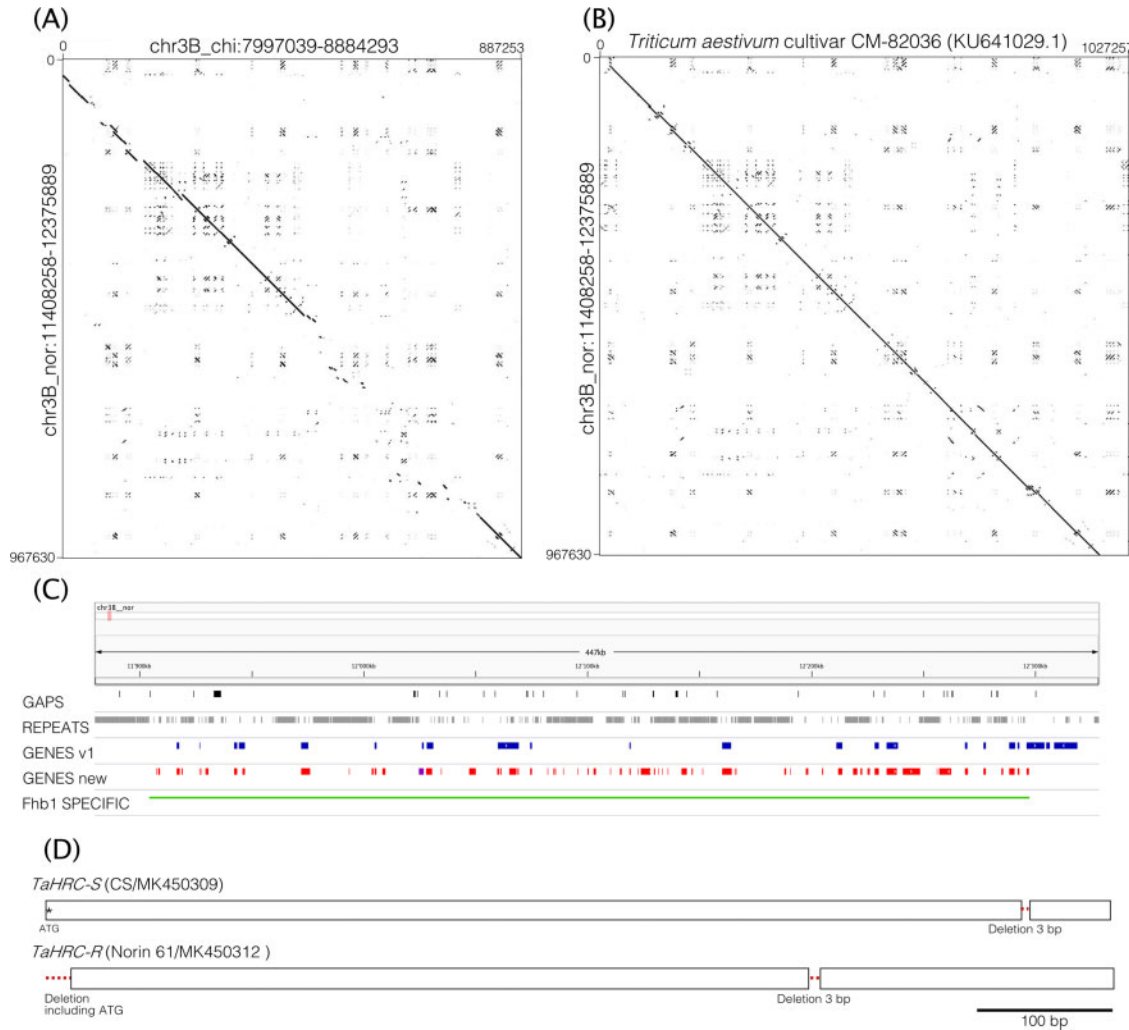

Fig. 6 Characterization of the *Fhb1* locus in CS and in FHB-resistant varieties. (A) Sequence dot plot of the region surrounding *Fhb1* in CS (X-axis chromosome 3B: 7.99–8.88 Mb) and Norin 61 (Y-axis, chromosome 3B: 11.41–12.37 Mb). The gap in the bottom part of the diagonal denotes the region with different sequence composition (spanning about 340 kb). (B) Dot plot comparing CM-82036 derived from Sumai 3 (X-axis, from Schweiger *et al.* 2016; BAC assembly, GenBank accession: MK450312) and Norin 61 (Y-axis, chromosome 3B: 11.41–12.37 Mb) showing the almost complete identity of the sequence. (C) Annotation of the ≈390 kb Norin 61 region containing *Fhb1* (chromosome 3B: 11.89–12.31 Mb). The newly annotated genes (red boxes) and the span of the Norin 61 region differing from CS are shown below the published annotation of Norin 61 (Walkowiak *et al.* 2020, first three tracks). The *TaHRC* gene is highlighted in purple. (D) Schematic structure of the deletion in the *TaHRC* gene. The boxes indicate the third exon. The red dashed line shows the sequence polymorphisms between CS and Norin 61 assemblies.

61 assembly, coupled with its FHB resistance, corroborates the role of the deletion in *TaHRC* for *Fusarium* resistance.

The short arm of chromosome 2D also harbors a QTL for FHB resistance and mycotoxin accumulation and is closely linked with the *Reduced height 8 (Rht8)* gene (Korzun *et al.* 1998, Chai *et al.* 2019, **Supplementary Table S4**). The gene for multidrug-resistant-associated protein (*TaMRP-D1*) was postulated as a candidate gene for this QTL (Handa *et al.* 2008). Because Norin 61 and CS as well as Sumai 3 have this allele of *TaMRP-D1* (Niwa *et al.* 2018) and a susceptible haplotype, we surveyed for allelic variation at *TaMRP-D1* and *Rht8* loci in other cultivars sequenced in the 10+ Wheat Genomes Project (**Supplementary Table S4**). We found a tight link between one allele of *TaMRP-D1* and the semi-dwarf and dense spike allele of *Rht8* in the FHB-susceptible haplotype, which is

consistent with a linkage drag potentially caused by the selection of the semi-dwarf allele (Niwa *et al.* 2018). By contrast, we observed that the *TaMRP-D1* variants were linked to the FHB and mycotoxin resistance in the cultivars with the non-semi-dwarf allele of *Rht8*. The efficient use of this FHB-QTL on the 2DS region as breeding resource requires the breaking of the linkage drag between the FHB-QTL and semi-dwarfism (Basnet *et al.* 2012, Niwa *et al.* 2018, Fabre *et al.* 2020).

Other functional variations between Norin 61 and CS responsible for adaptation to East Asian environments

The three homeologous *R-1* genes (on group 3 chromosomes) control grain color and preharvest sprouting (Warner *et al.* 2000, Flintham *et al.* 2002, Himi *et al.* 2002, Lin *et al.* 2016,

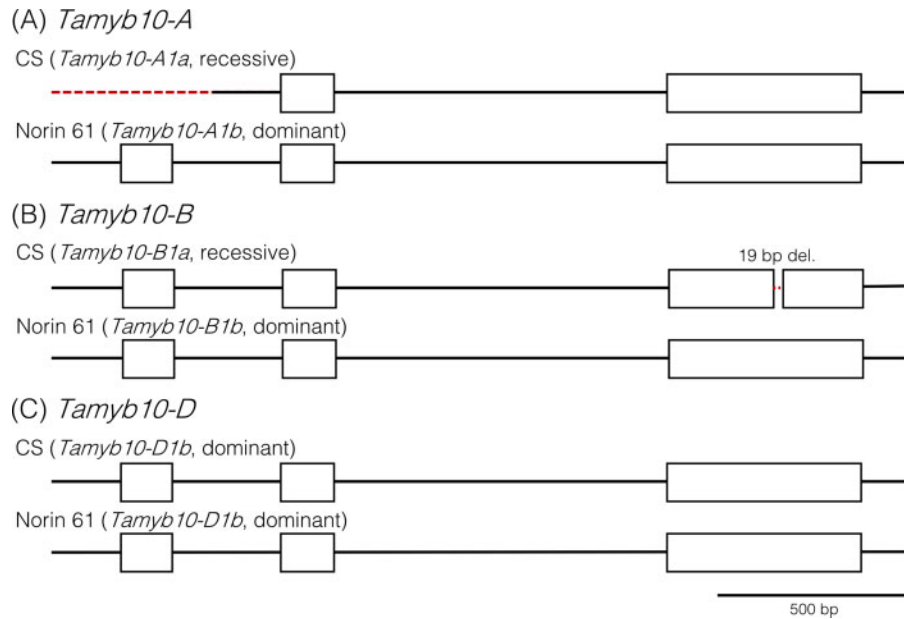

Fig. 7 Schematic features of *Tamyb10* sequences of CS and Norin 61. (A) *Tamyb10-A1*. CS has the recessive allele (*Tamyb10-A1a*), characterized by a large deletion, including the start codon. Norin 61 has the (wild type) dominant allele (*Tamyb10-A1b*). (B) *Tamyb10-B1*. The CS has the recessive allele (*Tamyb10-B1a*) has a 19-bp deletion and Norin 61 has the dominant *Tamyb10-B1b* allele. (C) *Tamyb10-D1*. Both CS and Norin 61 have the identical dominant allele (*Tamyb10-D1b*). The boxes indicate CDSs. The red dashed lines show the sequence polymorphisms between CS and Norin 61 assemblies.

Vetch et al. 2019). A plant homozygous for the recessive alleles of *R-A1a*, *R-B1a* and *R-D1a* (*r2*, *r3* and *r1*, respectively, in a former notation) has white grain. The presence of at least one dominant allele, i.e. *R-A1b*, *R-B1b* or *R-D1b* (*R2*, *R3* and *R1*, respectively), turns the grain color to red (McIntosh et al. 2013). The *Tamyb10* genes, which encode R2R3-type MYB domain proteins, are candidates for *R-1* and are used as a marker to detect dominant *R-1* alleles (Himi and Noda 2005, Himi et al. 2011). Although both CS and Norin 61 are red grain varieties, their underlying genotypes are different (Himi et al. 2011, Kojima et al. 2017). The sequence analysis suggested that Norin 61 retains the functional (i.e. dominant) allele at all three homeologous loci (Fig. 7, Supplementary Fig. S8). By contrast, *Tamyb10-A1* of CS contained a deletion of the first half of the R2 repeat, including the start codon (Fig. 7A), as well as a synonymous mutation and an intronic mutation. *Tamyb10-B1* of CS contained a disrupting 19-bp deletion in the third exon (Fig. 7B). *Tamyb10-D1* of both CS and Norin 61 were identical dominant alleles (Fig. 7C).

Semi-dwarf mutations of wheat are thought to be advantageous to increase yield in short growing seasons and to confer lodging resistance (Miralles and Slafer 1995, Asplund et al. 2012, Jobson et al. 2019). *Rht-B1b* (formerly designated *Rht1*) and *Rht-D1b* (*Rht2*) genes are orthologous to the *GIBBERELLIN INSENSITIVE (GAI)* of *Arabidopsis* (Peng et al. 1999, Kojima et al. 2017) and confer semi-dwarfism in wheat. Each allele contains a single-nucleotide polymorphism (SNP) that results in a stop codon within the DELLA domain, and translational reinitiation after this polymorphism produces a gain-of-function protein that represses gibberellin signaling (Peng et al. 1999). Both variants are present in the Japanese cultivar

Norin 10 and were used during the green revolution to confer lodging resistance to wheat grown in fertilized conditions (Peng et al. 1999). The genome analysis confirmed that Norin 61 possesses a semi-dwarf *Rht-D1b* allele with the SNP in contrast to CS (Supplementary Fig. S9). We further genotyped other cultivars in the next section.

Norin 61 carries the *Glu-D1f* allele that produces the 2.2 + 12 subunits of the high-molecular-weight (HMW) glutenin, first described by Payne et al. (1983) in Japanese hexaploid wheat varieties. HMW glutenin proteins are integral to end-use quality characteristics through the formation of the gluten matrix. The *Glu-D1* locus contains two genes, each encodes for an x and y subunits, that together constitute the HMW glutenin types (i.e. 2.2x + 12y or 2x + 12y). The 2.2 + 12 allele is also referred to as the f allele, and 2 + 12 as the a allele (Payne and Lawrence 1983). The very low electrophoretic mobility of the 2.2x protein on sodium dodecyl sulfate-polyacrylamide gel electrophoresis (SDS-PAGE) suggested that the protein was much larger in size than any other hexaploid HMW glutenin subunits known at the time. It was then hypothesized that 2.2x arose from an unequal crossing over in the central repeat domain of 2x that increased the size of the gene and that this novel allele is very recent, within the modern breeding history. This is supported by failure to identify 2.2 + 12 in surveys of *Glu-D1* SDS-PAGE mobilities in *Ae. tauschii* (Lagudah and Halloran 1988, William et al. 1993, Mackie et al. 1996), the D genome donor to hexaploid wheat, and that 2.2 + 12 is present primarily only in Japanese germplasm (Nakamura et al. 1999, Yanaka et al. 2016) indicated that 2.2x arose from recent mutation within hexaploid wheat. Further evidence for this hypothesis was provided by the full gene CDSs comparing 2.2x to 2x that showed

2.2x has a perfect 396 nucleotide duplication in the central repeat region (Wan et al. 2005).

Within the 257-kb region around the *Glu-D1* locus, we surveyed SNPs. There exists only 10 SNPs differentiating 2.2 + 12 from 2 + 12 of CS and other wheat varieties (Long Reach Lancer, ArinaLrFor, Mace, SY Mattis) (Supplementary Fig. S10A). The number was much less than the 72 SNPs differentiating the 2 + 12 sequences among the wheat varieties CS, Long Reach Lancer, ArinaLrFor, Mace and SY Mattis in the same region. Analysis with MUMmer showed no large-scale structural differences between 2.2 + 12 and 2 + 12 of CS, aside from 11 gaps ranging between 33 and 5,381 bp. Gaps were likely assembly artifacts, evidenced by Norin 61 reads aligning to the CS 'gap' regions. Due to the highly repetitive nature of the central repeat domain and the limitations of short-read sequencing, we were unable to directly detect the 396 duplication in 2.2x relative to 2x. However, with the genome assembly of Norin 61, we support here that the unique 2.2 + 12 in Japanese germplasm arose from a recent mutation of 2 + 12, as well as identify several molecular variants that could be used as a high-throughput molecular marker in breeding to differentiated 2.2 + 12 from the common 2 + 12 (Supplementary Fig. S10B).

Functional variations in other Japanese cultivars

To examine whether the variants found in Norin 61 are shared with other Japanese cultivars, PCR testing for markers of eight loci was performed on three Japanese cultivars (Shinchunaga, Norin 26 and Shirasagi komugi), as well as Norin 61 and CS (Table 5). As described above, Shinchunaga is a pure-line selection from a landrace and was used as a parent of Norin 61. Norin 26 is also derived from Shinchunaga and was released in 1937. It was the second most cultivated variety after Norin 61 in the 1950s and 1960s and was popular for Japanese udon noodles. Shirasagi komugi is also a cultivar of Shinchunaga lineage (released in 1956) with earlier maturing than Norin 61. The analysis showed that the same alleles present in Norin 61 were found in these three Japanese cultivars at three *Ppd1* and three *Vrn1* loci (Table 5, Saisho et al. 2011, Nishida et al. 2013). The semi-dwarf allele of *Rht-D1b* (Kojima et al. 2017) of Norin 61 was not found in the other cultivars; instead, Norin 26 and Shirasagi komugi possessed another semi-dwarf allele of *Rht-B1b*. By contrast, CS possesses different genotypes at *Ppd* and *Rht* loci (Table 5).

Discussion

In this study, we analyzed the chromosome-scale assembly of the Japanese wheat Norin 61 as the sole Asian cultivar in the 10+ Wheat Genomes Project. In addition to using standard statistics, such as N50, remapping, KAT, and BUSCO analysis, we validated the quality of the assembly by showing synteny to more than an Mb of the BAC contigs encompassing the resistant *Fhb1* haplotype on chromosome 3B. We were able to identify and confirm SNPs and indel mutations of up to kilobase scales of functional variants, including *Ppd*, *TaHRC*, *Rht* and *Tamyb10*. These data supported the high quality of the assembly for analysis of functional variations. Our manual inspection identified copy-number variations in *FT-B1*, suggesting that tandem duplications remain a major challenge in wheat genomics (Alonge et al. 2020).

Of the accessions whose karyotypes were compared, Norin 61 had the karyotype most similar to that of CS (Walkowiak et al. 2020). In contrast to the modern introgressions from different species that are seen in Western cultivars used in the 10+ Wheat Genomes Project, none of the known ancestors of Norin 61 are foreign species. The number of unique chromosomal segments in Norin 61 (45 regions) was less than the 54 observed in CS. These cytogenetic and repetitive element analyses suggested that Norin 61 as well as CS can serve as useful reference genomes for functional and evolutionary analysis.

Analysis of the distribution pattern of repetitive sequences on the chromosomes of the 10 wheat genomes identified hundreds of chromosomal segments with unique or rare retrotransposon insertions (>20 Mb) in A, B and D chromosomes that were hypothesized to be introgressions (Walkowiak et al. 2020). Among these are introgressions introduced during modern breeding of Western cultivars that originate from *Triticum timopheevii*, *Aegilops ventricosa* and *Thinopyrum ponticum* and that confer disease resistance (Walkowiak et al. 2020). Introgression from wild diploid and tetraploid species with A, B or D genomes may be common (Zhou et al. 2020). Norin 61 contains 45 unique chromosomal regions, and we analyzed two of these in detail. We found that these Norin 61 regions contain numerous genes that lack homology with CS genes. In both regions, Norin 61 contains tandem copies of the PR-13/Thionin gene family, which is well known to be toxic to plant pathogens (Stec 2006, Sels et al. 2008, Goyal and Mattoo 2014, Rogozhin et al. 2018). The low level of sequence conservation and presence or absence of large chromosomal segments

Table 5 Genotypes of Japanese cultivars at loci regulating flowering time and plant height

Cultivar name	Status	<i>Ppd-A1</i>	<i>Ppd-B1</i>	<i>Ppd-D1</i>	<i>Vrn-A1</i>	<i>Vrn-B1</i>	<i>Vrn-D1</i>	<i>Rht-B1</i>	<i>Rht-D1</i>
Komugi Norin 61	Breeders line	<i>ppd-A1</i>	<i>ppd-B1</i>	<i>Ppd-D1</i>	<i>vrn-A1</i>	<i>vrn-B1</i>	<i>Vrn-D1</i>	<i>Rht-B1a</i>	<i>Rht-D1b</i>
Shinchunaga	Pure selected line	<i>ppd-A1</i>	<i>ppd-B1</i>	<i>Ppd-D1</i>	<i>vrn-A1</i>	<i>vrn-B1</i>	<i>Vrn-D1</i>	<i>Rht-B1a</i>	<i>Rht-D1a</i>
Komugi Norin 26	Breeders line	<i>ppd-A1</i>	<i>ppd-B1</i>	<i>Ppd-D1</i>	<i>vrn-A1</i>	<i>vrn-B1</i>	<i>Vrn-D1</i>	<i>Rht-B1b</i>	<i>Rht-D1a</i>
Shirasagi komugi	Breeders line	<i>ppd-A1</i>	<i>ppd-B1</i>	<i>Ppd-D1</i>	<i>vrn-A1</i>	NA	<i>Vrn-D1</i>	<i>Rht-B1b</i>	<i>Rht-D1a</i>
CS	Standard line	<i>ppd-A1</i> ^a	<i>ppd-B1</i>	<i>ppd-D1</i>	<i>vrn-A1</i>	<i>vrn-B1</i>	<i>Vrn-D1</i>	<i>Rht-B1a</i>	<i>Rht-D1a</i>

Ppd-D1 and *ppd-D1* correspond to *Ppd-D1a* and *Ppd-D1b* in Fig. 5, respectively.

^aData from Nishida et al. (2013).

indicates that these introgressions must have come from distant genetic backgrounds. One of the 54 unique regions of CS coincided with the *Fhb1* chromosomal region responsible for resistance to *Fusarium*. Our de novo annotation of the region supported that the gene content and CDSs are highly divergent between CS and Norin 61. The haplotype of CS may confer an unknown different phenotype, such as resistance to other pathogens. We suggest that these unique chromosomal segments were introgressions from distinct genotypes and may have contributed to adaptive variations. These data also highlight the diversity present (and partially untapped) in East Asian cultivars.

In contrast to the three introgressions from distant species into Western cultivars discussed above (Walkowiak et al. 2020), the origin of the unique chromosomal regions in Norin 61 and CS is currently unclear. They are not likely introgressions from other species introduced during modern breeding because their known pedigrees do not include other species. In East Asia, the distribution of wild wheat relatives is limited, except for some populations of the DD genome species *Ae. tauschii*; thus, local introgression from wild relatives does not seem adequate to explain the large number of such regions distributed in the A, B and D chromosomes. We suggest that early bread wheat acquired these diverse chromosomal regions close to its origin in the Near East, and some of the polymorphisms were maintained throughout its dispersal to East Asia.

One way to address this question is to consider and unravel the demography of Asian wheat. Archaeological studies suggest that wheat arrived in China >4,000 years ago, reaching the islands of Japan >2,000 years ago (Kato 2000, Li et al. 2007, Fujita 2013, Barton and An 2014). The arrival of agriculture in Japan during the Yayoi period is considered a typical case of the farming/language dispersal hypothesis (Diamond and Bellwood 2003), but, compared with that of rice, the role of wheat in this process is not clear. Bioinformatic tools to analyze the genome-wide polymorphisms of polyploid species have been developed (Akama et al. 2014, Paape et al. 2018). The polymorphism analysis of Asian wheat together with a recently reported Tibetan wheat genome (Guo et al. 2020) and an updated version of CS (Alonge et al. 2020) will contribute to shed light on the origin of their high genetic diversity and selection.

Although both Norin 61 and CS originated in East Asia, our analysis of functional variations highlighted important differences between the two lines. CS is an experimental strain likely to be derived from a landrace in Sichuan, China (Liu et al. 2018). Norin 61 is a modern cultivar that has been widely cultivated in Japan for decades because of traits that confer high yield and superior grain quality in the Japanese climate. Our genome assembly of Norin 61 verified variations, including FHB resistance (*Fhb1*), grain quality (*Glu-D1*), semi-dwarfism (*Rht-D1*) and early flowering (*Ppd-D1*). In addition, our genotyping data together with previous genotyping of 12 genes of 96 cultivars (Kojima et al. 2017) supported that these functional variants are shared with many other Japanese cultivars, suggesting that the genome sequence of Norin 61 would be useful as a representative of modern Japanese cultivars.

In this analysis, we identified novel variations in the homeologs of the florigen gene *FT1/Vrn3*. Interestingly, all three homeologs of wheat showed copy number or indel variations. *FT-D1* of Norin 61 is a pseudogene with a frameshift 1-bp deletion. By contrast, we found two copies of *FT-B1* in Norin 61. The presence of at least two copies was supported both by the assembly sequence and by coverage analysis. Unexpectedly, although the RefSeq v1.1 of CS [The International Wheat Genome Sequencing Consortium (IWGSC) 2018] had only a single copy of *FT-B1*, our coverage analysis suggested the presence of additional copies also in CS, which were subsequently confirmed by the new assembly of CS (CS RefSeq v2.0). The presence of three or more copies in Norin 61 cannot be excluded from the current data. In addition, we found that allelic differences of *FT-A1* were associated with the spring or winter habit. Although the data presented indicate only an association without considering population structure, they suggest that the *Vrn-A3c* allele contributes to the early flowering of winter wheat, not that of spring wheat, assuming a functional difference in tetraploid wheat. An obvious next step would be to test the functional significance of these mutations on flowering time because flowering time has been a major target in Japanese wheat breeding programs.

Given the underexploitation of Asian germplasm in the most recent worldwide varieties (Balfourier et al. 2019), the use of the material to identify new QTLs and the responsible mutations would be important. A nested association mapping line using Norin 61 as the common parent crossed with diverse Asian cultivars is being developed by the National BioResource Project-KOMUGI. For example, a resistant allele of the FHB-resistant gene, *Fhb1*, was found in East Asian cultivars (Niwa et al. 2018) and is now used for breeding worldwide. However, *Fhb1* alone is not sufficient to control FHB and so FHB resistance from additional and more diverse sources should be integrated into new varieties. The molecular nature of many QTLs on the FHB-resistant gene is yet to be studied (Handa et al. 2008, Niwa et al. 2018). The use of FHB-QTL in 2DS, another gene resource for the FHB resistance of Asian germplasms (Basnet et al. 2012, Niwa et al. 2018, Fabre et al. 2020), was hampered by its linkage to the non-semi-dwarf allele of *Rht8* and so will be facilitated by further studies to allow pyramiding the FHB-resistant alleles. We propose that the de novo genome assembly of Norin 61 will open the way to analysis of the functional variants and evolution of East Asian wheat.

Materials and Methods

Plant material

The accession of Norin 61 was provided by NBRP-Wheat, Japan (Accession Number LPGKU 2305). This genotype is originally in the collection of Dr. Takashi Endo, Kyoto University, Japan, who provided the seed to Dr. Koji Murai, Fukui Prefectural University. Shuhei Nasuda obtained the seed from Dr. Koji Murai in 2010 and self-pollinated by bagging more than five times. A bulk collection of seeds from a single Norin 61 plant was used for this study. The seed is accessible at NBRP-Wheat (<https://shigen.nig.ac.jp/wheat/komugi/>, last accessed on Dec. 15, 2020) and also from the John Innes Centre (<https://www.seedstor.ac.uk/index.php>, last accessed on Dec. 15, 2020).

Sequencing data

WGS PE and MP libraries were prepared at the Carver Biotechnology Center, University of Illinois, USA. 10× Genomics Chromium libraries were developed at HudsonAlpha, USA. The libraries were sequenced on Illumina HiSeq 2500 (v2 and v4) and HiSeq 4000 sequencers at the Functional Genomics Center Zurich (Switzerland), IPK (Germany), and Carver Biotechnology Center, University of Illinois (USA). Details about library features and sequencing coverage are reported in **Table 1**. The conformation capture library was prepared using a variant (TCC) of the original Hi-C method (Lieberman-Aiden et al. 2009, Tiang et al. 2012, Concia et al. 2020) as described previously (Mascher et al. 2017, Himmelbach et al. 2018).

Assembly strategy

WGS libraries and linked read data were assembled with NRGene's (Ness-Ziona, Israel) DenovoMAGIC™ 3.0 pipeline and later scaffolded with Hi-C and POPSEQ data using TRITEX (Monat et al. 2019) (more details in Walkowiak et al. 2020). Assembly statistics were calculated with assembly-stats (<https://github.com/sanger-pathogens/assembly-stats>).

Assembly validation and coverage analysis

After including bread wheat chloroplast and mitochondrial genomes (NC_002762.1 and NC_036024.1, respectively), short reads of the PE700 library were aligned to the final assembly with minimap2 v2.17-r974-dirty (Li 2018) and statistics were calculated using the SAMtools v1.9 (Li et al. 2009) functions stats and flagstats. KAT v2.4.1 (Mapleson et al. 2017) was run in comp mode with `-h -m 21 -H 30000000000` settings on the PE700 reads and the assembly. BUSCO v3.1.0 (Seppey et al. 2019) was run (with `embryophyta_odb9` as a database and wheat as a species for Augustus) on the assembly and on the primary isoform of each predicted gene.

For the coverage analysis, a subset of CS and Norin 61 PE700 reads was aligned to the respective assemblies with HISAT2 v2.1.0 (Kim et al. 2019). Secondary and supplementary alignments were removed with SAMtools view and coverage functions. The coverage of the assembly region containing the *Adh-1* and *Vrn3* transcripts was calculated with BEDtools coverage (Quinlan and Hall 2010, v2.26.0) adopting the `-mean` option. Given that only primary alignments were retained to calculate coverage, there is no possibility that the counts could have originated from inflation of the coverage by counting alignments of the same read multiple times.

Cytogenetics

Chromosomes in the root tip meristem were prepared by the conventional acetocarmine-squash method (Murata et al. 2018). We performed nondenaturing FISH with three repetitive-sequence probes following the methodology described by Tang et al. (2014) and Zhao et al. (2016). The three oligo probes were: Oligo-pSc119.2-1 (Tamra-5'-CCGTT TTGTG GACTA TTAAT CACCG CTTTG GGGTC CCATA GCTAT-3'), Oligo-pTa535 (AlexaFluor488-5'-GACGA GAAT CATCT GTTAC ATGGG CACTT CAATG TTTT TAAAC TTATT TGAAC TCCA-3'), and Oligo-pTa713 (AlexaFluor647-5'-AGACG AGCAC GTGAC ACCAT TCCCA CCCTG TCTTA GCGTA ACGCG AGTCG-3'). Chromosomes were counterstained with 4',6-diamidino-2-phenylindole. Chromosomes were viewed using a BX61 epifluorescence microscope (Olympus, Tokyo, Japan) and captured using a CCD camera DP80 (Olympus). Images were processed and pseudocolored using ImageJ 1.51n in the Fiji package (Schindelin et al. 2012). For karyotyping, at least four chromosomes per accession were examined with reference to the karyotype of CS reported by Komuro et al. (2013).

Whole-genome alignment

Whole-genome sequence alignment was performed using LAST v957 (Frith and Kawaguchi 2015) with the CS assembly as the reference and Norin 61 as query. The many-to-one Norin 61 to CS alignments were then parsed to keep only the one-to-one hits. We processed the alignments and created dot plot visualizations using the scripts included with LAST. First, we used `last-postmask` to discard low complexity alignments and alignments with error probability $>10^{-5}$. Then, the resulting output files were converted into a tabular format using `maf-convert` from which the dot plots were created with `last-dotplot`.

Identification of flowering-related genes and phylogenetic analysis

Flowering-related genes in CS were identified by BLAST search (Altschul et al. 1997) of the sequence using known *FT*, *MFT* and *FTL* genes of Arabidopsis, rice and wheat as queries (Table 2) against CS RefSeq v1.1 [The International Wheat Genome Sequencing Consortium (IWGSC) 2018] with default parameters. Splicing variants of the *FT* genes described by Halliwell et al. (2016) were not used for this study. From Norin 61, the flowering-related genes were detected based on homology search comparing CS sequences with the Norin 61 pseudomolecules.

A total of 108 amino acid sequences of *FT* genes were aligned using MUSCLE (Edgar 2004). The alignments and the splicing boundaries of *FT* genes were manually curated according to BLASTN results. The nucleotide sequences of *FT1* homeologs in CS and Norin 61 (Table 2) were used for phylogenetic analysis.

The extra copies of *FT-B1* were identified based on the CDSs of *FT-B1* in CS compared with the pseudomolecules of CS (RefSeq v2.0, <https://www.wheatgenome.org/News2/IWGSC-RefSeq-v2.0-now-available-at-URGI> (last accessed on Dec. 15, 2020), and Alonge et al. 2020) and Norin 61.

Phylogenetic trees were built using translated protein sequences of 108 *FT* homeologs of wheat with a few rice and Arabidopsis sequences identified. A neighbor-joining (NJ) tree and a maximum-likelihood (ML) tree were constructed using MEGA X (Kumar et al. 2018). All positions of gaps and missing data were removed, and bootstrap probability was calculated for 1,000 replications. Both NJ and ML phylogenetic analyses were performed. The phylogenetic analysis of all *FT* genes involved 111 amino acid positions. The evolutionary distances were computed using the Poisson correction method (Zuckerkanndl and Pauling 1965) for the NJ tree. The JTT matrix-based model (Jones et al. 1992) was used as the substitution model and the tree inference for the ML tree. The phylogenetic analysis of *FT1* genes involved 11 nucleotide sequences. *OsHd3a* (GenBank accession: AB052941) and *OsRFT1* (GenBank accession: AB062675.1) were used as the outgroups. The trees were constructed based on 530 nucleotide sequences, and the evolutionary distances were computed using the Kimura 2-parameter method (Kimura 1980).

Definition of syntenic and unique genes, annotation and phylogenetic analysis of the unique chromosomal regions

All CDSs of all genes annotated on Norin 61 chromosomes were used for BLASTN (Walkowiak et al. 2020) searches against the corresponding chromosomes in the CS reference genome. A Norin 61 gene was classified as syntenic if its closest homolog in CS was $>95\%$ identical at the DNA level and its chromosomal position differed by $<5\%$ of the total chromosome length from that of the CS homolog. A Norin 61 gene was classified as 'private' if no homeolog with an *E*-value below 10^{-6} was identified on the corresponding CS chromosome.

To obtain a genome-wide assessment of the level of collinearity, chromosome lengths were normalized to 100% and each gene assigned a relative position along the chromosome. Then, ratios of syntenic to private genes were calculated in running windows corresponding to 10% of the chromosome lengths. Data from individual subgenomes were compiled to assess the overall levels of synteny along the chromosomes of all three subgenomes (Supplementary Fig. S3A). It should be noted that the gene annotation of Norin 61 is projected from that of CS; thus, it could be biased by the gene content in CS. To compensate for this bias, we did bi-directional BLAST searches of gene families of interest (i.e. those on 1A and 3B candidate introgressions) and annotated genes by hand, if they were missed in the annotation either in CS or Norin61. The gene content of the genomic regions studied here will most likely change with an improved (de novo) gene annotation.

To identify possible genes that were missed during automated annotation, one representative protein sequence for each family was used in TBLASTN searches against the respective chromosomes of Norin 61 and CS. Protein sequences were extracted directly from BLAST outputs and segments corresponding to individual exons were connected, resulting in some cases in incomplete protein sequences. Nevertheless, the data contained enough sequence information to allow phylogenetic analyses. Newly identified genes

were named using an index for the chromosome and the chromosome position divided by 1,000. In very dense gene clusters, an additional running number was added to the name. CS homeologs from other subgenomes were used as outgroups for the phylogenetic analysis.

Predicted protein sequences were then aligned with ClustalW using a gap-opening penalty of 5.0 and a gap-extension penalty of 0.01. Alignments were manually checked; sequences that were predicted to be much longer than the majority were trimmed and realigned. Phylogenetic trees were constructed with MrBayes, using the mcmc option. MrBayes was run for at least 100,000 generations, or until the average standard deviation of split frequencies fell below 0.01. Trees were visualized with FigTree.

Sequence analysis of functional variants

Four genes controlling important breeding traits (*Ppd1*, *TaHRC*, *Rht1* and *Tamyb10*) were selected and identified by BLASTN search using default parameters against CS and Norin 61 pseudomolecules based on reported sequences (Supplementary Table S5). The CDSs were extracted from CDS fasta files of CS and Norin 61 based on the BLASTN results.

The region containing the *Fhb1*-resistant allele was annotated with MAKER v2.31.9 (Campbell et al. 2014) using the Norin 61 genomic interval, the UniProt Liliopsida proteome (downloaded in July 2020) and the annotation from Walkowiak et al. (2020). Augustus was run with wheat as a species, and the output was parsed removing models that had >40% similarity over >50% of their length to TE proteins via BLAST. Dot plots of genomic regions were produced with Gepard v1.40 (Krumsek et al. 2007). The sequence of the variety Clark was downloaded from NCBI (GenBank accession MK450309). The sequences of *Rht-D1* in Norin 61, *Tamyb10-A1* in CS and Norin 61 were manually extracted from the pseudomolecules using SAMtools (Li et al. 2009), because they were not annotated. The *Ppd-1* sequences were extracted with 5 kb of 5'-UTR region from pseudomolecules using SAMtools. The obtained sequences were aligned using MUSCLE (Edgar 2004) in MEGA X (Kumar et al. 2018).

Glu-D1 variation

Nucleotide variation in the *Glu-D1* locus of Norin 61 was determined by aligning 470-bp PE Illumina reads of all 10+ wheat pan genome varieties to the CS reference genome v1 with HISAT2 v2.1.0 using default parameters (Kim et al. 2019) and alignment sorting and indexing done with samtools v1.6 (Li et al. 2009). Variants within the *Glu-D1* subunits, the 57 kb between subunits and 100 kb flanking were called with bcftools v1.11 'mpileup' and 'call' with minimum alignment quality score of 20 and '-group-samples-' option (Li 2011). Heterozygous calls were set to missing and missing variants exceeding a proportion of 0.1 filtered out. Structural variation between the 2.2 + 12 locus of Norin 61 genome assembly v1.1 and 2 + 12 locus of CS genome assembly v1 was assessed with MUMmer v3.23 using default parameters (Kurtz et al. 2004).

Availability

The data are also accessible at IPK, Germany, <https://wheat.ipk-gatersleben.de/> (last accessed on Dec. 15, 2020), and BLAST server at the National Institute of Genetics, Japan, <https://shigen.nig.ac.jp/wheat/komugi/about/norin61GenomeSequence.jsp> (last accessed on Dec. 15, 2020). The gene annotation of the *Fhb1* locus can be downloaded from https://de.cyverse.org/dl/d/6A85909D-942B-4C95-AEB8-7B5516680878/Fhb1_N61_340kbregion.tar.gz.

Supplementary Data

Supplementary data are available at PCP online.

Funding

JST CREST (JPMJCR16O3) to K.K.S., S.N., J.S. and T.B.; Swiss National Science Foundation 31003A_182318, CRSII5_183578, NCCR Evolving Language # 51NF40_180888 and European Union's Horizon 2020 research and innovation programme

under the Marie Skłodowska-Curie (MSC) grant agreement No 847585 to K.K.S.; MEXT KAKENHI The Birth of New Plant Species (JP16H06469, JP16H06464, JP16H06466, JP16K21727) to J.S., K.K.S., and H.T.; National Agriculture and Food Research Organization (NARO) Vice President Fund to H.H.; NBRP Genome Information Upgrading Project 2017, AMED to S.N., J.S., K.K. and K.K.S.; University of Zurich Research Priority Program Evolution in Action to K.K.S. and T.W.; German Federal Ministry of Food and Agriculture grant 2819103915 'WHEATSEQ' to N.S.; and Canadian Triticum Applied Genomics research project (CTAG2) funded by Genome Canada, Genome Prairie, the Western Grains Research Foundation, Government of Saskatchewan, Saskatchewan Wheat Development Commission, Alberta Wheat Commission, Viterra and Manitoba Wheat and Barley Growers Association to C.P.

Acknowledgments

We would like to thank the IT Support Group D-HEST, ETH Zurich, the Functional Genomics Center Zurich and the International Wheat Genome Sequencing Consortium (IWGSC).

Disclosures

The authors declare no competing interests.

References

- Ahn, J.H., Miller, D., Winter, V.J., Banfield, M.J., Jeong, H.L., So, Y.Y., et al. (2006) A divergent external loop confers antagonistic activity on floral regulators FT and TFL1. *EMBO J.* 25: 605–614.
- Akama, S., Shimizu-Inatsugi, R., Shimizu, K.K. and Sese, J. (2014) Genome-wide quantification of homeolog expression ratio revealed nonstochastic gene regulation in synthetic allopolyploid *Arabidopsis*. *Nucleic Acids Res.* 42: e46–e46.
- Alonge, M., Shumate, A., Puiu, D., Zimin, A.V. and Salzberg, S.L. (2020) Chromosome-scale assembly of the bread wheat genome reveals thousands of additional gene copies. *Genetics* 216: 599–608.
- Altschul, S., Madden, T., Schäffer, A., Zhang, J., Zhang, Z., Miller, W., et al. (1997) Gapped BLAST and PSI-BLAST: a new generation of protein database search programs. *Nucleic Acids Res.* 25: 3389–3402.
- Ammerman, A.J. and Cavalli-Sforza, L.L. (1971) Measuring the rate of spread of early farming in Europe. *Man* 6: 674.
- Asplund, L., Leino, M.W. and Hagenblad, J. (2012) Allelic variation at the *Rht8* locus in a 19th century wheat collection. *Sci. World J.* 2012: 1–6.
- Avni, R., Nave, M., Barad, O., Baruch, K., Twardziok, S.O., Gundlach, H., et al. (2017) Wild emmer genome architecture and diversity elucidate wheat evolution and domestication. *Science* 357: 93–97.
- Balfourier, F., Bouchet, S., Robert, S., De Oliveira, R., Rimbart, H., Kitt, J., et al.; International Wheat Genome Sequencing Consortium (2019) Worldwide phylogeography and history of wheat genetic diversity. *Sci. Adv.* 5: eaav0536.
- Barton, L. and An, C.-B. (2014) An evaluation of competing hypotheses for the early adoption of wheat in East Asia. *World Archaeol.* 46: 775–798.
- Basnet, B.R., Glover, K.D., Ibrahim, A.M.H., Yen, Y. and Chao, S. (2012) A QTL on chromosome 2DS of 'Sumai 3' increases susceptibility to Fusarium head blight in wheat. *Euphytica* 186: 91–101.

- Beales, J., Turner, A., Griffiths, S., Snape, J.W. and Laurie, D.A. (2007) A *Pseudo-Response Regulator* is misexpressed in the photoperiod insensitive *Ppd-D1a* mutant of wheat (*Triticum aestivum* L.). *Theor. Appl. Genet.* 115: 721–733.
- Brahammer, A.B., Kono, T.J.Y. and Hirsch, C.N. (2018) The maize pan-genome. In *The Maize Genome. Compendium of Plant Genomes*. Edited by Bennetzen J., Flint-Garcia S., Hirsch C., Tuberosa R. Springer, Cham. 10.1007/978-3-319-97427-9_2. (Last accessed February 1, 2021)
- Campbell, M.S., Law, M.Y., Holt, C., Stein, J.C., Moghe, G.D., Hufnagel, D.E., et al. (2014) MAKER-P: A tool kit for the rapid creation, management, and quality control of plant genome annotations. *Plant Physiol.* 164: 513–524.
- Chai, L., Chen, Z., Bian, R., Zhai, H., Cheng, X., Peng, H., et al. (2019) Dissection of two quantitative trait loci with pleiotropic effects on plant height and spike length linked in coupling phase on the short arm of chromosome 2D of common wheat (*Triticum aestivum* L.). *Theor. Appl. Genet.* 132: 1815–1831.
- Chen, Z., Cheng, X., Chai, L., Wang, Z., Du, D., Wang, Z., et al. (2020) Pleiotropic QTL influencing spikelet number and heading date in common wheat (*Triticum aestivum* L.). *Theor. Appl. Genet.* 133: 1825–1838.
- Concia, L., Veluchamy, A., Ramirez-Prado, J.S., Martin-Ramirez, A., Huang, Y., Perez, M., et al. (2020) Wheat chromatin architecture is organized in genome territories and transcription factories. *Genome Biol.* 21: 104.
- Danyluk, J., Kane, N.A., Breton, G., Limin, A.E., Fowler, D.B. and Sarhan, F. (2003) *TaVRT-1*, a putative transcription factor associated with vegetative to reproductive transition in cereals. *Plant Physiol.* 132: 1849–1860.
- Diamond, J. and Bellwood, P. (2003) Farmers and their languages: the first expansions. *Science* 300: 597–603.
- Díaz, A., Zikhali, M., Turner, A.S., Isaac, P. and Laurie, D.A. (2012) Copy number variation affecting the photoperiod-B1 and vernalization-A1 genes is associated with altered flowering time in wheat (*Triticum aestivum*). *PLoS One* 7: e33234.
- Dodson, J.R., Li, X., Zhou, X., Zhao, K., Sun, N. and Atahan, P. (2013) Origin and spread of wheat in China. *Quat. Sci. Rev.* 72: 108–111.
- Doležel, J., Čížková, J., Šimková, H. and Bartoš, J. (2018) One major challenge of sequencing large plant genomes is to know how big they really are. *Int. J. Mol. Sci.* 19: 3554.
- Dubcovsky, J. and Dvorak, J. (2007) Genome plasticity a key factor in the success of polyploid wheat under domestication. *Science* 316: 1862–1866.
- Edgar, R.C. (2004) MUSCLE: Multiple sequence alignment with high accuracy and high throughput. *Nucleic Acids Res.* 32: 1792–1797.
- Elbashir, A.A.E., Gorañi, Y.S.A., Tahir, I.S.A., Elhashimi, A.M.A., Abdalla, M.G.A. and Tsujimoto, H. (2017) Genetic variation in heat tolerance-related traits in a population of wheat multiple synthetic derivatives. *Breed. Sci.* 67: 483–492.
- Eshed, Y. and Lippman, Z.B. (2019) Revolutions in agriculture chart a course for targeted breeding of old and new crops. *Science* 366: eaax0025.
- Fabre, F., Rocher, F., Alouane, T., Langin, T. and Bonhomme, L. (2020) Searching for FHB resistances in bread wheat: susceptibility at the crossroad. *Front. Plant Sci.* 11. 10.3389/fpls.2020.00731 (Last accessed February 1, 2021)
- Faure, S., Higgins, J., Turner, A. and Laurie, D. (2007) The FLOWERING LOCUS T-like gene family in barley (*Hordeum vulgare*). *Genetics* 176: 599–609.
- Flintham, J., Adlam, R., Bassoi, M., Holdsworth, M. and Gale, M. (2002) Mapping genes for resistance to sprouting damage in wheat. *Euphytica* 126: 39–45.
- Frith, M.C. and Kawaguchi, R. (2015) Split-alignment of genomes finds orthologies more accurately. *Genome Biol.* 16: 106.
- Fu, D., Szűcs, P., Yan, L., Helguera, M., Skinner, J.S., von Zitzewitz, J., et al. (2005) Large deletions within the first intron in VRN-1 are associated with spring growth habit in barley and wheat. *Mol. Genet. Genomics* 273: 54–65.
- Fujita, M. (2013) Wheat. In *Japanese History of Breeding*. Edited by Ukai, Y. and Osawa, R. pp. 48–73. Yuushokan, Tokyo, Japan (in Japanese).
- Fukunaga, K. and Inagaki, M. (1985) Genealogical pedigrees of Japanese wheat cultivars. *Jpn. J. Breed.* 35: 89–92 (in Japanese).
- Goyal, R.K. and Mattoo, A.K. (2014) Multitasking antimicrobial peptides in plant development and host defense against biotic/abiotic stress. *Plant Sci.* 228: 135–149.
- Guo, Z., Song, Y., Zhou, R., Ren, Z. and Jia, J. (2010) Discovery, evaluation and distribution of haplotypes of the wheat Ppd-D1 gene. *New Phytol.* 185: 841–851.
- Guo, W., Xin, M., Wang, Z., Yao, Y., Hu, Z., Song, W., et al. (2020) Origin and adaptation to high altitude of Tibetan semi-wild wheat. *Nat. Commun.* 11: 5085.
- Gutaker, R.M., Groen, S.C., Bellis, E.S., Choi, J.Y., Pires, I.S., Bocinsky, R.K., et al. (2020) Genomic history and ecology of the geographic spread of rice. *Nat. Plants* 6: 492–502.
- Halliwell, J., Borrill, P., Gordon, A., Kowalczyk, R., Pagano, M.L., Saccomanno, B., et al. (2016) Systematic investigation of FLOWERING LOCUS T-like Poaceae gene families identifies the short-day expressed flowering pathway gene, *TaFT3* in wheat (*Triticum aestivum* L.). *Front. Plant Sci.* 7: 857.
- Handa, H., Namiki, N., Xu, D. and Ban, T. (2008) Dissecting of the FHB resistance QTL on the short arm of wheat chromosome 2D using a comparative genomic approach: From QTL to candidate gene. *Mol. Breeding* 22: 71–84.
- Hatakeyama, M., Aluri, S., Balachadran, M.T., Sivarajan, S.R., Patrignani, A., Grüter, S., et al. (2018) Multiple hybrid de novo genome assembly of finger millet, an orphan allotetraploid crop. *DNA Res.* 25: 39–47.
- Higuchi, Y., Narumi, T., Oda, A., Nakano, Y., Sumitomo, K., Fukai, S., et al. (2013) The gated induction system of a systemic floral inhibitor, anti-florigen, determines obligate short-day flowering in chrysanthemums. *Proc. Natl. Acad. Sci. USA* 110: 17137–17142.
- Himi, E., Maekawa, M., Miura, H. and Noda, K. (2011) Development of PCR markers for Tamyb10 related to R-1, red grain color gene in wheat. *Theor. Appl. Genet.* 122: 1561–1576.
- Himi, E., Mares, D.J., Yanagisawa, A. and Noda, K. (2002) Effect of grain colour gene (R) on grain dormancy and sensitivity of the embryo to abscisic acid (ABA) in wheat. *J. Exp. Bot.* 53: 1569–1574.
- Himi, E. and Noda, K. (2005) Red grain colour gene (R) of wheat is a Myb-type transcription factor. *Euphytica* 143: 239–242.
- Himmelbach, A., Walde, I., Mascher, M. and Stein, N. (2018) Tethered chromosome conformation capture sequencing in Triticeae: a valuable tool for genome assembly. *Bioprotocol* 8: e2955.
- Hu, G., Grover, C.E., Arick, M.A., Liu, M., Peterson, D.G. and Wendel, J.F. (2020) Homoeologous gene expression and co-expression network analyses and evolutionary inference in allopolyploids. *Brief Bioinform.* doi: 10.1093/bib/bbaa035.
- Hyles, J., Bloomfield, M.T., Hunt, J.R., Trethowan, R.M. and Trevaskis, B. (2020) Phenology and related traits for wheat adaptation. *Heredity* 125: 417–430.
- Ikeda, T.M., Nagamine, T., Fukuoka, H. and Yano, H. (2002) Identification of new low-molecular-weight glutenin subunit genes in wheat. *Theor. Appl. Genet.* 104: 680–687.
- Ishikawa, N. (2010) Recent progress and future tasks in wheat breeding at Kanto, Tokai and western Japan. *J. Crop Res.* 55: 1–8 (in Japanese with English summary).
- Jobson, E.M., Johnston, R.E., Oiestad, A.J., Martin, J.M. and Giroux, M.J. (2019) The impact of the wheat *Rht-B1b* semi-dwarfing allele on photosynthesis and seed development under field conditions. *Front. Plant Sci.* 10: 51.
- Jones, D.T., Taylor, W.R. and Thornton, J.M. (1992) The rapid generation of mutation data matrices from protein sequences. *Bioinformatics* 8: 275–282.
- Kane, N.A., Danyluk, J., Tardif, G., Ouellet, F., Laliberté, J., Limin, A.E., et al. (2005) *TaVRT-2*, a member of the *StMADS-11* clade of flowering repressors, is regulated by vernalization and photoperiod in wheat. *Plant Physiol.* 138: 2354–2363.
- Kasajima, S.-Y., Inoue, N. and Mahmud, R. (2009) Response spectrum for green light-induced acceleration of heading in wheat cv. Norin 61. *Plant Prod. Sci.* 12: 54–57.

- Kato, K. (2000) Komugi ga nihon ni kita michi. In *Mugi No Shizenshi*. Edited by Sato, Y. and Kato, K. pp. 113–136 Hokkaido University Press, Sapporo (in Japanese).
- Kihara, H. (1944) Discovery of the DD-analyser, one of the ancestors of *Triticum vulgare* (abstr). *Agric. Hortic.* 19: 889–890 (in Japanese).
- Kikuchi, R., Kawahigashi, H., Ando, T., Tonooka, T. and Handa, H. (2009) Molecular and functional characterization of PEBP genes in barley reveal the diversification of their roles in flowering. *Plant Physiol.* 149: 1341–1353.
- Kim, D., Paggi, J.M., Park, C., Bennett, C. and Salzberg, S.L. (2019) Graph-based genome alignment and genotyping with HISAT2 and HISAT-genotype. *Nat. Biotechnol.* 37: 907–915.
- Kimura, M. (1980) A simple method for estimating evolutionary rates of base substitutions through comparative studies of nucleotide sequences. *J. Mol. Evol.* 16: 111–120.
- Kobayashi, F., Tanaka, T., Kanamori, H., Wu, J., Katayose, Y. and Handa, H. (2016) Characterization of a mini core collection of Japanese wheat varieties using single-nucleotide polymorphisms generated by genotyping-by-sequencing. *Breed. Sci.* 66: 213–225.
- Kojima, H., Fujita, M., Matsunaka, H., Seki, M., Chono, M., Kiribuchi-Otobe, C., et al. (2017) Development and evaluation of the core collection of Japanese wheat varieties. *Bull. NARO Crop Sci.* 1: 1–13 (in Japanese with English summary).
- Komuro, S., Endo, R., Shikata, K. and Kato, A. (2013) Genomic and chromosomal distribution patterns of various repeated DNA sequences in wheat revealed by a fluorescence in situ hybridization procedure. *Genome* 56: 131–137.
- Korzun, V., Röder, M.S., Ganai, M.W., Worland, A.J. and Law, C.N. (1998) Genetic analysis of the dwarfing gene (Rht8) in wheat. Part I. Molecular mapping of Rht8 on the short arm of chromosome 2D of bread wheat (*Triticum aestivum* L.). *Theor. Appl. Genet.* 96: 1104–1109.
- Krumsiek, J., Arnold, R. and Rattei, T. (2007) Gepard: A rapid and sensitive tool for creating dotplots on genome scale. *Bioinformatics* 23: 1026–1028.
- Kumar, S., Stecher, G., Li, M., Nkayaz, C. and Tamura, K. (2018) MEGA X: Molecular evolutionary genetics analysis across computing platforms. *Mol. Biol. Evol.* 35: 1547–1549.
- Kuo, T.C.Y., Hatakeyama, M., Tameshige, T., Shimizu, K.K. and Sese, J. (2020) Homeolog expression quantification methods for allopolyploids. *Brief Bioinform.* 21: 395–407.
- Kurtz, S., Phillippy, A., Delcher, A.L., Smoot, M., Shumway, M., Antonescu, C., et al. (2004) Versatile and open software for comparing large genomes. *Genome Biol.* 5: R12.
- Lagudah, E.S. and Halloran, G.M. (1988) Phylogenetic relationships of *Triticum tauschii* the D genome donor to hexaploid wheat. *Theor. Appl. Genet.* 75: 592–598.
- Leitch, A.R. and Leitch, I.J. (2008) Genomic plasticity and the diversity of polyploid plants. *Science* 320: 481–483.
- Li, G., Zhou, J., Jia, H., Gao, Z., Fan, M., Luo, Y., et al. (2019) Mutation of a histidine-rich calcium-binding-protein gene in wheat confers resistance to *Fusarium* head blight. *Nat. Genet.* 51: 1106–1112.
- Li, H. (2011) A statistical framework for SNP calling, mutation discovery, association mapping and population genetical parameter estimation from sequencing data. *Bioinformatics* 27: 2987–2993.
- Li, H. (2018) Minimap2: Pairwise alignment for nucleotide sequences. *Bioinformatics* 34: 3094–3100.
- Li, H., Handsaker, B., Wysoker, A., Fennell, T., Ruan, J., Homer, N., et al.; 1000 Genome Project Data Processing Subgroup (2009) The sequence alignment/map format and SAMtools. *Bioinformatics* 25: 2078–2079.
- Li, X., Dodson, J., Zhou, X., Zhang, H. and Masutomoto, R. (2007) Early cultivated wheat and broadening of agriculture in Neolithic China. *Holocene* 17: 555–560.
- Lieberman-Aiden, E., Van Berkum, N.L., Williams, L., Imakaev, M., Ragozcy, T., Telling, A., et al. (2009) Comprehensive mapping of long-range interactions reveals folding principles of the human genome. *Science* 326: 289–293.
- Lin, M., Zhang, D., Liu, S., Zhang, G., Yu, J., Fritz, A.K., et al. (2016) Genome-wide association analysis on pre-harvest sprouting resistance and grain color in U.S. winter wheat. *BMC Genomics* 17: 794.
- Liu, D., Zhang, L., Hao, M., Ning, S., Yuan, Z., Dai, S., et al. (2018) Wheat breeding in the hometown of Chinese Spring. *Crop J.* 6: 82–90.
- Mackie, A.M., Lagudah, E.S., Sharp, P.J. and Lafandra, D. (1996) Molecular and biochemical characterisation of HMW glutenin subunits from *T. tauschii* and the D genome of hexaploid wheat. *J. Cereal Sci.* 23: 213–225.
- Mapleson, D., Accinelli, G.G., Kettleborough, G., Wright, J. and Clavijo, B.J. (2017) KAT: A K-mer analysis toolkit to quality control NGS datasets and genome assemblies. *Bioinformatics* 33: 574–576.
- Mascher, M., Gundlach, H., Himmelbach, A., Beier, S., Twardziok, S.O., Wicker, T., et al. (2017) A chromosome conformation capture ordered sequence of the barley genome. *Nature* 544: 427–433.
- Matsuo, H., Kohno, K. and Morita, E. (2005) Molecular cloning, recombinant expression and IgE-binding epitope of omega-5 gliadin, a major allergen in wheat-dependent exercise-induced anaphylaxis. *FEBS J.* 272: 4431–4438.
- Matsuoka, Y. (2011) Evolution of polyploid *Triticum* wheats under cultivation: The role of domestication, natural hybridization and allopolyploid speciation in their diversification. *Plant Cell Physiol.* 52: 750–764.
- Mayrose, I., Zhan, S.H., Rothfels, C.J., Magnuson-Ford, K., Barker, M.S., Rieseberg, L.H., et al. (2011) Recently formed polyploid plants diversify at lower rates. *Science* 333: 1257–1257.
- McFadden, E. and Sears, E. (1944) The artificial synthesis of *Triticum spelta*. *Rec. Genet. Soc. Am.* 13: 26–27.
- McIntosh, R.A., Yamazaki, Y., Dubcovsky, J., Rogers, J., Morris, C., Apples, R., et al. (2013) Catalogue of gene symbols for wheat. In *Proceedings of the 12th International Wheat Genetics Symposium*. pp. 74–75.
- Meguro, A., Takumi, S., Ogihara, Y. and Murai, K. (2003) WAG, a wheat AGAMOUS homologue, is associated with development of pistil-like stamens in alloplasmic wheat. *Sex. Plant Reprod.* 15: 221–230.
- Minoda, T. (2010) Effects of climatic conditions on the yield of wheat variety 'Norin 61' in the experimental upland field in Saitama Prefecture. *Jpn. J. Crop Sci.* 79: 62–68 (in Japanese with English summary).
- Miralles, D.J. and Slafer, G.A. (1995) Yield, biomass and yield components in dwarf, semi-dwarf and tall isogenic lines of spring wheat under recommended and late sowing dates. *Plant Breed.* 114: 392.
- Mizuno, N., Nitta, M., Sato, K. and Nasuda, S. (2012) A wheat homologue of *PHYTOCLOCK1* is a candidate gene conferring the early heading phenotype to einkorn wheat. *Genes Genet. Syst.* 87: 357–367.
- Mizuno, N., Kinoshita, M., Kinoshita, S., Nishida, H., Fujita, M., Kato, K., et al. (2016) Loss-of-function mutations in three homoeologous *PHYTOCLOCK1* genes in common wheat are associated with the extra-early flowering phenotype. *PLoS One* 11: e0165618.
- Monat, C., Padmarasu, S., Lux, T., Wicker, T., Gundlach, H., Himmelbach, A., et al. (2019) TRITEX: chromosome-scale sequence assembly of Triticeae genomes with open-source tools. *Genome Biol.* 20: 284.
- Murai, K., Miyamae, M., Kato, H., Takumi, S. and Ogihara, Y. (2003) *WAP1*, a wheat *APETALA1* homolog, plays a central role in the phase transition from vegetative to reproductive growth. *Plant Cell Physiol.* 44: 1255–1265.
- Murata, K., Watanabe, S., Tsujimoto, H. and Nasuda, S. (2018) Cytological observation of chromosome breakage in wheat male gametophytes caused by gametocidal action of *Aegilops triuncialis*-derived chromosome 3C. *Genes Genet. Syst.* 93: 111–118.
- Nakamura, H., Inazu, A. and Hirano, H. (1999) Allelic variation in high-molecular-weight glutenin subunit Loci of Glu-1 in Japanese common wheats. *Euphytica* 106: 131–138.
- Nemoto, Y., Kisaka, M., Fuse, T., Yano, M. and Ogihara, Y. (2003) Characterization and functional analysis of three wheat genes with homology to the *CONSTANS* flowering time gene in transgenic rice. *Plant J.* 36: 82–93.

- Ning, S., Wang, N., Sakuma, S., Pourkheirandish, M., Wu, J., Matsumoto, T., et al. (2013) Structure, transcription and post-transcriptional regulation of the bread wheat orthologs of the barley cleistogamy gene *Cly1*. *Theor. Appl. Genet.* 126: 1273–1283.
- Nishida, H., Yoshida, T., Kawakami, K., Fujita, M., Long, B., Akashi, Y., et al. (2013) Structural variation in the 5' upstream region of photoperiod-insensitive alleles *Ppd-A1a* and *Ppd-B1a* identified in hexaploid wheat (*Triticum aestivum* L.), and their effect on heading time. *Mol. Breed.* 31: 27–37.
- Nishimura, K., Moriyama, R., Katsura, K., Saito, H., Takisawa, R., Kitajima, A., et al. (2018) The early flowering trait of an emmer wheat accession (*Triticum turgidum* L. ssp. *dicoccum*) is associated with the *cis*-element of the *Vrn-A3* locus. *Theor. Appl. Genet.* 131: 2037–2053.
- Niwa, S., Kazama, Y., Abe, T. and Ban, T. (2018) Tracking haplotype for QTLs associated with Fusarium head blight resistance in Japanese wheat (*Triticum aestivum* L.) lineage. *Agric. Food Secur.* 7: 4.
- Ohta, S. (2010) Wheat. In *History of Crop Breeding*. Edited by Ukai, Y. and Osawa, R. pp. 41–66. Yuushokan, Tokyo, Japan (in Japanese).
- Paape, T., Briskine, R.V., Halstead-Nussloch, G., Lischer, H.E.L., Shimizu-Inatsugi, R., Hatakeyama, M., et al. (2018) Patterns of polymorphism and selection in the subgenomes of the allopolyploid *Arabidopsis kamchatica*. *Nat. Commun.* 9: 3909.
- Payne, P.I., Holt, L.M. and Lawrence, G.J. (1983) Detection of a novel high molecular weight subunit of glutenin in some Japanese hexaploid wheats. *J. Cereal Sci.* 1: 3–8.
- Payne, P.I. and Lawrence, G.J. (1983) Catalogue of alleles for the complex gene loci, Glu-A1, Glu-B1, and Glu-D1 which code for high-molecular-weight subunits of glutenin in hexaploid wheat. *Cereal Res. Commun.* 11: 29–35.
- Peng, J., Richards, D.E., Hartley, N.M., Murphy, G.P., Devos, K.M., Flintham, J. E., et al. (1999) 'Green revolution' genes encode mutant gibberellin response modulators. *Nature* 400: 256–261.
- Quinlan, A.R. and Hall, I.M. (2010) BEDTools: a flexible suite of utilities for comparing genomic features. *Bioinformatics* 26: 841–842.
- Rawat, N., Pumphrey, M.O., Liu, S., Zhang, X., Tiwari, V.K., Ando, K., et al. (2016) Wheat *Fhb1* encodes a chimeric lectin with agglutinin domains and a pore-forming toxin-like domain conferring resistance to Fusarium head blight. *Nat. Genet.* 48: 1576–1580.
- Rikiishi, K. and Maekawa, M. (2010) Characterization of a novel wheat (*Triticum aestivum* L.) mutant with reduced seed dormancy. *J. Cereal Sci.* 51: 292–298.
- Rogozhin, E., Ryazantsev, D., Smirnov, A. and Zavriev, S. (2018) Primary structure analysis of antifungal peptides from cultivated and wild cereals. *Plants* 7: 74.
- Saisho, D., Ishii, M., Hori, K. and Sato, K. (2011) Natural variation of barley vernalization requirements: Implication of quantitative variation of winter growth habit as an adaptive trait in East Asia. *Plant Cell Physiol.* 52: 775–784.
- Saisho, D. and Purugganan, M.D. (2007) Molecular phylogeography of domesticated barley traces expansion of agriculture in the old world. *Genetics* 177: 1765–1776.
- Sansaloni, C., Franco, J., Santos, B., Percival-Alwyn, L., Singh, S., Petrolci, C., et al. (2020) Diversity analysis of 80,000 wheat accessions reveals consequences and opportunities of selection footprints. *Nat. Commun.* 11: 4572.
- Scarth, R. and Law, C.N. (1983) The location of the photoperiod gene, *Ppd2* and an additional genetic factor for ear-emergence time on chromosome 2B of wheat. *Heredity* 51: 607–619.
- Schindelin, J., Arganda-Carreras, I., Frise, E., Kaynig, V., Longair, M., Pietzsch, T., et al. (2012) Fiji: an open-source platform for biological-image analysis. *Nat. Methods* 9: 676–682.
- Schreiber, M., Stein, N. and Mascher, M. (2018) Genomic approaches for studying crop evolution. *Genome Biol.* 19: 140.
- Schweiger, W., Steiner, B., Vautrin, S., Nussbaumer, T., Siegwart, G., Zamini, M., et al. (2016) Suppressed recombination and unique candidate genes in the divergent haplotype encoding *Fhb1*, a major Fusarium head blight resistance locus in wheat. *Theor. Appl. Genet.* 129: 1607–1623.
- Seki, M., Chono, M., Matsunaka, H., Fujita, M., Oda, S., Kubo, K., et al. (2011) Distribution of photoperiod-insensitive alleles *Ppd-B1a* and *Ppd-D1a* and their effect on heading time in Japanese wheat cultivars. *Breed. Sci.* 61: 405–412.
- Seki, M., Chono, M., Nishimura, T., Sato, M., Yoshimura, Y., Matsunaka, H., et al. (2013) Distribution of photoperiod-insensitive allele *Ppd-A1a* and its effect on heading time in Japanese wheat cultivars. *Breed. Sci.* 63: 309–316.
- Sels, J., Mathys, J., De Coninck, B.M.A., Cammue, B.P.A. and De Bolle, M.F.C. (2008) Plant pathogenesis-related (PR) proteins: a focus on PR peptides. *Plant Physiol. Biochem.* 46: 941–950.
- Seppey, M., Manni, M. and Zdobnov, E.M. (2019) BUSCO: assessing genome assembly and annotation completeness. *Methods Mol. Biol.* 1962: 227–245.
- Sharma, N., Ruelens, P., D'hauw, M., Maggen, T., Dochy, N., Torfs, S., et al. (2017) A flowering locus C homolog is a vernalization-regulated repressor in *Brachypodium* and is cold regulated in wheat. *Plant Physiol.* 173: 1301–1315.
- Shimada, S., Ogawa, T., Kitagawa, S., Suzuki, T., Ikari, C., Shitsukawa, N., et al. (2009) A genetic network of flowering-time genes in wheat leaves, in which an *APETALA1/FRUITFULL*-like gene, *VRN1*, is upstream of *FLOWERING LOCUS T*. *Plant J.* 58: 668–681.
- Shitsukawa, N., Tahira, C., Kassai, K., Hirabayashi, C., Shimizu, T., Takumi, S., et al. (2007) Genetic and epigenetic alteration among three homeologous genes of a class E MADS box gene in hexaploid wheat. *Plant Cell* 19: 1723–1737.
- Stec, B. (2006) Plant thionins—the structural perspective. *Cell. Mol. Life Sci.* 63: 1370–1385.
- Stevens, C.J. and Fuller, D.Q. (2017) The spread of agriculture in eastern Asia. *Lang. Dyn. Change* 7: 152–186.
- Stoneking, M. (2016) *An Introduction to Molecular Anthropology*. Wiley-Blackwell, Hoboken, NJ, USA.
- Su, Z., Bernardo, A., Tian, B., Chen, H., Wang, S., Ma, H., et al. (2019) A deletion mutation in *TaHRC* confers *Fhb1* resistance to Fusarium head blight in wheat. *Nat. Genet.* 51: 1099–1105.
- Takenaka, S., Nitta, M. and Nasuda, S. (2018) Population structure and association analyses of the core collection of hexaploid accessions conserved ex situ in the Japanese gene bank NBRP-Wheat. *Genes Genet. Syst.* 93: 237–254.
- Tang, Z., Yang, Z. and Fu, S. (2014) Oligonucleotides replacing the roles of repetitive sequences pAs1, pSc119.2, pTa-535, pTa71, CCS1, and pAWRC.1 for FISH analysis. *J. Appl. Genetics* 55: 313–318.
- Tanio, M., Kato, K., Ishikawa, N., Tamura, Y., Sato, M., Takagi, H., et al. (2005) Genetic analysis of photoperiod response in wheat and its relation with the earliness of heading in the southwestern part of Japan. *Breed. Sci.* 55: 327–334.
- Taya, S., Araki, H. and Nonaka, S. (1981) Effect of air temperature, sunshine and precipitation on the yield and other agronomic characteristics of wheat cultivar 'Norin 61'. *Nihon Sakumotsu Gakkai Kyushu Shibu Kaiho* 48: 15–18 (in Japanese).
- The International Wheat Genome Sequencing Consortium (IWGSC) (2014) A chromosome-based draft sequence of the hexaploid bread wheat (*Triticum aestivum*) genome. *Science* 345: 6194.
- The International Wheat Genome Sequencing Consortium (IWGSC) (2018) Shifting the limits in wheat research and breeding using a fully annotated reference genome. *Science* 361: eaar7191.
- Tiang, C.L., He, Y. and Pawlowski, W.P. (2012) Chromosome organization and dynamics during interphase, mitosis, and meiosis in plants. *Plant Physiol.* 158: 26–34.

- Turner, A., Beales, J., Faure, S., Dunford, R.P. and Laurie, D.A. (2005) The pseudo-response regulator *Ppd-H1* provides adaptation to photoperiod in barley. *Science* 310: 1031–1034.
- van Heerwaarden, J., Doebley, J., Briggs, W.H., Glaubitz, J.C., Goodman, M.M., Gonzalez, J.D.J.S., et al. (2011) Genetic signals of origin, spread, and introgression in a large sample of maize landraces. *Proc. Natl. Acad. Sci. USA* 108: 1088–1092.
- Vetch, J.M., Stougaard, R.N., Martin, J.M. and Giroux, M.J. (2019) Review: revealing the genetic mechanisms of pre-harvest sprouting in hexaploid wheat (*Triticum aestivum* L.). *Plant Sci* 281: 180–185.
- Walkowiak, S., Gao, L., Monat, C., Haberer, G., Kassa, M. T., Brinton, J., et al. (2020) Multiple wheat genomes reveal global variation in modern breeding. *Nature* 588: 277–283.
- Wan, Y., Yan, Z., Liu, K., Zheng, Y., D'Ovidio, R., Shewry, P.R., et al. (2005) Comparative analysis of the D genome-encoded high-molecular weight subunits of glutenin. *Theor. Appl. Genet.* 111: 1183–1190.
- Wang, W., Mauleon, R., Hu, Z., Chebotarov, D., Tai, S., Wu, Z., et al. (2018) Genomic variation in 3,010 diverse accessions of Asian cultivated rice. *Nature* 557: 43–49.
- Warner, R.L., Kudrna, D.A., Spaeth, S.C. and Jones, S.S. (2000) Dormancy in white-grain mutants of Chinese Spring wheat (*Triticum aestivum* L.). *Seed Sci. Res.* 10: 51–60.
- Welsh, J., Keim, D., Pirasteh, B. and Richards, R.D. (1973) Genetic control of photoperiod response in wheat. In *Proceedings of the 4th International Wheat Genetics Symposium*. pp. 879–884.
- William, M.D.H.M., Peña, R.J. and Mujeeb-Kazi, A. (1993) Seed protein and isozyme variations in *Triticum tauschii* (*Aegilops squarrosa*). *Theoret. Appl. Genetics* 87: 257–263.
- Wood, T.E., Takebayashi, N., Barker, M.S., Mayrose, I., Greenspoon, P.B. and Rieseberg, L.H. (2009) The frequency of polyploid speciation in vascular plants. *Proc. Natl. Acad. Sci. USA* 106: 13875–13879.
- Worland, A.J. (1996) The influence of flowering time genes on environmental adaptability in European wheats. *Euphytica* 89: 49–57.
- Xiao, J., Xu, S., Li, C., Xu, Y., Xing, L., Niu, Y., et al. (2014) O-GlcNAc-mediated interaction between VER2 and TaGRP2 elicits *TaVRN1* mRNA accumulation during vernalization in winter wheat. *Nat. Commun.* 5: 4572.
- Yan, L., Loukoianov, A., Tranquilli, G., Helguera, M., Fahima, T. and Dubcovsky, J. (2003) Positional cloning of the wheat vernalization gene *VRN1*. *Proc. Natl. Acad. Sci. USA* 100: 6263–6268.
- Yan, L., Louloianov, A., Blechl, A., Tranquilli, G., Ramakrishna, W., SanMiguel, P., et al. (2004) The wheat *VRN2* gene is a flowering repressor down-regulated by vernalization. *Science* 303: 1640–1644.
- Yanaka, M., Takata, K., Ishikawa, N. and Takahashi, T. (2016) Effects of the composition of glutenin subunits at *Glu-A1* and *Glu-D1* loci on the protein composition in Japanese soft wheat. *Jpn. J. Crop Sci.* 85: 403–410.
- Yang, F.P., Zhang, X.K., Xia, X.C., Laurie, D.A., Yang, W.X. and He, Z.H. (2009) Distribution of the photoperiod insensitive *Ppd-D1a* allele in Chinese wheat cultivars. *Euphytica* 165: 445–452.
- Zhao, X.Y., Liu, M.S., Li, J.R., Guan, C.M. and Zhang, X.S. (2005) The wheat *TaG11*, involved in ohotoperiodic flowering, encodes an Arabidopsis *Gl* ortholog. *Plant Mol. Biol.* 58: 53–64.
- Zhao, L., Ning, S., Yu, J., Hao, M., Zhang, L., Yuan, Z., et al. (2016) Cytological identification of an *Aegilops variabilis* chromosome carrying stripe rust resistance in wheat. *Breed. Sci.* 66: 522–529.
- Zhao, T., Ni, Z., Dai, Y., Yao, Y., Nie, X. and Sun, Q. (2006) Characterization and expression of 42 MADS-box genes in wheat (*Triticum aestivum* L.). *Mol. Gen. Genomics* 276: 334–350.
- Zhou, Y., Zhao, X., Li, Y., Xu, J., Bi, A., Kang, L., et al. (2020) *Triticum* population sequencing provides insights into wheat adaptation. *Nat. Genet.* 52: 1412–1422.
- Zuckermandl, E. and Pauling, L. (1965) Molecules as documents of evolutionary history. *J. Theor. Biol.* 8: 357–366.