

Performance Analysis of Manet Using ODMR Protocol Through Simulation

Tripti Pandey

M.Tech,

Department of Electronics and Comm

Oriental Institute of Science and Technology

Bhopal, (M.P.) India

Prof. Shashi Bhushan Tiwary

Assistant Professor,

Department of Electronics and Comm

Oriental Institute of Science and Technology

Bhopal, (M.P.)India

Abstract—The fast innovation improvement in the transportation framework is critically required today alongside expanding number of vehicles. Mobile Ad-Hoc Network (MANET) has turned into a dynamic zone of research, institutionalization, and advancement since it can possibly enhance vehicle and street security, movement productivity. Late research endeavors have put a solid accentuation on novel MANET plan structures and executions to enabling technologies that provide a wide variety of services such as vehicle road safety, enhancing traffic efficiency, reducing the level of accident and road congestion. A great deal of MANET examine works have concentrated on particular territories including steering, broadcasting, Quality of service (QoS). In this paper, demonstrate how MANET could be simulated on MATLAB software using different protocol and parameters, and then measure the simulation performance namely time, no of source, destination, protocol, data length or data join request, hops or switch and packet drop between vehicles. Full reach ability between vehicles has been performed between the Vehicle to vehicle and vehicle to Infrastructure or V to RSU.

Keywords- MANET, Protocols, MATLAB, Routing, V2V, V2I.

I. INTRODUCTION

Correspondence Currently, the increasing number of vehicles has caused some problems. One of them is a traffic jam and often accidents occurred, so these problems lead to a need of a technological system that can help us reducing those negative effects. Intelligent Transportation System (ITS), one of promising answers, is a combination of intelligent transportation system with information technology to improve accessibility, efficiency and security of transportation. ITS technology could provide real-time information to road users related to the road situation such as when there are traffic accidents or congestions occurred on a particular road area. The presence of this technology could give solutions or alternatives for road users can avoid the traffic jam. ITS also can support information about the condition of existing vehicles for the vicinity, so it can help users to avoid the accident. One of ITS technologies that is still in development is Mobile Ad-Hoc Network (MANET) [1].

MANET currently still has some obstacles to its development that requires much cost for development and testing. So far there is still no country that has really applied the MANET system commercially. On the other hand, the development and research about MANET is still ongoing although MANET network modeling has been done in the form of simulation [1]. The frequent exchange of routing vectors or link state tables, triggered by continuous topology changes, yields excessive channel and processing overhead. Limited bandwidth, constrained power, and mobility of network hosts make the multicast protocol design particularly challenging. To overcome these limitations, we have developed the on-Demand Multicast Routing Protocol (ODMRP). ODMRP applies *on-demand* routing techniques to avoid channel overhead and improve scalability. It uses the concept of *forwarding group* [5], a set of nodes responsible for

forwarding multicast data on shortest paths between any member pairs, to build a forwarding *mesh* for each multicast group.

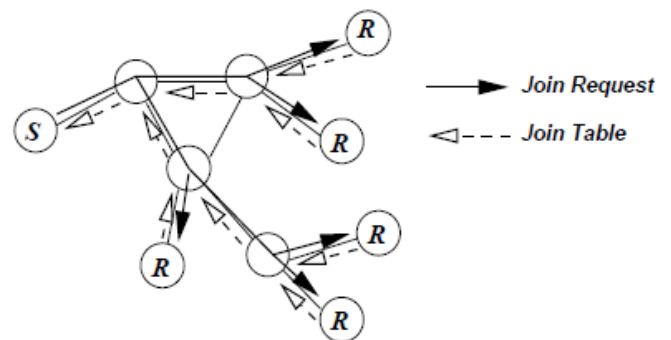

Fig.1: On-Demand Procedure for Membership Setup and Maintenance.

II. LITERATURE REVIEW

The MANET research has been conducted by some. In [1] Ramon *et al.* presents from theory to experimental evaluation: resource management in Software -Define Mobile Networks, they have done experiments on MATLAB open Flow enable new degrees for the management of wireless and wired resources in dynamic Mobile environment. In [4], Amrit *et al.* presents simulation of Mobile movement in MANET. This simulation explains all functions as both directions and also conducts testing for MANET applications and protocols. In [5] Hannes *et al.* presents a tutorial survey on MANET, a testing in directed and wireless multi-hop feasibility of V2V and V2I communications based on wireless local area. In [6] Ian *et al.* proposes a Software Define MANET: architecture and services, this paper describes some of the different operational and service modes that can be provided for MANET technology.

This section will explain and describe the evolutionary background of MANET as well as information about the MATLAB to support MANET implementation.

A. MANET Overview

MANET has two ways communication namely Vehicles to Vehicle (V2V) with Ad-Hoc type and Vehicle to Infrastructure (V2I) with each unit of Road Site Unit (RSU) and mobile network (e.g 4G / LTE). These communication types are explained in figure 1.

MANET is a high speed data communications technology for a vehicle. This technology is wireless based and has several protocols for data communication namely unicast, multicast, geocast, mobicast and broadcast protocol. Connectivity in MANET uses IEEE 802.11 on 5.9 GHz wave. MANET's traditional services include vehicle and road safety services, traffic efficiency, management services and infotainment services. Traffic efficiency and management services are aimed to improve traffic flow and traffic coordination and to provide local information and maps. In terms of infotainment service, MANET is expected to support information such as multimedia data transfer and global internet access. [6]

B. MATLAB for MANET

Networking devices have multiple controls and data flow operations in the same device. One of the controls is network management plane. This plane is used to configure each network node separately. The static nature of the current network does not allow full control configuration plane. The main concept of MATLAB is to offer control management for users to manage hardware forwarding of each network element.

The easiest thing MATLAB could support for MANET is by making RSU MATLAB-enabled for example using a controller like in Open Flow switches. In addition, the scope of the controller could be extended to protocol that could act as end users and could be abstracted as elements included in data such as RSU and other infrastructure nodes. Therefore, the protocol could be triggered by the controller for its performance such as the deployment of multi-hop V2V data. [7]

III. SIMULATION SCENARIO

In this study, a simulator that is used for simulation is MATLAB and SIMULINK. This simulator is installed on windows 10 which run on virtual machine. For writing the script we use .m file in MATLAB and also to show the visualization [8].

There are two measurement scenarios in this research. The first one is measurement of throughput, drop and delay of communication in one RSU, and the second one is measurement of throughput, packet drop and delay of communication between two different RSUs. In MATLAB we design the MANET topology with 2 RSUs and 5-500 vehicles (cars).

ALGORITHM

Step-1 reading configuration, runtime variables total packets generated in the simulation

Step-2 TODO: add topology builder and agent role for Nodes PHY used, MAC protocol, Agents, Applications used in this simulation

Step-3 initial nodes, start discrete simulation, update topology matrix, and update plot graph and edges, move node

Step-4 First we connect listener of the neighbor nodes based on topology, now, process output queue for new packets plot sender related info once

Step-5 Neighbor protocol info, show how many 1-hop neighbors and clusters we have, ODMRP protocol info, show FORWARDING_FLAG and number of entries in Member table, custom proto1 info on the topology graph

Step-6 loop thru neighbors, delete connected listener and plot link, packet has been sent

IV. RESULT AND ANALYSIS

In this simulation, several simulation scenarios are done with using 5-500 units of vehicles (cars) and 2 nodes of RSU. Each scenario will measure performance parameters namely delay, throughput, and packet drop. There are 2 scenarios to be evaluated, first is V2V communication and second is V2I communication with two RSUs.

A. Performance Evaluation V2V

After the MANET topology has been designed, then perform some testing to see whether the V2V connection is already reachable each other. In this case, the vehicle is defined as 'car'. The first simulation is to evaluate V2V communication.

2.1 Inter-vehicle communication:

In inter-vehicle communication, vehicles need only be concerned with activity on the road ahead and not behind.

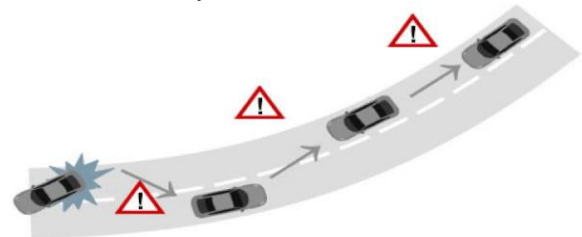
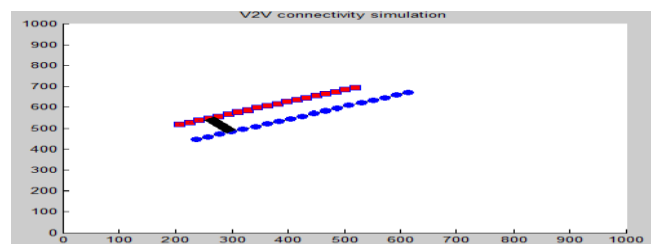

Fig.2: Inter-vehicle communication



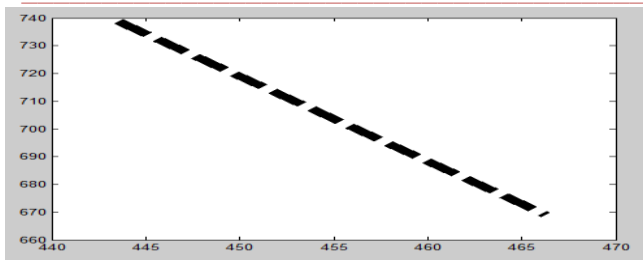

Fig.3: Simulation of V2V

B. Performance Evaluation V2I Communication with two RSU

In the second simulation, two car is expected to be reachable each other in the different RSU coverage. Here V2I or V2 RSU communication which has 2 RSU is designed and they communicate with the entire node (cars). Vehicle-to-roadside communication configuration provides a high bandwidth link between vehicles and roadside units. The roadside units may be placed every kilometer or less, enabling high data rates to be maintained in heavy traffic.

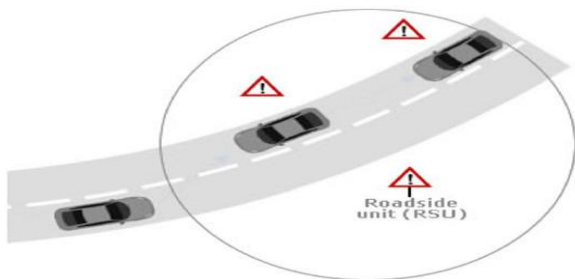

Fig.4: Vehicle-to-roadside communication

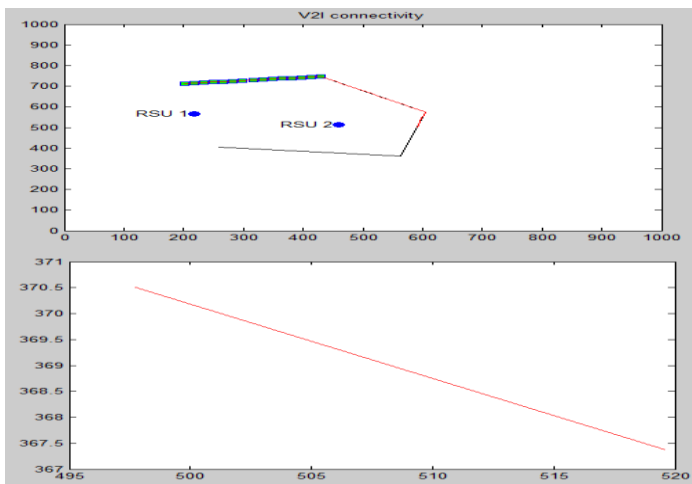
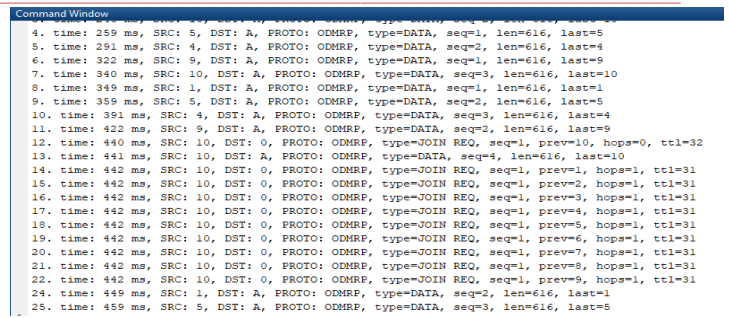
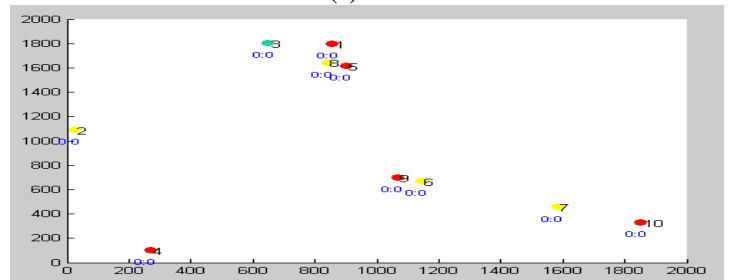

Fig.5: Simulation of V2I



(a)



(b)

Fig.6: (a) Simulation parameters (b) initializing simulation

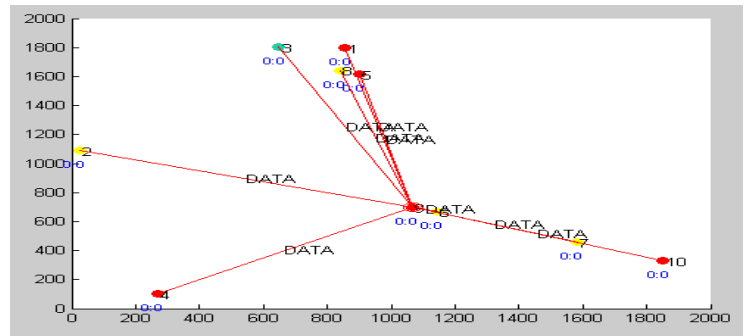

(a)

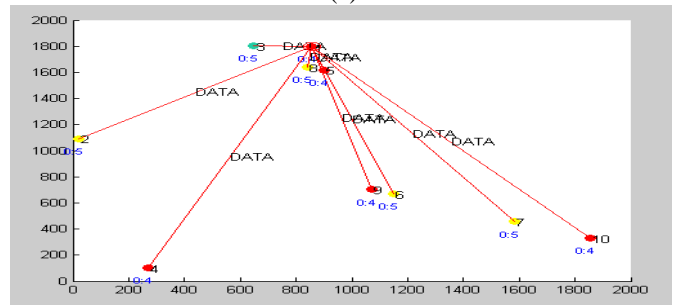

(b)

Fig.7: (a)&(b) Simulation of MANET using ODRP

Table-I: Simulation parameters

Software	MATLAB 8.3.0.532 (R2014a)
System Environment	Windows 10
Time	100 ms to 1000 ms
Destination	1-10
Source	1-10
Protocol	ODMRP
Length	600-700

Table-II: Comparison of Different Protocol

AUTHOR	PROTOCOL	PERFORMANCE
Hafez Seliem	Mac & Vdnet	60 S
Jos E Grimaldo	AODV, OLSR, DSR, And DSDV	1 S To 300 S
Forough Goudarzi	Routing Protocol	800 S
<i>Bhuvanewari Madasamy</i>	MGOR	100s
Guiyang Luo	Sdnmac	300s

[9] Slamet Indriyanto, Muhammad Najib Dwi “Performance Analysis of MANET Simulation on Software Defined Network” IEEE 2017

V. CONCLUSION

An experiment of MANET simulation in a MATLAB has been done and the performance parameters have been evaluated such as throughput, delay and packet drop. Two simulation scenarios have been simulated with using 5-500 units of cars and 2 RSU. First scenario is V2V communication and second is V2I communication with two RSU coverage. V2V communication could be successfully performed with the full reach ability result while the V2I communication with two different RSU has been established well. Experimental results show that how MANET simulated on MATLAB software using different protocol and parameters, and measured the simulation performance namely time, no of source, destination, protocol, data length or data join request, hops or switch and packet drop between vehicles. Full reach ability between vehicles has been performed between the Vehicle to vehicle and vehicle to Infrastructure or V to RSU. For future works, the V2V ad-hoc communication protocols and V2I can be practical implemented. So that the performance analysis results will be more reliable.

REFERENCES

- [1] Ramon Fontes, Claudia Campolo, Christian Rothenberg, “From Theory to Experimental Evaluation: Resource Management in Software-Define Mobile Networks”, Digital Object Identifier 10.1109/ACCESS., January 2017.
- [2] Ramon Fontes, “Mininet-Wifi”, [Online]. Available: <https://github.com/intrig-unicamp/mininet-wifi>
- [3] Ramon R. Fontes, Samira Afzal, Samuel H. B. Brito, Mateus A. S. Santos, Christian Esteve Rothenberg, “Mininet-WiFi: Emulating Software-Defined Wireless Networks.”, IFIP, 2015.
- [4] Amrit Ekka, “Simulation of Mobile Movement in MANET”, National Institute of Technology Rourkela, June 2013.
- [5] Hannes Hartenstein, Kenneth P. Laberteaux, “A Tutorial Survey on Mobile Ad Hoc Networks”, IEEE Communications Magazine, June 2008.
- [6] Ian Ku, You Lu, Mario Gerla, *et.al.*, “Towards Software-Defined MANET: Architecture and Service”, Annual Mediterranean Ad Hoc networking workshop (MED-HOC-NET), IEEE, 2014.
- [7] G. Abdalla, S. Senouci “Current Trends in Mobile Ad Hoc Networks”, Proceedings of UBIROADS workshop, 2007.
- [8] M. Sivasakthi and S. Suresh, “Research on Mobile ad hoc networks (MANETs): an overview,” Journal of Applied Sciences and Engineering Research, vol. 2, no. 1, pp. 23–27, 2013.