

## Study of Z-source Inverter using Different Control Techniques

Nikhil J Bodele  
M.Tech(power electronics and drives)  
Asst. Prof. at Jhulelal Institute of Technology

Ashutosh Rajurkar  
Assistant Electrical Engineer,  
Mahatransco

**Abstract**— This paper represents study of Z-Source Inverter using different controlling techniques like simple boost control, maximum boost control, maximum constant boost control and space vector control. All the techniques were implemented in MATLAB/SIMULINK, also relation with voltage gain versus modulation index and voltage stress versus voltage gain were analyzed in detail and verified. It was observed that gain of Z-source inverter can be varied by varying its parameters like modulation index and shoot-through duty ratio. The comparison shows that even though simple boost control technique was having higher boost factor, Maximum constant boost control technique is most suitable in PWM technique.

**Keywords**— Z-Source Inverter, Modulation Index, Boost Factor, Space Vector.

\*\*\*\*\*

### I. INTRODUCTION

In the conventional dc to ac converter, there are some limitations. In most of their application they are used as either buck or boost their output voltage but not both. In traditional method, different pulse width (PWM) control methods are used for three phase voltage source inverter. There are six active vectors for V-source inverter. When the dc voltage is applied across the load, two extra zero states will appear because of short circuiting of lower and upper three devices. Also both the upper and lower devices of V-source cannot be switched together, that will destroy the power device. So dead time is needed for power devices for protection purpose and this will introduce harmonics distortion at the output.

Different combinations like ac-dc, dc-ac, dc-dc, ac-ac can be achieved using Z-Source inverter. It provides a special feature that utilizes the shoot through zero state by gating on both upper and lower switches of a phase leg. Output voltage can be greater than available input dc voltage. So reliability of the inverter is improved. Latest application of ZSI is hybrid vehicle [3]. Also used in solar application system.

### II. THE CONVENTIONAL Z-SOURCE INVERTER

Z-source inverter is combination of two inductor ( $L_1, L_2$ ) and two capacitor ( $C_1, C_2$ ) connected in X shape. The specialty of Z-source inverter is that its output can vary between zero to infinity i.e. it is buck-boost inverter which is having vary wide range of output. Unlike traditional VSI that has eight switching states, the ZSI Bridge has nine permissible switching states.

1. Six active vectors same as VSI when the dc voltage is connected across load.
2. Two zero vectors when the load terminals are shorted through either the upper devices or lower devices.
3. One extra zero state is possible when upper and lower device is shorted with one leg or two legs or all legs.

This extra zero state is called as the shoot-through zero state. It can be produced in seven different ways.

Output of traditional Z-source inverter can be varied by using two parameters that is shoot-through duty ratio and modulation index [4]. By varying shoot-through duty ratio we can vary voltage boost factor of the ZSI and ac output voltage can be varied by using modulation index. During operation, there is compromise between modulation index and shoot-through duty ratio. If modulation index is large, shoot-through duty ration should be small and vice versa. Strong boost factor can be provided using large shoot-through duty ratio and that will increase the inverter bridge voltage from a very few low voltage. So large shoot through-duty ratio and small modulation index is used. This condition will reduces amplitude of ac output voltage and voltage stress will increase on capacitors and other devices [6]. So there are limitations when using boost factor (B) and modulation index (M). So to overcome this drawback, different control techniques are analyzed to increase the voltage boost factor [5].

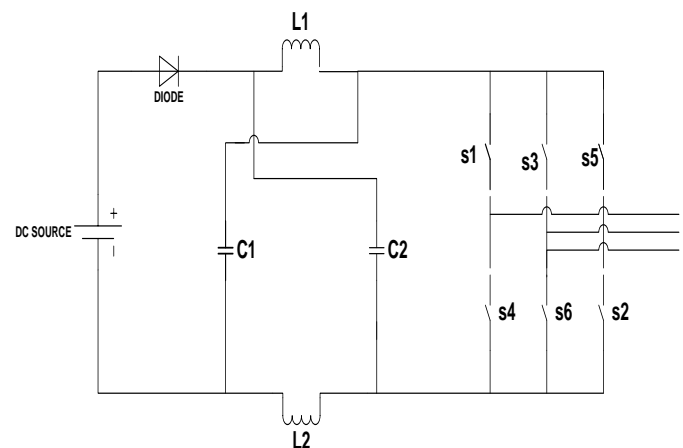

Fig. 1. Z-Source Inverter

### III. PWM CONTROLLING METHODS

#### A. Simple boost Controlling Technique

It is the most common method used for firing ZSI. [10] In this method sinusoidal pulse width modulation technique (SPWM) is used. Three phase balanced sinusoidal signal is compared with triangular carrier signals to obtain the gate pulses. There is one drawback of Sine PWM technique is that it cannot boost the output voltage because of two null sets in addition with six active states in one cycle of operation. So one adjustment is done, shoot-through state has introduced in null state by various techniques to boost the output voltage. This shoot-through is not useful to VSI.

In ZSI, zero state is produced when sinusoidal signals are less than or greater than triangular carrier signal. To include shoot-through state in that zero state we used two dc signals  $V_p$  and  $V_n$ . Whose amplitude is equal to the amplitude of sinusoidal waveform.  $V_p$  is positive peak of waveform and  $V_n$  is negative peak of waveform. These two signals are compared to carrier signals. When the triangular signals are greater than  $V_p$  or less than  $V_n$ , shoot-through state will occur. Maintaining shoot-through time per switching cycle as constant, shoot-through will appear in every phase, so shoot-through duty ratio and modulation index are independent of each other. This control technique is not that much efficient because of voltage stress across the switches is high due to improper use of traditional zero state.

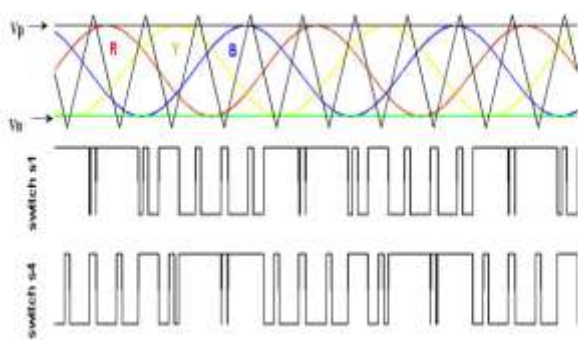

Fig. 2. Gate pulses of Simple Boost Controlling Technique

So the Voltage Gain of Z-source inverter can be calculated as below:

$$\frac{V_{ac}}{V_0/2} = M.B \quad (1)$$

$V_{ac}$  = Peak output phase voltage

$V_0$  = DC input voltage

M = Modulation Index

B = Boost factor

This is determined by as follow:

$$B = \frac{1}{1 - 2 \frac{T_0}{T}} \quad (2)$$

$T_0$  = Shoot-Through time

T = Total time Interval

D = Shoot through Duty ratio.

Voltage gain G as:

$$G = M.B = \frac{V_{ac}}{V_{in}/2} = \frac{M}{2M - 1} \quad (3)$$

Modulation Index can be calculated using Voltage Gain as below:

$$M = \frac{G}{2G - 1} \quad (4)$$

The voltage across the switches is  $B.V_0$ . The voltage stress under this can be calculated by following equation:

$$V_s = B.V_{in} = (2G - 1)V_0 \quad (5)$$

Voltage stress across switches is much high as shown in fig.7. So this method cannot be used for higher output voltage. The voltage gain increases, voltage stress also increases. Hence another suitable method is used to obtain higher gain in ZSI.

#### B. Maximum boost controlling Technique

The main purpose of this control method is to get highest boost factor by maintaining duty cycle of shoot-through state in constant level. [11] In Maximum boost control method the six active states remain unchanged while all traditional zero state converted in shoot-through state. For that we use envelope of three sinusoidal signals as  $V_p$  and  $V_n$ . Maximum envelope is known as  $V_p$  and minimum envelope as  $V_n$ . Triangular signal is used as carrier signal, so whenever the  $V_p$  is lower than triangular or the  $V_n$  is higher than the triangular, inverter will goes in shoot-through state otherwise it will act like traditional PWM mode [1]. If shoot-through duty ratio increases, the gain of inverter will increase i.e. boost factor of inverter will increase without changing modulation index. The shoot through state repeats periodically every  $\pi/3$ . The shoot-through duty ratio over one switching cycle in the interval  $(\pi/6, \pi/2)$  can be expressed as

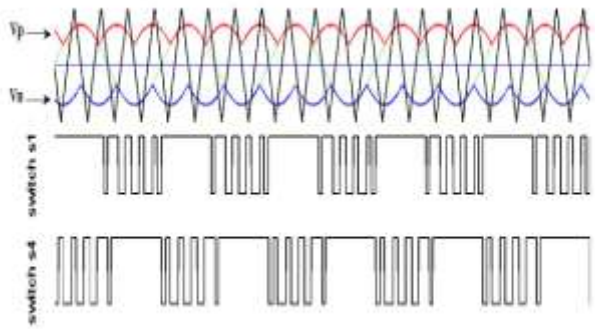

Fig. 3. Gate pulses of Maximum Boost Controlling Technique

$$\frac{T_0(\theta)}{T} = \frac{2 - (M\sin\theta - M\sin(\theta - \frac{2\pi}{3}))}{2} \quad (6)$$

The average duty ratio of shoot-through is given below:

$$\frac{T_0(\theta)}{T} = \frac{\int_0^{\frac{\pi}{6}} \frac{2 - (M\sin\theta - M\sin(\theta - \frac{2\pi}{3}))}{2} d\theta}{\frac{\pi}{6}} = \frac{2\pi - 3\sqrt{3}M}{2\pi} \quad (7)$$

The boost factor B is obtained as below:

$$B = \frac{1}{1 - 2\frac{T_0}{T}} = \frac{\pi}{3\sqrt{3}M - \pi} \quad (8)$$

The maximum modulation index that can be used for a given voltage gain G is followed by:

$$M = \frac{\pi G}{3\sqrt{3}G - \pi} \quad (9)$$

Thus, the voltage stress is calculated as below:

$$V_S = B \cdot V_{in} = \frac{\pi V_{in}}{3\sqrt{3}G - \pi} = \frac{3\sqrt{3}G - \pi}{\pi} V_{in} \quad (10)$$

Compared with the simple control method, the voltage stress is much lower as shown in fig.7. This means that for given devices, this technique can be used for higher gain in case of inverter.

### C. Maximum Constant boost controlling Technique

To reduce the volume of the set up and cost we use maximum constant boost control [12]. It is very important to keep the shoot-through duty ratio constant because constant duty ratio will eliminate the low frequency current ripple. At the same time with high boost factor for any modulation index is desired to reduce the voltage stress across the switches. To

maintain constant boost factor shoot-through time has to be kept constant from respective cycles [2]. For this control method we used third harmonic component amplitude of 1/6 of its fundamental component is added to the three phase sinusoidal reference signals. One of the reference peak amplitude at  $(\sqrt{3}/2)M$  while other one reference signal at its minimum value  $-(\sqrt{3}/2)M$  at  $\pi/3$ . So only two dc lines are required to control the shoot through time with harmonic injection i.e.  $V_p$  and  $V_n$ . The Voltage Gain can be increased by Varying M from  $\sqrt{3}/3$  to  $\sqrt{2}/3$  with shoot-through states and then decreasing M from  $\sqrt{2}/3$  to zero without shoot-through states.

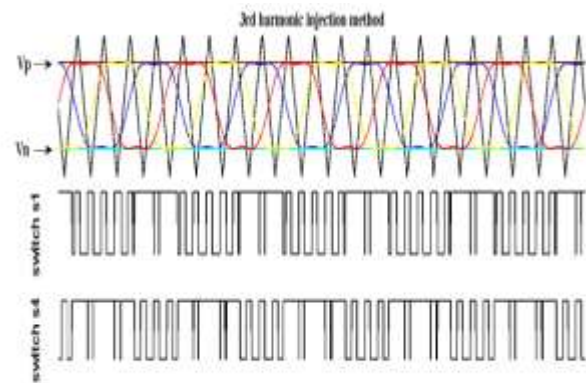

Fig. 4. Gate pulses of Maximum Constant Boost Controlling Technique

Voltage gain G is

$$G = M \cdot B = \frac{M}{\sqrt{3}M - 1} \quad (11)$$

$$M = \frac{G}{\sqrt{3}G - 1} \quad (12)$$

The voltage across the switches is  $V_s$ , can be expressed as below:

$$V_S = B \cdot V_{in} = (\sqrt{3}G - 1)V_{in} \quad (13)$$

The voltage gain almost remains same as the maximum boost control. So the voltage stress was also same fig.7. The advantage of this method is that use of greater range of modulation index.

### D. Modified SVPWM for Z-source inverter

Up to this, maximum boost control method has higher voltage gain as it uses all the possible traditional state to maintain shoot-through state. The disadvantage of that method is, shoot-through time interval becomes variable which causes low frequency ripple component in capacitor voltage and inductor current. So we introduced maximum constant boost control method [8], it controls the upper as well as lower shoot through envelopes to keep the constant duty ratio and higher boost factor. Switching frequency required for this method is

very high and it will create extra switching losses. So for low harmonics and large voltage utilization traditional SVM concept used for ZSI [7]. Two devices from the same leg are no longer complementary to each other like traditional SVM does. Shoot-through states are added at the beginning and end of the switching cycle to avoid switching losses. So one of them is described here is ZSVM6 i.e. total shoot through time is divided in to six parts evenly.

The ZSI contains six active, two zero and single shoot-through state vector. The total switching period is  $T_s$  which defined as:

$$T_s = T_0 + T_1 + T_2 + T_{sh} \quad (14)$$

$T_{sh}$  is shoot-through time period.  $T_{sh}$  is divided in to six equal parts so one shoot-through time becomes  $T_{sh}/6$ . To achieve sinusoidal three phase output voltage in traditional VSI voltage vector amplitude is limited within  $V_{in} / \sqrt{3}$ . In ZSI with combination of shoot-through time with SVM, output is limited within  $B.V_{in} / \sqrt{3}$ .

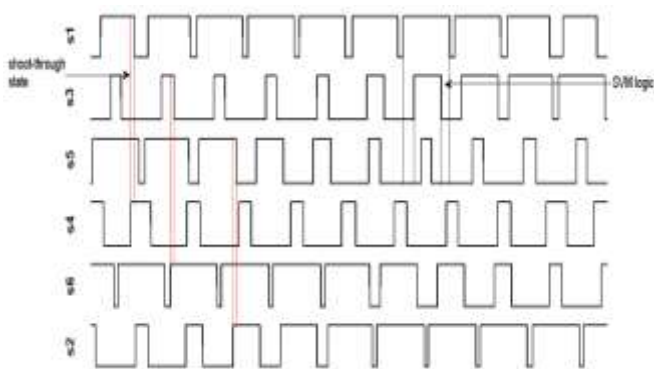

Fig. 5. Gate pulses of Space Vector Control Technique

$$V_C = \frac{T_s - T_{sh}}{T_s - 2T_{sh}} V_{in} \quad (15)$$

$$D = 1 - \frac{3\sqrt{3}}{2\pi} M \quad (16)$$

$$V_s = \frac{T_s}{T_s - 2T_{sh}} V_{in} = B.V_{in} \quad (17)$$

$$B = \frac{T_s}{T_s - 2T_{sh}} = \frac{\pi}{3\sqrt{3}M - \pi} \quad (18)$$

$$G = \frac{\pi M}{3\sqrt{3}M - \pi} \quad (19)$$

$$V_{ac} = B.M \cdot \frac{V_{in}}{2} \quad (20)$$

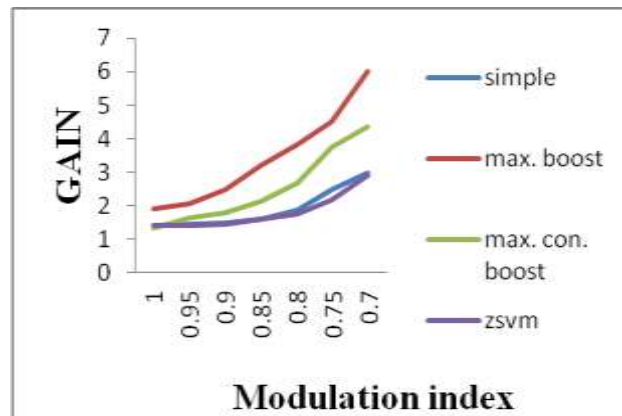

Fig. 6. Voltage Gain versus Modulation Index

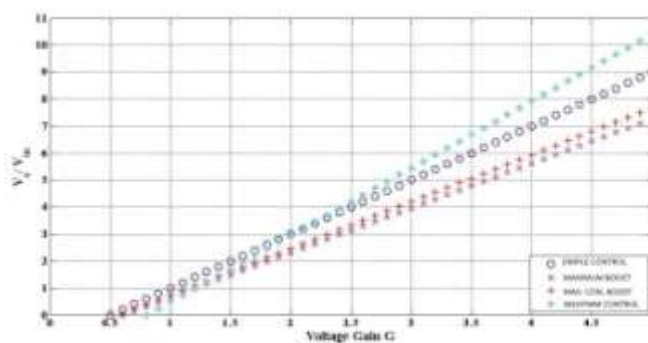

Fig. 7. Voltage Stress versus Voltage Gain [13]

From fig.6. We can conclude that by varying modulation index we can vary voltage gain of inverter. As the gain increases stress across the switch increases results in to switching losses.

#### IV. RESULTS

Simple boost, Maximum Boost, Maximum constant boost and Space vector control techniques were implemented in MATLAB/SIMULINK file. The main aim of this paper is to show that DC link voltage can be boosted by varying modulation index and at low shoot-through ZSI. Simulations were recorded at  $V_{in} = 24V$ ,  $L_1$  &  $L_2 = 1mH$ ,  $C_1$  &  $C_2 = 470\mu F$ , switching frequency  $f_s = 3KHz$ , output frequency  $f = 50Hz$  in the case of ZSI.

In simulation, all the techniques are verified by varying its modulation index from 1 to 0.7 with constant duty ratio. The variation between gain and modulation index is recorded (fig.6). Simple boost control technique boost factor is much higher than any other at different values of modulation index but due to low frequency harmonics its THD also higher than any other technique fig.9. In the table.1. All the techniques are verified for  $V_{in} = 24$ ,  $M = 0.8$ . Boost factor is higher for simple boost but its AC output is less due to low harmonics distortion. Maximum boost control technique has higher AC output than any other technique. THD for both line current and voltage is

less for maximum constant boost control technique and its AC output also average comparatively to others.

Table.1. comparison between different control methods

CONTROL METHOD	SIMPLE	MAX. BOOST	MAX. CONST. BOOST	SVPWM
$V_{LL(rms)}$ V	21.43	55.45	39.06	30.26
THD $V_{LL}\%$	98.13	98.22	88.80	97.66
$I_{l(rms)}$ A	1.326	3.613	2.64	4.7
THD $I_l\%$	4.58	3.75	2.79	3.42

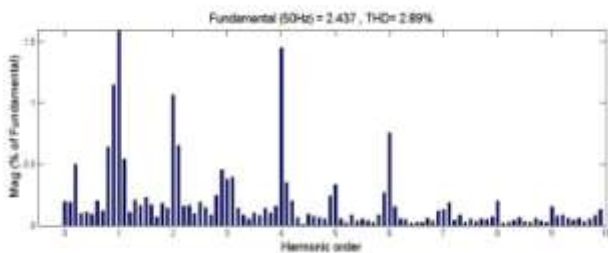

Fig. 9. THD analysis of line current MI= 0.8, of ZSI with Simple boost control technique

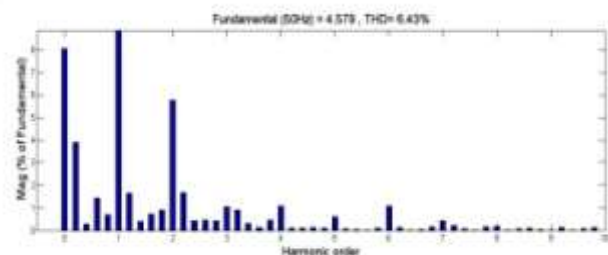

Fig. 10. THD analysis of line current MI= 0.8, of ZSI with Maximum boost control technique

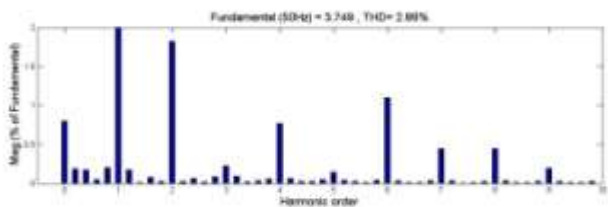

Fig. 11. THD analysis of line current MI= 0.8, of ZSI with Maximum constant boost control

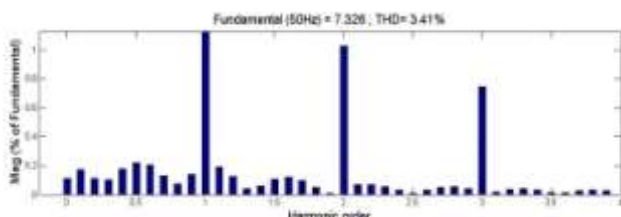

Fig. 12. THD analysis of line current MI= 0.8, of ZSI with Modified space vector PWM control

For hardware implementation, at  $V_{in}= 12V$ ,  $L_1\&L_2 = 1mH$ ,  $C_1\&C_2=470\mu F$ , switching frequency  $f_s=3KHz$ , output frequency  $f = 50Hz$ .

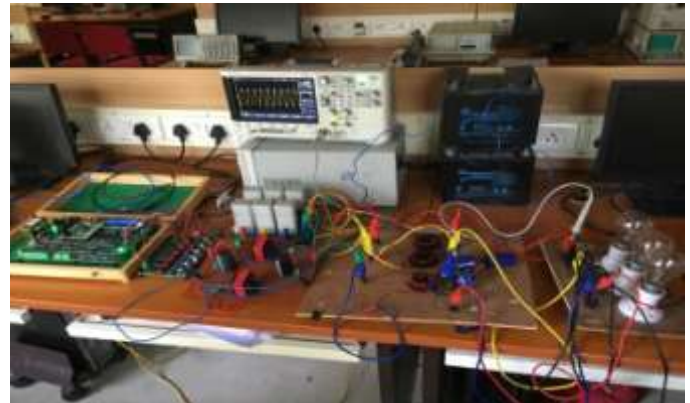

Fig. 13. Hardware implementation Z-Source Inverter

We have implemented two technology, simple boost control and space vector control MSVPWM6.

Table.2. comparison between hardware results

Modulation index (MI)	Simple boost control		Space vector control	
	Vdc o/p	$V_{LLrms}$	Vdc o/p	$V_{LLrms}$
1	11.5	7.5	10.4	7.68
0.95	18.7	12.8	12.4	8.66
0.9	27.3	17.5	21.9	16.38
0.85	34.9	26.9	25.2	21

Here in fig.14. and fig.15. shows the output of Z-source inverter for Space vector control and simple boost control respectively. We can observe that for 12V DC input voltage, the line voltage of inverter are  $21V_{rms}$  and  $26.9V_{rms}$ .

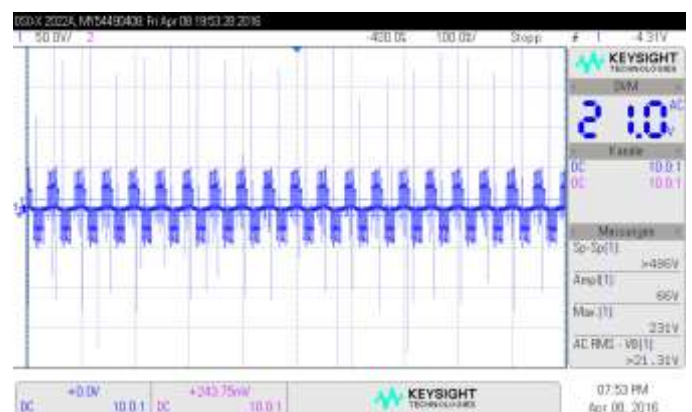

Fig.14. Line Voltage MI= 0.85 ZSI with Space vector control

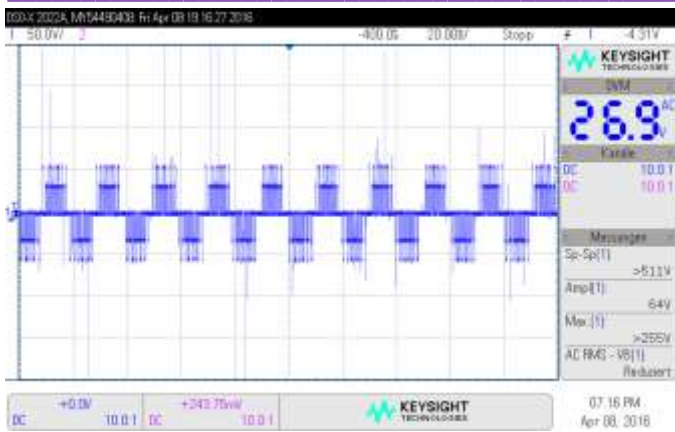

Fig.14. Line Voltage MI= 0.85of ZSI with Simple boost control

## V. CONCLUSION

In this paper, we simulated all the four control technique and implemented in hardware two of them that are used to control Z -source inverter. The Simple boost control method and space vector control with the simulation results and hardware results are shown. By all the simulation diagrams and tables it is shown that by varying modulation index we can increase the gain of inverter, the relation between Modulation index and duty ratio was observed. Relation with voltage gain versus modulation index and voltage stress versus voltage gain were observed and verified. By using proper method, passive component requirement can be minimized. Maximum constant boost and space vector control are very suitable for minimizing the Z-source network as the low frequency harmonics eliminated.

## REFERENCES

- [1] F. Z. Peng, M. Shen, and Z. Qian, "Maximum Boost Control of the ZSource Inverter," IEEE Trans. Power Electron., vol. 20, no. 4, pp. 833- 838, Jul 2005.
- [2] Miaosen Shen, Jin Wang, Joseph, A., Fang Zheng Peng, Tolbert, L.M., Adams, D., "Constant boost control of the Z-source inverter to minimize current ripple and voltage stress, " IEEE Transactions on Industry Applications, Vol. 42, no. 3, pp. 770-778.
- [3] Miaosen Shen and Fang Zheng Peng, "Converter Systems for Hybrid Electric Vehicles", Michigan State University Electrical Machines and Systems 2007, Oct. 8~11, Seoul, Korea.
- [4] F. Z. Peng, " Z-source inverter, " IEEE Transactions on Industry Applications, Vol. 39, no. 2, pp. 504-510.
- [5] Byamakesh Nayak, "Performance Analysis of Different Control Strategies in a Z-source Inverter," *School of Electrical Engineering KIIT University, Bhubaneswar Orissa, India* press.
- [6] Quoc-Nam Trinh, Hong-Hee Lee, and Tae-Won Chun, "A New Z-Source Inverter Topology to Improve Voltage Boost Ability." *8th International Conference on Power Electronics - ECCE Asia*

- [7] U.Shajith Ali, "A Novel Space Vector PWM for Z-Source Inverter, " *EEE Department SSN College of Engineering Chennai, India*
- [8] Jih-Sheng Lai, " AC Output Voltage Control with Minimization of Voltage Stress Across Devices in the Z-Source Inverter Using Modified SVPWM, " *Virginia Polytechnic Institute and State University, Whittemore Hall, Blacksburg, VA 24061-0111, USA*
- [9] Xinping Ding, Zhaoming Qian, Shuitao Yang, Bin Cuil, Fang zheng Peng: A High-Performance Z-Source Inverter Operating with Small Inductor at Wide-Range Load, *Twenty Second Annual IEEE Applied Power Electronics Conference, APEC 2007, pp. 615-620*
- [10] Miaosen Shen: Z-source inverter design, analysis, and its application in fuel cell vehicles, *PhD thesis, Michigan State University, 2006*
- [11] F. Z. Peng, M. Shen, and Z. Qian: Maximum boost control of the Z-source inverter, *IEEE Transactions on Power Electronic, vol. 20, no. 4, pp. 833-838*
- [12] Miaosen Shen, Jin Wang, Joseph, A., Fang Zheng Peng, Tolbert, L.M., Adams, D.J.:Constant boost control of the Z-source inverter to minimize current ripple and voltage stress, *IEEE Transactions on Industry Applications, Vol. 42, no. 3, pp. 770-778*
- [13] Omar Ellabban, Joeri Van Mierlo, and Philippe Lataire, " Comparison between different PWM control methods for different Z-Source Inverter Topology", *Power Electronics and Applications, 2009. EPE '09, no.7, 2009, pp.1-11, Barcelona.*