



GLOBAL JOURNAL OF COMPUTER SCIENCE AND TECHNOLOGY
Volume 11 Issue 20 Version 1.0 December 2011
Type: Double Blind Peer Reviewed International Research Journal
Publisher: Global Journals Inc. (USA)
Online ISSN: 0975-4172 & Print ISSN: 0975-4350

A Handoff using Guard Channels Scheme (HGCS) for Cognitive Radio Networks

By Madeeha Aman, Dr. Saeed Mahfooz, and Waheed Ur Rehman

University of Peshawar, Khyber Pakhtunkhwa, Pakistan

Abstract - Spectrum handoff is a very important phenomenon in Cognitive Radio (CR) networks. It provides flawless transmission upon the arrival of primary user (PU) while the channel is in use by the secondary user (SU). Spectrum handoff process provides the SUs with the opportunity to continue their communication on other unoccupied channels as soon as the PU repossesses its channel. FCC (Federal Communications Commission) has released new White Space rules in September 2010 which eliminate the requirement of spectrum sensing, making CRs more flexible. In addition, the CR is to be equipped with TV channel database. Taking these new rules into account, this paper suggests a new handoff scheme, HGCS (Handoff using Guard Channels Scheme), which makes effective use of the guard channels for communication. A preemptive resume priority (PRP) M/G/1 queuing network model is proposed to assess total service time for the suggested HGCS and comparing it to the existing random proactive-decision handoff scheme. Simulation and numerical results verify that HGCS can minimize the handoff delay, hence reduces the total service time compared to the random proactive approach.

Keywords : *Spectrum Handoff, Handoff Delay, Handoff using guard channels, Cognitive Radio.*

GJCST Classification : *C.2.1*



A HANDOFF USING GUARD CHANNELS SCHEME HGCS FOR COGNITIVE RADIO NETWORKS

Strictly as per the compliance and regulations of:



© 2011 . Madeeha Aman, Dr. Saeed Mahfooz, and Waheed Ur Rehman. This is a research/review paper, distributed under the terms of the Creative Commons Attribution-Noncommercial 3.0 Unported License <http://creativecommons.org/licenses/by-nc/3.0/>), permitting all non-commercial use, distribution, and reproduction in any medium, provided the original work is properly cited.

A Handoff using Guard Channels Scheme (HGCS) for Cognitive Radio Networks

Madeeha Aman^α, Dr. Saeed Mahfooz^Ω, and Waheed Ur Rehman^β

Abstract - Spectrum handoff is a very important phenomenon in Cognitive Radio (CR) networks. It provides flawless transmission upon the arrival of primary user (PU) while the channel is in use by the secondary user (SU). Spectrum handoff process provides the SUs with the opportunity to continue their communication on other unoccupied channels as soon as the PU repossesses its channel. FCC (Federal Communications Commission) has released new White Space rules in September 2010 which eliminate the requirement of spectrum sensing, making CRs more flexible. In addition, the CR is to be equipped with TV channel database. Taking these new rules into account, this paper suggests a new handoff scheme, HGCS (Handoff using Guard Channels Scheme), which makes effective use of the guard channels for communication. A preemptive resume priority (PRP) M/G/1 queuing network model is proposed to assess total service time for the suggested HGCS and comparing it to the existing random proactive-decision handoff scheme. Simulation and numerical results verify that HGCS can minimize the handoff delay, hence reduces the total service time compared to the random proactive approach.

Keywords : Spectrum Handoff, Handoff Delay, Handoff using guard channels, Cognitive Radio.

1. INTRODUCTION

The concept of software defined radio and CR was introduced to enhance the efficiency of frequency spectrum usage [1]. The Notice of Proposed Rule Making (NPRM) of the Federal Communications Commission (FCC) found the licensed band allocated to TV channels highly underutilized. To improve spectrum efficiency, they permitted secondary systems to function in the frequency band allocated to the television services [2] [3] [4]. Considering this, the IEEE 802.22 Working Group (WG) developed WRAN (Wireless Regional Area Network), a secondary system that will be operating in the licensed TV channels [5] [6].

The WRAN system was developed to provide wireless broadband access to the rural areas where broadband services have not yet reached due to certain physical limitations. To achieve this purpose, CR is seen as the solution, allowing capable and reliable use of

spectrum by adjusting to the radio's environment accordingly [1] [7]. CR has emerged as a potential technology in order to increase the usage of the limited radio bandwidth in addition with accommodating the growing number of wireless services, devices and networks. A CR transceiver is an intelligent device that adjusts itself to the radio environment consequently increasing the utilization of the limited radio resources while providing flexibility in wireless access [8]. Although the requirement of spectrum sensing has been eliminated recently by FCC [18] as CR will now be equipped with TV channel database, the traditional CRs could perform following important functions [9]: (1) Sense the spectrum to find out the available portions and detects the presence of licensed users in a licensed band. (2) Choose the best suited vacant channel. (3) Sharing this channel with other users; and (4) Vacate the channel at the arrival of the licensed user.

Spectrum handoff is a very important aspect in CR networks. It manages flawless communication in case of PU arrival while the channel is being used by the SU. Spectrum mobility allows the SU to resume its transmission on another vacant channel when the PU reclaims its channel. In order to continue its transmission SU will have to look for an idle channel first, and then decide whether to switch to another channel or stay on the current channel to wait for it to become available again. In all this process there will be a notable amount of handoff delay.

This paper focuses on the issue of handoff delay caused during spectrum mobility under the new FCC September 2010 release. Radio frequency spectrum is a very precious and valuable resource. According to [9], TV channels and their guard channels are to be used for communication in IEEE 802.22, which is the first standard implementing CR technology. This concludes that guard channels can be used for communication. During handoff process we can make wise use of guard channels through intelligent hardware devices and by communication protocols. This concept was first floated in [24], this paper implements this concept and proposes a handoff to a guard channel scheme (HGCS) in order to reduce the handoff delay compared to the existing handoff schemes. The guard channels are vacant channels; SU will easily search and access them without any difficulty.

The rest of the paper is organized as follows: In section II and III related work and spectrum handoff

Author ^α : Research Scholar, Department of Computer Science, University of Peshawar, Khyber Pakhtunkhwa, Pakistan.

E-mail : madeeha_08@yahoo.com

Author ^Ω : Chairman, Department of Computer Science, University of Peshawar, Khyber Pakhtunkhwa, Pakistan.

E-mail : saeedmahfooz@upesh.edu.pk

Author ^β : Assistant Professor, Department of Computer Science, University of Peshawar, Khyber Pakhtunkhwa, Pakistan.

E-mail : wahrehman@upesh.edu.pk

mechanism is discussed. Followed by section IV and V which presents the proposed handoff to the guard channel scheme (HGCS) and numerical and simulation results. Finally section VI concludes the paper.

II. RELATED WORK

Spectrum handoff varies from traditional handoff in wireless networks. Spectrum handoff takes place upon PU arrival whereas the handoff in wireless networks takes place due to signal degradation and user mobility. In nearly all of the existing spectrum handoff schemes [10]–[17], the handoff performance has been examined using numerous methods, taking into account different aspects discussed as follows:

In [10], authors explored spectrum handoff for link maintenance of three types, i.e., non-spectrum handoff, the proactive spectrum handoff, and the spectrum handoff depending on sensing mechanism. The authors have observed the performance based on the probability of link maintenance as well as the effective data rate of the SU's transmission. However their results reveal that there could be chances of erroneous and incorrect channel selection hence affecting the performance of SU. The authors in [11] have measured the handoff performance in opportunistic¹ and negotiated² situations. They have generalized the key tele-traffic parameters in both the primary system and the secondary system. Although the results show that opportunistic access provides higher SU service completion, nevertheless there will be an increase in handoff operations leading to noticeable amount of handoff delay. Whereas in [12] the authors have evaluated reactive-sensing spectrum handoff in comparison with proactive-sensing spectrum handoff. The authors have shown that proactive sensing minimizes transmission latency, although certain handoff delay still exists there. Moreover, [13] discusses a greedy approach to minimize total service time by selecting the target channels. Except that since there will be multiple spectrum handoffs, it will increase the number of interruptions resulting in a lot of channel switching overhead in resuming the transmission. In the study by [14], the authors propose a new scheme for spectrum handoff i.e. —Spectrum handoff to a backup channel to reduce the consecutive spectrum handoffs. Even so the scheme is for wireless ad hoc networks only. The authors in [15] have proposed a post-sensing spectrum handoff scheme which is based on Markov decision process. This scheme tries to minimize the waiting time for packet transmission. However the delay involved for sensing process persists. In [16], the authors have introduced a voluntary spectrum handoff method that reduces forced handoffs for secondary users, making the secondary users have longer

uninterrupted connection times. Except that since it is dependent on primary user estimation, there are chances of erroneous estimates. In addition, there will be an added complexity for the estimation process. In [17] the SU selects its operating channel based on the expected remaining idle period. Nonetheless it is dependent on past channel usage statistics for which the estimates could seldom be inaccurate.

All the spectrum handoff schemes discussed above have different shortcomings and the major one that is common in all of them is delay due to spectrum handoff. Other drawbacks include wastage of time, transmission latency, increase in transmission time for a SU caused by consecutive spectrum handoffs, chances of collision in case of proactive handoffs and increased complexity by estimating the PU arrival beforehand.

III. SPECTRUM HANDOFF

The spectrum handoff procedure has been discussed widely in many papers. Spectrum handoff takes place when a SU is operating on a licensed channel; meanwhile the PU gets activated and reclaims its channel. To continue its transmission, SU will search for an idle channel using different handoff schemes.

The traditional handoff procedure involves the sensing phase. FCC adopted and released new rules for White Space in September 2010 [18]. According to the new rules, the requirement for TV band devices to be capable of spectrum sensing has been eliminated, as the geo location and database access method are enough to provide reliable protection to TV channels. According to the new rules, the SU should have access to the TV channel database and it should be equipped with geo-location capability as well. The SU will then know if the channel is empty or taken up by PU, it does not need to sense the spectrum for idle channels anymore.

a) *The traditional spectrum handoff procedure*

- The SU has sensed the spectrum to find available channel for transmission.
- When the channel is available, the SU hops onto the channel and starts using it for transmission.

¹ No centralized spectrum agency managing the spectral band [11].

² A spectrum server centrally managing the whole spectrum [11].

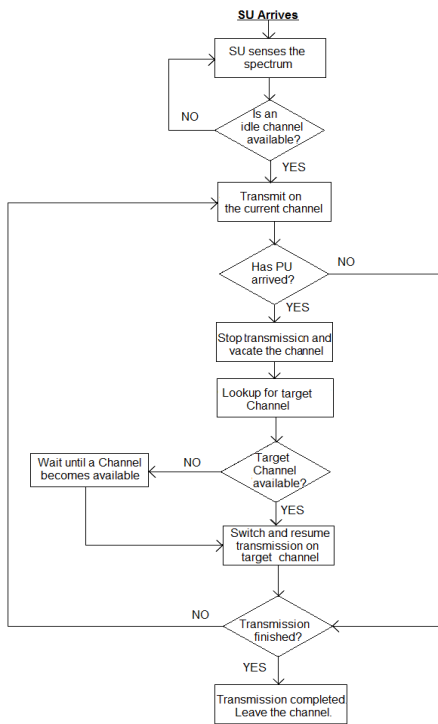

Fig.1 : Flow chart for traditional spectrum handoff

- When the SU detects the arrival of PU, it stops its transmission.
- The SU then vacates the channel, and resumes its transmission on the selected target channel.
- This process is repeated for as many times the interrupt occurs.

The flow chart of the traditional handoff procedure is shown in figure 1.

b) Handoff delay for traditional spectrum handoffs

The amount of delay caused during a handoff procedure relies on the handoff scheme used. These spectrum handoff schemes can be categorized as:

- Non spectrum handoff.
- Handoff based on radio sensing; which is further classified into Proactive sensing spectrum handoff and Reactive sensing spectrum handoff.

Handoff delay is termed as the time period from the moment of suspending frame transmission until the moment of resuming the transmission [12]. In case of non-spectrum handoff, the secondary user will wait for the same channel it had previously transmitted on before interrupt to become available again. In this case, the total handoff delay will be the waiting time on the channel for it to become idle again after each interrupt. [13] Calculates the handoff delay for non-spectrum handoff as,

$$E[D] = Y_o \tag{1}$$

Where $E[D]$ denotes the handoff delay and Y_o is the average busy period resulted from the PU of the channel.

In case of reactive approach, the delay will be the time required to find another channel on the spot, and wide band sensing will be needed. [12] Calculates the delay due to reactive approach as,

$$E[D_{reactive}] = t_p \tag{2}$$

Where t_p denotes the processing time which is the sum of channel switching time t_s and channel sensing time t_f .

In case of proactive approach, a backup channel is ready before transmission, the delay comprises of waiting time in queue as well as the waiting time on channel. [12] Calculates the delay due to proactive approach as,

$$E[D_{proactive}] = \min \{E[D_{stay}], E[D_{change}]\} \tag{3}$$

Where $E[D_{stay}]$ is the delay if the SU chooses to stay on the channel and wait for it to become available and $E[D_{change}]$ is the delay if the SU chooses not to wait for the current channel and hops onto to an available backup channel.

Proactive decision spectrum handoff reduces handoff delay as compared to reactive handoff since sensing all over again is not required [19]. This paper proposes a HGCS scheme that will minimize the handoff delay and total service time even more than the proactive strategy.

c) The Spectrum Handoff Procedure under new FCC rules

With these new rules, a typical TV band CR device mechanism now becomes:

- SU is connected to a fixed device that has access to TV channel database and is equipped with geo-location facility.
- SU obtains a list of idle channels from the fixed device.
- The SU selects a channel from the list and starts using it for transmission.
- The SU will already be aware of the arrival of PU. It will stop transmission and vacate the channel upon the arrival of PU.
- The SU will use a spectrum handoff mechanism to vacate the channel upon the arrival of PU.
- According to the spectrum handoff mechanism used, the SU will have already looked up or will then look up the available TV channel list for another idle channel for transmission.
- If another idle channel is available in the TV channel list, the SU will hop on to it and resume its transmission on the new idle channel.
- Else the SU then stays on the current channel and will wait for it to become available again.
- For the number of times the SU is interrupted, the above handoff procedure is repeated for each time.

d) *Handoff Delay under new FCC rules*

The handoff delay depends on two major aspects, one is due to the handoff scheme applied and secondly due to the time needed in spectrum sensing phase. The major difference between traditional and new procedure handoff is that the new procedure eliminates spectrum sensing phase. Its delay will only depend on the handoff scheme used, where as in traditional approach both aspects need to be considered.

IV. HANDOFF TO THE GUARD CHANNEL SCHEME (HGCS)

This paper reduces the handoff delay and hence the total service time for 802.22 networks using CR technology using the concept introduced in [24]. IEEE 802.22 is the first wireless standard based on CRs [5]. A slotted-based CR network is considered as in [13], with essential modifications made to it. Since the sensing requirement has been eliminated by FCC [18], each slot now consists of available TV channels list lookup phase and transmission phase. SU must obtain a list of available channels from TV Channel database before data transmission. The proposed handoff solution is a combination of proactive handoff strategy and HGCS strategy.

a) *The proposed HGCS Scheme*

This section gives an overview of the proposed HGCS scheme. The assumptions are summarized as follows,

- All the SU nodes are equipped with CR technology.
- The spectrum to be used for unlicensed communication by SU is the licensed spectrum of the PU (i.e. the TV channels).
- The SUs are mode I personal/ portable TVBDs (TV Band Devices) connected to a fixed mode II TVBD which is capable of determining the available channels at its location using geo-location and database access [23]. Figure 2 shows the scenario.
- SU can use the licensed channel for unlicensed use with the condition that the PU can preempt the SU when it arrives.
- The SUs are served on first come first serve (FCFS) basis.
- The PRP M/G/13 queuing network model proposed in [12] and [13] is followed with essential modifications made to it.
- There are guard channels that exist between the transmission channels. We assume that guard channels can be used for communication [9].
- Further we assume, as in [20] that while communicating on the guard channels the integrity of the system will be preserved. It will not interfere with the transmission of other channels. This has been made possible by superimposing the information signals in the guard frequency bands.

[20] Proves that guard bands can be used for communication and that a proper method as well as an apparatus exists for it.

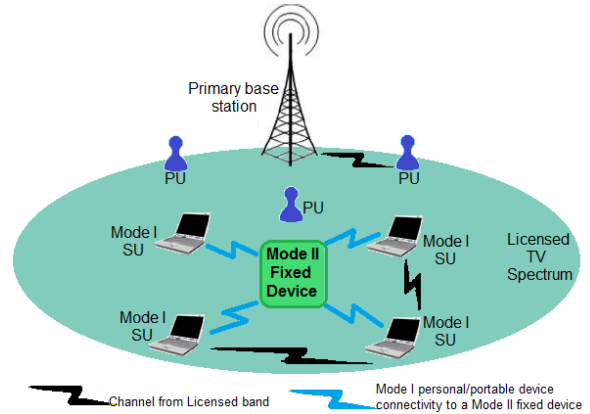

Fig.2 : Assumed CR Network Scenario

- It is assumed that SUs will communicate with each other by accessing their base station [22], which will be the fixed mode II TVBD they are connected to. Further, the base station maintains a database of all the channels and guard channels being used by the SUs.
- The proposed scheme is for IEEE 802.22 scenario, where RF channel bandwidth as well as the guard channel bandwidth is 6 MHz [9] [21], so the quality of the transmission will not be affected.

The steps of the proposed scheme HGCS are described as follows:

1. The SU obtains a list of available channels from the TV channel database of fixed Mode II device it is connected to.
2. SU selects a channel for transmission from the provided list.
3. SU starts using the selected channel for its transmission.
4. The SU will know from the TV channel list when to expect the PU back on the channel. It will vacate the channel as soon as the PU is back.
5. The SU will now look up the TV channel list for another channel. If available, it hops onto it and resumes its transmission.
6. If no other channel is available in the TV channel list, the SU will access its base station (the fixed mode II device) to look up the database of guard channels being used by other SUs.

³ PRP M/G/1 queuing network model is a Preemptive Resume Priority queuing network model with Markovian (exponential) distribution inter arrival time of PU and SU. It has a General distribution service time with 1 or more channels. The model is used to characterize the spectrum handoff for random proactive approach and proposed HGCS approach.

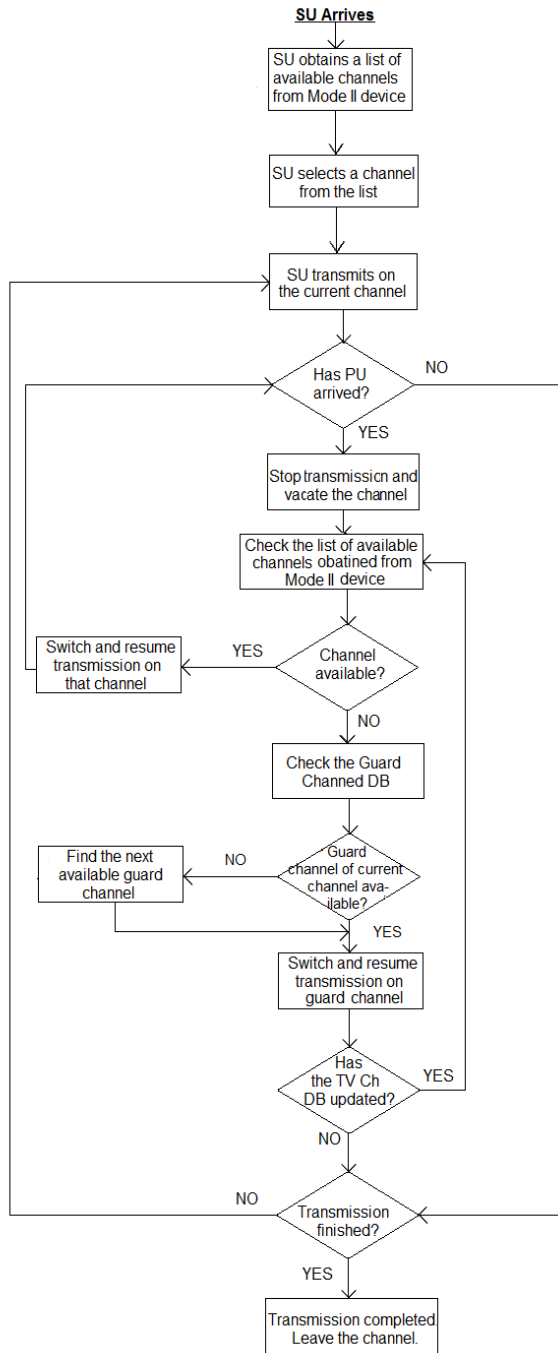

Fig.3 : Flow chart for the proposed HGCS Scheme

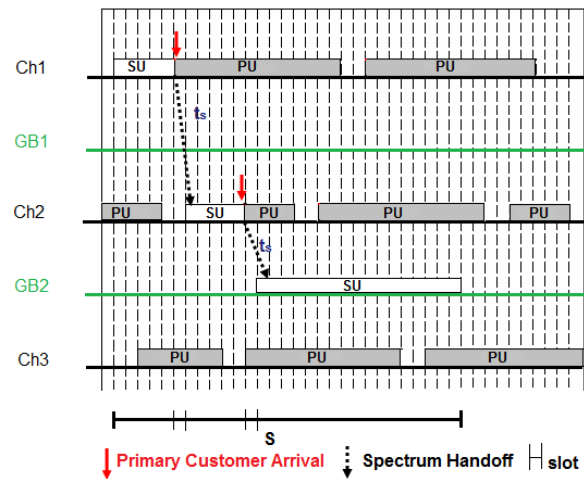

Fig.4 : An example of packet transmission process following HGCS scheme with two interruptions, where t_s is the channel switch time.

7. If in the database, the SU finds the guard channel of the channel it last used empty, it will switch to the guard channel and resume its transmission on the guard channel.
8. If the guard channel of the last channel used by SU is unavailable, it will switch to the next available guard channel and resume its transmission on it.
9. While communicating on guard channel, the SU will recheck its database for another idle channel if it is updated.
10. If it finds another idle channel in the updated database, it will switch to it and resume its transmission there.
11. Else it stays on the guard channel to complete its transmission.

The flow chart of the proposed scheme is shown in figure 3. The diagrammatic illustration used in [14] is modified it to the proposed HGCS scheme as shown in figure 4. In this figure, PU and SU stand for primary user and secondary user respectively. The default channel of SU is Ch 1. Finding its default channel Ch1 available; SU starts transmission on Ch1. After 5 time slots, the SU stops transmission and vacates the channel for the PU. The SU looks up its TV channel list and finds Ch2 idle. It switches to Ch2 to resume its transmission. After 5 time slots the SU needs to vacate the channel again for the PU. The SU looks up the TV channel list again for another idle channel. Finding no idle channel even in the list, the SU then checks the guard channel database. It finds the guard channel (GB2) of its last used channel (Ch2) available. The SU switches to GB2 to resume its transmission.

Finally the transmission of SU finishes on GB2. The total service time (denoted by S) is termed as the period from the moment of beginning transmitting packets until the completion of transmission. In this case

the SU needed total 27 time slots to complete its transmission.

b) PRP M/G/1 Queuing Network Model

A preemptive resume priority (PRP) M/G/1 queuing network proposed in [12] [13] is followed with considerable modifications made to the traditional PRP M/G/1 Theory as well as the proposed model in [13].

The guard channel between the channels is utilized for transmission in order to reduce the transmission delay for SU. A HGCS scheme is proposed to reduce the handoff delay, consequently minimizing the Total Service Time (S).

The proposed PRP M/G/1 queuing network is shown in figure 5. The model demonstrates a PRP M/G/1 queuing network having 2 channels, where PUs are placed in high priority queue and SUs are placed in low priority queue. The (bs(x)) indicate the transmission packets. λ_o denotes the arrival rate of PUs and λ_n denotes the arrival rate of SUs.

When SUs are interrupted by PUs, two cases can arise:

Case 1: After interruption, the SU checks the backup channels and the available TV channels list respectively for another vacant channel, if available; the unfinished transmission is put into the low priority queue of that channel.

Case 2: Else, instead of waiting in queue for a channel to become available, the unfinished transmission is then resumed on the guard channel of the last used channel.

If the guard channel of the last used channel is not available, the SU finds another available guard channel in the guard channel database.

The secondary user will be in ‘always-change’ state, since it will never have to stay on a channel and wait for it to become available.

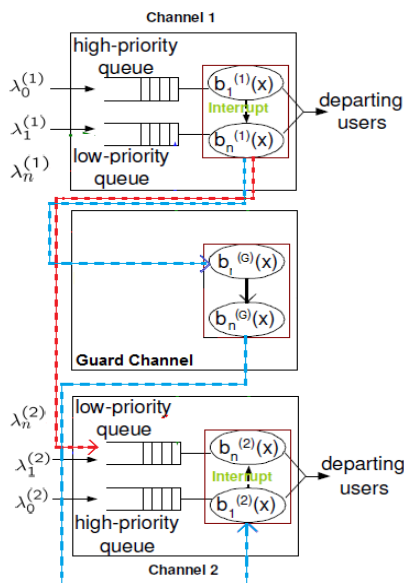

Fig 5 : PRP M/G/1 Queuing Network Model for the proposed scheme

c) Handoff delay and Total Service Time of secondary customers

Let S denote the total service time and E[D] denote the handoff delay. [13] Calculates the total service time as,

$$S = E[X_s] + E[N]E[D] \tag{4}$$

where, E[Xs] = The mean transmission length beginning with the packet transmission or resumption until packet interruption.

E[N] = The average number of interruptions. Calculated by,

$$E[N] = \lambda_o E[X_s] \tag{5}$$

where, λ_o is the arrival rate of PUs with Poisson processes.

E[D] = hand off delay.

For always-stay strategy, [13] calculates,

$$E[D_{stay}] = Y_o \tag{6}$$

For always-change strategy, [13] calculates,

$$E[D_{change}] = W_s + t_s \tag{7}$$

where Ws is the waiting time of SUs and ts is the channel switching time.

Considering both cases, [12] calculates Total Service Time for random proactive decision spectrum handoff as,

$$E[S_{random}] = E[X_s] + \frac{E[N]}{2} Y_o + \frac{E[N]}{2} (W_s + t_s) \tag{8}$$

According to the proposed HGCS method, the SU will always be in always-change case, i.e., either handoff to another vacant channel, or handoff to the guard channel. So, when calculating the total service time (S) for proposed HGCS scheme, the situation concerning the always-change case only will be faced, therefore the new Total Service Time (S) can now be calculated as:

$$S = E[X_s] + \frac{E[N]}{2} (W_s + t_s) \tag{9}$$

V. NUMERICAL AND SIMULATION RESULTS

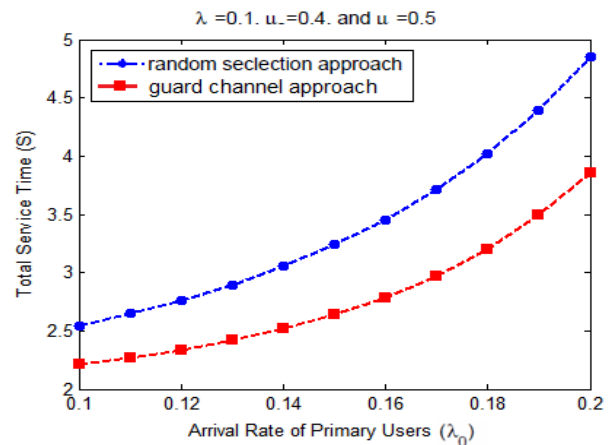

Fig.6 : Comparison of total service time for random and guard channel strategies. The value of ts is assumed to be zero.

a) Simulation Setup

For simulation MATLAB software is used. In order to compare our results with the random proactive decision spectrum handoff, the scenario assumed in [13] is followed. A system with 2 channels is considered. Both channels will entertain PUs and SUs. The arrival rate for both types of users is generated with the Poisson process. SUs can be interrupted by PUs. First-come-first-serve scheduling discipline is assumed.

b) Performance Evaluation

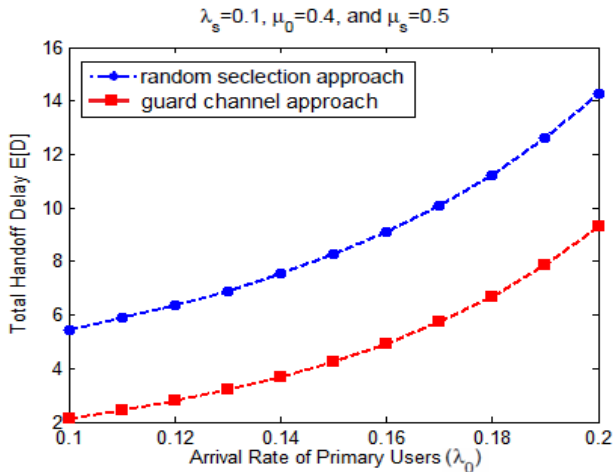

Fig.7 : Comparison of total handoff delay for random and guard channel strategies. The value of t_s is assumed to be zero.

Figure 6 compares the total service time using two different handoff schemes: 1) the random proactive decision channel selection strategy and 2) the proposed HGCS strategy. For $\lambda_s \leq 0.2$, the figure shows that the total service time can be reduced to more than 20% from the random channel selection approach. For larger λ_s , it can be anticipated that the proposed HGCS strategy can notably improve total service time.

Figure 7 compares the handoff delay for the two approaches mentioned above. For $\lambda_s \leq 0.2$, the figure shows that the total handoff delay can be reduced significantly using the proposed HGCS approach as compared to the random channel selection approach.

For larger λ_s , it is shown in Table 1 that the proposed HGCS strategy can considerably minimize the total handoff delay.

Figure 8 shows the effect of μ_s on the total service time of the HGCS. The SU has exponentially distributed packet length ($b_s(x)$) defined in [13] as,

$$b_s(x) = \mu_s e^{-\mu_s x} \tag{10}$$

where μ_s is the packet inter arrival time of SU. μ_p is the packet inter-arrival time of PU. The figure shows that with greater μ_s , the total service time is considerably less.

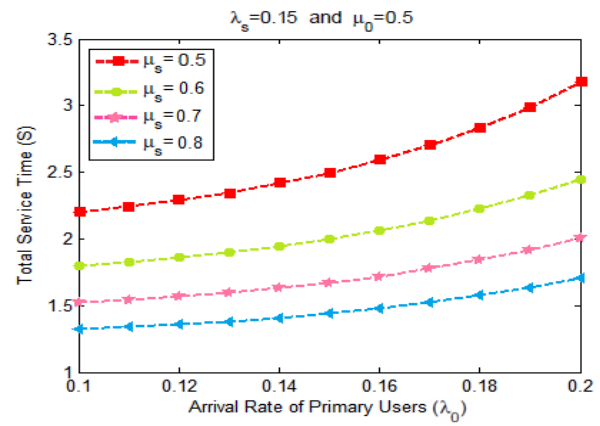

Fig.8 : Effect of μ_s on the total service time of HGCS. The value of t_s is assumed to be 0.

Table 1 compares the values of total service time and delay for different PU arrival rates. With the increase in arrival rate of PU, the service time significantly improves as compared to the random approach from 15 % to 20 % as shown in Table 1. For larger values of λ_s , the improvement will be even greater than 20%.

There is a noteworthy improvement in the delay values as well. HGCS shows better results as it eliminates the need of on channel wait as in random proactive approach. Secondly, it eliminates the blocking probability of SU transmission as well, as SU is going to have a channel available for it throughout the transmission. In addition the time needed for finding a new channel for completing the transmission is also minimized, as can be seen in the Table 1.

Table 1 : Comparison of Random Approach and HGCS Approach

$\lambda_s = 0.1, \mu_s = 0.5 \text{ and } \mu_0 = 0.5$						
	λ_0	Random Proactive Approach		HGCS Approach		Improvement in S with HGCS % Increase
		S	E[D]	S	E[D]	
1.	0.12	2.76	6.35	2.33	2.78	15.5%
2.	0.14	3.05	7.53	2.51	3.68	17.7%
3.	0.16	3.45	9.09	2.78	4.92	19.4%
4.	0.18	4.02	11.22	3.20	6.68	20.3%
5.	0.2	4.85	14.28	3.85	9.28	20.6%

VI. CONCLUSION

In this paper a HGCS is suggested that makes effective use of the guard channels for communication in CR networks. By using guard channels, a major improvement can be seen in the total service time as HGCS successfully minimizes the handoff delay with an improvement of approximately 20%. HGCS is then compared to the random proactive decision handoff scheme using a preemptive resume priority (PRP) M/G/1

queuing network model to analyze the total service time and handoff delay in each case. Numerical and simulation results show significant improvement from 15% to 20% with the increase in the PU arrival rate for HGCS as it guarantees faster service time for SUs. In future work, HGCS will be tested in the BRS (Business Radio Service) scenario formerly known as MMDS (Multi channel Multipoint Distribution Service).

REFERENCES REFERENCES REFERENCIAS

1. S. Haykin, "Cognitive Radio: Brain-Empowered Wireless Communication", IEEE JSAC, Feb 2005.
2. Federal Communications Commission (FCC), "Notice of Proposed Rule Making," ET Docket no. 04-113, May 25, 2004.
3. Federal Communications Commission (FCC), "Notice of Proposed Rule Making," ET Docket no. 06-156, October, 2006.
4. Federal Communications Commission (FCC), "Notice of Proposed Rule Making," ET Docket no. 03-322, December, 2003.
5. Carlos Cordeiro, Kiran Challapali, Dagnachew Birru and Sai Shankar N, "IEEE 802.22: An Introduction to the First Wireless Standard based on Cognitive Radios", Journal of Communications, April 2006.
6. IEEE 802.22 Working Group on Wireless Regional Area Network, <http://www.ieee802.org/22/>.
7. J. Mitola, "Cognitive radio: Making software radio more personal" IEEE Pers. Comm. 2005, August 1999.
8. E. Hossain , V. Bhargava., "Cognitive Wireless Communication Networks", Springer Science+Business Media, 2007, LLC, ISBN 978-0-387-68830-5, e-ISBN 978-0-387-68832-9.
9. I. F. Akyildiz, W. Y. Lee, M. C. Vuran, and S. Mohanty, "NeXt Generation/Dynamic Spectrum Access/Cognitive Radio Wireless Networks: A Survey," Computer Networks Journal (Elsevier), vol. 50, pp. 2127–2159, September 2006.
10. L-C. Wang and A. Chen, "On the Performance of Spectrum Handoff for Link Maintenance in Cognitive Radio", Wireless Pervasive Computing, 3rd International Symposium, 7 – 9 May 2008.
11. Y. Zhang, "Spectrum Handoff in Cognitive Radio Networks: "Opportunistic and Negotiated Situations", IEEE International Conference on Communications, 2009.
12. L-C. Wang and C-W. Wang, "Spectrum Handoff for Cognitive Radio Networks: Reactive-Sensing or Proactive-Sensing?", IEEE Performance, Computing and Communications Conference, December 2008.
13. C-W. Wang and L-C. Wang, "Modeling and Analysis for Proactive-decision Spectrum Handoff in Cognitive Radio Networks", IEEE International Conference on Communications, June 2009.
14. M. A. Kalil, F. Liers, T. Volkert and A. M- Thie; "A Novel Opportunistic Spectrum Sharing Scheme for Cognitive AdHoc Networks", Journal Springer Verlag, 2009.
15. R.-T. Ma, Y.-P. Hsu, and K.-T. Feng, "A POMDP-based Spectrum Handoff Protocol for Partially Observable Cognitive Radio Networks," IEEE Wireless Communications and Networking Conference (WCNC), April 2009.
16. S.-U. Yoon and E. Ekici, "Voluntary Spectrum Handoff: A Novel Approach to Spectrum Management in CRNs," IEEE International Conference on Communications (ICC), May 2010.
17. Y. Song and J. Xie, "Common Hopping Based Proactive Spectrum Handoff in Cognitive Radio Ad Hoc Networks," IEEE Global Communications Conference (GLOBECOM), Dec. 2010.
18. Federal Communications Commission(FCC), "Notice of Proposed Rule Making," ET Docket No. 04-186, 23 September 2010.
19. Q. Zhao, L. Tong, A. Swami, and Y. Chen, "Decentralized Cognitive MAC for Opportunistic Spectrum Access in Ad Hoc Networks: A POMDP Framework," IEEE Journal on Selected Areas in Communications, vol. 25, no. 3, pp. 589–600, April 2007.
20. Mitsuru Uesugi and Yokosuka, "OFDM Guard Band Communication Apparatus And Method," U.S. Patent 7 012 949 B2, Mar. 14, 2006.
21. Sung-Hyun Hwang, "Fractional BW Usage for WRAN Systems," IEEE P802.22 Wireless RANs, .. IEEE 802.22-06-0117-00-0000, 17 July 2006.
22. Kwang-Cheng Chen, Ramjee Prasad, "Cognitive Radio Networks", John Wiley and Sons, 2009, ISBN 978-0-470—69689-7.
23. Federal Communications Commission(FCC), "Small Entity Compliance Guide," ET Docket No. 04-186, 14 November 2008.
24. Madeeha Aman, Saeed Mahfooz and Waheed Ur Rehman, "Handoff delay in Cognitive Radios – A concept paper on utilization of guard channels IEEE 1st International Conference on Computer Networks and Information Technology (IEEE ICCNIT'11), 11 – 13 July, 2011, pp. 211 – 215, ISBN: 978-1-61284-941-6, ISSN: 2223-6317.