



# Force and Slip Displacement of Fibre Cemboard Panels Subjected To Four-Point Bending Test

Nur Amirah Najwa Mohammed<sup>1</sup>, Arnie Farhana Norhalim<sup>1,2</sup>, Zainorizuan Mohd Jaini<sup>1\*</sup>, Mazlan Abu Seman<sup>3</sup>

<sup>1</sup>Structural Dynamics and Computational Engineering, Faculty of Civil Engineering and Built Environment, Universiti Tun Hussein Onn Malaysia, 86400 Parit Raja, Johor, MALAYSIA

<sup>2</sup>Offshore, Utilities and Marine Terminals Department, ExxonMobil Research and Engineering, ExxonMobil BSC Malaysia Sdn. Bhd., 50450 Kuala Lumpur, MALAYSIA

<sup>3</sup>Department of Civil Engineering, College of Engineering, Universiti Malaysia Pahang, 26300 Gambang, Pahang, MALAYSIA

\*Corresponding Author

DOI: <https://doi.org/10.30880/ijie.2022.14.05.028>

Received 26 June 2022; Accepted 15 August 2022; Available online 25 August 2022

**Abstract:** For many years, fibre cemboard has been widely used in the construction industry. This material has many advantages, including a long-life span, ease of installation and low maintenance, which can reduce the cost of maintenance. However, due to its limitation of being unable to support heavy loads, it is only suitable for the lightweight floor system. Therefore, the fibre cemboard panel is introduced. Basically, the fibre cemboard panel consists of several layers of fibre cemboard that stack together using a special bond mechanism. This study aims to investigate the flexural capacity and slip displacement of fibre cemboard panels with different bond mechanisms (polyurethane glue, steel bolts and polyurethane glue + steel bolts) and spacings (50 mm, 75 mm, 100 mm, 150 mm, and 200 mm). The specimens were fabricated with a size of 305 mm width, 1220 mm span and 2@16 thickness. The four-point bending test was carried out using Universal Testing Machine (UTM) that yield the force-slip displacement curves. The results of experimental testing indicate that the bond mechanism has an apparent impact on the flexural capacity and slip displacement. The fibre cemboard panels bonded by steel bolts have the best performance. Meanwhile, the spacing was found to control the slip displacement the most than the flexural capacity. Close distance of spacing may increase the stiffness that appreciably contributes to better performance. The optimum spacing for the polyurethane glue is 50 mm, while the specimens bonded by steel bolts and polyurethane glue + steel bolts should have 75 mm and 100 mm spacings. The polyurethane glue can hold the stress concentration before the detachment. When polyurethane glue fails, the steel bolts resume the function to resist the slip displacement until the rupture.

**Keywords:** Fiber cemboard, force, slip-displacement, bond mechanism, four-point bending test

## 1. Introduction

Asbestos cemboard was previously popular in the construction industry. However, since this material was found harmful to human health, fibre cemboard has been preferred and replaced the function of asbestos cemboard. According to Bodnarova et al. [1], fibre cemboard is made from clean and green raw ingredients that consist of 50% to 70% cement with various types of mineral cellulose and filler (limestone powder, kaolin, perlite, and quartz sand). It is specifically developed for use in high humidity situations, such as those with strong fire and water resistance [2].

\*Corresponding author: [rizuan@uthm.edu.my](mailto:rizuan@uthm.edu.my)

2022 UTHM Publisher. All rights reserved.

[penerbit.uthm.edu.my/ojs/index.php/ijie](http://penerbit.uthm.edu.my/ojs/index.php/ijie)

Commonly, fibre cemboard is used for roof tiles, walls, floors, and aesthetic purposes [3]. Fig. 1 shows the application of fibre cemboard as structural and non-structural components.

In terms of the floor system, the application of fibre cemboard is not just limited to industrial and leisure buildings but has been extended to heavy-duty facilities. However, such a purpose requires special specifications to provide excellent serviceability. In general, the strengths of fibre cemboard are assessed through the modulus of rupture and mainly depended on fibre volume fraction. The bending strength of fibre cemboard is 22 MPa. Its tensile strength is around 6.5 MPa, whereas the compressive strength can achieve as high as 40 MPa. Despite the tensile strength improving by around 53% because of fibre volume fraction, the compressive strength declines correspondingly [4], [5]. When compared to concrete, fibre cemboard exhibits better toughness, ductility, flexural capacity, and fracture resistance [6].

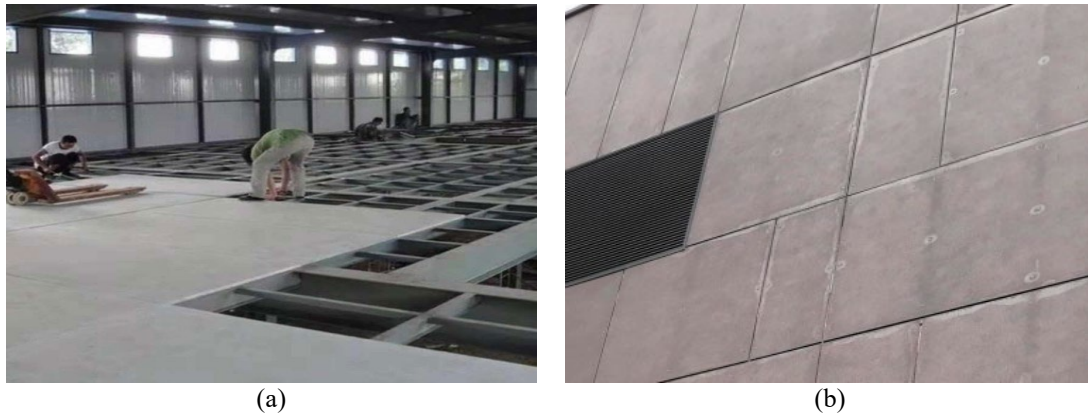

**Fig. 1 - The application of fibre cemboard - (a) floor system; (b) building facade**

Since fibre cemboard is fabricated with thickness around 16 mm to 20 mm, hence multi-layer should be provided for heavy-duty facilities. In major cases, polyurethane glue is applied to stick fibre cemboard according to the desired ply. However, the durability of polyurethane glue always becomes a challenge to maintain the integrity of fibre cemboard. Innovatively, the fibre cemboard panel is introduced to tackle the problems related to the bearing capacity, deformation, and detachment. In this approach, several layers of fibre cemboard can be stacked together using steel bolts as connector. Moreover, the polyurethane glue and steel bolts can be combined simultaneously. The application of fibre cemboard panel is vastly efficient, sustainable, and can be classified under an industrialized building system (IBS). The fibre cemboard panel can be fabricated in a factory or site, is easy to install and repair, as well as provide better performance.

The fibre cemboard panel has created a new horizon in its application. It allows thicker fibre cemboard to be installed for the floor system. Indirectly, the tensile-bending strength and compositeness can be augmented. Lu et al. [7] stated that the presence of steel bolts that act as the bond mechanism can improve the stiffness. The orientations of steel bolts in terms of size, spacing and end distance may govern the structural behaviour. Under the concentrated load, the interaction between steel bolts and fibre cemboard will induce high accumulated stresses. Cracking will be initiated due to high accumulate stresses and subsequently cause severe damage. However, the knowledge pertaining to this issue about the fibre cemboard panel is still not readily available. Especially the bearing resistance and slip displacement. Moreover, the effects of bond mechanism and spacing remain ambiguous and thus need to be investigated.

## 2. Fiber Cemboard

The invention of fibre cemboard can be traced back as early as 1902 when Hatschek process was used to create thin sheets from cement slurry [8]. On a conveyor belt, diluted cement slurry, fibre, water, and silica are mixed and dewatered. The layer that produced from dewatered is shifted to a mandrel. The process is repeated until the required thickness is achieved. Alternatively, the dilute slurry which consists of fibre, cementitious materials, and aggregates (quartz powder) can be sprayed or strained over fine screens. These fine screens gather the solids in a saturated state and forms thin layers. Then, the thin layers are piled on top of each other to achieve the desired thickness [9]. Fig. 2 depicts the major steps involved in Hatschek process. Although Hatschek process was originally created to produce asbestos, but nowadays it has been used to fabricate fibre cemboard based on cellulose fibre.

The use of cellulose fibre to replace asbestos has raised its own set of sustainability in the construction industry. In general, cellulose fibre can be obtained from various sources mainly from agricultural waste. According to Khedari et al. [10], agricultural waste generated worldwide can be reused to create new products. Abdel-Kader & Darweesh [11] stated that cellulose fibre from agricultural waste can be mixed into a mineral binder like cement to produce fibre cemboard. Although cellulose has several weaknesses such as poor strength, high water absorption and low frost resistance, the improvement in its natural characteristics can produce better quality of fibre cemboard.

Mukhametrakhimov & Lukmanova [12] suggested modifying agents on the physico-mechanical properties cellulose fibre where the durability of fibre cemboard can be significantly enhanced.

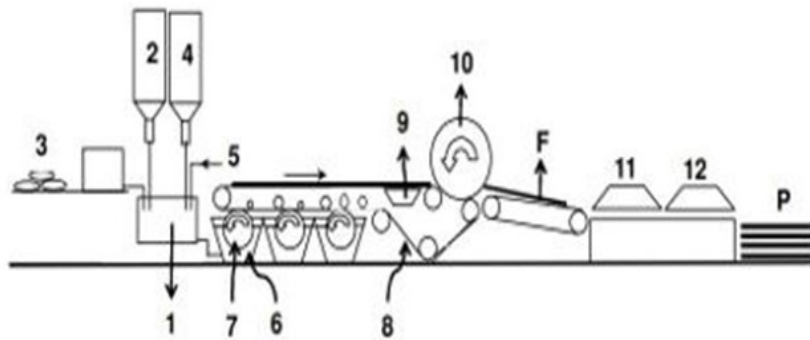

Fig. 2 - Hatschek process in the production of fibre cemboard [13]

## 2.1 Mechanical Properties

Fibre cemboard is made of a mixture which consists of 70% cement, 13% water, 10% filler (micro-silica and ground limestone), 3% cellulose fibre and 4% polyvinyl alcohol fibre [1]. Cement plays a major role in the mixture and acts as the binder. Meanwhile, cellulose fibre become reinforcement to strengthening the material compositions. According to Ahmad et al. [14], the presence of cellulose fibre in fibre cemboard help to increase the strengths, elastic modulus, toughness, and crack resistance. The strengths of fibre cemboard was greatly influenced by the density. It is similar to lightweight concrete. Karade [15] state that the density range for fibre cemboard is  $400 \text{ kg/m}^3$  to  $750 \text{ kg/m}^3$  for application of thermal insulation and masonry block. For ceiling, floor system and firewall, the density range could be  $1000 \text{ kg/m}^3$  to  $1200 \text{ kg/m}^3$ .

Flexural strength is the most demanding features for structural component [16]. According to Noor Azammi et al. [17], flexural strength refers to the ability of structural component to resist bending deflection. Khorami & Ganjian, [18] studied the flexural strength of fibre cemboard and found that the results could reach up to 6.6 MPa with the presence of the silica fume. It was found that the addition of silica fume able to improve other mechanical properties up to 20% of flexural strength. The presence of fibre volume fraction was found has an apparent effect on the flexural strength. As investigated by Khorami et al. [19], the best fibre volume fraction is 2% that can produce flexural strength up to 10 MPa.

In addition, fibre cemboard is also recognized to has high durability toward moisture [1]. Pan & Liu [20] and Singh et al. [5] conducted water absorption test on fibre cemboard. The finding shows that the increment of cellulose fibre content resulted in the higher water absorption. An experimental study by Jamshidi et al. [8] revealed that the maximum flexural strength load occurs at the dry specimens of fibre cemboard. Meanwhile, the wet specimens produce maximum deflection. This is due to water absorption by the cement matrix which reducing the stiffness and enhance the ductility of specimens.

## 2.2 PRIMAFlex

PRIMAFlex is an environmentally friendly multipurpose fibre cemboard that may be used both internally and externally. It is the flat sheet of choice for industry specialists. PRIMAFlex is manufactured by Hume Sdn. Bhd. This type of fiber cemboard is autoclaved for superior durability, flexibility, and outstanding dimensional stability. In addition, the fibre cemboard is lightweight (the nominal density of fibre cemboard is  $1390 \text{ kg/m}^3$ ) and fully free from asbestos. It has a composition of top-grade cellulose, Portland cement, finely ground sand, and water. The thickness of the fibre cement board is 16 mm, while the width and length are varied from 450 mm to 1220 mm and 603 mm to 3000 mm. The minimum bending strength is 10 MPa for wet and 16 MPa for dry. Jaini et al. [21] fabricated cemboard-foamed concrete panel using PRIMAFlex. Similarly, Sutiman et al. [22] used PRIMAFlex to prepare specimens for the lightweight steel composite slab.

## 2.3 Application of Fiber Cemboard

As one of materials for the building, fibre cemboard is incredibly useful. According to Ranachowski & Schabowicz [6] stated that fibre cemboard is widely used in ventilated facade cladding for both newly built and renovated buildings, interior wall coverings, balcony balustrade panels, base course and chimney cladding as well as the enclosure soffit lining. Because of fibre cemboard is less expensive and just require minimum maintenance, it commonly be used as a wood siding substitute [9]. Other than that, Khorami & Ganjian [18] described that the application of fibre cemboard can be extended for roofing and internal or external walls. The use of fibre cemboard as a

bearing structural component is quite limited. According to Norhalim & Jaini [23], fibre cemboard can be used together with cold-formed steel joints or girders as lightweight floor system.

In Malaysia, the fulfilment toward industrialized building system (IBS) and green index has led the application of fibre cemboard as prefabricated composite structures. Ahmed & Badaruzzaman [24] proposed the profiled steel sheet dry board (PSSDB) as composite panel system. It consists of profiled steel sheeting that bonded together with fibre cemboard using self-drilling screws. It was found that PSSDB demonstrates high efficiency under coupled bending and axially compression pressure. Melcher et al. [25] utilized fibre cemboard as precast dry floor system. It was found that the fibre cemboard has sufficient strength to carry the permanent and variable actions. Fibre cemboard is common for precast dry floor system due to the easiness in the installation and finishing.

### 3. Composite Slab

Composite slab is an alternative for conventional reinforced concrete slab. It can be casted as in-situ or precast. Due to this flexibility in the construction method, composite slab can accelerate construction process. According to Fragiacomio & Lukaszewska [26], composite slab can be produced through the combination of two materials. These materials are joined together by means of a bonding mechanism. By structurally merging the two materials, the strengths and stiffness can be exploited to produce a very effective design. Reducing the density of material may result to the lower strengths, but this condition is exceptional for composite slab. Currently, there are few types of composite slab such as timber concrete composite (TCC), PSSDB and corrugated steel-foamed concrete (CSFM). Because of lightweight materials that use to cast composite slab, it prone to vibration under human activities.

TCC is the initiative to develop an effective construction method through the exploitation of concrete and timber [27]. The top part of TCC is concrete that take the shape of member and supported by timber beams. Figure 2.6 shows TCC which has been constructed as precast. The degree of composite action between concrete and timber is derived by shear connections that provide resistance to the slip layer under the loaded stage. In ensuring a high degree of composite can be achieved, shear connections must be entirely stiff under service loads and sufficiently soft to offer global ductility to the composite slab. Ismail et al. [28] used cold-formed steel decking sandwiched with plywood for the construction of the composite slab. It speeds up the construction process by eliminating the need for curing.

Seraji et al. [29] investigated the impact of controlling the horizontal movement of slab ends on the stiffness and flexural capacity of PSSDB. The slab as can be illustrated in Fig. 3 is made of the primary components from the profile steel sheeting and dry board that connected with self-drilling and self-tapping screws. The tensile and compressive stresses are expected to be carried by these components. The obtained results supported the claim that developed compressive membrane action in the floor results in stiffer system behaviour at serviceability loads. On the other hand, Al-Shaikhli et al. [30] evaluated the flexural performance of infilled PSSDB. Normal concrete was used as infill material. It can be observed from the experimental study that the infilled PSSDB acts as elastic behaviour before the profile steel sheeting attain the yield strength, then indicate ductile behaviour due to the composite action.

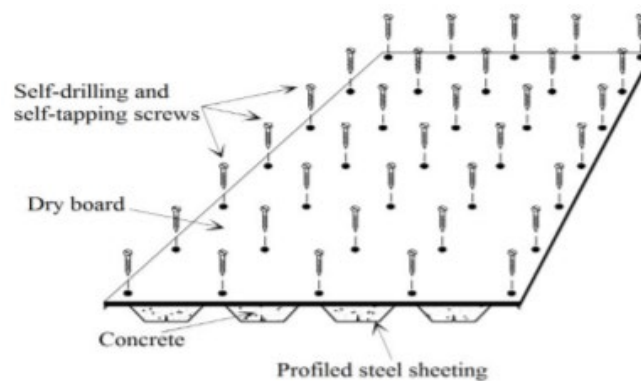

Fig. 3 - PSSDB [30]

#### 3.1 Bond Mechanism

For two materials to perform homogenously, the bonding mechanism must be provided in an effective way. The bonding mechanism can be provided by connector such as steel bolt, self-drilling screw and rivet. The use of connector is to provide shear capacity, prevent detachment of two materials and increase stiffness. In CSFM, embossment can be used to provide bonding mechanism that able to resist the slip-displacement. According Yeoh et al. [27], the connection stiffness influenced the degree of composite action. Auclair et al. [31] stated that concrete at the surrounding connection area is prone to experience cracking and fracture due to the high stress accumulation. Such condition can be observed in Fig. 4. With the same flexural stiffness, TCC beams can have varying strengths. The continuous steel mesh connector has better flexural rigidity and beam stability than discrete connectors but less elasticity.



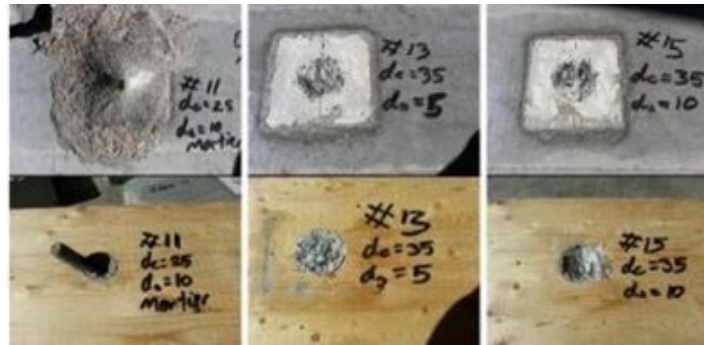

Fig. 4 - Cracking and fracture at the connection area [31]

Norhalim & Jaini [23] investigated the bearing resistance and failure mode of bolted-layered cemboard panel. The specimen that conducted consist of two layered fibre cement board that bond by a steel bolts and polyurethane glue. The push out test was carried out in this study. The result getting 38.79 kN which the higher value of bearing resistance that gained by 4 steel bolts and polyurethane glue composite. Meanwhile, the lowest value obtains by 2 steel bolts with polyurethane glue at 17.17 kN. Therefore, it can be observed that the polyurethane glue was discovered to be the governing factor in bearing capacity. Meanwhile, the steel bolt effectively controls the bond-slip behaviour. If the steel bolt is used solely as a bonding mechanism, the bearing capacity will be determined by its quantity and capacity and increasing the quantity of steel bolt will eventually result in a higher value of bearing resistance.

### 3.2 Failure Mode

In general, composite slab may experience flexure, shear and mixed behaviour that affect its bearing capacity, strengths, and ductility. Sjölander et al. [32] agreed that any types of failure mode occur on composite slab may contribute to the loss of structural integrity, reduce the interaction of bonding mechanism, and consequently contribute to the total collapse. Jamshidi et al. [8] emphasized that evaluating material properties is crucial for gaining insight into failure mode. In addition, Jamshidi et al. [8] conducted the comparison between the modulus of rupture of cemboard in wet and dry conditions. The findings show that the sample that is not exposed to water shows an increase in modulus of rupture to those of the wet state. As the modulus of rupture, the higher probability of the failure mode of sample to have also occurred higher.

An investigation on bearing capacity and mode failure of the layered-cemboard by using polyurethane glue with various number of bolts was done by Norhalim & Jaini [23]. Steel bolt samples, on the other hand, can effectively protect the fibre cement board from splitting. The stress distribution will be taken by the polyurethane glue during the initial phase in which the small samples are imposed by the loading. When the polyurethane glue fails and the fibre cemboard detaches, the steel bolt resumes its function of resisting loading until it reaches the rapture behaviour. This is due to the bolt's stress distribution. It was discovered, however, that the crack propagates from the area of the steel bolt when the stress distribution accumulates and becomes greater than the yield stress. Meanwhile, steel bolts exhibit ductile behaviour, which increases bond-slip behaviour. Polyurethane glue can withstand loading and produce a high value of bearing resistance, whereas steel bolts have become an efficient feature in improving bond-slip behaviour.

Other than that, Wang et al. [33] conducted a four-point bending to find the mechanical performance of foam-filled lattice composite panel. From the experiment the findings show three type of failure mode such as top face sheet delamination, top face sheet compression failure, and core shear failure. The delamination phenomenon between the top face sheet and the foam core can be observed because the shear stress in the interface was greater than the adhesive strength. The presences of web in the sample the delamination failure can be avoided due to the improvement of the adhesive strength fibre cement board and the foam core.

## 4. Experimental Study

### 4.1 Design and Specifications

Bolted fibre cemboard panel is a combination of two layers of fibre cemboard that bonded together using different types of bond mechanism. The fibre cemboard is based on PRIMAflex, a product from Hume Cemboard Industries Sdn. Bhd. For the experimental testing, the dimension of fibre cemboard is 305 mm width, 1220 mm span and 2@16 mm thickness. Meanwhile, steel bolt and polyurethane glue are used as fasters to create the bond mechanics between two layers of fibre cemboard. The steel bolt has grade S275 (carbon steel) with 8 mm diameter, 8 mm head height and 100 mm length. The steel bolt spacing are 50 mm, 75 mm, 100 mm, 150 mm, and 200 mm. Fig. 5 illustrates the design of fibre cemboard panel with polyurethane glue and steel bolt.

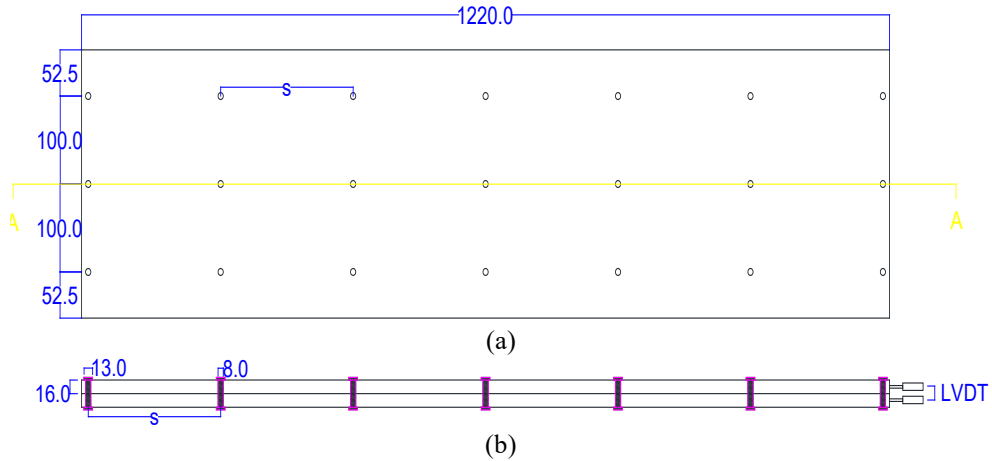

**Fig. 5 - Design of fibre cement board panel - (a) Plan view; and b) Cross-section view**

### 4.2 Materials and Specimens Preparation

Materials preparation of this study comprises of fibre cement board, steel bolt and polyurethane glue. Fig. 6 shows the required materials for the specimens. The fibre cement board is based on PRIMAflex which come with the original size of 1220 mm width, 2400 mm length and 16 mm thickness. Then, the fibre cement board is cut into individual components with size of 305 mm width, 1220 mm length and 16 mm thickness. Two layers of fibre cement board are stacked together using the designated bond mechanism, either using polyurethane glue, steel bolt or combination of polyurethane glue and steel bolt. For polyurethane glue, the specimens were embodied with the polyurethane glue at the marking lines according to the determined spacing. The polyurethane glue was placed at the bottom layer of fibre cement board, then attach to the top layer of fibre cement board and clamped to avoid gap between the two layers.

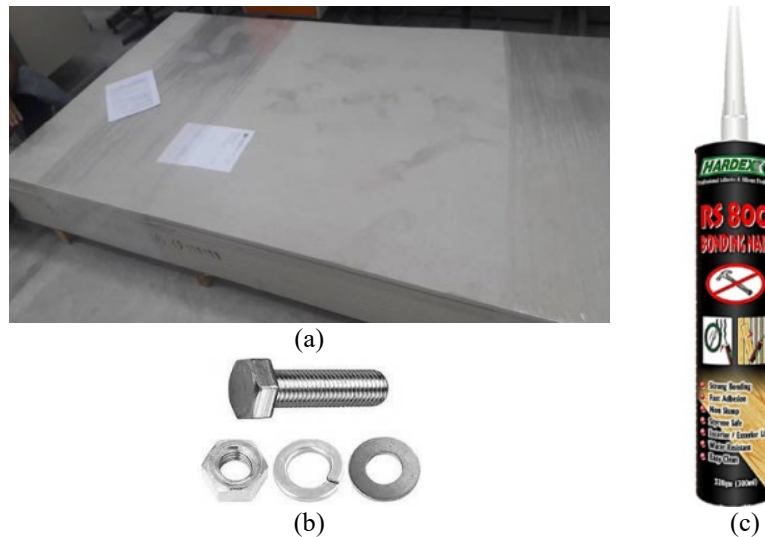

**Fig. 6 - Materials preparation: (a) Fibre cement board; (b) Steel bolt; and (c) Polyurethane glue**

For steel bolt, the fibre cement board must be drilled to create the holes. Steel bolt is installed based on the spacing of 50 mm, 75 mm, 100 mm, 150 mm, and 200 mm. Steel bolt must be tightened using bolt tightening machine until it reaches the torque if 90 Nm. The installation of steel bolt must be conducted carefully to ensure no cracks appear on the fibre cement board. For specimens with polyurethane glue and steel bolt as bond mechanism, the polyurethane glue was placed after the fibre cement board is drilled. After the polyurethane glue completely dry, the steel bolt is installed. The example of ready specimens can be seen in Fig. 7. Overall. There are 45 specimens that need to be fabricated as specified in Table 1.



**Fig. 7 - The example of bolted fibre cemboard panel**

**Table 1 - Details of specimens**

Bond Mechanism	Size	Spacing (mm)					Total
		50	75	100	150	200	
Polyurethane glue	1220 mm × 305 mm × 2@16 mm	3	3	3	3	3	15
Steel bolt		3	3	3	3	3	15
Polyurethane glue + steel bolt		3	3	3	3	3	15
<b>Total =</b>							<b>45</b>

### 4.3 Four-Point Bending Test

The specimens were tested under four-point bending test using Universal Testing Machine (UTM). The four-point bending test must be carried out according to BS EN 12390-5 (2002). The schematic drawing and actual arrangement of four-point bending test can be seen in Fig. 8. Steel supports used to hold the specimens are located 1050 mm apart and has 45 mm diameter. Meanwhile, two steel cylinders were placed at the top surface of specimens to distribute the applied force from the moveable crosshead of load cell. Thus, the specimens have had two points of applied force. The applied force is imposed based on the incremental stroke displacement at a constant loading rate of 0.5 mm/minute. While the force-time history is recorded directly from the load cell, the slip-displacement was measured using linear variable differential transformer (LVDT).

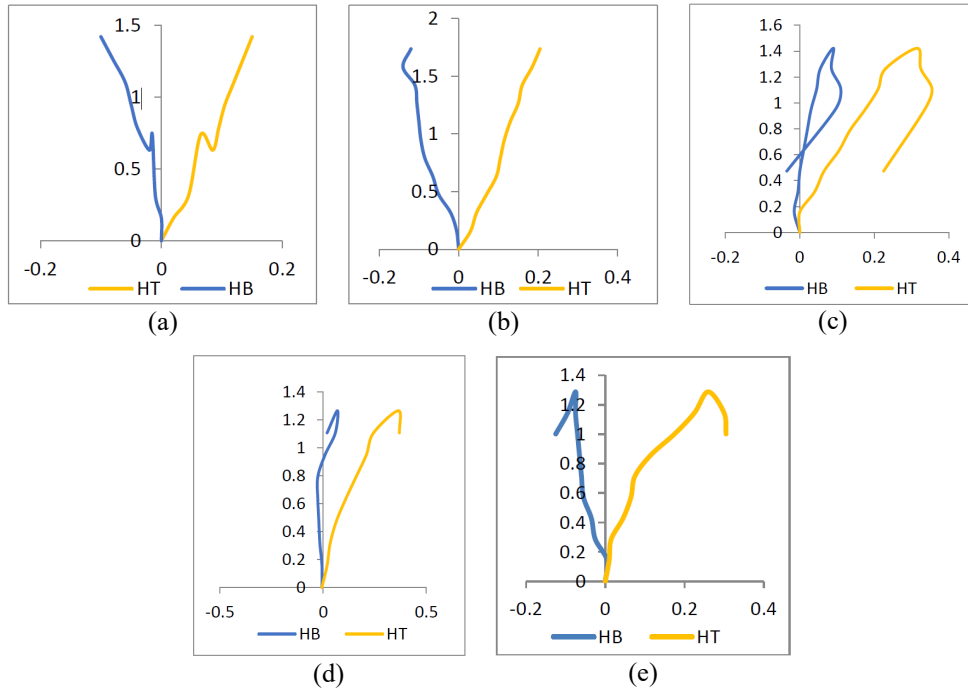

**Fig. 8 - Schematic arrangement of four-point bending test**

## 5. Results and Discussion

### 5.1 Force-Slip-Displacement Curves

Fig. 9 shows the force-slip displacement curves for the specimens that were fabricated using polyurethane glue. Based on the four-point bending test, the maximum force represents the ultimate capacity or specifically refer as the bearing resistance. Meanwhile, the slip displacement is a horizontal movement of fibre cement board due to the difference in the tension and compression behaviour. It can be observed that the top layer of fibre cement board experiences a larger slip displacement than the bottom layer. It should be noted here that the orange line represents the force-slip displacement curves of the bottom layer, whilst the blue line represents the force-slip displacement curves of the top layer. In terms of force, polyurethane glue contributes to the bearing resistance around 1.2 kN to 1.4 kN. Some specimens, especially those with 75 mm and 200 mm spacings, attain entirely brittle behaviour, while others display plastic-hardening behaviour.



**Fig. 9 - Force versus slip-displacement of fiber cementboard panels with polyurethane glue at spacing, (a) 50 mm; (b) 75 mm; (c) 100 mm; (d) 150 mm; and (e) 200 mm**

Fig. 10 shows the force-slip displacement curves of specimens that have the steel bolt as the bond mechanism. It can be observed that as the applied force is imposed on the top layer of the fibre cementboard, both force and slip displacement have raised results until the fibre cementboard panel is either facing cracking, rupture, or detachment. For the fibre cementboard panel bonded by steel bolt, the failure is due to the coinciding of stress concentration and slip-displacement. This is proof that the top and bottom layers of fibre cementboard act as a partially composite structure. The negative value of slip displacement arising at the bottom layer indicates the tension behaviour. The elongation of the fibre cementboard pushes the LVTD to the negative measurement. This phenomenon is similar to that found by Loehr et al. [34], where the lower part of the composite structure always behaves in tension.

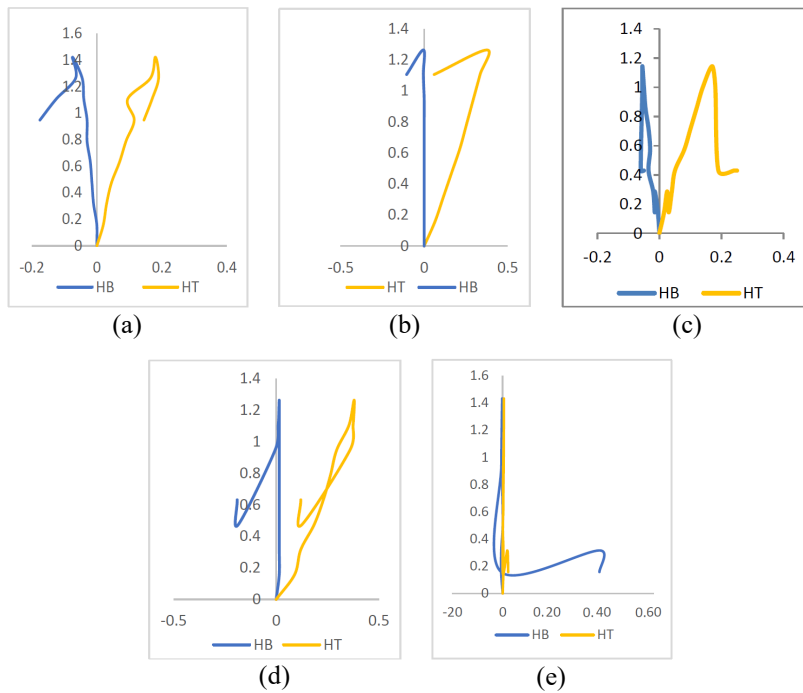

**Fig. 10 - Force versus slip-displacement of fiber cementboard panels with steel bolt at spacing, (a) 50 mm; (b) 75 mm; (c) 100 mm; (d) 150 mm; and (e) 200 mm**



Fig. 11 shows the force-slip displacement curves of specimens that were fabricated using combined bond mechanism (polyurethane glue + steel bolt). Like the specimens with polyurethane glue and the specimens with steel bolt, the combined bond mechanism produces similar behaviour of force-slip displacement curves. However, the combined bond mechanism on fibre cemboard panel shows the best results of force-slip displacement curves. Despite the smooth applied force, the graph that was plotted has a staggered pattern. This happen due to the fact the load from the applied force was held first by the polyurethane glue, and then disseminate to the steel bolt. The slip displacement that occurs on these specimens was identified as not exceeding 0.3 mm. It can be said that the polyurethane glue controls the slip displacement before the detachment, and then the steel bolt takes the action to hold the specimens from further sliding.

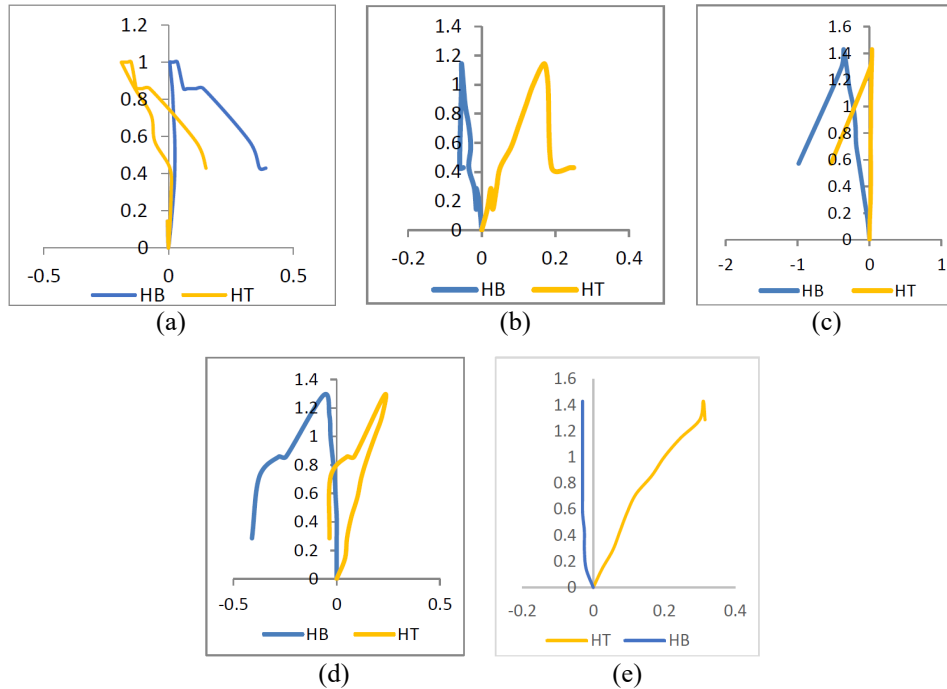
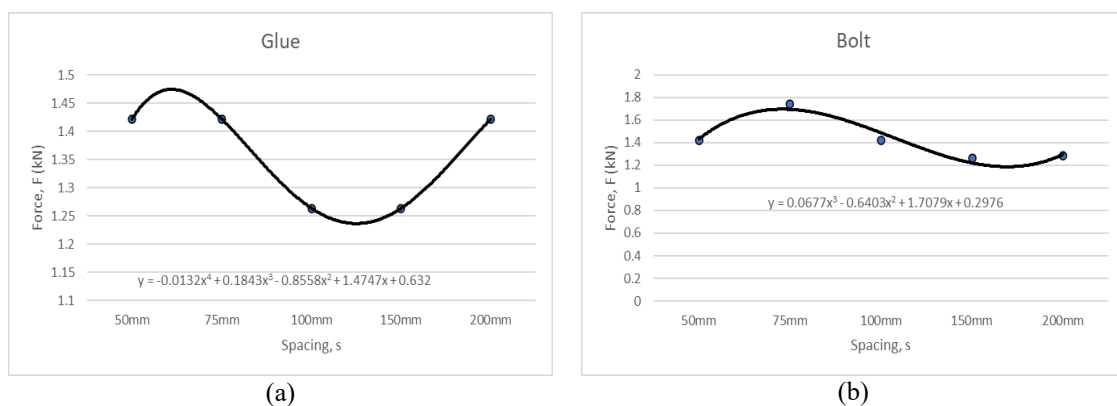
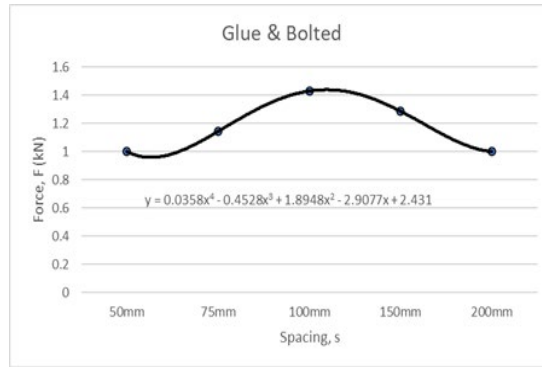

Fig. 11 - Force versus slip-displacement of fiber cemboard panels with polyurethane glue + steel bolt at spacing, (a) 50 mm; (b) 75 mm; (c) 100 mm; (d) 150 mm; and (e) 200 mm

## 5.2 Effects of Bond Mechanism

Fig. 12 shows the force in corresponds to the spacing of bond mechanism for the fibre cemboard panels. It should be emphasized here that the force can be referred as the bearing resistance acting in the horizontal direction. It was found from the experimental testing that different bond mechanisms yield different values of bearing resistance. This observation is identical to that obtained by Norhalim & Jaini [23] for the fibre cemboard samples subjected to push-out test. Bond mechanism manifests the condition of contact surface and friction between the structure. Take 50 mm spacing for instance, the specimens used polyurethane glue have the highest force at 1.42 kN, while the steel bolt at 1.74 kN and the combined bond mechanism reaches 1.14 kN. Despite that, 75 mm spacing causes the highest force for the fibre cemboard panel bonded by steel bolt, while 100 mm spacing happens to produce highest force for the fibre cemboard panel with combined bond mechanism.





(c)

**Fig. 12 - Force versus spacing for fibre cemboard panels with bond mechanism: (a) polyurethane glue; (b) steel bolt; and (c) polyurethane glue + steel bolt**

Apparently, the spacing also has the substantial impact on the bearing resistance. Close distance of spacing may increase the stiffness that appreciably contribute to the good performance. Jaini et al. [21] stated that the smaller the spacing, the higher the force that can be sustained by the structure. However, close distance of spacing may cause the specimens to experience premature failure due to the structure becomes too rigid and the stress concentration excessively surrounded the steel bolt. For the fibre cemboard panel with polyurethane glue, the trend of force toward spacing is obvious. As the spacing getting bigger, the force is decreased significantly. Similar pattern can be observed on the fibre cemboard panel bonded by steel bolt. For the fibre cemboard panel with combined bond mechanism, the force is increased as the spacing changes from 50 mm to 100 mm. Beyond that, the force is decreased irresistibly.

The relation between force and spacing for the fibre cemboard panel with different bond mechanisms can be presented by the best-fitted line of polynomial functions. The following are simple empirical equation that can be used to predict the bearing resistance of fibre cemboard panel:

$$F_B = -0.0132S^4 + 0.1843S^3 - 0.8558S^2 + 1.4747S + 0.632 \tag{1}$$

$$F_B = 0.0677S^3 - 0.6403S^2 + 1.7079S + 0.2976 \tag{2}$$

$$F_B = 0.0358S^4 - 0.4528S^3 + 1.8948S^2 - 2.9077S + 2.431 \tag{3}$$

where  $F_B$  is the bearing resistance and  $S$  is the spacing. Eq. (1), Eq. (2) and Eq. (3) are specific for the fibre cemboard panel with polyurethane glue, steel bolt, and combined bond mechanism, respectively. The limitation of above-mentioned equations is that it only suitable for the fibre cemboard with size of 305 mm width, 1220 mm span and 2@16 mm thickness (as used in this study).

Fig. 13 shows the slip displacement in corresponds to the spacing of bond mechanism. It should be noted that this study concentrates on three different bond mechanisms, namely the polyurethane glue, steel bolt and polyurethane glue + steel bolt (latter known as combined bond mechanism). For the polyurethane glue, it is clearly understood that spacing gave influence on the slip displacement. Jaini et al. [21] and Loehr et al. [34] mentioned that bigger spacing cause slip displacement to be at a greater rate. It was observed from the experimental testing that the slip displacement becomes higher as the spacing getting bigger. The highest slip displacement is recorded by 200 mm spacing at 0.45 mm, where the top layer of fibre cemboard suffer higher slip displacement than the bottom layer. The slip displacement occurs due to the detachment of top and bottom layers of fibre cemboard as the polyurethane glue losses the strength and suffers rapture.

In the fibre cemboard panel bonded by steel bolt, the slip displacement becomes larger as the spacing increases from 50 mm to 150 mm. The highest slip displacement is 0.37 mm, approximately 18% lower than the fibre cemboard panel with polyurethane glue. At 200 mm spacing, the slip displacement shows a little decrement. The slip displacement occurs due to the aftermath of cracking that initiate from one hole to another. As the cracking completely propagate to both ends, the fibre cemboard panel breakup into two segments. Notwithstanding the evidence, the steel bolt remains intact, and yielding was not observed during the breakup. Close distance of spacing has caused the fibre cemboard panel become too rigid and breakup easily. This is what exactly happens to 50 mm and 75 mm spacings.

In the combined bond mechanism, the stress concentration is carried by the polyurethane glue during the initial loaded phase. When the polyurethane glue failed and the fibre cemboard detached, the steel bolt resumes the function in resisting the sliding. The rapture occurs because of stress concentration that instigate the cracking. It was discovered that the propagation of cracking from the area of steel bolt happen when the stress concentration greater than the yield stress. For 50 mm spacing, the slip displacement is higher in the combined bond mechanism as compared to the polyurethane glue or the steel bolt. The highest slip displacement was recorded on 100 mm spacing at 0.38 mm, which

is 2.7% higher than the fibre cemboard panel bonded by steel bolt. In the combined bond mechanism, the polyurethane glue can withstand higher applied force, whereas the steel bolt has become an efficient feature in improving slip-displacement.

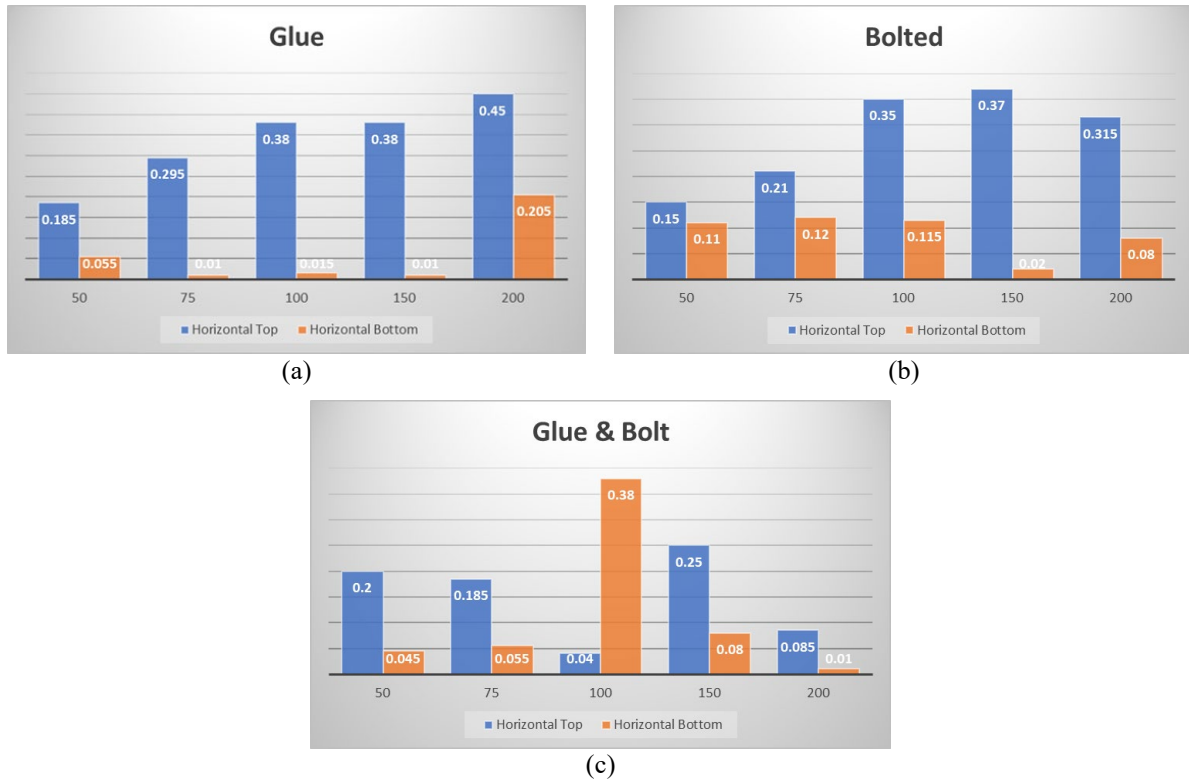

**Fig. 13 - Slip displacement versus spacing of fibre cemboard panel with bond mechanism - (a) polyurethane glue; (b) steel bolt; and (c) polyurethane glue + steel bolt**

## 6. Conclusion

This study presents an extensive investigation of the force and slip displacement of fibre cemboard panels under four-point bending test. The specimens were tested using Universal Testing Machine (UTM). The results of force were obtained from the load cell, whilst the results of slip displacement were measured using two sets of the linear variable differential transformer (LVDT). From the experimental testing, the force-slip displacement curves were successfully plotted. It was found that some specimens have brittle behaviour, while others exhibit plastic-hardening behaviour. Fibre cemboard panels bonded by steel bolts exhibit the best performance in terms of force and slip displacement.

The maximum force obtained from the experimental testing is considered as the ultimate load-bearing capacity that represents the ability of the specimens to sustain the applied load. Meanwhile, the bond mechanism shows the state of contact surface. Different bond mechanisms produce different values of maximum force. The highest maximum force was produced by the fibre cemboard panels bonded by steel bolts. Through the experimental testing, it was discovered that the spacing has an apparent impact on the force. Close distance of spacing may increase the stiffness that appreciably contributes to good structural behaviour. Based on the results, 50 mm is the optimum spacing for the polyurethane glue, while steel bolts and combined bond mechanism should have 100 mm and 150 mm spacings.

The spacing also has profound effects on the slip displacement. The greater the spacing, the binger the slip displacement. However, this trend is only true for the fibre cemboard panels bonded by polyurethane glue. For the specimens with steel bolts or combined bond mechanism, the increment of slip displacement occurs for 50 mm to 100 mm spacing. Beyond that, the slip displacement shows a decrement trend. During the initial loaded phase, the polyurethane glue can hold the stresses effectively. When the polyurethane glue fails and the fibre cemboard experiences detachment, the steel bolts take over the role to resist the slip displacement.

## Acknowledgement

This research was supported by Universiti Tun Hussein Onn Malaysia through Geran Penyelidikan Pascasiswazah, GPPS (Vot H533).

## References

- [1] Bodnarova, L., Hosko, M., & Martinec, P. (2018). Methods of testing the properties of fibre-cement composites. *IOP Conference Series: Materials Science and Engineering*, 385, 012005.
- [2] Ismail, N. N., & Jaini, Z. M. (2021). Effect of ply thickness on the bearing capacity of bolted-fiber cemboard: Numerical modelling using FEM. *Recent Trends in Civil Engineering and Built Environment*, 2(1), 508-517.
- [3] Sonphuak, W., & Rojanarowan, N. (2013). Strength improvement of fibre cement product. *International Journal of Industrial Engineering Computations*, 4(4), 505-516.
- [4] Shawia, N. B., Jabber, M. A., & Mamouri, A. F. (2014). Mechanical and physical properties of natural fiber cement board for building partitions. *Physic Science Research International*, 2(September), 49-53.
- [5] Singh, A., Singh, J., & Ajay, S. (2018). Properties of fiber cement boards for building partitions. *International Journal of Applied Engineering Research*, 13(10), 8486-8489.
- [6] Ranachowski, Z., & Schabowicz, K. (2018). *The fabrication, testing and application of fibre cement boards*. Cambridge Scholar Publishing.
- [7] Lu, S. K., Hua, D. X., Li, Y., Cui, F. Y., & Li, P. Y. (2019). Stiffness calculation method and stiffness characteristic analysis of bolted connectors. *Mathematical Problems in Engineering*, 2019, 6206092.
- [8] Jamshidi, M., Pakravan, H. R., & Pacheco-Torgal, F. (2013). Assessment of the durability performance of fiber-cement sheets. *Journal of Materials in Civil Engineering*, 25(6), 819-823.
- [9] Akhavan, A., Catchmark, J., & Rajabipour, F. (2017). Ductility enhancement of autoclaved cellulose fiber reinforced cement boards manufactured using a laboratory method simulating the Hatschek process. *Construction and Building Materials*, 135, 251-259.
- [10] Khedari, J., Suttisonk, B., Pratinthong, N., & Hirunlabh, J. (2001). New lightweight composite construction materials with low thermal conductivity. *Cement and Concrete Composites*, 23(1), 65-70.
- [11] Abdel-Kader, A. H., & Darweesh, H. H. (2010). Setting and hardening of agro/cement composites. *BioResources*, 5(1), 43-54.
- [12] Mukhametrakhimov, R., & Lukmanova, L. (2018). The modified fiber cement panels for civil construction. *Advances in Intelligent Systems and Computing*, 692, 852-858.
- [13] Da Costa Correia, V., Santos, S. F., & Savastano, H. (2018). Vegetable fiber as reinforcing elements for cement based composite in housing applications - A Brazilian experience. *MATEC Web of Conferences*, 149, 01007.
- [14] Ahmad, Z., Wee, L. S., & Fauzi, M. A. (2011). Mechanical Properties of Wood-wool Cement Composite Board Manufactured Using Selected Malaysian Fast Grown Timber Species. *Science Journal*, 5(1), 27-35.
- [15] Karade, S. R. (2011). Developments in cement-bonded composite material technology. *National Seminar on Modern Trends in Architectural and Civil Engineering Practices*, pp. 57-64.
- [16] Wypych, G. (2013). Testing methods of weathered specimen. *Handbook of Material Weathering*, 10, 277-350.
- [17] Noor Azammi, A. M., Ilyas, R. A., Sapuan, S. M., Ibrahim, R., Atikah, M. S. N., Asrofi, M., & Atiqah, A. (2019). 3-characterization studies of biopolymeric matrix and cellulose fibres based composites related to functionalized fibre-matrix interface. In Goh, K. L., Aswathi, M. K., De Silva, R. T., & Thomas, S (eds.), *Interfaces in Particle and Fibre Reinforced Composites*. Wood Publishing.
- [18] Khorami, M., & Ganjian, E. (2011). Comparing flexural behaviour of fibre-cement composites reinforced bagasse: Wheat and eucalyptus. *Construction and Building Materials*, 25(9), 3661-3667.
- [19] Khorami, M., Ganjian, E., Mortazavi, A., Saidani, M., Olubanwo, A., & Gand, A. (2017). Utilisation of waste cardboard and Nano silica fume in the production of fibre cement board reinforced by glass fibres. *Construction and Building Materials*, 152, 746-755.
- [20] Pan, H., & Liu, Y. (2009). Properties of natural fiber cement boards for building partitions. *Challenges, Opportunities and Solutions in Structural Engineering and Construction*, 13(10), 8486-8489.
- [21] Jaini, Z. M., Mokhatar, S. N., Hadipramana, J., & Abu Seman, M. (2020). Dynamic responses of sandwich cemboard-foamed concrete panels subjected to low-velocity impact. *IOP Conference Series: Materials Science and Engineering*, 713, 012025.
- [22] Sutiman, N. A., Majid, M. A., Jaini, Z. M., & Roslan, A. S. (2021). Structural behavior of lightweight composite slab system. *International Journal of Integrated Engineering*, 13(3), 57-65.
- [23] Norhalim, A. F., & Jaini, M. Z. (2020). Bearing resistance and failure mode of bolted-layered cemboard panels. *International Journal of Integrated Engineering*, 12(9), 149-160.
- [24] Ahmed, E., & Badaruzzaman, W. H. W. (2013). Vibration performance of profiled steel sheet dry board composite floor panel. *KSCE Journal of Civil Engineering*, 17(1), 133-138.
- [25] Melcher, J., Karmazinová, M., & Pilgr, M. (2013). Evaluation of strength characteristics of fibre-cement slab material. *Advanced Materials Research*, 650, 320-325.
- [26] Fragiaco, M., & Lukaszewska, E. (2011). Development of prefabricated timber-concrete composite floor systems. *Proceedings of the Institution of Civil Engineers - Structures and Buildings*, 164(2), 117-129.
- [27] Yeoh, D., Fragiaco, M., De Franceschi, M., & Heng Boon, K. (2011). State of the art on timber-concrete composite structures: Literature review. *Journal of Structural Engineering*, 137(10), 1085-1095.

- [28] Ismail, S., Abdullah, R., & Ahmad, Z. (2017). Finite element modeling and analysis of sandwich dry floor slab. *International Journal of Civil & Environmental Engineering*, 17(February), 21-26.
- [29] Seraji, M., Wan Badaruzzaman, W. H., & Osman, S. A. (2013). Membrane action in profiled steel sheeting dry board (PSSDB) floor slab system. *Journal of Engineering Science and Technology*, 8(1), 57-68.
- [30] Al-Shaikhli, M. S., Wan Badaruzzaman, W. H., Baharom, S., & Al-Zand, A. W. (2017). The two-way flexural performance of the PSSDB floor system with infill material. *Journal of Constructional Steel Research*, 138, 79-92.
- [31] Auclair, S. C., Sorelli, L., & Salenikovich, A. (2016). A new composite connector for timber-concrete composite structures. *Construction and Building Materials*, 112, 84-92.
- [32] Sjölander, A., Hellgren, R., Malm, R., & Ansell, A. (2020). Verification of failure mechanisms and design philosophy for a bolt-anchored and fibre-reinforced shotcrete lining. *Engineering Failure Analysis*, 116, 104741.
- [33] Wang, L., Liu, W., Wan, L., Fang, H., & Hui, D. (2014). Mechanical performance of foam-filled lattice composite panels in four-point bending: Experimental investigation and analytical modeling. *Composites Part B: Engineering*, 67, 270-279.
- [34] Loehr, W., Zhang, B., Melhem, H., & Kramer, K. (2017). Influence of fastener spacing on the slip modulus between cold formed steel and wood sheathing. *Structures Congress 2017: Buildings and Special Structures*. American Society of Civil Engineers.