

Buckling test of stiffened panels: evaluation of post-buckling and failure by testing and layerwise models

Original

Buckling test of stiffened panels: evaluation of post-buckling and failure by testing and layerwise models / Augello, R.; Pagani, A.; Carrera, E.; Peeters, D.; do Prado, A. P.; Santos, H. E.; Galeb, P. H.; Cabral, P. H.. - (2022). ((Intervento presentato al convegno 20th European Conference on Composite Materials (ECCM20) tenutosi a Lausanne, Switzerland nel 26-30 June 2022.

Availability:

This version is available at: 11583/2970441 since: 2022-08-03T10:32:29Z

Publisher:

ECCM20

Published

DOI:

Terms of use:

openAccess

This article is made available under terms and conditions as specified in the corresponding bibliographic description in the repository

Publisher copyright

(Article begins on next page)

BUCKLING TEST OF STIFFENED PANELS: EVALUATION OF POST-BUCKLING AND FAILURE BY TESTING AND LAYERWISE MODELS

R. Augello^a, A. Pagani^a, E. Carrera^a, D. M. J. Peeters^b, A. Prado^c, H. E. A. A. Santos^d, P. H. Galeb^e, P. H. Cabral^c

^a MUL2, Department of Mechanical and Aerospace Engineering, Politecnico di Torino, Torino, Italy

^b Delft University of Technology, faculty of Aerospace Engineering, section: Aerospace Structures and Computational Mechanics, Delft, Netherlands

^c Embraer S.A., São José dos Campos, Brazil

^d Instituto Tecnológico de Aeronáutica, São José dos Campos, Brazil

^e Universidade Federal de Itajubá, Itajubá, Brazil

Abstract: *The present paper deals with the buckling and post-buckling analysis of a multilayered composite reinforced panel. The panel, designed for aeronautical applications, results in a complex stacking sequence, and the development of a refined model able to describe its geometrical nonlinear behavior is mandatory to avoid the usage of highly computational effort-required 3D finite elements. The proposed approach is a finite element analysis based on the Carrera Unified Formulation (CUF). Thanks to CUF, a 1D model of the composite panel can be formulated and complicated stress fields within the structure can be evaluated, so that the nonlinear behavior is fully described. A refined Equivalent Single Layer (ESL) technique is employed, making use of Lagrange polynomials for the description of the stacking sequence. The results clearly demonstrate the reliability of this approach, comparing the linearized buckling and nonlinear post-buckling solutions with those from Nastran (1D, 2D and 3D) and experiments.*

Keywords: Post-Buckling; Reinforced Panel; Multilayered structure; Geometrical Nonlinear Analysis; Carrera Unified Formulation.

1. Introduction

The design of reinforced composite aerospace structures and the choice of safety margins are strongly affected by our predictive capability. The analysis of buckling and many other failure mechanisms requires the use of mathematical models able to capture 3D complex internal stress states, which is a major concern in composite laminates and represents a challenge of today structural simulations. For this reason, scientists have focused on the development of mathematical models able to cut down the computational effort required for the analysis while maintaining a high level of accuracy.

In the present work, we use a detailed model to characterize the post-buckling behavior and the stress state of a stringer-reinforced composite wing panel subjected to uniform compression. The model under consideration has layerwise capabilities and is based on the Carrera Unified Formulation (CUF) [1]. According to CUF, refined structural theories can be formulated automatically as a generalization of the three-dimensional equilibrium equations and by making use of arbitrary expansion of the primary unknowns, which can be either distributed along 1D

(CUF beam models) or 2D (CUF plate models) supports. Depending on the choice of the expansion functions, low- to high-order structural theories can be used in a unified manner. In this work, for example, we employ a piecewise description of the cross-section kinematics by Lagrange polynomials. These models have been demonstrated to be highly efficient and effective for the simulation of laminates in both linear and nonlinear regimes [2,3] and satisfy the C_z^0 requirements [4].

2. Numerical model of the reinforced panel

The geometry of the numerical model of the analyzed reinforced panel is presented in Fig. 1, where $h_1 = 9.52$ mm, $h_2 = 39.3$ mm, $h_3 = 3.66$ mm, $t = 7.3$ mm, $b = 270$ mm, $b_1 = 70$ mm, $l_1 = 50$ mm and $l = 690$ mm. The dark gray zones shown in Fig. 1 represent the experimental blocks which were used to apply the external load and to constrain the panel. Moreover, Fig. 1 shows the stacking sequence of the material, which properties are $E_1 = 119$ GPa, $E_2 = 9.8$ GPa, $E_3 = 4.67$ GPa, $\nu_{12} = 0.316$, $\nu_{13} = 0.26$, $\nu_{23} = 0.33$, $G_{12} = 4.7$ GPa, $G_{13} = G_{23} = 1.76$ GPa and $\rho = 1580$ kg/m³. It should be noted that the out-of-plane properties were assumed, since they were not available from the manufacturer.

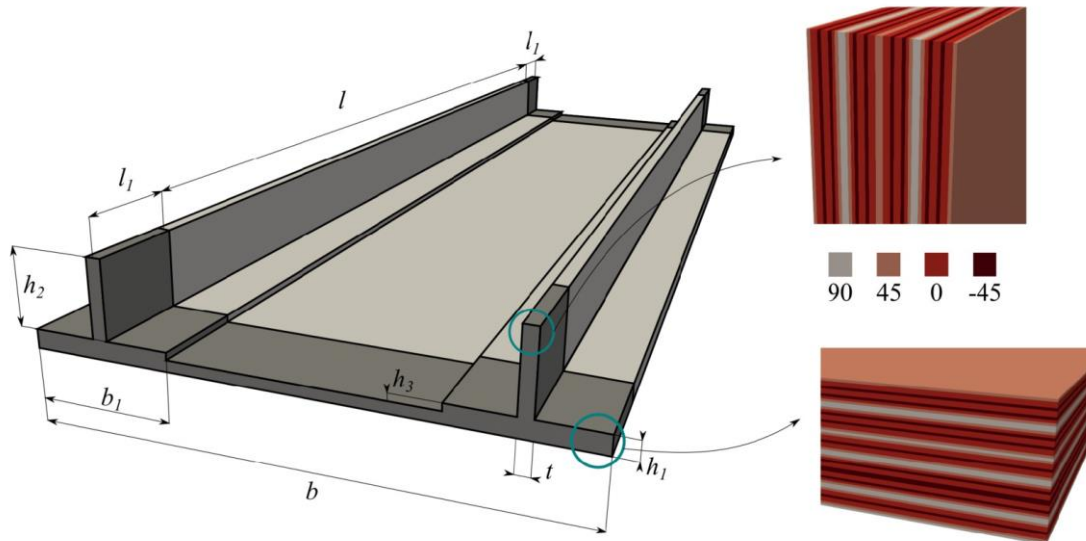

Figure 1. Geometry and stacking sequence of the composite stiffened panel.

In order to develop the Finite Element (FE) model of the stiffened composite panel, the Carrera Unified Formulation (CUF) is recalled. CUF is used in this paper for the derivation of the geometrical nonlinear governing equation. According to CUF and Fig. 2, the three-dimensional displacement field $\mathbf{u}(x, y, z)$ of the panel can be written as follows:

$$\mathbf{u}_k(x, y, z) = F_\tau(x, z)N_i(y)\mathbf{q}_{k\tau i} \quad \tau = 1, 2, \dots, M \quad i = 1, 2, \dots, N_n$$

where y is placed in the longitudinal direction of the panel, (x, z) are the coordinates of the cross-section, $\mathbf{q}_{k\tau i}$ is the vector of the nodal unknowns evaluated at each of the N_n node at the k – th layer level; $N_i(y)$, shown in blue in Fig. 2, represents the shape functions in the y direction; and $F_\tau(x, z)$, shown in red in Fig. 2, are the expansion functions of the cross-sectional area. Repeating indexes denote summation.

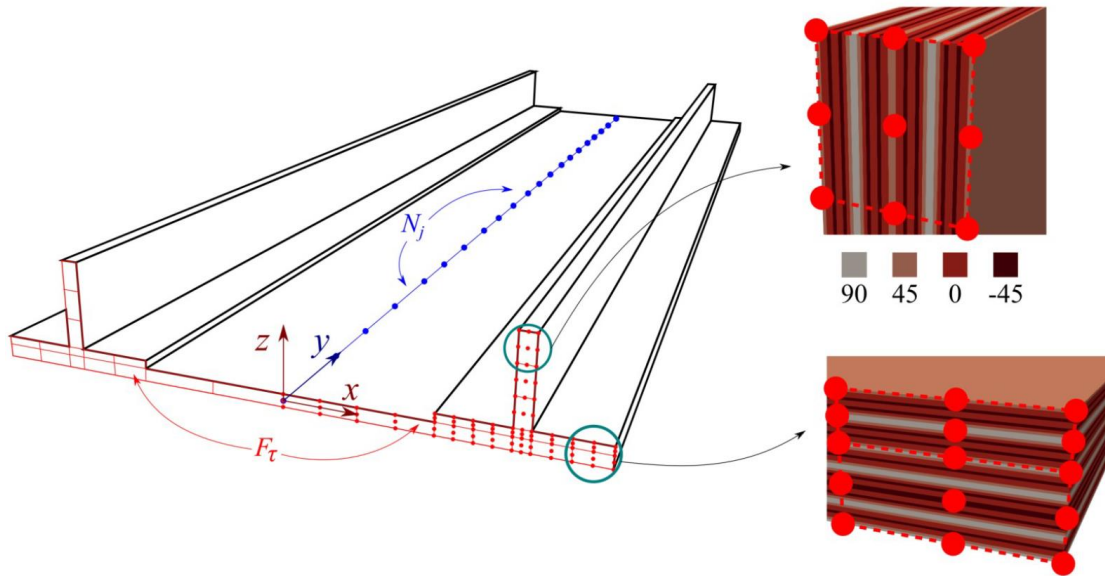

Figure 2. Mathematical 1D CUF model of the composite stiffened panel.

In this work, refined models are employed by using quadratic Lagrange Expansions. This expansion function, introduced in [2], makes use of opportune quadratic interpolation of the variables evaluated at the Lagrange Point (the red circles in Fig. 2). The interpolation functions are based on Lagrange polynomials, and they denote the order of the expansion (quadratic in this work). The Lagrange points can be used to define any geometric shape and, as in this work, to denote the domain of each layer in the classical Layer-Wise (LW) approach and of a group of plies in the refined Equivalent Single Layer (ESL) approach, as shown in Fig. 2.

2.1 Nonlinear governing equations

The stress, $\boldsymbol{\sigma}$, and strain, $\boldsymbol{\varepsilon}$, components are expressed in vectorial form with no loss of generality,

$$\boldsymbol{\sigma} = \{\sigma_{xx} \ \sigma_{yy} \ \sigma_{zz} \ \sigma_{xz} \ \sigma_{yz} \ \sigma_{xy}\}^T \quad \boldsymbol{\varepsilon} = \{\varepsilon_{xx} \ \varepsilon_{yy} \ \varepsilon_{zz} \ \varepsilon_{xz} \ \varepsilon_{yz} \ \varepsilon_{xy}\}^T$$

As far as the geometrical relations are concerned, the Green-Lagrange nonlinear strain components are considered. Therefore, the displacement-strain relations are expressed as

$$\boldsymbol{\varepsilon} = \boldsymbol{\varepsilon}_l + \boldsymbol{\varepsilon}_{nl} = (\mathbf{b}_l + \mathbf{b}_{nl})\mathbf{u}$$

where \mathbf{b}_l and \mathbf{b}_{nl} are the linear and nonlinear differential operators. Regarding the constitutive relations, linear elastic material is assumed in this work, thus Hooke's law can be employed:

$$\boldsymbol{\sigma} = \mathbf{C}\boldsymbol{\varepsilon}$$

where \mathbf{C} is the material matrix, whose complete form can be found in [5].

In this work, the principle of virtual work is recalled for the derivation of the FE governing equations, which, for a generic structure, can be expressed as:

$$\delta L_{int} = \delta L_{ext}$$

where δL_{int} is the virtual variation of the work of the internal loads (i.e., the strain energy) and δL_{ext} is the virtual variation of the work of the external loads.

The first term of the previous equation can be written as:

$$\delta L_{int} = \int_V \delta \boldsymbol{\varepsilon}^T \boldsymbol{\sigma} dV$$

where V is the volume of the body. Introducing the geometrical and constitutive relations, it takes the following form:

$$\delta L_{int} = \delta \mathbf{q}_{sj}^T \mathbf{K}_S^{ij\tau s} \mathbf{q}_{\tau i}$$

The argument of the integral represents the so-called secant stiffness matrix $\mathbf{K}_S^{ij\tau s}$. Its complete form is omitted here for the sake of brevity, but can be found in [3,6].

The right term of the principle of virtual work, omitting some mathematical steps that can be found in Carrera et al. [1], can be written as:

$$\delta L_{ext} = \delta \mathbf{q}_{sj}^T \mathbf{p}_{sj}$$

so that

$$\mathbf{K}_S^{ij\tau s} \mathbf{q}_{\tau i} - \mathbf{p}_{sj} = 0$$

The previous equation can be arbitrarily expanded to reach any desired theory, from low- to higher-order ones, by choosing the values for $\tau, s = 1, 2, \dots, M$ and $i, j = 1, 2, \dots, p + 1$ to give:

$$\mathbf{K}_s \mathbf{q} - \mathbf{p} = 0$$

where \mathbf{K}_s , \mathbf{q} , and \mathbf{p} are the global, assembled finite element arrays of the final structure. The final equation represents a nonlinear algebraic system of equation for which an alternative method is needed. We employ here the same procedure detailed in the work by Pagani and Carrera [6], where a Newton-Raphson scheme is derived by making use of a path following constraint. The main steps of the procedure are explained in this work. This procedure demands for the linearization of the nonlinear governing equations. As a result, we need to introduce the so-called tangent stiffness matrix $\mathbf{K}_T = \frac{d(\mathbf{K}_s \mathbf{q} - \mathbf{p})}{d\mathbf{q}}$. The explicit form of \mathbf{K}_T is not given here, but it is derived in a unified form in [7]. The resultant system of equations needs to be constrained. In this work, an opportune arc-length path-following constraint is adopted. More detail about the arc-length method adopted can be found in the works by Carrera [8] and Crisfield [9,10].

2.2 Refined equivalent single layer

In this paper, a refined equivalent single layer technique for the description of the composite panel is proposed. This approach makes use of the variable kinematics characteristics of CUF formalism. In fact, one can introduce refined mechanical theories with computational efficiency by opportunely using Lagrange polynomials. In this technique, the model of the composite structure is built to have a group of plies with the ESL assembling approach (homogenizing the mechanical properties), as depicted in Fig. 2. In addition, Fig. 3 summarizes the assembling technique using ESL. Clearly, despite the larger number of plies, the assembling procedure does

not require a huge computational effort, compared to the LW assembling, which is described in Fig. 4.

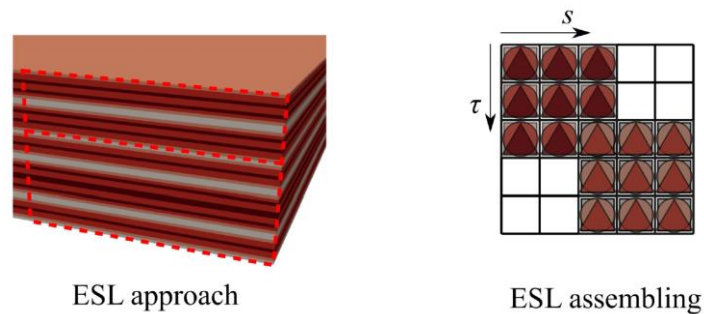

Figure 3. ESL approaches for the composite stiffened panel.

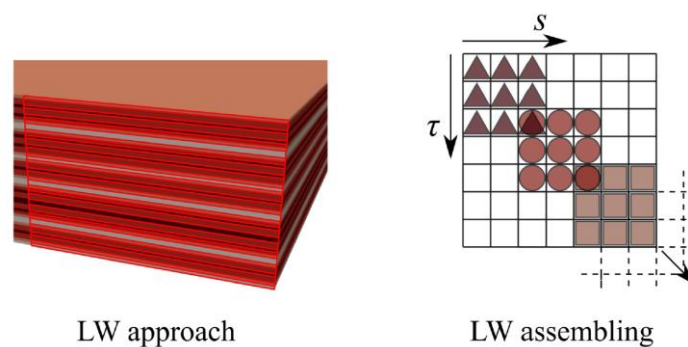

Figure 4. LW approaches for the composite stiffened panel.

3. Numerical results

The numerical results report the linearized buckling analysis of the stiffened panel, comparing the results from experiments to those obtained using LW and refined ESL models. Finally, the main post-buckling solutions, using the refined ESL model, are given and compared to the experimental results and those using Nastran 2D, 2D (skin) +1D (stringers), and 3D formulations. The details of the experimental setup are given in [11]. Briefly, 3 panels were manufactured, as depicted in Fig. 5. and the shortening was measured using two linear vertical displacement transducers (LVDT): one was placed on each side of the panel to ensure the panel was loaded in pure compression and no moment was induced on it.



Figure 5. Three manufactured stiffened panel and experimental buckling setup.

3.1 Linearized buckling

The first buckling load evaluated with experimental data, LW and refined ESL models is reported in Table 1.

Table 1: Measured buckling load and comparison between experimental results and numerical simulation.

Model	Buckling load, kN	DOF	Error %
Experimental	744.68	-	-
LW	739.17	715365	0.03 %
Refined ESL	744.12	10521	0.64 %

The buckling load is perfectly evaluated by the proposed model, compared to the experimental results, and with a significant gain on the computational cost, compared to the LW model. Moreover, Table 2 reports the first four buckling modes numerically evaluated with LW and refined ESL. Error % is obtained comparing to the average of tests.

Table 2: Measured buckling load and comparison between LW and refined ESL models.

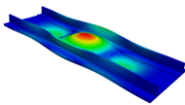
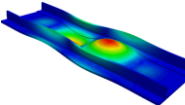
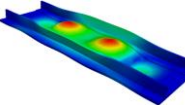
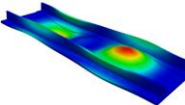
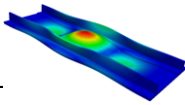
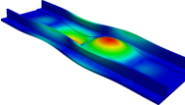
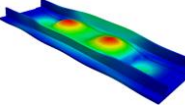
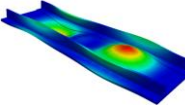
Model	Buckling mode 1	Buckling mode 2	Buckling mode 3	Buckling mode 4
LW	 739.17 kN	 744.86 kN	 809.42 kN	 829.87 kN
Refined ESL	 744.12 kN	 749.96 kN	 815.78 kN	 836.96 kN
<i>Diff %</i>	0.67 %	0.68 %	0.79 %	0.85 %

It can be concluded that the proposed refined ESL model can evaluate the buckling behavior of the structure with a reliable accuracy while increasing the computational cost.

3.2 Nonlinear post-buckling

Post-buckling results are discussed hereafter. The described refined ESL model is used for the geometrical nonlinear analysis. The results are compared with those from experiments and Nastran models. The adopted Nastran models are 3:

- Mixed 1D and 2D model for the modelling of the stringers and the skin, respectively. Degrees of Freedom (DOFs): 16746;

- Full 2D model. DOFs: 22146;
- Full 3D model. DOFs: 159570.

Nastran sol400 was used for the analysis. The results in terms of end shortening are depicted in Fig. 6 and listed in Table 3. Clearly, Nastran 1D and 2D models are not able to describe the buckling and post-buckling behavior of the stiffened panel, as the estimated buckling load is higher than the one from experimental setup. On the contrary, Nastran 3D, CUF and experimental results are close to each other

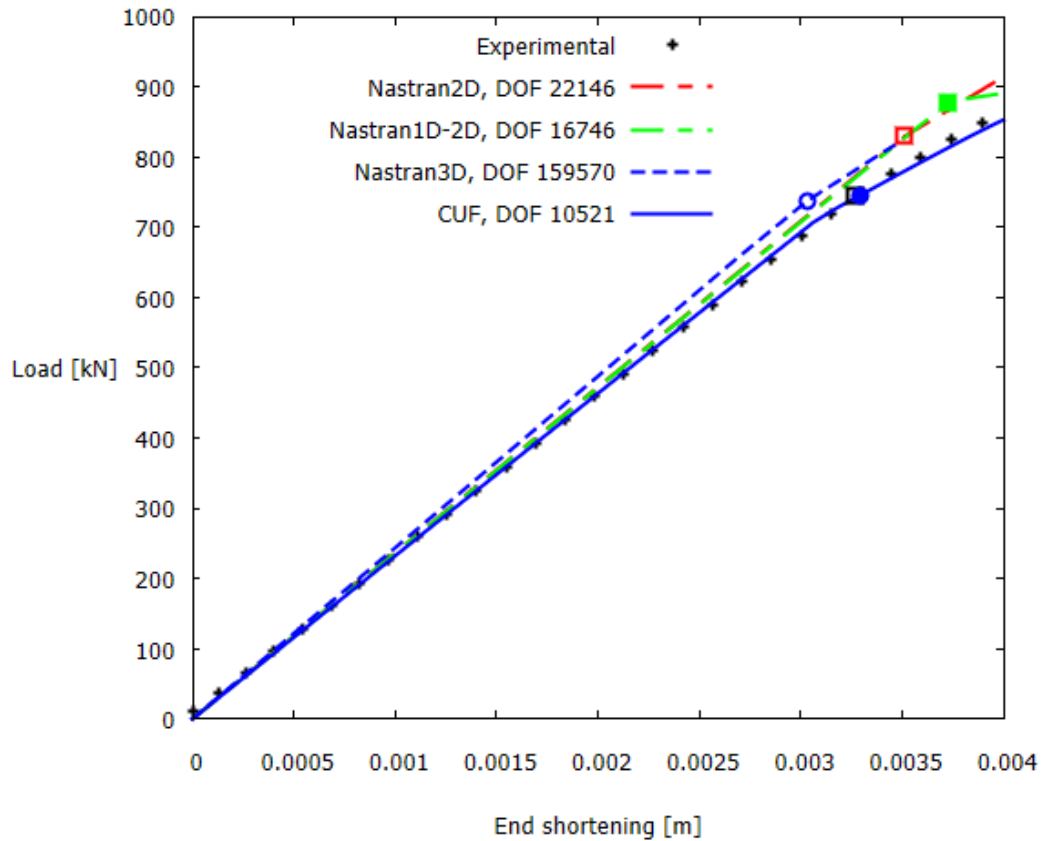

Figure 6. End-shortening vs applied load with Nastran, CUF and experimental results. Points and square indicate the buckling.

Table 3: Critical buckling load correspondent to the points and squares on Fig. 6.

Model	Shortening, m	Load, kN	DOF
Experimental	0.00327	744.676	-
Nastran 2D	0.00351	829.130	22146
Nastran 1D-2D	0.00372	877.694	16746
Nastran 3D	0.00309	729.498	159570
CUF	0.00329	728.819	10521

In addition, the post-buckling curves are reported in Fig. 7. Once again, the agreement between the refined ESL (denoted by CUF in the figure), Nastran 3D and Experimental results are close.

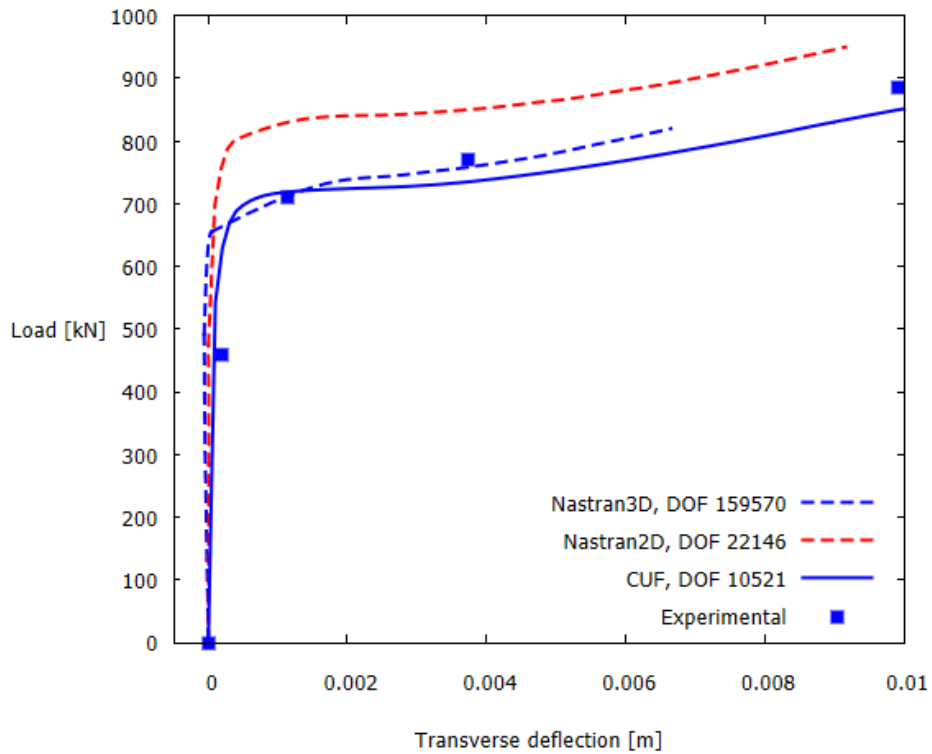

Figure 7. Transverse deflection vs load of the composite stiffened panel. Nastran, CUF and experimental results.

Finally, the refined ESL model is adopted for the evaluation of the post-buckling behavior, as reported in Fig. 8. Clearly, the model is demonstrated to be reliable.

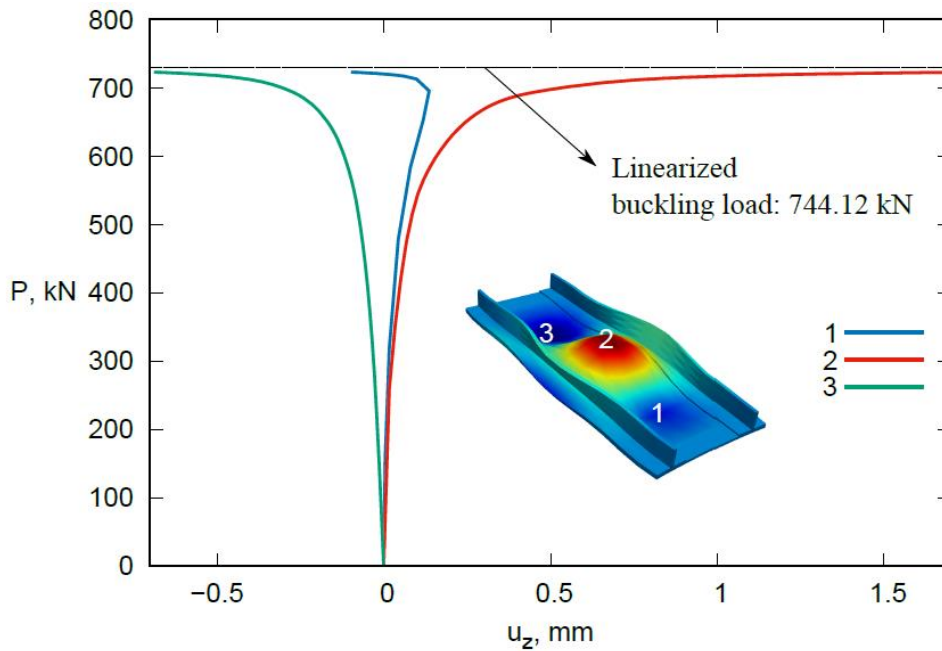

Figure 8. Numerical simulation of the post-buckling of the reinforced panel.

4. Conclusions

The present paper has the aim of analyzing the buckling and post-buckling behavior of a multilayered composite stiffened panel of aeronautical interest. Due to the complex stacking sequence, low-order mathematical models are not able to describe the 3D stress field and, thus, the post-buckling behavior. For a proper design of such structures, one must rely on heavy 3D models, which require a huge effort in terms of computational cost. However, the proposed refined ESL approach succeeds in correctly evaluating the critical point and the post-buckling behavior. This is possible thanks to CUF and its capability of developing 1D models while accounting for complicated stacking sequences by using refined expansion functions, which are based on Lagrange polynomials in this case. Results clearly show the advantage in terms of DOF gained and demonstrate that the present method can be used for the design of this kind of structures.

5. References

1. E. Carrera, G. Giunta, and M. Petrolo. *Beam structures: classical and advanced theories*. John Wiley & Sons, New York, USA, 2011.
2. E. Carrera and M. Petrolo. Refined one-dimensional formulations for laminated structure analysis. *AIAA journal*, 50(1):176-189, 2012.
3. A. Pagani and E. Carrera. Unified formulation of geometrically nonlinear refined beam theories. *Mechanics of Advanced Materials and Structures*, 25(1):15-31, 2016.
4. E. Carrera. C^0_z requirements-models for the two-dimensional analysis of multilayered structures. *Composite structures*, 37(3-4), 373-383, 1997.
5. E. Carrera and M. Filippi. Variable kinematic one-dimensional finite elements for the analysis of rotors made of composite materials. *Journal of Engineering for Gas Turbines and power*, 136(9):029501, 2014.
6. E. Carrera, A. Pagani and R. Augello. Evaluation of geometrically nonlinear effects due to large cross-sectional deformations of compact and shell-like structures. *Mechanics of Advanced Materials and Structures*, pages 1-9, 2018.
7. A. Pagani and E. Carrera. Large-deflection and post-buckling analyses of laminated composite beams by Carrera unified formulation. *Composite Structures*, 170:40-52, 2017.
8. E. Carrera. A study on arc-length type methods and their operation failures illustrated by a simple model. *Computers & Structures*, 50(2):217-229, 1994.
9. M. A. Crisfield. A fast incremental/iterative solution procedure that handles "snap-through". In *Computational Methods in Nonlinear Structural and Solid Mechanics*. Elsevier, Amsterdam, Netherlands, 1981.
10. M. A. Crisfield. An arc-length method including line searches and accelerations. *International journal for numerical methods in engineering*, 19(9):1269-1289, 1983.
11. P.H. Cabral, E. Carrera, H.E.A.A. dos Santos, P.H.G. Galeb, A. Pagani, D. Peeters, and A.P. Prado. Experimental and numerical vibration correlation of pre-stressed laminated reinforced panel. *Mechanics of Advanced Materials and Structures*, pages 1-13, 2020.