

本邦山地積雪地域の流出解析 RUNFF ANALYSIS OF SNOWY MOUNTAINOUS REGIONS IN JAPAN

journal or publication title	国立防災科学技術センター研究速報
number	17
page range	1-38
year	1975-08-30
URL	http://id.nii.ac.jp/1625/00002733/

RUNOFF ANALYSIS OF SNOWY MOUNTAINOUS REGIONS IN JAPAN

By

M. Sugawara, E. Ozaki, Y. Katsuyama and I. Watanabe

National Research Center for Disaster Prevention, Tokyo

1 Outline of the object region

1.1 The method of runoff analysis varies according to the characteristics of the object region, because the main factors of runoff phenomena vary according to regions and because the available data differ also. For example, in some regions it is not so difficult to estimate the equivalent water depth of snow deposit at the beginning of the snow-melting season directly by snow surveys, but in other regions it is very difficult.

1.2 The method described here has been developed for Japanese rivers of snowy mountainous regions and has given considerably good results. Fig. 1 shows the object basins analysed by Sugawara and others.

1.3 Snowy mountainous regions in Japan are under the following conditions:

1) There are heavy snowfalls in winter by seasonal strong northwest winds which bring much humidity from the Tsushima Warm Current that flows through the Sea of Japan. These humid northwest winds give heavy snowfalls on mountain slopes. Mean annual precipitations of mountainous regions facing on the Sea of Japan are generally over 3,000 mm and sometimes reach to 5,000 mm, and more than half of the total amount of annual precipitation in such regions is occupied by the snowfalls in winter namely from December to February.

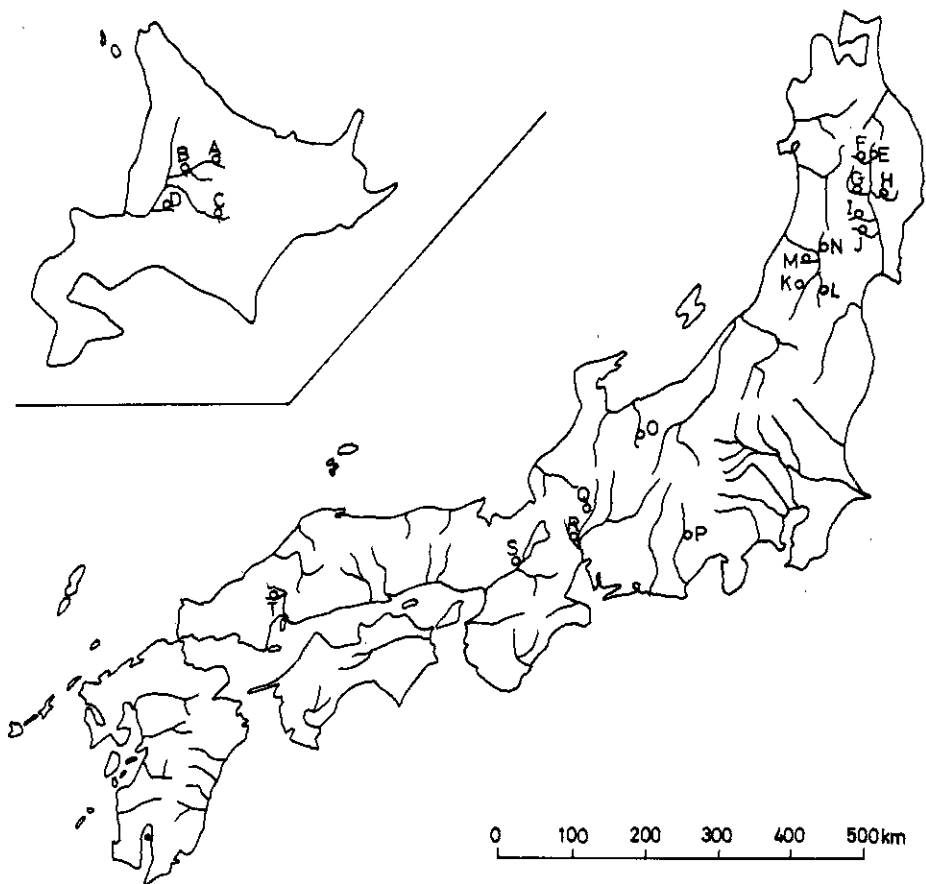

	Name of river	Name of tributary	Name of river gauge	Area of basin (km ²)	Number of rainfall station	Altitude (m)
A	Ishikari	Ishikari	Ishikarigawa	294	1	700 - 2,000
B	Ishikari	Ishikari	Inō	3,379	3	100 - 2,000
C	Ishikari	Sorachi	Kanayama	469	2	300 - 2,000
D	Ishikari	Ikushunbetsu	Katsurazawa	151	1	150 - 650
E	Kitakami	Kitakami	Shijūshita	1,196	5	200 - 1,600
F	Kitakami	Shizukuishi	Gosho	635	1	200 - 1,600
G	Kitakami	Sarugaishi	Tase	740	3	250 - 1,300
H	Kitakami	Waga	Yuta	583	3	250 - 1,300
I	Kitakami	Isawa	Ishibuchi	154	1	350 - 1,500
J	Kitakami	Iwai	Tsuriyama	288	2	150 - 1,600
K	Mogami	Mogami	Kamigo	1,690	5	100 - 2,000
L	Mogami	Su(kawa)	Sushiarai	422	3	100 - 1,800
M	Mogami	Sagae	Nishine	478	4	100 - 1,800
N	Mogami	Sake	Maki	639	3	100 - 1,300
O	Kurobe	Kurobe	Keyakidaira	313	1	650 - 3,100
P	Fuji	Fuji	Shimizubata	2,121	6	200 - 3,000
Q	Kiso	Nagara	Ueda	713	3	150 - 1,700
R	Kiso	Nagara	Sunomata	1,914	6	10 - 1,700
S	Yodo	Seta	Toriigawa	3,848	19	90 - 1,200
T	Ōta	Yoshiwa	Dani	76	1	570 - 1,340

Fig. 1

2) Mountain slopes are generally so steep and covered with thick forests, that it is very difficult or impossible to set rain-gauges on mountain slopes. Though there are many automatic rain-gauges using micro-wave on ridges or summits, they do not work in winter. Therefore we can scarcely have snowfall data for mountainous parts.

3) There are also small amounts of reliable snow deposit data obtained by snow surveys.

4) In most of the object basins, there are only a few rain-gauge stations which are mostly located in the plain and at so biased positions that they cannot be said to be representative for the basin.

5) Available data are the values of daily precipitation and daily temperature only.

6) Catchment areas of the object basins are generally from 100 km^2 to $2,000 \text{ km}^2$.

7) Most parts of the snow deposit melt away in the period from March to May, and we can neglect the effect of perpetual snow remaining in shady valleys.

2 Outline of the method of calculation

2.1 Input data are daily precipitations and daily temperatures at some points, and output data are daily discharges.

2.2 The basin is divided into some zones, each of which is assumed to be uniform in precipitation and temperature.

2.3 When temperature T_i of the i -th zone is not negative ($T_i \geq 0$), precipitation P_i of the i -th zone is assumed to be rain, and some part of the snow deposit will melt if it exists in the i -th zone. The volume of thawing consists of two parts, the main part is assumed to be proportional to the temperature T_i , and another part to be caused by rain water.

When temperature T_i is negative, precipitation in the i -th zone

is assumed to be snow and it is added to snow deposit.

2.4 Rain water in all zones and snow melt from all zones are summed up and the sum is transformed into runoff by the tank model which is shown in Fig. 2 schematically.

2.5 Some examples of obtained results are shown in Fig. 3.

3 Division of the basin into zones

3.1 It is not necessary to divide the basin into many zones. We usually divide the basin only into four zones.

3.2 To assume that each zone is uniform in temperature, zones must be divided by mean isothermal lines which can be replaced by contour lines for convenience' sake.

3.3 Usually the basin is divided into zones in such a way that the temperature T_i of the i -th zone decreases with a common difference ΔT . Then T_i is given by

$$T_i = T - (i-1) \Delta T + T_0 ,$$

where T is the daily temperature observed at a meteorological point or the mean of daily temperatures at some points, T_0 the correction term, and ΔT the common difference.

3.4 At the beginning, both ΔT and T_0 are determined by considering that the decreasing rate of temperature with altitude is about 0.55°C per 100 m. Later we have to take in mind that there are south slope and north slope in the basin. We can make the correction for this fact by the modification of ΔT , evaluating ΔT somewhat larger than before. Finally, we come to a conclusion that it is better to assume that the temperature decreasing rate is about 0.6°C per 100 m.

At first, we determine ΔT from the altitude difference of zones



Fig. 2

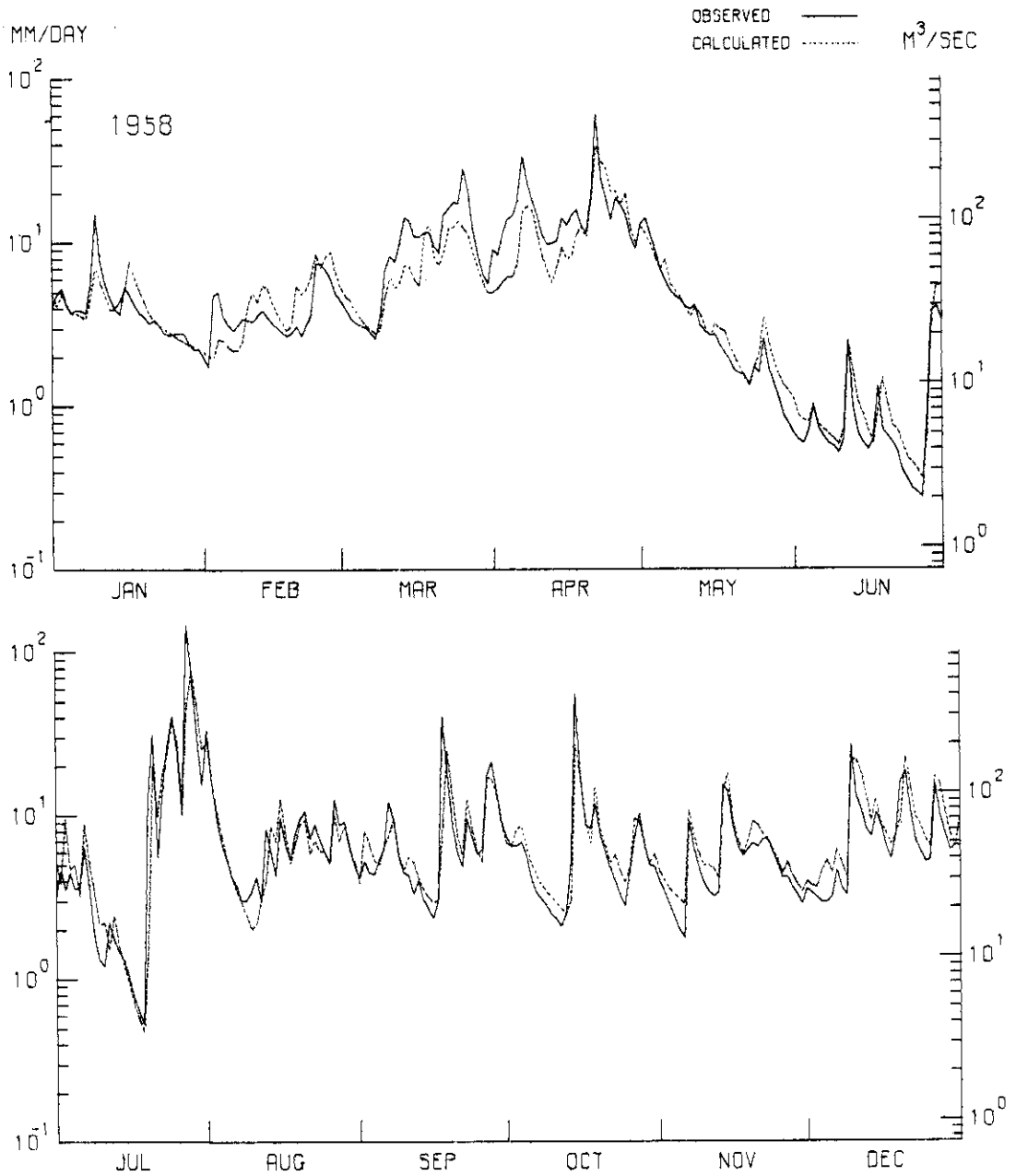

**Fig. 3.1 Daily discharge of River Sake
(a tributary of River Mogami) at Maki.**

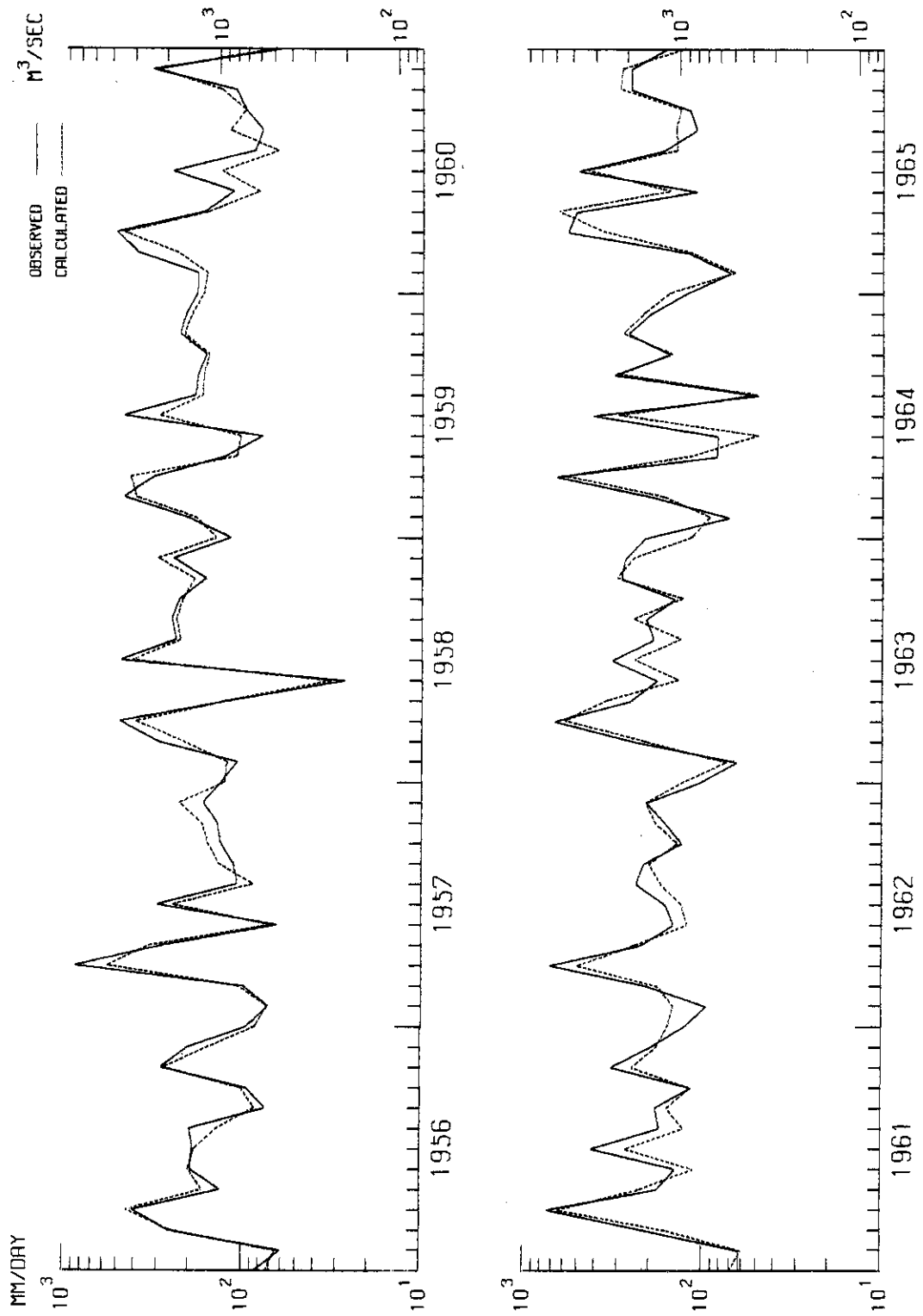
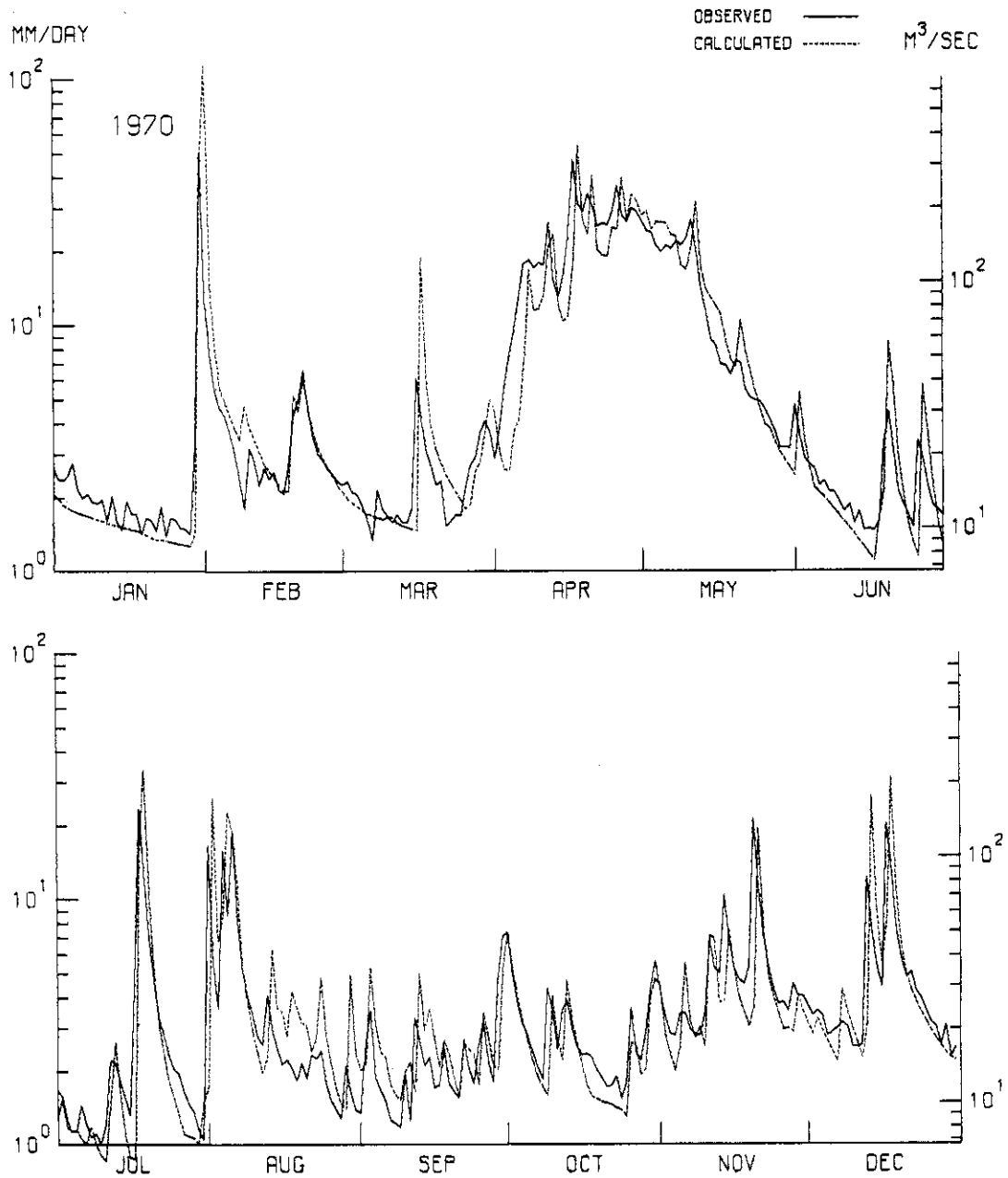

Fig. 3.2 Monthly discharge of River Sake (a tributary of River Mogami) at Maki.



**Fig. 3.3 Daily discharge of River Waga
(a tributary of River Kitakami) at Yuta.**

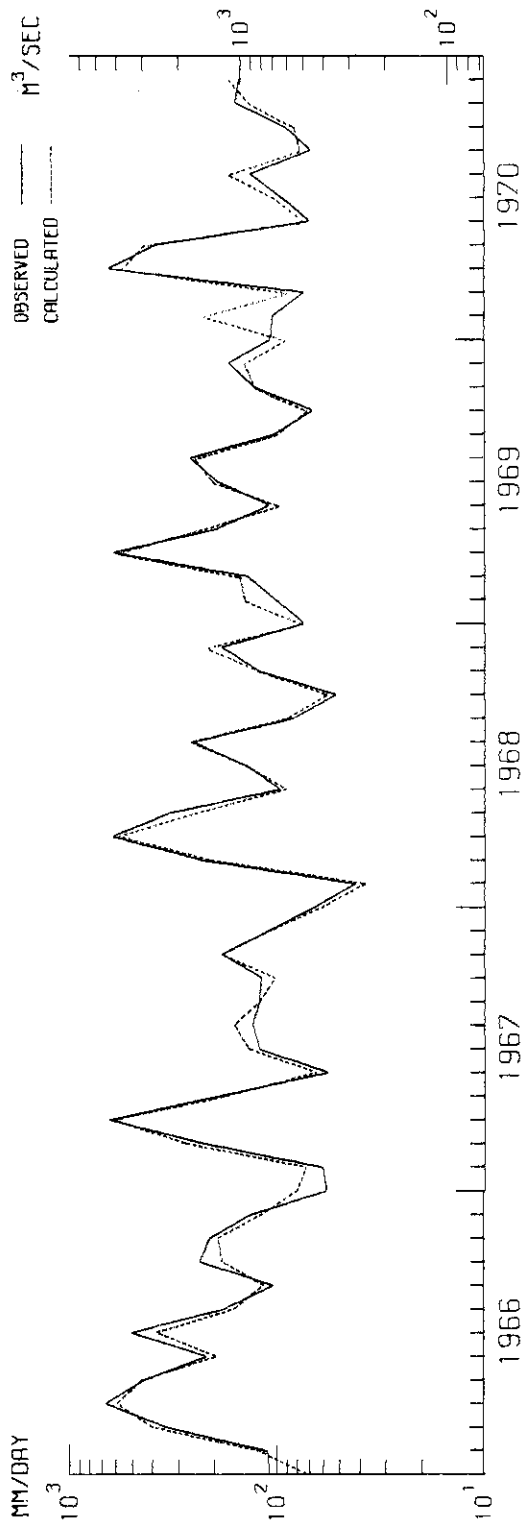

Fig. 3.4 Monthly discharge of River Waga (a tributary of River Kitakami) at Yuta.

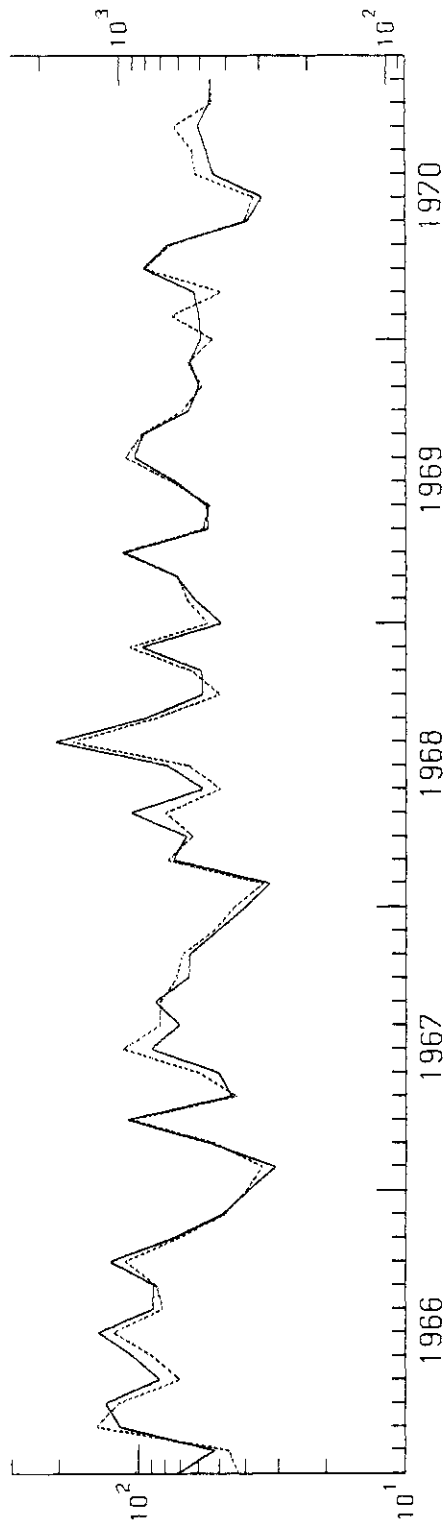

Fig. 3.5 Monthly discharge of River Sarugaishi (a tributary of River Kitakami) at Tase.

and T_0 from the altitude difference between the meteorological point and the mean altitude of the lowest zone. Then these values must be adjusted by trials.

3.5 A reasonable method to determine the area of zones must be the measurement of the area divided by contour lines, but we do not use this troublesome method because the zones are not divided by contour lines but by the unknown mean isothermal lines. We usually assume that the areas of zones are given by some arithmetic progressions shown in Table 1. We choose an appropriate one, looking at the topographical map of the object basin. Sometimes we make modification after trials.

Table 1

areal ratio of zones	percentage
4 : 3 : 2 : 1	40.0 : 30.0 : 20.0 : 10.0
5 : 4 : 3 : 2	35.7 : 28.6 : 21.4 : 14.3
6 : 5 : 4 : 3	33.3 : 27.8 : 22.2 : 16.7
9 : 8 : 7 : 6	30.0 : 26.7 : 23.3 : 20.0
14 : 13 : 12 : 11	28.0 : 26.0 : 24.0 : 22.0
1 : 1 : 1 : 1	25.0 : 25.0 : 25.0 : 25.0

4 Estimation of the areal mean precipitation of the i-th zone

4.1 The most important and difficult problem is to find the relation between the areal mean precipitation P_i of the i-th zone and the observed precipitation P at a rain-gauge station. If there are several rain-gauge stations, P is the mean of the observed values.

At the beginning it is assumed that the precipitation increases linearly with altitude and that the areal mean precipitation P_i of the i-th zone is given by

$$P_i = c (1+id) P .$$

Sometimes, we make modifications, considering that it would be rather better to assume that the precipitation of the fourth zone is equal to that of the third zone provided the basin is divided into four zones. In this case, the mean precipitation of the four zones are given by

$$P_1=c(1+d)P, \quad P_2=c(1+2d)P, \quad P_3=c(1+3d)P, \quad P_4=c(1+3d)P.$$

4.2 There is another remarkable fact about the precipitation changes with altitude. In all snowy basins in Japan which have been analysed by us, the estimated areal mean precipitation \bar{P} of the basin in summer is nearly equal to or slightly greater than the observed precipitation P at the rain-gauge station. If we put $\bar{P} = \alpha P$, α lies usually between 1.0 and 1.3. If we use this coefficient α in winter, however, the calculated discharge in the thawing season becomes much smaller than the actual. So we cannot but imagine that the coefficient α has a large seasonal change and must be large in winter and small in summer. Unfortunately, however, we have scarcely any data to ascertain this assumption. In some basins there are several rain-gauge stations on lower flatland and higher flatland near mountains, and the ratio of mean monthly precipitation of the respective two stations apparently shows a seasonal change that the precipitation is much larger in winter near mountains.

4.3 To represent the seasonal change, we introduce the monthly parameter C_m ($m = 1, \dots, 12$) with which we can give the areal mean precipitation P_{im} of the i -th zone in the m -th month as follows:

$$P_{im} = c(1+iC_m d)P \quad \left(\begin{array}{l} i = 1, \dots, k \\ m = 1, \dots, 12 \end{array} \right)$$

where i is the zone number, m the month number, P the observed daily precipitation at the rain-gauge station or the mean of daily precipitations at several stations, and c , C_m and d the constants. In some basins, we assume that the mean precipitation of the fourth zone is

equal to that of the third zone provided the basin is divided into four.

4.4 Recently we have found another curious fact. From the runoff analyses of some basins that lie between mountain ranges on the both sides, namely Japan Sea side and Pacific Ocean side, we find that the calculated discharge is somewhat larger than the observed one in autumn. After examining such examples we cannot but conclude that "the rain in autumn mainly stays in the plain", and we have to set C_m at a negative value in autumn. Some examples of the values of C_m are shown in Table 2.

Table 2

River name	Tributary name	J	F	M	A	M	J	J	A	S	O	N	D
Ishikari	Iku-shunbetsu	1.0	1.0	1.0	0.5	0	0	0	0	0	0	0.5	1.0
Ishikari	Ishikari	1.0	1.0	0.8	0.4	0.2	0	0	0	0	0	0.4	0.8
Kurobe	Kurobe	1.0	1.0	0.6	0.2	0	0	0	0	0	0	0.2	0.6
Kitakami	Waga	1.0	1.0	0.6	0.3	0	0	0	0	-0.2	-0.2	0.2	0.5

5 Calculation of thawing

5.1 There must be many meteorological parameters relating to thawing such as air temperature, precipitation, solar radiation, humidity, wind velocity, etc. In most basins, however, the available data are only of temperature and precipitation, and so we have to represent the volume of thawing as the function of air temperature and rainfall.

5.2 For simplicity's sake, we assume that the volume of thawing consists of two parts, one is proportional to the temperature, and the other to the product of the rainfall amount and the temperature. The latter part is deduced from the assumption that the temperature of rain drops is equal to the air temperature. Thus the volume of thawing from the i -th zone is given by

$$mT_i + (1/80) P_i T_i,$$

where $T_i (>0)$ is the air temperature of the i -th zone, P_i the rainfall, and m the constant of thawing.

5.3 The value of the thawing constant is determined by trials and is finally fixed at $m = 6$.

Usually, $m (= 6)$ is much larger than $P_i/80$, and so the thawing volume is mainly determined by the first term mT_i .

5.4 It is evident that the thawing volume is given by $mT_i + (1/80)P_i T_i$ only when there is enough snow deposit for thawing. Considering the amount of snow deposit S_i , the volume of thawing is given as follows:

$$\text{Min}[S_i, mT_i + (1/80)P_i T_i] .$$

5.5 When the available temperature data are the daily maximum and minimum, we use the weighted mean:

$$\alpha T_{\text{max}} + (1 - \alpha) T_{\text{min}} ,$$

where α is usually 0.5 or 0.6.

6 Calculation of runoff

6.1 The amount of rainfall (not snowfall) onto all the zones and the amount of thawing from all the zones are summed up and the sum is turned into runoff by the tank model.

6.2 The parameters of the tank model are kept constant all the year round. We need not use different values in the thawing season. It is rather curious, but we can get fairly good results by the use of constant parameters.

7 How to determine the parameters

7.1 There are so many parameters in this model that the researcher who wishes to use this model for the first time will doubt whether he

can find the adequate values only by trials. However, it is not so difficult if he has his own will to analyse.

7.2 The parameters of the tank model can be determined approximately by the analysis in summer season when there is no or scarcely snow deposit in the basin. If there are some known tank models for the basins which are similar to the object basin, we can use the parameters of these models for the first trial.

7.3 In most cases we divide the basin into four zones, the areal ratio of which can be chosen from Table 1, by looking at the topographical map.

7.4 The temperature decreasing constant ΔT and the correction constant T_0 are determined, as described above, by considering that the temperature decreasing rate with altitude is about 0.6°C per 100 m.

7.5 The most difficult and important problem is the determination of parameters for precipitation increase with altitude. These parameters cannot be estimated from topography but only by trials. At first, we put the common correction factor $c = 1$, and then put the coefficient of seasonal change as follows:

	Jan. - Mar.	Apr.	May - Oct.	Nov.	Dec.
C_m	1	1/2	0	1/2	1

Then the variable parameter is only d , and the mean precipitation in each zone is given as follows:

$$(1+dC_m)P, \quad (1+2dC_m)P, \quad (1+3dC_m)P, \quad (1+4dC_m)P ;$$

or $(1+dC_m)P, \quad (1+2dC_m)P, \quad (1+3dC_m)P, \quad (1+3dC_m)P .$

7.6 The first trial is carried out after putting d at some arbitrary value such as $d = 0.3$. Comparing the calculated discharge with the observed one especially in the thawing season, we modify the value d .

7.7 If the calculated thawing season comes earlier than the actual one, we must modify ΔT by making it larger than before, and vice versa. Sometimes the modification of T_0 is necessary. The parameters ΔT and T_0 are very sensitive.

7.8 In some cases where the modification of parameter ΔT cannot give a good result, the modification of the areal ratio of zones will give better results.

7.9 If the calculated discharge is somewhat smaller than the actual one in summer, we must modify the common correction factor c .

7.10 Of course we must modify the parameters of the tank model to make the shape of derived hydrograph better while we are modifying the parameters d , ΔT and others.

8 Some remarks

8.1 In some cases where there are several meteorological stations in the basin, we divide it into several sub-basins, each of them usually containing one station. Then we can calculate the runoff from each of the sub-basins which are composed to make the calculated discharge of the whole basin.

8.2 As is described above, the areal mean precipitation of the i -th zone in the m -th month is given by

$$P_{im} = c(1 + idC_m)P, \quad \begin{pmatrix} i = 1, \dots, k \\ m = 1, \dots, 12 \end{pmatrix}$$

or the precipitation of the fourth zone is equal to that of the third zone provided the basin is divided into four zones. In our program, however, we use a more general form by using the coefficient d_i with the index i , and then P_{im} is given by

$$P_{im} = c(1 + d_i C_m)P,$$

where d_i are put numerically as $(d, 2d, 3d, 4d)$ or $(d, 2d, 3d, 3d)$.

8.3 In most of Japanese river basins, the irrigation for paddy fields has a significant effect on the discharge. For the calculation of this effect, we usually subtract some amount from the output of tank model for irrigation of paddy fields and feed back it to the third tank to represent infiltration from paddy fields. The amount of irrigation water is determined by trials and errors. In the program given in Appendix, however, the calculation of the effect of irrigation is neglected for simplicity's sake.

9 Program

9.1 In the program given in Appendix, the basin is divided into several sub-basins, each of them containing one meteorological station. The series of calculated runoffs derived from meteorological data of such stations are composed with appropriate weights to make the runoff from the object basin.

9.2 In the case where the mean precipitation and temperature of several stations are used as input, we must make the mean at first to put it into the above program.

9.3 Considering the convenience for the judgement to modify the values of parameters for the next trial, we print out the results as follows:

Daily outputs are: 1) observed and calculated daily runoff (mm/day), 2) calculated snow deposit in water depth (mm), and 3) hydrographs in logarithmic scale. Plotted hydrographs are $\log q$, $\log \tilde{q}$ = $\log (q_4+q_3+q_2+q_1)$, $\log (q_3+q_2+q_1)$, $\log (q_2+q_1)$ and $\log q_1$, where q is the observed runoff, \tilde{q} the calculated runoff, q_1 , q_2 , q_3 and q_4 the outputs of tanks from bottom to top. From the hydrograph showing each of runoff components visually, we can judge what and how parameters must be modified. When the basin is divided into several sub-basins,

q_1 , q_2 , q_3 and q_4 are respectively the weighted means of the output of the tanks of each of the sub-basins.

Monthly outputs are: 1) observed and calculated monthly runoffs (mm/month), 2) monthly final value of storage amount in each tank of each sub-basin, and 3) the snow deposit in water depth of each zone of each sub-basin. We do not print out all daily outputs because of simplicity. We think, too much data is not good for judgement.

9.4 Meanings of indexes, constants and variables are as follows:

1) Index

K	rain-gauge station (sub-basin) index
I	zone index
J	day index
M	month index

2) Integer

NP	number of rain-gauge stations
IZONE	number of zones
JN	number of days in a year
JE	last day number in a month
JS	first day number in a month
MONTH(M)	number of days in a month

3) Constants and variables in the calculation of snow deposit and snow melt

WE(K)	area of K-th sub-basin provided the basin area is unit
ZA(I,K)	area of the I-th zone in the K-th sub-basin provided the area of K-th sub-basin is unit
P(J,K)	daily precipitation
T(J,K)	daily temperature
TMAX(J)	daily maximum temperature
TMIN(J)	daily minimum temperature

TW(K)	weight α in the formula $\alpha T_{\max} + (1-\alpha)T_{\min}$
TO(K)	temperature correction factor T_0 in the formula $T_i = T - (i-1) \Delta T + T_0$
TD(K)	temperature decreasing constant ΔT of the above formula
TI	derived temperature of a zone in a sub-basin
PC(K)	correction coefficient c for precipitation in the formula $P_{im} = c(1+C_m d_i)P$
PX	modified daily precipitation cP after multiplication by $c = PC(K)$
PD(I,K)	coefficient d_i of the above formula for precipitation change with altitude
PCM(M)	coefficient C_m in the above formula for the seasonal change
PN	derived mean areal precipitation of a zone in a sub-basin
SMELT	thawing constant m in $mT_i + (1/80)P_i T_i$
SNOW(I,K)	snow deposit in water depth in the I-th zone of the K-th sub-basin
SK	snow deposit in water depth in a sub-basin which is obtained by accumulation of the deposits of all the zone
ST(J)	snow deposit in water depth of the whole basin
SM	volume of thawing in water depth
PY	input to the tank model which is obtained by accumulating the rainfall and snow melt of each zone

4) Constants and variables of the tank model

Most of them are shown in Fig. 4. QA, QB, QC, QD are the weighted sum of the outputs from sub-basins. They are obtained by accumulating the output from the respective tank of each sub-basin.

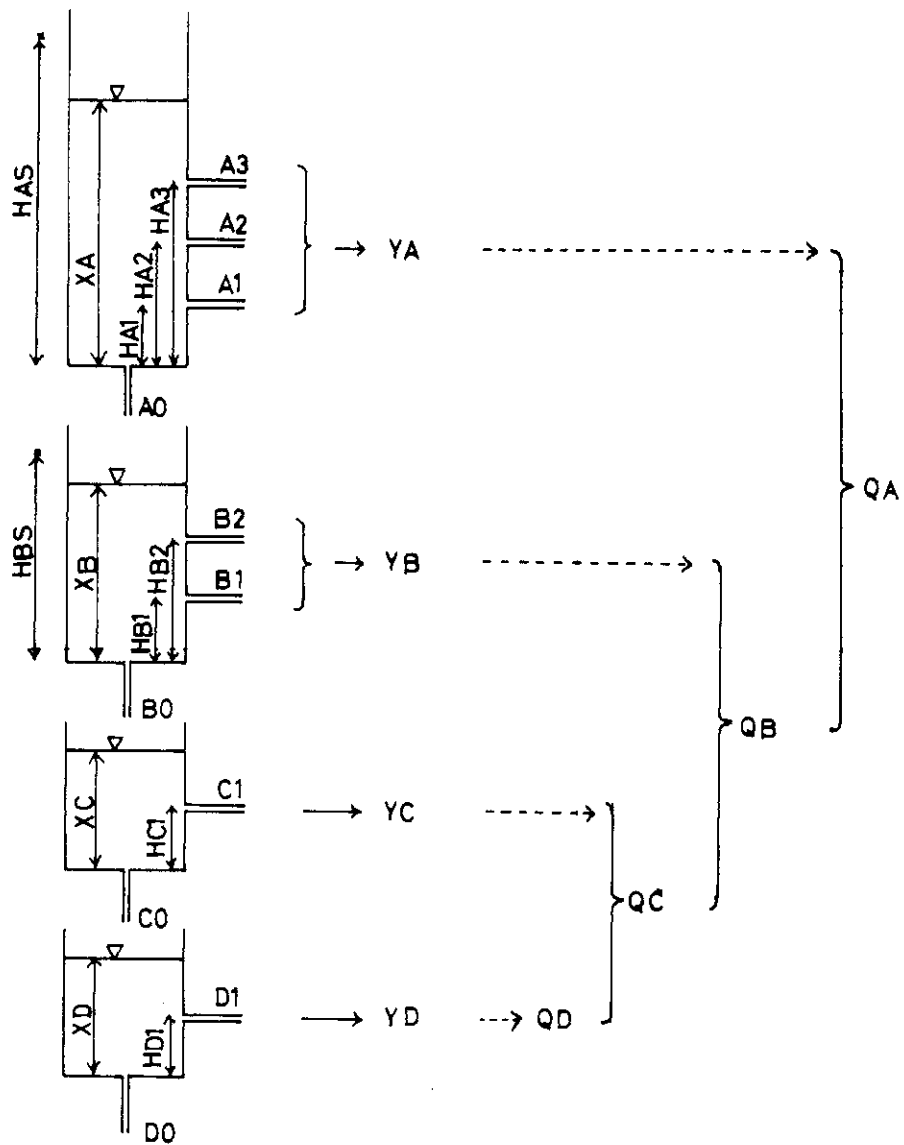

Fig. 4

LAG(K)	time lag for the K-th sub-basin (usually one day)
EVAP(M)	daily evaporation in the M-th month
Q(J)	observed daily discharge
PNAME(K)	name of rain-gauge station
QNAME	name of river gauge
FYEAR	first year
LYEAR	last year
YEAR	year

5) Graph plotting

N	scale point index on ordinate
NPLOT	number of hydrographs to be plotted
NSCAL	number of scale points
L	plotting position number
LY	maximum of L
DY	assigned character size for log 10
YMIN	minimum of ordinate
AMIN	$\log(YMIN + QO)$
NX	index for plotted hydrograph
QO	non-negative constant additive to discharge (it is necessary when the minimum discharge is 0)
GBUF(L)	buffer for one line
SCAL(N)	scale points on ordinate
ISCAL(N)	position of scale points
CM(M)	characters indicating months
CHAR(NX)	plotted characters
PLOT(NX)	discharge values plotted

6) Others

SQ	monthly sum of the observed discharge (mm)
SQE	monthly sum of the estimated discharge (mm)

(Manuscript received 25 April 1975)

WAGACAWA 1970		Q	YUTA V	YA	XB	XC	XD					
1	107.0	90.3	YUTA	43.	44.	5.	387.	16.	72.	142.	333.	
			SAWAUCHI	52.	58.	19.	928.	458.	644.	882.	1137.	
			WAKAHATA	48.	50.	13.	870.	292.	455.	624.	869.	
2	104.5	223.0	YUTA	0.	10.	23.	391.	25.	84.	192.	406.	
			SAWAUCHI	1.	16.	35.	921.	782.	1157.	1619.	1768.	
			WAKAHATA	0.	15.	36.	863.	502.	823.	1153.	1436.	
3	73.4	88.0	YUTA	17.	23.	16.	386.	0.	12.	169.	421.	
			SAWAUCHI	7.	10.	21.	904.	1130.	1630.	2284.	2533.	
			WAKAHATA	15.	20.	28.	850.	677.	1107.	1533.	1841.	
4	647.6	556.6	YUTA	3.	18.	39.	397.	0.	0.	0.	0.	
			SAWAUCHI	37.	123.	115.	914.	0.	571.	1384.	1790.	
			WAKAHATA	36.	102.	114.	871.	0.	33.	614.	1087.	
5	384.0	432.7	YUTA	0.	0.	0.	363.	0.	0.	0.	0.	
			SAWAUCHI	0.	14.	129.	1016.	0.	0.	0.	0.	
			WAKAHATA	0.	0.	81.	947.	0.	0.	0.	0.	
6	69.6	74.3	YUTA	0.	0.	1.	311.	0.	0.	0.	0.	
			SAWAUCHI	0.	14.	31.	1023.	0.	0.	0.	0.	
			WAKAHATA	0.	10.	15.	929.	0.	0.	0.	0.	
7	94.3	101.6	YUTA	9.	5.	1.	243.	0.	0.	0.	0.	
			SAWAUCHI	3.	1.	12.	993.	0.	0.	0.	0.	
			WAKAHATA	5.	1.	12.	895.	0.	0.	0.	0.	
8	134.6	170.1	YUTA	0.	0.	17.	254.	0.	0.	0.	0.	
			SAWAUCHI	11.	16.	32.	976.	0.	0.	0.	0.	
			WAKAHATA	1.	5.	32.	884.	0.	0.	0.	0.	
9	68.6	77.2	YUTA	15.	13.	13.	254.	0.	0.	0.	0.	
			SAWAUCHI	20.	21.	26.	959.	0.	0.	0.	0.	
			WAKAHATA	24.	23.	24.	867.	0.	0.	0.	0.	
10	91.7	82.4	YUTA	3.	5.	9.	256.	0.	0.	0.	0.	
			SAWAUCHI	17.	19.	15.	937.	0.	0.	0.	0.	
			WAKAHATA	17.	19.	16.	849.	0.	0.	0.	0.	
11	158.2	134.7	YUTA	3.	16.	23.	257.	16.	17.	19.	19.	
			SAWAUCHI	7.	24.	40.	923.	42.	46.	51.	51.	
			WAKAHATA	6.	22.	39.	840.	37.	40.	44.	44.	
12	150.0	169.1	YUTA	0.	6.	26.	269.	1.	3.	42.	111.	
			SAWAUCHI	1.	15.	46.	923.	162.	293.	432.	457.	
			WAKAHATA	0.	13.	44.	841.	99.	194.	324.	343.	

Fig. 5 Printed format of monthly output

Each of the columns are (from left to right): month number, observed runoff (mm/month), calculated runoff (mm/month), name of rain-gauge station (sub-basin), monthly final values of storage amount (mm) in each tank (YA, XB, XC, XD), and monthly final values of snow deposit in water depth (mm) in each zone from lower to higher.

1970 J 2.61 2.07 260.
 2.56 1.98 260.
 2.35 1.86 263.
 2.46 1.80 203.
 2.78 1.77 281.
 2.15 1.73 293.
 1.99 1.71 300.
 2.07 1.68 304.
 1.92 1.66 309.
 1.89 1.63 316.
 1.97 1.61 317.
 1.59 1.57 345.
 2.03 1.55 354.
 1.59 1.54 366.
 1.46 1.52 367.
 1.94 1.50 388.
 1.72 1.48 390.
 1.70 1.46 391.
 1.41 1.44 391.
 1.66 1.41 392.
 1.61 1.37 402.
 1.46 1.35 405.
 1.83 1.34 438.
 1.30 1.33 443.
 1.66 1.32 447.
 1.61 1.30 449.
 1.50 1.20 450.
 1.48 1.28 458.
 1.41 1.27 456.
 3.27 1.45 471.
 50.15 44.07 447.
 12.6611334 468.
 7.35 14.24 491.
 5.35 8.28 491.
 4.54 5.51 513.
 6.25 4.85 519.
 3.62 4.27 523.
 1.01 1.80 525.
 2.36 3.41 534.
 1.79 4.68 582.
 1.14 1.83 609.
 2.79 3.40 616.
 2.23 3.06 616.
 2.62 2.70 629.
 2.37 2.53 649.
 2.53 2.38 667.
 2.14 2.23 678.
 2.05 2.11 681.
 2.71 2.11 677.
 4.31 5.15 672.
 4.96 4.46 683.
 6.54 6.00 689.
 4.50 4.62 695.
 3.67 3.68 699.
 2.98 3.17 710.
 2.81 2.87 734.
 2.58 2.63 750.
 2.47 2.43 753.
 2.40 2.22 764.

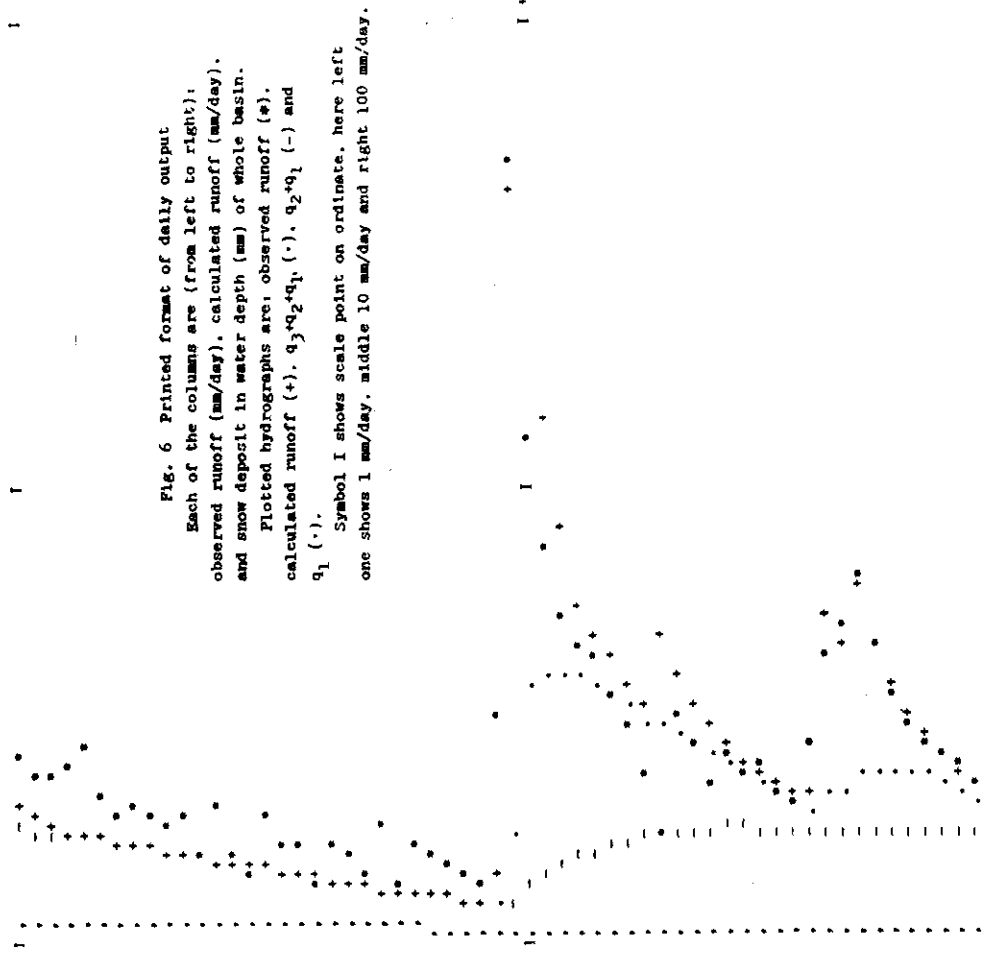
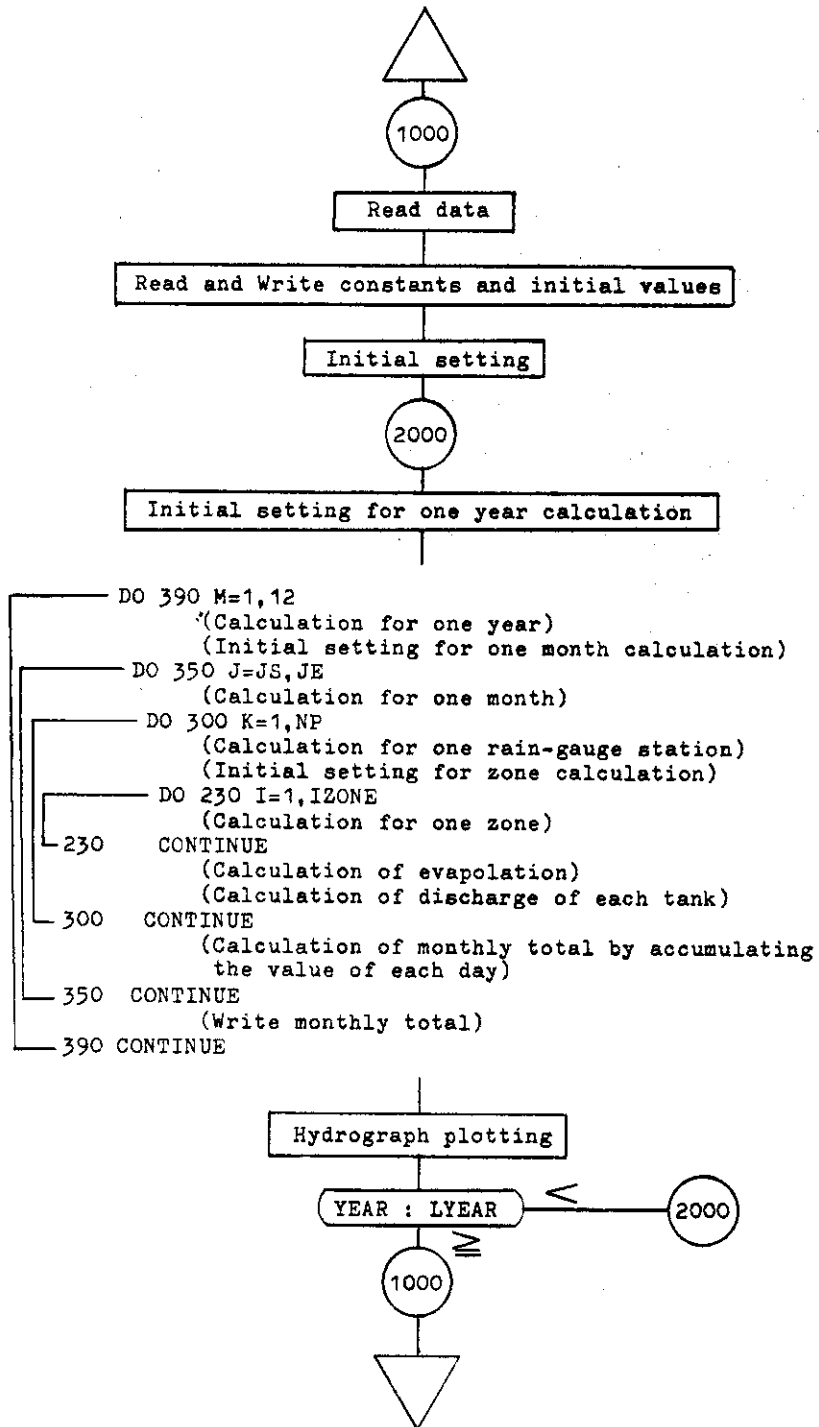
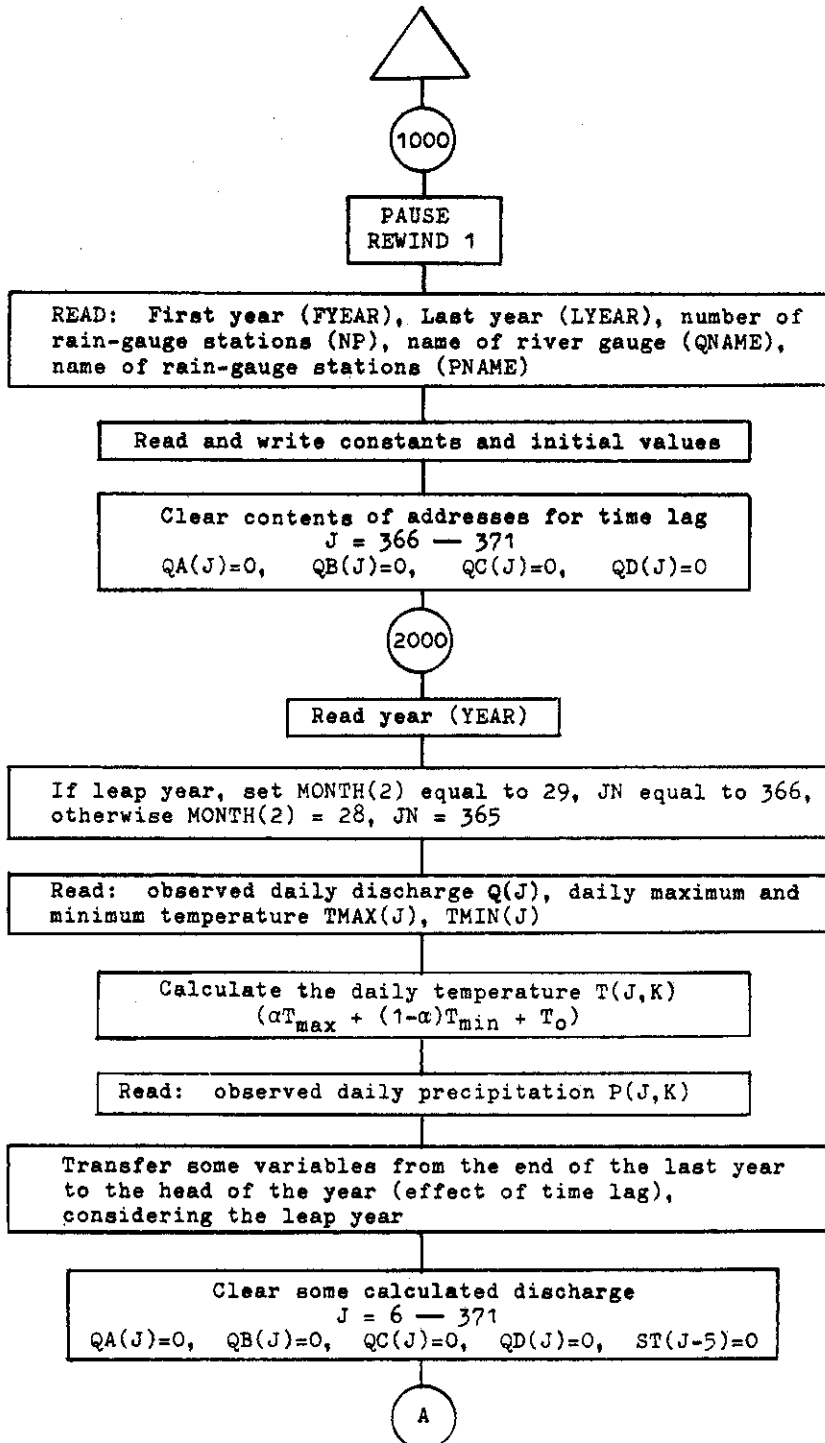

Fig. 6 Printed format of daily output
 Each of the columns are (from left to right):
 observed runoff (mm/day), calculated runoff (mm/day),
 and snow deposit in water depth (mm) of whole basin.
 Plotted hydrographs are, observed runoff (+),
 calculated runoff (+), $q_1+q_2+q_3$, q_1 , q_2+q_3 and
 q_1 (•).
 Symbol I shows scale point on ordinate, here left
 one shows 1 mm/day, middle 10 mm/day and right 100 mm/day.

Block chart



Flowchart, main program



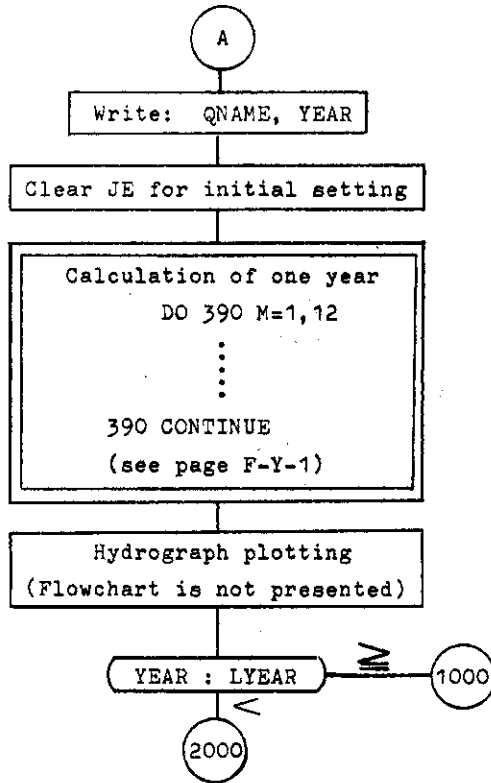

Open subroutine
Calculation for one year

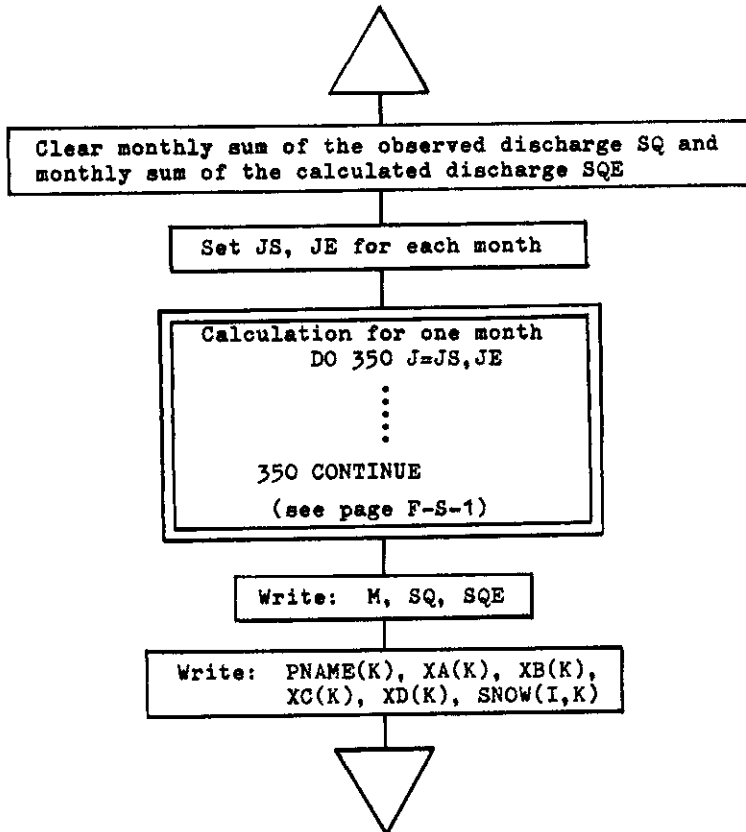

Open subroutine
Calculation for one month

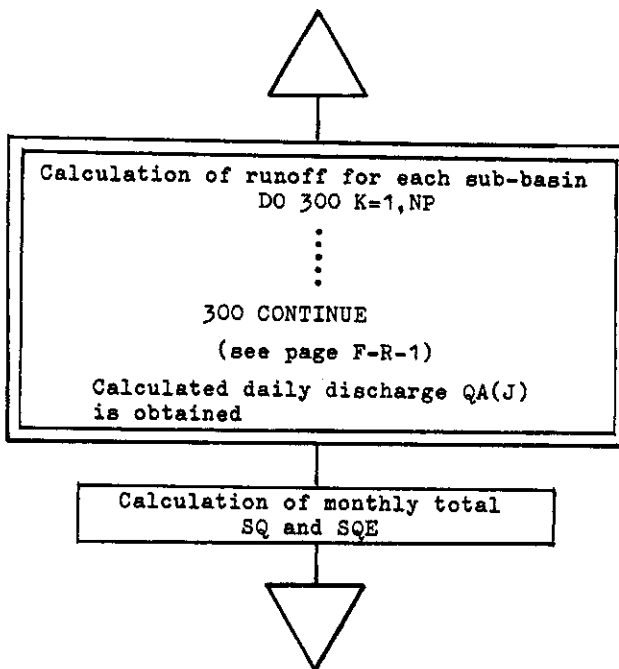

Open subroutine

Calculation of runoff for each sub-basin

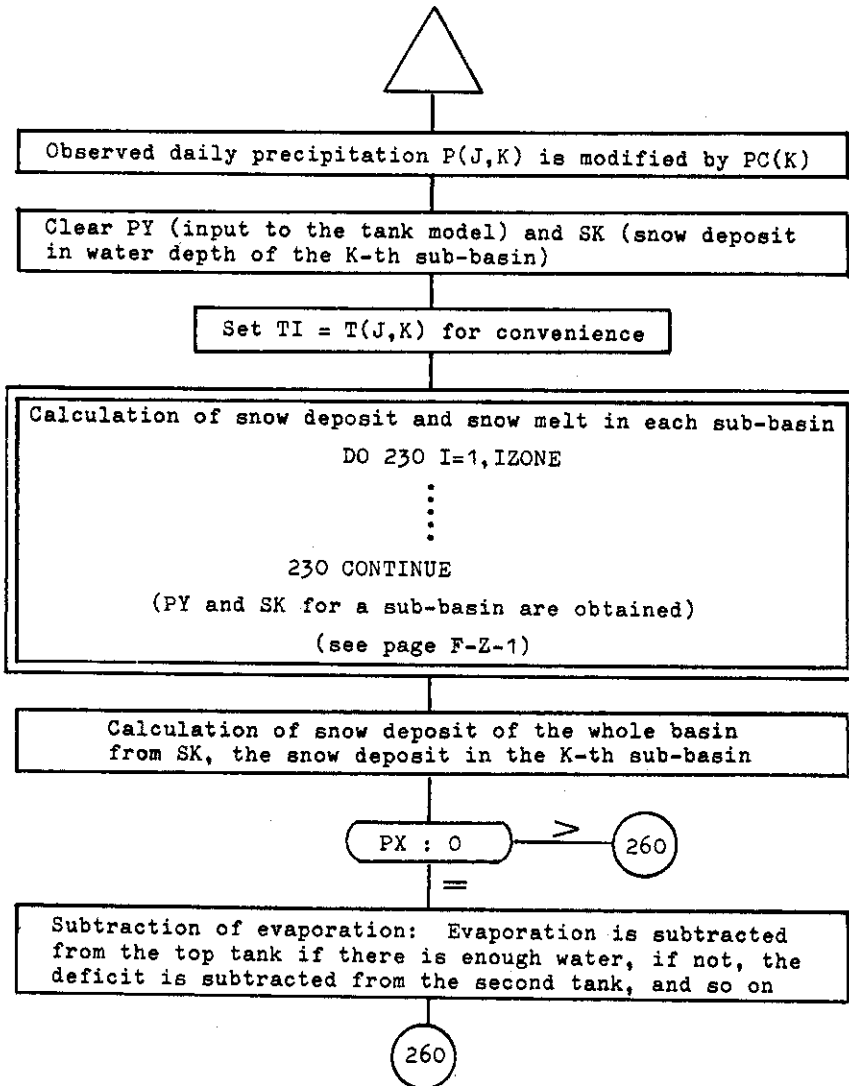

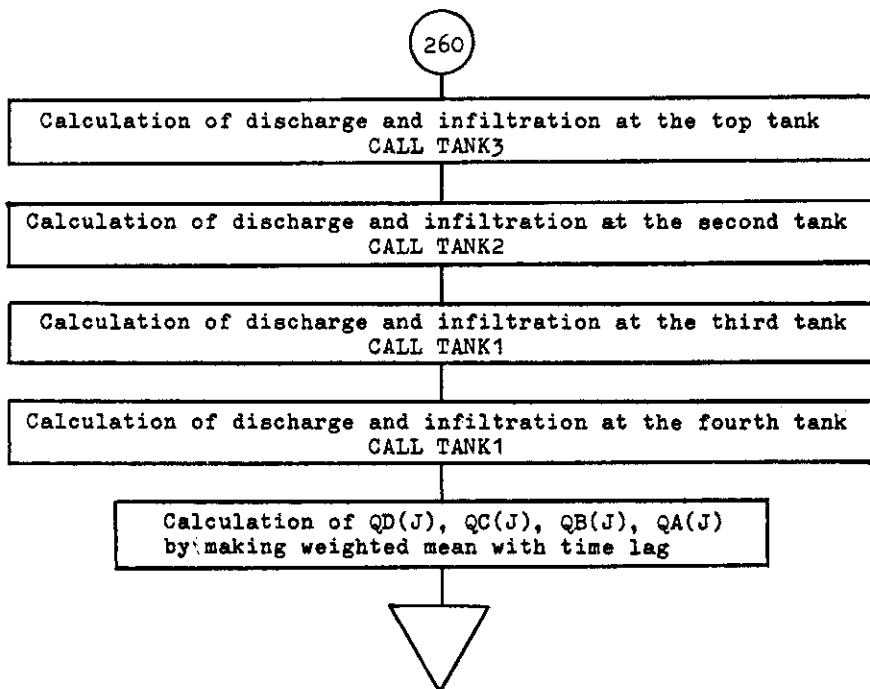

Open subroutine

Calculation of snow deposit and snowmelt

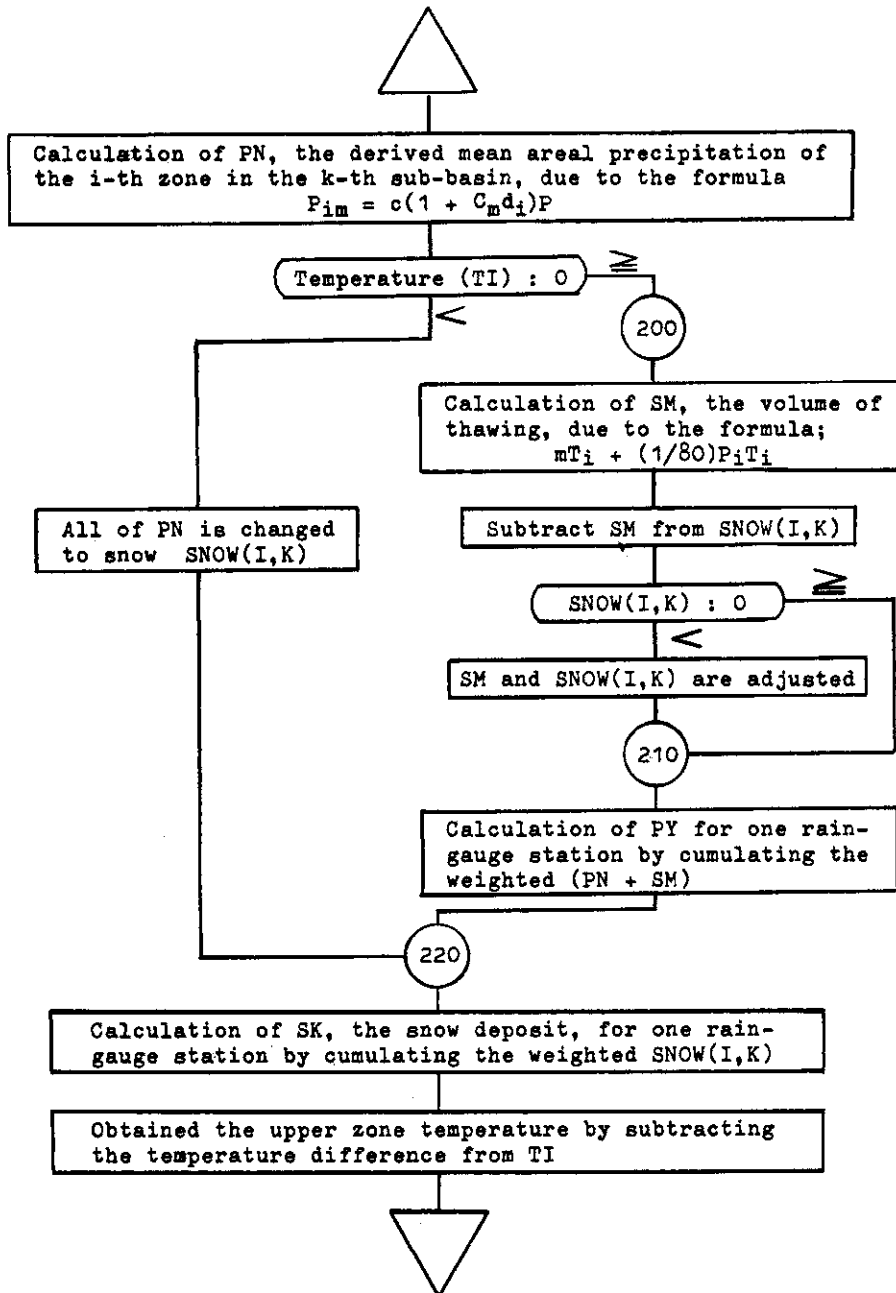

APPENDIX B

YJOB

YTFTC

C

C LIMITATIONS IN THIS PROGRAM

C NP: LESS OR EQUAL 6, REFER TO P, T, PNAME, XA, XB,
 C XC, XD, PC, WF, LAG, TW, TD, TD, PD, ZA, SNOW
 C IZONE: LESS OR EQUAL 4, REFER TO PD, ZA, SNOW
 C LAG: LESS OR EQUAL 5, REFER TO QA, QB, QC, QD
 C NSCAL: LESS OR EQUAL 5, REFER TO SCAL, ISCAL
 C NPLOT: LESS OR EQUAL 5, REFER TO CHAR, PLOT
 C LY: LESS OR EQUAL 120, REFER TO GBUF
 C
 C

1 DIMENSION Q(366),P(366,6),T(366,6),TMAX(366),TMIN(366),
 1 + QA(371),QB(371),QC(371),QD(371),ST(366),PNAME(6),
 1 + MONTH(12),XA(6),XB(6),XC(6),XD(6),PC(6),WE(6),LAG(6),
 1 + TW(6),TD(6),TD(6),EVAP(12),PCM(12),PD(4,6),ZA(4,6),
 1 + SNOW(4,6),
 1 + GBUF(120),SCAL(5),ISCAL(5),CM(12),CHAR(5),PLOT(5)

C

2 INTFGER YEAR,FYEAR

C

3 DATA MONTH/31,28,31,30,31,30,31,31,30,31,30,31/

4 DATA CHAR/'* + ' - '/'

5 DATA CM /'J F M A ;

5 + 'M J A ;

5 + 'S O N D ;

C

6 1000 PAUSE

7 RFWIND 1

C

C

C FYEAR : FIRST YEAR

C LYEAR : LAST YEAR

C NP : NUMBER OF RAIN-GAUGE STATIONS

C QNAME : NAME OF RIVER GAUGE

C PNAME : NAME OF RAIN-GAUGE STATIONS

C

8 READ (1) FYEAR,LYEAR,NP,QNAME,(PNAME(K),K=1,NP)

C

C

C READ/WRITE CONSTANTS AND INITIAL VALUES

C

9 READ (5,10) HAS,HA1,HA2,HA3,A0,A1,A2,A3

10 READ (5,10) HBS,HB1,HB2,B0,B1,B2

11 READ (5,10) HC1,C0,C1

12 READ (5,10) HD1,D0,D1

13 READ (5,11) IZONE,SMELT

14 READ (5,10) (XA(K),K=1,NP)

15 READ (5,10) (XB(K),K=1,NP)

16 READ (5,10) (XC(K),K=1,NP)

17 READ (5,10) (XD(K),K=1,NP)

```

18      READ (5,10) (PC(K),K=1,NP)
19      READ (5,10) (WE(K),K=1,NP)
20      READ (5,10) (TW(K),K=1,NP)
21      READ (5,10) (T0(K),K=1,NP)
22      READ (5,10) (TD(K),K=1,NP)
23      READ (5,12) (LAG(K),K=1,NP)
24      READ (5,10) EVAP
25      READ (5,10) PCM
26      READ (5,10) ((PD(I,K),I=1,IZONE),K=1,NP)
27      READ (5,10) ((ZA(I,K),I=1,IZONE),K=1,NP)
28      READ (5,10) ((SNOW(I,K),I=1,IZONE),K=1,NP)
29      READ (5,13) NPLOT,NSCAL,LY,DY,YMIN,Q0
30      READ (5,10) (SCAL(N),N=1,NSCAL)

```

C

```

31      WRITE (6,20) HAS,HA1,HA2,HA3,A0,A1,A2,A3
32      WRITE (6,21) HBS,HB1,HB2,B0,B1,B2,HC1,CO,C1,HD1,DO,D1
33      WRITE (6,22) (XA(K),K=1,NP)
34      WRITE (6,23) (XB(K),K=1,NP)
35      WRITE (6,24) (XC(K),K=1,NP)
36      WRITE (6,25) (XD(K),K=1,NP)
37      WRITE (6,26) (PC(K),K=1,NP)
38      WRITE (6,27) (WE(K),K=1,NP)
39      WRITE (6,28) (TW(K),K=1,NP)
40      WRITE (6,30) (T0(K),K=1,NP)
41      WRITE (6,31) (TD(K),K=1,NP)
42      WRITE (6,32) (LAG(K),K=1,NP)
43      WRITE (6,33) EVAP
44      WRITE (6,34) PCM
45      WRITE (6,35) ((PD(I,K),I=1,IZONE),K=1,NP)
46      WRITE (6,36) ((ZA(I,K),I=1,IZONE),K=1,NP)
47      WRITE (6,37) ((SNOW(I,K),I=1,IZONE),K=1,NP)
48      WRITE (6,38) NPLOT,NSCAL,LY,DY,YMIN,Q0
49      WRITE (6,39) (SCAL(N),N=1,NSCAL)

```

C

```

50      10 FORMAT(8F10.4)
51      11 FORMAT(110,F10.0)
52      12 FORMAT(8I10)
53      13 FORMAT(3I10,5F10.4)
54      20 FORMAT(1H 8X'HAS'8X'HA1'7X'HA2'7X'HA3'7X'A0'8X'A1'8X
54      +      'A2'8X'A3'/3X4F10.0,4F10.3)
55      21 FORMAT(/1H 8X'HBS'8X'HB1'7X'HB2'7X'B0'8X'B1'8X'B2'8X
55      +      'HC1'7X'CO'8X'C1'8X'HD1'7X'D0'8X'D1'/
55      +      3X3F10.0,3F10.3,2(F10.0,2F10.4))
56      22 FORMAT(/1H 'XA'12F10.0)
57      23 FORMAT(1H0'XB'12F10.0)
58      24 FORMAT(1H0'XC'12F10.0)
59      25 FORMAT(1H0'XD'12F10.0)
60      26 FORMAT(1H0'PC '12F10.2)
61      27 FORMAT(1H0'WE'12F10.0)
62      28 FORMAT(1H0'TW '12F10.1)
63      30 FORMAT(1H0'T0 '12F10.1)
64      31 FORMAT(1H0'TD '12F10.1)
65      32 FORMAT(1H0'LAG' I8,11I10)
66      33 FORMAT(1H0'EVAP'12F10.2)

```



```

67      34 FORMAT(1H0'PCM '12F10.2)
68      35 FORMAT(1H0'PD '12F10.2/(5X12F10.2))
69      36 FORMAT(1H0'ZA '12F10.2/(5X12F10.2))
70      37 FORMAT(1H0'SNOW'F8.0,11F10.0/(3X12F10.0))
71      38 FORMAT(/9X'N PLOT'5X'NSCAL'6X'LY'8X'DY'9X'YMIN'7X'QD'/
71      +      2X3I10,F11.0,2X2F10.4)
72      39 FORMAT(/1H 'SCAL'12F10.2)

C
C
C CLEAR CONTENTS OF ADDRESSES FOR TIME LAG
C
73      DO 130 J=366,371
74      QA(J)=0.
75      QB(J)=0.
76      QC(J)=0.
77      130 QD(J)=0.

C
C
C ENTRY OF COMPUTING LOOP FOR ONE YEAR
C
78      2000 READ (1) YEAR
C
C LEAP YEAR OR NOT
C
79      MONTH(2)=28
80      JN=365
81      IF (MOD(YEAR,4).NE.0) GO TO 140
82      MONTH(2)=29
83      JN=366
84      140 CONTINUE

C
C READ Q, T OF ONE YEAR
C
85      READ (1) Q

C
86      DO 150 K=1,NP
87      READ (1) TMAX
88      READ (1) TMIN

C
C CALCULATION OF THE DAILY TEMPRATURE T(J,K)
C
89      TW=1.-TW(K)

C
90      DO 150 J=1,JN
91      T(J,K)=TMAX(J)*TW(K)+TMIN(J)*TW+TD(K)
92      150 CONTINUE

C
C READ P OF ONE YEAR
C
93      DO 160 K=1,NP
94      160 READ (1) (P(J,K),J=1,366)

C
C TRANSFER SOME VARIABLES FROM LAST YEAR-END TO THE HEAD OF
C THIS YEAR (EFFECT OF TIME LAG), CONSIDERING THE LEAP YEAR

```

```

C
95      JLAG=366
96      IF (MOD(YEAR-1,4).EQ.0) JLAG=367
C
97      DO 170 J=1,5
98      QA(J)=QA(JLAG)
99      QB(J)=QB(JLAG)
100     QC(J)=QC(JLAG)
101     QD(J)=QD(JLAG)
102     170 JLAG=JLAG+1
C
C      CLEAR SOME CALCULATED DISCHARGE
C
103     DO 180 J=6,371
104     QA(J)=0.
105     QB(J)=0.
106     QC(J)=0.
107     QD(J)=0.
108     180 ST(J-5)=0.
C
109     WRITE (6,50) QNAME, YEAR
C
C      CALCULATION FOR ONE YEAR
C
110     JF=0
111     DO 390 M=1,12
C
C      CLFAR MONTHLY SUM
C
112     SQ=0.
113     SQE=0.
C
C      SFT JS, JF FOR EACH MONTH
C
114     JS=JE+1
115     JE=JE+MONTH(M)
C
C      CALCULATION FOR ONE MONTH
C
116     DO 350 J=JS,JE
C
C      CALCULATION OF RUNOFF FOR EACH SUB-BASIN
C
117     DO 300 K=1,NP
C
C      OBSERVED DAILY PRECIPITATION IS MODIFIED
C
118     PX=P(J,K)*PC(K)
C
119     PY=0.
120     SK=0.
C

```

```

C   SET TI FOR CONVENIENCE
C
121  TI=T(J,K)
C
C   CALCULATION OF SNOW DEPOSIT AND SNOW MELT IN EACH SUB-BASIN
C
122  DO 230 I=1,IZONE
C
C   CALCULATION OF THE DERIVED MEAN AREAL PRECIPITATION
C
123  PN=(1.+PD(I,K)*PCM(M))*PX
C
C   TEMPERATURE IS NEGATIVE OR NOT
C
124  IF (TI.GE.0.) GO TO 200
C
C   ALL OF PN IS CHANGED TO SNOW
C
125  SNOW(I,K)=SNOW(I,K)+PN
126  GO TO 220
C
C   CALCULATION OF THE VOLUME OF THAWING
C
127  200 SM=(SMELT*TI)+(0.0125*PN*TI)
128  SNOW(I,K)=SNOW(I,K)-SM
C
C   IF SNOW(I,K) IS NEGATIVE, SNOW AND SM ARE ADJUSTED
C
129  IF (SNOW(I,K).GE.0.) GO TO 210
130  SM=SM+SNOW(I,K)
131  SNOW(I,K)=0.
C
C   CALCULATION OF PY BY CUMULATING THE WEIGHTED (PN + SM)
C
132  210 PY=PY+(PN+SM)*ZA(I,K)
C
C   CALCULATION OF THE SNOW DEPOSIT
C   BY CUMULATING THE WEIGHTED SNOW
C
133  220 SK=SK+SNOW(I,K)*ZA(I,K)
C
C   OBTAIN THE UPPER ZONE TEMPERATURE
C
134  TI=TI-TD(K)
C
135  230 CONTINUE
C
C   CALUCLATION OF SNOW DEPOSIT OF THE WHOLE BASIN
C
136  ST(J)=ST(J)+SK*WE(K)
C
C
137  250 IF (PX.GT.0.) GO TO 260
C

```

```

C SUBTRACTION OF EVAPORATION: EVAPORATION IS SUBTRACTED
C FROM THE TOP TANK IF THERE IS ENOUGH WATER, IF NOT,
C THE DEFICIT IS SUBTRACTED FROM THE SECOND TANK, AND SO ON
C
138     XA(K)=XA(K)-EVAP(M)
139     IF (XA(K).GE.0.) GO TO 260
140     XB(K)=XB(K)+XA(K)
141     XA(K)=0.
142     IF (XB(K).GE.0.) GO TO 260
143     XC(K)=XC(K)+XB(K)
144     XB(K)=0.
145     IF (XC(K).GE.0.) GO TO 260
146     XD(K)=XD(K)+XC(K)
147     XC(K)=0.
148     IF (XD(K).LT.0.) XD(K)=0.
C
149     260 CONTINUE
C
C
C     CALCULATION OF DISCHARGE AND INFILTRATION
C
150     CALL TANK3 (PY,XA(K),YA,YA0,HAS,HA1,HA2,HA3,A0,A1,A2,A3)
C
151     CALL TANK2 (YA0,XB(K),YB,YB0,HBS,HB1,HB2,B0,B1,B2)
C
152     CALL TANK1 (YB0,XC(K),YC,YC0,HC1,C0,C1)
C
153     CALL TANK1 (YC0,XD(K),YD,YD0,HD1,D0,D1)
C
C     CALCULATION OF QD, QC, QB, QA BY MAKING WEIGHTED MEAN
C WITH TIME LAG
C
154     JL=J+LAG(K)
155     QD(JL)=QD(JL)+YD*WE(K)
156     QC(JL)=QC(JL)+(YD+YC)*WE(K)
157     QB(JL)=QB(JL)+(YD+YC+YB)*WE(K)
158     QA(JL)=QA(JL)+(YD+YC+YB+YA)*WE(K)
C
159     300 CONTINUE
C
C     MONTHLY TOTAL OF Q
C
160     SQ=SQ+Q(J)
161     SQE=SQE+QA(J)
C
162     350 CONTINUE
C
C     PRINT: MONTHLY TATAL OF Q,
C           MONTHLY END-VALUE OF STORAGE OF EVERY TANK,
C           MONTHLY END-VALUE OF SNOW OF EVERY ZONE
C
163     WRITE (6,60) M,SQ,SQE
C
164     DO 360 K=1,NP

```



```

190      AM=1H
191      IF (J.NE.JS) GO TO 550
192      AM=CM(M)
      C
193      DO 540 N=1,NSCAL
194      IPOS=ISCAL(N)
195      540  GBUF(IPOS)=1HI
      C
196      550  PLOT(1)=Q(J)+Q0
197      PLOT(2)=QA(J)+Q0
198      PLOT(3)=QB(J)+Q0
199      PLOT(4)=QC(J)+Q0
200      PLOT(5)=QD(J)+Q0
      C
201      NX=NPLOT
202      560  IF (PLOT(NX).GT.YMIN+Q0) GO TO 570
203      IPOS=1
204      GO TO 580
      C
205      570  IPOS=(ALOG10(PLOT(NX))-AMIN)*DY+1.
206      IF (IPOS.LE.0) IPOS=1
207      IF (IPOS.GT.LY) IPOS=LY
      C
208      580  GBUF(IPOS)=GHAR(NX)
209      NX=NX-1
210      IF (NX.GT.0) GO TO 560
      C
211      WRITE (6,90) AM,Q(J),QA(J),ST(J),(GBUF(L),L=1,LY)
212      90  FORMAT(1H A1,2F7.2,F6.0,110A1)
      C
213      590  CONTINUE
      C
      C
214      IF (YEAR.LT.LYEAR) GO TO 2000
215      GO TO 1000
216      END

```

YTFTC

```
1      SUBROUTINE TANK3(P,X,Y,Y0,HS,H1,H2,H3,A0,A1,A2,A3)
2      X=X+P
3      Y=0.
4      IF (X.LE.H1) GO TO 100
5      Y=(X-H1)*A1
6      IF (X.LE.H2) GO TO 100
7      Y=Y+(X-H2)*A2
8      IF (X.LE.H3) GO TO 100
9      Y=Y+(X-H3)*A3
10     100 XS=X
11     IF (XS.GT.HS) XS=HS
12     Y0=XS*A0
13     X=X-Y0-Y
14     RETURN
15     END
```

YTFTC

```
1      SUBROUTINE TANK2(P,X,Y,Y0,HS,H1,H2,A0,A1,A2)
2      X=X+P
3      Y=0.
4      IF (X.LE.H1) GO TO 100
5      Y=(X-H1)*A1
6      IF (X.LE.H2) GO TO 100
7      Y=Y+(X-H2)*A2
8     100 XS=X
9     IF (XS.GT.HS) XS=HS
10     Y0=XS*A0
11     X=X-Y0-Y
12     RETURN
13     END
```

YTFTC

```
1      SUBROUTINE TANK1(P,X,Y,Y0,H1,A0,A1)
2      X=X+P
3      Y=0.
4      IF (X.GT.H1) Y=(X-H1)*A1
5      Y0=X*A0
6      X=X-Y0-Y
7      RETURN
8      END
```

(Manuscript received 12 May 1975)