

Kristina Radić

**Nitric oxide synthase expression and activity
in cell models relevant to human
pathophysiology**

DIPLOMA THESIS

Committed to University of Zagreb, Faculty of Pharmacy and Biochemistry

Zagreb, 2015

This diploma thesis is reported at the course of Biological Chemistry, University of Zagreb Faculty of Pharmacy and Biochemistry and is composed on the Department of Biochemical Sciences “Alessandro Rossi Fanelli” under the professional supervision of Professor Jerka Dumić in cooperation with Professor Paolo Sarti.

ACKNOWLEDGEMENTS

I would like to express my deep gratitude to my supervisor Professor Jerka Dumić for giving me, within collaboration with Professor Luciano Saso, the opportunity to work on this project at the Sapienza University but also for her continued support and patience.

This project is held at the Department of Biochemical Sciences in Rome and was born under the supervision of Professor Paolo Sarti, to whom I wish to dedicate special thanks for providing me the possibility to work in his laboratory. I want to thank him for his enthusiasm and scientific passion as well as for his fun spirit meritorious for daily good laughs.

I would like to acknowledge all Professor Sarti’s lab members and collaborators, for all they shared with me and especially for their patience with my Italian: Dr. Elena Forte, Dr. Alessandro Giuffrè, Dr. Marzia Arese, Dr. Micol Falabella, Dr. Maria Chiara Magnifico, Francesca Malagrino and Karim Zuhra. Very special thanks I wish to dedicate Dr. Micol Falabella for guiding me through all the experiments with great passion and making me fall in love with science even more. Together with Dr. Elena Forte I would like to thank you for your time spent in correcting this thesis. Also, I would like to thank Dr. João Vicente for his wise advice and big heart.

Above all, I am expressing my deepest gratefulness to my numerous family, especially to my mother to whom I dedicate this work. Not even a thought of it would have been possible without your unconditional love and support.

Last but not least, I would like to express gratitude to my boyfriend Vlatko and to all of my friends especially to Lucija, Anamarija, Eva, Ivana and Kristina for sharing all hard moments with me during this challenging period making them unforgettable.

Table of content

1. INTRODUCTION	1
1.1. NITRIC OXIDE and NITRIC OXIDE SYNTHASES.....	1
1.2. MITOCHONDRIA.....	5
1.2.1. Oxidative phosphorylation.....	7
1.3. MITOCHONDRIAL DISEASES.....	11
1.3.1. Leber’s hereditary optic neuropathy.....	15
2. AIM OF THE PROJECT	17
3. METHODS AND MATERIALS	18
3.1. CELL CULTURES.....	18
3.1.1. Cell lines.....	18
3.1.2. Mycoplasma detection test.....	19
3.1.3. Cells cryopreservation and resuscitation	20
3.2. CELL VIABILITY ASSAY.....	21
3.3. PROTEIN CONTENT QUANTIFICATION.....	22
3.3.1. Bradford assay.....	22
3.3.2. Bicinchoninic Acid assay (BCA).....	23
3.4. QUANTITATIVE REAL TIME POLYMERASE CHAIN REACTION.....	24
4. RESULTS AND DISCUSSION	30
4.1. MYCOPLASMA DETECTION TEST.....	30
4.2. CELL VIABILITY ASSAY.....	30
4.3. EXPRESSION OF NOS _s mRNA LEVELS.....	32
5. CONCLUSION	35
6. LITERATURE	36
7. SUMMARY	40

1. INTRODUCTION

1.1. NITRIC OXIDE and NITRIC OXIDE SYNTHASES

Nitric oxide (NO \cdot) is a fairly stable and highly diffusible gas signalling molecule with a crucial role in animal pathophysiology [Wink and Mitchell, 1998]. In eukaryotic cells NO \cdot is mostly synthesized by a family of enzymes called NO synthases (NOSs). Three different isoforms of NOS are expressed in mammals and differ in their functions. The neuronal NOS (nNOS or NOS1) and endothelial NOS (eNOS or NOS3), named after the tissue in which they were first identified, are expressed constitutively, but can be also acutely activated by protein kinases or calcium. Under normal metabolic conditions NOSs usually generate NO \cdot for signalling purposes. In the nervous system NO \cdot is known to promote signal transmission between neurons, whereas at the level of endothelial cells, it regulates the vascular tone by inhibiting smooth cells contraction and platelet aggregation. The inducible NOS (iNOS or NOS2), releases large amount of NO \cdot and for longer period than the other NOSs in response to proinflammatory or inflammatory mediators (*e.g.* cytokines). NO \cdot produced by iNOS represents an important defence mechanism against pathogens in the innate immune responses [Liew and Cox, 1991]. Signals able to trigger the NOS2 expression leading to inflammatory cascade activation can be for example bacterial lipopolysaccharide or cytokines.

NOS enzymes are able to produce NO \cdot by catalysing the oxidation of L-arginine to L-citrulline through a two successive mono-oxygenation reactions (Fig. 1) [Alderton et al., 2001]; the NOS exists as a homodimer. Each monomer can be structurally and functionally divided in two main domains: a C-terminal reductase domain and an N-terminal oxygenase domain. The C-terminal domain contains the binding site for one of each molecule: NADPH, FMN and FAD; whereas the N-terminal binds haem and tetrahydrobiopterin as cofactors as well as L-arginine. To become active each enzyme must assemble into dimers, which are specifically designed to enable electron transfer from the reductase domain of one monomer to the oxygenase domain of the other.

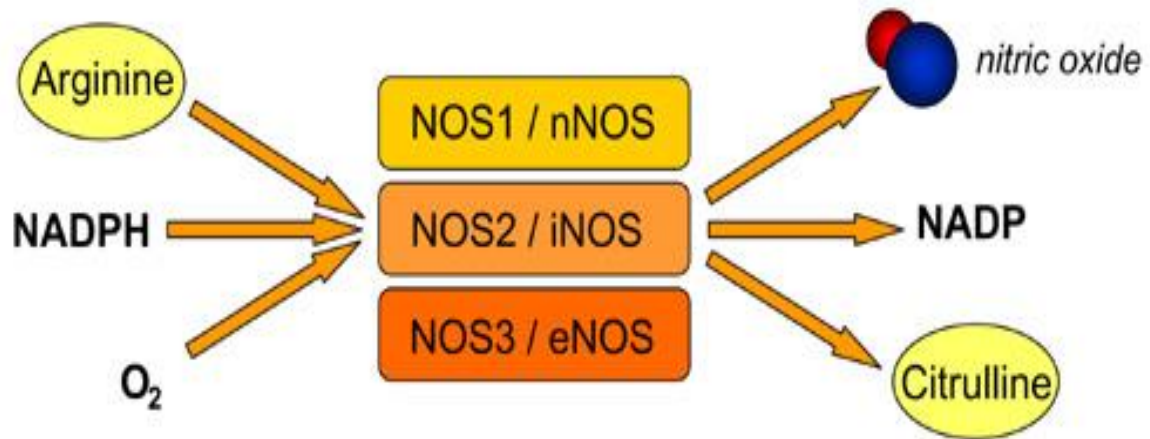

Figure 1. Scheme of NO· synthesis [from University of Reading website]

Notably NO· is involved in several processes, such as blood vessel dilation, regulation of the immune function, neurotransmission in the brain and in the peripheral nervous system and modulation of mitochondrial respiration. It can work, depending on its intracellular concentration and localization, as a physiological signalling molecule or as a toxic agent for both parasitic and human cells [Poole, 2005].

NO· exerts its signalling functions either by binding to the haeme iron of guanylyl cyclase (GC), triggering GC activation, cyclic GMP production and leading to consequent downstream target modifications [Michell et al., 2001], or through post-translational protein modifications. This latter event occurs usually for S-nitrosation of cysteine residues or nitration of tyrosine groups. The control of cell survival is strictly dependent on NO· concentration: at low doses it inhibits programmed cell death; at higher doses instead, it is lethal. The threshold at which NO· can act as a pro apoptotic molecule varies considerably with the cell type. The anti-apoptotic pathways are mainly regulated by NO· caspases inactivation due to S-nitrosation; the apoptotic events are instead linked to p53, a well-established tumour suppressor and transcriptional activator [Messmer et al., 1994].

NO· has a crucial role in cytotoxic events (Fig. 2) due to its radical nature. NO· is a molecule able to react with various cell constituents as molecular oxygen (O₂), superoxide (O₂⁻), transition metals in a free or complexes form and nucleophilic centres in proteins [Stroes et al., 1998]. Superoxide for example can itself combine with nitric oxide generating peroxynitrite anion (ONOO⁻), a harmful molecule with high oxidant power able to diffuse through cells damaging proteins, lipids and DNA bases [Szabo and Ohshima, 1997]. These reactions are very useful in protecting our organism from parasites but their persistence may result fatal for cell survival. Therefore, in order to cope with oxidative and nitrosative stress and keep the level of reactive chemical species within a physiological not harmful range, the human organism has developed an efficient antioxidant system. (Fig. 3) [Krauss, 2003].

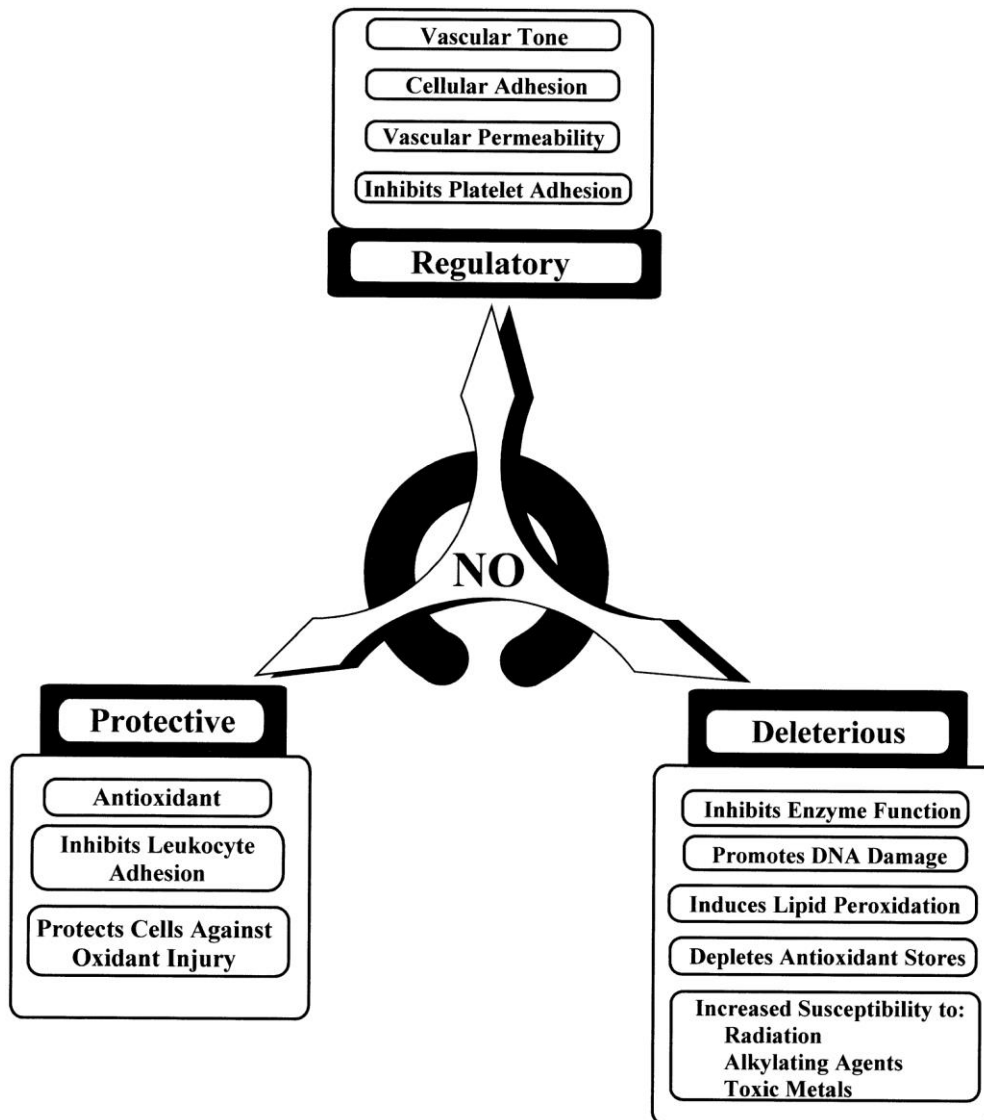

Figure 2. Roles of NO· in mammals [from Grisham M. B. et al. 1999]

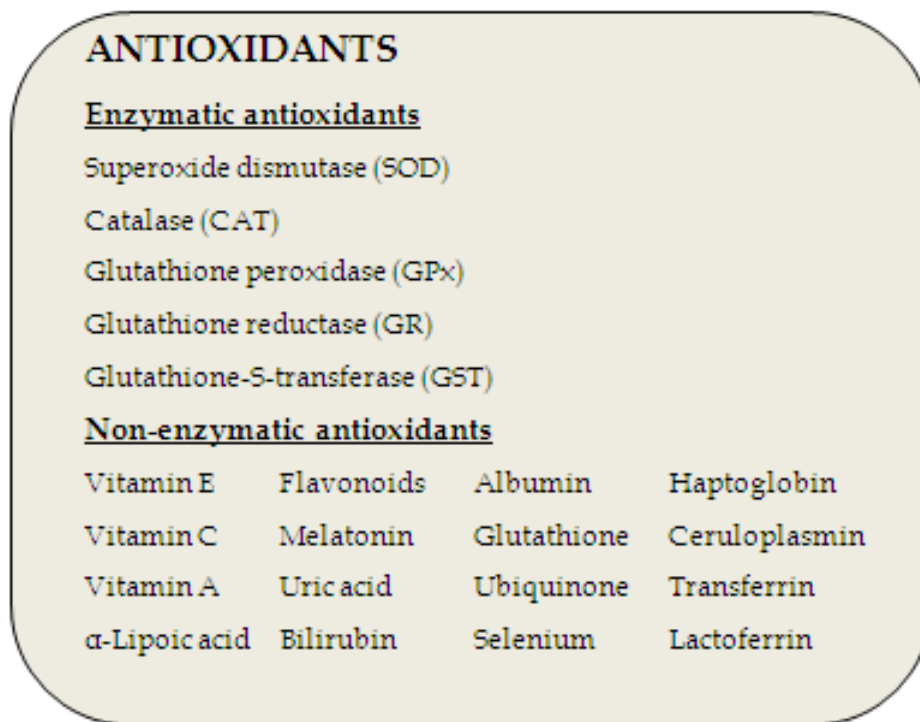

Figure 3. Human antioxidant system

From the pharmacological point of view, $\text{NO}\cdot$ has been demonstrated as an important agent for treatment of several disease conditions [Wink and Mitchell, 1998]. According to this beneficial property, various prodrugs able to release $\text{NO}\cdot$ at specific site have been developed. Due to its free radical nature $\text{NO}\cdot$ is a very reactive molecule with a rapid rate of diffusion in biosystems and also a fairly short half-life [Archer, 1993] that depends on cell environment or medium composition. One of the main challenges for researchers has been to find out the optimal rate of $\text{NO}\cdot$ release from $\text{NO}\cdot$ donors or persistence into bioenvironments for a number of specific conditions [Ignarro et al., 2002].

After the discovery that several mechanisms involved in the maintenance of blood pressure in vivo (*e.g.* smooth muscle relaxation) use $\text{NO}\cdot$ as an intermediary, this molecule became an interesting potential agent in the treatment of cardiovascular diseases, diffused worldwide [Naseem, 2005]. Taking advantage of the $\text{NO}\cdot$ ability to induce relaxation of the smooth muscle cells of blood vessels (Fig. 4), several pharmacological $\text{NO}\cdot$ -releasing compounds have been developed with a prolonged half-life (several hours) and a reduced incidence of drug tolerance compared to conventional $\text{NO}\cdot$ donors as for example nitroglycerin, a drug widely used for decades in the treatment of angina pectoris [Murray et al., 2003].

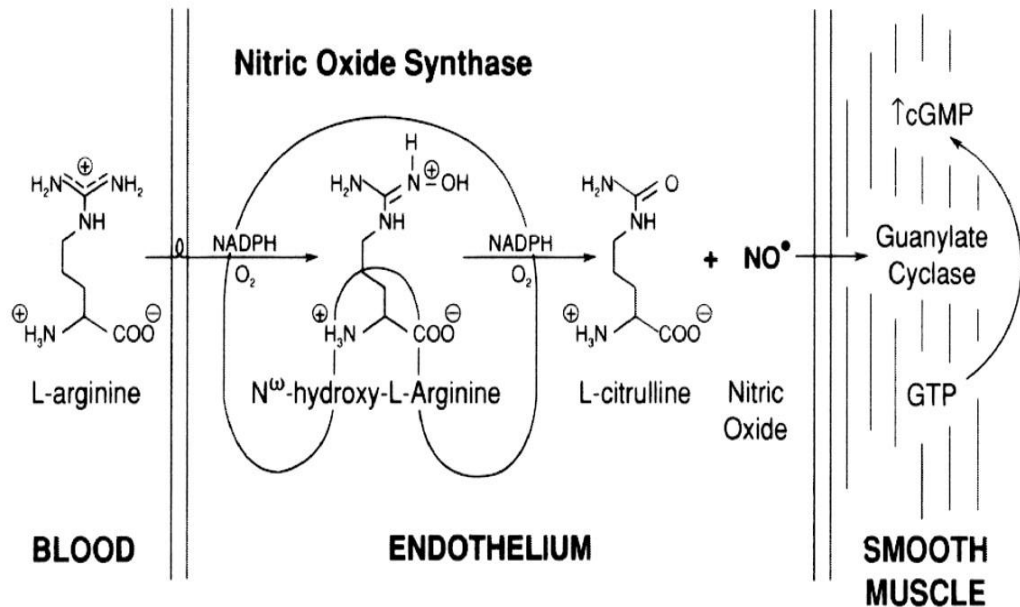

Figure 4. Synthesis of NO \cdot in endothelium and signal transmission in smooth muscle [from annals.org website]

1.2. MITOCHONDRIA

Mitochondria are the eukaryotic cell organelles responsible for the most of useful energy derived from carbon sources and converted to adenosine triphosphate (ATP) during the oxidative phosphorylation [Karp, 2010]. According to the endosymbiotic theory, mitochondria represent formerly free-living aerobic bacteria taken inside by primeval anaerobic eukaryotes around 1.5 billion years ago [Martin and Muller, 1998]. The mitochondria structure may validate this theory since they have a double membrane system: a smooth outer membrane and a noticeably folded inner membrane that enclose the mitochondrion matrix (Fig. 5) [Alberts et al. 2002]. Like its bacterial ancestor, the mitochondrial inner membrane has a structure very similar to prokaryotes containing, instead of cholesterol, cardiolipin- a typical component of prokaryotic membranes [Frey and Mannella, 2001].

The folds of inner membrane are called *cristae*; they increase the mitochondrial surface and contain five enzymatic complexes forming the oxidative phosphorylation system [Perkins et al., 1997]. Another proof for bacterial origin of mitochondria is the presence of their own DNA that is separated from the nuclear genome and encodes for 13 proteins involved in the electron transfer and oxidative phosphorylation, 2 ribosomal RNA (rRNAs) and 22 transfer RNAs (tRNAs) [Kurland and Andersson, 2000].

Mitochondrial DNA (mtDNA) is a maternally inherited circular molecule of 16,569 nucleotides. It is a multi copy genome whose number of molecules depends on tissue activity and energy demand [Mehrabian et al., 2005]. As nuclear DNA (nDNA), mtDNA is susceptible to point mutations but, due to its features, the results are more deleterious than in the nuclear DNA. Being located next to the oxidative phosphorylation machinery, where formation of reactive oxygen species can occur, the mitochondrial genome is more exposed to oxidative stress [Doudican et al., 2005]. Moreover it lacks protective histones and has a simple DNA repairing system [Wei, 2014]. Taken all together, these characteristics lead to a higher susceptibility of mtDNA to oxidative stress, brakes and point mutations.

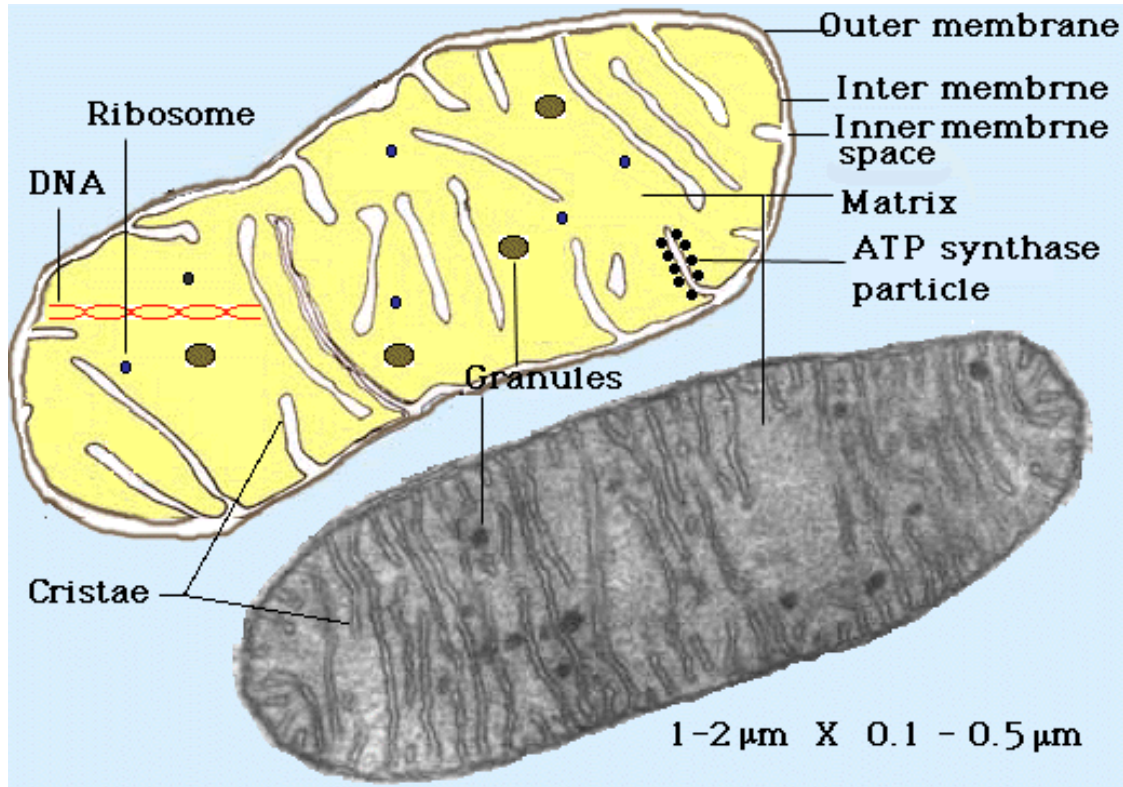

Figure 5. Mitochondria structure scheme and microscopic photography [from thescienceupdate.blogspot.it website]

1.2.1. Oxidative phosphorylation

Oxidative phosphorylation (OXPHOS) is one of the most important functions of mitochondria made possible due to specific mitochondrial membrane features. The mitochondrial outer membrane is porous whereas the inner membrane acts as a barrier to the movement of many biological metabolites [Mathews et al., 2000]. Carefully selected metabolites are transported across the inner membrane with the assistance of proteins that are placed on it in a large number [Berg et al., 2000].

Oxidative phosphorylation is the main pathway to obtain energy (ATP) in mammalian cells. In fact, carbohydrates, fats and proteins are oxidized firstly in the cell cytosol and then in the mitochondrial matrix in a process known as Krebs cycle (Fig. 6). During these processes, NAD^+ and FAD^{2+} are reduced and their reduced equivalents, NADH and FADH_2 , are accumulated within the cell [Murray et al., 2003].

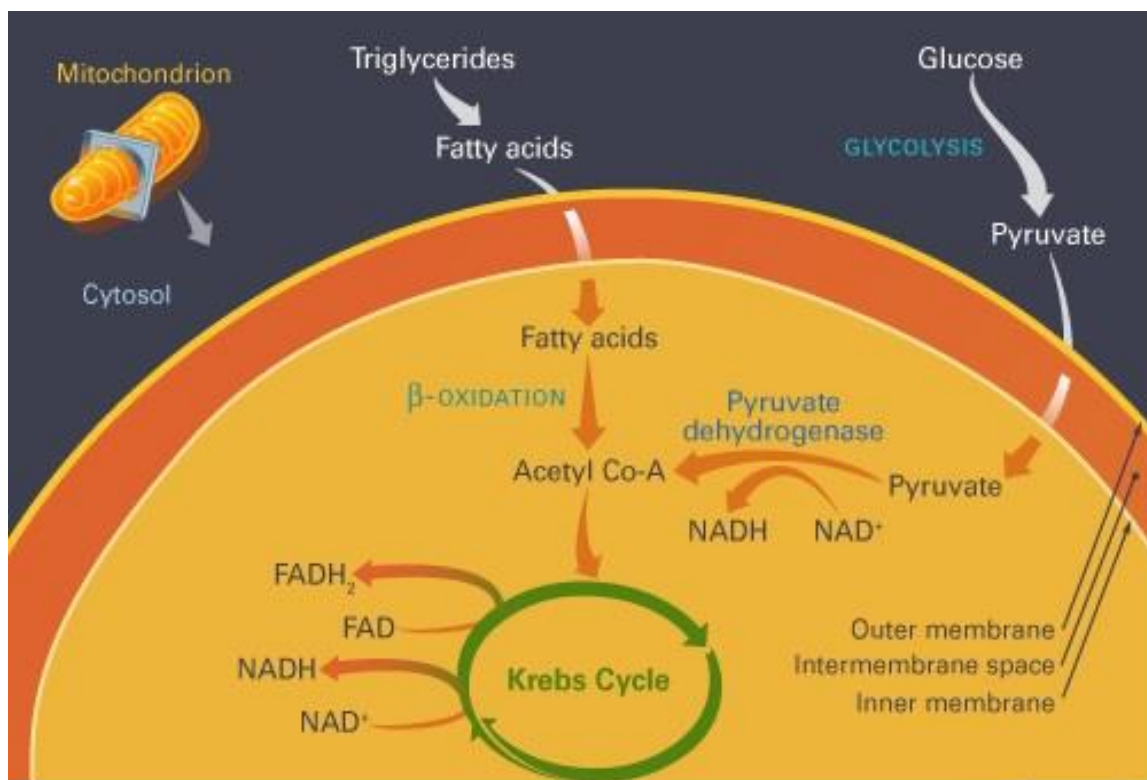

Figure 6. Degradation of triglycerides and glucose and synthesis of NADH and FADH_2
[from aziendanatura.it website]

During oxidative phosphorylation, electrons from reduced NADH and FADH₂ are transferred along the redox carriers constituting the respiratory chain located in the inner mitochondrial membrane. These are four multi-subunits protein complexes (I, II, III and IV) and two smaller carriers (coenzyme Q and cytochrome c). Complex I accepts electrons from the NADH while Complex II is an entry point for electrons from the FADH₂. Carried by coenzyme Q and subsequently by Complex III and cytochrome c, electrons flow through the Complex IV and are donated to the oxygen molecule forming water using H⁺. At the level of complexes I, III and IV, the free energy (ΔG) released by the redox reaction accounting for electrons transfer, is used to translocate protons (H⁺) from the mitochondrial matrix into the intermembrane space. This vectorial accumulation of protons generates both a chemical and an electrical potential gradient across the inner membrane, which is used as a proton-motive force to drive ATP synthesis, the so-called $\Delta\mu\text{H}^+$ [according to Mitchell et al. 2001]. This is done in the presence of Pi and ADP by a special multisubunit enzyme also located on the inner membrane and called ATP synthase (F₀F₁ ATPase or complex V). One of its subunits, F₀, allows the flow of protons down the gradient. The proton-motive force allows rotational catalysis and consequently binding ADP and inorganic phosphate into ATP with the assistance of a subunit called F₁ [Murray et al., 2003]. The exchange of ATP with ADP from inside of the mitochondrion to outside is catalyzed by the ATP/ADP translocase [Gilbert, 2000].

Oxidation of every FADH₂ leads to synthesis of 2 ATP whereas 3 ATP molecules are formed upon oxidising one NADH [Mathews et al., 2000]. Each respiratory complex includes a number of different coenzymes, such as flavins (FMN or FAD in complexes I and II), iron-sulphur clusters (in I, II and III) and haem groups (in II, III and IV) [Berg et al., 2000].

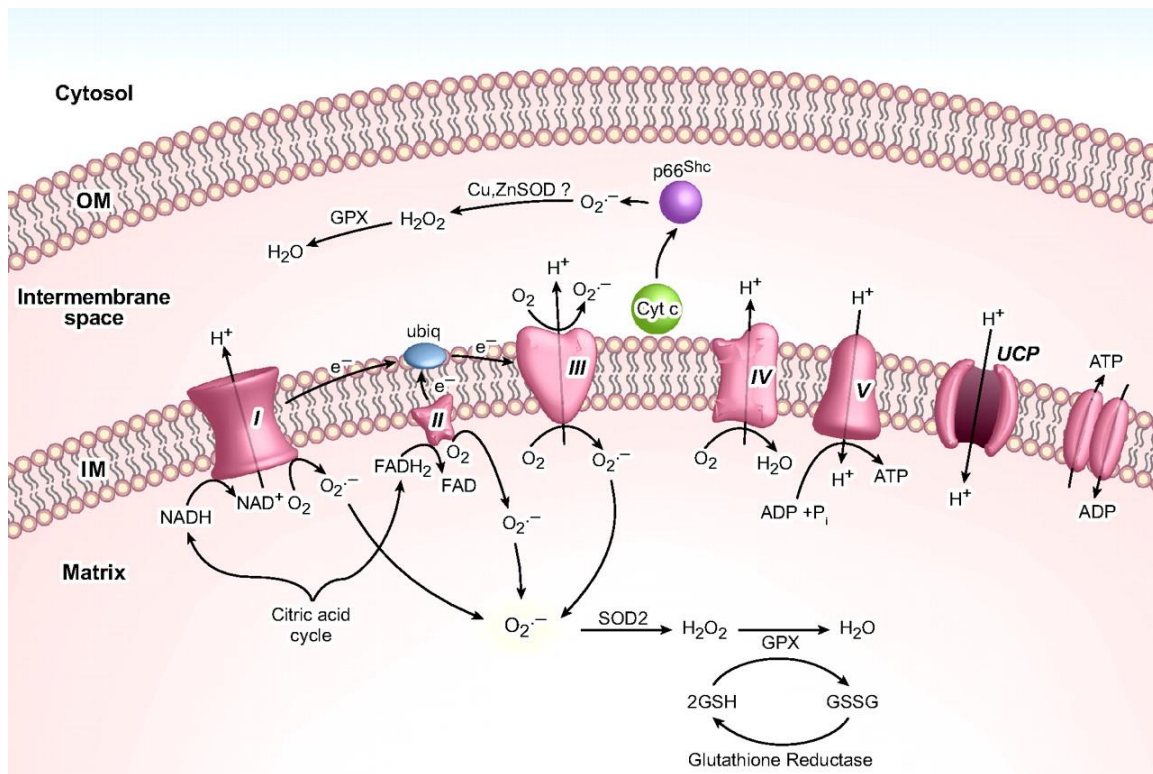

Figure 7. Electron transport and oxidative phosphorylation systems [from cicres.ahajournals.org website]

Mitochondrial respiration is the main and the most efficient way used by the cell to obtain the energy but on the other side, it is the source of reactive oxygen species that can react with $\text{NO}\cdot$ (see Fig. 7). These reactive oxygen and nitrogen species (RONS) can be eliminated enzymatically (*e.g.* by glutathione peroxidase or manganese superoxide dismutase) and/or non-enzymatically (cytochrome c, ascorbic acid or vitamin E) [Nickel et al., 2014]. $\text{NO}\cdot$ is known to control mitochondrial respiration by inhibiting many OXPHOS components, always and primarily complex IV but also complex I, depending on experimental conditions. Prolonged inhibition of OXPHOS following the overproduction of RONS leads to ATP deficiency and consequently to cell death via apoptosis or necrosis.

Reaction with complex IV occurs at nanomolar $\text{NO}\cdot$ concentration, is quick and reversible, while inhibition of complex I occurs after a long exposure to much higher concentration of $\text{NO}\cdot$ (millimolar). Inhibition of complex IV (cytochrome oxidase) takes place at the binuclear haem $\text{a}_3\text{-Cu}_B$ active site and the occurrence of the inhibition strongly depends on the electron flux through the respiratory chain as well as the relative concentrations of O_2 and $\text{NO}\cdot$ [Sarti et al., 2000 and Vicente, 2014].

Complex I, also called NADH-coenzyme Q reductase, is the entry point for electrons into the respiratory chain and it is consisted of 46 separate polypeptide chains. As prosthetic groups, there are tightly bound FMN-containing flavoprotein and at least six iron-sulphur centres, which undergo cyclic oxidoreduction between ferrous and ferric state (Fig. 8) [Mathews et al., 2000]. Complex I is considered one of the major cellular ROS sources, produced principally at the coenzyme Q-binding and the flavin mononucleotide sites [Lin et al., 2012]. $\text{NO}\cdot$ inhibits complex I via S-nitrosation of Cys39 exposed on ND3 surface. This reaction depends on the structural conformation of the complex, which is conditioned by the availability of O_2 and mitochondrial NADH [Sarti et al., 2012]. Moreover, this S-nitrosation regulates different functions, like control of ROS generation and cytoprotection after I/R (ischemia and suddenly reperfusion condition) [Sarti et al., 2012].

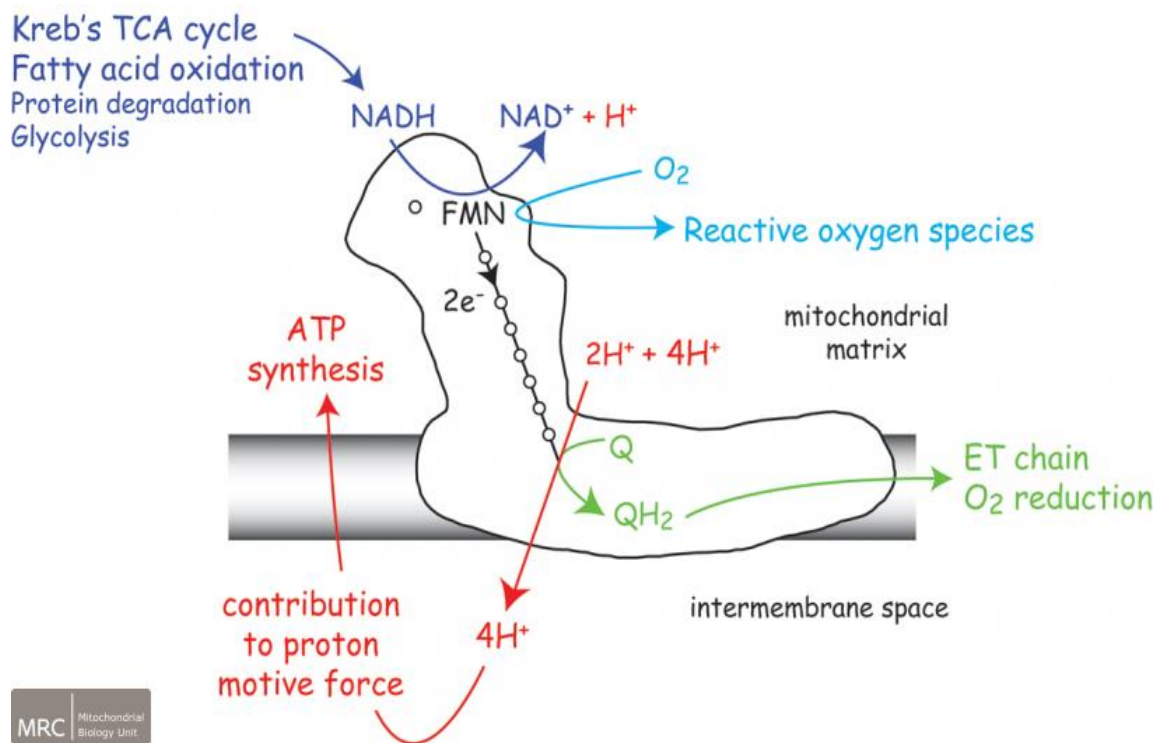

Figure 8. Complex I structure and function in electron transport system [from biochemj.org website]

1.3. MITOCHONDRIAL DISEASES

Mitochondrial diseases are disorders caused by mutations in the mtDNA or nDNA genes encoding for proteins involved in the mitochondrial respiratory chain function [McFarland et al., 2010]. These disorders have a worldwide prevalence estimated around 1:8500 [Arpa et al., 2003] and at moment they lack efficient therapies. These disorders are clinically heterogeneous; most of them affect both muscles and brain (mitochondrial encephalomyopathies), since the activity of these systems is highly dependent on the ATP availability (Fig. 9) [Mann et al., 1992]. Common diseases, such as Alzheimer's and Parkinson's disease, may be also correlated with variations of mitochondrial genome [Taylor and Turnbull, 2005]. As mentioned above (chapter1.2), 13 mitochondrial proteins are encoded by the mitochondrial genome and more than 70 mitochondrial proteins are encoded by the nuclear genome, synthesized in cytoplasm and subsequently imported inside the organelles [Anderson et al., 1981]. Complex II, coenzyme Q and cytochrome c are completely encoded by nDNA while mtDNA encodes for seven subunits of complex I (ND1-ND4, ND4L, ND5 and ND6), one of complex III (cytochrome b), three of complex IV (COXI-COXIII) and two of complex V (ATPase6 and ATPase8) [Carelli et al., 2004].

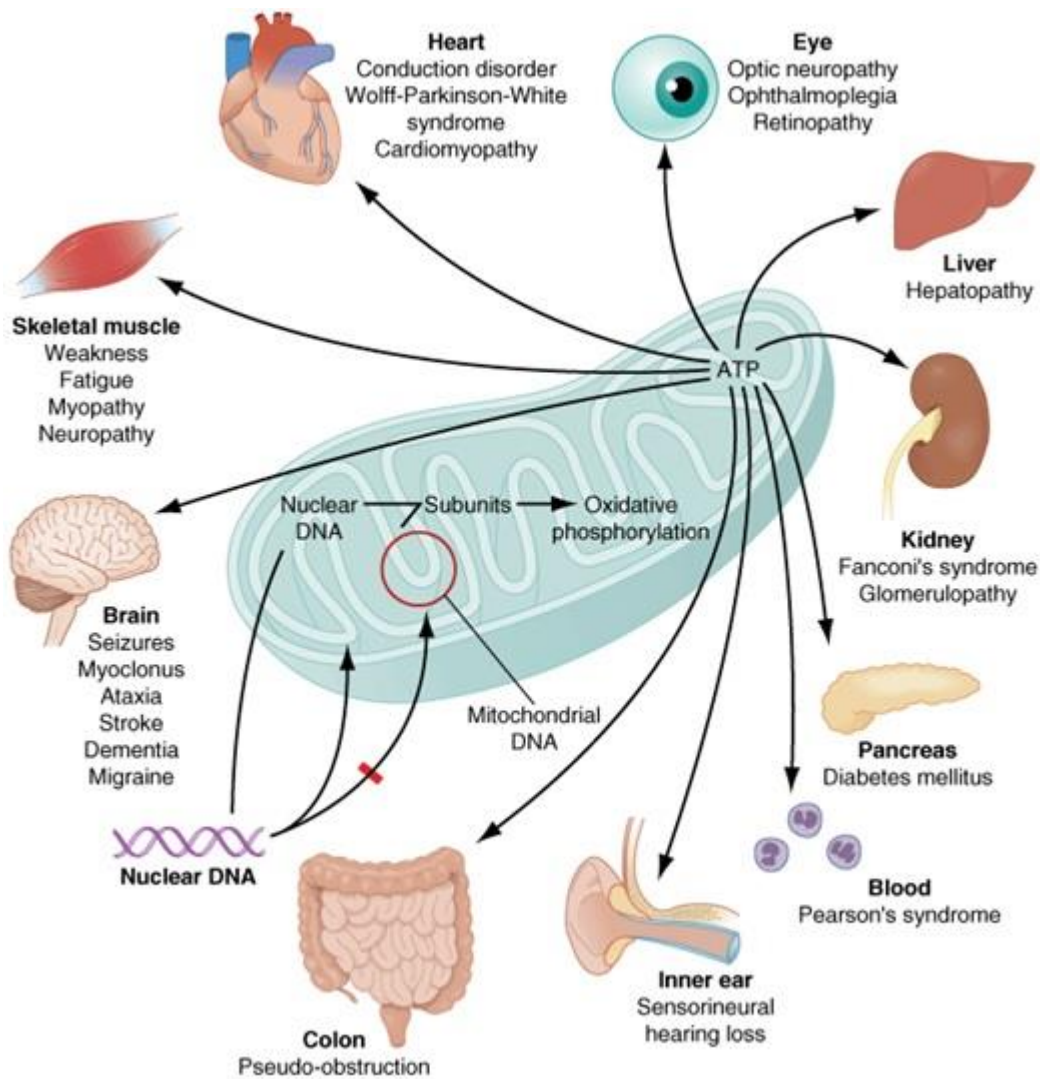

Figure 9. Organs and systems more sensitive to mitochondrial dysfunctions [from accessmedicine.com website]

The number of mitochondria in each cell is highly variable (from few hundreds to thousands) and depends on cell activity and metabolism; in those tissues with a high metabolic activity (*e.g.* brain, heart and skeletal muscle) it can reach 2000 copy per cell [Alberts et al., 2002]. In normal cells all mtDNA molecules are identical, a situation known as “homoplasmy”; on the contrary when a deleterious mutation is present it can affect just a portion of mtDNA in a condition called “heteroplasmy” (Fig. 10) [Wallace and Chalkia, 2013]. It is therefore clear that the relative proportion of non-mutated and mutated mtDNA is responsible for causing a mitochondrial disease that occurs when a certain amount of wild-type mtDNA is insufficient to compensate for the mutant mtDNA in a specific organ and tissue of the individual [DiMauro and Davidzon, 2005].

In normal conditions mtDNA is **HOMOPLASMIC**
Many pathogenic mutations are **HETEROPLASMIC**

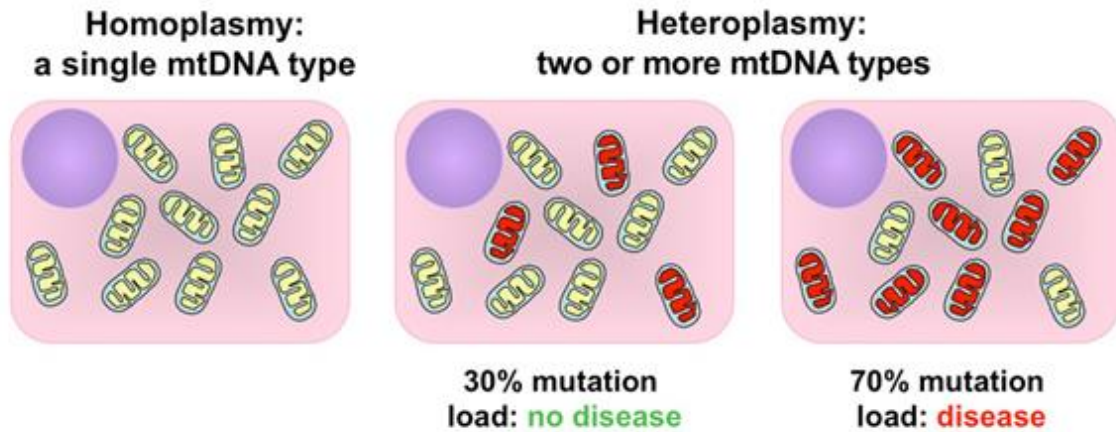

Figure 10. Possible proportions of wild type and mutated mitochondrial DNA

As already mentioned, mitochondrial disorders can be related to mtDNA point mutations or nuclear DNA protein-coding genes defects (Fig. 11). The first category includes syndromes like Leber's hereditary optic neuropathy (LHON), the most common mitochondrial disorder caused by specific mtDNA point mutations affecting complex I subunit genes; lactic acidosis and stroke-like episodes (MELAS), a disorder commonly associated with a mutation in position 3243A>G of the $\text{tRNA}^{\text{Leu(UUR)}}$ gene [Goto et al., 1990]; myoclonus epilepsy with ragged red fibers (MERRF, caused by the A8344G mutation in the tRNA^{Lys} gene of mtDNA) [Shoffner et al., 1990]; ataxia and retinitis pigmentosa (NARP) and maternally inherited Leigh syndrome (MILS), two clinically different disorders both associated to a mutation on the gene encoding for ATPase6 subunit [Di Mauro and Bonilla, 2004]. The group of disorders caused by defects in the nuclear DNA encoding for mitochondrial protein includes autosomal dominant optic atrophy (ADOA) and Friedreich's ataxia (FRDA).

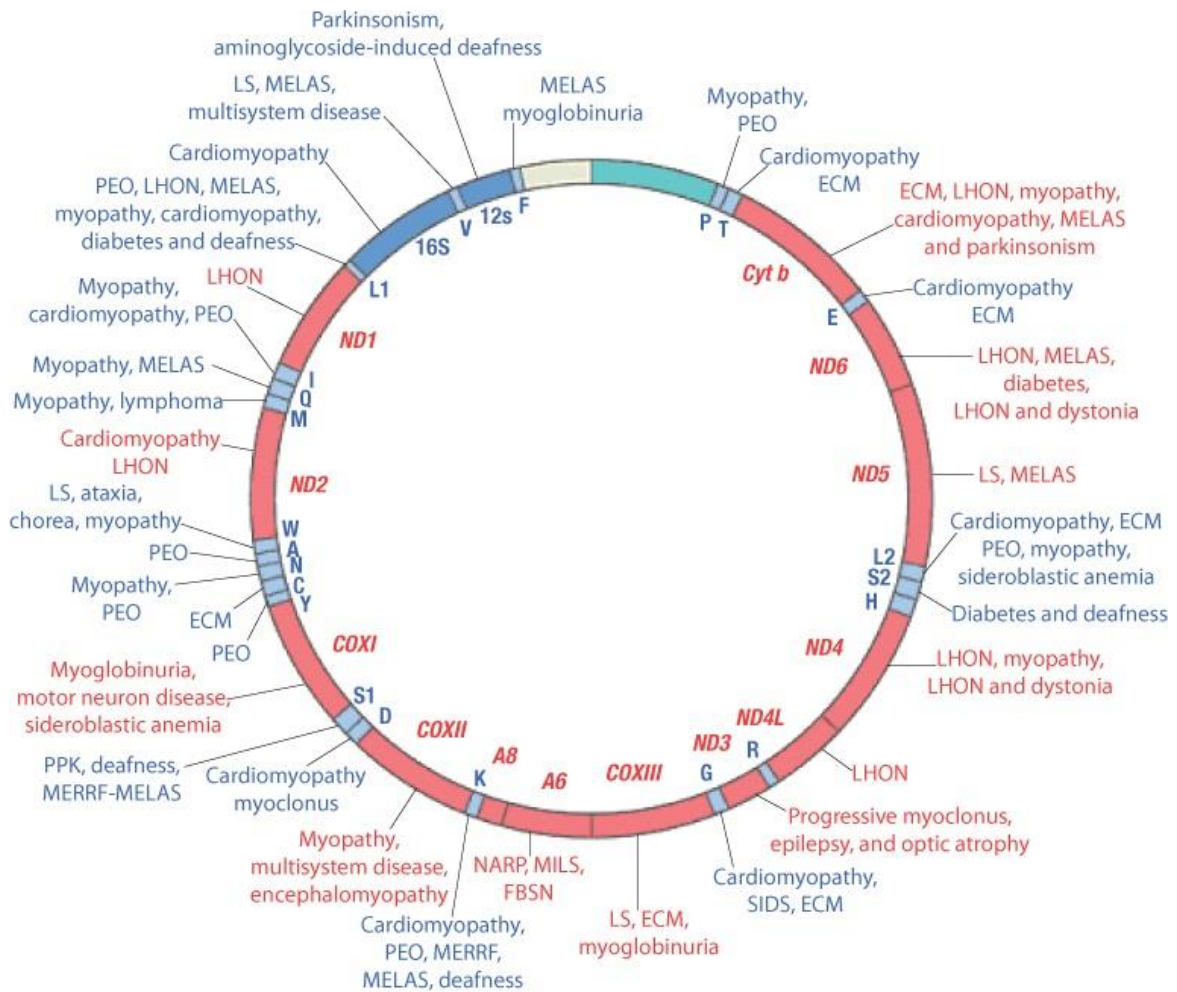

Figure 11. Mitochondrial genome coding subunits of the OXPHOS complexes and diseases arising from the specific mutations. Mutations impairing mitochondrial protein synthesis are shown in blue while mutations resulting in protein coding genes are shown in red [from clinicalgate.com website]

1.3.1. Leber's Hereditary Optic Neuropathy

LHON is a rare mitochondrial disease affecting usually young men in their early adulthood. It was described for the first time by the German ophthalmologist Theodor Leber in 1871. He was observing four families with young men members that were suffering from abrupt loss of vision in both eyes, either simultaneously or sequentially [Wallace, 1986].

LHON disorder is a central nervous system disease caused by single point mutations of those mtDNA genes encoding for Complex I subunits (Fig. 12). Several mutations were described but the most common ones (90-95%) are: G11778A in ND4, G3460A in ND1 and T14484C in ND6 [DiMauro and Davidzon, 2004]. LHON pathology is characterized by a dysfunction of the optic nerves leading to bilateral loss of vision due to retinal ganglion cells (RGCs) death [Lehninger et al., 2005], but can be accompanied by other neurological disorders. Some neuropathological studies of LHON show lesions in both white matter and in the optic nerve showing demyelization, vacuolisation, cystic necrosis, plaques and occasionally inflammatory cell infiltrates [Kovács, et al. 2004]. Moreover, several studies showed that LHON cell death is apoptotic [Battisti et al., 2004]

It is not clear yet why these mutations cause disorders primarily only in the RGCs and optic nerve even though they are widespread all around the body [Lin et al., 2012]. From the biochemical point of view mutated mitochondria are less effective in energy producing because of Complex I mutations. The cells attempt to gain energy both enhancing Complex II activity and compensating the OXPHOS failure overusing the glycolytic pathway. These strategies are not sufficient to supply the required ATP and the OXPHOS dysfunction leads to a chronic oxidative stress levels increase [Lehninger et al., 2005]. Studies performed on a LHON mouse model revealed that even though the mutated cells are able to maintain basal ATP levels, their viability is deeply damaged by the oxidative stress resulting from Complex I alteration [Lin et al., 2012]. In particular, it was demonstrated that under physiological conditions the antioxidant cells defence system is sufficient to balance the subtle mitochondrial dysfunction, but in presence of an increased metabolic demand, ROS production sensibly increases leading to cell damage and triggering the apoptotic pathway [Carelli et al. 2004].

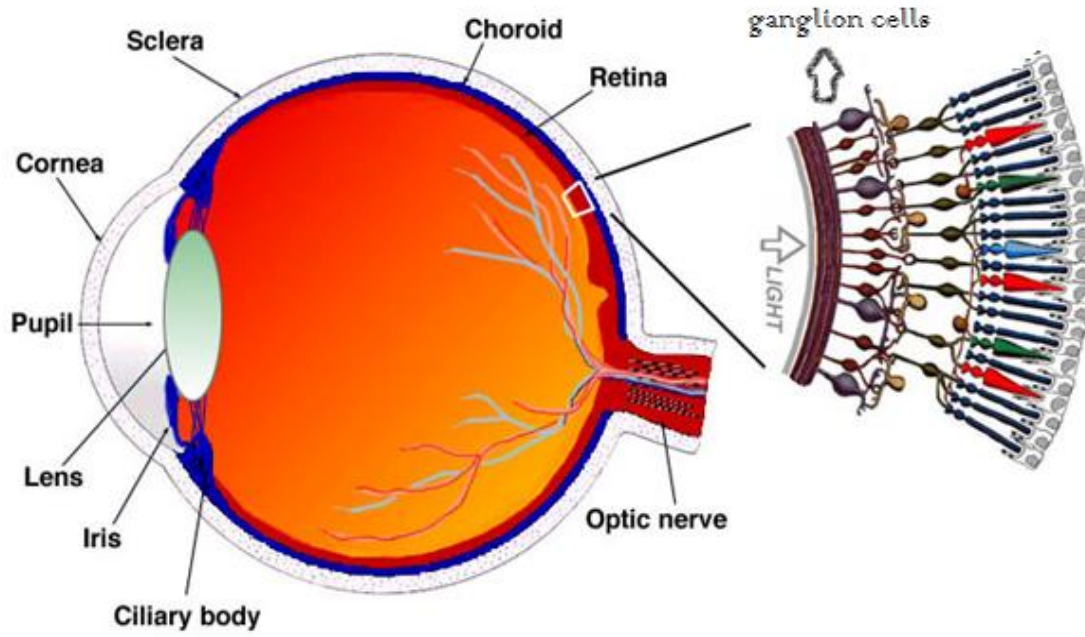

Figure 12. A schematic section through the human eye with a schematic enlargement of the retina [from webvision.med.utah.edu website]

2. AIM OF THE PROJECT

The first clinical description of a young man patient suffering from LHON was reported in the 1871, but only in the 1998 Wallace and colleagues discovered the first LHON-associated mutation in ND4 gene of mitochondrial DNA (mtDNA) coding for a subunit of mitochondrial Complex I. Since then, other mutations have been reported to be associated with LHON disorder and different pathogenic hypothesis have been proposed. Although several studies unravelled the main LHON features, several open questions about the pathophysiology of this disease still persist, making difficult the development of an efficient therapeutic approach.

As mentioned above, LHON is a disorder caused by mtDNA point mutations in the genes coding for the OXPHOS Complex I subunits. From the biochemical point of view the bioenergetics failure and the enhanced reactive oxygen species (ROS) production are the typical hallmarks of LHON disease, unable, however, to explain the late onset and the incomplete penetrance. It seems that the presence of the mutation is necessary but not sufficient to trigger the disease and other factors could be involved. Since LHON is characterized by a deficit in the oxidative phosphorylation chain and NO \cdot is an important signalling molecule exerting several pathophysiological actions in mammals, in particular is an established modulator of mitochondrial function, we have been wondering if it might have a role in the LHON development and progression.

The aim of this thesis work was to unravel the potential role of NO \cdot thus of the nitrosative stress, in the LHON pathophysiology. In order to address this issue we have set the protocols to measure the mRNA level of NOSs of LHON cells, and to test their viability when cultured in presence of the NO \cdot releaser DETA-NONOate.

3. MATERIALS AND METHODS

3.1. CELL CULTURES

3.1.1. Cell lines

The Leber's hereditary optic neuropathy (LHON) cell line was obtained from a female patient affected by A11778G LHON mutation. Healthy individuals of same sex and age were chosen as controls. Lymphoblast cell lines were established by Epstein - Barr virus (EBV) transformation of leukocytes isolated from the whole blood. All EBV-transformed cell lines were maintained in prescribed medium (RPMI 1640) supplemented with 20% heat inactivated fetal bovine serum (FBS), 2 mM L-glutamine, non-essential amino acids (100 units/mL penicillin and 100 mg/mL streptomycin) (Table 1) and grown in T25 cm² tissue culture flasks under standard conditions [5% CO₂, 95% relative humidity and 37°C].

RPMI-1640 is a medium developed for the long-term culture of peripheral blood lymphocytes and is able to support the growth of a wide variety of cells in suspension as well as a number of cells grown as monolayers. RPMI 1640 medium contains sodium bicarbonate commonly used as a buffering component to guarantee the optimal pH range of 7.2-7.4. Cells in culture normally produce CO₂ that easily combines with water forming carbonic acid (H₂CO₃) which in turn rapidly dissociates to form hydrogen ions (H⁺) and bicarbonate (HCO₃⁻) leading to a decrease of medium pH and consequent inhibition of cell growth.

Phenol red is another component of RPMI 1640 medium; it is pH indicator able to provide gross information on cell metabolism: in acidic environment its colour turns from the medium purple to yellow. FBS is added to RPMI 1640 medium as a source of growth factors as well as L-Glutamine, an essential amino acid used for protein production, as an energy source, and in nucleic acid metabolism.

Culture medium	Components
RPMI 1640 Completed medium	Sodium bicarbonate Phenol red Non-essential amino acids L- Glutamine 2 mM FBS 15% (v/v) heat-inactivated Penicillin 100 U/mL Streptomycin 100 µg/mL

Table 1. Components contained in RPMI 1640 (Sigma Aldrich) medium

3.1.2. Mycoplasma detection method

To detect the presence of mycoplasmas in the cell cultures the q-RT-PCR method was used [see chapter 3.5.]. To perform the q-RT-PCR sequencing primers against *tuf* gene (which encodes peptide chain elongation factor Tu) were designed. These designed primers match *tuf* gene of 19 mycoplasmas on the public database (5'-TCCAGGWCAYGCTGACTA-3' as a forward primer and 5'-ATTTTWGGAACKCCWACTTG-3' as a reverse primer).

The samples were prepared as follows:

1. $2-3 \times 10^5$ cells were washed with phosphate buffer saline (PBS) 1 \times .

Reagent	Amount to add in 1L of distilled water	Final concentration
NaCl	8 g	137 mM
KCl	0.2 g	2.7 mM
Na ₂ HPO ₄	1.44 g	10 mM
KH ₂ PO ₄	0.24 g	1.8 mM

Table 2. Recipe for preparation 1 L PBS 1 \times

2. Cells were resuspended in 10 μ L RNase free water.
3. Samples were boiled at 95°C 15min.
4. The thermal cycle of q-RT-PCR was set as follow: 95°C for 10 min, required to activate DNA polymerase followed by 95°C for 30 sec (denaturation), 60°C for 15 sec (annealing), 72°C for 30 sec (extension). No more than 40 cycles of amplification were used.

Mix	Volume / μ L
MASTER MIX (10 \times buffer, MgCl ₂ 25mM, dNTPs mix, Taq Pol 5 U/ μ L, Syber Green)	12.5
5' primer 0.3 μ M	1.5
3' primer 0.3 μ M	1.5
dH ₂ O	Fill to 25
Template	1

Table 3. Quantitative and qualitative composition of mixture for q-RT-PCR

3.1.3. Cells Cryopreservation and Resuscitation

In order to prevent the risk of genetic and morphological changes, thus to reduce the risk of contamination and to slow down the aging process mammalian cell lines need to be cryopreserved.

This process was performed as follows:

1. Viable cells were counted, centrifuged at 800 rpm for 10 min and the supernatant was discarded
2. Cells were resuspended in the freezing medium (see Table 4) at an optimal concentration of $2-10 \times 10^6$ cells/mL and aliquoted in cryogenic vials
3. Each vial was placed in ice for 30 min in order to obtain a slowly freezing and maintain the cell membrane integrity. Finally vials were transferred into a -80°C freezer.

Component	%
FBS	90
DMSO	10

Table 4. Composition of cryopreservation medium

Cell lines were resuscitated by rapid thawing at 37°C and DMSO dilution with 10 mL of warmed RPMI 1640 complete medium. Thereafter cells were centrifuged at 800 rpm for 10 min, the supernatant was pour off and the pellet resuspended in fresh medium in a T25 cm^2 flask.

3.2. CELL VIABILITY ASSAY

Lymphoblasts were counted and split at a density of 500.000 cells/mL. To check the cell viability in presence and absence of DETA-NONOate at different concentrations we used the Trypan Blue (TB) solution method. TB is a cell impermeable molecule able to penetrate only into the cells with damaged membrane that become clearly recognisable at the optical microscope for their distinctive blue colour.

Approximately 20×10^3 cells were seeded in each well of a 96 multiwell plate (CELLSTAR[®]) at a final concentration of 2×10^5 cell/mL and treated with DETA-NONOate at concentrations ranging from 0.01 to 0.5 mM for 48 h. DETA-NONOate is a NO \cdot donor with 20 h of half-life at 37°C, therefore it was added again to the cells after 24 h of incubation. Afterwards, cells were collected and their viability was determined using TB. Each condition was performed in triplicate.

Protocol for counting cells with Hemocytometer (Fig. 13)

1. Cell sample was dilute 1:1 in a 0.4% TB solution (Sigma-Aldrich).
2. The glass cover slip was placed over the counting chambers.
3. 10 μ L of cell sample were pipetted into the hemocytometer.
4. The hemocytometer was placed under a microscope with typical magnification of 100 \times .
5. Focus onto the grid pattern and count the number of cells in the middle square of the two grids.
6. To calculate the total number of viable cells in the flask was calculated using the formula below:

$$\frac{\text{Total cells counted} \times \text{dilution factor (2)} \times 10.000 \text{ cells/mL}}{\text{Number of hemocytometer squares}}$$

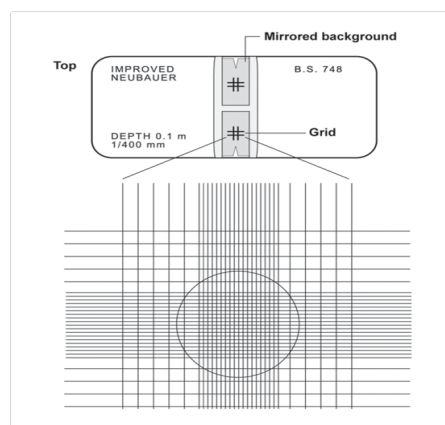

Figure 13. Hemocytometer (Neubauer chamber) [from lifetechnologies.com website]

3.3. PROTEIN CONTENT QUANTIFICATION

3.3.1. Bradford assay

The Bradford protein assay is a method commonly used to measure the concentration of total proteins in biological samples. The assay is based on the shift of absorbance from 465 nm (brown) to 595 nm (blue) that occurs when proteins bind to Coomassie Brilliant Blue G-250 dye under acid conditions [Bradford 1976]. This method measures the presence of basic (*e.g.* arginine; lysine) and aromatic (*e.g.* histidine) amino acid residues that are primarily involved in the protein-dye complex formation (Fig. 14.).

To perform the protein quantification assay the Bio-Rad Protein Assay Solution was used and the standard curve was built using 2mg/mL bovine serum albumin (BSA) as reference protein. Briefly, serial BSA protein dilutions were made (2; 4; 6; 8; 10µg/mL) in order to obtain a standard curve and 1µL of lysate was diluted in 200 µL of Bradford solution and brought up to 1mL using Milli-Q water. Sample and standards were incubated at room temperature (25 °C) for 5 min, transferred to disposable cuvette and the absorbance was read at 595 nm. The regression coefficient was calculated using the BSA standard curve.

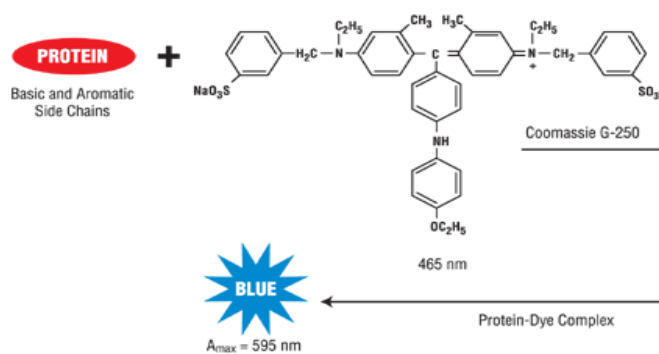

Figure 14. Forming of protein-Dye blue complex [from qcbio.com website]

3.3.2. Bicinchoninic Acid assay (BCA)

The BCA protein assay is a colorimetric technique commonly used to detect and quantify the total protein concentration. The assay relies on the principle that in an alkaline environment Cu^{2+} ions are reduced to Cu^+ by proteins. The bicinchoninic acid is a specific reagent for Cu^+ ions forming with them a purple-blue complex whose colour is proportional to the total protein present in the sample (Fig. 15) [Walker J. M. 2002]. For the assay the BCA Kit (Sigma Aldrich) was used and the standard curve was built using a series of BSA protein dilutions. Briefly, an aliquot of 2 μL of sample and standard were diluted in 1 mL of BCA working reagent obtained mixing 50 parts of solution A with 1 part of solution B. Both samples and standards were incubated at 37°C for 30 min and the absorbance was measured at 562 nm using a Jasco V-650 spectrophotometer. Using the BSA standard curve (Fig. 16) protein concentration of the samples was calculated.

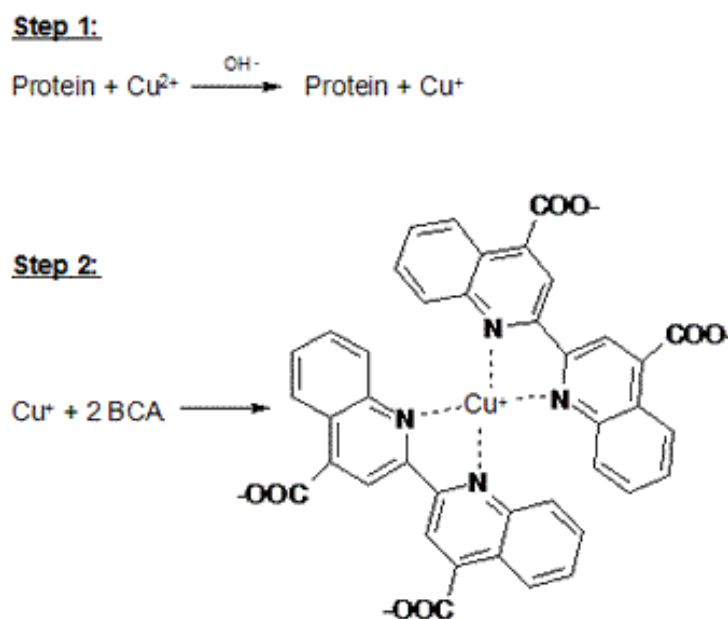

Figure 15. Reduction of Cu^{2+} and reaction with BCA forming purple-blue complex [from nfsc4500101groupa.weebly.com website]

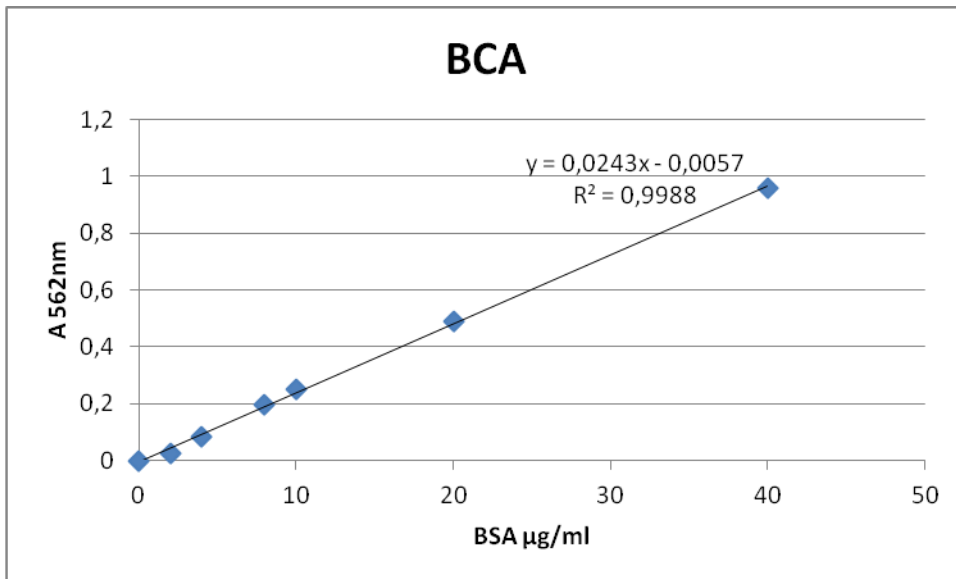

Figure 16. Standard curve for BCA assay obtained using a Jasco V-650 spectrophotometer

3.4. QUANTITATIVE REAL TIME POLYMERASE CHAIN REACTION

The q-RT-PCR is a common method used to produce in few hours millions of copies of specific DNA sections and obtaining enough DNA required for further analysis. The method is so-called because the amplification of DNA with a PCR is monitored in real time (q-RT-PCR cyclers constantly scan q-RT-PCR plates). In contrast to the conventional PCR the q-RT-PCR is a quantitative method that enables to determine the exact concentration (relative or absolute) of the amplified DNA in the sample. Apart from DNA, also RNA can be used as a template. In this latter case the RNA needs to be purified and reverse transcribed into DNA (also termed complementary DNA or cDNA) before being amplified with q-RT-PCR.

The main steps followed were:

1. Sample preparation
2. Retrotranscription
3. q-RT-PCR

1. Sample preparation

RNA purification

RNA purification is the first and crucial step of q-RT-PCR and it has to be performed accurately in order to exclude all those factors that could negatively influence the quality of the analysis. Degradation of the RNA is a critical issue during sample preparation as well as the possible presence of organic solvents, (commonly used during the RNA extraction process) DNA and proteins.

RNA purification from cultured cell lines is consisted of several steps (Fig. 17) that were performed using the NucleoSpin® RNA Buffer Set (Macherey-Nagel).

NucleoSpin® RNA Buffer Set procedure

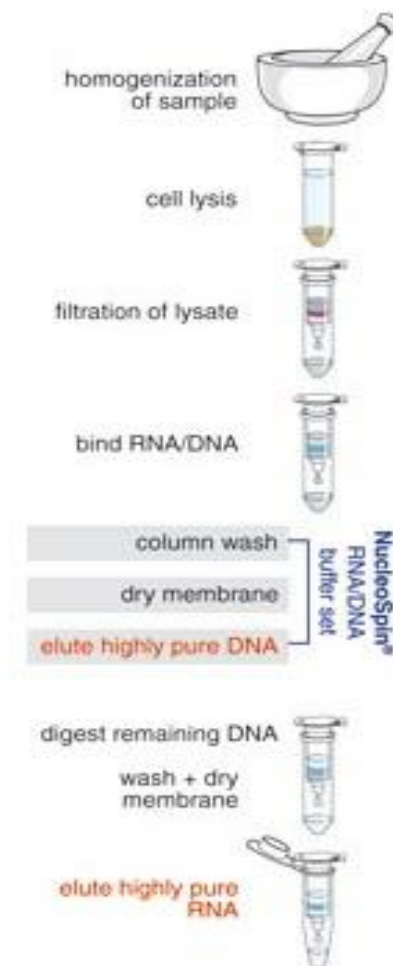

Figure 17. RNA purification steps [from bioke.com website]

RNA quality control

To assess the RNA concentration and assure the sample purity two analyses were performed: spectrophotometer measurement and gel electrophoresis. The absorbance ratio measured at 260 nm and 280 nm provides information about RNA and DNA purity. In the presence of “pure” RNA this ratio should be 1.9-2.1. All proteins display absorption at 280 nm, so that if protein contamination is present in the sample a decrease of the ratio is expected. On the contrary when phenol and/or urea are present an absorbance at 230 nm or 270 nm is observed with consequent increase of the ratio. To measure small volumes of the sample, Eppendorf BioSpectrometer® was used (Fig. 18).



Figure 18. Eppendorf BioSpectrometer® [from labwrench.com website]

Gel electrophoresis is a very useful method to determine RNA degradation and it relies on principle that when the two ribosomal RNA (rRNA) bands are detected without smearing the RNA sample is considered intact. The two sharp bands seen on the gel correspond to 28S and 18S rRNAs, at a ratio of 2:1.

2. Retro transcription

Once the mRNA is isolated and purified it is necessary to transcribe it into the complementary DNA (Fig. 19) that is used as a template for the gene amplification.

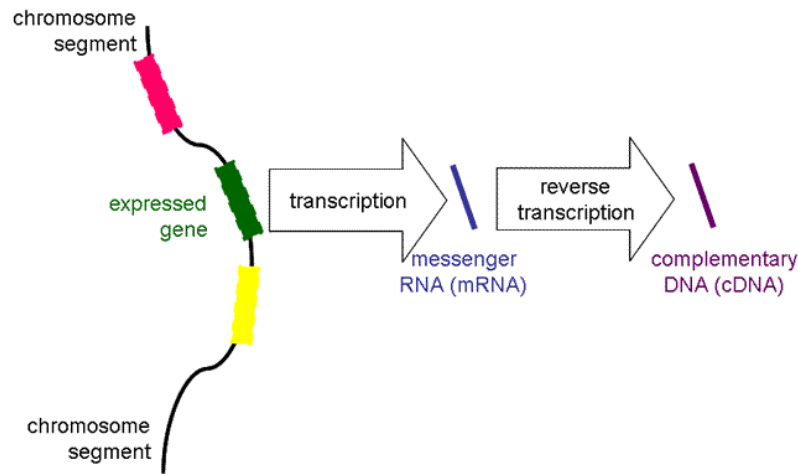

Figure 19. Transcription and retrotranscription of expressed gene [from saylor.org website]

3. q-RT-PCR

The amount of specific DNA section is detected using the fluorescence Syber Green dye that fluoresces when it is bound to the double stranded PCR products. The method is based on the natural process of DNA replication (Fig. 20). Briefly, the reaction occurs when a cDNA sample, DNA polymerase, nucleotides (dNTPs), primers (Forward and Reverse) and other reagents (PCR Buffer and MgCl₂) are added in a PCR sample tube.

Primers are short pieces of DNA made in laboratory and custom built according to the specific needs. In a PCR experiment, two primers are designed so to match the DNA segment that needs to be amplified (Table 5). Through complementary base pairing, one primer attaches to the top strand at one end of your segment of interest, and the other primer attaches to the bottom strand at the other end. In most cases, two primers (usually 20 nucleotides long) are able to target just one place in the entire genome.

Gene	Primers
β-actin reverse	5' AGGATGGCAAGGGACTTCCTG 3'
β-actin forward	5' AATGTGGCCGAGGACTTTGAT 3'
iNOS reverse	5' CAGCAGCCGTTCCCTCCTC 3'
iNOS forward	5' CCGAGTCAGAGTCACCATCC 3'
eNOS reverse	5' GCTCATTCTCCAGGTGCTTCAT 3'
eNOS forward	5' GCCGTGCTGCACAGTTACC 3'

Table 5. Nucleic base sequences of reverse and forward primers

DNA polymerase commonly used is derived from a strain of bacteria called *Thermus aquaticus* that live in the hot springs and can survive near boiling temperatures able therefore, to be active at 72°C.

In parallel with the analysis of the samples, negative and positive controls were also loaded. No template control (NTC) was used as a negative control in order to check a possible external contamination or primer dimer formation that could increase the fluorescence signal. Positive control was analysed in order to check the activity and specificity of the primers.

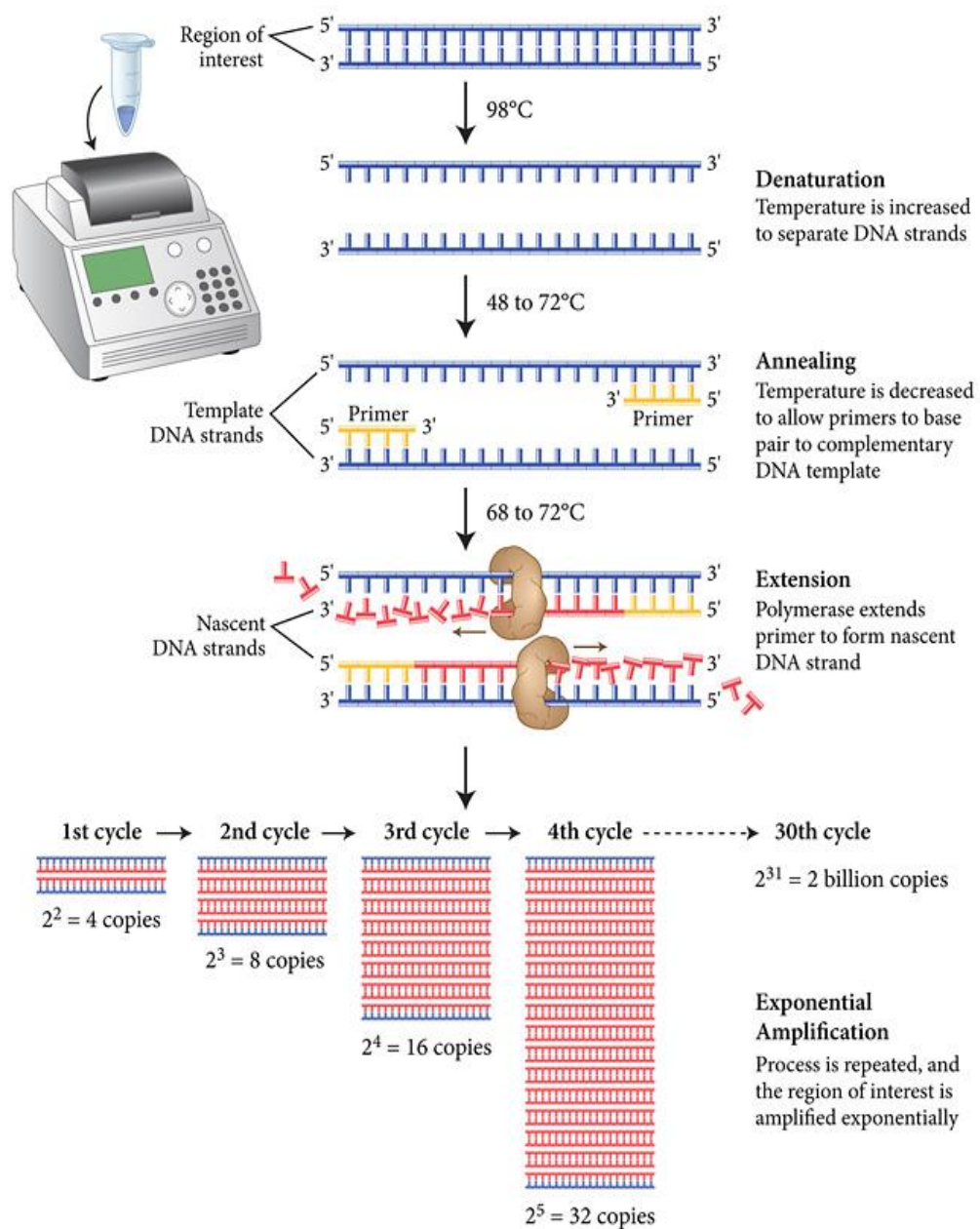

Figure 20. Quantitative real time polymerase chain reaction [from neb.com website]

At the end of each cycle (run) the melting curve was performed to ensure a single amplified product for each reaction. During the melting curve analysis, all products generated in the PCR amplification reaction were melted at 95°C, annealed at 55°C and subjected to a gradual increase in temperature. The result is a plot of raw fluorescence data units versus temperature and each peak in the curve indicates a specific melting product. Ideally, a single peak is observed and the melting temperature is the same in all reactions where the same sample is amplified. If secondary peaks are seen it means that the required product is not the only one that is amplified. As an internal control gene encoding for β -actin has been used because it is expressed constantly and at the high levels in almost every cell lines and they were used to normalize changes in specific gene expressions.

4. RESULTS AND DISCUSSION

4.1. MYCOPLASMA CONTAMINATION TEST

Mycoplasma is the most common contaminant of cell cultures with an average infection rate of 25% of the worldwide cell cultures [Uphoff et al 2001] and is considered a major problem in biological studies. This type of contamination is of particular importance since, contrary to bacterial infection, it can be detected only through special assays. Moreover mycoplasma strains are usually resistant to many of the commonly used antibiotics challenging the eradication. Manifestations of mycoplasma contamination are variable even though the most common remarkable effect is an irreversible deterioration and loss of cell cultures. One of the most common and reliable method to detect mycoplasma contaminants is the q-RT-PCR technique. Recently, a number of q-RT-PCR assays have been described for a variety of mycoplasmas

To assess the absence or presence of mycoplasma contaminations in our cell cultures, we performed a q-RT-PCR. We selected a couple of primers and run a q-RT-PCR on both controls and LHON lymphoblasts cell lines at the beginning and at the end of this thesis project. In order to check the specificity of our primers we also loaded a positive mycoplasma control. In all the q-RT-PCR we performed we did not detect any presence of mycoplasma contamination.

4.2. CELL VIABILITY ASSAY

In order to assess the control and LHON cell lines viability in presence of NO \cdot we performed a viability assay on cells incubated with different concentration of the NO \cdot releaser DETA-NONOate. Lymphoblast cells, obtained from the LHON patient and healthy controls (CT1 and CT2), were seeded in plates and treated with four different concentrations of DETA-NONOate (0.01; 0.05; 0.1; 0.5 mM) for 48 hours. DETA-NONOate is one of the most commonly used NO \cdot donors and it is suitable for long term incubation since it has a half-life of 20 h at 37°C allowing to maintain stable NO \cdot levels for a prolonged period of time. Moreover the DETA-NONOate spontaneous decomposition is not affected by the presence of light, metals, thiols or cells and produces only NO \cdot and non-toxic diethylenetriamine (DETA).

Since DETA-NONOate dissociation is strictly pH dependent being almost instantaneous at pH 5, in order to prevent accidentally NO \cdot releasing, the DETA-NONOate stock solution was prepared in 0.01 NaOH and stored at -20 °C. The DETA-NONOate stock was thereafter diluted in RPMI-1640 immediately before addition to the cells. In order to guarantee a 48 h incubation the compound was added again after 24 h. At the end of the overall incubation time cells were collected and their viability was determined by the Trypan blue exclusion method; data were estimated from three independent experiments performed in triplicate and statistically analyzed. The results indicate that, compared to healthy controls, LHON patient cells are more susceptible to NO \cdot toxicity. Particularly, LHON cells show a greater percentage of mortality when exposed to the higher concentrations of DETA-NONOate (0.05, 0.1 and 0.5 μ g/mL) compared to controls ones.

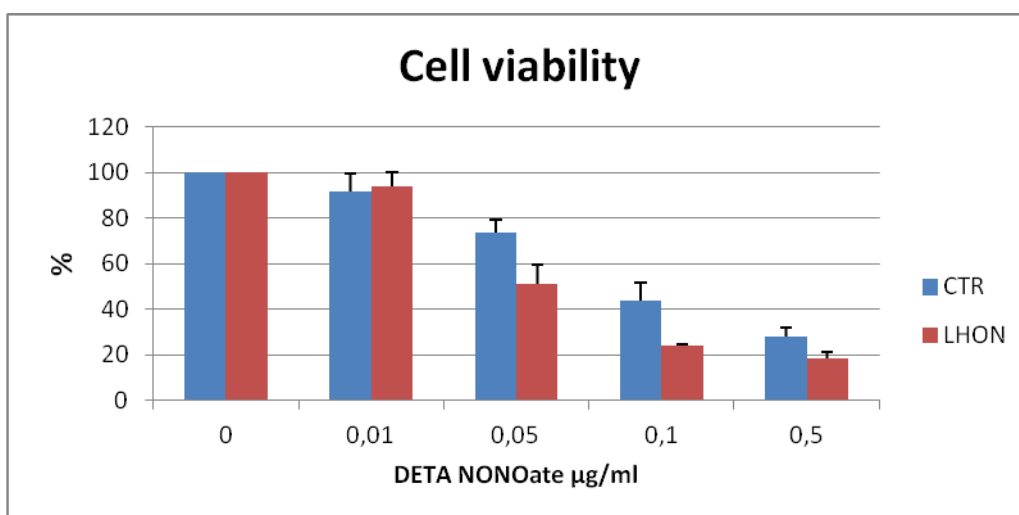

Figure 21. Cell viability of DETA-NONOate treated cells reported as percentage in the absence of the NO \cdot releaser Controls (CTR) viability is expressed as the average of CT1 and CT2 measurements.

4.3. EXPRESSION OF NOSs mRNA LEVELS

To determinate whether NOSs mRNA levels differed between controls and LHON cells, we performed a q-RT-PCR analysis for the eNOS and iNOS expression genes. To perform this measurement, the total RNA was first extracted from the cells and its quality thereafter tested the quality of RNA.

The absorption of the isolated RNAs derived both from controls (CT1 and CT2) and the LHON patient has been evaluated spectroscopically at 260 nm and 280 nm and the 260/280 nm ratio, indicative of RNA purity, calculated. The results reported in Table 6 show that the RNA extraction was successfully performed. The values of the 260/280 nm ratio were in between 1.9 and 2.1 indicating that as purified the RNA was free from contaminations by organic chemicals and proteins (see chapter 3.4., Methods and Materials). Moreover, using the Lambert-Beer law we were able to calculate the RNA concentration of samples.

Sample	A_{260nm}/A_{280nm}
CT1	2.1
CT2	2.1
LHON	2.0

Table 6. Typical A_{260nm}/A_{280nm} values obtained with Eppendorf BioSpectrometer®

Once checked the purity of the RNA samples we further proceeded with quality controls: the gel electrophoresis, a method commonly used to detect the presence of denatured RNA. High quality and non-degraded RNA is fundamental for a good cDNA synthesis and down streaming q-RT-PCR steps. One of the major concerns of RNA extraction is the presence of ribonucleases (RNAses). These are ubiquitous enzymes present within the cells and tissues able to rapidly degrade the total RNA. Additionally, RNAses are present in various biological fluids (*e.g.* tears, saliva) and are particularly resistant to several chemical agents. For these reasons samples were prepared in the presence of RNAses inhibitors.

A picture of a typical electrophoresis gel is shown in Fig. 22. The control samples were overloaded so the first two bands are lighter but no smearing was present and two sharp bands, corresponding to 28S and 18S RNA, can be detected as expected for intact RNA samples.

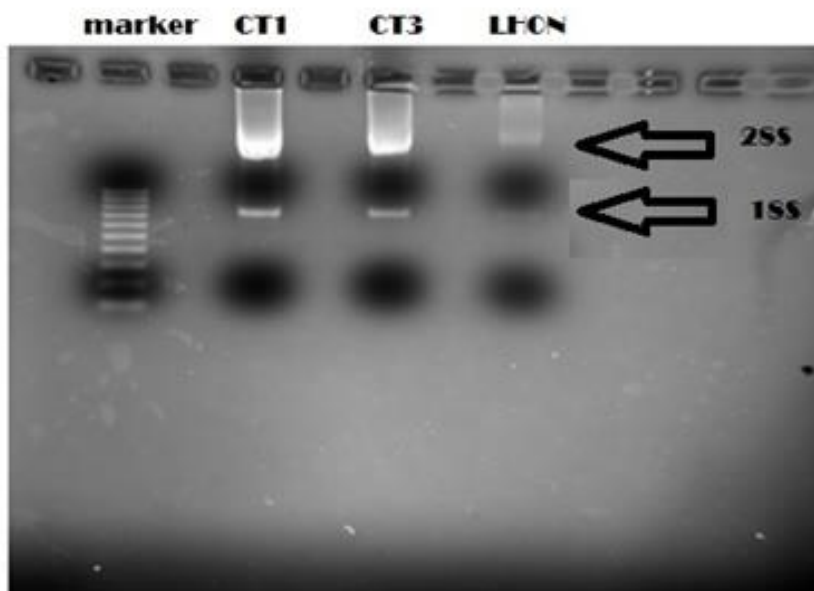

Figure 22. Picture of electrophoresis gel taken with ChemiDoc MP System (BioRad)

After having assessed the good quality of the RNA samples, the q-RT-PCR analysis was performed. The amount of amplified DNA coding either for iNOS or for eNOS was detected using the fluorescence Syber Green dye that fluoresces when it is bound to the double stranded PCR products. The results were analysed using ddCt method, which comprises the $2^{-\Delta\Delta CT}$. This is a convenient method for acquiring relative expression of the target gene in different samples. It requires the assignment of one or more housekeeping genes, which are assumed to be uniformly and constantly expressed in all samples. The analysis shown in Fig. 23 and Fig. 24, although apparently suggestive of different expression of the iNOS and eNOS mRNA in LHON and control cells was not statistically different. At this stage the conclusion can only be that more experiments are necessary to assess possible differences between LHON and control cells in the expression and activity of these enzymes.

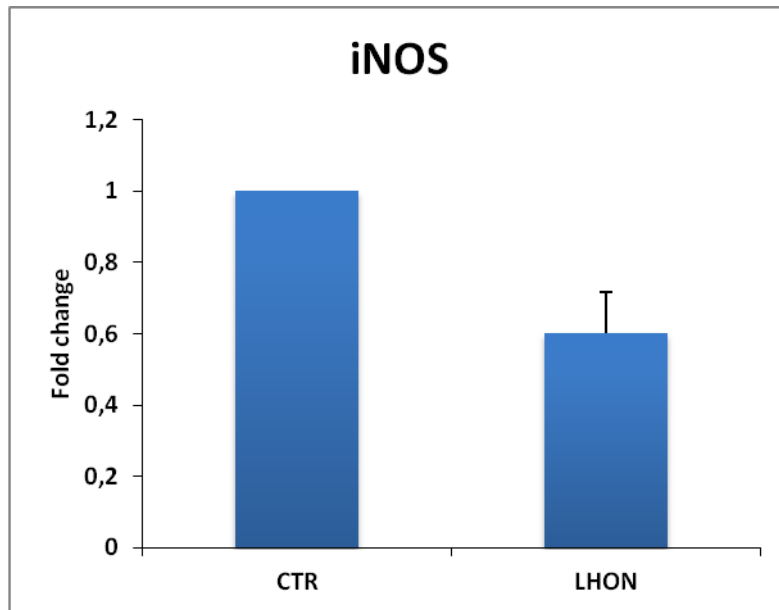

Figure 23. Relative expression of amplified DNA coding for iNOS in controls and LHON cells

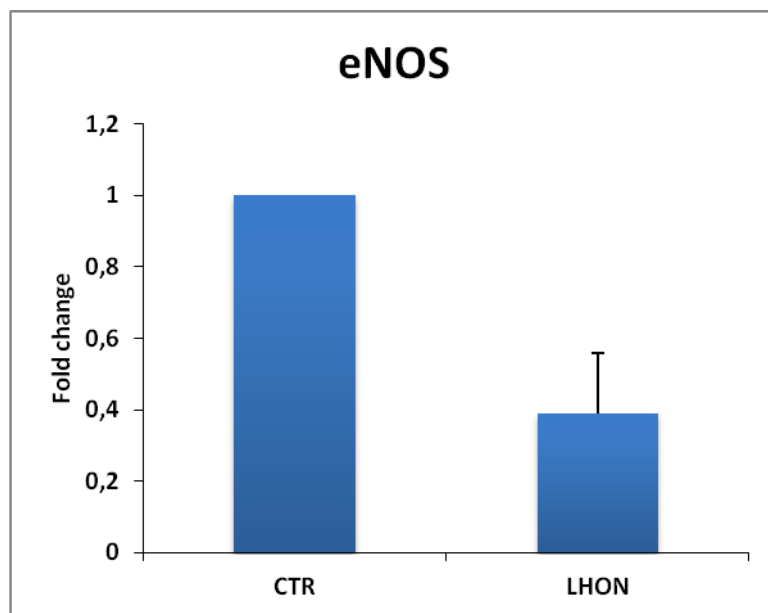

Figure 24. Relative expression of amplified DNA coding for eNOS in controls and LHON cells

5. CONCLUSION

In this thesis work, we investigated the potential role of NO \cdot in the LHON development and progression. The alteration of mitochondrial respiratory chain function with consequent deficit in ATP levels and increased ROS production are two of the main biochemical features of the LHON pathology leading to the preferential loss of RGCs and subsequent optic nerve degeneration. Although several studies carried on cell and animal models unravelled some of the molecular and biochemical bases underlying the LHON pathology, many open questions still persist making difficult to provide an efficient therapy able to prevent and reverse the LHON symptoms.

NO \cdot is an established modulator of mitochondrial function, we have therefore addressed the question whether changes in the NO \cdot metabolism could have a role in the LHON pathophysiology. With this aim in mind, we analysed the viability of LHON cells cultured in the presence of the NO \cdot releaser DETA-NONOate, mimicking a chronic increase of NO \cdot bioavailability, as it might occur in vivo particularly due to iNOS activation. The assay revealed that NO \cdot has a greater impact on LHON cell viability whereas control lymphoblasts were able to cope much better with nitrosative stress.

These data suggest that in LHON cells the exposure to high NO \cdot levels leading to overproduction of reactive oxygen and nitrogen species (RONS), impairs the redox homeostasis, exacerbates mitochondrial dysfunction, thereby leading to cell death.

Finally, we checked the mRNA NOSs level to verify whether in the absence of exogenous NO \cdot , LHON cells undergo nitrosative stress as a consequence of an increased nitric oxide synthases expression (and activity). At this stage, our data show similar eNOS and iNOS mRNA expression in LHON and control cells. As already mentioned, more experiments are necessary, even though we cannot exclude that the intrinsic enzymatic activity could be different in controls and LHON patients.

The future perspective will be to investigate more deeply the role of nitric oxide in the LHON pathophysiology, in order to assess if this small gas molecule could affect the OXPHOS ATP production and cell bioenergetics. If the ongoing experiments will confirm the preliminary observations, then it is tempting to speculate that the lower levels of NOSs found in LHON patients may represent a cell attempt to inhibit NO synthesis, thus lowering peroxynitrite. Indeed, a better knowledge of the molecular mechanisms of LHON disorder would lead to the development of efficient therapies.

6. LITERATURE

1. Alberts B, Johnson A, Lewis J, Raff M, Roberts K, Walter P. Molecular biology of the cell. New York, Garland Science, 2002, 15, 795.
2. Alderton WK, Cooper CE, Knowles RG. Nitric oxide synthases: structure, function and inhibition. *Biochem J*, 2001, 357, 593-615.
3. Anderson S, Bankier AT, Borel V, Bruchmann M, Coulson AR, Drouin J, Eperon IC, Nierlich DP, Roe BA, Sanger F, Schreier R, Smith AJH, Staden R, Young IG. Sequence and organization of the human mitochondrial genome. *Nature*, 1981, 290, 457-465.
4. Archer S. Measurement of nitric oxide in biological models. *FASEB J*, 1993, 7, 349-60.
5. Arpa J, Cruz-Martinez A, Campos Y, Gutierrez-Molina M, Garcia-Rio F, Perez-Conde C, Martin MA, Rubio JC, Del Hoyo P, Arpa-Fernandez A, Arenas J. Prevalence and progression of mitochondrial disease: a study of 50 patients. *Muscle Nerve*, 2003, 28, 690-695.
6. Battisti C, Formichi P, Cardaioli E, Bianchi S, Mangiavacchi P, tripod SA, Tosi P, Federico A. Cell response to oxidative stress induced apoptosis in patients with Leber's hereditary optic neuropathy. *J Neurol Neurosurg Ps*, 2004, 75, 1731-1736.
7. Berg JM, Tymoczko JL, Stryer L. Biochemistry. New York, W H Freeman, 2000, 339-340; 477-480.
8. Bradford MM. A rapid and sensitive method for the quantitation of microgram quantities of protein utilizing the principle of protein-dye binding. *Anal Biochem*, 1976, 72, 248-254.
9. Carelli V, Rugolo M, Sgarbi G, Ghelli A, Zanna C, Baracca A, Lenaz G, Napoli E, Martinuzzi A, Solaini G. Bioenergetics shake cellular death pathways in Leber's hereditary optic neuropathy: a model of mitochondrial neurodegradation. *Biochim Biophys Acta*, 2004, 1658, 172-179.
10. DiMauro S, Bonilla E. Mitochondrial encephalomyopathies. New York, McGraw-Hill, 2004, 1623-1662.
11. DiMauro S, Davidzon G. Mitochondrial DNA and disease. *Ann Med*, 2005, 37, 222-232.

12. Doudican NA, Song B, Shadel GS, Doetsch PW. Oxidative DNA damage causes mitochondrial genomic instability in *Saccharomyces cerevisiae*. *Mol Cell Biol*, 2005, 25, 5196-5204.
13. Frey TG, Mannella CA. The internal structure of mitochondria. *Trends Biochem Sci*, 2001, 25, 319-324.
14. Gilbert H. Basic concepts in biochemistry. McGraw-Hill Medical, 2000, 175-176.
15. Goto Y, Nonaka I, Horai S. A mutation in the tRNA^{Leu(UUR)} gene associated with the MELAS subgroup of mitochondrial encephalomyopathies. *Nature*, 1990, 348, 651-653.
16. Ignarro LJ, Napoli C, Loscalzo J. Nitric oxide donors and cardiovascular agents modulating the bioactivity of nitric oxide. *Circ Res*, 2002, 90, 21-28.
17. Karp G. Cell and molecular biology; Concepts and experiments. John Wiley & Sons, Inc., 2010, 182-190.
18. Kovács G, Höftberger R, Majtényi R, Horváth R, Barsi P, Komoly S, Lassmann H, Budka H, Gábor J. Neuropathology of white matter disease in Leber's hereditary optic neuropathy. *Brain*, 2004, 128, 35-41.
19. Krauss G. Biochemistry of signal transduction and regulation. Weinheim, Wiley-VCH Verlag GmbH & Co. KGaA, 2003, 264-265.
20. Kurland CG, Andersson SGE. Origin and evolution of the mitochondrial proteome. *Microbiol Mol Biol R*, 2000, 64, 786-820.
21. Liew FY, Cox FEG. Nonspecific defence mechanism: the role of nitric oxide. *Immunol Today*, 1991, 12, A17-A24.
22. Lin CS, Sharpley MS, Fan W, Waymire KG, Sadun AA, Carelli V, Ross-Cisneros FN, Baciú P, Sung E, McManus MJ, Pan BX, Gil DW, MacGregor GR, Wallace DC. Mouse mtDNA mutant model of Leber hereditary optic neuropathy. *Proceeding of National Academy of Sciences*, 2012, 109, 20065-20070.
23. Mann VM, Cooper JM, Krige D, Daniel SE, Schapira AH, Marsden CD. Brain, skeletal muscle and platelet homogenate mitochondrial function in Parkinson's disease. *Brain*, 1992, 115, 333-342.
24. Martin W, Muller M. The hydrogen hypothesis for the first eukaryote. *Nature*, 1998, 392, 37.
25. Mathews CK, Van Holde KE, Ahern KG. Biochemistry. Benjamin Cummings, 2000, 159-166.
26. McFarland R, Tayloe RW, Turnbull DM. A neurological perspective on mitochondrial disease. *Lancet Neurol*, 2010, 9, 829-840.

27. Mehrabian Z, Liu L, Fiskum G, Rapoport SI, Chandrasekaran K. Regulation of mitochondrial gene expression by energy demand in neural cells. *J Neurochem*, 2005, 93, 850-860.
28. Messmer UK, Ankarcrona M, Nicotera P, Brune B. p53 expression in nitric oxide-induced apoptosis. *FEBS Lett*, 1994, 355, 23-26.
29. Michell BJ, Chen Z, Tiganis T, Stapelton D, Katsis F, Power DA, Sim AT, Kemp BE. Coordinated control of endothelial NO synthase phosphorylation by protein kinase C and the cAMP-dependent protein kinase. *J Biol Chem*, 2001, 276, 17625-17628.
30. Murray RK, Granner DK, Mayes PA, Rodwell VW. Harper's Illustrated Biochemistry. McGraw-Hill Companies, Inc., 2003, 92-102; 462-463; 572-573.
31. Naseem KM. The role of nitric oxide in cardiovascular diseases. *Mol Aspects Med*, 2005, 26, 33-65.
32. Nickel A, Kohlhaas M, Maack C. Mitochondrial reactive oxygen species production and elimination. *J Mol Cell Cardiol*, 2014, 73, 26-33.
33. Perkins G, Renken C, Martone ME, Young SJ, Ellisman M, Frey T. Electron tomography of neuronal mitochondria: three-dimensional structure and organization of cristae and membrane contacts. *J Struct Biol*, 1997, 119, 260-272.
34. Poole RK. NO and nitrosative stress tolerance in bacteria. *Biochem Soc T*, 2005, 33, 176-180.
35. Sarti P, Arese M, Forte E, Giuffrè A, Mastronicola D. Mitochondria and nitric oxide: chemistry and pathophysiology. *Adv Exp Med Biol*, 2012, 942, 75-92.
36. Sarti P, Forte E, Giuffrè A, Mastronicola D, Magnifico MC, Arese M. The chemical interplay between nitric oxide and mitochondrial cytochrome c oxidase: reactions, effectors and pathophysiology. *J Cell Biol*, 2012, 2012, 571057.
37. Sarti P, Giuffrè A, Forte E, Mastronicola D, Barone MC, Brunori M. Nitric oxide and cytochrome c oxidase: Mechanisms of inhibition and NO degradation. *Biochem Bioph Res Co*, 2000, 274, 183-187.
38. Shoffner JM, Lott MT, Lezza AM, Seibel P, Ballinger SW, Wallace DC. Myoclonic epilepsy and ragged-red fiber disease (MERRF) is associated with a mitochondrial DNA tRNA(Lys) mutation. *Cell*, 1990, 61, 931-937.
39. Stroes E, Hijmering M, Van Zandvoort M, Wever R, Rabelink TJ, Van Faassen EE. Origin of superoxide production by endothelial nitric oxide synthase. *FEBS Lett*, 1998, 438, 161-164.

40. Szabo C, Ohshima H. DNA damage induced by peroxynitrite: subsequent biological effects. *Nato Sci S A Lif Sci*, 1997, 1, 373-385.
41. Taylor RW, Turnbull DM. Mitochondrial DNA mutations in human disease. *Nat Rev Genet*, 2005, 6, 389-402.
42. Vicente JB, Colaço HG, Mendes MIS, Sarti P, Leandro P, Giuffrè A. NO binds human cystathionine β -synthase quickly and tightly. *J Biol Chem*, 2014, 289, 8579-8587.
43. Walker JM. The bicinchoninic acid (BCA) assay for protein quantitation. *The Protein Protocols Handbook*, Human Press, 2002, 11-14.
44. Wallace DC, Chalkia D. Mitochondrial DNA genetics and the heteroplasmy conundrum in evolution and disease. *Perspect Biol Med*, 2013, 5, 021220.
45. Wallace DC. Mitochondrial genes and disease. *Hosp Pract*, 1986, 21, 77.
46. Wei YH. Oxidative stress and mitochondrial DNA mutations in human aging. *J Mol Cell Cardiol*, 2014, 73, 26-33.
47. Wink DA, Mitchell JB. Chemical biology of nitric oxide: insights into regulatory, cytotoxic and cytoprotective mechanisms of nitric oxide. *Free Radical Bio Med*, 1998, 25, 434-456.

7. SUMMARY

Due to complex interactions of mitochondrial and nuclear DNA, the real cause of inherited mitochondrial diseases is still unclear and patients currently lack effective treatments. Leber's hereditary optic neuropathy, one of the most common inherited optic neuropathies, is caused by point mutations in mtDNA that result in a defect of respiratory chain complex I activity.

From the biochemical point of view the bioenergetic failure and the enhanced reactive oxygen species (ROS) production are typical hallmarks of LHON disease, but still they do not explain the late onset and the incomplete penetrance. Moreover it is still unknown why, although the mutation is present overall the body only the RGCs are affected. Since LHON is characterized by a deficit in the oxidative phosphorylation chain and $\text{NO}\cdot$ is an established mitochondrial respiratory chain negative modulator, we checked if it might have a role in the LHON development and progression.

The results presented in this thesis prove that long-term exposure to $\text{NO}\cdot$ has a larger impact on LHON cells viability compared to controls and suggest that higher levels of reactive oxygen and nitrogen species (ONOO^-) are produced in this pathological state, leading to cell death. In addition, careful though still statistically insufficient evaluations of the levels of iNOS and eNOS mRNA expression seems to suggest that there might be a difference in the expression of one or more NOSs in LHON patients: this question however remains open. Future perspectives are, indeed, to provide a complete picture about involvement of NO in this specific mitochondrial disease and to solve the conundrum of the NOSs expression and activity. . The feeling is that the $\text{NO}\cdot$ metabolism can be relevant to LHON pathophysiology, its comprehension opening to the development of more efficient therapeutic and preventive interventions.

PROŠIRENI SAŽETAK

UVOD

Dušikov oksid ($\text{NO}\cdot$) jednostavan je plin koji u animalnoj fiziologiji ima važnu ulogu kao signalna molekula u procesima koji reguliraju cirkulaciju krvi, aktivaciju imunskog sustava, prijenos živčanih signala kao i u procesima koji moduliraju mitohondrijsku respiraciju. $\text{NO}\cdot$ također ima ulogu u razvoju nekih bolesti no točni mehanizmi još uvijek nisu poznati. U eukariotskim stanicama sinteza $\text{NO}\cdot$ katalizirana je članovima porodice enzima koja je nazvana sintaze dušikovog oksida (NOSs).

Mitohondrij je stanični organel koji sadrži vlastitu kužnu DNA i odgovoran je za produkciju najveće količine energije u stanici u procesu oksidativne fosforilacije. Mitohondrijski genom se nalazi u neposrednoj blizini sustava oksidativne fosforilacije koji je veliki izvor reaktivnih oksidativnih spojeva pa je, prema tome, izloženiji mutacijskim promjenama od nuklearnog genoma što može dovesti do razvoja bolesti. Složene interakcije mitohondrijske i nuklearne DNA onemogućuju otkrivanje pravog uzroka nasljednih mitohondrijskih bolesti kao i pružanje učinkovite terapije.

Leberova nasljedna optička neuropatija (LHON), jedna od najučestalijih nasljednih optičkih neuropatija, posljedica je točkastih mutacija mitohondrijske DNA koje dovode do smanjenja aktivnosti kompleksa I u respiratornom lancu. Tipična su obilježja LHON-a, sa biokemijskog stajališta, smanjenje proizvodnje energije na staničnoj razini i povećana proizvodnja reaktivnih kisikovih (ROS) i dušikovih (RONS) spojeva no to ne objašnjava odgođenu pojavu simptoma bolesti i učinak samo na određene stanice. Naime, premda je mutacija prisutna u cijelom tijelu, štetan se učinak očituje samo na ganglijskim stanicama mrežnice. Obzirom da je LHON karakteriziran deficitom oksidativne fosforilacije, a $\text{NO}\cdot$ je poznati negativni modulator mitohondrijskog respiratornog lanca istražili smo njegovu ulogu u razvoju LHON-a.

MATERIJALI I METODE

Nakon uzgoja staničnih kultura ljudskih limfoblasta, uzetih od pacijenta nositelja mutacije odgovorne za nastanak LHONA i zdravih kontrolnih stanica, mogli smo proučavati utjecaj $\text{NO}\cdot$ na smrtnost stanica. Stanične kulture su uzgajane u propisanom mediju (RPMI 1640) pod standardnim uvjetima. Imajući na umu opasnost od zaraze staničnih kultura mikoplazmama, provjerili smo njihovu prisutnost pomoću q-RT-PCR koristeći 5'-TCCAGGWCAYGCTGACTA-3' i 5'-ATTTTWGGAACKCCWACTTG-3' kao početnice. Analizu smo proveli na početku i na kraju istraživanja za ovaj rad te smo ustvrdili da kulture stanica nisu zaražene sa mikoplazmama.

U svrhu proučavanja utjecaja $\text{NO}\cdot$ na smrtnost stanica poslužili smo se s DETA NONOate kao stalnim donatorom $\text{NO}\cdot$. Stanice limfoblasta uzete od pacijenta nositelja mutacije A11778G koji boluje od Leberove nasljedne optičke neuropatije i od zdravih pojedinaca istog spola raspodijeljene su na ploči sa 96 jažica. 20×10^3 stanica je stavljeno u pojedinu jažicu i to tako da konačna koncentracija bude 2×10^5 stanica/mL. Tretirane su sa DETA-NONOate u rangu koncentracija od 0,01 do 0,5 mM u periodu od 48 sati. Nakon završenog perioda, žive stanice su brojane uz pomoć hemocitometra dodatkom Trypan Blue otopine.

Količina iNOS-a i eNOS-a na razini mRNA provjerena je metodom kvantitativne polimerazne lančane reakcije u stvarnom vremenu. Pročišćavanje RNA provedeno je uz pomoć NucleoSpin[®] RNA Buffer Set (Macherey-Nagel) prema standardnom postupku a kvaliteta je provjerena spektrofotometrijski pomoću Eppendorf BioSpectrometer[®] i provođenjem gel elektroforeze. Nakon retrotranskripcije mRNA u cDNA izveli smo q-RT-PCR koristeći početnice za β -aktin, iNOS I eNOS. β -aktin služi za normalizaciju rezultata koja je potrebna pri korištenju ddCt metode kojom smo analizirali podatke.

REZULTATI I RASPRAVA

Rezultati su pokazali da dugotrajna izloženost dušikovom oksidu ima veći utjecaj na smrtnost stanica LHON-a uspoređujući je sa smrtnosti kontrolnih stanica i pretpostavljaju da se ROS i RONS stvaraju u većim količinama u ovom patološkom stanju i vode ka staničnoj smrti.

U pripremi q-RT-PCR, pročišćena mRNA je bila prikladna za analizu jer je spektrofotometrijski određen omjer vrijednosti izmjeren na 260 nm i 280 nm u svim slučajevima bio između 1,9 i 2,1. Nadalje, gel elektroforezom smo jasno vidjeli 2 oštre linije koje ukazuju na konzistentnost pročišćene mRNA. Provedenom q-RT-PCR analizom dobili smo rezultate koji, iako nisu statistički značajni, pretpostavljaju da postoji razlika u ekspresiji jednog ili više NOS enzima kod pacijenata oboljelih od LHON-a, ali ovo pitanje ostaje otvoreno za daljnja istraživanja.

Buduća je perspektiva potpuno objašnjenje uloge $\text{NO}\cdot$ u specifičnim mitohondrijskim bolestima i rješavanje zagonetne ekspresije i aktivnosti samog NOS-a. Možda upravo metabolizam $\text{NO}\cdot$ može biti važan u patofiziologiji LHON-a te njegovo razumijevanje može pridonijeti razvoju efikasnijih terapija i preventivnih mjera.

Temeljna dokumentacijska kartica

Sveučilište u Zagrebu
Farmaceutsko-biokemijski fakultet
Zavod za Biokemiju i Molekularnu Biologiju
A. Kovačića 1, 10000 Zagreb, Hrvatska

Diplomski rad

Ekspresija i aktivnost sintaze dušikovog oksida u staničnim modelima relevantnim za ljudsku patofiziologiju

Kristina Radić

SAŽETAK

Složene interakcije mitohondrijske i nuklearne DNA onemogućuju otkrivanje pravog uzroka nasljednih mitohondrijskih bolesti kao i pružanje učinkovite terapije. Leberova nasljedna optička neuropatija (LHON), jedna od najučestalijih nasljednih optičkih neuropatija, je posljedica točkastih mutacija mitohondrijske DNA koje dovode do smanjenja aktivnosti kompleksa I u respiratornom lancu. Tipična obilježja LHON-a, sa biokemijskog stajališta, su smanjenje proizvodnje energije na staničnoj razini i povećana proizvodnja reaktivnih kisikovih (ROS) i dušikovih (RONS) spojeva no, to ne objašnjava odgođenu pojavu simptoma bolesti i učinak samo na određene stanice. Naime, iako je mutacija prisutna u cijelom tijelu, štetan učinak iskazuje samo na ganglijskim stanicama mrežnice. Obzirom da je LHON karakteriziran deficitom oksidativne fosforilacije, a $\text{NO}\cdot$ je poznati negativni modulator mitohondrijskog respiratornog lanca istražili smo njegovu ulogu u razvoju LHON-a. Rezultati u ovom radu pokazuju da dugotrajna izloženost dušikovom oksidu ima veći utjecaj na smrtnost stanica LHON-a uspoređujući je sa smrtnosti kontrolnih stanica i pretpostavljaju da se ROS i RONS stvaraju u većim količinama u ovom patološkom stanju i vode ka staničnoj smrti. Vođeni tom mišlju, provjerili smo i količinu iNOS-a i eNOS-a na razini mRNA. Obzirom da rezultati nisu statistički značajni, pretpostavili smo da postoji razlika u ekspresiji jednog ili više NOS enzima kod pacijenata oboljelih od LHON-a ali ovo pitanje ostaje otvoreno za daljnja istraživanja. Buduća perspektiva je potpuno objašnjenje uloge $\text{NO}\cdot$ u specifičnim mitohondrijskim bolestima i rješavanje zagonetne ekspresije i aktivnosti samog NOS-a. Možda upravo metabolizam $\text{NO}\cdot$ može biti važan u patofiziologiji LHON-a te njegovo razumijevanje može pridonijeti razvoju efikasnijih terapija i preventivnih mjera.

Rad je pohranjen u Središnjoj knjižnici Sveučilišta u Zagrebu Farmaceutsko-biokemijskog fakulteta.

Rad sadrži: 40 stranica, 24 grafičkih prikaza, 6 tablica i 47 literaturnih navoda. Izvornik je na engleskom jeziku.

Ključne riječi: Dušikov oksid, sintaza dušikovog oksida, oksidativni stres, Leberova nasljedna optička neuropatija.

Mentor: **Dr. sc. Jerka Dumić**, redovita profesorica Sveučilišta u Zagrebu Farmaceutsko-biokemijskog fakulteta.

Ocjenjivači: **Dr. sc. Jerka Dumić**, redovita profesorica Sveučilišta u Zagrebu Farmaceutsko-biokemijskog fakulteta.

Dr. sc. Sandra Šupraha Goreta, docentica Sveučilišta u Zagrebu Farmaceutsko-biokemijskog fakulteta.

Dr. sc. Jasna Jablan, viša asistentica Sveučilišta u Zagrebu Farmaceutsko-biokemijskog fakulteta.

Rad prihvaćen: rujan 2015.

Basic documentation card

University of Zagreb
Faculty of Pharmacy and Biochemistry
Department of Biochemistry and Molecular Biology
A. Kovačića 1, 10000 Zagreb, Croatia

Diploma thesis

Nitric oxide synthase expression and activity in cell models relevant to human pathophysiology

Kristina Radić

SUMMARY

Due to complex interactions of mitochondrial and nuclear DNA, the real cause of inherited mitochondrial diseases is still unclear and patients currently lack effective treatments. Leber's hereditary optic neuropathy (LHON), one of the most common inherited optic neuropathies, is caused by point mutations in mtDNA that result in a defect of respiratory chain complex I activity. From the biochemical point of view the bioenergetic failure and the enhanced reactive oxygen species (ROS) production are typical hallmarks of LHON disease, but still they do not explain the late onset and the incomplete penetrance. Moreover it is still unknown why, although the mutation is present overall the body only the RGCs are affected. Since LHON is characterized by a deficit in the oxidative phosphorylation chain and NO \cdot is an established mitochondrial respiratory chain negative modulator, we checked if it might have a role in the LHON development and progression. The results presented in this thesis prove that long-term exposure to NO \cdot has a larger impact on LHON cells viability compared to controls and suggest that higher levels of reactive oxygen and nitrogen species (ONOO \cdot) are produced in this pathological state, leading to cell death. In addition, careful though still statistically insufficient evaluations of the levels of iNOS and eNOS mRNA expression seems to suggest that there might be a difference in the expression of one or more NOSs in LHON patients: this question however remains open. Future perspectives are, indeed, to provide a complete picture about involvement of NO \cdot in this specific mitochondrial disease and to solve the conundrum of the NOSs expression and activity. The feeling is that the NO \cdot metabolism can be relevant to LHON pathophysiology, its comprehension opening to the development of more efficient therapeutic and preventive interventions.

The thesis is deposited in the Central Library of the University of Zagreb Faculty of Pharmacy and Biochemistry.

Thesis includes: 40 pages, 24 figures, 6 tables and 47 references. Original is in English.

Keywords: Nitric oxide, nitric oxide synthase, oxidative stress, Leber's optic hereditary neuropathy.

Mentor: **Jerka Dumić, Ph.D.** *Full Professor*, University of Zagreb Faculty of Pharmacy and Biochemistry

Reviewers: **Jerka Dumić, Ph.D.** *Full Professor*, University of Zagreb Faculty of Pharmacy and Biochemistry
Sandra Šupraha Goreta, Ph.D. *Assistant Professor*, University of Zagreb Faculty of Pharmacy and Biochemistry
Jasna Jablan, Ph.D. *Senior Assistant*, University of Zagreb Faculty of Pharmacy and Biochemistry

The thesis was accepted: September 2015.