



UNIVERSITÀ
DEGLI STUDI
DI PADOVA

Università degli Studi di Padova

Padua Research Archive - Institutional Repository

Word order in the Old Italian DP

Original Citation:

Availability:

This version is available at: 11577/3186029 since: 2016-05-26T10:14:29Z

Publisher:

Oxford University Press

Published version:

DOI:

Terms of use:

Open Access

This article is made available under terms and conditions applicable to Open Access Guidelines, as described at <http://www.unipd.it/download/file/fid/55401> (Italian only)

(Article begins on next page)

Part Two

WORD ORDER, FEATURES,
AND AGREEMENT



6

Word Orders in the Old Italian DP

CECILIA POLETTO

1 Laying out the problem

In this article¹ I examine the impact of a cartographic approach on research about diachronic change and investigate the internal structure of the DP in Old Italian (OI). I propose that some of its marked word orders can be interpreted as instances of a scrambling phenomenon that allows a series of DP internal elements to move in front of the head noun. I show that scrambling in the DP displays similar properties to those found in the vP and the CP layers, which suggests an analysis in terms of left peripheral movements in a way similar to the one usually assumed for the V2-like property of OI.² Although I will not analyze in detail scrambling in the vP phase or V2 in this article (see Poletto [2006] for a detailed discussion), I will assume that all phases are built in a parallel fashion (see Poletto [2006] in particular with respect to the formal properties associated with the left periphery.³ In a way parallel to the distinction found in the left periphery of the CP, there are two differences between OI and Modern Italian (MI) left periphery: in OI the lexical head can move to the lowest X^o position in the left periphery of the DP phase, while in MI this is not possible. I concentrate here on the second fundamental distinction between the Old and the Modern Italian DP: in

¹ It is my pleasure and my honor to dedicate this article to Luigi Rizzi, whom I owe the best time of my professional life in Geneva many years ago and who remains an unsurpassed source of inspiration as the head of a school of thought.

² The idea that there is a parallel between sentential structure and DP structure is rather old and goes back at least to Siloni (1995). Here I will make extensive use of Giusti (2006), who explicitly assumes a parallel between the DP and the CP structure, though the exact make of all the projections is still to be investigated.

³ I am aware of the fact that there has been a recent debate concerning the status of the DP as an independent phase or not, but I will keep the idea that DP is indeed a phase, because it can have a thematic grid and because of the well-known similarities between the DP and the CP. For a more detailed discussion on the parallel between the DP and the CP in a cartographic perspective see Giusti (2006).

OI, there are left peripheral positions that are accessible to movement that are not accessible anymore. This provides another parallel between the CP and DP structure, as it has been noticed that the OI left periphery allows for movements to Specifiers in the left periphery that are no longer possible in MI: for instance, the informational Focus position in the CP is accessible without any further restriction in OI, while in MI it is only available when the contrastive Focus position is already occupied (see Benincà and Poletto [2004] for a detailed analysis of this distinction and Cruschina [2010] for modern Sicilian) and a class of null topics are found in OI that are not licensed in MI anymore (see Poletto 2014). This differential access to the left periphery accounts for at least three different types of movements internal to the DP which can be shown to display different properties: (a) PP preposing, (b) pre- and postnominal structural genitives, and (c) prenominal appositive adjectives.⁴

In section 1.1 I summarize some recent work on the DP structure that will be relevant to my analysis of OI.

In section 2 I investigate those scrambling cases in which a PP originated inside the NP is raised to the DP or PP edge that contains it. On the basis of the empirical generalization stating that whenever an object PP is preposed, the definite determiner is never realized, I will propose that the preposed PP is located in the specifier of a DP-peripheral position (probably the highest one corresponding to ForceP in the CP) whose head is usually occupied by the definite determiner, which is not realized if its Specifier is occupied according to an economy principle.

In section 3 I will argue that (a) OI still has some residual cases of structural genitive (in contrast to MI) assigned to possessive elements that can occur pre- or postverbally depending on the type of possessive and (b) it can be shown that at least some head nouns clearly have access to the left periphery of the DP.

In section 4 I investigate another typical feature that distinguishes Old and Modern Italian, namely the fact (as already noted by Thiella [2008]) that restrictive adjectives, which can only be postnominal in MI, can also occur in prenominal position in OI. I will treat also these cases as movement of the adjective to a left peripheral position, a hypothesis already put forth by Giusti (2006) for the (pragmatically very restricted) MI cases. This possibility will also be tied to the V2-like property of the OI DP, which allows for movement of the N° to the DP internal left periphery.

⁴ The empirical basis of this work is provided by a selection of the Opera del Vocabolario (OVI) online corpus <<http://artfl-project.uchicago.edu/content/ovi>> which only include Bono Giamboni's *Libro dei Vizi e della Virtudi*, Dante's *Vita nuova*, and the *Testi antichi fiorentini del Dugento* edited by Schiffini. The reason why I made a selection with respect to the texts present of the OVI database is that all the examples have been extracted manually as the corpus is not syntactically tagged, which required going through all the texts to extract the examples.

Giusti (2006) shows that MI does have an active left periphery as Topic movements of adjectives are indeed possible. However, the basic distinction between the Old and the Modern Italian DP is the same that is well-known from work by Benincà (1984, 2006) for the CP layer: it is indeed possible to move XPs to the CP layer both in Modern and Old Italian. Thus, the change from OI to MI is due to the interplay of two specific properties: the first is that the head noun can reach the head to the lowest position in the left periphery, either of the CP or of the DP, while this is not the case in modern Italian; the other is that there are positions in the left periphery that are available to fronting in OI which are not in MI.

1.1 THE STRUCTURE OF THE DP PHASE



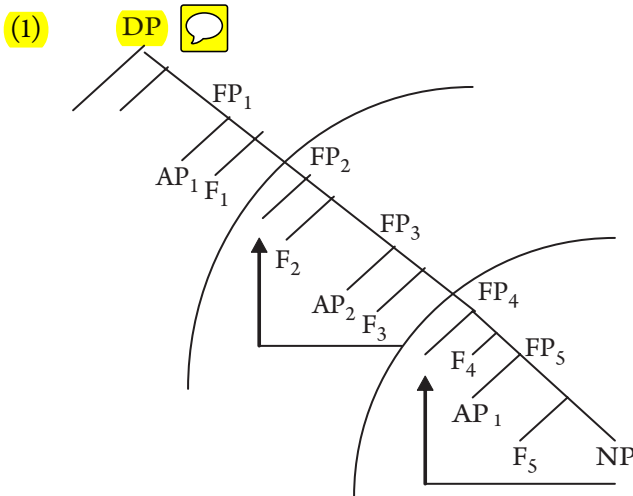

In recent work Cinque (2005) entertains the hypothesis that the noun movement is to be analyzed as the displacement of the entire NP to all the specifiers of the various functional projections in the IP-like space of the DP⁵ or of successively higher XPs into higher specifiers giving rise to what is called “snowballing movement” and thus reversing the order of the adjectives as shown in (1) (see also Laenzlinger, this volume).



Cinque (2005) observes that in Modern Romance languages, whereas in prenominal position the adjective receives only one interpretation, which corresponds to individual level, nonrestrictive, and absolute reading, in postnominal position it can have two interpretations: the same of the adjective in prenominal position, or another interpretation, corresponding to stage level, restrictive,

⁵ I will follow here Giusti (2006), who proposes that the highest projection in the IP-like space of the DP is a NumberP.

and relative reading. Cinque (2005) illustrates his claim with examples of the following type:

- (2) Le invisibili stelle di Andromeda sono molto distanti.
The invisible stars of Andromeda are very far 
 “Andromeda’s stars are all invisible and very far” 
- (3) Le stelle invisibili di Andromeda sono molto distanti.
The stars invisible of Andromeda are all far 
 a. “Andromeda’s stars are all invisible and very far” 
 b. “there are some stars of Andromeda’s which are invisible and these are very far” 

He further notices that this is the opposite of what we find in English, where restrictive adjectives can only be found in prenominal position. The explanation Cinque (2005) proposes for this difference is illustrated on the basis of the following structure: he starts from the assumption that the order we observe in English, as is generally the case in languages in which modifiers precede the head, is the basic order of the adjectives. In Romance restrictive adjectives can only be postnominal because there is movement of the whole FP containing the noun and nonrestrictive adjectives to the Spec of the highest position in the DP, a movement that leaves the restrictive adjectives, which in their basic order are the highest, as shown by languages like English, in a postnominal position:

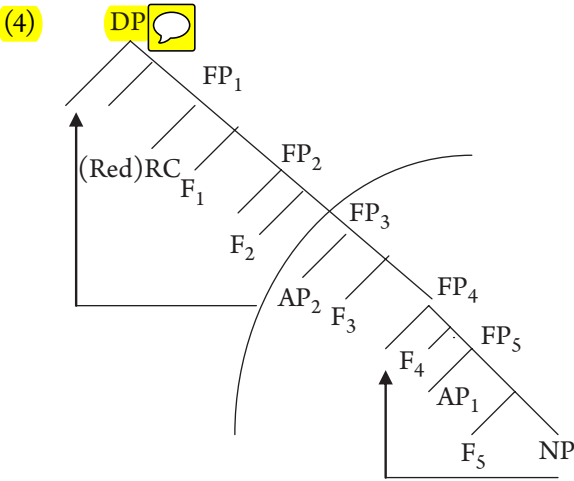

In what follows I will claim that this movement does not necessarily apply in OI because of the V2-like property of the Noun.



Giusti (2006) also follows the idea that the CP and DP have similar structures and analyzes prenominal adjectives as movements to a DP internal left periphery. She

assumes that Cinque's hierarchy of the adjectives is universal and can only be violated by A'-movement of an adjective and proposes the following more detailed left periphery of the DP, where the DP position corresponds to Force (and realizes the Case feature), while the lower dP corresponds to FinP in the CP layer and can host the head noun in N initial languages like Albanian. The intermediate Kon(trastive) position is a Topic-like position where adjectives can be located when they are contrastive:

(5) [DP Kase [KonP [dP Number [AgrP ... [NP]]]]]

Lower than dP there is also an IP-like space with several Agreement projections whose specifiers host adjectives as Cinque (1994) proposes.

Starting from this hypothesis of the internal structure of the DP layer, I will assume that the basic difference between Modern and Old Italian is the same that we find in the CP layer, (modulo the different labeling), namely the V2-like property of the left periphery of each phase. As the inflected verb can raise to the lowest C projection, namely Fin, when it is empty, the N can raise to d. As the inflected verb can also raise to higher positions in the CP, (see Benincà [2006] who shows that the inflected verb can raise up to Topic, creating enclisis of object clitics), there can be cases in which the N does not only raise to d but also higher up to D. This idea thus predicts that when N raises to the lower d or the higher D the corresponding "complementizer" does not occur, as it happens with the inflected verb. Determiners are the most probable counterpart of complementizers in the nominal domain. Like complementizers, they are "multifunctional" in providing the connection to the phase external structure and at the same time providing the "type" of phase (in the case of the DP, the determiner expresses features like referentiality, specificity, and also case). I will not be able to justify this assumption in the present work, and I refer to Poletto (2014) for a detailed analysis of the V2-like properties of the DP. What I will concentrate on here are rather the various movement possibilities that can be observed in OI and that are not possible any longer in MI. I will show that:

a) **there**  positions in the left periphery of the clause that cannot be realized in MI but can host XPs in OI, as it is the case for the Informational Focus position in the CP layer as proposed by Benincà (2006) for OI and Cruschina (2009)  for modern Sicilian. Among the various positions that can be occupied by XP in OI which are blocked in MI, I will concentrate here on the movement of an XP originating inside the DP and moving to the edge of the nominal phase, whose category can either be a DP, QP, or PP.

b) The left peripheral type of movement has to be distinguished from non-left peripheral movement inside the DP, which only targets some specific possessive pronouns that can bear a structural case in a position corresponding to the one of the TP in clauses. Also this type of phase-internal movement does not exist anymore in modern Italian.

The internal layering of the OI DP is thus identical to the one of MI and is illustrated in (6a). However in OI additional movements are possible that are not allowed in MI: (6b) illustrates a case of left peripheral movement to the edge of the DP phase and (6c) phase internal movement to a structural case position of possessive pronouns:

- (6) a. $[_{DP} [_{SpecDP} XP] D^{\circ} \text{def.det} [_{KonP} [_{dP} [_{AgrP} [_{SpecAgrP} [Poss.Pron]]] .. [_{NP} N^{\circ} [Poss.Pron] [XP]]]]]$
- b. $[_{DP} [_{SpecDP} XP] D^{\circ} \text{defD} [_{KonP} [_{dP} [_{AgrP} [_{SpecAgrP} [Poss.Pron]]] .. [_{NP} N^{\circ} [Poss.Pron] [XP]]]]]$
- c. $[_{DP} [_{SpecDP} XP] D^{\circ} \text{defD} [_{KonP} [_{dP} [_{AgrP} [_{SpecAgrP} [Poss.Pron]]] .. [_{NP} N^{\circ} [Poss.Pron] [XP]]]]]$

In what follows I will first consider cases of (6b) and then cases of (6c).

2 PP fronting as movement to the DP edge

Old Italian, being an SVO language like MI, generally displays the order head noun-PP:

- (7) e a Seleuco, figliuolo d' Antioco, ee data la signoria dell' oste
and to Seleuco, son of Antioco, had given the command of the
(B. G. Or.)
army
“and he had given to Seleuco, son of Antioco, command over the army”

Giorgi (2010) notices that, although this is by far the more widespread option, OI also displays some striking cases of prenominal PPs, which are mainly found in poetry, but also, though more sporadically, in prose. The following examples show the case in point:⁶

⁶ The fact that the definite determiner never appears when PP fronting applies does not necessarily mean that this is the only context in which the definite determiner is not realized in OI. The distribution of definite determiners in OI is rather different from MI, as shown by Thiella (2007) and depends on several semantic and syntactic factors. As for the distribution of indefinite articles, as far as I know nobody has ever investigated this point. If it were the case that also indefinite articles are sometimes null, this would mean that cases like (8c) are not necessarily to be interpreted as definite, but there could also be a null indefinite article. (8c) actually looks like a case in which the DP “madre antica” is definite, but unfortunately this is not always clear for all the examples. Therefore, I leave the problem concerning the definite/indefinite status of DPs with internal PP-fronting open, as it awaits future research on the distribution of indefinite articles.

- (8) a. Fanno di loro gente un capitano c'ha e Umiltà
do.3pl of their people a captain that has name humility
"They elect a captain of their people called Humility" (VeV 27)
- b. gli altri c'hanno o neente
the others who have.3pl of love nothing
"The others who have nothing of love" (C. Davanzati XI, 229)
- c. Morte villana, di pietà nemica, di dolor madre antica⁷
Death villain, of mercy enemy, of sorrow mother ancient
"You, villain death, you are the enemy of mercy and the ancient mother
of sorrow" (VN)
- d. lungi di Gerusalemme bene cinque leghe
away from G. well five miles
"A good five miles away from Gerusalem" (San Gradale 40)

Notice that an account in terms of a split left periphery of the DP that allows for PP fronting has an advantage in terms of the general theory of how linguistic change works: it provides us with the means to analyze both (7) and (8) as being part of one and the same grammar, without resorting to the hypothesis that speakers require two grammars (an "Italian" and a "Latin" one) to produce (7) as well as (8). This means that we do not need to apply the idea that OI "swings" between two grammars, one of which is modeled on Latin, but that (most probably due to Latin influence) OI has simply maintained a rule of PP-fronting that allows us to explain (8) but is also connected to other phenomena of the internal syntax of the DP, as we will see in the following text. Furthermore, this property is found across phases, which renders it more stable and easier to learn.

Hence, I propose that the examples above are to be analyzed as the effect of a scrambling process that moves the PP to the highest position of the phase, that is, as instances of (6b). As discussed, Giusti (2006) proposes that in MI it is possible to move adjectives to a prenominal contrastive topic position located lower than the edge of the DP phase. Because examples like those in (8) are not grammatical in MI, they have to be analyzed differently from Giusti's contrastively topicalized adjectives.

That this phenomenon is different from the one analyzed by Giusti (2006) for MI is also shown by the fact that PP-fronting is never found with a definite determiner. We can formulate following empirical generalization:

- (9) When an XP is preposed in front of the N, the N never has a definite determiner.

⁷ This case without a determiner is clearly definite; here Dante refers to a personification of Death.

In the sample I manually abstracted out of the OVI corpus there are cases in which the PP precedes an indefinite article or a quantifier (see (8a, b)), but no cases of definite determiners (see (8c) and footnote 5). If cases like (8) are to be explained as instances of (6b), here repeated as (10), we still have to explain why (9) holds:

- (10) $[_{DP} [_{SpecDP} [_{PP} \text{di dolor}]]]_{D^{\circ}} \text{defD} [_{KonP} [_{dP} [_{AgrP} [_{SpecAgrP}] [\text{madre}]]]_{ADjP} \text{antica}]$
 $[[_{NP} [\text{madre}]] [_{pp} \text{di dolor}]]_{\cdot\cdot}$

In (10) the PP *di dolor* “of sorrow” has moved to the highest Spec of the DP phase, the NP containing the head noun *madre* “mother” has moved from its based position to a position higher than the adjective *antica* “old,” which thus ends up in postnominal position. As for the reason why PP fronting seems incompatible with a definite determiner, I follow the standard assumption that when the SpecD position is occupied, the D° position needs not be filled (see among others Koopman [1996]).⁸ I will treat indefinite determiners in the same way as quantifiers, which never copy the highest head of the phase, D° . According to Giusti and Leko (2005) there are two possible structures for quantifiers: they can be similar to adjectives, and as such be located in positions lower than d° , or they can work like lexical elements selecting a full DP. However, in no case do quantifiers occupy either the D° position; hence they are perfectly compatible with PP fronting. The same is true of the indefinite article.

One indication that PP fronting targets the edge of the DP phase is provided by the observation that PP fronting is not only compatible with postnominal adjectives (see (8c)), but also with prenominal adjectives, and the order is always PP adjectives N as shown by the following example:

- (11) a. di dolor grave e soverchio tormento
of pain big and overwhelming torment
“the torment of a big and overwhelming pain” (ante (Rime, son. 772))
b. coloro che son oggi e che per innanzi nasceranno possono avere
those who are today and who in future will.be.born can
verace fede e di Dio perfetto intendimento
have real faith and of God perfect understanding
“those who live now and those who will be born will be able to have a
true faith and a perfect understanding of God” (eV 69)

⁸ The other possibility to account for the lack of a definite determiner is to assume that this is due to the parallelism of phases, and being OI a V2 language, then the V2-like property must apply to the DP as well. This means that the lexical Noun can move to the left periphery of the clause, in which case the determiner is not realized.

Because in these cases the preposed PP is located in front of an adjective,⁹ and because adjectives are the specifiers of FPs located in the IP-like space of the DP, this means that the PP must have been moved higher than this IP-like space inside the DP, namely to the DP-internal left periphery. Thus, the order PP-adjective N suggests that PP fronting is really very high in the structure of the DP namely the edge of the DP projection.¹⁰

Evidence in favor of a movement analysis of cases like (8) along the lines in (10) is provided by the fact that the phenomenon is also found within PPs: Andreose (2010) notices that OI presents several cases of PP preposing inside complex PPs:

- (12) a. Ballata, i' voi che tu ritrovi Amore, / e con lui
 Ballad I want.1sg that you find.2sg love and with him go.2sg
 a **madonna davante** . . .
 to my-lady before
 "Ballad, I want that you find Love and with him go before my lady . . ."
 (VN 46)
- b. E come fue a te presso, così è a tutti coloro che
 and how was to you besides so is to all those that
 voglion te seguire . . .
 want.3pl you follow.inf
 "And as it was besides you, so it is besides all those that want to follow
 you . . ." (VeV 99)

Cases like (12) are rather frequent in the corpus and show that the fronting applies also at the edge of a PP: in both (12a) and (12b) there is a so-called lexical preposition that selects a functional preposition (in both cases *a* "at/to") that embeds the DP. Fronting applies here to the functional P and the DP that are placed in front of the lexical preposition.

Interestingly, when the PP fronts to the edge of the bigger PP containing it, there is no ban against a definite determiner, as (13) shows:

- (13) presso a tre miglia alla cittade
 close to three miles to.the city
 "three miles close to the city" (Pagani 247)

⁹ Notice that this looks like a real case of PP complement preposing, and this is clearly not a poetic text neither a translation from Latin.

¹⁰ If the definite determiner is similar to the complementizer of inflected clauses, according to Rizzi's (1997) original proposal, it should be merged in the highest left peripheral position. However, there has been recent work (see among others Ledgeway 2003, 2007) that shows that the complementizer can be merged lower and be raised. This could also be extended to the definite determiner, however at the moment I have no test to distinguish between the two hypotheses.

This is so, because the PP *presso a tre miglia* “three miles away” has been fronted to the Specifier of the PP whose head is the preposition *a* “at/to” not to the edge of the DP whose head is *cittade* “city.”

A further argument in favor of a movement analysis to the edge of the DP phase is provided by examples like the following, where the object PP has moved further on out of the DP into the clausal spine. Also cases like the following are ungrammatical in MI:

- (14) E delle genti del mondo quietare una parte
and of the world calm, in part
“And to calm one part of the people of the world” (VeV 78)

This shows that it is indeed possible to move the PP; actually the DP-internal movement most probably constitutes a preliminary step feeding the subsequent movement into the left periphery of the clause.

One more interesting argument is constituted by the fact that preposed PPs can have an indefinite article or a quantifier and the preposed PP is always located in front of them, showing that the movement is really to the edge of the whole phase, which also includes the QP:

- (15) a. Chi d’infamia d’alcuna macula si sozza
who of infamy of any spot himself gets.dirty
“who becomes dirty of any blemish of infamy” (VeV 29)
b. appresso la morte di questa donna alquanti die avvenne
after the death of this woman several days cosa...¹¹
happened.3sgthing
“several days after the death of this woman it happened that...” (VN 33)
c. Dipoi destructione di Troia anni CCCCXIV
after the distruction of T years 414
“414 years after the destruction of Troy” (Pagani 72)

In (15a) the PP is preposed in front of the quantified nominal expression “alcuna macula,” but because the verb *sozzare* requires a genitive, that is, a DP introduced by the preposition *di*, the fronted PP ends up in the edge of the phase, hence in front of the preposition *di*.

On this basis I conclude that OI has movement of a DP internal PP to the edge of the nominal phase, which is the SpecD, SpecPP, or the SpecPP position, which

¹¹ I report this example from Andreose (2010: 623) who notices that the phenomenon of PP preposing is found inside DPs indicating a time interval. He does not explicitly say that all these cases include a quantifier, but this is always the case.

explains why in these cases no definite determiner occurs, why the PP occurs on the left side of all other prenominal DP internal elements like adjectives. Furthermore, the fact that the edge of the nominal phase is available to PP fronting allows for further extraction of the PP inside the clausal spine.¹²

3 Movement to the IP-like space

Still starting from the general view that nominal expressions and clauses have similar structures, one might wonder whether OI is different from MI also with respect to movement in the IP-like space of the clause. One other striking case of DP-internal preposing of genitive pronouns is the one noted by Vanelli (2010) exemplified here by the following sentences:¹³

- (16) a. Al costui tempo
to.the of.whom time
“In his time” (CF 90)
- b. la colui vittoria
the him there victory
“his victory” (Ligario 181)

Cases of this type are completely impossible in MI, where a postnominal PP introduced by the preposition *di* “of” must be used yielding “al tempo di costui.” In OI the possessive complement *di costui* is preposed to the noun, and the preposition *di* disappears. Evidently, this construction cannot be assimilated to PP fronting examined in section 2 for the following reasons: (a) in PP fronting there is no deletion of the preposition (b) all types of prepositions can be fronted, not only elements introduced by *di* (c) in this case there is clearly no incompatibility with the definite determiner, which appears on the left of the moved possessive pronoun, while in cases of PP fronting the definite determiner is never realized.

Hence, if this is not PP fronting to the edge of the DP what is it then? I surmise that this construction represents an instance of structural case assignment where genitive is assigned in a dedicated position in the structure similar to Saxon genitive in English. The possessive is moved to SpecPossessive (a position already identified by Giusti [2006] and Stavrou [2008] on the basis of other languages).

¹² The distinction between MI and OI is not directly related to the possibility to move the N to the left periphery of the clause, but to the fact that, being OI a V2-like language, some left peripheral positions that are not available in MI are still active in OI, as is the case for informational Focus in the CP layer (see Benincà 2006; Poletto 2014).

¹³ The prenominal position is not the only one with an element like *costui*; on the contrary this position is rather limited in relation to the postnominal one. However, what is interesting here is that the possibility of having *costui* in prenominal position exists, while it does not in MI.

PossessiveP is similar to TP in being a structural case assigner, though it does not assign nominative but genitive. That a residue of genitive is found with pronouns is expected, as pronouns are generally those elements that can still display case even in languages that have lost it on DPs.

In this case the movement of *costui/colui* is not to the left periphery of the DP, but to a dedicated genitive position located in the IP-like space of the DP and similar to SpecT for the subject of tensed clauses. If this type of movement is to a Genitive case checking position, then the structure corresponding to (16) is the one in (17):

- (17) $[_{DP} [_{D^o} \text{il}] [_{TopicP} \dots [_{OP}] [_{dP} [_{PossP} [_{DP} \text{costui}] \dots [_{AgrP} \text{tempo} [_{NP} [_{N} \text{tempo} [_{DP} \text{costui}]]]]]]]]]]]$

This analysis also provides us with the means to capture further cases of structural genitive that do not only concern pronouns that were originally noted by Longobardi (1991) that are also found in the OVI corpus:¹⁴

- (18) a. in casa i Frescobaldi
in home the F.
“in Frescobaldis’ home” (GVillani b77)
b. In casa gl’Orciolini
in home the O.
“In Orciolinis’ home” (CF 126)

This type of construction is not identical to (16), as it only occurs with a definite set of head nouns.

Furthermore, with the N *casa* there is no definite determiner and the head noun precedes the structural genitive. Following Longobardi (1991), we propose that these cases are similar to construct state nominals, where there is movement of the possessive DP *gli Orciolini* to the SpecPoss position and movement of the head noun *casa* to D°, as the absence of the determiner indicates, thus bypassing its structural genitive DP. The derivation is illustrated in (19):

- (19) $[_{DP} [_{casa}] [_{TopicP}' [_{OP}]] [_{dP} [_{AgrP} [_{DP} \text{gli Orciolini}] \dots [_{AgrP} \text{casa}] [_{NP} [_{N} \text{casa}] [_{DP} \text{gli Orciolini}]]]]]]]]]$

¹⁴ There are examples of this construction with *casa* with the prepositions *da*, *from*, *di*, *of*, *a* *to* *at*, *in* *in*

¹⁵ This is also the view accepted by Renzi (2010) and Thiella (2008), who shows that in Old Venetian the name *barca* “boat” behaves the same. Moreover, they all notice that *casa* is representative of a small class of geographical nouns that all share the same structural property of being able to move to D. Given that this only concerns a small class, while I am rather concerned with the “standard” DP-internal movements, I will leave this topic aside and refer to the literature mentioned previously for further details.

The distinction between real construct state cases like (18) and cases like (16) does not reside in the movement of the possessive element, but in the movement of the head noun, which remains below SpecPossP in (16) but raises to D° in (18). As for the reason why only the noun *casa* (and a handful of other geographical nouns) has this special properties, see Longobardi (1991) who notices that this phenomenon of raising to the D° position is not only found in OI, but is rather general in Romance with various degrees of grammaticalization of the N corresponding to English “home” (e.g., in French has moved even further and has become the locative preposition *chez*).

Our rather detailed left periphery of the DP also captures further cases that lay in between the simple case in (16) in which only the possessive raises to SpecPoss and the construct state cases in which also the head noun raises to D°.

Andreose (2010) reports further cases of lack of the preposition *di* (i.e., of structural genitive) that appear with intrinsically relational nouns like kinship nouns:

- (20) a. La figliola Guidi Tinaçi d'Aliana
 the daughter Guido T of A.
 “The daughter of Guido Timazzi of Agliana...” (Streda 221)
- b. le rede Guglielmo Gitti
 the heirs Guglielmo Gitti
 “the heirs of G.G.” (Streda 24)

Cases like those in (20) look like a “mixed construction” because the structural genitive occurs after the head noun as in construct state but there is a definite determiner like in (16) and unlike in (18). Also these cases can straightforwardly be analyzed by assuming a split left periphery of the DP on the basis of Giusti (2006): here the relational noun has moved to the left periphery of the DP, but not as high as the definite determiner, but only to the lower d° position, as illustrated in (21):

- (21) [_{DP} [Ia] [_{TopicP}] [_{dP} [figliola] [_{PossP} [_{DP} Guidi Tinaçi d'Aliana] . . .
 [_{AgRP} figliola [_{NP} [_N figliola [_{DP} Guidi Tinaçi d'Aliana]]]]]]]

These cases clearly show that the head noun in OI can move to the left periphery of the DP according to the assumption that the V2-like property is established in OI across phases. One further interesting generalization that comes from this small overview of the different movement properties of different head nouns is that the SpecPoss position seems to be available only to pronouns when the head noun remains below PossP, while it is also available to DPs containing a proper noun (all the examples I found in the corpus have a proper noun as possessor)

when the head noun is intrinsically relational. The reason why structural genitive can be either pre- or postnominal is due to the independent V2-like property that the OI DP displays.

4 Prenominal restrictive adjectives

If we now turn to the order of adjectives, we see that there are several differences between OI and MI that suggest that OI allows for movements of adjectives to the left peripheral DP area that are now excluded in MI. In the previous sections we have seen that:

- a) The edge of the DP is available to PP fronting.
- b) The SpecPoss position assigns structural case thus preventing the realization of the preposition *di*.
- c) In some cases the head noun moves to the left periphery of the DP bypassing a structural genitive.

Here I will argue that the prenominal adjectives found in OI that are impossible in MI are also instances of movement to the left periphery of the DP, namely to a Topic or Operator-like position (illustrated in (25) as OpP) between D° and d° .

A well-known feature of OI with respect to MI (see Thiella 2008) is the fact that prenominal adjectives can have a restrictive interpretation in OI, while in MI prenominal adjectives can only be appositive (see section 1.2 where Cinque's analysis of this phenomenon is presented). This phenomenon is represented in (22) and (23), which are all ungrammatical in MI:

- (22) a. S'era svegliato nel **destrutto** cuore
 refl was awaken in.the ruined heart
 "It arose in the in the painful heart" (VN 43)
- b. avendo per anticho tempo grande nimistade
 having for old time great enmity
 "being enemies from old times" (CF 97)
- c. di vendichare la ricevuta onta
 to avenge.inf the received shame
 "to avenge the shame received" (Distruzione di Tr 64)

Cases like the ones mentioned are extremely frequent, but we also find cases of modified or coordinated adjectives with an interpretation that is impossible in

MI: the examples in (23) illustrate cases of prenominal coordinated adjectives that are ungrammatical in MI, (24) cases of modified adjectives:

- (23) a. Uno gentile e potente huomo
 a noble and powerful man
 “A noble and powerful man” (CF)
- b. Di là da mare rei e periculosi passi
 of there from sea guilty and dangerous passes
 “bad and dangerous passages on the other shore of the” (VeV 100)
- (24) a. domandò se avesse più care pietre
 asked.3sg if had.subj.3sg more valuable stones
 “asked whether he had more precious stones” (Nov. I, 123)
- b. E avessimi posto in più oscuro e salvatico
 and had.2sg-me placed in more obscure and
 luogo
 savage place
 “and placed me in a more known and savage country” (VeV 4)

The analysis I intend to put forward here still derives from the same property that explains why OI allows for PP fronting and for postnominal structural genitives, namely the V2-like property, which can be split into two phenomena: (a) the possibility to have N raising to the left periphery of the DP and (b) the possibility to reach left peripheral Specifier positions that are frozen in MI.

Recall that Cinque’s analysis of MI places restrictive adjectives in the highest position in the IP-like space of the DP internal structure, as their order with respect to other adjectives in the Germanic languages attests. The fact that in Italian the highest adjectives can only occur postnominally, while lower nonrestrictive adjectives can occur both pre- and postnominally is an “optic” effect due to movement of the whole big FP containing the NP and the lower nonrestrictive adjectives to the SpecD position, thus crossing restrictive adjectives, which thus surface in postnominal position. If the reason why in MI the highest adjectives appear to occur lower is that there is obligatory FP movement to the highest Spec, then the reason why in OI highest adjectives actually occur higher than lower ones must be due to the lack of the complex FP movement to SpecD, which in turn must be banned because of general properties that distinguish OI from MI. I claim that this general property is the V2-like property: that is, if the head noun can raise to the left periphery, then there is no need to pied-pipe the whole FP to SpecD. The distinction between Old and Modern Italian is thus due to the fact that in OI the head noun can raise at least to the d° position when d° is empty, thus preventing movement of the whole FP (including the head noun) to its specifier.

The V2-like property of the OIDP also allows for restrictive adjectives to move to the internal left periphery, thus yielding the prenominal order of the restrictive adjective. Cases like the one mentioned previously are thus to be analyzed as follows:¹⁶

(25) [_{DP} [_{DP} il] [_{TopicP} [distrutto] [_{OpP}] [dP cuore [AgrP cuore ... [_{NP} [_N cuore]]]]]]

An argument in favor of a leftward movement analysis of the adjective is the fact that in some cases the adjective has a PP complement that is left stranded on the right side of the head noun:

- (26) a. **Se io pensava di volere cercare una comune**
 If I thought.1sg of want.inf look.for.inf a
 via di costoro
 common way of them
 “If I thought about finding a common way with them” (VN)
 b. **e ciò non è propria natura di cavallo**
 and this not is own nature of horse
 and this is not in a horse’s nature” (Nov. 28)

In this case the adjective *comune* “common” is on the left of the head noun *via* “way” but its complement “of them” is on the right of the head noun. The phrase cannot be interpreted other than “a way common to them.” The same is true in (26b), where “own” can only be interpreted as taking the PP *di cavallo* “of horse” as its complement as it is clear from the context.

Notice furthermore that OI also has the possibility to extract the moved XP to a higher CP-left peripheral position, a possibility that is clearly tied to the one of DP-internal movement, because subextraction is also banned in MI:

- (27) a. **Molto** fue cotesto a dire grande ardimento
 very was this to say.inf big courage
 “It was very great courage that” (VeV 99)
 b. **Molto** sono male partiti
 very are badly separated
 “They are sorted very badly” (VeV 44)

¹⁶ Here I adopt the analysis of Romance V2 as proposed in Poletto (2002) and Poletto (2014) where the lexical head moves up to the lowest projection in the left periphery (in this case *d'*), but Topics can be realized in TopicP without the need to be in a Spec-head relation with the lexical head. This allows me to explain the cases of V3 and V4 where several topics appear in front of the inflected verb in the CP, which is what distinguishes Romance V2-like structures from the proper V2 of the Germanic languages.

- c. **Molto** fece il re **Pelleus grande festa al nepote**
 very made.3sg the king P. big feast to the nephew
 “The king P. made a very feast for the nephew” (**Distruzione di Troia**)

The cases presented in (27) can only be interpreted if we assume that the modifier marked in bold is to be interpreted with the following adjective. Notice furthermore that these cases are not only found with copular constructions, but also with other verbs (as in (27c)).

Further cases of extraction of modifiers from the DP are those like the one reported in (28), where the modifier *solamente* “only” modifies the PP *co le pettora de’ nostri cavalli* “with the breasts of our horses,” showing that there had to be left peripheral movement internal to the DP (or PP) in order to allow for further extraction, which is no longer possible in Italian.

- (28) a. **a** **e** **solamente** vi faremo cadere co le **pettora**
 that only you will.make fall.inf with the breasts of
de’ nostri cavalli
 our horses
 “We will overthrow you **a** only the chests of our horses” (VeV 96)

Moreover, given that cases of prenominal restrictive adjectives can be combined with the definite determiner, as minimal pairs like the following one display, I will not assume the same analysis I put forth for cases of PP preposing, which are incompatible with the definite determiner, thus suggesting movement of the PP/AdjP to the highest SpecD position, but movement to a lower position located in the Topic space of the DP-internal left periphery. The following examples constitute a minimal pair that shows that the movement of the adjective is compatible with a definite determiner but can also occur without it:

- (29) a. **Quella** c ha i **piue** ricchi fedeli
 that which has the more rich believers
 “The one that has the richer belie**ers**” (VeV 39)
 b. **E** aveva più ricchi fedeli
 and had.3sg more rich believers
 “And had the richer belie**ers**” (VeV 40)

The examples discussed, which show that (a) restrictive adjectives can be prenominal and that (b) it is possible to further extract modifiers into the CP, support the idea that the internal left periphery of the DP allows for movements in OI that are banned in MI, like it is the case in the CP and vP layers.

Hence, we can conclude that there is actually no difference in the basic positioning of the adjectives between Old and Modern Italian in the IP-like space of the DP internal structure, as expected in Cinque's theory; the only difference between OI and MI is that the left periphery of OI can attract adjectives to a position where they maintain their restrictive reading, while this is not the case in MI.

5 Conclusion

In this work I have shown that some scrambling phenomena found in the DP area in OI can be analyzed in a way parallel to V2 in the CP phase. We have seen that there are at least four types of movements in the DP area that have gone lost:

- a) The movement of a PP or to the highest position in the DP yielding scrambling as well as the nonoccurrence of a definite determiner.
- b) The movement of a genitive phrase to a specifier located most probably in the IP-like area of the DP, a position that licenses genitive case and thus prevents the occurrence of the preposition *di* "of."
- c) The head noun to the left periphery of the DP bypassing the structural genitive position.
- d) Adjectives (or portions of the adjectival structure) can move to a left peripheral position lower than SpecDP which keep their original interpretation and can be either restrictive or nonrestrictive.



All these movements have disappeared in modern Italian. I hypothesize that the reason for the loss of (a, c) is unique and is related to the V2-like property of the left periphery of the DP.

The reason why structural genitive has disappeared is not related to V2 per se, but the reason why structural genitive can be postnominal in OI directly depends on the possibility to move the head noun to the left periphery of the DP.

The reason why in OI restrictive adjectives can remain in a prenominal position avoiding "snowballing" movement of an XP including the noun and non restrictive adjectives as assumed by Cinque (2005) for MI is that snowballing is blocked by the "alternative" V2-like movement of the head noun in OI which allows for N to d.

This analysis has the general consequence that it does not require to postulate that languages like OI have two different grammars and explains the cases of re-ordering found at different levels of the DP structure like cases of movement that can be reduced to one single property of the language, namely the V2-like property, which is active at other phase edges as well.

References

- Andreose, Alvise. 2010. "Il sintagma preposizionale." In L. Renzi and G. Salvi, eds. *Grammatica dell'italiano antico*, vol. 1, 617–714. Bologna: Il Mulino.
- Benincà, Paola. 1984. "Un'ipotesi sulla sintassi delle lingue romanze medievali." *Quaderni Patavini di Linguistica* 4: 3–19.
- Benincà, Paola. 2006. "A Detailed Map of the Left Periphery of Medieval Romance." In R. Zanuttini, H. Campos, E. Herburger, and P. Portner, eds. *Negation, Tense and Clausal Architecture: Crosslinguistic Investigations*, 53–86. Washington, DC: Georgetown University Press.
- Cinque, Guglielmo. 1994. "On the Evidence of Partial N-movement in the Romance DP." In G. Cinque et al., eds. *Paths towards Universal Grammar*, 85–110. Washington, DC: Georgetown University Press.
- Cinque, Guglielmo. 1999. *Adverbs and Functional Heads: A Cross-Linguistic Perspective*. New York and Oxford: Oxford University Press. 
- Cinque, Guglielmo. 2005. "Deriving Greenberg's Universal 20 and Its Exceptions." *Linguistic Inquiry* 36: 315–32.
- Giusti, Giuliana. 2006. "Parallels in Clausal and Nominal Periphery." In M. Frascarelli, ed. *Phases of Interpretation: Studies in Generative Grammar*, Vol. 91, 163–86. Berlin: Mouton de Gruyter.
- Giusti, Giuliana, and Nedžad Leko. 2005. "The Categorical Status of Quantity Expressions." In N. Leko, ed. *Linguisticki vidici*, 121–84. Sarajevo: Forum Bosnae.
- Giusti, Giuliana, and Melita Stavrou. 2008. "Possessive Clitics in the DP: Doubling or Dislocation?" In D. Kallulli and L. Tasmowski, *Clitic Doubling in the Balkan Languages*, 105–32. Amsterdam: John Benjamins.
- Koopman, Hilda. 1996. "The Spec Head Configuration." In Edward Garrett and Felicia Lee, ed. *Syntax at Sunset, UCLA Working Papers in Syntax and Semantics* 1 37–64.
- Longobardi, Giuseppe. 1994. "Reference and Proper Names." *Linguistic Inquiry* 25: 609–65.
- Poletto, Cecilia. 2002. "On V2 and V3 sequences in Rhaetoromance." In S. Barbiers, L. Cornips, and Susan Van der Klei, eds. *Syntactic Microvariation*, Amsterdam: SAND. <<http://www.meertens.nl/books/synmic/pdf/poletto.pdf>>. 1–28.
- Poletto, Cecilia. 2006. "Parallel Phases: A Study on the High and Low Left Periphery of Old Italian." In Mara Frascarelli, ed. *Phases of Interpretation. Studies in Generative Grammar*, Vol. 91, 261–94. Berlin: Mouton de Gruyter.
- Poletto, Cecilia. 2014. *Word Order in Old Italian*. Oxford: Oxford University Press.
- Renzi, Lorenzo. 2010. *Grammatica dell'Italiano antico*. Il Mulino: Bologna.
- Thiella, Anna. 2008. *Il sintagma nominale negli antichi volgari di area veneta e lombarda*.  roman II: Padova.
- Vanelli, Laura. 2010. "I dimostrativi." In Lorenzo Renzi and Giampaolo Salvi eds., *Grammatica dell'italiano antico*, 349–57. Bologna: Il Mulino.