

# HENRY

Hydraulic Engineering Repository

Ein Service der Bundesanstalt für Wasserbau

---

Periodical Part, Published Version

**International Association for Hydro-Environment Engineering and Research (IAHR) (Hg.)**

## **Hydrolink 2019/1. Drone**

Hydrolink

Zur Verfügung gestellt in Kooperation mit/Provided in Cooperation with:  
**International Association for Hydro-Environment Engineering and Research (IAHR)**

---

Verfügbar unter/Available at: <https://hdl.handle.net/20.500.11970/108956>

Vorgeschlagene Zitierweise/Suggested citation:

International Association for Hydro-Environment Engineering and Research (IAHR) (Hg.) (2019): Hydrolink 2019/1. Drone. Madrid: IAHR (Hydrolink, 2019/1). [http://iahr.oss-accelerate.aliyuncs.com/library/HydroLink/HydroLink2019\\_01\\_29489d9sd8.pdf](http://iahr.oss-accelerate.aliyuncs.com/library/HydroLink/HydroLink2019_01_29489d9sd8.pdf).

### **Standardnutzungsbedingungen/Terms of Use:**

Die Dokumente in HENRY stehen unter der Creative Commons Lizenz CC BY 4.0, sofern keine abweichenden Nutzungsbedingungen getroffen wurden. Damit ist sowohl die kommerzielle Nutzung als auch das Teilen, die Weiterbearbeitung und Speicherung erlaubt. Das Verwenden und das Bearbeiten stehen unter der Bedingung der Namensnennung. Im Einzelfall kann eine restriktivere Lizenz gelten; dann gelten abweichend von den obigen Nutzungsbedingungen die in der dort genannten Lizenz gewährten Nutzungsrechte.

Documents in HENRY are made available under the Creative Commons License CC BY 4.0, if no other license is applicable. Under CC BY 4.0 commercial use and sharing, remixing, transforming, and building upon the material of the work is permitted. In some cases a different, more restrictive license may apply; if applicable the terms of the restrictive license will be binding.





# hydrolink

## DRONE SPECIAL

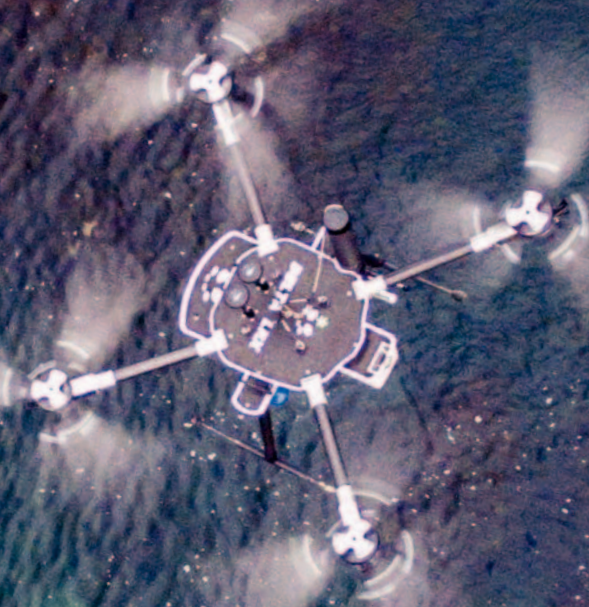

International Association  
for Hydro-Environment  
Engineering and Research

Hosted by  
Spain Water and IWHR, China

**DRONES IN HYDRAULICS**

SEE PAGE 4

**TO DRONE OR NOT TO DRONE**

SEE PAGE 16

**CANDIDATES FOR  
IAHR COUNCIL ELECTION**

SEE PAGE 28



# DRONES IN HYDRAULIC ENGINEERING AND HYDRO-ENVIRONMENT STUDIES

EDITORIAL BY ANGELOS N. FINDIKAKIS AND PAOLO PARON

The public perception of drones has changed greatly in recent years from viewed primarily as part of the military arsenal to being accepted as tools for multiple commercial applications, and even as toys, making popular Christmas presents for a broad range of ages. This has not only contributed to the acceptance of the drone business by the general public, but it also has triggered the interest of many engineers, scientists and other professionals to explore the use of drones as tools in their work. In the past five years, innovations in hardware and software have advanced drone technology to the point that non-experts too have started using it.

Several features of modern commercial drones have increased their appeal to professionals. Drones today are very safe and easy to use; they are becoming extremely portable; they offer unprecedented image and video quality; they can be deployed in very complicated and difficult to reach environments; they have an increasingly large range of operation (up to several km); the flying apps that are used to pilot or pre-programme flight lines are becoming increasingly easier to use and more reliable. In addition, drones offer unparalleled flexibility in capturing hyper-spatial, hyper-temporal and hyper (or multi)-spectral data. This opens new frontiers in measuring, monitoring, modelling and understanding natural phenomena and their interaction with human activities. Using an array of miniaturized sensors in the visible, infrared, thermal radar or LiDAR frequencies makes it possible to monitor almost every aspect of the natural and anthropic environments, in both urban and rural settings, as well as to conduct routine infrastructure monitoring, such as, for example, the inspection of sewers and dams.

Post-processing of drone data is now much faster than in the past thanks to a new generation of software: Structure from Motion allows for the reconstruction of centimetric accurate Digital Elevation Models (DEM) and smart algorithms like the Cloth Simulation Model by Zhang et al.<sup>[1]</sup> allows also for the interpolation of Digital Terrain Models from DEMs. Quantitative video measurements are now allowing for digital video gauging of rivers. Repeating the same flight plan at high temporal frequency allows to capture small changes in hydraulic and hydrological processes with high spatial resolution.

Last, but not least, the cost of drone equipment and the super computers needed to process the terabytes of data generated has been dropping exponentially.

In 2016 Goldman Sachs<sup>[2]</sup> estimated that by 2020 businesses and civil governments would have spent 13-billion-USD on drones. Similar sectorial studies<sup>[3]</sup> have projected that by 2025 the drone business in the US alone will create more than 100,000 new jobs, with a market of about 14 billion USD and precision agriculture representing the largest share of this market. The use of drones in agriculture offers the possibility of increasing irrigation water use efficiency. The use of drones as a major tool in topographic surveys and site exploration studies is also finding increasingly greater use.



Angelos N. Findikakis  
Hydrolink Editor

Paolo Paron  
Guest Editor

This special issue of Hydrolink presents few examples of the use of drone technology and methods in a variety of applications in hydro-environmental and hydraulic engineering studies. The article by Biggs gives an overview of the use of drones in hydraulics, including the development of high resolution digital elevation models needed for erosion, sedimentation and morphodynamic studies, and the use of drones for underwater imagery and velocity measurements in rivers.

The use of unmanned aerial systems in the

study of hydrologic processes by mapping changes in natural and urban landscapes and estimating flow velocities from images and video, is also discussed in the article by Manfreda and McCabe.

A discussion and examples of velocity measurements in rivers and streams in Denmark are presented in the article by Bandini et al. More examples of the use of unmanned aerial systems in the study of rivers and their ecosystems are presented in the article by Haas et al. The article by Hackl discusses the use of drones to obtain accurate topographic data that were essential for modelling the flow under a bridge in a mountainous region of Switzerland, and to assess the risk of scouring and erosion under different flood conditions. The article by Guillot describes the use of data from a small drone in combination with other aerial photography to study the morphodynamics of part of the shoreline of a small island off the Atlantic coast of France. The article by Paron et al. shows how topographic surveys with drones can be used to improve, update and calibrate flood modelling in data-scarce regions and under adverse conditions, such as those in the tropical environment of Mozambique. A different type of application of drones is presented in the article by Freissinet, who discusses the use of a new aerial sensor able to monitor cyanobacteria in water and collect data from two different lakes in France for use in a mathematical model to simulate the evolution of algal blooms in space and time. These seven examples illustrate the level of interest in drone technology among the hydraulic community.

We are clearly still in the infancy phases of the deployment of drones in support of rigorous science. On one hand the technology is moving very fast, as well as the software components, especially with the relatively new application of AI and object-based classification of these hyper detailed images. On the other hand, there is still a lot to be done for the methodological calibration of these tools in order to guarantee the fundamental principle of replicability required in every field of science. There is no doubt that the application of drone tools and methods is very exciting and opens up a number of new opportunities guided by rigorous testing but also by the creativity and ingenuity of the researchers.

## References

- [1] Zhang W. et al. 2016: "An Easy-to-Use Airborne LiDAR Data Filtering Method Based on Cloth Simulation", *Remote Sensing*, vol. 8, no. 6
- [2] <https://www.goldmansachs.com/insights/technology-driving-innovation/drones/>
- [3] Warwick, G. 2014: "AU/VI - Precision Agriculture Will lead Civil UAS", *Aviation Week Network*, <http://aviationweek.com/blog/auvsi-precision-agriculture-will-lead-civil-uas>



## IAHR International Association for Hydro-Environment Engineering and Research

### IAHR Secretariat

Madrid Office  
IAHR Secretariat  
Paseo Bajo Virgen del Puerto 3  
28005 Madrid SPAIN  
tel +34 91 335 79 08  
fax + 34 91 335 79 35

Beijing Office  
IAHR Secretariat  
A-1 Fuxing Road, Haidian District  
100038 Beijing CHINA  
tel +86 10 6878 1808  
fax +86 10 6878 1890

iahr@iahr.org  
www.iahr.org

*Editor:*  
Angelos Findikakis  
Bechtel, USA  
anfindik@bechtel.com

*Editorial Assistant:*  
Elsa Incio  
IAHR Secretariat  
elsa.incio@iahr.org

*Guest Editor:*  
Paolo Paron, UNESCO IHE

### Hydrolink Advisory Board

Luis Balaïron • CEDEX –Ministry Public Works, Spain  
Jean Paul Chabard • EDF Research & Development, France  
Yoshiaki Kuriyama • The Port and Airport Research Institute, PARI, Japan  
Jaap C.J. Kwadijk • Deltares, The Netherlands  
Ole Mark • DHI, Denmark  
Rafaela Matos • Laboratório Nacional de Engenharia Civil, Portugal  
Jing Peng • China Institute of Water Resources and Hydropower Research, China  
Patrick Sauvaget • Artelia Eau & Environnement, France  
James Sutherland • HR Wallingford, UK  
Karla González Novion • Instituto Nacional de Hidráulica, Chile

ISSN 1388-3445

Cover picture: Drones provide a cost-effective platform for aerial surveying of waterbodies. Photograph: Dave Allen, NIWA

NUMBER 1/2019

# IN THIS ISSUE

## DRONE SPECIAL

|   |    |
|---|----|
| <b>EDITORIAL</b> .....  | 2  |
| <b>DRONES IN HYDRAULICS</b> .....   | 4  |
| <b>EMERGING EARTH OBSERVING PLATFORMS OFFER NEW INSIGHTS INTO HYDROLOGICAL PROCESSES</b> .....  | 8  |
| <b>UNMANNED AERIAL SYSTEMS (UASS) FOR MONITORING WATER SURFACE ELEVATION, BATHYMETRY, SURFACE VELOCITY AND DISCHARGE IN STREAMS</b> ..... | 10 |
| <b>RIVERS 2.0 – TRANSFORMING RIVERS INTO DIGITAL LANDSCAPES USING UNMANNED AERIAL VEHICLES</b> .....                                      | 13 |
| <b>TO DRONE OR NOT TO DRONE? EXPERIMENTING THE USE OF UAV FOR FLOOD MODELLING IN DATA-SCARCE REGIONS</b> .....                            | 16 |
| <b>IMPACT OF UAV PHOTOGRAMMETRY ON THE FLOOD SIMULATION PROCESS OF BRIDGES IN MOUNTAIN REGIONS</b> .....                                  | 19 |
| <b>GAUTRELLE DIKE ANALYSIS AT OLERON ISLAND</b> .....   | 22 |
| <b>OPTICAL SENSOR AND DRONE SYSTEM FOR THE SURVEY OF CYANOBACTERIA IN FRESHWATER ECOSYSTEMS – OSS-CYANO</b> .....                         | 24 |
| <b>7<sup>TH</sup> INTERNATIONAL SYMPOSIUM ON HYDRAULIC STRUCTURES: A RETROSPECT</b> .....   | 26 |
| <b>2019 IAHR COUNCIL ELECTIONS</b> .....  | 28 |



IAHR is sponsored by:



Hosted by  
Spain Water  
and IWHR, China



# DRONES IN HYDRAULICS

BY HAMISH BIGGS

The rise of drones in hydraulics reflects the demand for higher resolution data at lower cost. Drones are now affordable, reliable and easy to use, making them well suited for investigation of finer scale processes (mm to cm), compared to the landscape scales covered by aircraft and satellites. The rise of drones has also been paralleled by exponential improvements in lightweight sensor technology. For example, high resolution digital cameras (>50 MP), LiDAR units and hyperspectral cameras can now be carried by consumer grade drones with less than 5 kg of payload. This article provides an introduction to the use of drones in hydraulics and discusses an exciting future of drone based remote sensing.



Figure 1. Drones provide a cost-effective platform for aerial surveying of waterbodies. Photograph: Dave Allen, NIWA

## Drone hardware

Unmanned Aerial Vehicles (UAVs), Unmanned Aerial Systems (UAS) and Remotely Piloted Aircraft Systems (RPAS) are some of the many synonyms for drones. Their forms are equally diverse, with fixed wing aircraft, miniature helicopters, balloons, blimps, kites and multirotor aircraft all used for environmental remote sensing <sup>[1]</sup>. The choice of appropriate drone hardware depends on the mission requirements (e.g. area covered, altitude, payload and flight time). The most commonly used drones for hydraulics applications are multirotor aircraft. Small multirotors (such as the DJI Phantom 4 Pro) are used for aerial

imagery and general surveying, while larger units (such as the DJI Matrice 600 Pro) are suitable for LiDAR and other payloads up to 5 kg.

## Aerial imagery and surveying

The most common application for drones in hydraulics is recording aerial imagery and surveying (Figure 1). The spatial resolution of aerial imagery is determined by drone altitude and camera specifications. For example, the DJI Phantom 4 Pro with 20 MP sensor and 24 mm equivalent focal length lens achieves pixel resolution of 5.5 mm at 20 m altitude and 27.5 mm at 100 m altitude. The spatial coverage of

aerial imagery is determined by flight speed, altitude and image overlap. Camera settings, flight speed and lighting are critical to obtain good aerial imagery. Shutter priority mode is recommended, with 1/1000 shutter (or faster) to minimise image blur. Ground Control Points (GCP) are used to obtain georeferenced aerial images. GCPs can be either targets set out and surveyed, or identifiable features with known (surveyed) locations. The use of GCPs can sometimes be avoided if camera origin is known with RTK or PPK GPS precision. Aerial images can either be analysed individually or combined into a 'georeferenced orthomosaic' (basically a 2D photo map) for further analysis



Figure 2. Drone-based survey of aquatic vegetation (River Urie, UK)

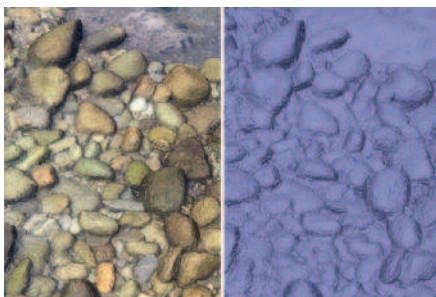

Figure 3. Solid models of a cobbled river bed resolved with underwater imagery from an amphibious drone (e.g. RC boat)

(Figure 2). Georeferenced orthomosaics can be easily generated with Structure from Motion (SfM) software such as Agisoft Photoscan or Pix4D. Imagery for this purpose should have 60-80% overlap on all sides and at least 8 GCPs distributed throughout the site. Further analysis of georeferenced orthomosaics often entails image segmentation into classes, then measurement of the total area of classes; or measurement of the number, area and dimensions of objects within a class<sup>[2]</sup>. Common applications in hydraulics are to delineate the boundaries of waterbodies, structures and biota (e.g. vegetation), then evaluate the total surface area and geometry of objects within each class.

### Image analysis

Classification of aerial imagery can either be performed manually<sup>[2]</sup> or using automated techniques<sup>[3]</sup>. Which approach is appropriate depends on the survey frequency, input data type, classes to be resolved and required output accuracy. For one-off surveys with RGB imagery, manual image classification provides higher accuracy<sup>[3]</sup> and is usually faster than using automated techniques. For automated image classification significant time must be spent setting up and tuning the classification algorithms, then evaluating the accuracy of the automatic classifications against manual classifications or ground truth data. For research applications, this is often a diversion from the original purpose of the survey and results in studies devoted to the accuracy of the automatic classification rather than detailed analysis of the survey data. Automated techniques often struggle to separate the boundaries of overlapping or touching objects within a class. This is not a problem if only the total area of classes is required, however if the dimensions of individual objects within a class are required, then this is a big problem and manual image classification should be used. Where automated classification techniques excel is for routine monitoring of total class area over large spatial extents with multispectral or hyperspectral imagery<sup>[4]</sup>. Hyperspectral imagery has hundreds of narrow spectral bands (compared to the 3 lumped bands of RGB imagery). It is not easy to visualise, but is well suited for supervised image classification, object-based classification, or machine learning approaches<sup>[3, 4]</sup>.

### Digital Elevation Models (DEMs)

Accurate DEMs are critical for many hydraulic applications (e.g. erosion, hydraulic modelling, sediment transport and morphodynamics). High resolution DEMs can be obtained from drone-based aerial imagery or light weight terrestrial LiDAR units (such as those from LiDAR USA). DEMs from aerial imagery are obtained using Structure from Motion (SfM) image processing software (e.g. Agisoft Photoscan or Pix4D). For most terrain types the DEMs obtained using SfM have similar accuracy to LiDAR, but much lower equipment cost<sup>[5]</sup>. In terrain that is heavily vegetated or lacks distinct visual distinct features (e.g. uniform mud, sand, or snow) LiDAR provides more accurate and reliable data.



**Hamish Biggs** is a scientist at the National Institute of Water and Atmospheric Research (NIWA) in New Zealand. His research covers novel remote sensing techniques, flow around aquatic vegetation, sediment transport, biomechanics, image analysis and field equipment development.

### Bathymetry

In the future bathymetric (green) LiDAR units may reach the price, performance and weight of terrestrial (infrared) LiDAR units. When this occurs drone-based bathymetric LiDAR surveys will become common practice. Until then, other means to determine bathymetry from remote sensing data can be used. For example, bathymetry from: underwater imagery (Figure 3), through water imagery corrected for surface refraction<sup>[6]</sup>, spectral attenuation of light with depth, or turbulence metrics<sup>[7]</sup>.

### Underwater imagery

The SfM image processing techniques typically used for aerial drone surveying, can equally be applied to underwater camera imagery (Figure 3). For rivers that are sufficiently clear and deep, this enables Remote Control (RC) boat-based surveys to resolve bathymetry, grain size distributions and bed roughness. The bathymetry data or solid models can even be used as inputs for 2D or 3D hydraulic modelling.

### Sediment size distributions

Imagery from drones or underwater cameras (Figure 3) can be used to obtain sediment size distributions<sup>[8, 9]</sup>. The smallest size fraction that these techniques are suitable for depends on the spatial resolution of the imagery. For braided gravel bed rivers with predominantly coarse sediment, low altitude drone-based surveying is a convenient way to map sediment size distributions over large spatial extents. This data has many applications, such as physical habitat mapping, roughness coefficients for hydraulic modelling, or inputs for sediment transport modelling.

### Discharge gauging and Large Scale Particle Image Velocimetry (LSPIV)

Discharge gauging from imagery is useful for flow conditions where in-water measurement equipment cannot be deployed (e.g. flash floods and debris flows) or in remote locations



without access to standard gauging equipment [10]. Imagery can be recorded from river banks or drones, then LSPIV techniques used to determine surface velocities. Discharge is estimated from surface velocities, bathymetry and a conversion from surface velocity to depth averaged velocity (such as the index velocity method). Bathymetry can be surveyed independently or estimated from imagery derived data (e.g. turbulence metrics) [7]. Imagery from drones has advantages over bank-based imagery in orthorectification and spatial coverage. For example, spatial distributions of surface velocities for physical habitat mapping, and discharge gauging in large rivers where bank-based imagery is not feasible. The 'Drone flow' project in New Zealand is currently developing a drone based LSPIV system featuring a stereoscopic camera system, high resolution IMU (for camera orientation) and RTK GPS (for camera origin) that will avoid the need for Ground Control Points (GCPs) and significantly improve drone based hydraulic measurements.

### The future?

In such a diverse and rapidly evolving field, it is challenging to speculate about the future. However, there are a number of technologies and capabilities to watch. The first is the performance (and cost) of thermal infrared cameras. Rapid improvements in both spatial resolution (number of pixels) and thermal resolution (temperature graduation) will lead to many exciting applications in hydraulics. For example: studying turbulence and mixing processes at river confluences, identifying zones of ground water upwelling in rivers, studying the breakdown of thermal stratification in waterbodies as surface layers cool, studying mixing processes due to wind loading, using subtle water temperature differences as tracers for LSPIV, and discharge gauging at river confluences. The development of high performance aerial surveying systems (such as 'Drone flow') also promise an exciting future for drones in hydraulics by providing input data for hydraulic modeling, fish passage, discharge gauging and physical habitat assessments. ■

### References

- [1] Klemas, V. (2015). Coastal and environmental remote sensing from unmanned aerial vehicles: An overview. *Journal of Coastal Research*, 31(5), 1260-1267.
- [2] Biggs, H., Nikora, V., Gibbins, C., Fraser, S., Papadopoulos, K., Green, D. & Hicks, D.M. (2018). Coupling Unmanned Aerial Vehicle (UAV) and hydraulic surveys to study the geometry and spatial distribution of aquatic macrophytes. *Journal of Ecohydraulics*, 3(1), 45-58.
- [3] Husson, E., Ecker, F. & Reese, H. (2016). Comparison of manual mapping and automated object-based image analysis of non-submerged aquatic vegetation from very-high-resolution UAS images. *Remote Sensing*, 8(9), 724.
- [4] Parsons, M., Bratanov, D., Gaston, K. & Gonzalez, F. (2018). UAVs, Hyperspectral Remote Sensing, and Machine Learning Revolutionizing Reef Monitoring. *Sensors*, 18(7), 2026.
- [5] Fonstad, M., Dietrich, J., Courville, B., Jensen, J. & Carboneau, P. (2013). Topographic structure from motion: a new development in photogrammetric measurement. *Earth Surface Processes and Landforms*, 38(4), 421-430.
- [6] Dietrich, J. (2017). Bathymetric Structure from Motion: extracting shallow stream bathymetry from multi view stereo photogrammetry. *Earth Surface Processes and Landforms*, 42(2), 355-364.
- [7] Deterf, M., Johnson, E. & Weitbrecht, V. (2017). Proof of concept for low cost and non contact synoptic airborne river flow measurements. *International journal of remote sensing*, 38(8-10), 2780-2807.
- [8] Buscombe, D. (2013). Transferable wavelet method for grain size distribution from images of sediment surfaces and thin sections, and other natural granular patterns. *Sedimentology*, 60(7), 1709-1732.
- [9] Deterf, M. & Weitbrecht, V. (2013). User guide to gravelometric image analysis by BASEGRAIN. In: *Advances in River Sediment Research, Proceedings of the 12th International Symposium on River Sedimentation ISRS 2013*, (pp. 1789-1796). Kyoto, Japan. CRC Press.
- [10] Le Coz, J., Jodeau, M., Hauet, A., Marchand, B. & Le Boursicaud, R. (2014). Image-based velocity and discharge measurements in field and laboratory river engineering studies using the free Fudaa-LSPIV software. In: *Proceedings of the international conference on fluvial hydraulics, River Flow 2014* (pp. 1961-1967). Lausanne, Switzerland. CRC Press.



Figure 4. Dr David Plew commences a surveying mission in Kaikoura, New Zealand. Photograph: Jochen Bind, NIWA





# 38<sup>th</sup> IAHR WORLD CONGRESS PANAMA CITY 2019 Water - Connecting the World

## THEMES TO BE COVERED

- Hydraulic Structures
- Water Management and Hydro-Informatics
- Ports and Coastal Engineering
- River and Sediment Management
- Hydro-Environment
- Climate Change and Extreme Events

### CONGRESS VENUE:

Panama City was founded in 1519, being the first Spanish city on the shores of the Pacific Ocean. With a skyline filled with modern buildings, the city is well known for its business structure, cosmopolitan culture and biodiversity.

The Panama Canal, only fifteen minutes from downtown Panama City, is one of the most important engineering works of the 20th and 21st century.

Panama is a country of diversity and contrasts; a country of multiple atmospheres, diverse in the historical, geographical and cultural aspects, and inhabited by a colorful mixture of ethnicities and customs. Because of this unique combination of people and unusual places, Panama City is a magical and fascinating destination. The Congress will provide every participant with a life-time memorable experience.

PLAN TO JOIN US IN 2019!

| KEY DATES AND DEADLINES |                        |
|-------------------------|------------------------|
| Paper Submission.....   | April 16, 2019         |
| Paper Notification..... | June 18, 2019          |
| Congress.....           | September 1 to 6, 2019 |

**PANAMA**  
HOTEL RIU PLAZA  
[iahrworldcongress.org](http://iahrworldcongress.org)

## Francis-99: FLUID STRUCTURE INTERACTION

[www.bit.ly/Francis-99](http://www.bit.ly/Francis-99)

### 28-29 MAY 2019 | Trondheim, Norway

Francis-99 is an open platform for the hydropower researchers, which gives possibility of exploring their capabilities and skills. Students & researchers use Francis-99 data and perform studies by applying different tools and techniques.

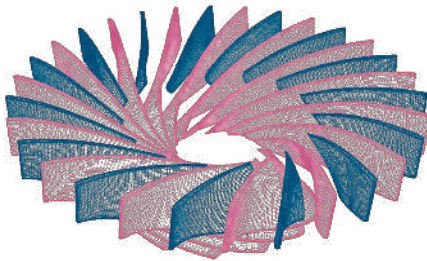

We have successfully organized the first and second workshops during 2014 and 2016, respectively. In the third workshop, we provide two test-cases: **HYDROFOIL** for basic research and **TURBINE** for applied research. More detail is available on the website.

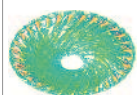

**Francis-99**



Chirag Trivedi ([chirag.trivedi@ntnu.no](mailto:chirag.trivedi@ntnu.no))



# EMERGING EARTH OBSERVING PLATFORMS OFFER NEW INSIGHTS INTO HYDROLOGICAL PROCESSES

BY MATTHEW F MCCABE & SALVATORE MANFREDA

Data, and its timely delivery, presents one of the major constraints in advancing the hydrological sciences. Traditional monitoring techniques are time consuming, expensive, and discontinuous in space and time. Moreover, field observations are influenced by instrumental degradation and human errors. While providing the foundation upon which much of our hydrological knowledge is based, new observational strategies are required to drive further understanding and insights. Recent advances in earth observation (EO) technologies present a new frontier for hydrologic monitoring and process description [1, 2].

If a goal of the hydrological sciences is to further advance our understanding and description of the underlying physical processes and mechanisms, traditional monitoring approaches are unlikely to provide the level of detail required to do this, for both technical and economical limitations. Indeed, our ability to monitor system processes in the face of recent climate and anthropogenic changes is being increasingly compromised by the significant decline in the number of monitoring installations over the last few decades[3]. The dynamic nature and inherent variability of many hydrological processes dictates a need for both high spatial and high temporal resolution data. New approaches and technologies that augment traditional monitoring systems are required.

Field measurements still represent the "gold-standard" in observational practice, and it is unlikely that anything will supplant the insights that a quality in situ monitoring network can provide. However, recent technological advances in both satellite and nearer-to-earth platforms[2] have redefined our capacity to observe and monitor processes through time, and over large spatial domains, in ways that are not possible via ground-based measurement alone. In particular, new CubeSat satellite platforms [4], unmanned aerial systems (UAS)[1], and even high-definition video cameras [2], offer the possibility to monitor the earth system in ways that existing ground-based infrastructure cannot. These observational advances rely, in large part, on technological developments deriving predominantly from the mobile phone and related consumer electronics industry, which has driven sensor miniaturization and relatively low-cost electronics that have enhanced communication, storage and power-

supplies. More specifically, the proliferation of low-cost digital cameras with high-quality sensors and large on-board storage, has enabled a new range of optically-based hydrological monitoring efforts. Indeed, several authors have exploited these technologies using novel image processing algorithms to investigate snow cover detection [5], derive rainfall intensity, [6] and measure streamflow velocity [7], to name just a few applications.

While certainly not new in terms of spectral sensing capabilities, optical techniques provide an efficient and non-invasive method for a variety of hydrologic monitoring tasks. One of the most mature applications of optical sensing from UAS is the use of computer vision approaches (i.e. structure-from-motion) to reconstruct three-dimensional surfaces, allowing previously unheard of resolutions and accuracies that can inform the production of digital surface and elevation models [8]. The capacity to map both urban and natural landscapes [9] and to respond to dynamically changing surface fields, represents a critical advance in hydraulic assessment, particularly for flood mapping and response [10] (see Figure 1). More advanced applications of image and video capture from UAS include flow visualization methods that can yield a spatially distributed estimation of the surface flow velocity field, based on the similarity of image sequences. Proof-of-concept experiments have demonstrated the feasibility of applying these methods to monitor flood events from crowd-sourced imagery [11], or even to reconstruct velocity fields of natural stream reaches [12]. As an example, Figure 2 presents the use of optical velocimetry measurement over the Bradano river in Southern Italy. The optical image used for the analysis is also reported with two insets describing features of the free water surface that can be used in a flow tracking algorithm.

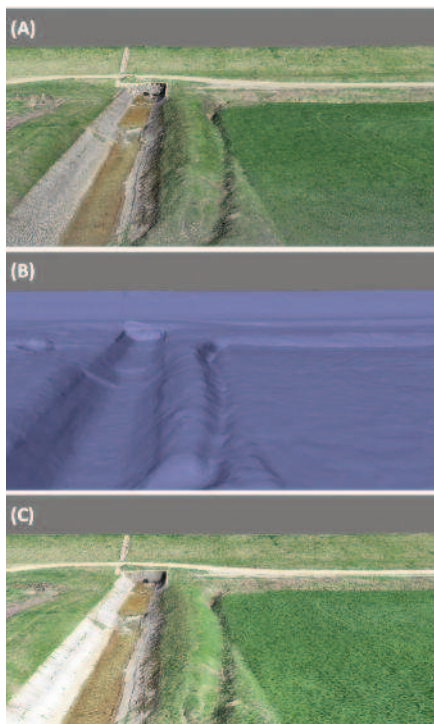

Figure 1. (A) UAS derived 3D dense point cloud, (B) mesh model, and (C) tiled model derived from a UAS based survey of an earthen dam next to the village of Pi chia (Timisoara, Romania). Such data provide the framework for development of high-resolution flood modeling, urban watershed mapping and civil engineering design and map updating [20]

One of the key attributes of UAS systems that sets them apart from other earth-observing platforms is their capacity to act as an interchangeable multi-sensor platform. While simple optical sensors provide a foundation for mapping and monitoring activities, expanding



**Matthew McCabe** is a Professor of Remote Sensing and Water Security and the Associate Director of the Water Desalination and Reuse Center at the King Abdullah University of Science and Technology (KAUST) in Saudi Arabia. Prof. McCabe's research

focuses on issues related to water and food security, climate change impacts, precision agriculture, water resources monitoring and modeling, and the novel use of technologies for enhanced Earth system observation. Improved description and understanding of the water-food nexus is a key objective of his research.



**Salvatore Manfreda** is an Associate Professor of Water Management and Hydrology at the University of Basilicata in Italy. He is Chair of the COST Action Harmonious and Scientific Coordinator of the Flood Forecasting System of the Civil

Protection of the Basilicata Region. He has broad interest in hydrology and ecohydrology, with particular emphasis on distributed modeling, flood prediction, stochastic processes in hydrology, soil moisture process, delineation of flood prone areas, vegetation patterns and UAS monitoring. He is a member of the editorial board of the journal *Ecohydrology* (Winley) and *Hydrology* (MPDI).

these into the multi- and hyper-spectral domain, or exploiting LiDARbased technologies, opens up a range of insights into diverse topics including water quality [13], soil erosion and contamination [14], vegetation health and structure [15, 16], and even near-shore bathymetric measurements [17]. From a hydrologic perspective, it is this multi-sensing capability

that positions UAS as a game-changing tool for driving observational analysis. Through exploiting a single platform, a unique and multi-faceted sensing framework is enabled.

The emergence of these new observational platforms present both opportunities and challenges that will need to be addressed by the broader research community, for their potential is yet to be fully realized. There are a number of international projects or initiatives that have been mobilized to support this task. Among others, two that we are involved in seek to address some of the implementation and adoption issues. The recently funded European Cooperation in Science and Technology (COST) HARMONIOUS "action" (<https://www.costharmonious.eu>) is one such effort to channel competencies, knowledge, and technologies around the application of UAS. In establishing an international network of more than 100 researchers from 32 countries, its purpose is to identify common strategies in environmental monitoring to exploit UAS technologies, including direct applications in the hydrological sciences. The Action is structured around five working groups (WGs) that seek to establish optimal strategies for data processing, monitoring of vegetation, soil water content, river systems and discharge, and the harmonization of these outcomes (and algorithms) across environmental gradients.

Another community effort that is folded within the International Association of Hydrological Sciences (IAHS) Panta Rhei [18] initiative, is the Measurements and Observations in the XXI

century (MOXXI) Working Group (WG), which aims to focus on advancing our monitoring and data analysis capabilities to predict and manage hydrological change [19].

MOXXI promotes new monitoring approaches in order to increase the quality and resolution of hydrological observations by creating a nexus of scientists with a shared interest in sensors and novel observations spanning ground-based measurements to proximal and remote sensing. We are in a golden era of earth observation, with hydrological sciences awash with data. What is lacking are techniques to channel this information deluge into useable content and to drive knowledge advances. Guidance on how to exploit crowd-sourced data, to leverage UAS and satellite platforms, and to interrogate the massive data streams that will continue to be produced are all required. Community efforts that provide structure and strategy to this mission will be central to realizing the potential for technology driven insights in the hydrological sciences. ■

## References

- [1] Manfreda, S., et al., *On the Use of Unmanned Aerial Systems for Environmental Monitoring*, *Remote Sensing*, 2018, **10**(4): p. 641.
- [2] McCabe, M.F., et al., *The future of Earth observation in hydrology*, *Hydrological Earth Syst. Sci.*, 2017, **21**: p. 3879-3914.
- [3] Shiklomanov, A.I., R.B. Lammers, and C.J. Vörösmarty, *Widespread decline in hydrological monitoring threatens Pan-Arctic research*, *Eos*, 2002, **83**(2): p. 13+16-17.
- [4] McCabe, M.F., et al., *CubeSats in Hydrology: Ultrahigh-Resolution Insights Into Vegetation Dynamics and Terrestrial Evaporation*, *Water Resources Research*, 2017, **53**(12): p. 10017-10024.
- [5] Hinkler, J., et al., *Automatic snow cover monitoring at high temporal and spatial resolution, using images taken by a standard digital camera*, *International Journal of Remote Sensing*, 2002, **23**(21): p. 4669-4682.
- [6] Kurihata, H., et al., *Rainy weather recognition from in-vehicle camera images for driver assistance*, in *IEEE Proceedings. Intelligent Vehicles Symposium*, 2005, 2005.
- [7] Dal Sasso, S.F., et al., *Exploring the optimal experimental setup for surface flow velocity measurements using PTV*, *Environmental Monitoring and Assessment*, 2018, **190**(8): p. 460.
- [8] Turner, D., A. Lucieer, and C. Watson, *An automated technique for generating georectified mosaics from ultra-high resolution Unmanned Aerial Vehicle (UAV) imagery, based on Structure from Motion (SfM) point clouds*, *Remote Sensing*, 2012, **4**(5): p. 1392-1410.
- [9] Flener, C., et al., *Seamless Mapping of River Channels at High Resolution Using Mobile LiDAR and UAV-Photography*, *Remote Sensing*, 2013, **5**(12): p. 6382.
- [10] Feng, Q., J. Liu, and J. Gong, *Urban Flood Mapping Based on Unmanned Aerial Vehicle Remote Sensing and Random Forest Classifier—A Case of Yuyao, China*, *Water*, 2015, **7**(4): p. 1437.
- [11] Le Coz, J., et al., *Crowdsourced data for flood hydrology: Feedback from recent citizen science projects in Argentina, France and New Zealand*, *Journal of Hydrology*, 2016, **541**: p. 766-777.
- [12] Tauro, F., A. Petroselli, and E. Arcangeletti, *Assessment of drone-based surface flow observations*, *Hydrological Processes*, 2015, **30**(7): p. 1114-1130.
- [13] Zang, W., et al., *Investigating small-scale water pollution with UAV Remote Sensing Technology*, *World Automation Congress 2012*, Puerto Vallarta, Mexico, 2012, p. 1-4.
- [14] D'Oleire-Oltmanns, S., et al., *Unmanned Aerial Vehicle (UAV) for Monitoring Soil Erosion in Morocco*, *Remote Sensing*, 2012, **4**(11): p. 3390-3416.
- [15] Aasen, H., et al., *Generating 3D hyperspectral information with lightweight UAV snapshot cameras for vegetation monitoring: From camera calibration to quality assurance*, *ISPRS Journal of Photogrammetry and Remote Sensing*, 2015, **108**: p. 245-259.
- [16] Wallace, L., et al., *Assessment of Forest Structure Using Two UAV Techniques: A Comparison of Airborne Laser Scanning and Structure from Motion (SfM) Point Clouds*, *Forests*, 2016, **7**(3): p. 62.
- [17] Matsuba, Y. and S. Sato, *Nearshore bathymetry estimation using UAV Coastal Engineering Journal*, 2018, **60**(1): p. 51-59.
- [18] Montanari, A., et al., *"Panta Rhei—Everything Flows": Change in hydrology and society—The IAHS Scientific Decade 2013-2022*, *Hydrological Sciences Journal*, 2013, **58**(6): p. 1256-1275.
- [19] Tauro, F., et al., *Measurements and Observations in the XXI century (MOXXI): innovation and multi-disciplinarity to sense the hydrological cycle*, *Hydrological Sciences Journal*, 2018, **63**(2): p. 169-196.
- [20] Manfreda, S., et al., *Assessing the Accuracy of Digital Surface Models Derived from Optical Imagery Acquired with Unmanned Aerial Systems*, *Drones*, 2019, **3**(7), 15.

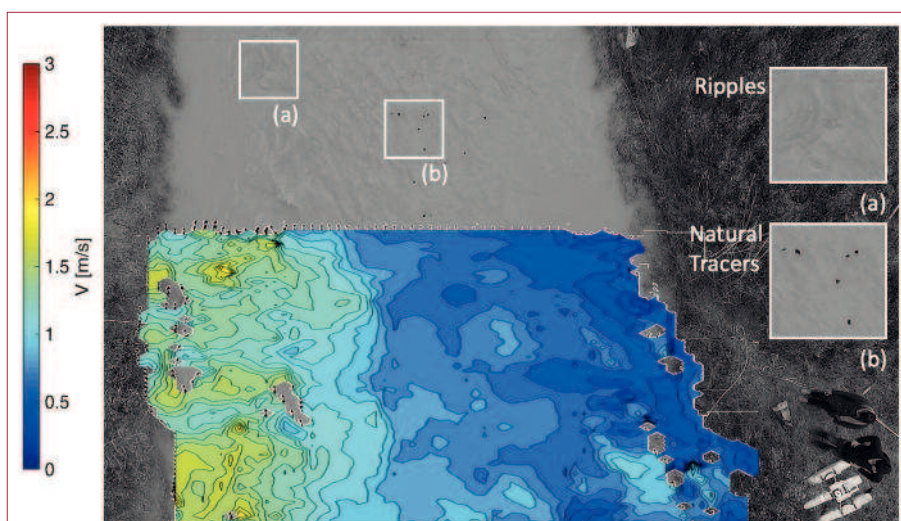

Figure 2. A 2-D flow velocity field derived using an optical camera mounted on a quadcopter hovering over a portion of the Bradano river system in southern Italy. One of the images used for the analysis is shown as a background, where surface features used by flow tracking algorithms are highlighted in the insets (a, b)



# UNMANNED AERIAL SYSTEMS (UAS) FOR MONITORING WATER SURFACE ELEVATION, BATHYMETRY, SURFACE VELOCITY AND DISCHARGE IN STREAMS

BY FILIPPO BANDINI, BEAT LÜTHI & PETER BAUER-GOTTWEIN

To date, hydrometric monitoring (i.e. monitoring of water surface elevation, bathymetry, flow velocity and discharge) of rivers and streams has relied primarily on either in-situ measuring stations or in-situ surveys. In-situ surveys are expensive, require the operator to access the area and cannot be conducted during extreme events, such as floods. State-of-the-art UAS-borne sensors can provide hydrometric observations of streams with high accuracy, high spatial resolution and at a lower cost than in-situ surveys.

“The single water drop never feels responsible for the flood” - Douglas Adams, English author. Floods (and water scarcity) have a large impact on individuals, communities, agriculture and industries; however, data availability from in-situ monitoring stations is declining worldwide for both political and economic reasons <sup>[1], [2]</sup>. Thus, most river networks are gauged at relatively few locations only with low spatial resolution and small streams (less than 100 m wide) may not be gauged at all. Optimization of river maintenance and flood prediction requires cutting-edge sensing technology. Satellite sensing technology is rapidly evolving to improve the observation and prediction of surface water and thus prevent natural disasters. Satellite altimeters have been successful in monitoring water surface elevation in large rivers, but are ineffective for smaller streams due to low spatial resolution. On the other hand, Denmark has established a large and expensive in-situ monitoring and maintenance program of its streams. Denmark has a dense network of rather small streams (ca. 48 000 km of streams are less than 2.5 m wide, 14 500 km are between 2.5 and 8 m, 1 500 km are more than 8 m wide), which are causing floods in agricultural areas resulting in significant property damage and crop yield losses. Conveyance and shape control of the small Danish streams costs approximately 20-30 million euros per year. Vandløbsregulativer (watercourse regulations) prescribe that each municipality is obliged to maintain the river shape or conveyance set by the current regulation. For this reason, 15 000 to 20 000 km of public rivers in Denmark are surveyed with in-situ measurements of bathymetry and discharge every 3-10 years. The majority of these streams are regulated by shape (bathymetry) control, with less than 5%



Figure 1. UAS in action to monitor a Danish stream

regulated by conveyance control (rating curves). These expensive surveys are conducted by human operators and are essential for targeting river maintenance, i.e. river vegetation cutting and riverbed clean-up. Maintenance operations are expensive and detrimental to the river ecological status, but are necessary to avoid floods.

Thus, recurring questions among researchers and practitioners working with Danish streams are “How can we improve the monitoring system for optimizing river maintenance and flood prediction? Can we deploy a technology to retrieve hydraulic observations of inland surface water bodies, whenever and wherever it is required, with (i) high accuracy, (ii) high spatial resolution and (iii) at a reasonable cost?”. Unmanned Aerial Systems (UASs), a new kit in surveyors’ toolbox, have changed our way to “access” and monitor the environment. Indeed, UAS can monitor remote areas delivering real time data. Compared to satellite monitoring, they ensure high spatial resolution, repeatability of the flight missions and good tracking of the water bodies. Compared to manned aircrafts, UASs are low-cost and easy-to-maneuvre platforms that can retrieve observations with higher temporal resolution, potentially including periods of hydrological interest, such as floods and droughts. Figure 1 shows a picture of a UAS flying above a Danish stream to retrieve hydrometric observations. Nevertheless, UASs face several constraints: vibrations, limited size, weight, and electric power available for the sensors and inability to fly in extreme weather conditions.

Several previous studies have used photogrammetry to estimate Water Surface Elevation (WSE), i.e. height of water surface above mean sea level [3]–[6]. However, there are a number of serious limitations: water trans-

parency causes through-water images and the ever-changing features on the water surface, such as ripples or turbulence, complicate identification of homologous points in the bundle adjustment. For this reason, WSE is generally estimated by identifying points on the shoreline, i.e. points at the interface between land and water, which are supposed to be at the same elevation as the nearby water surface away from the shoreline. However, this technique requires the operator to survey Ground Control Points (GCPs) and necessitates high computational time to process images. Furthermore, when the shoreline method is applied, the operator has to identify the shoreline points either manually or through automatic edge detection algorithms, which is highly complicated in densely vegetated rivers. In earlier publications [7]–[9] we presented the first studies on UAS radar altimetry. Studies were conducted to measure water surface elevation in Danish rivers and lakes, and in the famous and unique cenotes and lagoons of the Yucatan peninsula, Mexico. An accuracy of few centimetres and a spatial resolution of few decimetres were achieved. This accuracy and spatial resolution are higher than any other spaceborne radar or airborne LIDAR altimeter. Furthermore, compared to photogrammetry, this technique does not rely on any GCP, and requires a significantly smaller amount of survey time and post-processing computational time (approximately 1/1000 of processing time). Unlike photogrammetry, UAS radar altimetry can also measure WSE in rivers surrounded and overhung by aquatic vegetation and trees. In Figure 2, we show a WSE profile retrieved with our UAS radar altimetry technique of the stretch of a Danish stream.

Surface flow velocity can be estimated with nonintrusive image analysis techniques applied to frames retrieved from the UAS-borne RGB



**Filippo Bandini** is a Postdoctoral researcher at DTU Environment, Technical University of Denmark. His research is currently focused on UAS-borne remote sensing of hydraulic measurements and assimilation of these innovative observations into hydrodynamic models. He is primarily developing, investigating and integrating lightweight and accurate sensors to retrieve water level, speed, and bathymetry measurements from UAS.



**Beat Lüthi** studied Mechanical Engineering at ETH Zürich and graduated at ETH in 2002 in the field of fluid turbulence. Until 2012, Beat Lüthi was leading the hyromechanics group at IfU ETH, specialized in the fields of image based particle tracking velocimetry and turbulence small scale dynamics. In 2012 Beat Lüthi founded the ETH spin off company photrack Ltd. Photrack has developed the now patented technology SSIV to measure surface flow velocities and discharge rates with cameras. For the resulting products DischargeKeeper and the Discharge App there is growing business in Europe, USA, Africa, Central Asia and China.



**Peter Bauer-Gottwein** is professor in hydrology and water resources management at DTU Environment. Research focus areas are hydrological modelling, hydrogeophysics, earth observation for inland water applications and hydroeconomic modelling. Scientific highlights include ground-breaking work on the integration of time-lapse gravity observations with hydrological models; Exploration and modelling of the world’s largest karstic groundwater aquifer on the Yucatán Peninsula, México; Assimilation of satellite radar altimetry observations to hydrologic forecasting systems; Integration of water and power system models for joint resource management. He has significant international experience, including Southern Africa, Mexico, China, Central Asia. He has authored 70+ scientific articles in international journals indexed in ISI Web of Sciences and 4 book chapters.

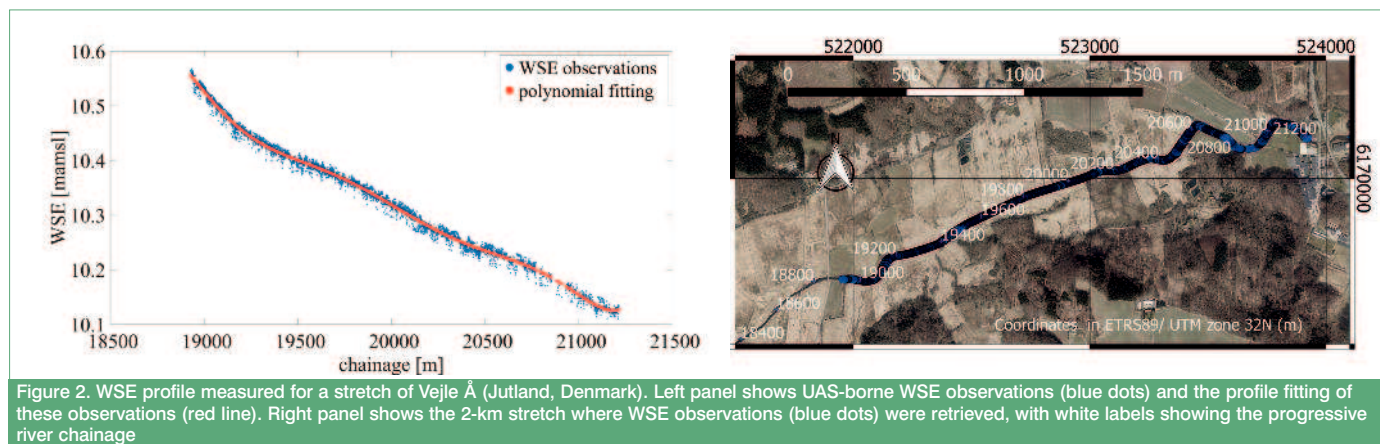

Figure 2. WSE profile measured for a stretch of Vejle Å (Jutland, Denmark). Left panel shows UAS-borne WSE observations (blue dots) and the profile fitting of these observations (red line). Right panel shows the 2-km stretch where WSE observations (blue dots) were retrieved, with white labels showing the progressive river chainage



camera. These image techniques commonly require that tracer particles are on the water surface and that they travel with the same velocity as the surface flow. Surface flow velocities are reconstructed by determining the displacements of the tracer particles (such as leaves, foam, artificial particles) between two subsequent frames. These image analysis techniques are generally differentiated between two categories, based on the Eulerian or Lagrangian specification of the flow field: Particle Image Velocimetry (PIV) [10]-[12] or Particle Tracking Velocimetry (PTV) [13][14], respectively. Surface Structure Image Velocimetry (SSIV) [15], [16] is a special variant of the PIV cross-correlation technique and is aimed at reducing the negative influence on the observations caused by i) glare and shadows on the water surface, and ii) lack of traceable features [17]. Figures 3 and 4 show the SSIV estimation of the surface velocity field and the extracted surface velocity profile in a Danish stream. In this case, no artificial particles were added on the water surface and the algorithm was able to reconstruct the water flow by identifying natural particles such as foam or ripples generated by water turbulence.

Surface velocity observations are essential to highlight flow patterns. Furthermore, surface velocity can also be used to estimate discharge following standard procedures such as the ISO standard EN ISO 748:2007. To do so it is necessary to have also the water depth profile, which can be measured either with an in-situ bathymetric survey, or with UAS-borne bathymetric observations obtained from state-of-the-art bathymetric LIDARs [18] or UAS-tethered sonar [19]. To convert from surface velocity to discharge, we have to adopt assumptions about the vertical velocity profile in the water column. Thus, UAS can supply hydrometric data, such as WSE, bathymetry and discharge, needed to inform hydrodynamic modelling and river management. High spatial-resolution WSE profiles along streams emerge as a new dataset that can help us understand how rivers are affected by vegetation growth and optimize river maintenance, such as vegetation cutting and riverbed clean-up. In our vision, hydrometric UAS-observations are essential not only for small scale management of flood protection/modelling and river restoration, but also to establish a river monitoring UAS-network at regional/national scale. However, this requires that Beyond the Visual Line Of Sight (BVLOS) fully autonomous flights are allowed by the regulators. BVLOS

Figure 3. Water surface velocity field observations in Værebros å (Denmark)

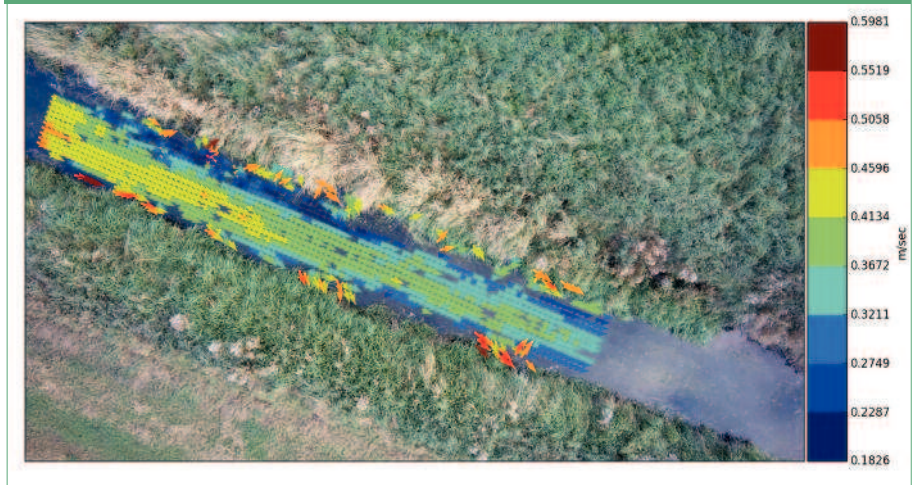

flights will significantly increase UAS potential for hydrometric monitoring, including river maintenance optimization and flood prediction. ■

### References

- [1] F. Tauro, J. Selker, N. Van De Giesen, T. Abrate, R. Uijlenhoet, M. Porfiri, S. Manfreda, K. Caylor, T. Moramarco, J. Benveniste, G. Ciruolo, L. Estes, A. Domeneghetti, M. T. Perks, C. Corbari, E. Rabbiei, G. Ravazzani, H. Bogena, A. Harfouche, L. Broccai, A. Maltese, A. Wickler, A. Tarpanelli, S. Good, J. M. Lopez Alcalá, A. Petroselli, C. Cudennec, T. Blume, R. Hut, and S. Grimaldia, "Measurements and observations in the XXI century (MOXXI): Innovation and multi-disciplinarity to sense the hydrological cycle," *Hydrol. Sci. J.*, vol. 63, no. 2, pp. 169–196, 2018.
- [2] R. Lawford, A. Strauch, D. Toll, B. Fekete, and D. Cripe, "Earth observations for global water security," *Curr. Opin. Environ. Sustain.*, vol. 5, no. 6, pp. 633–643, 2013.
- [3] P. Leduc, P. Ashmore, and D. Sjogren, "Technical note: Stage and water width measurement of a mountain stream using a simple time-lapse camera," *Hydrol. Earth Syst. Sci.*, vol. 22, no. 1, pp. 1–11, 2018.
- [4] E. Ridolfi and P. Manciola, "Water level measurements from drones: A Pilot case study at a dam site," *Water (Switzerland)*, 2018.
- [5] A. S. Woodget, P. E. Carboneau, F. Visser, and I. P. Maddock, "Quantifying submerged fluvial topography using hyperspatial resolution UAS imagery and structure from motion photogrammetry," *Earth Surf. Process. Landforms*, vol. 40, no. 1, pp. 47–64, 2015.
- [6] H. Pai and S. Tyler, "Re-examining data-intensive surface water models with high-resolution topography derived from unmanned aerial system photogrammetry," *Am. Geophys. Union, Fall Meet. 2017, Abstr. #H41D-1463*, 2017.
- [7] F. Bandini, J. Jakobsen, D. Olesen, J. A. Reyna-Gutierrez, and P. Bauer-Gottwein, "Measuring water level in rivers and lakes from lightweight Unmanned Aerial Vehicles," *J. Hydrol.*, vol. 548, pp. 237–250, 2017.
- [8] F. Bandini, M. Butts, T. V. Jacobsen, and P. Bauer-Gottwein, "Water level observations from unmanned aerial vehicles for improving estimates of surface water-groundwater interaction," *Hydrol. Process.*, 2017.
- [9] F. Bandini, A. Lopez-Tamayo, G. Merediz-Alonso, D. Olesen, J. Jakobsen, S. Wang, M. Garcia, and P. Bauer-Gottwein, "Unmanned aerial vehicle observations of water surface elevation and bathymetry in the cenotes and lagoons of the Yucatan Peninsula, Mexico," *Hydrogeol. J.*, pp. 1–16, Apr. 2018.
- [10] F. Tauro, M. Porfiri, and S. Grimaldi, "Surface flow measurements from drones," *J. Hydrol.*, vol. 540, pp. 240–245, 2016.
- [11] F. Tauro, M. Porfiri, and S. Grimaldi, "Orienting the camera and firing lasers to enhance large scale particle image velocimetry for streamflow monitoring," *Water Resour. Res.*, vol. 50, no. 9, pp. 7470–7483, 2014.
- [12] M. Jodeau, A. Hauet, A. Paquier, J. Le Coz, and G. Dramais, "Application and evaluation of LS-PIV technique for the monitoring of river surface velocities in high flow conditions," *Flow Meas. Instrum.*, vol. 19, no. 2, pp. 117–127, 2008.
- [13] F. Tauro, R. Piscopia, and S. Grimaldi, "PTV-Stream: A simplified particle tracking velocimetry framework for stream surface flow monitoring," *Catena*, 2019.
- [14] F. Tauro, R. Piscopia, and S. Grimaldi, "Streamflow Observations From Cameras: Large-Scale Particle Image Velocimetry or Particle Tracking Velocimetry?," *Water Resour. Res.*, 2017.
- [15] B. Lüthi, T. Philippe, and S. Peña-Haro, "Mobile device app for small open-channel flow measurement," in *7th Intl. Congress on Env. Modelling and Software*, 2014, vol. 1, pp. 283–287.
- [16] B. Lüthi, Thomas Philippe, and S. Peña-Haro, "Method and system for determining the velocity of a moving fluid surface," EP Nr: 3 018 483, 2018.
- [17] J. P. Leitão, S. Peña-Haro, B. Lüthi, A. Scheidegger, and M. Moy de Vitry, "Urban overland runoff velocity measurement with consumer-grade surveillance cameras and surface structure image velocimetry," *J. Hydrol.*, 2018.
- [18] G. Mandlbauer, M. Pfennigbauer, M. Wieser, U. Riegl, and N. Pfeifer, "Evaluation Of A Novel Uav-Borne Topo-Bathymetric Laser Profiler," *ISPRS - Int. Arch. Photogramm. Remote Sens. Spat. Inf. Sci.*, vol. XLI-B1, pp. 933–939, Jun. 2016.
- [19] F. Bandini, D. Olesen, J. Jakobsen, C. M. M. Kittel, S. Wang, M. Garcia, and P. Bauer-Gottwein, "Technical note: Bathymetry observations of inland water bodies using a tethered single-beam sonar controlled by an unmanned aerial vehicle," *Hydrol. Earth Syst. Sci.*, vol. 22, no. 8, pp. 4165–4181, Aug. 2018.

Figure 4. UAV-borne surface velocity profile compared to in-situ surface velocity probe measurements, Værebros å (Denmark)

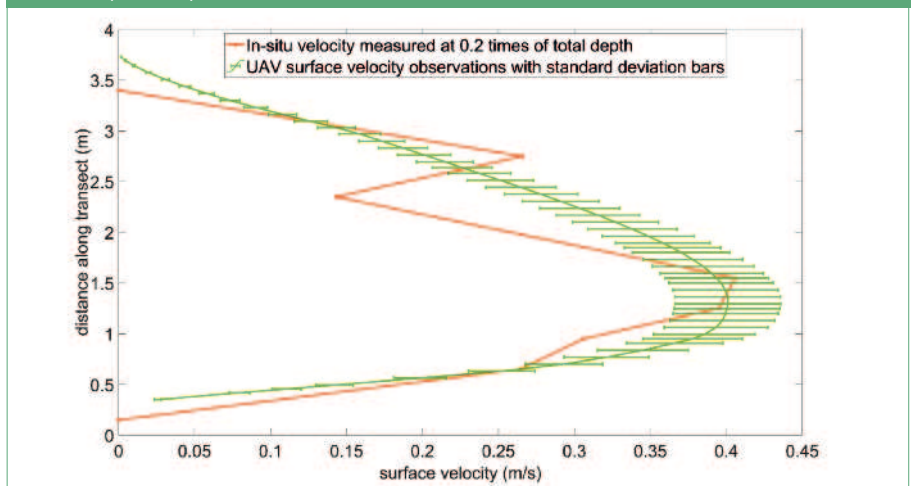

# RIVERS 2.0 – TRANSFORMING RIVERS INTO DIGITAL LANDSCAPES USING UNMANNED AERIAL VEHICLES

BY CHRISTIAN HAAS, PHILIPP THUMSER & JEFFREY A. TUHTAN

Rivers are best viewed from above, and unmanned aerial systems (UAS) provide an excellent means to collect digital imagery and data in challenging environments. UAS are now commonly used in archaeology, geography, mining, and civil engineering. The measurement and mapping of hydrosystems using UASs is both lean and agile, with the added advantage of increased safety for the surveying crew. Here we provide an overview of how UAS can be used to create new sources of digital information, ushering in the age of what we refer to as Rivers, 2.0.

## State of the Art in UAS applications

UAS are especially well-suited for the efficient generation of high-resolution geodata using cameras. The most promising approaches are derived from photogrammetric methods developed for remote sensing of satellite and aerial imagery using the Structure from Motion (SfM) method [11][12]. Advanced image processing methods create cm-accurate SfM geodata on river reaches ranging from 50 m to tens of km [4][11]. The most common types of UAS geodata are precise, high resolution digital elevation models (DEM) and orthomosaics, providing a level of detail previously not possible using satellite and aerial imagery.

UAS river surveys with SfM post-processing can provide reliable data with the added advantage of simple field deployment, and replication of measurements to reduce uncertainty and measurement errors [5]. Once completed, the geodata can be used to generate topographic maps [5][17], estimates of the river bathymetry [20] and sediment and habitat maps [19], investigate morphologic processes, including erosion and deposition [11][14], obtain surface velocity measurements [9][16] and many more.

UAS geodata is also being used increasingly in vegetation studies using multispectral cameras which provide maps of the normalized differenced vegetation index (NDVI) [18]. Key to the success of UAS in river geodata collection is their low cost: excellent results can be obtained from UAS for 5,000 € or less [2]. Due to their simplicity and inexpensive application, UAS surveying techniques now provide the opportunity to map and visualize riverine ecosystems and their changes over time. These new, time-resolved data provide resource managers, firms and researchers with a dynamic view of the river over time and space. Rivers, 2.0 will further

Figure 1. Survey work within National Environment Commission Bhutan project E-Flow at Punatsangchhu river for environmental flow assessment in regard to a future dam for hydroelectric power generation upstream. Manual survey with total station (top left and right) and echosounder (bottom left) in the future dewatered reach of Punatsangchhu I HPP. Use of a low cost UAS (center) in combination with ground reference points to build high resolution digital elevation model of both dry and submerged areas



Figure 2. (a) The position of the drone for each image (crosses) and the ground control points (triangles) overlaid on a digital map of the river section. (b) Dense point cloud of the same reach after processing the aerial imagery. (c) The georeferenced digital elevation model based on the point cloud. (d) The final, high-resolution orthophoto (5 cm/px) mosaic of the reach, showing both the ice jam to the left and an ice cover at different stages of formation [1]

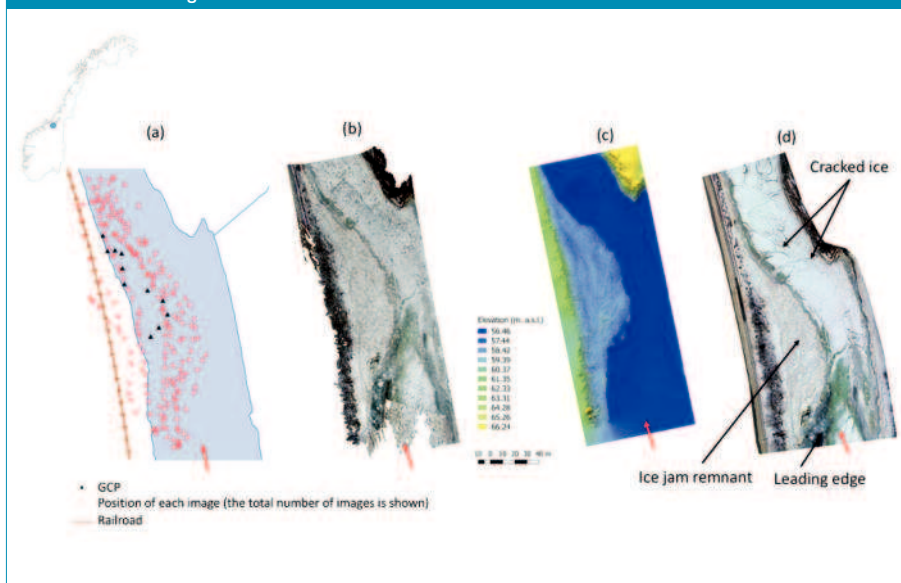



evolve as advanced data processing techniques include existing data with UAS imagery using machine learning, creating new ways and means to study complex natural processes [8]. One of the most fulfilling aspects of UAS imagery and geodata is that it lends itself well to stakeholder involvement, presenting rivers “from above” is often a very effective way to share information and involve non-technical audiences in project planning [7].

Four examples of the use UAS imagery to study river landscapes and systems around the world are presented next.

### Bhutan – Using UAS imagery to establish environmental flows (e-flow) for large hydropower

UAS imagery were processed using SfM to generate high-precision digital elevation models, which served as the basis for 2D hydraulic modelling for e-flow, also referred as residual flow, assessment on planned hydropower development in the Himalayas. Using a low cost UAS (DJI Phantom 3 Professional) reduced the manual survey effort to a minimum and increased the safety for the field crew as only certain areas of the river had to be entered. Spare parts for this system are available almost everywhere even in remote regions such as Bhutan.

### Norway – River Ice Assessment using SfM and UAS

UAS images were used to create the first detailed maps of river ice forming in the Gaula River, Norway. Figure 2 shows the steps in the processing of the collected data. The resulting map includes features which are nearly impossible to collect using traditional ground-based surveying methods, including highly-detailed regions of cracked ice and a clear separation between the newly formed river ice and an older ice jam remnant.

### Thailand – UAS for climate resilience monitoring of ecosystem-based watershed management

This project was part of the climate resilience monitoring of nature-based hydraulic structures and artificial wetlands in a Tha Di river, including flood protection and agricultural uses. It used conventional RGB (red, green and blue) camera images as well as Near Infrared (NIR) imagery to create high-resolution 3D maps of the river and surrounding vegetation. Figure 3 shows the position of the UAS image and the reference ground control points used, and Figure 4 shows

Figure 3. The Results of the 3D NDVI surface model. UAS image positions as well as the reference ground control points are also shown. The final model used a total of 284 multi-spectral (RGB, NIR) images [6]

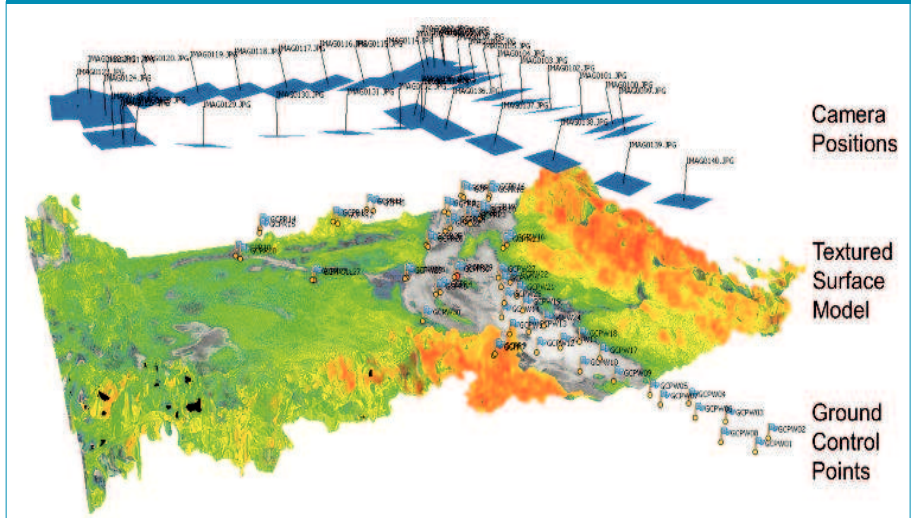

Figure 4. Left: NIR orthoimage of the nature-based living weir (red box) and surrounding vegetation with 5 cm/px resolution. Plants with higher activity are bright red, low activity green, and the river are shown in graduated grayscale [6]

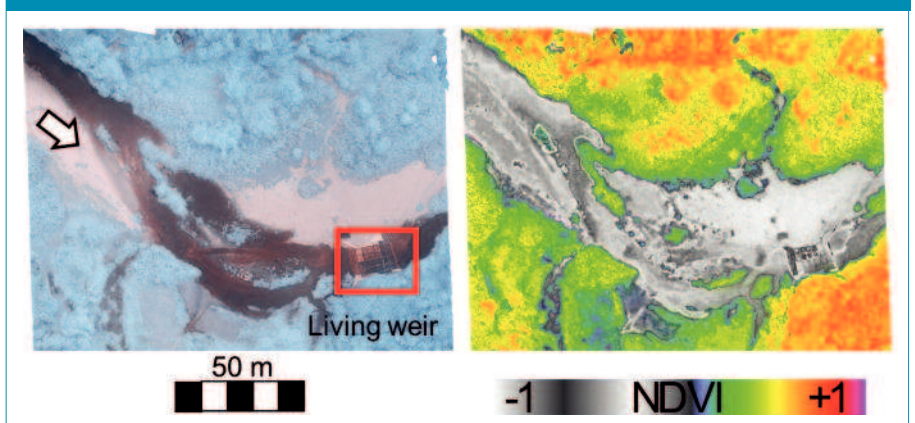
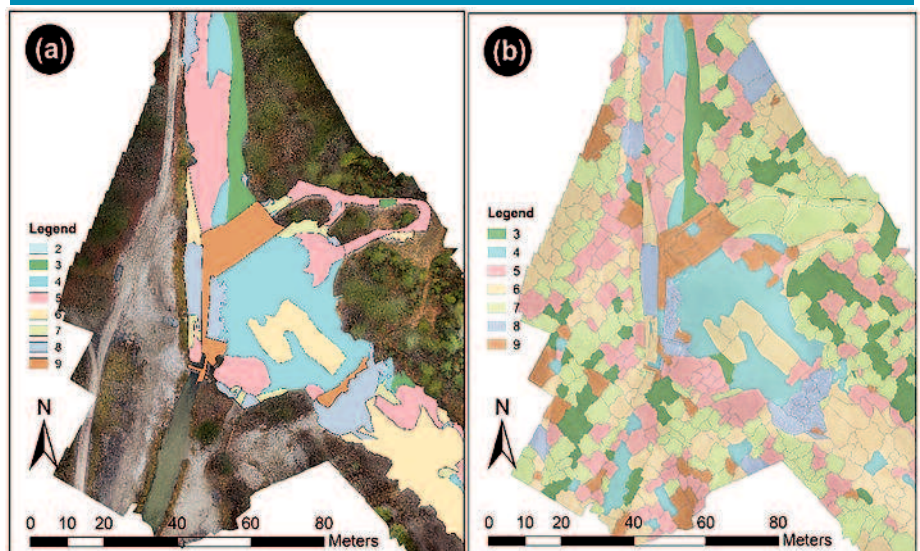

Figure 5. (a) A high-resolution ortho image was used in conjunction with standard terrestrial mapping methods to produce a substrate map. (b) An automated, object-based image classification method produces nearly identical results, with the added advantage of including regions not taken into account using the standard substrate mapping method [10]



the high-resolution vegetation map generated from these images.

### Germany – Automated UAS-based river substrate mapping

Creating accurate maps of the river substrate is a challenging and expensive task because of the difficulty of field work data collection. Areas with a certain dominant substrate size [9] (rock (9), boulders (8), large stones (7), small stones (6), large gravel (5), medium gravel (4), fine gravel (3), sand (2), silt/clay/loam (1), organic material/detritus (0)) are mapped. Inspired by classical satellite remote sensing methods to classify land use, we developed new methods for using high-resolution UAS imagery in a Germany river to automatically classify and map the river substrate. Figure 5 shows side by side the high-resolution ortho image that was used in conjunction with standard terrestrial substrate mapping and the substrate map developed using the same ortho imagery obtained with a drone and an automated, image-based classification method.

### Conclusions and Future Outlook

UAS provide an easy, safe, and cost-effective tool to collect river geodata in the age of Rivers 2.0. The variety of sensors is increasing, and the advent of more advanced data processing methods will continue to expand the use of UAS as low-cost remote sensing tools for river landscapes. We are especially encouraged by the latest results using machine learning algorithms in conjunction with the widespread availability of GPU image processors. Current UAS geodata include high-resolution point clouds, multispectral orthoimagery and digital elevation models. These data are not the final products; they can be processed to generate additional data products, such as NDVI maps to

### Funding Note

The work reported in this article supported by funding from the European Union's Horizon 2020 research and innovation programme under grant agreement No 727830, <http://www.fithydro.eu/>. JAT contribution has been funded in part by the Sihtasutus Eesti Teadusagentuur (ETAg), <https://www.etis.ee/>, Estonia, through the projects "Bioinspired Ecohydraulic Sensor Array for Laboratory and Insitu Flow Measurements" (grant agreement No PUT1690) and "Octavo" (grant agreement No B53). The funders had no role in study design, data collection and analysis, decision to publish, or preparation of the manuscript.

study vegetation, or maps documenting ground surface changes to study erosion and sedimentation. One limitation of many UAS is the use of ground control points (GCP) to correct for positioning errors during data collection. However, the use of high precision GNSS (Global Navigation Satellite System) in other fields such as self-driving cars has led to a massive decrease in the cost of GNSS receivers. Currently, consumer-grade UAS with cm-precision geopositioning can be purchased for around 5.000 €. This represents a tenfold reduction in the cost of such systems over the last five years. We believe that the use of UAS for river geodata collection has not yet reached its peak, and that affordable precision-GNSS will usher in another expansion phase of this field. The River 2.0 paradigm involves the transition from static, low-resolution geodata to the development and use of dynamic, high-spatial and temporal resolution geospatial data. Costs for large, time-resolved datasets are forecasted to decrease, and the simple deployment of UAS will lead them to becoming a standard surveying tool. Indeed, we believe that the coming years will see the transition from low to high resolution, and the change from annual, static data representations to seasonal or monthly dynamic maps; we call this transition "orthomotion". The evolution of UAS technology has already made its mark on river measurements and mapping, by making field work more accurate, less expensive, faster and less dangerous. Welcome to the age of Rivers, 2.0. ■

### References

- [1] Alfredsen, K., Haas, C., Tuhtan, J. A., Zinke, P., 2017. Brief Communication: Mapping river ice using drones and structure from motion. *The Cryosphere*.
- [2] Colomina, I., Molina, P., 2014. Unmanned aerial systems for photogrammetry and remote sensing: A review. *ISPRS Journal of Photogrammetry and Remote Sensing* 92, 79–97. doi:10.1016/j.isprsjprs.2014.02.013
- [3] Deter, M., Weitbrecht, V., 2015. A low-cost airborne velocimetry system: proof of concept. *Journal of Hydraulic Research* 0, 1–8. doi:10.1080/00221686.2015.1054322
- [4] Eisenbeiss, H., Zhang, L., 2006. Comparison of DSMs generated from mini UAS imagery and terrestrial laser scanner in a cultural heritage application. *International Archives of Photogrammetry, Remote Sensing and Spatial Information Sciences XXXVI-5*, 90e96.
- [5] Fonstad, M.A., Dietrich, J.T., Courville, B.C., Jensen, J.L., Carbonneau, P.E., 2013. Topographic structure from motion: a new development in photogrammetric measurement. *Earth Surf. Process. 04 Landforms* 38, 421–430. doi:10.1002/esp.3366
- [6] Haas, C., Thumser, P., Tuhtan, J.A., Thongkao, S., Treitler, R., 2016. UAS based monitoring of a living weir in Thailand. Presented at the 11th International Symposium on Ecohydraulics, Melbourne.
- [7] Ling, M., Chen, J., 2014. Environmental visualization: applications to site characterization, remedial programs, and litigation support. *Environ Earth Sci* 72, 3839–3846. doi:10.1007/s12665-014-3220-y
- [8] Rink, K., Scheuermann, G., Kolditz, O., 2014. Visualisation in environmental sciences. *Environ Earth Sci* 72, 3749–3751. doi:10.1007/s12665-014-3759-7
- [9] Schneider, M., Noack, M., Gebler, T., Kopecki, I., 2010. Handbook for the Habitat Simulation Model CASIMIR. [http://www.casimir-software.de/data/CASIMIR\\_Fish\\_Handb\\_EN\\_2010\\_10.pdf](http://www.casimir-software.de/data/CASIMIR_Fish_Handb_EN_2010_10.pdf)
- [10] Shafi, M., 2016. An Investigation on Image Processing Techniques for Substrate Classification Based on Dominant Grain Size on RGB Images from UAS.
- [11] Smith, M.W., Vericat, D., 2015. From experimental plots to experimental landscapes: topography, erosion and deposition in sub-humid badlands from Structure-from-Motion photogrammetry. *Earth Surf. Process. Landforms* 40, 1656–1671. doi:10.1002/esp.3747
- [12] Snaveley, N., Seitz, S.M., Szelski, R., 2007. Modeling the World from Internet Photo Collections. *Int J Comput Vis* 80, 189–210. doi:10.1007/s11263-007-0107-3
- [13] Snaveley, N., Seitz, S.M., Szelski, R., 2006. Photo tourism: exploring photo collections in 3D. in: *ACM Transactions on Graphics (TOG)*, ACM, pp. 835–846.
- [14] Tamminga, A.D., Eaton, B.C., Hugenholz, C.H., 2015. UAS-based remote sensing of fluvial change following an extreme flood event. *Earth Surf. Process. Landforms* 40, 1464–1476. doi:10.1002/esp.3728
- [15] Tamminga, A., Hugenholz, C., Eaton, B., Lapointe, M., 2015. Hyperspatial Remote Sensing of Channel Reach Morphology and Hydraulic Fish Habitat Using an Unmanned Aerial Vehicle (UAS): A First Assessment in the Context of River Research and Management. *River Res. Applic.* 31, 379–391. doi:10.1002/rra.2743
- [16] Thumser, P., Haas, C., Tuhtan, J.A., Fuentes-Pérez, J., Toming, G., 2016. RAPTOR-UAS: Real-Time Particle Tracking in Rivers using an Unmanned Aerial Vehicle. *Earth Surface Processes and Landforms*, July 2017. *Earth Surface Processes and Landforms* 42(14). DOI: 10.1002/esp.4199
- [17] Thumser, P., Haas, C., Tuhtan, J.A., Schneider, M., 2015. HYDRONES: Hydrosystem Drone Surveying. E - proceedings of the 36th IAHR World Congress 28 June – 3 July, 2015, The Hague, the Netherlands.
- [18] Whitehead, K., Hugenholz, C.H., Myshak, S., Brown, O., LeClair, A., Tamminga, A., Barclyn, T.E., Moorman, B., Eaton, B., 2014. Remote sensing of the environment with small unmanned aircraft systems (UAS), part 2: scientific and commercial applications. *J. Unmanned Veh. Sys.* 02, 86–102. doi:10.1139/juvs-2014-0007
- [19] Woodget, A., 2015. Quantifying physical river habitat parameters using hyperspatial resolution UAS imagery and SIM-photogrammetry (Doctoral Thesis). University of Worcester.
- [20] Woodget, A.S., Carbonneau, P.E., Visser, F., Maddock, I.P., 2015. Quantifying submerged fluvial topography using hyperspatial resolution UAS imagery and structure from motion photogrammetry. *Earth Surf. Process. Landforms* 40, 47–64. doi:10.1002/esp.3613



**Christian Haas** is managing director and partner of I AM HYDRO - Investigation And Monitoring of HYDROsystems. Focus of the company is to supply better data and to improve understanding of environmental processes. Christian is survey expert and specialized on the use of UAS for hydro-environmental applications. Together with his co-authors he is working since 2013 on development and improvement of UAS based data collection and post processing methods. He joined the IAHR student chapter Stuttgart in 2009 and was member of the board 2010- 2011.



**Philipp Thumser** is managing director and partner of I AM HYDRO - Investigation And Monitoring of HYDROsystems. Focus of the company is to supply better data and to improve understanding of environmental processes. Philipp lead and participated in projects regarding survey work and monitoring at more than 50 rivers worldwide, including rivers in Africa, Asia and Europe.



**Jeffrey A. Tuhtan** leads the Environmental Sensing and Intelligence group at the Centre for Biorobotics, Dept. of Computer Systems at the Tallinn University of Technology. The group's research focus is Measurement and Computing in Natural Science, Engineering and Medicine using principles taken from Biology, Fluid Dynamics and Remote Sensing. Current academic research includes two H2020 projects FITHydro and LAKsMI (Sensors for LARge scale HydrodynaMIC Imaging of ocean floor), as well as the base financing grant B53 Octavo, and PUT 1690 Bioinspired flow sensing. He has been a member of IAHR since 2005.



# TO DRONE OR NOT TO DRONE? EXPERIMENTING THE USE OF UAV FOR FLOOD MODELLING IN DATA-SCARCE REGIONS

BY PAOLO PARON, MAURIZIO MAZZOLENI, ANDREA REALI & LUGIA BRANDIMARTE

## Background and problem setting

Floodplains are among the most valuable ecosystems for providing goods and services to the environment and supporting biodiversity<sup>[1]</sup>. At the same time, people tend to settle in floodplains as they offer favorable conditions for agriculture, trade and economic development<sup>[2]</sup>. This has been the case since the earliest recorded civilizations, such as those in Mesopotamia and Egypt that developed in the fertile riparian areas of the Tigris and Euphrates and Nile rivers. It is estimated that almost one billion people, the majority of them the world's poorest inhabitants, currently live in floodplains<sup>[3]</sup>. As a result, flooding is nowadays one of the most damaging natural hazards<sup>[4]</sup> and causes about half of all deaths from climate-related disasters<sup>[5]</sup>.

Given the relevance of floodplain studies, many flood inundation models have been presented by ecologists, geomorphologists, hydraulic engineers and hydrologists over the past decades<sup>[6]</sup>. They range in complexity from simply intersecting a plane representing the water surface with digital elevation models<sup>[7],[8]</sup> to sophisticated numerical solutions of the Navier–Stokes equations<sup>[9]</sup>. These models have been proved to be valuable tools in understanding flood propagation while supporting sustainable floodplain management and flood risk reduction<sup>[10]</sup>.

Yet, most African floodplains did not benefit from this scientific progress in hydrological and hydraulic modeling of floods, as the necessary information (input and calibration data) is often missing or incomplete. In particular, there is a lack of topographic data, key input of flood inundation models, as well as flood extent maps, crucial to calibrate and test models. While satellite data can help getting this information for larger river systems and large-scale studies, their spatial and temporal resolution (or cost in case of higher resolution) is not appropriate for small to medium river systems and local scale studies. Flooding processes in Africa also have higher impact in modifying the topography of floodplains than elsewhere, since there are fewer structural flood protection measures in place and much less regulation in the way these floodplains are occupied by human activities. Recently, the necessity to counterbalance time-consuming traditional topographic survey techniques in inaccessible areas generated a strong interest in building on remote sensing techniques and data, and eventually led to the birth of Fluvial Remote Sensing (FRS) as a sub-discipline<sup>[11]</sup>. However, the freely accessible data have limited use for hydraulic risk analyses in small to medium scale areas due to their coarse resolution. On the other hand, the high accuracy laser sensing topography is often too expensive, due to the need of small planes or helicopters to carry the LiDAR equipment, which

does not always justify its use and is rarely available in low income countries.

At the same time, the Unmanned Aerial Systems (UAS) or drone industry has seen a huge development in the last few years and has now become mature enough to enter the surveying business. Both hardware and software have made very large progresses in few years' time, allowing people with little surveying experience to be able to generate highly accurate Digital Elevation Models at low cost. Moreover, the safety of operating drones has dramatically increased thanks to the development of user friendly application software (apps) and on-board navigation hardware (obstacle avoidance systems) used to control these devices.

For these reasons, we decided to experiment the acquisition of DEM for hydraulic modelling by means of a commercial UAS and compare different DEMs over the same area to assess the advantage of using drones on a systematic scale for flood modelling purposes. A growing number of research and application papers have been published in the last years. For example, Zinke et al.<sup>[12]</sup> obtained underwater bathymetry data in a Norwegian river from UAV imagery using an algorithm developed for coastal bathymetry modelling; Perks et al.<sup>[13]</sup> flew a UAV during a flood event of the Alyth Burn in Scotland to capture real-time videos and, with an application of the Kande–Lucas–Tomasi (KLT) algorithm, estimate the free surface velocity by tracking the movement of objects in the water; Leitao et al.<sup>[14]</sup> used a drone-based DEM for urban surface flow modelling to be potentially connected to a drainage modelling of a Swiss town; while Mourato et al.<sup>[15]</sup> developed a Digital Surface Runoff Model (DSRM) from UAV imagery for flood hazard mapping.

## Objective of the research and study area

The main goal of our exercise was to compare the accuracy of Shuttle Radar Topography Mission (SRTM) vs LiDAR vs drone derived DEMs for use as input data in a 1D hydraulic model of a tropical river in Mozambique, the lower Limpopo River.

Figure 1. The trans-boundary Limpopo River Basin and the study area highlighted in red in the Lower Limpopo. (Background image from [http://www.limpopo.riverawarenesskit.org/LIMPOP\\_ORAK\\_COM/INDEX.HTM](http://www.limpopo.riverawarenesskit.org/LIMPOP_ORAK_COM/INDEX.HTM))





**Maurizio Mazzoleni** was born in Brescia, Italy. He is an environmental engineering specialised in flood risk analysis and reduction. He graduated from University of Brescia, Italy, in May 2011. Between July 2011 and 2012 he worked within the KULTURisk Project as research fellow at the University of Brescia. Afterwards, he joined IHE Delft as PhD fellow under the FP7 Project WeSenseIt. In 2016 he successfully defended his PhD thesis on the assimilation of crowdsourced observations in hydrological and hydraulic models. After his PhD, he worked as Junior Lecturer at IHE Delft for the BPutra and H2020 GroundTruth 2.0 Project. Currently, he is involved in the "HydroSocialExtremes: Unravelling the mutual shaping of hydrological extremes and society (2018-2023)" with the objective of explore and model the dynamics and risks generated by feedback mechanisms between physical, technical and social processes.  
<http://katalog.uu.se/profile/?id=N18-1680>



**Luigia Brandimarte** is an Associate Professor in Hydraulic Engineering at Royal institute of Technology in Stockholm, Sweden. She holds a PhD from Politecnico di Milano, Italy, in hydraulic engineering. Her main research interests are: dynamics of water and society; flood risk management; scour at hydraulic structures.  
<https://www.kth.se/profile/luigiab>



**Paolo Paron** is a Senior Lecturer in Earth Science and Remote Sensing at IHE Delft since 2011. He holds a PhD in Earth Science from the University of Chieti, Italy. He has 15+ years of professional experience working in the Academic, Humanitarian (United Nations & INGOs), and Private Sectors, mainly in developing countries. He was visiting associate at the universities of Oxford (UK) and Darwin (Australia), researching on mapping and remote sensing in geomorphology and environmental change in the Tropics. His present research interest is in the application of innovative and low/cost methods and tools for monitoring of water and environmental parameters in data scarce regions. He is also researching in the field of sustainable development practices for adaptation to global changes.  
<https://www.un-ihe.org/paolo-paron>



**Andrea Reali** graduated in Civil Engineering at the Royal institute of Technology in Stockholm, Sweden in August 2018. He is now working as Construction Engineer at Saipem. His field of expertise are: hydraulic modelling, structural engineering.

The study area is a stretch of 30 Km along the Lower Limpopo River between an irrigation work upstream, and a road bridge downstream (Figure 1). The nearest gauging stations are about 1 km upstream and about 100 m downstream of the study area, with no tributaries in this stretch of river. In our study area, an aerial borne LiDAR dataset acquired during the month of February 2017 (under extreme dry conditions) was available and was used as a benchmark for comparing both the SRTM (of February 2001) and the Drone derived DEM in January 2018.

**Drone survey and DEM production**

The drone campaign was carried out in January 2018 under extreme hot weather conditions with air temperature above 40 degrees in few days. We did not use any Ground Control Point (GCP)

due to issues with the equipment. We have used two drones (at the same time), a Phantom 4 Pro (P4Pro) and a Phantom 4 Advanced (P4Adv). They carry the same camera on-board which is summarized in the specs available online at <https://www.dji.com/nl/phantom-4-pro/info>

We designed and performed the flight plans using the app DroneDeploy[16], which is very versatile, allowing for designing of the flying areas in Google Earth and then importing them in DroneDeploy for further adjustment based on the flying parameters. Moreover, this app allows to work on both desktop/laptop and tablets using either iOS or Window or Android operating systems.

Different tablets were used during our surveying: for the P4Pro drone we used an iPad Air 2, while for the P4Adv an Android tablet (a Huawei

Media pad M3). We experienced a series of problems with the Android-based tablet such as loss of video communication, flight plans not initiated, image capture not starting, image not been displayed on the tablet and other similar problems. This has been a known issue with Android-based tablets for some time, and the users forum<sup>[17]</sup> offer plenty of examples. The iPad equipped drone, on the contrary, did not show major issues apart from the ones related to high temperatures during the flights, which in few occasions grounded the drone.

The survey was designed to collect transects perpendicular to the main river channel, starting from one end of the floodplain, continuing over the river banks and flying over the (almost) dry river bed, and ending in the opposite floodplain. This way, we focused on defining the morphology and elevation of the river bed and of the river banks with the goal of calculating the volumes of bank full waters.

A total of 13 flight plans of different extent were carried out (see Figure 2a). The selection of the locations was done according to the homogeneity of the river bank and river bed morphology, and considering the logistics of field work and a limited amount of time available for the survey.

The flight lines' directions were kept almost always perpendicular to the river bed to have a consistent direction of flight with respect to the natural features that we wanted to capture and model. An example of the flight plan of the most upstream one area, including the Macarretane weir is shown in Figure 2b.

Because of the flat topography, we opted for a flight plan with 75% of frontlap and 65% of sidelap between consecutive images. This allowed for the same objects to be captured by at least 3 images and observed by three

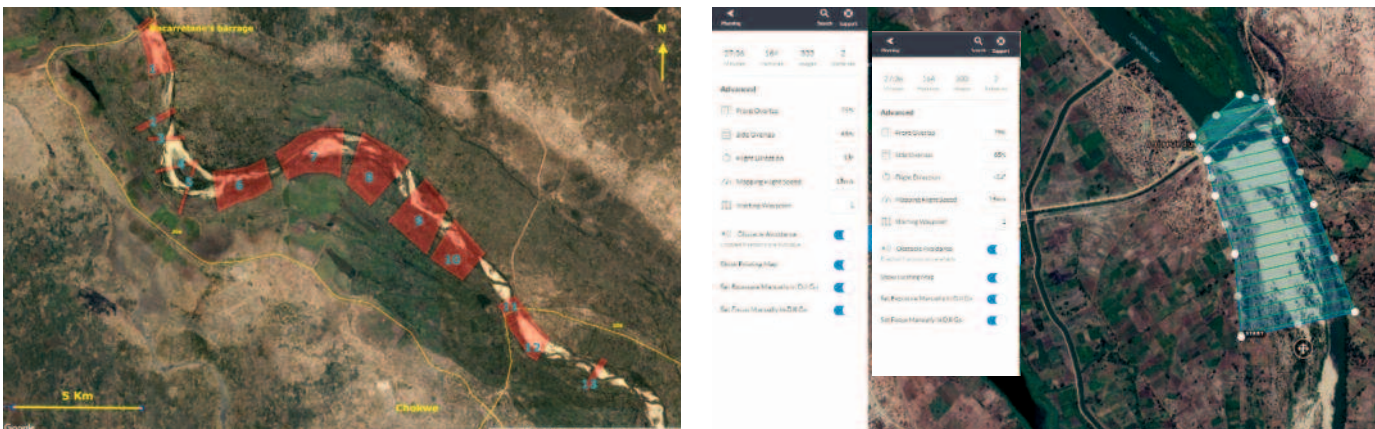

FIGURE 2. (A, left) Flying areas (red shaded areas) distributed in the study area. (B, right) Example of a flight plan with flight details on the left hand-side panel



different angles. Using this geometry of the flight plan we could then input our images in a Structure from Motion software (Agisoft Photoscan Pro version 1.3) that would generate the orthomosaic and Digital Elevation Model (DEM) of each flight plan. During the survey we were not able to use any Ground Control Point (GCP) so we relied only and exclusively on the onboard GPS.

The topography of this area is quite flat with the major topographic variations being the banks and river bed. Because of the 3 years of ongoing drought in the area, we were able to capture the dry river bed in some sections, thus providing very useful information for the 1D flood model. However, the environmental conditions were not very favorable due to very high temperatures, exceeding 40 degrees, and very strong winds, and posed different challenges. The high winds prevented the drones from taking off safely; the high temperatures affected both the Tablet (which did not work at a temperature of 40 degrees), the onboard instrumentation, and the compass and onboard GPS signal.

The post processing phase followed a standard Structure from Motion (SfM) workflow. As mentioned above, one hindering factor was the inability to use Differential or Real Time Kinematic (RTK) GPS to add Ground Control Points (GCP) to the dataset.

As suggested by the SfM procedure using Agisoft Photoscan Pro version 1.3 we followed these steps: 1) Aligned the photos, thus building a preliminary sparse point cloud that, for each overlapping photo, identifies homologous pixel in all the photos. During this phase the software also performed bundle adjustments and precise geolocation; 2) Densified this sparse point cloud, increasing the number of homologous pixels identified during the first step. If allowed in this phase, the software can also generate a point classification based on their color. Normally this step works well in highly contrasting environments where the pixels show highly contrasting colors; 3) Generated a Triangular Irregular Network based on millions of points from the previous steps. This was a very important step because it formed the basis for the generation of the DEM that was the focus of our study; 4) After generating the Dense Point Cloud and the Mesh, the software created the orthomosaic and exported the desired outputs (DEM and Orthophoto), 5) finally, we were able to extract river cross sections at particular locations using the estimated orthomosaic.

**Figure 3.** Comparison of the raw drone topography (dark blue line) with the corrected one (light blue line) and with the reference LIDAR (red line). The spike on the left-hand side is due to the reflections of the water body in the river active channel, and it was smoothed out before processing in the 1D flood model

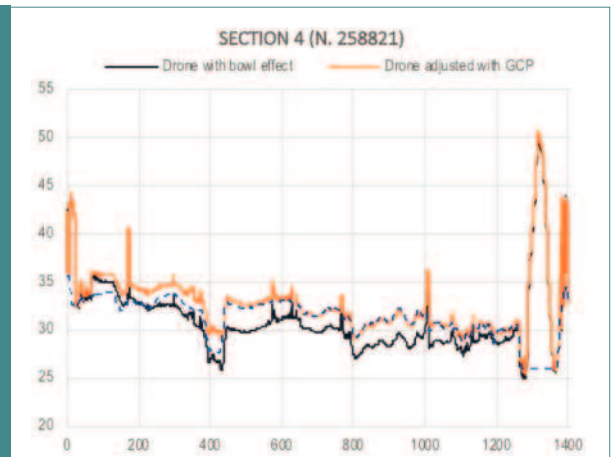

### Results: comparing topography from different sources

The processing of drone data without GCP resulted in the use of only drone GPS coordinates. These were not accurate enough to generate geometrically correct topographies. In particular, we faced the known problem of dome (or bowl) effect. The DEM showed a fake convex shape at the center (Figure 3).

However, we used the LiDAR and associate orthophotography to generate virtual GCPs that allowed us to rectify the dome effect of the drone data (Figure 4).

This way it was possible to obtain a geometrically corrected DEM from the drone photos. From Figure 4 it can be seen how the drone results are in good agreement with the LiDAR

*Continues in page 21*

**Table 1.** Details of drone, LIDAR and SRTM DEMs

|                                 | Drone  | LIDAR   | SRTM                          |
|---------------------------------|--|---|-------------------------------|
| Date of acquisition             | Jan 2017   | Mar 2015  | Feb 2000                      |
| Method used to generate the DEM | Structure from Motion                                    | Return time of the Laser impulses                             | Radar                         |
| Spatial resolution              | 6 cm (orthophoto)<br>- 25 cm (DEM)                       | 1 m   | 30 m                          |
| Extent                          | 30 km stretch, in small transects                        | The whole Limpopo River Floodplain                            | From +80° North to -80° South |
| Cost (order of magnitude)       | 10 <sup>3</sup> USD                                      | 10 <sup>6</sup> USD   | free                          |
| Repeatability                   | As desired, operated by national staff, at very low cost | As desired, operated by specialized firms, at very high costs | One-off                       |

**Figure 4.** DEM (left) and orthophoto (right) of the Macarretane area after correction using the GCP derived from LiDAR data to remove the dome or bowl effect

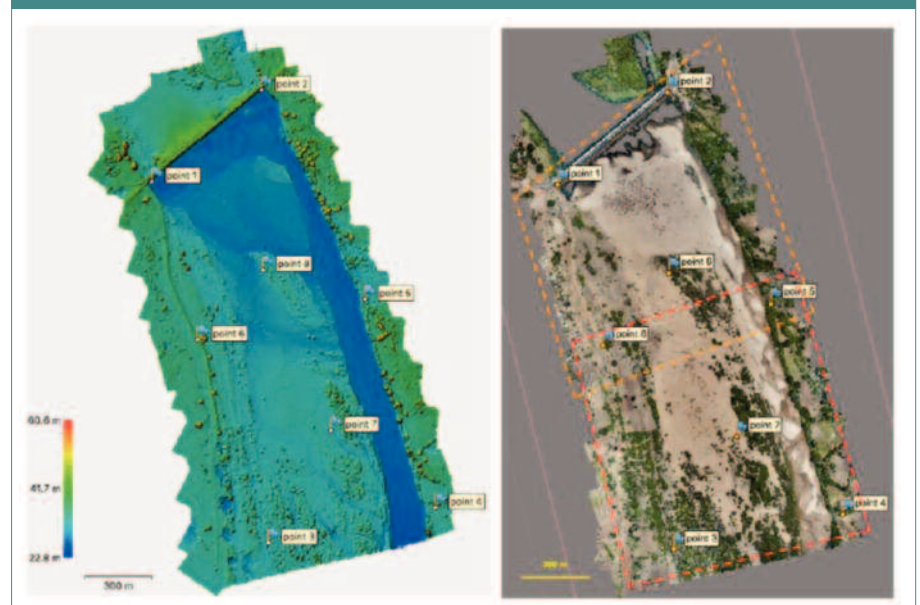

# IMPACT OF UAV PHOTOGRAMMETRY ON THE FLOOD SIMULATION PROCESS OF BRIDGES IN MOUNTAIN REGIONS

BY JÜRGEN HACKL & BRYAN T. ADEY

Hydraulic risk assessment of bridges in mountain regions is an essential task because a bridge failure could have serious social-economic consequences, especially if it renders an area inaccessible. Nowadays, UAVs could provide a fast and cost-effective way to obtain the information with the high temporal and spatial resolution required for such a risk assessment.

A risk assessment related to bridges in a mountainous region poses several challenges. The probability of occurrence of bridge failures due to hydraulic events (e.g. flood, scour, debris) and the resulting consequences depend significantly on the physical characteristics (e.g. slope, soil, vegetation, precipitation) of the specific regions where the bridges are located. An indication of the effects of these characteristics can be seen in the sediment deposition during floods in mountain catchments [1]. Additionally, there is often no recent topographical information that can be used to develop terrain models needed to generate realistic water flow simulations in mountainous regions. Furthermore, most hydrology and hydraulic models have been developed for lower gradient rivers and often cannot be used directly to model water flow in Mountain Rivers [2].

In an effort to improve the assessment of hydraulic risk related to bridges in mountainous regions, an investigation was undertaken by Hackl et al. [3], to determine whether Unmanned Aerial Vehicles (UAVs) and photogrammetry could be used to generate the topographical information required to run realistic water flow simulations.

The investigated bridge is located in Val da Riein, in the sub-mountainous region of Surselva, a district of Grisons, the largest and easternmost Canton of Switzerland. It is part of the cantonal road network, connecting the towns of Ilanz and Vals (Fig. 1). The bridge is located in the only major road leading to Vals. Consequently, there would be significant economic consequences for the residents of Vals, if this bridge could not be used. The bridge crosses the Riein Creek where it joins the River Glogn. The bridge, built in 1987, is a single span bridge with reinforced concrete (Fig. 2a). It has a span width of 24 m, the bridge deck is 7.97 m wide, and the clearance between the bridge and the water surface is approximately 5.8 m. The abutments were partially protected against scouring with rip-rap (Fig. 2b). The original protection measures were damaged during a flood event in July 2011. This damage has also allowed some erosion of the embankments to occur, as documented in Fig. 2c.

The steps applied to test the use of an UAV and modern photogrammetric technology to obtain and verify the accuracy of the topographical information to improve bridge risk assessment were: (1) mission planning and preparation, (2)

in-situ data acquisition, (3) data processing and the generation of a 3D digital terrain model, (4) processing of the 3D terrain model, (5) hydrodynamic modeling and simulations, and (6) post-processing and verification of the results. An overview of the whole process is provided in Fig. 3.

Figure 2. Details of the bridge. (a) Technical drawing with dimensions. (b) Picture of intact rip-rap taken before 2011 (reprinted from TBA GR [5], with permission from Kristian Schellenberg). (c) Picture of damaged rip-rap taken in July 2016. Photograph: Clemens Kielhauser.

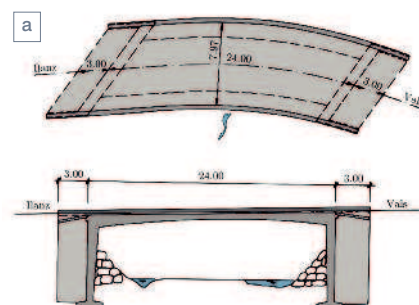

Figure 1. Location of the bridge and the catchment areas of the rivers (map data (c) 2017 swisstopo JD100042).

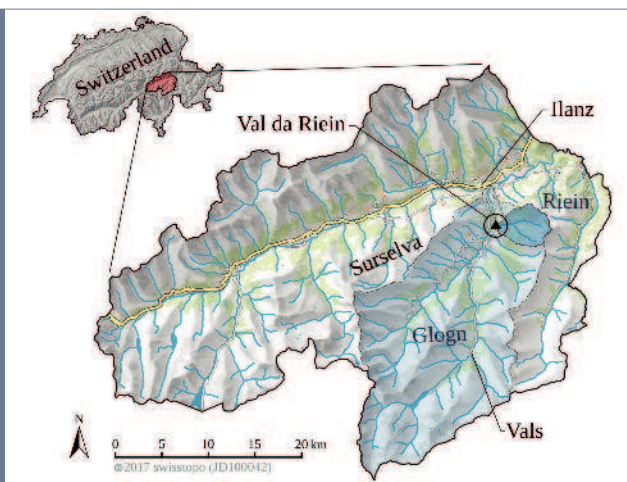
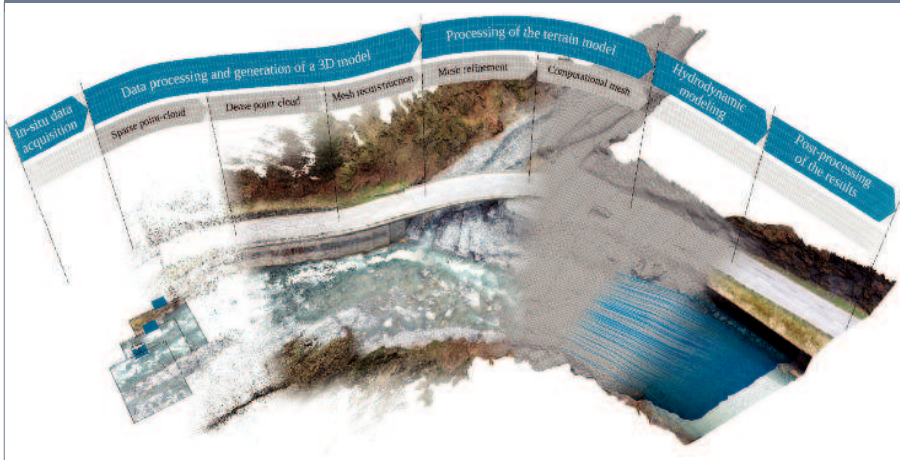



Figure 3. Process from left to right: (1) mission planning and preparation, (2) in-situ data acquisition, (3) data processing and the generation of a 3D model, including sparse point-cloud, dense point-cloud and mesh reconstruction, (4) processing of the terrain model, including mesh refinement, and creation of a computational mesh, (5) hydrodynamic modeling and simulation, and (6) post-processing of the results.



(1) Supporting information about the area and the bridge was gathered in advance. The area covered was approximately 125 x 200 m, considering a length of 100 m upstream of the Creek Riein. To reduce the measurement errors, 26 reference targets (Ground Control Points or GCP) were positioned on the river banks, the dry riverbed and the bridge. No flight permission was needed, according to Swiss regulations [4]. For safety reasons it was decided that two people operate the UAV, a pilot and a camera operator.

(2) The UAV platform DJI Inspire 1 (quadcopter) from DJI Innovations (Shenzhen, China) was used for image acquisition. This is a commercial off-the-shelf solution, which comes fully assembled and equipped. On the UAV platform, a calibrated 12.4-megapixel Zenmuse X3 camera was mounted via a 3-axial gimbal, operated independently with a second remote. During three flights of approximately seven minutes each, a total of 1621 images with an overlap of at least 90% were taken.

(3) To obtain a 3D digital terrain model, 2D-image information was processed using Structure from Motion (SfM) photogrammetric algorithms and computer vision. To calculate 3D models from a large number of images, the following process was used: (a) image pre-processing (e.g. filtering out blurred images), (b) camera calibration, (c) sparse point-cloud reconstruction, (d) dense point-cloud reconstruction, (e) mesh reconstruction, (f) mesh refinement, (g) mesh texturing, and (h) accuracy assessment. In order to achieve this, three open-source software solutions were used. OpenCV was used in step (b), openMVG in step (c) and openMVS for step (d) through (g) (see Tab. 1). The computations were done on a 4x10 Core Intel Xenon E5-2690v2 3.0Ghz, 384GB DDR2 server, running on Linux 64bit operating system (Ubuntu 14.04).

(4) For the creation of a computational mesh which was used in the computational fluid dynamics (CFD) simulations, processing of the 3D digital terrain model, obtained via UAV



**Jürgen Hackl** is a researcher at the Infrastructure Management Group at the Swiss Federal Institute of Technology in Zürich (ETHZ), Switzerland. His research interests lie in urban resilience and span both computational modelling and network science.

Much of his work has been on improving the understanding, design, and performance of complex interdependent infrastructure systems, affected by natural hazards.



**Prof. Dr. Bryan T. Adey** is the Professor for Infrastructure Management, and the head of the Institute for Construction and Infrastructure Management, in the Department of Civil, Environmental and Geomatic Engineering, at the Swiss Federal

Institute of Technology in Zürich (ETHZ), Switzerland. He is also the Director of Studies for the Masters Spatial Planning and Infrastructure Systems at the ETHZ and the president of the code and research committee 4.3 Maintenance Management: Total System of the Swiss Association for Road and Transport Professionals (VSS).

photogrammetry, was necessary. Due to missing pictures or the inability of the software to compute every part of the terrain (e.g. insufficient lightning), gaps and loose artefacts occurred in the model, (see Fig. 3), these disturbances had to be removed manually from the model.

(5) To analyze the complex flow field around the Val da Riein Bridge, the open source CFD software package OpenFOAM was used. A number of parameters and settings had to be defined in advance. The CFD analysis process involved: (a) mesh generation, determination of (b) physical properties, definition of (c) boundary and initial conditions, definition of (d) time discretization and iterative solver, (e) simulation run, and (f) post-processing and validation of the results.

(6) The post-processing of the simulation results was performed in order to extract the information from the CFD simulation. The open-source, multi-platform data analysis and visualization application ParaView and Blender were used. The results of most interest for this study were the velocity vectors and streamlines around the bridge, for the estimation of the possibility of scouring, and the water surface for the estimation of the possibility of the river overtopping the bridge. The modelled flow velocities are illustrated in Fig. 4. The output was compared and evaluated with observed historical data of the region.

Fig. 4 shows the results for a simulation run where the discharge of the River Glong corresponds to the mean annual runoff and the

Table1. Software packages used in the study.

| Application | Description  | License | Type       | Url   |
|-------------|--|---------|------------|---|
| openCV      | Is an open source computer vision and machine learning software library.   | BSD     | library    | <a href="https://opencv.org/">https://opencv.org/</a>                                     |
| openMVG     | Is a library for computer-vision scientists and especially targeted to the Multiple View Geometry community.   | MPL2    | library    | <a href="https://github.com/openMVG/openMVG">https://github.com/openMVG/openMVG</a>       |
| openMVS     | Is a library for computer-vision scientists and especially targeted to the Multi-View Stereo reconstruction community.   | GNU-GPL | library    | <a href="https://github.com/cdceacave/openMVS">https://github.com/cdceacave/openMVS</a>   |
| Blender     | Is the free and open source 3D creation suite. It supports the entirety of the 3D pipeline-modeling, rigging, animation, simulation, rendering, compositing and motion tracking, even video editing and game creation. | GNU-GPL | standalone | <a href="https://www.blender.org/">https://www.blender.org/</a>                           |
| swiftSnap   | Is a Blender addon for creating snappyHexMeshDict and associated files for OpenFOAM's snappyHexMesh application.   |         | plug-in    | <a href="https://github.com/nogenmyr/swiftSnap">https://github.com/nogenmyr/swiftSnap</a> |
| OpenFOAM    | Is a free, open source computational fluid dynamic software.   | GNU-GPL | standalone | <a href="https://www.openfoam.com/">https://www.openfoam.com/</a>                         |
| ParaView    | Is an open-source, multi-platform data analysis and visualization application.   | BSD     | standalone | <a href="https://www.paraview.org/">https://www.paraview.org/</a>                         |

Figure 4. Water surface and velocity trace lines for a 100-year flood event for the River Glong and a 300-year flood event for the River Riein, which corresponds to an average discharge of  $489 \text{ m}^3/\text{s}$  respectively  $11 \text{ m}^3/\text{s}$ .

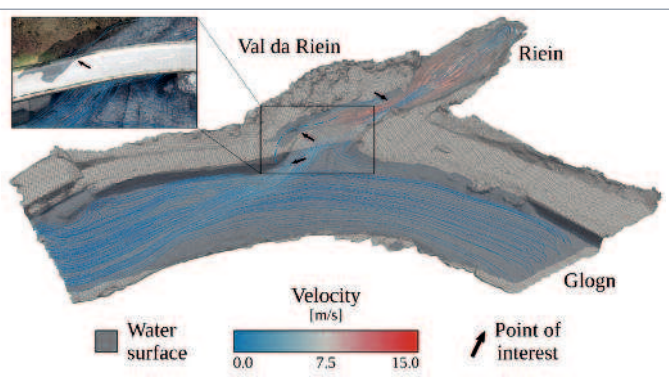

discharge of the River Riein to a flood event with a 300 year return period. Water surface and velocity trace lines are plotted. Red colored trace lines indicate areas with a high velocity. In this scenario flooding of the road is observed. It can be seen that a bridge overflow is rather unlikely because the water flows over the northern embankment and not over the bridge itself.

The results of the simulation correspond to the observed behavior; namely, high flow volumes

and velocities were observed at the northern abutment of the Val da Riein Bridge resulting in a high likelihood of scouring occurrence. Especially during extreme events, the structural integrity of the bridge could be jeopardized. However, the simulation results indicate that bridge overtopping is unlikely because during the investigated events the water flows over the embankment on the road before it overflows the bridge.

To conclude, UAV technology applied in engineering applications has great potential, especially since the availability of inexpensive commercial off-the-shelf UAVs increases every year, and precise GPS and gyroscope technology enable less experienced operators to maneuver the UAV more precisely. This technology provides the ability to quickly deliver high resolution temporal and spatial information, which can be used to generate precise orthophotos, maps and 3D models, within a shorter amount of time than traditional surveying processes. This increases the ability to perform detailed studies in risk assessments. ■

## References

- [1] Weingartner, R., Barben, M., and Spreafico, M. (2003). "Floods in mountain areas - An overview based on examples from Switzerland." *J. Hydrol.*, 282(1-4), 10-24.
- [2] Jarrett, R. D. (1984). "Hydraulics of high-gradient streams." *J. Hydraul. Eng.*, 11(110), 1519-1539.
- [3] Hackl, J. et al. (2018). "Use of Unmanned Aerial Vehicle Photogrammetry to Obtain Topographical Information to Improve Bridge Risk Assessment" *J. Inf. Syst.*, 24(1), 04017041.
- [4] DETEC. (2014). "Verordnung des UVEK über Luftfahrzeuge besonderer Kategorien." Nr.: 748.941, Departement of the Environment, Transport, Energy and Communication, Bern, Switzerland.
- [5] TBA GR. (2016). "Objektbilder: Valsenstrasse/lanz—Mulin da Pitasch." KJUBA-GR. Rep. KJUBA-Nr.: 48 00 07, Tiefbauamt Graubünden, Chur, Switzerland.

## TO DRONE OR NOT TO DRONE? EXPERIMENTING THE USE OF UAV FOR FLOOD MODELLING IN DATA-SCARCE REGIONS

Continued from page 18

data, while SRTM provided an uncertain DEM, which may result in unreliable estimates of the extent of the flooded area.

The table below summarizes the characteristics of the three DEMs used in this study: the LiDAR, used as reference, the SRTM and the drone-generated DEM. They clearly show different characteristics with the LIDAR and drone being more similar to each other than to the SRTM.

### Conclusions

The aim of this study was to investigate the potential use of drone-based topographical dataset as a faster and cheaper substitute of LIDAR products and global topographical datasets, for flood modelling, in data-scarce regions. We found that drone-based DEM provided more accurate terrain elevation values than SRTM products and similar values than those from LiDAR surveys.

In addition, during the driest period of the year, drone surveys can be very effective to monitor and quantify morphological changes of river beds and river banks and thus re-calibrate the geometry of the river. The general assessment of drone-based DEM is positive and cost-effective when compared to more expensive and topographical products such as LiDAR. In

addition, the topographic survey campaigns using drones can be easily carried out by Water Resource Management Authorities, every year, after short training activities. In our assessment, there is a high return for the small investment in the drone equipment.

However, drone-based topographical datasets also have some disadvantages. In our survey the environmental conditions were extreme, with very high temperatures, which affected the performance of the electronics onboard the drone and remote controller. Also, we could not collect GCPs. Despite these limitations, we managed to georeference our point clouds based on fixed locations visible on the LiDAR flight and corresponding orthophotography, and so we could assess the quality of the drone's topography generated using off-the-shelf drone equipment.

New models of commercial drones with on board RTK GPS are becoming more frequent also in the price range below 10,000 USD. This, we believe, will create a breakthrough in the ability of having repeated, very accurate and very high resolution, topographic surveys at selected crucial river cross-sections, thus allowing improved assessment of high risk areas. ■

## References

1. Costanza R., d'Arge R., de Groot R., et al. (1997). The value of the world's ecosystem services and natural capital. *Nature*, 387, 253-260.
2. Di Baldassarre, G., A. Montanari, H. Lins, D. Koutsoyiannis, L. Brandimarte, and G. Bloschl (2010). Flood fatalities in Africa: from diagnosis to mitigation. *Geophysical Research Letters*, 37, L22402
3. UNESCO-IFI (2007). International Flood Initiative <http://www.ifi-home.info/IFI-pamphlet.pdf>
4. Opperman, J.J., Galloway G.E., Fargione J., Mount J.F., Richter B.D., Secchi S. (2009). Sustainable floodplains through large-scale reconnection to rivers. *Science*, 326, 1487-1488.
5. CRED. (2016). EM-DAT: The International Disaster Database. <http://www.emdat.be>.
6. Bates, P. D. & De Roo, A. P. J. (2000). A simple raster-based model for flood inundation simulation. *Journal of Hydrology*, 236, pp. 54-77. doi:10.1016/S0022-1694(00)00278-X.
7. Nardi, F., Vivoni, R. E. and S. Grimaldi, S. (2006). Investigating a floodplain scaling relation using a hydrogeomorphic delineation method. *Water Resources Research*, Volume 42, Issue 9.
8. Brandimarte, L., Brath, A., Castellari, A. and G. Di Baldassarre (2009). Isla Hispaniola: a trans-boundary flood risk mitigation plan. *Physics and Chemistry of the Earth*, 34, 2009, pp. 209-218.
9. Hunter N.M., Bates P., Horritt M.S., and Wilson M.D. (2007). Simple spatially-distributed models for predicting flood inundation: A review. *Geomorphology*, 90(3-4), 208-225. <https://doi.org/10.1016/j.geomorph.2006.10.021>
10. Horritt, M. S., and P. D. Bates (2002). Evaluation of 1D and 2D numerical models for predicting river flood inundation. *Journal of Hydrology*, 268(1-4), 87-99.
11. Carbonneau P. E. and Piegay H. (2012). *Fluvial Remote Sensing for Science and Management*. Wiley-Blackwell, - ISBN: 978-0-470-71427-0.
12. Zinke Peggy and Flener C. (2012) Experiences from the use of Unmanned Aerial Vehicles (UAV) for River Bathymetry Modelling in Norway. Proceedings of "Technoport - Sharing possibilities". Trondheim: 16-18 April 2012.
13. Perks, M. T., Russell, A. J., and Large, A. R. G. (2016). Technical Note: Advances in flash flood monitoring using unmanned aerial vehicles (UAVs). *Hydrol. Earth Syst. Sci.*, 20, 4005-4015. <https://doi.org/10.5194/hess-20-4005-2016>
14. Leitão, J. F., Moy de Vitry, M., Scheidegger, A., and Rieckermann, J. (2016). Assessing the quality of digital elevation models obtained from mini unmanned aerial vehicles for overland flow modelling in urban areas. *Hydrol. Earth Syst. Sci.*, 20, 1637-1653. <https://doi.org/10.5194/hess-20-1637-2016>
15. Mourato S., Fernandez P., Pereira L., and Moreira M. (2017). Improving a DSM Obtained by Unmanned Aerial Vehicles for Flood Modelling. IOP Conf. Ser.: Earth Environ. Sci. 95 022014 doi:10.1088/1755-1315/95/2/022014
16. <https://www.dronedeploy.com/>
17. <https://forum.dronedeploy.com/> and <https://forum.dji.com/>



# GAUTRELLE DIKE ANALYSIS AT OLERON ISLAND

BY BENOÎT GUILLOT

The Oleron island is located along the French Atlantic coast less than 30 kilometers north of the Gironde estuary. Artelia was commissioned in 2017 by the Charente-Maritime Departement Council to analyze the consequences of a removal scenario of *Gautrelle* dike in the north of the island. This dike was built in the 1990's to protect a large low elevation area which includes a camping site.

The study was performed between the spring of 2017 and the winter of 2018. To understand the morphodynamics of the area, we used diachronic aerial photography and a small Unmanned Aerial Vehicle (UAV), to achieve precise topographic and ortho-image data. These data were combined with GIS computations and analysis.

## Material and methods

Old aerial photographs were obtained using the database of the French National Geographical Institute (IGN) for the years 1950, 1964, 1973, 1984, 1991 and 2000. Between years 2000 and 2014 we used reference ortho-images, called "BD Ortho", provided also by IGN. These images are mainly black and white and were mosaiked for each date, using a stereo-photogrammetric protocol. After this mosaiking, they were georeferenced using remarkable georeferencing points picked-out from a 2014 reference image. After a technical check, each resulting orthophoto was visually photo-interpreted to identify the shoreline position (dune toe, dike or groin toe). Then, each diachronic shoreline was analyzed with GIS software using the *Digital Shoreline Analysis System* (DSAS) [1] to get evolution dynamics.

The high-resolution survey was conducted in the spring of 2017, to actualize the last topographic data acquired in 2010, and the last orthophoto acquired in 2014. For this survey, we used a local stereo-photogrammetric protocol [2]. This is based on the use of Ground Georeferencing Protocol (GGP) and Ground Control Points (GCP). Those points were georeferenced with a centimetric *Trimble Geo 6000* Global Navigation Satellite System (GNSS), with a Post-Processing Kinematic (PPK) protocol. Aerial data were obtained deploying an UAV equipped with a 3 axis brushless gimbal and 20 Mp camera (*DJI Phantom 4 Pro*). During the stereo-photogrammetric assembly, low precision UAV GNSS positions were not used. The entire model was georeferenced, using GGP's and GCP's. The data produced were a 1-cm cell-size orthophoto and a 4-cm cell-size Digital Surface Model. Vertical accuracy of the data is less than 6 cm and horizontal accuracy is less than 3 cm. Vegetation was classified and filtered above the camping surface, to produce a Digital Terrestrial Model.

Those data were then computed with a GIS (*Arcgis*) software. Several analyses were



**Benoît Guillot** is the manager of ARTEDRONES, the field data acquisition team of Artelia specialized in drone operation. He obtained a master and PHD degree in developing protocols to acquire topographic data of groins and dikes in shoreline environments by using drones.

deployed. The first involved the extraction of contour lines, hillshades and slopes. The second focused on computing cut and fill to identify topographic differences and to document the evolution of the topography between 2010 and 2017. The third set of analysis dealt with the conversion of the topographic differences into volumetric differences using each DSM cell surface and elevation difference.

## Results

Results obtained by this survey allowed analyzing precisely the topographical and morphological evolution of the shoreline (figure 4). The data showed significant morphological evolution of the beach, specifically

Figure 1. Study site localization: In A: Study site located in South-West French littoral. In B: Study site located at Oleron Island. In C: overview of the study site

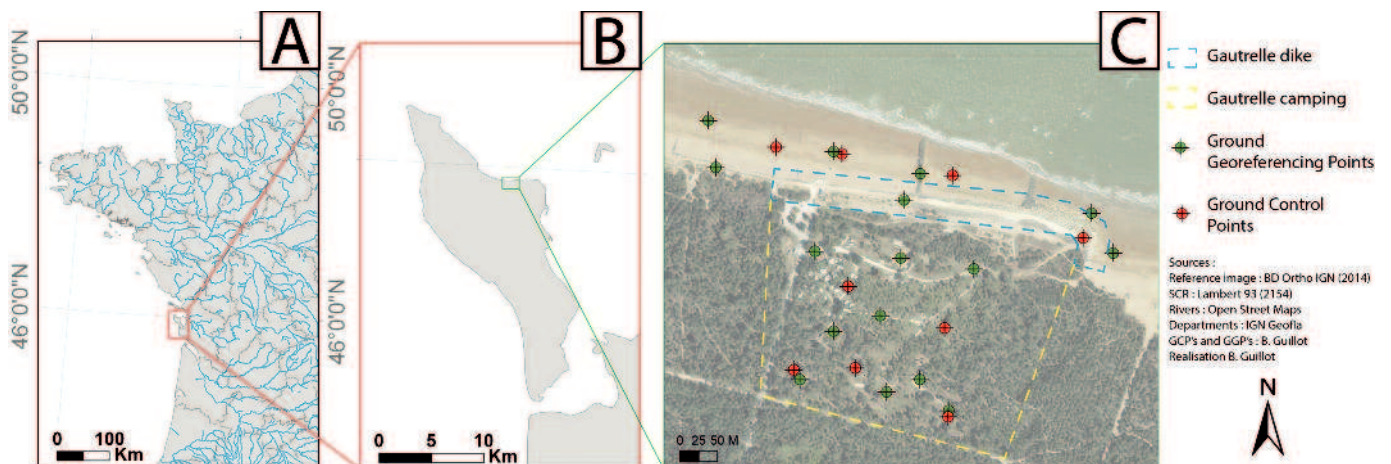



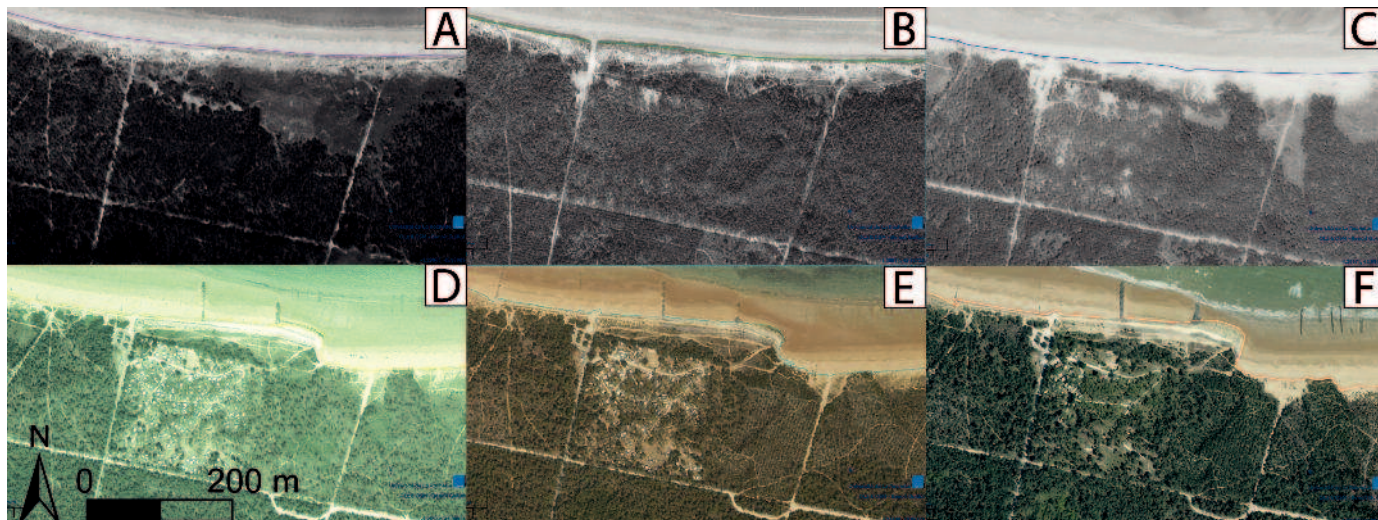

Figure 2. Diachronic images of the study site: 1950 (A), 1973 (B), 1984 (C), 2000 (D), 2010 (E), 2014 (F)

around groins and dike. The adjacent field appears to be relatively stable.

**Conclusion**

New technologies such as photogrammetric drones or UAS appear to be very interesting for analyzing littoral environments. The possibility to implement automated flight plans offers new perspectives for deploying this type of equipment easily. Combined with a robust protocol using ground control points, this technology can be deployed on demand after every meteorological event such as storms or severe winds. For coastal studies, the accuracy of data, the very high resolution and the flexibility of the protocol are highly valuable in support of traditional studies such as 2D or 3D modeling. Future improvements to this protocol are expected by optimizing the number of ground control points (to be decreased) and by working on the classification of vegetation points. ■

**References**

- [1] USGS, U.S.G.S., 2016. Department of The Interior, DSAS 4.0, Installation, Instructions and User Guide, updated for Version 4.3 (only compatible with Arcgis 10).
- [2] Guillot, B., Musereau, J., Dalaine, B., Morel, J., 2018. Coastal Dunes Mobility Integration and Characterization: Developing a Flexible Volume Computing Method. Journal of Geographic Information System 10, 503-520. <https://doi.org/10.4236/jgis.2018.105027>

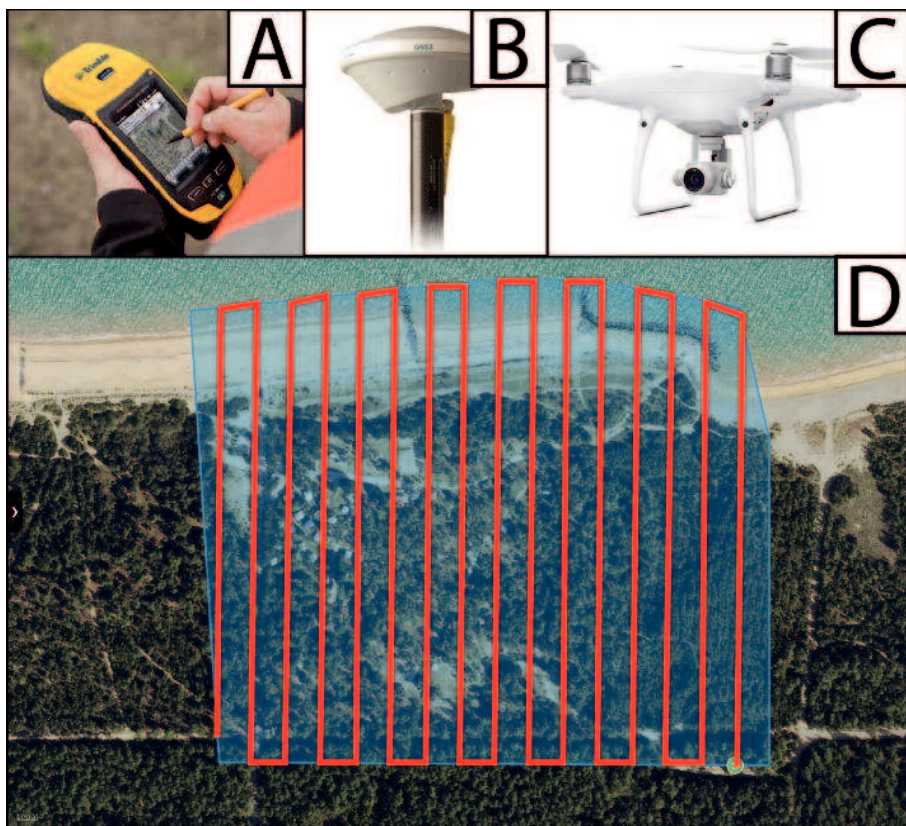
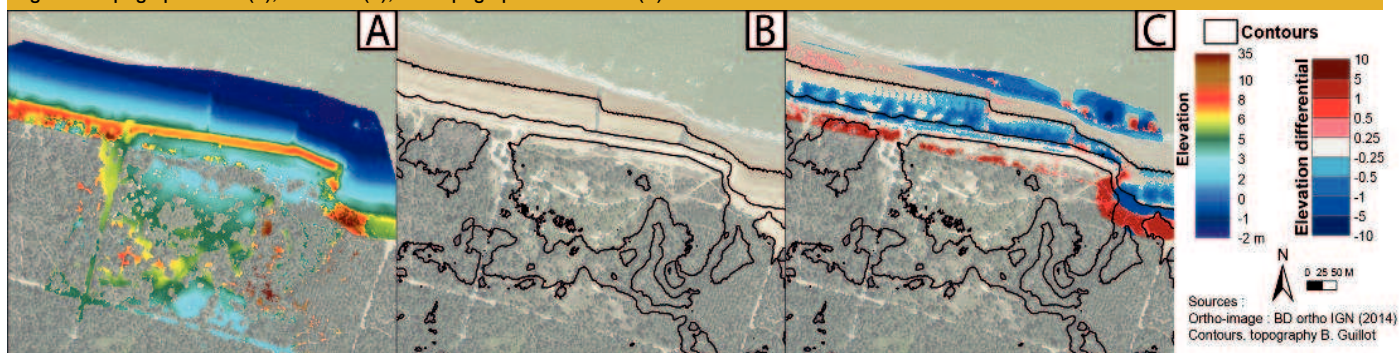

Figure 3. Geo6000 GNSS (A) with Trimble Zephyr model 2 antenna (B), the UAV used for the survey (C), the flight plan deployed (D)

Figure 4. Topographic data (A), contours (B), and topographic differential (C)





# OPTICAL SENSOR AND DRONE SYSTEM FOR THE SURVEY OF CYANOBACTERIA IN FRESHWATER ECOSYSTEMS – OSS-CYANO

BY CATHERINE FREISSINET



**Dr. Catherine Freissinet** started working at Sogreah/Artelia in 1993. She is now head of R&D and Innovation in the Environment department within ARTELIA's Water & Environment sector. She oversees and coordinates activities relating to research programmes in France, in Europe and internationally. She is also International Project Director focusing on issues concerning the integrated management of river basins and natural resources, including the impact of climate change and adaptation strategies, and statutory and institutional studies.

Access to freshwater resources is one of the basic human rights but the available water is not always of sufficient quality, especially for drinking and everyday consumption. Moreover, freshwater ecosystems are also used for recreational activities in many countries and thus are of particular importance for the local economy in numerous areas. Due to eutrophication and, to a lesser extent, to climatic changes [1] [2], cyanobacterial blooms seem to be increasing in a growing number of freshwater ecosystems worldwide. These blooms severely disrupt the functioning of these ecosystems and potential

water use because many cyanobacterial species are able to produce a variety of toxic metabolites, which can be harmful to both human and animal health. In addition to health risks, cyanobacterial blooms may also interfere with drinking water production due to filter clogging and taste and odor. Following the recommendations of the WHO published in 1998, health and sanitation authorities of numerous countries have published guidelines for the survey of cyanobacteria in aquatic ecosystems used for the production of drinking water or for recreational activities.

The main problem in these surveys is the spatial heterogeneity of the cyanobacteria distribution during their blooms. This distribution may be affected by significant horizontal (Fig. 1) and vertical variations [3] [4] [5] [6], which makes it difficult to manage the health risks associated with the events that cause the proliferation of different species.

In recent years, new tools have been tested with the intention of improving cyanobacterial surveys such as, for example, remote sensing to determine the horizontal distribution of cyanobacteria in freshwater ecosystems [7], or

spectrofluorometric probes to reveal the vertical distribution of cyanobacteria in the water column [8]. Moreover, these spectrofluorometric probes and other sensors have now been integrated into buoys, to provide real-time monitoring of cyanobacteria in freshwater ecosystems [9]. However, despite the great potential of these measurement tools, their cost remains prohibitive for their routine use in the foreseeable future, and most of the worldwide monitoring programs for the survey of cyanobacteria will continue to be based on more conventional methods for the years to come. Performing discrete sampling of various water volumes taken from the shoreline of ecosystems is probably the most often used method in these studies. Unfortunately, because of spatial and temporal differences in the distribution of cyanobacteria, this approach can often provide only a very rough estimation of cyanobacterial abundance and, consequently, resulting in the inaccurate estimation of the associated health risks. There is therefore a real need to develop new tools allowing the estimation of the spatial distribution of cyanobacteria at an affordable cost for their use in routine survey programs.

Figure 1. Spatial heterogeneity in the distribution of cyanobacteria at Champs sur Marne lake, August 2017 (Photo: C Freissinet)



Figure 2. OSS-Cyano methodology

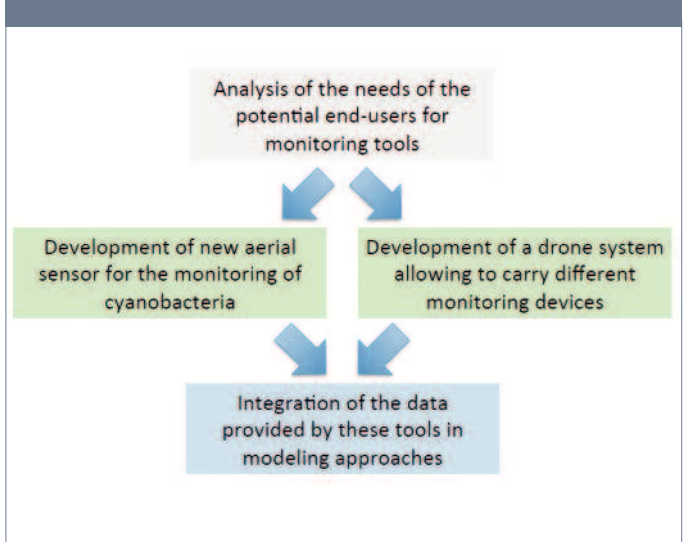

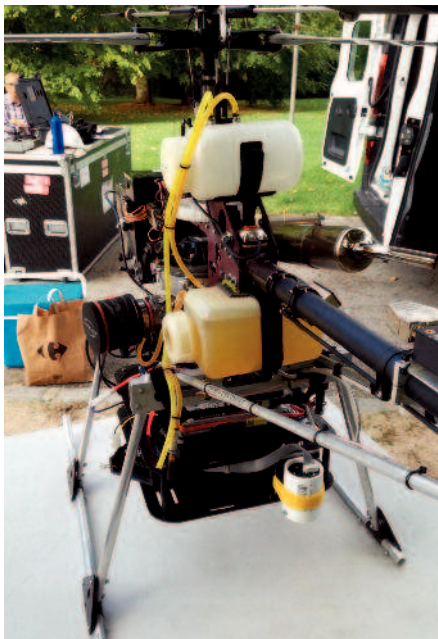

Figure 4. Sensor mounted on a drone (Photo C. Freissinet)

### Methodology and Results

The OSS-Cyano overall methodology is shown in fig. 2. A preliminary inquiry has allowed identifying the water managers' needs. These end-user requirements were the backbone of the research work to develop a prototype operational tool made of two main components: a new aerial sensor able to monitor cyanobacteria in water domains on the one hand, and a drone system allowing carrying various surveying and sampling equipment on the other hand. Then the modeling module was based on the use of the Delft3D-Flow hydrodynamic model (from Deltares). Calibration was performed by LEESU on two lakes using continuous measurements from sub-aquatic sensors placed in these lakes. The integration of aerial collected data into the model provides coherent spatial and temporal view of potential cyanobacteria blooms. The full prototype tool was validated on the two lakes: nautical base of Champs sur Marne (Paris suburb) and Lake Grand Lieu (Britany)

The main results of the project are the development and the testing of a new sensor and a drone system associated with a mathematical model for the monitoring of the spatial distribution of cyanobacteria and more widely of phytoplankton and periphyton, in freshwater ecosystems. The system used included the following:

- A fully automated low-cost (< 400 euros) optical sensor with autonomy of several months on a standard battery, which could be used either alone at the top of a mast (fig.3) or mounted on a drone (fig.4). This sensor has



Figure 3. Optic sensor at a fix position at Champs sur Marne (Photo C. Freissinet)



Figure 5. OSS-Cyano drone (Photo Ifsttar)

been validated under realistic conditions. The results have been published recently by Hmimina<sup>[10]</sup>.

- A drone (fig.5) able to carry also other equipment allowing (i) to perform measurements in the water column by using probes (chlorophyll a, pH, temperature, and conductivity) and (ii) to sample water for cell counting or toxin identification and quantification.
- A three-dimensional hydrodynamic model using data from the sensor and/or drone to forecast short-term changes of the spatial dispersion of cyanobacteria in a water body.

### Acknowledgments

This work was supported by the ANR OSS-CYANO project ANR-13-ECOT-0001, grant ANR-2013-Ecotecnologies & Eco-Services (ECO-TS) of the French Agence Nationale de la Recherche.

This project relies on the participation of six laboratories (IEES Paris, IFSTTAR, Leesu/Ecole des Ponts, ESE/Université Paris-Sud, Université

Paris-Diderot/MNHN, CEREEP) and the private company partner ARTELIA Water & Environment. ■

### References

- [1] Markensten et al. 2010. Simulated lake phytoplankton composition shifts toward cyanobacteria dominance in a future warmer climate. *Ecological Applications* 20, 752-767.
- [2] Paerl, H.W. & Huisman, J., 2009. Climate change: a catalyst for global expansion of harmful cyanobacterial blooms. *Environmental Microbiology Reports* 1, 27-37. Briand et al. 2003. Health hazards for terrestrial vertebrates from toxic cyanobacteria in surface water ecosystems. *Veterinary Research* 34, 361-378.
- [3] Porat et al. 2001. Diel buoyancy changes by the cyanobacterium *Aphanizomenon ovalisporum* from a shallow reservoir. *Journal of Plankton Research* 23, 753-763.
- [4] Welker, M., Döhren von, H., Täuscher, H., Steinberg, C.E.W. & Erhard, M., 2003. Toxic Microcystis in shallow lakes Müggelsee (Germany) - dynamics, distribution, diversity. *Archiv für Hydrobiologie* 157, 227-248.
- [5] Cuyper et al. 2009. Impact of internal waves on the spatial distribution of *Planktothrix rubescens* (cyanobacteria) in an alpine lake. In press in *The ISME Journal*.
- [6] Pobel et al. 2011. Influence of sampling strategies on the monitoring of cyanobacteria in shallow lakes: Lessons from a case study in France. *Water Research* 45, 1005-1014.
- [7] Hunter et al. 2009. Using remote sensing to aid the assessment of human health risks from blooms of potentially toxic cyanobacteria. *Environmental Science & Technology* 43, 2627-2633.
- [8] Le Boulanger et al. 2002. Application of a submersible spectrofluorometer for rapid monitoring of freshwater cyanobacterial blooms: a case study. *Aquatic Microbial Ecology* 30, 83-89.
- [9] Le Vu et al. 2011. High-frequency monitoring of phytoplankton dynamics within the European water framework directive: application to metalimnetic cyanobacteria. *Biogeochemistry* 106: 229-242.
- [10] Hmimina, et al. 2019. Linking phytoplankton pigment composition and optical properties: A framework for developing remote-sensing metrics for monitoring cyanobacteria. *Water Research* 148 (2019) 504e514



# 7<sup>TH</sup> INTERNATIONAL SYMPOSIUM ON HYDRAULIC STRUCTURES: A RETROSPECT

MAY 14-18 2018, AACHEN, GERMANY

BY DANIEL B. BUNG, BLAKE P. TULLIS, SÉBASTIEN ERPICUM & BRIAN M. CROOKSTON

The seventh International Symposium on Hydraulic Structures (ISHS2018) was held in Aachen, Germany May 14 to 18, 2018. The event aimed to provide a platform for researchers and practitioners from all over the world to discuss recent advances in hydraulic structures design, field applications and future research needs. A total of 108 delegates attended the symposium representing 27 countries and 5 continents.

## Short course on basic principles of open channel hydraulics

The five-days event began with a short course on the basic principles of open channel hydraulics, being offered by Prof. Hubert Chanson at the University of Applied Sciences in Aachen. The full-day short course was offered free-of-charge and attracted more than 28 attendees from 8 different countries and 4 continents.

## Workshop on non-linear weir design

A specialized workshop on the hydraulics and design of nonlinear weirs took place on the second day. The aim of this workshop was the transfer of knowledge from theory to practice. The workshop was organized by two speakers from research (Prof. Blake Tullis from Utah State University, United States; Dr. Sébastien Erpicum from Liege University, Belgium) and two

additional speakers from practice (Dr. Brian Crookston, Schnabel Engineering, United States; Frédéric Laugier from EDF, France) and included summaries on piano key weirs and labyrinth weirs. 20 individuals (full room capacity) attended the specialty workshop.

## Symposium

The symposium itself took place May 16-17 in the SuperC building, located in the city center of Aachen. It was run in two parallel tracks with a total of 14 technical sessions. 74 papers were presented in oral presentations of 20 minutes length and 3 additional papers were presented in a poster session. The themes of the single sessions were:

- Dam Safety and Management
- Weirs and Spillways
- Nonlinear Weirs
- Energy Dissipators

- Fish Passages (two sessions)
- Case Studies
- Sedimentation and Erosion
- Intake Structures
- Waterway Structures
- Physical Modelling
- Hybrid Modelling
- Numerical Modelling
- Coastal Structures and Waves

In addition to these technical sessions, three invited keynote lectures were given. To follow the aim of ISHS to close the gap between research and practice, keynote speakers were invited from all fields. The speakers were:

- Paul Schweiger (Gannet Fleming Engineering): Lesson-to-be-Learned from the Oroville Dam Spillway Incident.
- Prof. Dr. Robert Boes (ETH Zürich): Multi-phase flow at hydraulic structures: water-sediment, air-water, and water-structure-fish interaction.
- Prof. Dr. Andreas Schmidt (Federal Waterways Engineering and Research Institute): Modelling in Waterways Engineering – Expectations and Challenges.



Attendees of the short course offered by Prof. Hubert Chanson



Workshop session with Dr. Erpicum presenting

### Philip H. Burgi Best Paper Award

ISHS 2018 was the inaugural year of the Philip H. Burgi Best Paper Award, named after the first chair of the Hydraulic Structures Technical Committee and awarded to the best paper of the Symposium. Members of the International Scientific Committee created a short list of 5 best-paper candidates and the best paper was determined by symposium attendee voting. The ISHS2018 Philip H. Burgi Best Paper award was given to Dr. Svenja Kemper from University of Wuppertal, Germany. Schnabel Engineering (USA) donated an iPad to accompany the award. Announcement of the Best Paper award winner was part of the closing dinner program.

### Field trip

The final day of the symposium included a technical tour of Eupen Dam and Water Treatment Plant (Belgium) and the Coo Pump-Storage Plant (Belgium). Approximately 60 individuals attended the tour. Eupen dam and water treatment plant, which includes nanofiltration, have been an important source of clean drinking water in the region since 1951. The

Coo pump-storage plant was built between 1971 and 1979 to support the Tihange nuclear power plant located next to river Meuse. It has a generation capacity of 1,164 MW with 6 pump-turbine groups located in an underground cavern. Two upper reservoirs provide a combined storage capacity of 8.5 million m<sup>3</sup> and are located 279 m above the lower reservoir. The plant is operated by ENGIE company and is a key component of the overall power production system in which intermittent renewable energy sources play a growing part.

### Proceedings

All papers are published in the Proceedings and have been thoroughly peer-reviewed for technical quality and presented at ISHS2018. The Proceedings were published by Utah State University and are available open access at <http://digitalcommons.usu.edu/ishs/2018/>. Each manuscript includes the ISBN of the

Proceedings as well individual direct object identifiers (DOI). Each manuscript is indexed by Scopus and Compendex and available to users through the USU digital commons portal pursuant to a Creative Commons Attribution-NonCommercial CC BY 4.0 license.

### Acknowledgements

The chair of the Local Organizing Committee, Prof. Daniel Bung, is grateful for the big support provided by all LOC members and the effort spent by all members of the International Scientific Committee and reviewers for ensuring a high technical quality of the program. The support of Schnabel Engineering, Inc., and the Federal Waterways Engineering and Research Institute (BAW) is also acknowledged. ■





# YOUR VOTE COUNTS!

The Nominating Committee hereby presents the slate of candidates for the 2019 Council Elections.

All IAHR Members have the option to file a nomination by petition, with the deadline being April 30th.

All Members will be invited to vote by electronic ballot and elections will be open until Wednesday September 4th.

For more information on this election procedure visit [www.iahr.org](http://www.iahr.org) / About / Council / Council Elections or contact Elsa Incio at [elsa.incio@iahr.org](mailto:elsa.incio@iahr.org)



## 2019 COUNCIL ELECTIONS

### For President

**Prof. James E Ball**  
University of Technology Sydney,  
Australia



It is an honour to be considered a candidate for election as President of IAHR. I am currently a member of the School of Civil and Environmental Engineering at UTS. One focus of the UTS approach to engineering education is the link between science and application of engineering - an area of ongoing interest to IAHR. In addition to being a member of IAHR, I am a Fellow of Engineers Australia, a member of ASCE, and a member of IAHS. Additionally, I was the Editor responsible for revision of the Australian Guidelines for flood estimation - Australian Rainfall and Runoff, published in 2016. Also, I am Editor-in-Chief for the International Journal of River Basin Management, an Editor for Water Science and Technology, and a member of the editorial boards for the Urban Water Journal, the Journal of Hydroinformatics, and the Australian Journal of Water Resources.

As a member of IAHR since 1985 I have been able to both observe and participate in many IAHR activities. During that time I have participated in the IAHR Technical Committees on Hydroinformatics, and Urban Drainage and have organised both a World Congress (2011) and an ICUD (1999). In addition, over the past 8 years I have had the opportunity to serve IAHR as a Council Member and Vice-President from the Asia-Pacific Division. During this time I served on the Finance and Publications Committees where the aim was to enhance the services available to IAHR members within the constraints of a sustainable association.

Over the past few years, IAHR has been undergoing change with the creation of a new Secretariat in Beijing to complement our Madrid Secretariat, a new ED to replace Chris George who has retired, the creation of new journals, and the implementation of a new integrated management system for servicing members. While many aspects of this change have been completed, there are other aspects that need to continue if IAHR is to benefit.

One issue of continued focus needs to be our membership. Over the past few years, significant effort has been applied to increasing our membership in developing countries. While this has been successful, there are two areas where we need to focus our ongoing efforts; these are the female participation in the Association (and our Technical Committees) and in our connection with the practicing end of the engineering spectrum. Both of these areas are important to IAHR for its long-term sustainability.

We also need to continue the improvement of services to our members within the constraints of available finance. While recent years have seen the creation of the Journal of Eco-hydraulics and the provision of support for the on-line journal Water Science and Engineering, we need to continue our journal activities to ensure there are opportunities within the IAHR stable of journals for publications across the range of activities undertaken by members of IAHR and its Technical Committees. Additionally, we need to enhance our social media activities to meet the needs of our Young Professionals.

### For President

**Prof. Joseph Hun-wei Lee**  
Hong Kong University of Science  
and Technology,  
China



Prof. J.H.W. Lee is Senior Advisor to the President and former Vice-President for Research and Graduate Studies (2010-2016), the Hong Kong University of Science and Technology (HKUST). Prof Lee is a native of Hong Kong and received all his university and postgraduate education at the Massachusetts Institute of Technology (1969-1977). In 1980 he joined the University of Hong Kong (HKU) where he became Redmond Chair Professor of Civil Engineering in 1995. At HKU, he was Dean of Engineering from 2000 to 2003, and Pro-Vice-Chancellor and Vice-President (Staffing) from 2004-2010. Prof. Lee is recognized internationally for his contributions in hydraulic engineering – in particular the theory of buoyant jets and its applications to environmental engineering. He is the recipient of numerous awards that include the ASCE Hunter Rouse Hydraulic Engineering Award (2009), the Hilgard Hydraulic Prize (2013), the China State Scientific and Technological Progress Award (2010), and the Croucher Senior Research Fellowship (1998). He is a Fellow of the Royal Academy of Engineering and the Hong Kong Academy of Engineering Sciences. He was bestowed Honorary Membership by IAHR in 2015. Prof. Lee has served on many international advisory bodies and as an independent expert on numerous hydro-environmental projects.

### IAHR Involvement:

- IAHR President's Task Force on Governance (2017-2018)
- Executive Chairman, Local Organizing Committee, IAHR Congress 2013, Chengdu, China
- IAHR Vice-President (2007-2011)
- IAHR APD Chairman (2003-2007)
- Founding Editor in Chief, IAHR-APD Journal of Hydro-environment Research (2007-)
- Chairman, Local Organizing Committee, IAHR-APD Congress 2004, Hong Kong, China.
- IAHR Fluid Mechanics Section Chair (1996-2002)

### Personal Statement

My involvement with IAHR dates back to 1983 when I attended my first IAHR Congress in Moscow; it was a memorable occasion as I met so many top scholars – at a time when the use of turbulence modeling in hydro-environment problems was at its infancy. IAHR has always had this unique family spirit that ties young members to more experienced mentors of the community. Water and environment will rank high on the policy agenda of many governments in the coming decade. Population growth, urbanization and climate change give rise to many food, water and energy security issues. The “second machine age” is also bringing many opportunities for the next generation of hydro-environment research and practice: smart water management systems for climate resilient cities is just an example. On the other hand, IAHR is also facing many challenges: in this age of globalization and ubiquitous data access there is a need for organizations to act swiftly and respond in an agile manner.

I commit to bring my energy, experience and international networks to lead the development of IAHR. Building on the excellent foundation laid by the past presidents I intend to work with all members to:

- Promote diversity and enhance international collaboration
- Listen to the young members for their ideas and suggestions; increase significantly IAHR membership
- Streamline IAHR governance and improve administrative effectiveness
- Actively engage top scholars and practitioners in high level agenda setting inter-disciplinary forums and publications

## SLATE OF CANDIDATES

**For Vice-President  
For the Americas****Prof. Robert  
Ettema**

Colorado State  
University.  
USA



With a sense of deep appreciation for IAHR's important international mission in water engineering and science, I am glad to be a candidate for the position of IAHR Vice-President (Americas Region). The position offers an opportunity to actively promote IAHR's activities. Additionally, the position presents an effective opening through which to guide IAHR towards addressing contemporary fiscal challenges facing IAHR.

The world needs IAHR, an independent international organization linking engineers and scientists focused on enlightened water engineering and science. However, as with many independent international associations of professionals, IAHR is vulnerable. IAHR's mission involves progressive efforts at promoting and conducting its activities and generating funds to enable its activities. These efforts require continual, vigilant tending by IAHR's leadership.

My connection with IAHR began about thirty-five years ago, when I joined IAHR and participated in various IAHR specialty symposia and an IAHR Congress. The expertise stimulation, fun and fellowship I experienced with these meetings led me to assist with organizing an IAHR symposium (1986) and an IAHR congress (2009). Also, I have assisted with running the Prof. J.F. Kennedy Student Paper Competition (35th-37th IAHR congresses), and since 2016 have served as IAHR Book Series Editor (assisting Taylor & Francis). I have served on IAHR's Council since mid-2011, beginning as a North American "at-large" member (2011-2014) and now as a member for North America (2015-2021). As a Council member, I currently serve on two task committees: Standing Committee on Finance; and, Revenue Generation. Last year, I submitted a green paper regarding the formation of an IAHR Development Fund supported by means of philanthropy, a path IAHR must further explore.

I am a professor in the Dept. of Civil and Environmental Engineering at Colorado State University, Colorado, USA. Prior to this appointment, I served six years as engineering dean at the University of Wyoming; and, earlier I was a faculty member based for 25 years in the University of Iowa's well-known unit, IHR-Hydrosience & Engineering. My professional goals are to advance water engineering through needs-motivated research and demonstrably effective education. Research activities involve me in various aspects of water-related infrastructure and cold-regions engineering.

**For Vice-President  
For the Americas****Prof. Rafael  
Murillo**

Universidad de  
Costa Rica.  
Costa Rica



I am appointed as an adjunct professor in the Department of Civil Engineering at the University of Costa Rica (UCR) as well as the Head of the Doctoral Programme in Engineering. I hold an undergraduate degree in civil engineering from UCR, and graduate degrees from IHE-Delft (M.Sc HE), Netherlands, and University of Manitoba (Ph.D.), Canada.

As a hydraulic engineering, I have worked intensively in Central America in the areas of hydrology, small hydropower as well as urban and highway drainage.

I joined IAHR in 1997. I have served on Council first as chairman of the Latin-American Division and presently as member representing Americas. I organized the International Conference on Fluvial Hydraulics River Flow and the XXV LAD Congress, both held in Costa Rica in 2012. I am currently collaborating with organization of 2019 World Congress to be held in Panama and the editorial committee of RIBAGUA.

**Statement**

It is an honoured to be nominated as candidate for IAHR Vice President. Nowadays water challenges require efforts from teams form by professional drawn from diverse areas. This simple fact should be reflected in the organization, its activities and members.

If elected my agenda will be to continue the efforts to link IAHR with water related professionals in Latin-American and to build bridges between them, especially among young professionals, by promoting networking opportunities, cooperation and exchange between academic institutions and YPN groups as well as encouraging activities within the region. I will also work towards achieving the IAHR strategic goals.

**For Vice-President  
For the Asia Pacific****Prof. Gregory  
Shahane de  
Costa**

Open Polytechnic  
of New Zealand.  
New Zealand



Since graduating with a Civil Engineering Degree from the University of Moratuwa, Sri Lanka and then doing a Masters in Environmental Engineering at the University of Hiroshima Japan, I continued to do a PhD at the same University. I also went on to do a MBA as well. In addition to my continuous and long involvement in tertiary education and research, I am also a Chartered Professional Engineer, on the International Professional Engineers register, Fellow of Engineering New Zealand and Fellow of Institute of Engineers Sri Lanka. I have been a recipient of many Research Fellowships and awards including the Monbugakusho, JSPS etc. I have also led collaborative International Research Projects funded by International funding agencies. Currently I am the academic specialist in charge of Engineering, Construction and Environment, programs and course design and development, at the Open Polytechnic of New Zealand.

My introduction to IAHR was while doing my PhD, in 1993, 26 years ago, when I presented my research work for the first time at a premier international forum. Since then I have attended all IAHR Congresses and most IAHR APD congresses as well. As Co-Chair of the 2010 IAHR APD Local Organizing Committee, we successfully organized a congress in New Zealand. Similarly as Chair of the 2016 IAHR APD Local Organizing Committee, we successfully organized a Congress in Sri Lanka. I have been Vice President of the IAHR APD Executive committee from 2014 to 2018 and currently the President of IAHR APD Executive committee.

If elected I look forward to making use of my experience and links to develop a vibrant loop between academia, research and industry in the Water Environment. I also look forward to working towards strengthening links between IAHR and policy makers and, IAHR having an enhanced influence on local and global policy in relation to Water Environment. Further, I look forward to enhanced connectivity, conveying the IAHR message and strengthening IAHR brand in tertiary education and research institutes related to water. Lastly but not least if elected I would work towards a cohesive and strong IAHR family.

**For Vice-President  
For the Asia Pacific****Prof. Hyoseop  
Woo**

Gwangju Institute  
of Science and  
Technology.  
Korea



Hyoseop Woo is Professor at School of Earth Science and Environmental Engineering, Gwangju Institute of Science and Technology (GIST). Before he joined GIST, he was a researcher in the field of hydro-engineering for 27 years, and served as President from 2011-2014, at Korea Institute of Civil Engineering and Building Technology (KICT) with about 1,000 employees and \$140 million annual budget. He received his Ph.D. at Dept. of Civil and Environmental Engineering, Colorado State University, USA in 1985 in sedimentation engineering. He authored more than 200 scientific contributions including college textbooks (in Korean), book chapters (in English), and numerous journal articles. He served as President of Korea Water Resources Association (KWRA) serving for about 2,500 members. He joined IAHR at the early 1990s, and served as leader of IAHR regional activities; hosted numerous IAHR conferences in Korea, including the 2005 IAHR Biennial Congress, the 2010 ISE, and the 2012 APD Congress. He served as Chairman of IAHR-APD from 2015 until 2018 after having served as Vice Chair for four years. During his tenure, he set up a tradition of having a special session at each IAHR-APD congress on the historical water projects and traditional water technologies in the Asia-Pacific region. He also helped found JHER, the IAHR journal, by providing a financial support from KWRA. He also served Associate Editor of WASER.

**Statement**

If elected, I plan to support the following:

- Make IAHR play a leading role in international cooperation among research institutes for collaboration. Public research institutes could have more flexible approach toward international collaborations for non-commercial, public-oriented water issues. A small example of such could be a recent successful collaboration jointly led by KICT and IAHR on real-scale channel experiments using a unique experimental facility in Korea operated by KICT, which was introduced at Hydrolink in 2017.
- Expand IAHR's membership and activities, especially in the Southeast and South Asia regions, such as in Vietnam, Thailand, and India, as they have large potential IAHR membership. APD membership and activities within IAHR are growing, highlighting the relevance of IAHR to the water-related diverse research and application problems.



## 2019 COUNCIL ELECTIONS

Council Member - For MENA/India sub-continent region  
2 candidates for 1 position**Dr. Gökçen Bombar**

*Izmir Katip Celebi University, Turkey*



After working as researcher at Dokuz Eylül University for three years, I was appointed in Ege University. In 2016 I moved to zmir Katip Çelebi University where I serve as Vice Dean of the Engineering and Architecture Faculty and Assistant Director of Women's Studies Research and Application Center. My research interests are flow on stepped spillways, sediment transport under unsteady flow conditions, bridge pier scour, dam-break problems, morphodynamics of river confluences, etc. I am co-author of 12 international scientific articles and around 65 proceeding papers. I have been involved in several projects funded by TUBITAK as a researcher and have been running one as PI. I was granted to participate in an experimental study in Hydraulics Laboratory of IST, Lisbon, in 2015. I was member of the LOC of 13th ACE Congress, zmir, 2018.

I am a member of IAHR and have involved in IAHR activities as a presenting author in IAHR World, IAHR Europe and River Flow conferences since 2006. I was finalist of JFK Student Competition in 2009, Vancouver.

As the leading organization, IAHR is in a unique position to promote synergies between academicians working in different countries in the world. If elected, I would be very interested in working to increase the communication between IAHR and researchers in the Turkish Republics, as Azerbaijan, Kazakhstan, Kyrgyzstan, Turkmenistan and Uzbekistan. Especially I would foster the participation of young scientists in the activities of IAHR by organizing workshops.

**Prof. Dalila Louydi**

*University Hassan II - Casablanca, Morocco*



My project is to work closely with the other council members for promoting IAHR more within the MENA region. Although collaborations between IAHR and many institutions already exist in this region, there is still more work that can be done in North Africa to bring more partners from this area. Besides, this region is considered as the gate to Africa, which can be valuable for more collaboration with African countries.

The MENA region is one of the most water scarce areas of the world. Climate change induced droughts and floods, lack of integrated water management, poor groundwater and surface water quality, dysfunctional water supply and wastewater systems are examples of water issues to which IAHR can bring its knowledge in this region. The association can greatly contribute to sustainable development of MENA region by promoting research and its application, continuing education and training activities for water stakeholders. Besides, water sector is tightly linked to the energy one in MENA region, whether it is fossil or renewable energy, which offers more opportunities to research development.

I will work on these objectives by expanding IAHR branches through my professional network. Indeed, I took part in 2014-2016 to the USAID program 'Further Advancing the Blue Revolution Initiative' (FABRI-DAI), targeting the reinforcement of MENA Network of Water Centers Of Excellence (MENA NWC). I have also organized, in December 2018, the International Symposium on flash floods in MENA region in collaboration with Kyoto university, Japan, Gutch university in Oman, IAHR and many other partners.

Council Member - For North America region  
2 candidates for 1 position

**Prof. Marcelo H. Garcia**  
*University of Illinois at Urbana-Champaign, USA*



IAHR played a pivotal role in my career and I wish for this same experience for all of its members, particularly Millennials who will lead us in the future. I joined IAHR as a student member in 1985 during my graduate studies at St. Anthony Falls Hydraulics Laboratory, University of Minnesota. I hold the Geoffrey Yeh Chair in Civil Engineering and serve as Director of the Ven Te Chow Hydrosystems, University of Illinois at Urbana. Received Water Resources Engineering Diploma at Universidad Nacional del Litoral (UNL) in Santa Fe, Argentina, while working full-time on the Parana Medio Hydropower Project at Agua y Energia Elctrica (AyEE). First conference publication on the erosion of clays in the Parana River was at the IAHR Latin American Congress in Mexico (1982). First journal publication was in IAHR Journal of Hydraulic Research (1987). Since 2000, I have served as adviser for the IAHR Student Chapter at Illinois. I served as Editor of the Journal of Hydraulic Research, 2001 to 2006. and Editor-in-Chief of ASCE Manual of Engineering Practice 110 "Sedimentation Engineering," published by the American Society of Civil Engineers (2008). Participated in many conferences and in particular in most Latin American Congresses, except one, since 1994, giving keynote lectures and teaching short courses. Organized River, Coastal and Estuarine Morphodynamics (RCEM) Symposia and River Flow Conference. Recognized with IAHR Arthur Thomas Ippen and M.S. Yalin Lifetime Achievement Awards as well as ASCE Hunter Rouse and H.A. Einstein Awards. Member of National Academy of Engineering of Argentina.

**Prof. Ioan Nistor**  
*University of Ottawa, Canada*



I am a Professor of Hydraulic and Coastal Engineering at University of Ottawa, Canada, researching hazards associated with extreme loading on infrastructure. My work involves post-disaster forensic engineering surveys and experimental, numerical and analytical work. As a Voting Member of the ASCE Tsunami Effects and Loads Committee and of the JSCE Working Group 5 (Debris), I contribute to the development of new standards and design guidelines for flood-resistant infrastructure.

I worked with IAHR, first as Secretary and then Chair of the IAHR Coastal and Maritime Hydraulics Committee. My goal has been to strengthen the awareness and presence of IAHR in North and South America. As such, I organized and hosted in Ottawa, a first in the Americas, the 2016 Coastlab Conference, IAHR's premier coastal/maritime speciality conference. I have also been involved with several IAHR events: Chair - 2015 IAHR-COPRI Long Waves Symposium and Session Organizer/Chair for the 35th Congress (Chengdu), 36th Congress (Hague) and 37th Congress (Kuala Lumpur).

My personal experiences – growing up in Romania, obtaining my PhD in Japan, working as a consulting engineer (TECSULT-Montreal) in several African and Asian countries on water resources projects and, then, as an academic studying the impact of natural disasters on communities – have shaped my values and taught me that we are all inhabitants of one giant village. I pledge to my fellow IAHR members to: (1) continue to expand our reach and assistance in developing countries, (2) expand IAHR's presence in the Americas and (3) get young engineers involved with IAHR!



**International Association  
for Hydro-Environment  
Engineering and Research**

*Hosted by  
Spain Water and IWHR, China*

## SLATE OF CANDIDATES

Council Member - For Latin America region  
2 candidates for 1 position**Dr. Veronica Minaya**

Escuela Politécnica Nacional.  
Ecuador



I have a PhD in Eco-hydrology obtained at UNESCO-IHE and TUDelft in The Netherlands. Previously, I was working as a post-doc researcher at the Vrije University in Brussels, where I was involved in capacity development initiatives in the South, mainly Africa and South America. Currently, I am working as full-time lecturer in the Escuela Politécnica Nacional in Quito - Ecuador. My research interests include water resource management, water productivity and hydrological modeling.

During my PhD research back in 2015, I got actively involved in youth organizations, and founded the IAHR-YPN in Delft - aiming for cooperation between members and researchers/professionals from different institutions. At the same time, I was also a core member of the Water Youth Network, engaged and actively participated in several events in the water sector.

With a profound interest I have followed the many initiatives that IAHR is leading in the hydro-environment engineering and research field, I believe that getting involved as a Council Member would be a very rewarding next step. In general, I have been very interested in research development, and women and youth empowerment and I would love to bring this passion for inclusion, creativity, innovation, and capacity building to the IAHR.

**Prof. Andres Rodriguez**

Universidad Nacional de Cordoba.  
Argentina



I was born in Cordoba, Argentina in 1961. Civil Engineer, at National University Cordoba UNC, Argentina, 1985 Ph.D. Marine Sciences, Politechnical University Catalonia UPC, Spain, 1997 Pos-Doctoral stage, UPValencia, Spain, 2000.

Full Professor, 1997-2018, UNC Director/codirector 27 of Master/Doctoral thesis.

Principal Researcher, CONICET, 2000-present.

Associate Professor, Laboratory Maritime Engineering, UPC, Barcelona, 1991-1997. Associate Researcher, National Water Institute, 1997-present.

Director Hydraulics Laboratory UNC, 1997-present.

President Superior Institute Water Resources ISRH, UNC, 2002-2007

National Director Water Resources, Arg., 2006/2015

Director SINARAME, meteorological radar Network Argentina, 2009-2015

Expertise in fluvial hydraulics, experimental/numerical hydrodynamics, maritime engineering, water quality and radar hydro-meteorology.

National prize Engineering National Academy, 2000.

Autor/coauthor: 64 peer reviewed papers, 14 book chapters, 6 books, 29 technical notes, over 200 conference presentations and 1 patent.

Coordinator, Cordoba HidroMeteorological Observatory, since 2017.

Member IAHR since 1986,  
Papers IAHR World Congress: 3  
Papers IAHR LAD Regional Congress Conferences: 31  
Main Organization Com. Member of 2000 Latin American IAHR Congress  
Member of Scientific Com. of several Latin American IAHR Congress  
Invited Professor of IAHR LAD Pre-congress Courses  
Reviewer of 38th IAHR Congress, Panama.

Vision and goals:  
Increase the diffusion of LAD activities to the international community  
Increase the youth participation in IAHR activities,  
Increase the diffusion of IAHR in social-tech. networks  
Guide and focus IAHR activities to world requirements.

Council Member - For Europe region  
2 candidates for 1 position**Prof. Amparo López Jiménez**

Universidad Politécnica de Valencia.  
Spain



I gained the qualification of Industrial Engineer at the Universitat Politècnica de València and my PhD in the Department of Hydraulic and Environment Engineering (UPV, Spain). Actually, I am Full Professor of Hydraulic Engineering at the higher Technical School of Industrial Engineering, and Director of my department. Since 1997, I have taught and researched in fluid mechanics, hydraulic machinery and dispersion of pollutants. I have worked in more than 50 projects or research contracts and I am author of 90 articles in magazine, among other research activities.

I was involved with IAHR since 1996, when I participated in my first Symposium on Hydraulic Machinery and Cavitation. Since then, I have been participating in IAHR meetings and organizing workshops and seminars. I am also part of the Spanish Chapter of IAHR and I participate in the IAHR Europe Regional Division Leadership Team 2018-2020. Actually, I am Associated Editor of Ribagua, our IAHR Journal in Spanish.

I am an enthusiastic person, and I would contribute to IAHR with my professional experience as well as my proactive attitude. In my opinion, the future of hydraulic and environmental engineering involves an integral management of water at any scale, as it is a benefit not only economic in the long term, but also environmental and social, as indicated by the Sustainable Development Objectives of the UN, in which hydraulic and environmental engineers we are completely questioned. IAHR must strongly lead this involvement with any action focused on diffusion, networking and research in our field.

**Prof. Jorge Matos**

University of Lisbon.  
Portugal



I am a professor at the Department of Civil Engineering, Architecture and Georesources of the Instituto Superior Técnico (IST), University of Lisbon, where I earned the M.Sc. in Hydraulics and Water Resources and the Ph.D. in Civil Engineering. My primary research field is hydraulic structures. In recent years, I have been involved in the coordination of the KIC-InnoEnergy Master Programme on Energy Technologies at the IST.

I joined IAHR in 1987, during the biennial Congress in Lausanne. My participation in this event has shaped my involvement with the Association, where I have had the privilege to contribute, namely on the establishment of the Hydraulic Structures Committee, in 1998, in which I later served as Secretary, Chair, and Past Chair (2003-11). More recently, I took part of the Hydro-Environment Division's team, as Secretary (2011-15). At the Portuguese Water Resources Association (APRH), I am a member of the General Council since 2004, having served as President of the Executive Committee (2008-09).

If elected, I will work closely with the Council to carry out actions envisaged in the strategic plan, such as: stimulate the engagement of young professionals and students in the Association; develop synergies with peer associations, namely by promoting co-sponsorship of specialist conferences; strengthen the links with regional divisions and committees; contribute to the consolidation of international symposia and junior researcher and engineer workshops; promote intercultural cooperation and collaboration between research and practice communities; in short, actively collaborating to reach the vision of the IAHR, in this fascinating time of change.







Prince Sultan Bin Abdulaziz  
International Prize for Water

Recognizing Innovation

Invitation for Nominations

**9<sup>th</sup> Award  
(2020)**

**Nominations open online  
until 31 December 2019**



Creativity  
Prize



Surface Water  
Prize



Groundwater  
Prize



Alternative Water  
Resources Prize



Water Management &  
Protection Prize

[www.psipw.org](http://www.psipw.org)

e-mail: [info@psipw.org](mailto:info@psipw.org)