

1999

Beyond the Formalism Debate: Expert Reasoning, Fuzzy Logic, and Complex Statutes

Edward Adams

University of Minnesota Law School, adams006@umn.edu

Daniel Farber

Follow this and additional works at: https://scholarship.law.umn.edu/faculty_articles



Part of the [Law Commons](#)

Recommended Citation

Edward Adams and Daniel Farber, *Beyond the Formalism Debate: Expert Reasoning, Fuzzy Logic, and Complex Statutes*, 52 VAND. L. REV. 1243 (1999), available at https://scholarship.law.umn.edu/faculty_articles/827.

This Article is brought to you for free and open access by the University of Minnesota Law School. It has been accepted for inclusion in the Faculty Scholarship collection by an authorized administrator of the Scholarship Repository. For more information, please contact lenzx009@umn.edu.

Beyond the Formalism Debate: Expert Reasoning, Fuzzy Logic, and Complex Statutes

Edward S. Adams, Daniel A. Farber

52 Vand. L. Rev. 1243 (1999)

Formalists and antiformalists continue to debate the utility of using legislative history and current social values to interpret statutes. Lost in the debate, however, is a clear model of how judges actually make decisions. Rather than focusing on complex problems presented by actual judicial decisions, formalists and antiformalists concentrate on stylized examples of simple statutes.

In this Article, Professors Adams and Farber construct a more functional model of judicial decisionmaking by focusing on complex problems. They use cognitive psychological research on expert reasoning and techniques from an emerging area in the field of artificial intelligence, fuzzy logic, to construct their model. To probe the complex interactions between judicial interpretation, the business and legal communities, and the legislature, the authors apply their model to two important bankruptcy cases written by prominent formalist judges.

Professors Adams and Farber demonstrate how cognitive psychology and fuzzy logic can reveal the reasoning processes that both formalist and antiformalist judges use to interpret complex statutes. To apply formalist rules, judges need to recognize the aspects of a case that trigger relevant rules. Cognitive psychologists have researched expert reasoning using this type of diagnostic process. Once the judge identifies the appropriate rules, she will often find they point in conflicting directions. Fuzzy logic provides a model of how to analyze such conflicts.

Next, Professors Adams and Farber consider how these models of judicial decisionmaking inform efforts to improve statutory interpretation of complex statutes. They reason that expert decisionmaking builds on pattern recognition skills and fuzzy maps, both the result of intensive repeated experience. The authors explain that cases involving complex statutory interpretation frequently involve competing considerations, and that the implicit understandings of field "insiders" tend to be entrenched and difficult to displace. Consequently, Professors Adams and Farber argue that judges in specialty courts, such as the Bankruptcy Courts, are probably in a better position than generalist appellate judges to interpret complex statutes. Generalist judges should approach complex statutory issues with a strong degree of defer-

ence to the "local culture" of the field.

Professors Adams and Farber conclude the Article with speculation on how fuzzy logic could be used in a more quantitative way to model legal problems. They note that computer modeling may ultimately provide insight into the subtle process of judicial practical reasoning, moving away from the false dichotomy often drawn between formalist and antiformalist approaches to practical judicial decision-making.

Beyond the Formalism Debate: Expert Reasoning, Fuzzy Logic, and Complex Statutes

*Edward S. Adams**
*Daniel A. Farber***

I.	LEVIT V. INGERSOLL RAND FINANCIAL CORP. (DEPRIZIO) AND BFP V. RESOLUTION TRUST CORP.	1247
	A. Sections 547 and 548: A Primer	1247
	B. Deprizio	1252
	1. Reaction to <i>Deprizio</i>	1260
	2. Congress's Response: The 1994 Bankruptcy Reform Act	1266
	C. BFP v. Resolution Trust Corp.	1268
II.	A FORMALIST'S GUIDE TO PRACTICAL REASONING AND FUZZY LOGIC	1280
	A. "Judgment Calls" and the Formalist Judge	1280
	B. Analyzing Legal Problems: Practical Reasoning and Expert Judgment	1284
	C. Applying Legal Rules: Fuzzy Logic and Its Applications	1289
	1. Basic Principles	1290
	2. Fuzzy Cognitive Maps	1297
	3. Using an FCM to Simulate <i>Deprizio</i>	1299
	4. Adaptive Fuzzy Systems and Neural Networks	1310

* Associate Dean for Academic Affairs, Julie E. Davis Chair 2nd Professor of Law, and Director of the Center for Law and Business Studies at the University of Minnesota; Of Counsel, Fredrikson & Byron, P.A.; Principal, Jon Adams Financial Co. L.L.P.; B.A., 1985, Knox College; J.D., 1988, University of Chicago; M.B.A., 1997, University of Minnesota. Our thanks to David P. Bryden, Jim Chen, Philip P. Frickey, Richard S. Frase, Michael S. Paulsen, E. Thomas Sullivan, and Susan M. Wolf for their many useful suggestions and advice regarding this piece. Thanks also to Paul Bunge, Stacey Drentlaw, Chris Hofstad, and Scott Korzenowski for their able research assistance. Any mistakes that remain are our own.

** Associate Dean for Faculty Research and Development and Henry J. Fletcher Professor of Law, University of Minnesota Law School.

5.	Fuzzy Formalism.....	1312
III.	INTERPRETING COMPLEX STATUTES IN A FUZZY WORLD ...	1315
A.	<i>Deferring to "Front-line" Interpreters</i>	1315
B.	<i>Living with Ambiguity</i>	1317
C.	<i>Statutory Cultures</i>	1318
IV.	CONCLUSION	1322
	APPENDIX I.....	1324
	APPENDIX II.....	1331
	APPENDIX III	1334
	APPENDIX IV	1337

Tinkering with [] an interconnected system without really knowing how the modification will affect the overall operation can result in strange, unexpected outcomes; it can even result in a counterproductive or unjust system.¹

Judges tinker with the legal system all the time. Frequently forced to apply statutes in factual situations never dreamt of by the drafters of such legislation, judges labor to make the relevant statutory language "fit" the case at issue. The results of such tinkering or interpretation vary widely. Sometimes such tinkering produces outcomes that are both unintended and unacceptable, leading to disastrous results. Other times judges, like the rest of us, get it right.

Statutory interpretation is currently the subject of a lively scholarly debate. Should judges render a decision based merely on the words of the text before them or should they go one step further and attempt to discern the purpose of the legislation at issue? Is it legitimate for them to consult current social values? On one side of the debate are formalists, who eschew legislative history and current social values while being suspicious of the concept of statutory purpose. On the other side are antiformalists, who prefer to downplay textual arguments in favor of these other sources of guidance. Antiformalists endorse "practical reason"—meaning reliance on complex judgments regarding text, purpose, legal context, and societal norms.²

Although this is an important debate, the dispute between these viewpoints has obscured significant aspects of statutory interpretation while highlighting others. As a result, analysis of statutory

1. Hon. Leif M. Clark, *Fuzzy Thinking and Legislating Logically*, 12 AM. BANKR. INST. J. 14, 14 (1994). This comment was in response to an article that proposed to abolish Chapter 11.

2. For further explanation of practical reasoning, see *infra* Part II.B.

interpretation has been skewed.³ First, the debaters have focused on the differences between formalism and antiformalism (or “practical reasoning”), ignoring considerable areas of overlap. Second, much of the discussion has involved stylized examples, often in the context of fairly simple statutes, rather than the complexities presented by actual judicial decisions under complicated modern statutory schemes. Third, neither side has a very clear model of the process that judges actually use to make decisions. This Article is intended to move beyond the current debate about formalism by focusing on these issues.

This Article seeks to provide more functional models of judicial decisionmaking. Normally, formalists and antiformalists alike resort to “hand waving” when seeking to describe the judge’s cognitive process. This Article will attempt to provide some substance to its description of this process by referring to work by cognitive psychologists on expert judgments and to an emerging field known as fuzzy logic. The latter term—which sounds like a professor’s disparagement of an inept first-year student—requires a brief explanation.

What is fuzzy logic? To understand fuzzy logic, one must first consider its historical antecedents. As early as Aristotle, most theories of logic have been bivalent.⁴ Bivalent set theory states that an object “cannot belong to both a set and its complement set or to neither of the sets.”⁵ Computer systems, for example, respond to rules comprised of combinations of the numbers one or zero.⁶ In the real world, bivalent logic can be limiting because it does not recognize that something may fail to be *either* A or non-A; it may be partially A and partially non-A. In contrast, fuzzy logic⁷ recognizes this possibility, which seems more descriptive of the realities of legal decision-making. Pioneered in 1965 by Lotfi Zadeh, fuzzy logic⁸ recognizes that some-

3. For a brief summary of the current debate, see ABNER J. MILEVA & ERIC LANE, AN INTRODUCTION TO STATUTORY INTERPRETATION AND THE LEGISLATIVE PROCESS 23-34, 50-54 (1997). For a more extensive discussion, see WILLIAM N. ESKRIDGE, DYNAMIC STATUTORY INTERPRETATION 107-204 (1994).

4. See *The Logic That Dares Not Speak Its Name*, ECONOMIST, Apr. 16, 1994, at 89.

5. Bart Kosko & Satoru Isaka, *Fuzzy Logic*, SCI. AM., July 1993, at 76.

6. See Suzanne Long, *Fuzzy Logic In Focus*, HEMISPHERES, Dec. 1994, at 101.

7. See Kosko & Isaka, *supra* note 5, at 77. The term “fuzzy logic” refers to “any mathematical or computer system that reasons with fuzzy sets.” *Id.*

8. As a science, fuzzy logic has its roots in philosophy and traditional logic. Recognition that logic could consist of multiple values has its roots in work originally done by Bertrand Russell at the beginning of the century. Russell recognized that language is inherently vague. He further noted that vagueness itself was a matter of degree. See DANIEL MCNEILL & PAUL FREIBERGER, FUZZY LOGIC 29 (1993). Nonetheless, it was Polish logician and philosopher Jan Lukasiewicz who first developed a form of fuzzy sets. He did this by introducing the value 1/2 to

thing may be partially in one set while partially in another. In essence, fuzzy logic allows for *multivalent* levels of validity.⁹

Fuzzy logic, as well as studies of expert reasoning, shows its power best in complex situations. As noted earlier, much of the scholarly literature about statutory interpretation fails to come to grips with the full complexity of many modern statutory cases. Rather than resorting to capsule versions of cases, this Article will consider two important bankruptcy cases in-depth. Part I of this Article examines two celebrated, recent bankruptcy decisions which utilize different varieties of formalism. Two leading formalists, Justice Antonin Scalia and Judge Frank Easterbrook wrote the opinions. Specifically, Part I analyzes and critiques the Seventh Circuit decision in *Levit v. Ingersoll Rand Financial Corp. (Deprizio)*¹⁰ and the Supreme Court's decision in *BFP v. Resolution Trust Corp.*,¹¹ which utilize different varieties of formalism. Through an in-depth analysis of these cases, we probe the complex interactions between judicial interpretation, the business and legal communities, and the legislature.

Part II shows how cognitive psychology and fuzzy logic can illuminate the reasoning processes used by formalist and anti-formalist judges alike. In order to apply formalist rules, judges need to recognize the aspects of a case that trigger relevant rules. Cognitive psychologists have researched expert reasoning using this type of diagnostic process. Once the judge has identified the appropriate rules, she may find that they point in conflicting directions. Fuzzy logic provides a model of how to analyze such conflicts.

Part III considers how these models of judicial decision-making might inform efforts to improve statutory interpretation of complex statutes like the Bankruptcy Code. Specifically, this Article argues that expert decisionmaking builds on pattern recognition skills and fuzzy maps, both the result of intensive repeated experience. Consequently, bankruptcy judges are probably in a better position than generalist appellate judges to maneuver among the complexities of

the traditional values of 1 and 0, which recognized that, in addition to A and non-A, something might be partially A or partially non-A. This opened the door to inserting an infinite number of values between 1 and 0. See *id.* at 29-31. It was not until 1965, however, when Lotfi Zadeh published *Fuzzy Sets* that modern fuzzy set theory was created. Using the work of Russell and Lukasiewicz, Zadeh further recognized that something could belong to some extent in one set as well as another. Based on these assumptions, he developed a mathematical formula for fuzzy sets. See generally Lotfi A. Zadeh, *Fuzzy Sets*, 8 INFO. & CONTROL 338-353 (1965). Most work currently being done utilizing fuzzy logic originated with this groundbreaking work.

9. See *The Logic That Dares Not Speak Its Name*, *supra* note 4, at 89.

10. *Levit v. Ingersoll Rand Fin. Corp. (Deprizio)*, 874 F.2d 1186 (7th Cir. 1989).

11. *BFP v. Resolution Trust Corp.*, 511 U.S. 531 (1994).

the Code and to accommodate the values and interests at stake. Also, because of the complexity of these statutory schemes and of the corresponding fuzzy cognitive maps, judges would do well to acknowledge that competing considerations are involved in almost every interesting case. The implicit understandings of bankruptcy "insiders," both in the legislative process and in bankruptcy practice and adjudication, are strongly entrenched and difficult to displace. In short, generalist judges should approach bankruptcy issues with a strong degree of deference to the "local culture" of the field.

This Article closes with some speculation about how fuzzy logic could be used in a more quantitative way to model legal problems. Although the efforts presented in this Article are quite preliminary, they suggest ground for hope that computer modeling may ultimately provide insight into the subtle process of judicial practical reasoning.

I. *LEVIT V. INGERSOLL RAND FINANCIAL CORP. (DEPRIZIO)*
AND *BFP V. RESOLUTION TRUST CORP.*

A. *Sections 547 and 548: A Primer*

A realistic appraisal of statutory interpretation requires the use of realistic examples, such as the Bankruptcy Code. For the non-bankruptcy specialist, some background on the relevant code provisions may be useful.

Bankruptcy law aims to distribute the bankruptcy estate to the debtor's creditors and equity-holders in an order that corresponds to the prescribed hierarchy of classes.¹² Prior to bankruptcy, creditors often rush to collect their claims or to receive payments in order to avoid this prescribed hierarchy. This rush to payment increases the likelihood of the debtor's bankruptcy, reduces the assets available for distribution, and undermines bankruptcy law's primary goals of order and equality of distribution.¹³

To prevent this "rush to payment," the Bankruptcy Code "grants the trustee or the debtor in possession certain avoiding or avoidance powers."¹⁴ These powers "allow the trustee or debtor in

12. See 11 U.S.C. § 726 (1994).

13. See 1 DAVID G. EPSTEIN ET AL., *BANKRUPTCY* § 6-3, at 278 (1993).

14. Steve H. Nickles & Edward S. Adams, *Tracing Proceeds to Attorneys' Pockets (and the Dilemma of Paying for Bankruptcy)*, 78 MINN. L. REV. 1079, 1109 (1994). See 11 U.S.C. §§ 544 (trustee as a hypothetical lien creditor and bona fide purchaser and as successor to actual creditors); 545 (statutory liens); 546(c) (reclamation); 547(b) (preferences); 548(a) & (b) (fraudulent transfers and obligations); 549(a) (postpetition transfers); and 553(a) (b) (setoff) (1994).

possession to undo and recover some prebankruptcy transfers of the debtor's property and most postbankruptcy transfers of the estate's property."¹⁵ In turn, the trustee either distributes this recovered property to unsecured creditors and equity-holders according to the Code's priority scheme or gives it to the requisite secured party if it is secured collateral. *Deprizio* addresses § 547(b)¹⁶ of the Code, which allows the trustee to avoid "a transfer of the debtor's property on the eve of bankruptcy to satisfy an old debt,"¹⁷ and § 550(a)¹⁸ of the Code, which allows a recovery of a preferential pre-petition transfer. *BFP v. Resolution Trust Corp.*¹⁹ addresses § 548²⁰ of the Code, which empowers the trustee to avoid a fraudulent transfer of the debtor's property.

15. Nickles & Adams, *supra* note 14, at 1109.

16. Section 547(b) provides:

Except as provided in subsection (c) of this section, the trustee may avoid any transfer of an interest of the debtor in property—

- (1) to or for the benefit of a creditor;
- (2) for or on account of an antecedent debt owed by the debtor before such transfer was made;
- (3) made while the debtor was insolvent;
- (4) made
 - (A) on or within 90 days before the date of the filing of the petition; or
 - (B) between ninety days and one year before the date of the filing of the petition, if such creditor at the time of such transfer was an insider; and
- (5) that enables such creditor to receive more than such creditor would receive if—
 - (A) the case were a case under chapter 7 of this title;
 - (B) the transfer had not been made; and
 - (C) such creditor received payment of such debt to the extent provided by the provisions of this title.

11 U.S.C. § 547(b) (1994). This is § 547(b) as amended in 1984. The version in force in 1983, which applied to the *Deprizio* case, applied the year-long voidable preference section only if the requirement of § 547 (b)(4)(B)(ii) was met, which required the insider to have "reasonable cause to believe the debtor was insolvent at the time of such transfer." *Levit v. Ingersoll Rand Fin. Corp.* (*Deprizio*), 874 F.2d 1186, 1189 (7th Cir. 1989) [hereinafter *Deprizio*].

17. Elizabeth A. Orelup, Note, *Avoidance of Preferential Transfers Under the Bankruptcy Reform Act of 1978*, 65 IOWA L. REV. 209, 214-215 (1979).

18. Section 550(a) provides:

Except as otherwise provided in this section, to the extent that a transfer is avoided under section 544, 545, 547, 548, 549, 553(b), or 724(a) of this title, the trustee may recover, for the benefit of the estate, the property transferred, or, if the court so orders, the value of such property, from

- (1) the initial transferee of such transfer or the entity for whose benefit such transfer was made; or
- (2) any immediate or mediate transferee of such initial transferee.

11 U.S.C. § 550(a) (1994).

19. *BFP v. Resolution Trust Corp.*, 511 U.S. 531, 535-36 (1994).

20. Section 548 provides in relevant part:

Subject to the requirements of § 547(b) of the Code, a trustee or debtor in possession can “avoid”²¹ any transfer²² of the debtor’s estate that “prefers” one creditor over another.²³ Under § 547(b)(4), the trustee may only recover those transfers made within 90 days before the filing of the bankruptcy petition unless the transfer was made to an “insider,”²⁴ in which case the period is extended to one

(a)(1) The trustee may avoid any transfer of an interest of the debtor in property, or any obligation incurred by the debtor, that was made or incurred on or within one year before the date of the filing of the petition, if the debtor voluntary or involuntary--

- (A) made such transfer or incurred such obligation with actual intent to hinder, delay, or defraud any entity to which the debtor was or became, on or after the date that such transfer was made or such obligation was incurred, indebted; or
- (B)
 - (i) received less than a reasonably equivalent value in exchange for such transfer or obligation; and
 - (ii) (I) was insolvent on the date that such transfer was made or such obligation was incurred, or became insolvent as a result of such transfer or obligation . . .

11 U.S.C. § 548 (1994).

21. In bankruptcy, “avoid” means the power given to a bankruptcy trustee to set aside any transaction that is improper.

22. The Code defines “transfer” as “every mode, direct or indirect, absolute or conditional, voluntary or involuntary, of disposing of or parting with property or with an interest in property, including retention of title as a security interest and foreclosure of the debtor’s equity of redemption.” 11 U.S.C. § 101(54) (1994).

23. See 11 U.S.C. § 547(b) (1994). A preference is any transfer of the debtor’s property on the eve of or in contemplation of bankruptcy which satisfies an old debt.

24. Section 101(31) of the Code defines an “insider” to include:

- (A) if the debtor is an individual--
 - (i) relative of the debtor or of a general partner of the debtor;
 - (ii) partnership in which the debtor is a general partner;
 - (iii) general partner of the debtor; or
 - (iv) corporation of which the debtor is a director, officer, or person in control;
- (B) if the debtor is a corporation--
 - (i) director of the debtor;
 - (ii) officer of the debtor;
 - (iii) person in control of the debtor;
 - (iv) partnership in which the debtor is a general partner;
 - (v) general partner of the debtor; or
 - (vi) relative of a general partner, director, officer, or person in control of the debtor;
- (C) if the debtor is a partnership--
 - (i) general partner of the debtor;
 - (ii) relative of a general partner, director or officer person in control of the debtor;
 - (iii) partnership in which the debtor is a general partner;
 - (iv) general partner of the debtor; or
 - (v) person in control of the debtor;
- (D) if the debtor is a municipality, elected official of the debtor or relative of an elected official of the debtor;

year.²⁵ Since the Code bifurcates the treatment of avoidance and recovery issues, once a transfer is found to be preferential under § 547, § 550 identifies the parties from whom the trustee or debtor in possession can recover the transfer.²⁶ Section 550(a) permits the trustee to recover the transfer from the "initial transferee" or from any "entity for whose benefit such transfer was made."²⁷

Bankruptcy Code § 548 allows a trustee to avoid a fraudulent transfer²⁸ of the debtor's property, or any obligation the debtor fraudulently made or incurred within one year prior to filing the bankruptcy petition.²⁹ Section 548 contains provisions similar to the Uniform Fraudulent Conveyance Act ("UFCA") and the Uniform Fraudulent Transfers Act ("UFTA"). These two Acts condemn transfers that are both actually and constructively fraudulent.³⁰ An actual fraudulent transfer occurs under § 548 when the debtor acts "with actual intent to hinder, delay, or defraud any entity to which the debtor was . . . indebted."³¹ Since direct evidence of requisite intent is rarely available, courts have accepted circumstantial evidence, in the form of badges of fraud, as sufficient.³² Although the trustee bears the burden of proof, "certain combinations of these badges of fraud create [] a presumption of fraudulent intent, shifting the burden of

(E) affiliate, or an insider of an affiliate as if such affiliate were the debtor;
and

(F) managing agent of the debtor.

11 U.S.C. § 101(31) (1994).

25. Section 547 strives to discourage creditors "from racing to the courthouse to dismember the debtor during his slide into bankruptcy" in order to "facilitate the primary bankruptcy policy of equality of distribution among creditors of the debtor. Any creditor that received a greater payment than others of its class is required to disgorge so that all may share equally." H.R. REP. NO. 95-595, at 177-78 (1978), *reprinted in* 1978 U.S.C.C.A.N. 5963, 6138.

26. See *supra* note 18 for the text of § 550(a).

27. 11 U.S.C. § 550(a) (1994).

28. See *supra* note 22 for the definition of "transfer" in the Code. For the purposes of § 548, the term includes not only a sale, gift or other absolute, voluntary conveyance of the debtor's interest in property, but various other dispositions as well. See Nickles & Adams, *supra* note 14, at 1115-16 n.148.

29. See 11 U.S.C. § 548(a) (1994).

30. "Until 1918, American jurisdictions either recognized the Statute of Elizabeth [13, Chapter 5 (condemned any conveyance of property made with the intent "to delay, hinder or defraud creditors")] as part of their inherited common law or enacted identical or very similar versions of it." Nickles & Adams, *supra* note 14, at 1114. The UFTA and the UFCA cover transfers the debtor made with the intent to defraud (actually fraudulent) and those transfers that are irrespective of the debtor's intent if the court deems such transfers to be unfair to the debtor's creditors (constructively fraudulent).

31. Nickles & Adams, *supra* note 14, at 1117 (quoting 11 U.S.C. § 548(a)(1) (1988)). The debt may have arisen on or after the date of the transfer at issue. See *id.*

32. See *id.* at 1117.

proof to the transferee to establish the lack of any actual fraudulent intent.”³³

Alternatively, a transfer is constructively fraudulent when the debtor made the transfer for less than “reasonably equivalent value”³⁴ and the debtor was or thereby became insolvent;³⁵ was engaged in business with unreasonably small capital;³⁶ or intended to incur debts that would exceed her ability to pay.³⁷ The purpose of § 548 is manifestly simple: to protect a debtor’s other creditors from unfair reductions in the debtor’s estate.³⁸

The Seventh Circuit’s landmark decision in *Deprizio*³⁹ expanded the scope of § 547 preference provisions to include payments made by the debtor to one of its lenders an entire year before the filing of the bankruptcy petition, if the loan was guaranteed by an insider of the debtor company. The more controversial aspect of the case centers on the court’s formalist approach to § 550(a) which, through the court’s literal reading of the section, allowed the trustee to seek a recovery not only from the inside guarantors of these loans, but also from the lenders who received the payments as well.⁴⁰

Prior to the Supreme Court’s decision in *BFP*,⁴¹ courts had struggled to develop a framework to ascertain “reasonably equivalent value” under § 548(a)(2).⁴² In a triumph for mortgage lenders, *BFP*

33. *Id.* at 1118.

34. “In deciding whether something the debtor received in exchange for a transfer is ‘reasonably equivalent value,’ the court must determine whether the debtor received ‘value’ and, if so, how the value received compared to the property that she transferred or the obligation she incurred in exchange therefor.” Nickles & Adams, *supra* note 14, at 1118 n.155. Section 548 defines “value” as “property, or satisfaction or securing of a present or antecedent debt of the debtor, but does not include an unperformed promise to furnish support to the debtor or to a relative of the debtor.” 11 U.S.C. § 548(d)(2)(A) (1994).

35. See 11 U.S.C. § 548(a)(2)(B)(i) (“insolvent on the date that such transfer was made or such obligation was incurred, or became insolvent as a result of such transfer or obligation”).

36. See 11 U.S.C. § 548 (a)(2)(B)(ii).

37. See 11 U.S.C. § 548 (a)(2)(B)(iii).

38. As a result of this protection, creditors “need not monitor debtors so closely, and the savings in monitoring costs make businesses more productive.” Nickles & Adams, *supra* note 14, at 1121 (quoting *Bonded Fin. Servs., Inc. v. European Am. Bank*, 838 F.2d 890, 892 (7th Cir. 1988)).

39. *Levit v. Ingersoll Rand Fin. Corp. (Deprizio)*, 874 F.2d 1186, 1197, 1200-01 (7th Cir. 1988).

40. See *id.* at 1196-97.

41. *BFP v. Resolution Trust Corp.*, 511 U.S. 531 (1994).

42. The circuits had adopted one of the following three approaches: *Durrett v. Washington Nat’l Ins. Co.*, 621 F.2d 201, 203 (5th Cir. 1980) (establishing a price bid at foreclosure sale to be at least 70 percent of the property’s fair market value) [hereinafter “*Durrett* approach”]; *Lawyers Title Ins. Corp. v. Madrid (In re Madrid)*, 21 B.R. 424, 427 (B.A.P. 9th Cir. 1982), *aff’d on other grounds*, 725 F.2d 1197 (9th Cir. 1984) (establishing a price received at a regularly conducted foreclosure sale is conclusively presumed to be reasonably equivalent value) [hereinafter

established a bright-line rule that the price received at a noncollusive, properly conducted foreclosure sale conclusively establishes reasonably equivalent value for the purposes of § 548.⁴³ The Court rejected fair market value as a benchmark for evaluating mortgage-foreclosure sales under § 548 based upon the text of the Code and the market conditions present at the forced sale of property.

A more detailed analysis of these celebrated cases follows below. Because our goal is to explore the interpretation of complex statutory problems, we will examine the ramifications of each in detail.

B. Deprizio

In April 1983, the V.N. Deprizio Construction Company filed for bankruptcy protection under Chapter 11 of the Code.⁴⁴ Shortly thereafter, the proceeding converted to a Chapter 7 liquidation and a trustee was appointed.⁴⁵ At the time of the filing, the debtor had several groups of creditors.⁴⁶ First, the debtor had borrowed money from various lenders. Richard Deprizio, the debtor's president, and his brothers Robert and Edward, all insiders⁴⁷ of the company, personally guaranteed some of Deprizio's debts to these lenders.⁴⁸ Second, when the debtor fell behind in its payments to the employee pension and welfare funds, it executed notes in the funds' favor secured by a junior lien on the debtor's assets that Richard Deprizio co-signed. Third, the debtor was delinquent in the payment of withholding taxes to the Internal Revenue Service. The year prior to the filing of bankruptcy the debtor made a number of payments to each of these creditors.⁴⁹

"Madrid approach"]; *Bundles v. Baker (In re Bundles)*, 856 F.2d 815, 825 (7th Cir. 1988) (bankruptcy court should make a case-by-case determination of reasonable equivalency by weighing all the relevant facts) [hereinafter "*Bundles* approach"].

43. See *BFP*, 511 U.S. at 549.

44. See *Levit v. Ingersoll Rand Fin. Corp. (Deprizio II)*, 86 B.R. 545, 549 (N.D. Ill. 1988).

45. See *id.*

46. See *id.*

47. See *supra* note 24 for the text of § 101(31) of the Code defining insider.

48. See *Deprizio II*, 86 B.R. at 549.

49. The scope of this Article is limited to the Seventh Circuit's holding concerning the Lender Creditors and the Trustee's right to recover payments made to them by the Debtor. The Seventh Circuit found that there could be no recovery under § 550(a) for payment of delinquent taxes made to the IRS more than ninety days before the filing of bankruptcy, because even though the insiders of the company may be held liable for the company's failure to pay taxes, they were not creditors of Deprizio because they held no right to reimbursement from the company. Concerning the Trustee's claim against the Funds, the court held that there could be recovery of payments made by the Debtor but only to the extent that state law allowed it. The

When the case was converted to a Chapter 7 proceeding, the trustee, asserting his power to avoid preferential transfers and recover their value for the estate, brought an adversary proceeding against the creditors. He sought a declaratory judgment that any payments made between ninety days and one year prior to the filing of the bankruptcy petition to the creditors were voidable preferences under § 547.⁵⁰ To succeed in this proceeding, the trustee had to show not only that the payments made to the creditors were preferential transfers under § 547, but also that § 550 allowed recovery of the payments from the parties. According to the trustee, the insiders, Richard, Edward, and Robert Deprizio, were actually creditors within the meaning of § 101(9)⁵¹ because they held a right to a contingent claim against the debtor. The trustee argued that the payments made to the lenders more than ninety days but less than one year preceding bankruptcy were voidable preferences, since every reduction in the amounts owed the lenders reduced the extent to which the insiders would be exposed on their guarantees.⁵² Thus, every payment was “for the benefit” of the insiders because it reduced the amount of reimbursement that the lenders could ultimately seek. The trustee further argued that § 550(a) allowed recovery of the preferential transfers directly from the initial transferees—in this case, the lenders.⁵³

The bankruptcy court dismissed the trustee’s action and held for the lenders.⁵⁴ The court focused on whether the payments made to the lenders, which indirectly benefited the insiders, created a prefer-

court remanded for further review. See *Levit v. Ingersoll Rand Fin. Corp. (Deprizio)*, 874 F.2d 1186, 1200 (7th Cir 1988).

50. See *In re V.N. Deprizio Const. (Deprizio III)*, 58 B.R. 478, 479 (Bankr. N.D. Ill. 1986).

51. Then § 101(9)(A) (now § 101(10)(A)) defined a “creditor” to mean an “entity that has a claim against the debtor that arose at the time of or before the order for relief concerning the debtor.” 11 U.S.C. § 101(9)(A) (1988) (current version at 11 U.S.C. § 101(10)(A) (1994)). A “claim” means a “right to payment, whether or not such a right is . . . contingent.” 11 U.S.C. § 101(4)(A) (1988) (current version at 11 U.S.C. § 101(5)(A) (1994)).

For example, XYZ Co. cannot meet the obligations it has to its lender. Since the lender has a guarantee from XYZ’s president, the lender may recover from the guarantor. At this point the guarantor, the president of XYZ Co., may seek recovery from XYZ Co. Therefore, a guarantor has a contingent claim against the debtor and is a “creditor” of the debtor under section 101(9)(A).

Virtually every court addressing the issue has so held. See, e.g., *In re Foland & Co.*, 55 B.R. 593, 594 n.3 (Bankr. E.D. Pa. 1985); *In re Big Three Transp., Inc.*, 41 B.R. 16, 19 (Bankr. W.D. Ark. 1983); *In re R.A. Beck Builder, Inc.*, 34 B.R. 888, 892 (Bankr. W.D. Pa. 1983).

52. See *Deprizio III*, 58 B.R. at 480.

53. Trustee relied for support for his position on *In re Big Three Transp., Inc.*, 41 B.R. 16, 21 (Bankr. W.D. Ark. 1983), which held that the unambiguous language of 11 U.S.C. § 550(a)(1) provides for the trustee’s right to recover for the non-insider creditor.

54. See *Deprizio III*, 58 B.R. at 480.

ential transfer that was recoverable under § 550 from the lenders.⁵⁵ The court adopted a two-transfer theory⁵⁶ approach to the issue, as relied upon in *In re Mercon Industries*.⁵⁷ The court viewed the single payment to the non-insider as effecting two transfers under the Code: one directly to the lenders in satisfaction of the primary indebtedness; and one indirectly to the insiders in satisfaction of their contingent liability. The bankruptcy court applied the voidable preference analysis under § 547(b) separately to each transfer. As the court noted, the transfer to the lenders was simply an ordinary transfer and thus the ninety-day preference period applied. More specifically, the court concluded that the lenders were not themselves insiders "at the time of such transfer" as required by statute in order to extend the preference period to one year from the filing of the petition.⁵⁸ The court did allow recovery of the monetary transfer under § 550(a) from the insiders because the indirect benefit they received was a preferential transfer under § 547(b).⁵⁹ Hence, the transfer was subject to the one-year expanded preference period which applies to "insiders."⁶⁰ The court held that § 550(a) limited the trustee's recovery "to the extent that a transfer is avoided under § 547."⁶¹ Since the transfers to the lenders were subject only to the ordinary ninety-day preference period, recovery under the expanded one-year preference period would be limited to the extent that the insiders benefited from the payments.⁶²

55. *See id.* at 480-81.

56. The two-transfer theory holds that the definition of transfer is broad enough to encompass that the satisfaction, partial or whole, of an insider guarantor's contingent claim against the debtor is *independent* of the transfer from the debtor to the lender who holds the guarantee. *See In re Mercon Indus., Inc.*, 37 B.R. 549, 552 n.3 (Bankr. E.D. Pa. 1984). Pursuant to this theory, the two separate transfers must each independently meet the elements of § 547(b) for the trustee to invoke her avoidance powers.

57. *Id.* at 551.

58. *See supra* note 16 for the text of § 547(b).

59. *See Deprizio III*, 58 B.R. at 480.

60. *Id.*

61. *Id.*

62. The court stated in dicta that even if the transfers to the lenders were found to be avoidable pursuant to § 547(b), the "weight of authority would not recognize the right of the trustee to recover from these creditors under § 550(a)" based upon the court's equitable powers. These decisions have for the most part relied on a passage from a leading bankruptcy treatise: in some circumstances, where a literal application of section 550(a) would permit the trustee to "recover from a party who acted merely as a conduit, the bankruptcy court should use its equitable powers to prevent an inequitable result." 5 COLLIER ON BANKRUPTCY ¶ 550.02, at 550-15 (15th ed. 1998). Other cases which considered the issue rely on the bankruptcy court's equitable powers to preclude the trustee from recovering from innocent creditors who were the initial transferees. *See, e.g., In re T.B. Westex Foods, Inc.*, 96 B.R. 77 (Bankr. W.D. Tex. 1989); *In re Midwestern Cos.*, 96 B.R. 224 (Bankr. W.D. Mo. 1988); *In re Aerco Metals, Inc.*, 60 B.R. 77 (Bankr. N.D. Tex. 1985); *In re R.A. Beck Builder, Inc.*, 34 B.R. 888 (Bankr. W.D. Pa. 1983); *In re*

On interlocutory appeal by the trustee, the district court reversed.⁶³ The court rejected the two-transfer approach of the bankruptcy court, and held both that: (1) the payments made to the lenders were preferential transfers under § 547(b) and subject to an extended reach back period of one year; and (2) the payments made by the debtor could be recovered under § 550(a) from the lenders as “initial transferees.”⁶⁴ The court relied on the broad definition of creditor in the Code, which includes guarantors.⁶⁵ The court reasoned that the debtor’s payments benefited both the lenders who received the payments and also those creditors who were guarantors.⁶⁶ Relying on the plain language of § 547(b)(4)(B), which expands the preference period when “such creditor” is an insider, the court found that “such creditor” refers back to § (b)(1)—the creditor to whom or for whose benefit the transfer occurred.⁶⁷

Turning to the issue of recoverability of the transfer, the district court found the two-transfer theory of the bankruptcy court contrary to the literal reading of § 547. The district court asserted that the bankruptcy court misconceived the nature of “transfer”⁶⁸ under the Code by defining it from the creditor’s point of view, equating it with “benefit received.”⁶⁹ Rather, the district court said that the Code defines “transfer” from the payor’s point of view regardless of the number of parties that may benefit from it.⁷⁰ Looking at the intent of Congress, the court found that if “Congress had wanted a transfer to occur whenever someone receive[d] a benefit, it could have defined ‘transfer’ as ‘receiving or acquiring property or an interest in property.’”⁷¹

Cove Patio Corp., 19 B.R. 843 (Bankr. S.D. Fla. 1982); *In re Duccilli Formal Wear, Inc.*, 18 B.R. 1180 (Bankr. S.D. Ohio 1982); *In re Church Buildings & Interiors, Inc.*, 4 B.R. 128 (Bankr. W.D. Mass. 1981).

63. See *In re V.N. Deprizio Constr. Co. (Deprizio II)*, 86 B.R. 545, 556 (N.D. Ill. 1988).

64. *Id.* at 551.

65. See *id.* at 550 (citing 11 U.S.C. § 101(9)(a) (1983) (containing the definition of “creditor”)).

66. *Id.*

67. Because in this case the debtor’s payment on debt guaranteed by Richard Deprizio was for the benefit of an insider, the court concluded that the expanded preference period applied. See *id.*

68. See *supra* note 22 for the definition of “transfer” in the Code.

69. The bankruptcy court considered there to be two transfers since there was a benefit to two parties: the Lender Creditors and the Insider Guarantors.

70. See *Deprizio II*, 86 B.R. at 551. The Code defines “transfer” as occurring when someone “dispos[es] of or part[s] with property or with an interest in property.” 11 U.S.C. § 101(54) (1994). See *supra* note 22 for the full text.

71. *Deprizio II*, 86 B.R. at 551.

Once the district court disposed of the two-transfer theory, it turned to § 550. The district court acknowledged prior authority,⁷² but refused to overlook the clear and unambiguous language of the section. It adopted a literal reading which "expressly recognize[d] that one transfer may benefit both an outsider creditor and an insider guarantor and permit[ted] recovery from either the 'initial transferee' or 'the entity for whose benefit the transfer was made.'" ⁷³ The court relied upon the minority view expressed by *In re Big Three Transportation, Inc.*⁷⁴

The district court went on to say, "[w]here Congress has crafted an unambiguous comprehensive statutory scheme, such as it has in the Code, we are extremely hesitant to tamper with that scheme by use of vague equitable powers."⁷⁵ According to the court, there was no inequity in forcing a creditor to return payments that it received only because the debtor had engaged in preferential behavior.⁷⁶ Further, since one of the purposes of a guarantee was to provide the lender a second pocket to recover from in the event of default, the court said that it "s[aw] nothing inequitable in requiring the creditor to pursue the guarantor once the debtor bec[ame] insolvent—indeed that [was] precisely what the creditor bargained for in obtaining the guarantee."⁷⁷

The Seventh Circuit, in an unanimous decision authored by Judge Easterbrook, affirmed the district court's decision, holding that payments made to the lenders by the debtor were subject to a year-long preference-recovery period under § 547(b)(4)(B), when those payments were for the benefit of insiders.⁷⁸ The court also affirmed the

72. See *id.* at 550-51 (citations omitted). The court recognized that the accepted majority view was that recovery could only be had from the insider based either on the two-transfer theory or the equitable approach theory.

73. *Id.*

74. The Arkansas Bankruptcy Court stated that the language in section 550(a)(1) was: susceptible of no other interpretation than the result reached herein. The drafters of the Code could very easily have omitted the 'initial transferee' language. Since they obviously did not, however, drafters of loan guaranty agreements will have to consider the literal meaning of § 550(a)(1) in advising their lending institution clients. *In re Big Three Transp. Inc.*, 41 B.R. 16, 21 (Bankr. W.D. Ark. 1983).

75. *Deprizio II*, 86 B.R. at 552.

76. See *id.* at 552-53. The non-insider creditors in this case only got paid because of the existence of the guarantee. According to the court it was reasonable to assume that when an insolvent company pays a guaranteed debt over its other debts, it is reasonable to presume that the motive is to benefit the guarantor.

77. *Id.* at 553. Even if the guarantor is now insolvent, the creditor bargains for and bears that risk at the time of the initial agreement and throughout the relationship.

78. See *Levit v. Ingersoll Rand Fin. Corp. (Deprizio)*, 874 F.2d 1186, 1200-01 (7th Cir. 1989). The court only affirmed the district court's decision as to the transfers made to creditors

district court's reading of § 550(a) that allowed the Trustee to recover the payment from the lender as an "initial transferee."⁷⁹

The Seventh Circuit began its analysis by pointing out that while no other appellate court had addressed the issue before it, several bankruptcy and district courts, as well as commentators, had.⁸⁰ Despite the apparent inequity that several courts and commentators had recognized in allowing a recovery from a non-insider creditor, the Seventh Circuit stated, an "ordinary" reading of the Code necessitated just such a conclusion.⁸¹ The court first addressed whether there was an avoidable preference under § 547. Easterbrook agreed with the trustee that, since the debtor's repayments to the lenders reduced the outstanding loan balances and diminished the degree to which these lenders could compel the insiders to honor their guarantees, these payments were "for the benefit" of the insiders.⁸² Accepting that the transfer to the lenders was preferential, and hence avoidable under § 547(b), the court then turned to § 550(a) to determine liability for repayment.⁸³

The Seventh Circuit, relying on the district court's reasoning, rejected the "two-transfer" theory as contrary to the clear language of

who had secured a personal guarantee from an insider. The court reversed as to the payments made to the employee plans and the federal government because there were no guarantees from insiders for these obligations.

79. *Id.*

80. *See id.* at 1188 (citations omitted). While acknowledging that the majority of courts refused to extend the preference period to one year for non-insider lenders who had guarantees from insiders based on either the two-transfer theory or the courts' equitable powers, the court affirmed the district court's following of the minority of courts because of its reliance on the text of the Code and congressional intent. The court does mention that the commentators are evenly divided upon the issue. Compare 4 COLLIER ON BANKRUPTCY ¶ 550.02, at 550-10 (15th. ed. 1998) and Vern Countryman, *The Trustee's Recovery in Preference Actions*, 3 BANKR. DEVS. J. 449, 464 (1986) (both saying "no" to extending the preference period on grounds of the perceived inequity of treating the diligent lender who took a guarantee from an insider differently than a lender who did not), with Isaac Nutovic, *The Bankruptcy Preference Laws: Interpreting Code Sections 547(c)(2), 550(a)(1) and 546(a)(1)*, 41 BUS. LAW. 175, 186-99 (1985), and Thomas E. Pitts, Jr., *Insider Guaranties and the Law of Preferences*, 55 AM. BANKR. L.J. 343 (1981) (both answering "yes" to extending the period).

81. *Deprizio*, 874 F.2d at 1198.

82. *Id.* at 1189 (relying on the interlocked sections of the Code: §§ 101(4)(A), 101(9), 547(b) and 550(a)).

83. *See id.* at 1190. The four requirements for a finding of an avoidable preference are: (1) insider—as defined in § 101(30); (2) benefit—the insider must have some form of personal liability (albeit contingent) on the debt being repaid that will be reduced by the debtor's repayments; (3) creditor—the insider, upon activation of its liability, must have a claim against the debtor; (4) lack-of-defenses requirement—the lender must not qualify for one of the § 547 defenses. The court noted that while § 547 distinguishes as to whether the Guarantor is an "insider," § 550 does not. Section 550(a) allows recovery from either "initial transferee" or the "entity for whose benefit such transfer was made." 11 U.S.C. § 550(a) (1994).

§ 550(a) and the definition of transfer in § 101(30).⁸⁴ The language in § 550(a) that limits a trustee to a recovery "to the extent that a transfer is avoided," the court said, is there simply to provide for those situations where less than the full amount of a transfer can be avoided and does not mean that a single payment can constitute multiple transfers.⁸⁵

Relying not just on the provision's literal meaning but also on a purpose approach, Easterbrook wrote, "[t]he trustee's power to avoid preferences . . . is essential to make the bankruptcy case a *collective* proceeding for the determination and payment of debts."⁸⁶ In the court's view, the trustee's avoiding powers served all the creditors in two ways:

first, they eliminate the benefit of attaching assets out of the ordinary course in the last 90 days before the filing, so that the rush to dismember a firm is not profitable from a creditor's perspective; second, the avoiding powers assure each creditor that if it refrains from acting, the pickings of anyone less civil will be fetched back into the pool.⁸⁷

The court concluded that the ninety-day preference period established by Congress was sufficient to allow reasonably alert lenders to protect themselves, but that in the case of insiders special problems arise due to the intimate knowledge they possess on the health of the business.⁸⁸ The court further found that the Trustee's ability to recover from the lenders ensured that the Trustee would determine the "ultimate distribution of the debtor's net assets" rather than the "efforts of insiders to protect their own interests."⁸⁹

In addition to relying on the text and purpose of the Code, Judge Easterbrook also examined the Code's legislative history for the meaning of "initial transferee" in § 550(a)(1). The court, along with the parties, drew different inferences from the legislative silence on the issue. The lenders argued that the silence evidenced congres-

84. *Deprizio*, 874 F.2d at 1195-96.

85. *Id.* The Lender Creditors argued that the language in § 550, "to the extent that a transfer is avoided under section . . . 547" means that § 547 recovery must be satisfied with respect to the party from whom recovery is sought under § 550. The Seventh Circuit saw no support for linkage between the two sections in the Code.

86. *Id.* at 1194.

87. *Id.* (citing Thomas H. Jackson, *Avoiding Powers in Bankruptcy*, 36 STAN. L. REV. 725, 727-31, 756-68 (1984)).

88. *See id.* This knowledge may be used to their advantage when paying off debts, thus disrupting the bankruptcy process if the preference period is only ninety days. As the court noted, invoking the one-year preference period makes it unlikely that insiders would be able to prefer themselves.

89. *Id.* at 1195.

sional intent to continue the practice under the pre-1978 Bankruptcy Act of recovering payments only from parties to whom the transfer represented a preference.⁹⁰ Judge Easterbrook disagreed, stating that, “[w]hen Congress makes wholesale changes in the text and structure of the law, it is fatuous to pretend that a silent legislative history means that existing practices should continue unchanged.”⁹¹ Easterbrook pointed out that the silence in the Committee Report⁹² was not informative because it was the “novel text of section 550(a)(1) . . . that underlies the Trustee’s claim . . . and that change [in the text] did not happen until five years after the *Report*.”⁹³

Easterbrook steadfastly rejected the bankruptcy court’s equity arguments.⁹⁴ He did not see any inequity in requiring the outside lenders to pursue the inside guarantors for any shortfall they encountered, since that was the situation for which they had bargained.⁹⁵ In

90. See *id.* at 1196.

91. *Id.*

92. REPORT OF THE COMMISSION ON THE BANKRUPTCY LAWS OF THE UNITED STATES, H.R. DOC. NO. 93-137 (1973).

93. *Deprizio*, 874 F.2d at 1197 n.9. In short, according to Judge Easterbrook:

An extended recovery period is consistent with the structure of the Code and does not subvert any of its functions. A longer period when insiders reap benefits by preferring one outside creditor over another facilitates the operation of bankruptcy as a collective process and ensures that each creditor will receive payment according to the Code’s priorities and non-bankruptcy entitlements. Silence in the legislative history therefore does not require or authorize a court to depart from the text and structure of the Code.

Id. (citing *Chan v. Korean Air Lines, Ltd.*, 490 U.S. 122, 133-38 (1989); *United States v. Ron Pair Enters., Inc.*, 489 U.S. 235, 240 (1989)).

94. See *Bonded Fin. Servs., Inc. v. European Am. Bank*, 838 F.2d 890, 894-95 (7th Cir. 1988); *In re Iowa R.R.*, 840 F.2d 535, 536 (7th Cir. 1988); *In re Chicago, Milwaukee, St. Paul & Pac. R.R.*, 791 F.2d 524, 528 (7th Cir. 1986); *Boston & Maine Corp. v. Chicago Pac. Corp.*, 785 F.2d 562, 566 (7th Cir. 1986); see also *Norwest Bank Worthington v. Ahlers*, 485 U.S. 197, 206 (1988) (“[W]hatever equitable powers remain in the bankruptcy courts must and can only be exercised within the confines of the Bankruptcy Code.”).

Easterbrook argued that equity arguments are inapplicable to this situation because “[r]ules of law affecting parties to voluntary arrangements do not operate ‘inequitably’ in the business world—at least not once the rule is understood.” *Deprizio*, 874 F.2d at 1197. The court interpreted the preference provisions of the Code to be clear and unambiguous. Thus, equitable arguments would be inadmissible. Furthermore, as a matter of policy no “inequity” resulted to the Lender Creditors. The extended-preference period, whether it had a positive or negative effect on the extension of credit, still allowed creditors to receive a competitive rate of return in financial markets. While the rule may have had the effect of foreclosing efficient business arrangements and increasing the interest low risk borrowers pay, “inefficiency is not inequity.” *Id.*

95. See *Deprizio*, 874 F.2d at 1197. Easterbrook also rejected the policy arguments advocated by the creditors. He rejected their theory that an extended preference-recovery period will cause a stampede from workouts to bankruptcies. Nor did he see the inequity in recapturing “payments to creditors that may have been favored only because payment reduced insiders’ exposure . . . then distribut[ing] these monies according to statutory priorities and contractual entitlements.” *Id.*

dictum, the court contended that the Lender Creditor's concerns about the "pernicious consequences" of adopting its holding would not actually burden creditors to any significant degree because §§ 547(b)(5)⁹⁶ and 547(c)⁹⁷ "excluded from recovery bulk or ordinary commercial payments."⁹⁸

To summarize, the Seventh Circuit agreed with the trustee and held that because insiders benefited from the payments made to the lenders, the preference period should be extended to one year. Even though the payments were preferential only because of the benefit to the insiders, the court permitted recovery of payments from the lenders based upon a literal reading of § 550(a) and supported by a reading of the purposes and policies behind the Code provision.

1. Reaction to *Deprizio*

Both scholars and the business community took immediate notice of the Seventh Circuit ruling. The debate among legal commentators regarding the soundness of the *Deprizio* decision has been resounding. Many commentators severely criticized the decision and

96. Section 547(b)(5) "enables such creditor to receive more than such creditor would receive if—(A) the case were a case under chapter 7 of this title; (B) the transfer had not been made; and (C) such creditor received payment of such debt to the extent provided by the provisions of the title." 11 U.S.C. § 547(b)(5) (1994).

97. Section 547(c) provides:

The trustee may not avoid under this section a transfer—

- (1) To the extent that such transfer was—
 - (A) intended by the debtor and the creditor to or for whose benefit such transfer was made to be a contemporaneous exchange for new value given to the debtor; and
 - (B) in fact a substantially contemporaneous exchange;
- (2) to the extent that such transfer was—
 - (A) in payment of a debt incurred by the debtor in the ordinary course of business or financial affairs of the debtor and the transferee;
 - (B) made in the ordinary course of business or financial affairs of the debtor and the transferee; and
 - (C) made according to ordinary business terms;
- (3) that creates a security interest in property acquired by the debtor—
 - (A) to the extent such security interest secures new value [in the nature of a purchase money security interest] . . .
- (4) to or for the benefit of a creditor, to the extent that, after such transfer, such creditor gave new value to or for the benefit of the debtor—
 - (A) not secured by an otherwise unavoidable security interest; and
 - (B) on account of which new value the debtor did not make an otherwise unavoidable transfer to or for the benefit of such creditor

11 U.S.C. § 547(c) (1994) (as amended in 1984 to eliminate the former requirement in § 547(c)(2) that the payment come within forty-five days of the debt to count as one in due course, a qualifier that potentially allowed the trustee to recover all installment payments).

98. *Deprizio*, 874 F.2d at 1199.

warned of possible dire implications for the lending industry.⁹⁹ In response, Professor Jay Westbrook argued that the fear about *Deprizio* was misplaced.¹⁰⁰ He argued that commercial lenders would adapt quickly to the decision, just as they did to equally controversial decisions, and believed that as such, the decision would become part of the commercial landscape.¹⁰¹ He identified two shortcomings in the debate surrounding *Deprizio*: (1) the failure to address the distinction between "true economic value" and "pure-leverage" guarantees; and (2) the technical requirement that the insider be a "creditor" of the debtor.¹⁰²

Westbrook's primary concern was the underlying policy issue presented in *Deprizio*: preference policy as applied to insider guarantees. Acknowledging that the leverage generated by an inside guarantee threatens the antidismemberment and equality of distribution policies promoted by the Bankruptcy Code, Westbrook agreed with Easterbrook's policy analysis that "[o]nly recovery against the possessors of that leverage, the lenders themselves, [would] mitigate its undesirable effects."¹⁰³

Deprizio, Westbrook argued, would not affect "true guarantee" situations.¹⁰⁴ The lender may have had to repay the trustee the

99. See, e.g., Donald W. Baker, *Repayments of Loans Guaranteed by Insiders as Avoidable Preferences in Bankruptcy: Deprizio and Its Aftermath*, 23 UCC L.J. 115, 147 (1990) (arguing that *Deprizio* is unsound and should be reconsidered); Robert F. Higgins & David E. Peterson, *Is There A One-Year Preference Period for Non-Insiders?*, 64 AM. BANKR. L.J. 383, 383-84 (1990) (criticizing *Deprizio* for the risks it raises for non-insider creditors); Henk J. Brands, Note, *The Interplay Between Sections 547(b) and 550 of the Bankruptcy Code*, 89 COLUM. L. REV. 530, 532-33 (1989) (proposing that recovery from the non-insider should be based on § 550(a)(2) rather than § 550(a)(1)); John Stephen Cullina, Comment, *Recharacterizing Insider Preferences as Fraudulent Conveyances: A Different View of Levit v. Ingersoll Rand*, 77 VA. L. REV. 149, 149-52, 156-59 (1991) (arguing that Code should be amended to characterize transfers that benefit insiders as fraudulent conveyances); Andrew J. Nussbaum, Note, *Insider Preferences and the Problem of Self-Dealing Under the Bankruptcy Code*, 57 U. CHI. L. REV. 603, 614 (1990) (criticizing courts for not characterizing transfers involving insiders according to their substantive impact); James A. Rodenberg, Note, *Indirect Preferences: Recovery Under Sections 547 and 550 of the Bankruptcy Code*, 55 MO. L. REV. 327, 342-50 (1990) (arguing that the Code does not require the preference period to be extended for non-insider lenders); Mark E. Toth, Comment, *The Impossible State of Preference Law Under The Bankruptcy Code: Levit v. Ingersoll Rand Financial Corp. and the Problem of Insider-Guaranteed Debt*, 1990 WIS. L. REV. 1155, 1168-75 (asserting that the preference sections as currently applied will not adequately deal with the insider-guaranteed debt scenario). But see Thomas E. Pitts, Jr., *Insider Guarantees and the Law of Preferences*, 55 AM. BANKR. L.J. 343 (1981) (arguing that § 550(a)(1) should be read literally and that the financial community will adapt to this interpretation).

100. See Jay Lawrence Westbrook, *Two Thoughts About Insider Preferences*, 76 MINN. L. REV. 73, 73 (1991).

101. See *id.*

102. *Id.* at 74.

103. *Id.* at 77.

104. *Id.* at 81.

amount of an avoidable transfer, but the lender would have a solvent guarantor from whom to recover (or most likely to join in the original action). The trustee may even have chosen to recover from the guarantor directly.¹⁰⁵ On the other hand, the lender with a "pure leverage guarantee" would have felt *Deprizio* head on: the lender would have to pay the trustee directly but would be unable to collect from the guarantors. Thus, those lenders with true guarantees were protected despite *Deprizio*, while those lenders with pure leverage guarantees were not. According to Westbrook, the preference provisions were designed for exactly this type of situation.¹⁰⁶ Allowing a recovery from lenders in the pure leverage situation furthered the anti-dismemberment policies of the Code.¹⁰⁷ The commercial lending industry would be hurt by the *Deprizio* holding only if lenders were customarily taking "pure leverage guarantees." Those taking "true guarantees" would not be adversely affected. *Deprizio*, according to Westbrook, "provide[d] the right incentives and [would] operate to permit the taking of true guarantees and to discourage the taking of pure-leverage guarantees, just as we should want."¹⁰⁸

Westbrook then examined and defended the requirement that the insider be a creditor of the debtor by virtue of its right to reimbursement. He readily admitted that the creditor requirement presented an anomaly: "the insider's creditor status [while] crucial to the outcome . . . has almost nothing to do with the policies the [*Deprizio*] rule serves¹⁰⁹ and the [*Deprizio*] opinion defends."¹¹⁰ Recognizing preference law as formulaic and meant to operate mechanically, Westbrook found that the creditor requirement served to (1) constrain the enforcement of preference policy except in the core cases and (2) include in the "balance against enforcement of preference policy the costs that would arise from applying the more formulaic preference rules to marginal cases."¹¹¹ In sum, in Westbrook's view, the

105. *See id.*

106. *See id.* Since the target of the anti-dismemberment policy was the leverage that the lender held over a company, the pure-leverage guarantee was in conflict with the Code. Because the pure-leverage guarantor was unable financially to honor the guarantee, the effect of *Deprizio* was to remove the lender's leverage.

107. *See id.* at 85.

108. *Id.* at 86.

109. *Id.* at 88 (citing Cullina, *supra* note 99, at 151).

110. *Id.* at 88.

111. *Id.* at 95. The creditor requirement becomes a proxy for the relationship between the transfer and the benefit, it reflects the "direct and quantified connection between the company's transfer and the insider's benefit." *Id.*

creditor rule was a proxy for the "policies constraining application of the preference rules."¹¹²

Peter Alces, in a response to Westbrook's article, rejected this defense of *Deprizio* because it removed from its grasp several situations which should be included within the decision's scope.¹¹³ Alces rejected Westbrook's distinction of a "true guarantee" from a "pure-leverage guarantee" and his defense of the creditor requirement.¹¹⁴ Alces found that "[t]he basis of constructive fraud liability [was] prejudice to the plaintiff, (i.e., general unsecured creditors in bankruptcy) without regard to the intent of the defendant (i.e., preferential transferee)."¹¹⁵ Alces' position was that Westbrook failed to recognize the implications of construing "preference law as formulaic."¹¹⁶ For Alces, the *Deprizio* case was primarily about the constructive fraud nature of preference law.

Another commentator, David Karzen, commented that even though the initial transferee would most likely be involved materially in the aspects of the transaction, § 550(a)(1) on its face did not require any substantive linkage.¹¹⁷ He argued that when there is no linkage between the insider and the initial transferee, the initial transferee's liability under § 550(a)(1) was arbitrary and unfair. Karzen supported his position by reference to draft legislation prepared by the Commission on Bankruptcy Laws, which he viewed as evidence that Congress intended that "liability [should] flow from one's substantive relationship to the avoided transfer."¹¹⁸

112. *Id.* at 98.

113. See Peter A. Alces, *Rethinking Professor Westbrook's Two Thoughts About Insider Preferences*, 77 MINN. L. REV. 605, 608 (1993).

114. Alces argued that Westbrook's interpretation of the creditor requirement as a "proxy for the strength and clarity of the relationship between transfer and benefit" misses the central point of preference law: "the amount of the *transfer* to the lender would be the amount of the preference, not the value of the *benefit* the insider realizes as a result of the preference." According to Alces there was nothing in the Code to support Westbrook's position. See *id.* at 631.

115. The very basis of constructive fraud law focuses on the detriment the victim of misrepresentation suffers rather than on the benefit the fraud-feasor realizes. See *id.* at 609.

116. This is, according to Alces, just another terminology for accepting the constructive fraud nature of preference liability. See *id.* at 610.

117. See David I. Karzen, *Deprizio and Bankruptcy Code Section 550: Extended Preference Exposure Via Insider Guarantees, and Other Perils of Initial Transferee Liability*, 45 BUS. LAW. 511, 520-23 (1990).

118. *Id.* at 524. The commission had recommended the separation of the trustee's recovery rights from the specification of his several avoiding powers. REPORT OF THE COMMISSION ON THE BANKRUPTCY LAWS OF THE UNITED STATES, H.R. DOC. NO. 93-137, pt.2, at 178 (1973). He also supports this position based upon the text of § 547(d).

Unlike legal scholars, practicing attorneys and lenders were forced to directly confront the practical effects of *Deprizio*. In the aftermath of the decision, lenders and their counsel took three different courses of action. First, applying a rudimentary cost-benefit analysis, many lenders sought to ascertain the benefits and burdens of a personal guarantee more carefully before accepting one.¹¹⁹ Lenders who had ample leverage by other means often chose another course, not wanting to risk liability under *Deprizio*, especially if the guarantor was not solvent enough to fully cover the loan.¹²⁰ Also, many lenders took special care to note that the status of the guarantor often changed over time. A guarantor who had substantial wealth at the time of the loan might lose some of its assets, thus making the guarantee less advantageous and more risky for the lender. Similarly, outside guarantors sometimes later became insiders, thereby making the guarantee less attractive to the lender. In such instances, many lenders opted to release the guarantor from the guarantee.¹²¹

Second, some lenders structured their loan transactions so they were protected as "subsequent transferees" under § 550(a)(2) and (b).¹²² Under this option, the lender would loan money to the insider, who would then reloan the money to the debtor company. Any payments would retrace these steps: the debtor company would pay the insider, who would in turn pay the lender. Even though the debtor's payments to the insider might be voidable as preferences, the lender would be insulated as a subsequent transferee who took for value, in good faith, and without knowledge that the original transfer was voidable. If allowed, this would shelter all preferential payments, even those within the ninety-day period.

A number of potential problems, though, presented themselves in structuring loan arrangements in this manner. First, although the payments made by the debtor were "to" an insider, a court could construe them as being made "for the benefit" of the lender who ultimately received the money, thus eliminating the subsequent transferee defense through § 550(a). Second, a court could find that the

119. See Karzen, *supra* note 117, at 511.

120. See *id.* at 533.

121. See *id.*

122. *Id.* at 532. See *supra* note 18 for text of § 550(a)(2). Section 550(b) provides:

The trustee may not recover under section (a)(2) of this section from

- (1) a transferee that takes for value, including satisfaction or securing of a present or antecedent debt, in good faith, and without knowledge of the voidability of the transfer avoided; or,
- (2) any immediate or mediate good faith transferee of such transferee.

11 U.S.C. § 550(b) (1994).

lender in such a transaction had not met all the requirements of a subsequent transferee because of a lack of good faith.¹²³ Finally, a court could reasonably conclude that the lender had become an insider, through the exercise of its control, subjecting the lender to the one year preference provision it was attempting to avoid.

To avoid these difficulties, the device most often used by lenders to avoid the *Deprizio* rule was a waiver. Pursuant to this option, the insider agreed to waive all rights to reimbursements from the borrower, or to be subrogated to the lender's rights, after the insider honored the guarantee.¹²⁴ The effect of the waiver was to eliminate the insider's right to a contingent claim against the debtor, thus terminating its "creditor" status. In this scenario, any payment made to the lender did not benefit an insider; thus, the extended preference period was not triggered. This option, however, also presented problems for the lender. First, guarantors were often reluctant to waive their reimbursement and subrogation rights because of the increase in their own risk exposure. Second, the waiver's sole function was to escape the effect of *Deprizio*, but the effect was also to intensify the guarantor's motive to prefer since it would have to answer for the entire amount if the debtor defaulted.

The viability of the waiver alternative was actually considered by two bankruptcy courts.¹²⁵ The guarantor in *In re Fastrans* waived any and all common law, statutory, legal, and equitable rights arising in relation to the guaranteed indebtedness.¹²⁶ The court reasoned that for the trustee to utilize *Deprizio*, "he must establish that the insider-guarantor . . . has a 'claim' against the debtor arising from his obligations under the Guaranty and is not just a creditor of the debtor generally."¹²⁷ Based on the terms of the waiver, the trustee was unable to satisfy that requirement. *In re XTI Xonix Tech., Inc.* upheld the effectiveness of obtaining waivers of subrogation, indemnification,

123. The legislative history of § 550(b) seems to allow for a court to make such a finding: The phrase "good faith" in this paragraph is intended to prevent a transferee from whom the trustee could recover from transferring [sic] the recoverable property to an innocent transferee, and receiving a retransfer from him, that is, "washing" the transaction through an innocent third party. In order for the transferee to be excepted from liability under this paragraph, he himself must be a good faith transferee.

S. REP. NO. 95-989, at 90 (1978), reprinted in 1978 U.S.C.A.N. 5787, 5876.

124. Karzen, *supra* note 117, at 529. See also Alvin L. Arnold, *Bankruptcy: Waiver of Subrogation Rights Defeats Deprizio*, 22 REAL EST. L. REP. 4, 4 (1992).

125. See Hostmann v. First Interstate Bank, N.A. (*In re XTI Xonix Tech., Inc.*), 156 B.R. 821, 824-34 (Bankr. D. Or. 1993); *In re Fastrans, Inc.*, 142 B.R. 241, 246 (Bankr. E.D. Tenn. 1992).

126. See *Fastrans*, 142 B.R. at 243.

127. *Id.* at 245.

contribution, and reimbursement rights from guarantors in order to preclude the guarantors' insider creditor status for the purposes of §§ 547(b) and 550(a).¹²⁸

2. Congress's Response: The 1994 Bankruptcy Reform Act

Six years after *Deprizio*, Congress passed the Bankruptcy Reform Act of 1994.¹²⁹ Among numerous other provisions, the Reform Act addressed the perceived inequities of *Deprizio* and its progeny. Section 202 of the Reform Act, entitled "Limitation on Liability of Non-Insider Transferee for Avoided Transfer," overruled the *Deprizio* line of cases, inserting a new § 550(c).¹³⁰ Section 550 now provides that noninsider transferees have no liability for preferential transfers made for the benefit of insiders during the period between ninety days and one year prior to the filing of bankruptcy petition. The legislative history confirms this change.¹³¹ Now, a trustee looking to recover for a preferential transfer in the *Deprizio*-type situation will only be able to look to the insider guarantor for recovery, and not the transferee, if the transfer was made more than ninety days but less than one year prior to the petition.

128. *XTI Xonix*, 156 B.R. at 824; see also *In re Southmark Corp.*, 993 F.2d 117 (5th Cir. 1993); *In re Northwestern Contracting Co.*, 187 B.R. 420 (Bankr. D. Conn. 1995).

129. Bankruptcy Reform Act of 1994, Pub. L. No. 103-394, 108 Stat. 4106 (1994).

130. See *supra* note 18 for the language of § 550 prior to the Reform Act. The Reform Act amended the section as follows:

- (c) If a transfer made between 90 days and one year before the filing of the petition
 - (1) is avoided under section 547(b) of this title; and
 - (2) was made for the benefit of a creditor that at the time of such transfer was an insider; the trustee may not recover under subsection (a) from a transferee that is not an insider.
- (d) The trustee is entitled to only a single satisfaction under subsection (a) of this section.
- (e)
 - (1) A good faith transferee from whom the trustee may recover under subsection (a) of this section has a lien on the property recovered to secure the lesser of . . .
- (f) An action or proceeding under this section may not be commenced after the earlier of—
 - (1) one year after the avoidance of the transfer on account of which recovery under this section is sought; or . . .

11 U.S.C. § 550 (1994).

131. Section 550(c) "overrules the *DePrizio* [sic] line of cases and clarifies that non-insider transferees should not be subject to the preference provisions of the Bankruptcy Code beyond the 90-day statutory period." H.R. REP. NO. 103-835, at 45 (1994), reprinted in 1994 U.S.C.C.A.N. 3340, 3353.

Although the changes in the Reform Act addressed one aspect of the *Deprizio* situation, they left unanswered several other potential questions. For example, there still remains a problem with an “indirect preference” made within ninety days of the petition. Suppose a fully secured senior lienholder receives a payment from the debtor within ninety days of the petition. Since the lienholder is fully secured, this transfer would not be avoidable under § 547, since it would not increase what the creditor would get if she were involved in a Chapter 7 debtor scenario. But this payment, which lowers the amount of the lien of the senior lender, necessarily increases the lien of any junior lienholders. Thus, the payment to the fully secured senior lienholder is actually “to or for the benefit of” another creditor—the junior lienholder. Accordingly, the Reform Act would still allow the trustee to recover, under § 550(a)(1), from the fully secured senior lienholder as “the initial transferee of such transfer.”¹³²

Non-insider lenders, under the Reform Act, are now not only protected from the *Deprizio* situation, they may actually realize positive gains from it.¹³³ Moreover, imagine the effect such a situation is

132. Perhaps more importantly, the Reform Act actually might have gone too far in attempting to protect the so-called “innocent” lender in the *Deprizio* type situation. Suppose A Corp. gets a \$100,000 loan from Norwest. As a condition of the loan, Norwest requires A Corp.’s president to personally guarantee the obligation. A Corp. then makes a \$60,000 payment to Norwest. This payment occurs more than ninety days but less than one year prior to A Corp.’s filing for bankruptcy protection. This transfer has been a benefit to the president, an insider, because it has lowered his contingent obligation on the guarantee. This transfer can obviously be avoided as a preferential transfer because it was “to or for the benefit” of a creditor, the president. Under the Reform Act, the new § 550 then comes into operation. The new section would not allow the trustee to recover the transfer from the non-insider, Norwest, because the transfer occurred more than ninety days prior to the bankruptcy petition. The trustee, though, can recover the payment from the president (assuming she is solvent enough), even though she did not directly receive the transfer, but only indirectly benefited from it. Norwest, through the receipt of the \$60,000 payment, has now seen its loan decreased to \$40,000. Since A Corp. is now in bankruptcy, Norwest will most likely be an unsecured creditor with respect to this remaining amount. Even if Norwest were secured, the Trustee could likely avoid any security interest by operation of § 547(b). See 5 COLLIER ON BANKRUPTCY ¶ 547.03[3][a], at 547-28 (1998). If the president was solvent enough to pay the trustee for the avoided preference, however, the debtor’s bankruptcy estate has now grown by \$60,000. Presumably, Norwest, as a creditor, would be able to share in this amount. This obviously puts lenders, such as Norwest in this example, in a very advantageous position.

An obvious corollary to this is that it may now be less beneficial for lenders to take waivers of subrogation rights from guarantors. If courts hold that lenders can share in the avoidance recovery from the insiders, lenders will presumably want the guarantor to be deemed a creditor so the trustee can look to the guarantor’s personal funds to increase the amount of the estate, without looking to the non-insider lender for recovery.

133. In this scenario, even though Norwest benefits from the insider guarantor’s payment to the trustee, the payment would likely not be a preference as contemplated by the Code, since the payment actually increases the value of the bankruptcy estate. “[A] preference turns on

likely to have on future guarantors. Who would agree to act as a "true guarantor" when they continue to be potentially liable for the debt even though the creditor is paid?¹³⁴

C. BFP v. Resolution Trust Corp.

In 1987, the BFP partnership was formed to purchase a home in California from Sheldon and Anne Foreman.¹³⁵ BFP acquired title to realty subject to a first deed of trust in favor of Imperial Federal Savings & Loan Association in the amount of \$356,250.¹³⁶ BFP granted a second deed of trust to the Foremans as security for a \$200,000 promissory note.¹³⁷ When BFP failed to make the requisite payments, Imperial instituted foreclosure proceedings.¹³⁸ Paul Osborne purchased the home at a foreclosure sale on July 12, 1989, for \$433,000.¹³⁹ On October 12, 1989, BFP filed for Chapter 11 bankruptcy relief and initiated an adversary proceeding to set aside the sale to Osborne as a fraudulent transfer under § 548 of the Code.¹⁴⁰ BFP argued that the transfer was a fraudulent conveyance because the property was actually worth \$725,000 at the time of the sale to Osborne and thus \$433,000 was not "reasonably equivalent value."¹⁴¹

The bankruptcy court, acting on separate motions, found that the foreclosure sale was properly conducted under California law without collusion or fraud.¹⁴² Accordingly, it granted summary judgment in favor of Imperial.¹⁴³ The district court upheld the bankruptcy court.¹⁴⁴ BFP sought further review and a divided bankruptcy appel-

whether it results in a *diminution* of the bankrupt's estate." *Danning v. World Airways, Inc. (In re Holiday Airlines Corp.)*, 647 F.2d 977, 982 n.3 (9th Cir. 1991).

134. Some other problems that remain after the 1994 Amendment are discussed in David B. Young & Jeff Bohn, *Preferences and Fraudulent Transfers: A Lender's Perspective*, 767 PLI/COMM 585, 665-69 (1998).

135. See *BFP v. Resolution Trust Corp.*, 511 U.S. 531, 533 (1994).

136. See *id.*

137. See *id.*

138. Imperial entered a notice of default and "scheduled a properly noticed foreclosure sale." *Id.* Foreclosure proceedings were delayed when Imperial was declared insolvent and Resolution Trust Corporation was appointed as receiver.

139. See *id.* at 534.

140. See *supra* note 20 for the text of § 548. The constructive fraud provision at issue in *BFP* permits the avoidance of a transfer if the trustee can establish: (1) there was a transfer of interest of the debtors; (2) transfer occurred within one year of the filing of bankruptcy petition; (3) debtor was insolvent at the time of the transfer or as a result of the transfer; and, (4) debtor received "less than reasonably equivalent value in exchange for such transfer." 11 U.S.C. § 548(a)(2)(A) (1994).

141. *BFP*, 511 U.S. at 534.

142. See *id.*

143. See *id.*

144. See *id.*

late panel affirmed the summary judgment for Imperial.¹⁴⁵ Relying on *In re Madrid*,¹⁴⁶ the panel majority found that a “non-collusive and regularly conducted nonjudicial foreclosure sale . . . cannot be challenged as a fraudulent conveyance because consideration received in such a sale establishes ‘reasonably equivalent value’ as a matter of law.”¹⁴⁷ BFP appealed both decisions to the Ninth Circuit, which consolidated the appeals.¹⁴⁸ The Ninth Circuit affirmed the lower courts’ decisions.¹⁴⁹

Justice Scalia, writing for the majority in a 5-4 decision,¹⁵⁰ affirmed the lower courts’ decisions and held that a fair and proper price is the price received at the foreclosure sale.¹⁵¹ Scalia defined the question presented in the case as “whether the amount of debt (to the first and second lienholders) satisfied at the foreclosure sale (viz., a total of \$433,000) is ‘reasonably equivalent’ to the worth of the real estate conveyed.”¹⁵²

The Court recognized that of the three critical terms (“reasonably,” “equivalent,” and “value”) before it, the Code defined only “value.”¹⁵³ The courts of appeals had employed several distinct approaches in determining whether a transfer was avoidable for receiving less than reasonably equivalent value. The Court first examined the Fifth Circuit’s standard as developed in *Durrett v. Washington National Insurance Co.* (the “Durrett approach”).¹⁵⁴ To determine “reasonably equivalent value” under § 548(a)(2), the *Durrett* approach applied a numerical test in which the “price” received at the foreclosure sale was gauged against the appraised fair market value.¹⁵⁵ To defeat a subsequent avoidance in bankruptcy under the *Durrett* approach, the foreclosure sale price had to be at least seventy percent of the fair market value.¹⁵⁶

145. *See id.* (referencing *In re BFP v. Imperial Savings & Loan Assoc.*, 132 B.R. 748 (B.A.P. 9th Cir. 1991)).

146. *In re Madrid*, 21 B.R. 424, 424 (B.A.P. 9th Cir. 1982).

147. *In re BFP v. Imperial Savings & Loan Assoc.*, 132 B.R. 748, 750 (B.A.P. 9th Cir. 1991).

148. *See BFP*, 511 U.S. at 534.

149. *See In re BFP*, 974 F.2d 1144 (9th Cir. 1992).

150. Justice Scalia was joined in the majority by Chief Justice Rehnquist, Justice O'Connor, Justice Kennedy, and Justice Thomas. Justice Souter, writing for the very spirited dissent, was joined by Justice Blackmun, Justice Stevens, and Justice Ginsburg.

151. *See BFP*, 511 U.S. at 545.

152. *Id.* at 536.

153. *Id.* at 535. *See supra* note 34 for the text of the Code defining value.

154. *Durrett v. Washington Nat'l Ins. Co.*, 621 F.2d 201, 203 (5th Cir. 1980).

155. *Id.* at 203-04.

156. *See id.*

In 1982, the Ninth Circuit Bankruptcy Appellate Panel rejected the *Durrett* approach in *In re Madrid* (the "*Madrid* approach"),¹⁵⁷ holding that a "regularly conducted sale, open to all bidders and all creditors, is itself a safeguard against the evils of private transfers to relatives and favorites."¹⁵⁸ The premise of the *Madrid* approach was that subjecting a properly conducted foreclosure sale to attack as fraudulent transfer would create a *de facto* right of redemption in the trustee, significantly chilling participation at foreclosure sales, depressing prices, and increasing deficiency judgments.¹⁵⁹ The *Madrid* court held that "consideration received at a non-collusive and regularly conducted foreclosure sale" meant the same thing as "reasonably equivalent value" under § 548(a)(2)(A).¹⁶⁰ The focus under the *Madrid* approach was whether the foreclosure sale conformed with the governing state law procedures.

The Seventh Circuit adopted the third major approach in its decision in *In re Bundles* (the "*Bundles* approach").¹⁶¹ The Seventh Circuit, dissatisfied with both the *Durrett* and *Madrid* approaches, determined that each bankruptcy court would need to make a case-by-case determination of reasonable equivalence through a multifactored analysis.¹⁶² The reasonable *equivalency* inquiry would not be limited to comparing the price received at the foreclosure sale to the property's fair market value. Rather, it would involve a fact-specific inquiry requiring the bankruptcy court to utilize its expertise in assessing the adequacy of the price based on the conditions of the sale.¹⁶³

Scalia rejected the *Durrett* fixed percentage approach and the *Bundles* totality of circumstances approach because of their reliance on fair market value as the "benchmark" for measuring whether the price received was "reasonably equivalent."¹⁶⁴ The Court relied on the Code's plain language in support of its rejection of these two approaches.¹⁶⁵ Relying on the canon *expressio unius est exclusio alterius*,¹⁶⁶ the Court reasoned that because the term "fair market value"

157. *In re Madrid*, 21 B.R. 424, 427 (B.A.P. 9th Cir. 1982).

158. *Id.* at 426-27.

159. *See id.*

160. *Id.* at 427.

161. *In re Bundles*, 856 F.2d 815 (7th Cir. 1988).

162. *See id.* at 824.

163. *See id.* at 825.

164. *BFP v. Resolution Trust Corp.*, 511 U.S. 531, 537 (1997).

165. *See id.*

166. The phrase translates to "the expression or inclusion of one thing implies the exclusion of others."

does not appear in § 548 but does appear in other sections of the Code,¹⁶⁷ Congress “seemingly [went] out of its way to avoid that standard term” and instead chose the “entirely novel phrase ‘reasonably equivalent value.’”¹⁶⁸ Scalia relied on *City of Chicago v. Environmental Defense Fund*,¹⁶⁹ also decided that same term. There the Court reasoned that “[i]t is generally presumed that Congress acts intentionally and purposely when it includes particular language in one section of a statute but omits it in another.”¹⁷⁰

The Court found further support for its rejection of fair market value as the “benchmark” by comparing a forced sale with normal market conditions. According to Scalia, fair market value presumes conditions that do not apply in the forced sale context.¹⁷¹ In the Court’s view, both *Durrett* and *Bundles* failed to “come to grips with this glaring discrepancy between the factors relevant in an appraisal of a property’s market value, on the one hand, and the strictures of the foreclosure process on the other.”¹⁷² Scalia stated that based on the factors present at a forced sale the property was “simply *worth less*.”¹⁷³ The Court found fair market value to be the very “antithesis” of forced sale value, and thus inapplicable in the context of a mortgage foreclosure sale.¹⁷⁴

167. For example, “fair market value” does appear in §§ 552 and 346(j)(7)(b).

168. *BFP*, 511 U.S. at 537.

169. *City of Chicago v. Environmental Defense Fund*, 511 U.S. 328 (1994).

170. *Id.* at 338 (internal quotation marks omitted). In *BFP*, Scalia went on to note that “this presumption is even stronger when the omission entails the replacement of standard legal terminology with a neologism.” *BFP*, 511 U.S. at 537.

171. *BFP*, 511 U.S. at 537.

172. *Id.* at 538. Scalia relied for authority on Black’s Law Dictionary:

The market value of . . . a piece of property is the price which it might be expected to bring if offered for sale in a fair market; not the price which might be obtained on a sale at public auction or a sale forced by the necessities of the owner, but such a price as would be fixed by negotiation and mutual agreement, after ample time to find a purchaser, as between a vendor who is willing (but not compelled) to sell and a purchaser who desires to buy but is not compelled to take the particular . . . piece of property.

BLACK’S LAW DICTIONARY 971 (6th ed. 1990).

173. *BFP*, 511 U.S. at 539.

174. Justice Scalia further explained:

An appraiser’s reconstruction of “fair market value” could show what similar property would be worth if it did not have to be sold within the time and manner structures of state-prescribed foreclosure. But property that *must* be sold within these strictures is simply *worth less*. No one would pay as much to own such property as he would pay to own real estate that could be sold at leisure and pursuant to normal marketing techniques. And it is no more realistic to ignore that characteristic of the property (the fact that state foreclosure law permits the mortgagee to sell it at forced sale) than it is to ignore other price-affecting characteristics (such as the fact that state zoning law permits the owner of the neighboring lot to open a gas station).

Id. (footnote omitted).

The Court concluded that once a piece of property is subject to a foreclosure sale, the free market rules are inapplicable and are replaced by the states' laws governing forced sales. Thus, "the only legitimate evidence of the property's value at the time it is sold is the foreclosure-sale price itself."¹⁷⁵

Characterizing the *Durrett* and *Bundles* approaches as attempting to establish a "fair" forced sale price, the majority found that "such judgments represent policy determinations that the Bankruptcy Code gives us no apparent authority to make."¹⁷⁶ The majority reasoned that the terms of the sale determine how closely the sale price at the foreclosure sale approximated its fair market value. Accordingly, since each state determines the terms of a foreclosure sale, "[t]o specify a federal 'reasonable' foreclosure-sale price is to extend federal bankruptcy law well beyond the traditional field of fraudulent transfers, into realms of policy where it has not ventured before."¹⁷⁷

Justice Scalia examined the history of fraudulent transfer and foreclosure law and noted that until *Durrett* "no prior decision had ever applied the 'grossly inadequate price' badge of fraud under fraudulent transfer law to set aside a foreclosure sale."¹⁷⁸ The majority rejected the *Durrett* and *Bundles* positions that "reasonably equivalent value" . . . requires a foreclosure sale to yield a certain minimum price beyond what state foreclosure law requires."¹⁷⁹ In doing so, the majority recognized Congress's power to disrupt the "ancient harmony" and to "preempt traditional state law" but noted it was reluctant to do so "absent clearer textual guidance" in the statute.¹⁸⁰ The majority accordingly held that "a fair and proper price, or a 'reasonably equivalent value,' for the foreclosed property, is the price in fact received at the foreclosure sale so long as all the requirements of the State's foreclosure law have been complied with" because the Code was not clear enough to displace the essential state

175. *Id.* at 549.

176. *Id.* at 540.

177. *Id.* The majority found that "[s]tates have created diverse networks of judicially and legislatively crafted rules governing the foreclosure process, to achieve what each of them considers the proper balance between the needs of lenders and borrowers." *Id.* at 541-42.

178. *Id.* at 542 (footnote omitted).

179. *Id.* at 542-43. The majority relied on *United States v. Texas*, 507 U.S. 529, 534 (1993), for the proposition that "statutes that invade common law must be read with presumption favoring retention of long-established principles absent evident statutory purpose to the contrary." *Id.* at 543.

180. *Id.* at 543. The Court rejected the position that the 1984 amendments to the Bankruptcy Code codified the *Durrett* approach. According to the Court, the effect of the amendments was to expand the definition of "transfer" to include foreclosure sales and to allow a transfer to be avoided as fraudulent even if it was against the debtor's will. *See id.*

interest.¹⁸¹ Hence, the price received at a foreclosure sale conclusively establishes “reasonably equivalent value” for the purposes of § 548(a)(2).¹⁸²

Scalia further asserted that the majority’s reading of § 548(a)(2) did not render the section superfluous, as the dissent argued, because “reasonably equivalent value” continued to have an independent meaning outside the foreclosure context similar to fair market value.¹⁸³ According to the majority, this section would continue to affect those sales that failed to comply with the requisite state law procedures governing foreclosure sales.¹⁸⁴ In that instance, the transfer would be avoided if the “price received was not reasonably equivalent to the property’s actual value at the time of the sale.”¹⁸⁵

Justice Souter, writing for the dissent, attacked the majority for engrafting an exception onto § 548 that was “in derogation of the straightforward language used by Congress” in drafting the Code.¹⁸⁶ Souter argued that the majority opinion attempted to escape the plain meaning of the Code. The dissent advocated a “plain reading” of § 548 in which the bankruptcy court would “compare the price received by the insolvent debtor and the worth of the item when sold and set aside the transfer if the former was substantially ([un]reasonabl[y]) ‘less than’ the latter.”¹⁸⁷ The dissent supported its position through reliance on the text and policy of the Code.

The dissent vehemently objected to the majority’s assumption that because properties are “worth less” at foreclosure sales they must be worth whatever price was paid.¹⁸⁸ The dissent found this assump-

181. *Id.* at 545.

182. *Id.*

183. *Id.*

184. *See id.*

185. *Id.* at 546. (“the price that would have been received if the foreclosure sale had proceeded according to law”). The majority also noted its disagreement with the dissent’s reading of the plain language of § 548(a)(2). *See id.* While conceding that the central issue was the relationship between the value received for the property and the actual value, the majority rejected the dissent’s assertion that there was no ambiguity in the language, asserting that the doubt lay in “[w]hat . . . foreclosed property [is] worth.” *Id.* at 547 (emphasis omitted). The majority stated that until the value of the property in foreclosure was determined, there could not be a determination of whether the price received was reasonably equivalent. *See id.* The majority concluded by noting that the dissent failed to offer any alternatives to the question before the Court, and that it left to bankruptcy courts the determination of “value” and “worth”. *Id.*

186. *Id.* at 549 (Souter, J., dissenting).

187. *Id.* at 552.

188. *Id.* at 551 n.2 (responding to majority at 539). The dissent did recognize that reasonably equivalent value cannot be equated with fair market value because foreclosure sales “fail to bring in what voluntary sales realize.” *Id.* at 550. The dissent’s position was that people pay less for property at a foreclosure sale not because the property is worth less, but because they

tion to be implausible, even accepting the fact that foreclosure sales bring less value. The dissent offered two primary objections to the Court's reading of § 548: (1) if "value" of property was conclusively the price paid at a foreclosure sale, then the "less than equivalent value" inquiry would never be worth undertaking, and the trustee's avoidance power undoubtedly would be a "dead letter" for mortgage foreclosure sales;¹⁸⁹ and (2) the majority opinion allowed for the possibility that a "peppercorn paid at a non-collusive and procedurally regular foreclosure sale"¹⁹⁰ can be treated conclusively as "reasonably equivalent value" for the sale of property. The dissent argued that "reasonably equivalent" is a statutory qualification of value that demonstrates Congressional awareness that assets transferred in a foreclosure sale often receive less than their "optimal value."¹⁹¹ Thus, "reasonably equivalent" embodies acceptance that the assets will not yield their optimal value and "that avoidance in bankruptcy . . . should only occur when it is clear that the bankruptcy estate will be substantially augmented."¹⁹²

Souter also argued that the majority position violated a basic rule of construction in giving two separate meanings to the phrase

want a bargain, they want to pay less. Further, in a case like this, there are not an abundance of "free-spending millionaires" and that those that do exist are not likely reading "the fine print which fills the 'legal notice' columns of their morning newspaper." *Id.* at 551 n.2.

189. *Id.* at 555. The dissent argued that the majority's reading of § 548 resulted in the section becoming superfluous and a "dead letter." They found additional support for their assertion based upon the majority noting that the statute would still apply to collusive or procedurally defective foreclosures and to other types of transfers. According to the dissent, collusive and procedurally defective sales were already within the ambit of the Code. *Id.* (citing *In re Worcester*, 811 F.2d 1224, 1228, 1232 (9th Cir. 1987) (interpreting § 541(a)). The dissent stated, "neither the Court nor the respondents and their *amici* identify any specific case in which the court pronounced itself powerless to avoid a collusive foreclosure sale." *Id.* The dissent continued "[i]t would seem peculiar, then, that for no sound reason, Congress would have tinkered with these closely watched sections of the Bankruptcy Code, for the sole purpose of endowing bankruptcy courts with authority that had not been found wanting in the first place." *Id.* at 555-56 (note omitted).

190. *Id.* at 549.

191. *Id.* at 559. The dissent asserted that common sense dictates that a piece of property has worth independent of forced sale conditions. In addition, the appraised value is relevant to the reasonable equivalence determination "both because it provides a proper measure of the rights received by the transferee and because it is indicative of the extent of the debtor's equity in the property, an asset which, but for the pre-bankruptcy transfer under review, would have been available to the bankruptcy estate." *Id.* at 551 n.2. The dissent did not advocate a "dollar for dollar" exchange or that "fair market value" be expected at a forced sale because the plain language of § 548 dictates otherwise. *Id.* at 559.

192. *Id.* at 559 (citing *In re Southmark Corp.*, 138 B.R. 820, 829-30 (Bankr. N.D. Tex. 1992) (court must compare "the value of what went out with the value of what came in," but the equivalence need not be "dollar for dollar") (citation omitted); *In re Countdown of Conn., Inc.*, 115 B.R. 18 (Bankr. D. Conn. 1990) ("[S]ome disparity between the value of the collateral and the value of the debt does not necessarily lead to a finding of lack of reasonably equivalent value.")).

“reasonably equivalent value” in § 548(a)(2).¹⁹³ “Reasonably equivalent value” takes on a procedural meaning in one class of cases (real estate foreclosures) and a substantive meaning in another class of cases (all other transfers or foreclosures).¹⁹⁴

The dissent also relied on the 1984 amendments to the Bankruptcy Code.¹⁹⁵ The 1984 amendments included “foreclosure sales” within the definition of transfer,¹⁹⁶ which the dissent found to be clear textual guidance that Congress intended mortgage foreclosure sales to be judged under the same standard as other transfers.¹⁹⁷ Thus, the term “reasonably equivalent value” has a single meaning in the one provision. According to the dissent, Congress would have never made foreclosure sales subject to § 548 if it did not want courts to question the value received at the sale.¹⁹⁸

For the dissent, the plain reading of the Code required bankruptcy courts to compare the price received with the value of the property at the time of the sale.¹⁹⁹ Regardless of how “difficult and contestable” this process may be, courts routinely carried out this procedure when assets were transferred in a non-foreclosure settings. The dissent asserted that if courts could carry out this process in a non-foreclosure setting, then they could give “sensible content [to § 548] in evaluating particular transfers on foreclosure.”²⁰⁰ For instance, bankruptcy courts would determine if the price received for the property at the foreclosure sale was substantially less than the reasonable value on a case-by-case basis. If so, the sale would be

193. See *id.* at 557. “A common rule of construction calls for a single definition of a common term occurring in several places within a statute.” *Id.* (citing *Bray v. Alexandria Women’s Health Clinic*, 506 U.S. 263, 283 (1993); *Dewsnup v. Timm*, 502 U.S. 410, 422 (1992) (Scalia, J., dissenting) (“[N]ormal rule[s] of statutory construction” require that “identical words [used] in the same section of the enactment” must be given that same effect.)).

194. *Id.* at 557 n.9.

195. Bankruptcy Amendments and Federal Judgeship Act of 1984, Pub. L. 98-353 §§ 401(1), 463(a), 98 Stat. 366, 378 (1984).

196. See 11 U.S.C. § 101(54) (1994) (“[I]nvoluntary” transfers are no less within the trustee’s § 548 avoidance powers than “voluntary” ones and “foreclosure of the debtor’s equity of redemption” is itself a transfer for the purposes of bankruptcy law).

197. *BFP*, 511 U.S. at 557. “Thus, whether or not one believes (as the majority seemingly does not) that foreclosure sales rightfully belong within the historic domain of ‘fraudulent conveyance’ law, that is exactly where Congress has now put them, . . . and our duty is to give effect to these new amendments, along with every other clause of the Bankruptcy Code.” *Id.* at 554 (citations omitted).

198. See *id.* at 555. Further, the amendments demonstrate Congress’s intent to regulate the price received at a foreclosure sale. It is worth noting, as Souter does, that the amendments specifically rejected codifying *In re Madrid*, which would have established an irrebuttable presumption that the price obtained at a foreclosure sale was reasonably equivalent value.

199. See *id.* at 552.

200. *Id.* at 560.

avoided. According to the dissent, the policy of the Code supported this reading of § 548.²⁰¹ To obtain the Code's goal—fair balance between creditors and debtors—a court must be permitted to void “procedurally regular foreclosure sales for low prices (and thereby return[] a valuable asset to the bankruptcy estate).”²⁰² Souter stated that this “is plainly consistent with those policies of obtaining a maximum and equitable distribution for creditors and ensuring a ‘fresh start’ for individual debtors, which the Court has often said are at the core of federal bankruptcy law.”²⁰³

The majority had also relied on the federalism canon of *Gregory v. Ashcroft*²⁰⁴ to assert that, based on the state's interest in security of titles, the Code must “be presumed to contain an implicit foreclosure-sale exception, which Congress must override expressly or not at all.”²⁰⁵ The dissent argued that the plain language of the Code rejected a requirement that Congress supply “clearer textual guidance.”²⁰⁶ According to the dissent, *BFP* was distinguishable from *Gregory* because the “authority of the States in defining and adjusting the relations between debtors and creditors has never been plenary, nor could it fairly be called ‘essential to their independence.’”²⁰⁷ The dissent argued that the majority had allowed state practice to trump the federal Bankruptcy Code by allowing each state's practice to determine the value of property.²⁰⁸ As the dissent pointed out, the majority failed to follow the past decisions of the Court which held that “state regulation must yield to the extent it actually conflicts with federal law.”²⁰⁹ Thus, Justice Souter argued, “the Court's opinion . . . evinces no special appreciation of the fact that this case arises under the Bankruptcy Code, which, in maintaining the national system of credit and commerce, embodies policies distinct from those of state

201. *See id.* at 562-63.

202. *Id.* at 563.

203. *Id.*

204. *Gregory v. Ashcroft*, 501 U.S. 452 (1991). *Gregory* concerned the state's authority to determine the qualifications of state officials, i.e., the retirement age of state judges.

205. *BFP*, 511 U.S. at 565.

206. *Id.* at 565-66 (citing *Dewsnup v. Timm*, 502 U.S. 410, 417 (1992) (holding that when the Code is silent or ambiguous it should not be read as departing from previous practice); *United States v. Ron Pair Enters., Inc.*, 489 U.S. 235, 240 (1989) (“It is not appropriate or realistic to expect Congress to have explained with particularity each step it took.”)).

207. *Id.* at 565 n.17. Further, the dissent stated that the “Court converts a stray phrase in [*Zeiss*] . . . into a pronouncement about the allocation of responsibility between the National Government and the States.” *Id.* (citations omitted).

208. *See id.* at 567 (relying on *Adams Fruit Co. v. Barrett*, 494 U.S. 638, 648 (1990)).

209. *Id.* at 567-68 (citing *Cipollone v. Liggett Group, Inc.*, 505 U.S. 504, 545, 546 (1992) (Scalia, J., concurring in judgment in part and dissenting in part)); *Perez v. Campbell*, 402 U.S. 637, 651-52 (1971).

debtor-creditor law . . . and which accordingly endows trustees with avoidance power beyond what state law provides.”²¹⁰ Further, the dissent conceded that even if the policy favoring security of title should count more and the “important” bankruptcy policies count less, Congress was the appropriate body to provide a foreclosure-sale exception.²¹¹

Thus, Justice Souter found that the meaning of the Code was “clear,” “coherent,” and “consistent.”²¹² Despite the important state interest involved, the dissent refused to depart from the “plain Code meaning.”²¹³ According to the dissent, the Court frustrated Congress’s clear intent through its reading of § 548.²¹⁴ The dissent urged that effect be given to the statute that Congress wrote authorizing the trustee to avoid transfers, including foreclosure sales, for less than the reasonably equivalent value.²¹⁵

In their foreword to the Harvard Law Review, William Eskridge and Philip Frickey label *BFP* a “clumsy move” on behalf of the Court.²¹⁶ *BFP* radically expanded *Gregory* into the majority opinion in what they argue is “an approach at odds with the Constitution’s Supremacy Clause.”²¹⁷ They find Justice Scalia’s opinion lacking in judicial candor²¹⁸ because of the “unsupportable formalist gloss” it gives to “its policy-driven result.”²¹⁹ The country, they assert, will feel the impact of *BFP* through the doubt it creates over the meaning of the Code, because it leaves unanswered when and how the text of the Code will be overridden because of state interests or any other policy.

210. *Id.* at 563 n.15 (citations omitted). Souter stated, “a central premise of the bankruptcy avoidance powers is that what [sic] state law plainly allows as acceptable or ‘fair,’ as between a debtor and a particular creditor, may be set aside because of its impact on other creditors or on the debtor’s chances for a fresh start.” *Id.* at 564.

211. *Id.* at 569 (citation omitted).

212. *Id.* at 566. Further the dissent goes on to say “[e]ven if the plain language is insufficiently ‘clear guidance’ for the Court, further guidance is at hand here. The provision at hand was amended in the face of judicial decisions driven by the same policy concerns that animate the Court, to make plain that foreclosure sales and other ‘involuntary’ transfers are within the sweep of avoidance powers.” *Id.* at 566 n.18.

213. *Id.* at 566 (citations omitted).

214. *See id.*

215. *Id.* at 570.

216. *See* William N. Eskridge & Philip P. Frickey, *Foreword: Law as Equilibrium (The Supreme Court, 1993 Term)*, 108 HARV. L. REV. 26, 83 (1994).

217. *Id.* at 84 (citation and footnote omitted). The authors noted that *Gregory* involved federal regulation of state governments themselves, which is strikingly different from federal regulation interfering with state property law. Further they question that the Court failed to mention *Gregory* in either *Holder v. Hall*, 512 U.S. 874 (1994), or *Johnson v. De Grandy*, 512 U.S. 997 (1994), both cases involving direct regulation by the federal government.

218. *See id.* at 84.

219. *Id.*

As they also maintain, *BFP* presents a problem for the Court because it produces “stealth constitutionalism”—created through the Court’s use of clear statement rules to promote its own chosen “underenforced constitutional norms.”²²⁰ Noting that Scalia’s opinion failed to analyze any constitutional concerns, Eskridge and Frickey label the case as a “bait and switch.”²²¹ Namely, the Court entices Congress to act a certain way and then it switches the rules. Eskridge and Frickey charge that instead of making law a “more predictable regime,” *BFP* leaves the Code’s interpretation less predictable than before.²²²

More practically, it is unclear whether *BFP* will apply to foreclosure bids made by mortgagees since the decision was made in the context of a third-party purchaser.²²³ When a mortgagee bids on its own collateral, the majority position loses much of its persuasive force. As the dissent pointed out, it is in the mortgagee’s interest to only bid the amount of the indebtedness. If the mortgagee bids more, it is turned over to the debtor or other creditors, but when the mortgagee bids the price of the indebtedness and then turns around and sells the real estate at a profit, it pockets the difference. Prior to *BFP*, some courts only applied the *Madrid* conclusive presumption approach when there was a successful third-party purchaser. Thus, based on these factors, courts may find the Supreme Court’s free market approach untenable.²²⁴ Based on the Supreme Court’s reliance on a state’s legitimate interest in protecting the titles of real estate, however, the success of this position is unlikely.²²⁵ The impact of *BFP* on the debtor and junior lienholder will be to move their challenge from the sale price to the foreclosure sale procedure under state law.²²⁶ Thus, it becomes imperative that both the lender and the bankruptcy trustee know the applicable state foreclosure law grounds

220. *Id.* at 85. “The Court can enforce its own constitutional values without directly confronting Congress when it requires a clear statement from Congress when their “statutes venture close to—but not beyond—a constitutional periphery.” *Id.*

221. *Id.* (“[W]hen Congress enacted the statutes in question [referring to *BFP* and *Gregory*], the constitutionality of the state-infringing provisions was clear and Congress could not have anticipated the *Gregory* rule; nor could a reasonable observer have predicted the expansion of *Gregory* in *BFP*.”).

222. *See id.* at 86.

223. *See generally* Audy M. Perry, Jr., Comment, *BFP v. Resolution Trust Corporation: Supreme Court Shifts Focus Onto State Law in Ruling on Mortgage Foreclosure Sales*, 97 W. VA. L. REV. 255 (1994).

224. *See* Kenneth M. Block & Jeffrey B. Steiner, *Ending the Threat of “Durrett”*: *BFP Settles Application of Fraudulent Transfer to Foreclosures*, N.Y.L.J., July 20, 1994, at 5.

225. *See id.* at 6.

226. *See* Barr v. Allen, 170 B.R. 772, 776 (Bankr. E.D.N.Y. 1994) (noting the only issue for the court was “whether the foreclosure sale *sub judice* was accordant procedurally and substantively with applicable South Carolina state foreclosure law”).

for attacking involuntary transfers, including irregular foreclosure procedures, inadequate price, and collusion.

The Supreme Court's decision in *BFP* may also affect fraudulent conveyance claims in relation to other involuntary judgments. In the real estate tax sales context, the courts have divided over the applicability of *BFP*. Some courts have distinguished *BFP* based on a footnote in the opinion limiting the decision to cover "mortgage foreclosure of real estate" and noting that "considerations bearing upon other foreclosures and forced sales (to satisfy tax liens, for example) may be different."²²⁷ But other courts have followed *BFP* under the rationale that a tax sale is "as much a forced sale process as a mortgage foreclosure."²²⁸ Although *BFP* operates to make inadequate price irrelevant for determining "reasonably equivalent value" under the Code, it may still be a valid ground for setting aside a sale under state foreclosure law. In *Barr v. Allen*, the bankruptcy court upheld a sale after analyzing the sale price under the state's substantive foreclosure law to determine if the price was so low as to shock the conscience or raise a presumption of fraud or unfairness.²²⁹ Since the Court's decision, *BFP* has been extended to apply to both state land sale contract forfeitures²³⁰ and unauthorized post-petition tax foreclosure sales,²³¹ but not personal property forfeitures or forced sales of personal property.²³²

BFP and *Deprizio* illustrate the use of formalist methods by two leading judges. As Judge Easterbrook's use of formalism in the

227. *BFP v. Resolution Trust Corp.*, 511 U.S. 531, 537 n.3 (1994); see *D'Alfonso v. A.R.E.I. Inv. Corp.* (*In re D'Alfonso*), 211 B.R. 508, 517-18 (Bankr. E.D. Pa. 1997); *Jones v. C&M Invs.* (*In re Jones*), 209 B.R. 380, 386 (Bankr. E.D. Va. 1997). See generally *Butler v. Lejcar* (*In re Butler*), 171 B.R. 321 (Bankr. N.D. Ill. 1994).

228. *McGrath v. Simon*, 170 B.R. 78, 82 (Bankr. D.N.J. 1994); see also *In re Samaniego*, 224 B.R. 154 (Bankr. E.D. Wash. 1998); *Russell-Polk v. Bradley* (*In re Russell-Polk*), 200 B.R. 218 (Bankr. E.D. Mo. 1996). But *BFP* may not apply to "tax foreclosure" sales. *In re Sherman*, 223 B.R. 555, 558 (B.A.P. 10th Cir. 1998).

229. See *Barr*, 170 B.R. at 776-77.

230. See *Vermillion v. Scarbrough*, 176 B.R. 563, 569-70 (Bankr. D. Or. 1994) (court found that *BFP* had equal relevance in the context of Oregon land sale contract forfeitures where debtor in possession sought recovery); see also *McCanna v. Burke*, 197 B.R. 333 (D.N.M. 1996). But see *Dunbar v. Johnson* (*In re Grady*), 202 B.R. 120, 125 (Bankr. N.D. Iowa 1996) (holding *BFP* does not apply to land sale contract forfeiture).

231. See *T.F. Stone Co. v. Harper*, 170 B.R. 884, 892 (Bankr. N.D. Tex. 1994), *aff'd*, 72 F.3d 466 (5th Cir. 1995) ("The Supreme Court's rationale to protect *bona fide* purchasers appears to be no less applicable to a § 540 transfer in a non-collusive tax foreclosure sale as it is in a § 548 transfer by way of a mortgage foreclosure sale."). But see *Shaw v. County of San Bernadino*, 157 B.R. 151 (B.A.P. 9th Cir. 1993).

232. See *Carter v. H&B Jewelry & Loan* (*In re Carter*), 209 B.R. 732, 735-37 (Bankr. D. Or. 1997) (refusing to extend *BFP* rationale to a case where debtor forfeited property to a pawn shop); see also *In re Prince Gardner, Inc.*, 220 B.R. 63 (Bankr. E.D. Mo. 1998).

context of *Deprizio* indicates, judges can seldom rely on formalism or interpositive methodology alone. Indeed, in *Deprizio*, as we noted, Judge Easterbrook employed an approach which considered both the legislative history and purpose of the relevant statutory section. Justice Scalia's use of the history of bankruptcy and state mortgage laws, along with what commentators have concluded are his hidden policy considerations in *BFP*, buttress this point. The remainder of this Article will show how the disciplines of cognitive psychology and fuzzy logic illuminate the reasoning processes used by formalists and antiformalists while also demonstrating how these models of judicial decision making might inform efforts to improve statutory interpretation of complex statutes.

II. A FORMALIST'S GUIDE TO PRACTICAL REASONING AND FUZZY LOGIC

In Part I, we provided a "thick description" of formalist reasoning in action. The stereotypical formalist judge decides cases in a matter of minutes, aided only by a dictionary and a list of canons of interpretation. If Part I does nothing else, it should demonstrate that formalist methods are far more complex in practice. In Part II, we explore the kinds of judicial reasoning that formalists use just as much as other judges. In the first section, we show that formalist judges cannot avoid reliance on expert judgment when applying their methods. The next two sections attempt to explore in greater depth what is involved in the application of expert judgment. We consider cognitive psychologists' research on expert decisionmaking, then turn to the use of fuzzy logic to model expert decisionmaking in the legal context, by developing such a model for the *Deprizio* decision.

A. "Judgment Calls" and the Formalist Judge

Justice Scalia's opinion in *BFP* provides a useful insight into formalist methods. The majority in *BFP* interpreted "reasonably equivalent value" in § 548 to mean whatever price was received at a regularly conducted foreclosure sale, and not, as urged by the parties and the dissent, "fair market value" or a "fair and proper price."²³³ It rejected "fair market value" based on an *expressio unius est exclusio*

233. *BFP v. Resolution Trust Corp.*, 511 U.S. 531, 545 (1994).

alterius argument.²³⁴ Likewise, it rejected a “fair and proper price” interpretation because of a lack of congressional intent and the history of fraudulent transfer law and foreclosure law.²³⁵ The majority found an essential state interest in the security of title to real estate—a core state function, which can only be disrupted by Congress with a clear statement of intent. Absent such clear, contrary congressional intent, and based upon the conditions at a foreclosure sale, the Court found that free market rules were inapplicable. The Court instead replaced the free market rules with a state’s laws governing forced sales, which ultimately become the only tool for measuring value.²³⁶

To deride this approach as mindless literalism would be a mistake. On the contrary, Justice Scalia’s approach extends beyond (and perhaps even “against”) the dictionary meaning of the phrase in dispute to include a fairly rich array of other factors. Indeed, apart from his steadfast refusal to consider legislative debates and committee reports—a position in which he is now apparently almost alone on the Court—his approach seems to contain nearly the full range of considerations that might be thought relevant.²³⁷

Judge Easterbrook’s approach in *Deprizio* provides another illustration of formalist methods.²³⁸ Easterbrook relied upon the unambiguous language of §§ 547 and 550(a). Mandating an “ordinary” reading, the Seventh Circuit found that the debtor engaged in preferential transfers and allowed the trustee to recover from the initial transferees, the lenders.²³⁹ The Seventh Circuit relied upon the plain language of the Code in rejecting both the equitable arguments and the “two-transfer” theory that the lower courts advocated.²⁴⁰ Easterbrook also found support from the purpose of the Code in maintaining bankruptcy as a collective proceeding for the determination

234. *Id.* at 537. Since the term is used elsewhere in the Code, and it is presumed Congress acts intentionally, Congress must have meant something else by its use of “reasonably equivalent value” in the fraudulent conveyance context.

235. *See id.*

236. *See id.* at 537, 545.

237. On the evolution of textualist analysis beyond literalist application of dictionaries, see Lawrence M. Solan, *Learning Our Limits: The Decline of Textualism in Statutory Cases*, 1997 WISC. L. REV. 235, 236-40. A recent empirical study of Supreme Court statutory interpretation decisions confirms that the Court relies on a wide range of legal sources, including judicially created policy norms. *See* Jane S. Schacter, *The Confounding Common Law Originalism in Recent Supreme Court Statutory Interpretations*, 51 STAN. L. REV. 1, 18, 21-28 (1998).

238. *Levit v. Ingersoll Rand Fin. Corp. (Deprizio)*, 874 F.2d 1186 (7th Cir. 1989).

239. *Id.* at 1197.

240. *Id.* at 1195-99.

and payment of debts.²⁴¹ In allowing recovery from the initial transferee under § 550(a), Easterbrook rejected the "barking dog" technique advocated by the lenders.²⁴² Instead, he found that a silent legislative history did not allow a court to depart from the clear and unambiguous text of the Code.²⁴³

A central question at this point is whether formalist judges like Scalia and Easterbrook even need practical reason. The answer is a resounding "yes." Perhaps the need for practical reason is most obvious in connection with the canons that formalist judges use. As Llewellyn demonstrated, the traditional canons can be readily arranged in conflicting pairs.²⁴⁴ Typically, the two canons in a given pair are not directly contradictory, but instead their domains are defined by qualifications such as "unless the context dictates otherwise." Application of these conflicting canons may require a good deal of skilled judgment. Moreover, the statutory language in any given case may trigger more than one canon. For example, different grammatical features of the text may evoke conflicting canons, or a text-based canon may cut against a policy-based canon like the rule of linguistic lenity.²⁴⁵

The possibility of such conflicts cannot be eliminated without drastic surgery on the body of canons. As Cass Sunstein points out, "[t]he only way to reduce the risk of conflicting interpretive principles is to produce a system with one or very few such principles" but any such "simple system will contain an unacceptably high potential for an unacceptably large number of errors."²⁴⁶ Given the traditional set of canons, which Scalia endorses, statutory interpretation must sometimes involve conflicting canons and therefore the need to exercise judgment.

Even eliminating the canons in favor of pure textualism would not reduce statutory interpretation to a mechanical task. Modern courts often confront statutes that are lengthy and complex. Deciding what interpretation of a particular clause best fits the overall text of the Internal Revenue Code, the Clean Air Act, or the Uniform Com-

241. *See id.* at 1197.

242. *Id.* at 1195-96.

243. *See id.* at 1196.

244. *See* K. LLEWELLYN, *THE COMMON LAW TRADITION: DECIDING APPEALS* 401-06 (1960); *see also* Ronald F. Wright, *Letters from Beyond the Regulatory State*, 100 *YALE L.J.* 825, 839-40 (1990) (book review).

245. Moreover, as Nicholas Zeppos points out, the "plain meaning" of two provisions may conflict. Nicholas S. Zeppos, *Justice Scalia's Textualism: The "New" New Legal Process*, 12 *CARDOZO L. REV.* 1597, 1627 (1991).

246. Cass R. Sunstein, *Principles, Not Fictions*, 57 *U. CHI. L. REV.* 1247, 1254 (1990).

mercial Code is a demanding process.²⁴⁷ The judge must determine which conflicting interpretation has the best coherence with the overall sense of the statute. This determination obviously requires a good deal of judgment, not to mention expertise.²⁴⁸ Justice Scalia's textualism is ultimately based on his desire to cabin judicial discretion in order to avoid reliance on the "judge's own views of justice, fairness, or social welfare."²⁴⁹ If the issue, however, is not the dictionary meaning of a particular clause, but the interpretation that produces the best "fit" with a complex statute, the judge's decision must seemingly retain an element of discretionary judgment.

Judges could avoid these difficulties by resorting to clause-bound plain meaning. Under that approach, the judge would first determine the clause of the statute that controls the dispute. She then would pick the meaning that would be most likely adopted by an English speaker who knew nothing about the purpose of the statute, surrounding provisions of the statute, the statute's history, other aspects of the legal context, or American social and cultural norms. The reasons for eschewing that approach, however, are sufficiently obvious to deprive it of any support among writers on jurisprudence, let alone practicing judges. Any method of interpretation sufficiently complex to be seriously considered sometimes will require the use of practical reasoning. Thus, no plausible system of interpretation truly can be distilled to noncontroversial deductions from a set of rules.

Indeed, even the most rigorous formalism could not eliminate the need for practical reasoning by appellate judges. As Llewellyn pointed out, parties are unlikely to appeal clear-cut cases.²⁵⁰ For instance, once a strong presumption in favor of ordinary meaning is in place, the cases most likely to reach appellate courts are those that remain debatable even given the presumption, either because the ordinary meaning seems ambiguous or because the countervailing considerations are unusually strong. In those cases, operating at the margin of the domain of ordinary meaning, the appellate judge must exercise judgment about whether the totality of other relevant principles overcome ordinary meaning. In short, as H.L.A. Hart recognized,

247. The search for "horizontal" coherence within a statute is an important part of Justice Scalia's method. See William N. Eskridge, Jr., *The New Textualism*, 37 U.C.L.A. L. REV. 621, 660-63 (1990). For an insightful discussion of statutory interpretation in tax law, see Michael Livingston, *Congress, the Courts, and the Code: Legislative History and the Interpretation of Tax Statutes*, 69 TEX. L. REV. 819 (1991).

248. See, e.g., Livingston, *supra* note 247, at 826-31.

249. Zeppos, *supra* note 245, at 1619 (footnote omitted).

250. See LLEWELLYN, *supra* note 244, at 398.

any system of rules will inevitably require the exercise of "discretion" in hard cases,²⁵¹ and any plausible vision of formalism must acknowledge that reality. Formalism might plausibly attempt to diminish the number of hard cases or their practical significance, but not to eliminate them.

*B. Analyzing Legal Problems: Practical Reasoning
and Expert Judgment*

While formalists have focused on the structure of rules that judges use, their primary intellectual opponents have focused on the interaction between rules and the concrete cases confronting judges. Tending to downplay the importance of rules, they focus on the "practical reason" that judges use when applying law to a particular case.

Frank Michelman has observed that practical reasoning "seems always to involve a combination of something general with something specific," so that judgment "mediates between the general standard and the specific case."²⁵² In applying a standard, we must interpret it, thereby reconstructing "the standard's meaning and rightness."²⁵³ Michelman also notes that "[t]his process, in which the meaning of the rule emerges, develops, and changes in the course of applying it to cases is one that every common law practitioner will immediately recognize."²⁵⁴ Practical reason, then, is a search for contextual justification for the best legal answer among the potential alternatives.²⁵⁵ Or, to use an image common in discussions of practical reasoning, justification is thought to be more of a web than a tower, drawing on the coherence of many sources rather than building on a single unified foundation.

Advocates of practical reasoning have attempted to explain the methods that they believe judges (and particularly the best judges)²⁵⁶

251. H.L.A. HART, *THE CONCEPT OF LAW* 138-44 (1961). This discussion should not be read to imply that practical reasoning is absent from the decision of easy cases. It is an open question whether hard cases trigger additional cognitive skills, or whether instead easy cases merely involve very simple applications of the same cognitive skills involved in deciding hard cases.

252. Frank I. Michelman, *Foreword: Traces of Self-Government (Supreme Court Term 1985)*, 100 HARV. L. REV. 1, 28 (1986); see also Mark V. Tushnet, *Colloquy: The Degradation of Constitutional Discourse*, 81 GEO. L.J. 251, 252-53 (1992).

253. Michelman, *supra* note 252, at 28.

254. *Id.* at 28-29.

255. See John Stick, *Can Nihilism Be Pragmatic?*, 100 HARV. L. REV. 332, 349 (1986).

256. Justice Cardozo's own description of the decisional process comes to mind in this regard. See generally BENJAMIN N. CARDOZO, *THE NATURE OF THE JUDICIAL PROCESS* (1921).

use to decide hard cases. Those efforts are often attacked as banal²⁵⁷ or vacuous,²⁵⁸ and admittedly are much less precise than one might wish. On the other hand, many other cognitive skills also are extremely difficult to explain (for example, the ability to determine the correct swing path for hitting a golf ball) yet these skills obviously exist. Given our general ignorance of the functioning of the human brain, it is not surprising that we cannot give a convincingly detailed account of how a difficult task, such as deciding a hard case, is accomplished.

The vagueness of these descriptions of practical reasoning has given ammunition to critics who find it a vacuous concept. However, there seems to be no escape from the need to make judgments in situations where various rules and canons collide or contain ambiguities and gaps. Formalists may regret rather than celebrate the need for judges to make "judgment calls," but they cannot escape the necessity of practical reasoning. It behooves us, then, to attempt to clarify as much as possible the nature of the cognitive processes involved.

Although only a limited amount of work has been done regarding legal decisionmaking,²⁵⁹ a broader body of literature has examined how experts in various other fields make decisions. The study of expertise has been a fruitful field of study for psychologists over the past twenty years. Some of this interest grows out of the field of Artificial Intelligence ("AI"), motivated by a desire to design computer systems that can mimic the decisions of human experts.²⁶⁰

One of the first efforts toward AI was through the game of chess. For this reason, chess expertise has been the subject of considerable study. The basic strategy for building a chess-playing computer is to project the play forward as many moves as possible, con-

257. See CASS R. SUNSTEIN, *AFTER THE RIGHTS REVOLUTION: RECONCEIVING THE REGULATORY STATE* 149 (1990).

258. See RICHARD POSNER, *THE PROBLEMS OF JURISPRUDENCE* 452 (1990) (critiquing Farber and Frickey).

259. See generally Jeanette A. Lawrence, *Expertise on the Bench: Modeling Magistrates' Judicial Decision-Making*, in *THE NATURE OF EXPERTISE* 229-60 (Michelene T.H. Chi et al., eds., 1988); Anthony Palasota, *Expertise and the Law: Some Recent Findings From the Cognitive Sciences About Complex Human Information Processing*, 16 *T. MARSHALL L. REV.* 599 (1991); Edwina L. Rissland, *Artificial Intelligence and Law: Stepping Stones to a Model of Legal Reasoning*, 99 *YALE L.J.* 1957 (1990). For a recent review of the literature, see Ian Weinstein, *Lawyer-ing in the State of Nature: Instinct and Automaticity in Legal Problem Solving*, 23 *VT. L. REV.* 1 (1998).

260. Perhaps it is not unfair to note that this project is in some sense the epitome of formalism, literally trying to reduce a decisionmaking process to the mechanical application of rules. The ideal formalist judge would be a well-programmed computer. As we suggest at the end of this Article, the most plausible model of judicial decisionmaking involves "fuzzy" rules. In principle, a suitably designed computer would conceivably follow these rules.

sidering variables such as each possible move, the opponent's possible responses, and the computer's best counter-responses. The initial assumption was that chess masters differed from novices by their ability to see more moves ahead in the game. As it turned out, however, chess masters do not typically look farther ahead in the game; if they did, they would be unable to perform such feats as "lightning chess" against multiple opponents. Instead, they differ from novices in another respect, which a classic series of experiments revealed.²⁶¹

In these experiments, the subjects were briefly shown a slide of a chess board and afterwards asked to recall the positions of the thirty-six game pieces. Novices were lucky to be able to remember the positions of five or six pieces after seeing a board for five seconds. Chess masters were able to reconstruct the positions of twenty pieces, and were also much better at retaining this knowledge after interruptions. But in other areas, chess masters have no better than average memories.²⁶²

The most intriguing finding was that chess masters did not have a particularly good recall for the positions of individual pieces.²⁶³ Rather, their advantage was limited to those positions that might result from real games. For example, when chess pieces were randomly placed on the board, the chess masters did little better than the novices. Moreover, when recalling real chess positions, chess masters did not place the pieces on the board on an individual basis but in clusters of strategically meaningful groups, like pawn chains.²⁶⁴ Based on experiments of this sort, researchers concluded that chess masters have learned something on the order of fifty thousand different chess patterns, along with typical tactics associated with each position. Thus, chess masters normally do not have to reason laboriously about which piece to move and how their opponent may respond, because they immediately "see" the next move. In short, the experts "chunk" the information into meaningful units—they recognize patterns and associate those patterns with potential strategies.²⁶⁵

Other studies of expertise confirm the crucial importance of this type of sophisticated pattern recognition. In a study of how experts and novices solve physics problems, researchers found that experts actually took longer to categorize the problems than the nov-

²⁶¹ For a description of these classic experiments, see JOHN R. ANDERSON, *COGNITIVE PSYCHOLOGY AND ITS IMPLICATIONS* 243-45 (2d ed. 1985).

²⁶² Nor, typically, are chess masters particularly intelligent outside of their field. *See id.*

²⁶³ *See id.*

²⁶⁴ *See id.*

²⁶⁵ *Id.*

ices.²⁶⁶ The novices tended to classify on the basis of superficial features (“this involves an inclined plane”), while the experts looked for deeper principles (“this involves energy conservation”). Once they had classified the problem, however, the experts proceeded much more directly, quickly, and accurately to the solution.²⁶⁷ Their mental categories also were connected directly with solution methods, which experts could readily call up once they had classified the problem.²⁶⁸ Although these studies primarily have involved experts in fields where spatial and visual information is important, like architecture and athletics, they clearly demonstrate the requisite expert’s ability “to detect and remember patterns in complex sets of phenomena that are essentially invisible to novices.”²⁶⁹

A particularly relevant study involved expert radiologists. Like physicists, expert radiologists spent more time interpreting X-rays than novices in their preliminary assessment of how to categorize the problem situation.²⁷⁰ After they made this categorization, the experts moved rapidly to solutions.²⁷¹ Their categorization tended to be much more accurate and to provide more coherent explanations.²⁷² Notably, experts were more willing than novices to discard their preliminary assessment in the light of new information (or newly noticed features of the X-ray.)²⁷³

This study seems especially relevant based upon the apparent similarity between medical diagnosis and legal reasoning.²⁷⁴ Despite the expectation that physicians would rely on their understanding of the basic sciences and the application of the scientific method in making diagnoses, the studies in fact demonstrated the opposite.²⁷⁵ Expert physicians rely more heavily on their experience in examining

266. *See id.*

267. *See* Michelene T.H. Chi et. al., *Categorization and Representation of Physics Problems by Experts and Novices*, 5 COGNITIVE SCI. 121, 134 (1981).

268. *See id.* at 139.

269. *Id.* at 141.

270. Alan Lesgold et al., *Expertise in a Complex Skill: Diagnosing X-ray Pictures*, in THE NATURE OF EXPERTISE, *supra* note 259, at 311-42.

271. *See id.*

272. *See id.*

273. *See id.*

274. *See* Steven L. Winter, *The Cognitive Dimension of the Agon Between Legal Power and Narrative Meaning*, 87 MICH. L. REV. 2225, 2262-67 (1989) (explaining the use of cognitive models in legal reasoning and the relationship with Llewellyn’s “situation sense”). Reasoning by analogy, which is important in law, has also been the subject of recent research, as seen in Laura R. Novick & Keith J. Holyoak, *Mathematical Problem Solving by Analogy*, 17 J. EXPERIMENTAL PSYCH.: LEARNING, MEMORY, & COGNITION 398 (1991), and Cass R. Sunstein, *Problems with Rules*, 83 CAL. L. REV. 953 (1995).

275. *See* Chi, *supra* note 267, at 134.

and treating patients than on their biomedical knowledge of the underlying disease process.²⁷⁶ Apparently, practicing physicians make "virtually no use of basic science knowledge."²⁷⁷

Admittedly, the study of expertise by psychologists is relatively primitive, and further research may unseat current psychological dogma. Moreover, legal expertise may require some skills different than those involved in the areas that have been studied most intensively.²⁷⁸ Nevertheless, these results suggest some possible insights about how legal experts may learn to make decisions.

If neither psychologists nor the experts themselves can give a detailed account of the ability to make expert decisions, how is it possible for experts to acquire the skill? Typically, experts acquire skill by following examples²⁷⁹ and through practice, with large doses of the latter. Herbert Simon estimated that chess masters have spent ten to twenty thousand hours staring at chess positions, the equivalent of full-time study for ten academic years on a single subject.²⁸⁰ Similarly, a radiologist's knowledge may be based upon the examinations of ten thousand to two hundred thousand films.²⁸¹ The foundation of expertise, like that of the law, seems to be experience more than logic.

Moreover, these studies reveal expertise to be more than an act of intuitive perception. Expert radiologists did not merely perceive x-rays more accurately, they gave better reasons for their interpretations and were better able to test them against additional information.²⁸² Similarly, the exercise of practical reasoning by judges is not a mystical intuitive act, but an effort to understand and reason through a problem, which is subject to criticism and assessment by legal observers.

In sum, this body of literature provides three major conclusions about how experts make decisions.²⁸³ First, expertise does not simply consist of knowing a greater number of facts or rules. It also involves the crucial ability to pick out the key features of a new situation. Second, this skill is learned primarily through experience with

276. *See id.*

277. *Id.*

278. But a recent empirical study indicates that experienced lawyers indeed utilize many of the same methods as other experts. *See Weinstein, supra* note 259, at 24-40.

279. In this case, from the problems that others solve.

280. *See THE NATURE OF EXPERTISE, supra* note 259, at xxxi.

281. *See Lesgold, supra* note 270, at 312.

282. *See id.* at 310-13, 320-23.

283. For a more detailed discussion, see Daniel A. Farber, *The Inevitability of Practical Reason: Statutes, Formalism and the Rule of Law*, 45 VAND. L. REV. 533, 534-38 (1992).

large numbers of past situations.²⁸⁴ Third, expertise is not merely an act of intuitive perception. As noted above, expert radiologists do not merely perceive x-rays more accurately than novices; they give better reasons for their interpretations and are better able to test those interpretations against additional information.²⁸⁵

Assuming these findings carry over to law, we would expect judicial decision-making to have several characteristics. First, regardless of the judge's favored methodology, use of that methodology will involve the use of pattern analysis. Second, the judge's pattern analysis will identify and categorize the salient facts and link those facts with relevant legal interpretations. Third, the judge's ability to conduct this pattern analysis is at least as much a function of experience and training as of raw ability or knowledge of legal theories. Formalist and antiformalist judges alike must engage in this type of pattern analysis before they can apply their favored legal methods to the cases before them.

C. Applying Legal Rules: Fuzzy Logic and Its Applications

Consider the task facing a formalist judge when confronting a new case. First, the judge must take a relatively unformed legal problem and translate it into formalist terms. For example, the judge must decide what statutory text is most relevant (which usually means an overall understanding of the operation of the statute) and

284. Consider the following analysis of the nature of expertise:

The expert spends proportionally more time building up a basic representation of the problem situation before searching for a solution The novice takes much longer but devotes a small proportion of his total processing time to finding/generating an initial problem representation. In some domains, even the absolute time spent on building the right initial representation is longer for experts.

A schema with a high probability of being at least in the right problem space is invoked very rapidly by the expert. This schema guides further processing, including the building of a basic representation.

Experts are able to tune their schemata to the specifics of the case. This permits them to test more completely whether the schema they have invoked is in fact the right one.

Lesgold, *supra* note 270, at 312. This description is strikingly similar to Steve Winter's account of the everyday use of experience-based cognitive templates by nonexperts. See Winter, *supra* note 274, at 2225.

285. As the radiology example indicates, belief in practical reasoning does not imply skepticism about reality. Knowing, for example, that radiologists use practical reasoning rather than formalist methods provides no reason to doubt the reality of the cancers they diagnose. Nor does practical reasoning suggest any reason to embrace value relativism. On the contrary, practical reasoning suggests that our ordinary moral judgments are defensible rather than merely arbitrary. Finally, contrary to a view that advocates of storytelling sometimes express, practical reasoning is a form of rational decisionmaking, not an alternative to rationality.

what canons of interpretation apply to the case. As the previous section demonstrated, cognitive psychologists have studied the kinds of pattern analysis involved in this kind of expert judgment. Second, we have already seen that in any case interesting enough to reach an appellate court, multiple factors will bear on the result. For example, relevant language in more than one clause may need to be reconciled or several canons of interpretation arguably may apply. Moreover, these factors themselves are not bivalent. The meaning of a particular clause is rarely perfectly clear, and a canon of interpretation may apply with more or less strength in a given situation. Somehow, the formalist judge must combine these factors to reach a decision in the case. In this section, we will examine how the discipline of fuzzy logic provides a model for this second phase of the decision-making process.

1. Basic Principles

As almost everyone else, judges usually speak and write in bivalent terms. An especially rigorous type of this bivalent logic is used extensively in certain technical fields, including mathematics and computer science, where it is particularly useful to work with strings of zeroes and ones and to eliminate fractions. In employing this type of logic, however, one “trades accuracy for simplicity.”²⁸⁶ The alternative descriptions “my lawn is green” and “my lawn is brown” are bivalent statements. They describe one’s view of the lawn. Yet, rarely is either precisely accurate—grass is seldom completely green or completely brown.

Fuzziness, or multivalence, is useful everywhere between these two extremes. A fuzzy interpretation of the statement “the lawn is green” takes the statement to be a partial truth.²⁸⁷ Fuzziness attempts to capture a more nuanced and precise picture of the world, not merely a bivalent description of it. Fuzziness does not, however, reject absolutes—multivalence reduces to bivalence in extreme cases. Occasionally, a lawn really is purely green or purely brown. Yet, fuzziness recognizes that this description is rarely accurate. More often, a lawn is best described as both green and brown or, in fuzzy terms, as both green and not green. Multivalent logic trades the “rounded-off simplicity of bivalence” for “the expressive power and

286. Kosko & Isaka, *supra* note 5, at 21.

287. *See id.* at 26.

accuracy of fuzziness.”²⁸⁸ Fuzziness recognizes that every statement, every word, is a matter of degree.²⁸⁹

The way that opposing terms blur into each other is familiar to lawyers. Some legal terms, such as “reasonableness” and “good faith,” often seem to consist of nothing other than blurry edges. One of the first lessons of law school, however, is that even seemingly more discrete terms like “offer,” “intent,” and “cause” are blurrier than expected. The same is true of ordinary terms. An hour away from the office is not a vacation, a month on a beach clearly is one, and in between are many absences from work that seem somewhat vacation-like but are not easily classified. To some extent, “vacation” is a matter of degree; the word stands for a fuzzy set of events rather than one side of a crisp dichotomy.

“Fuzzy logic,” a term used to describe technology employed in devices from video cameras to washing machines,²⁹⁰ is nothing more than reasoning with fuzzy sets. In practice, it most often means creating devices that apply fuzzy rules: if-then statements like, “If the clothes are Very Dirty (fuzzy set X), then make the wash cycle Longer (fuzzy set Y).” In mathematical terms, fuzzy if-then rules express the relation between fuzzy sets. Each rule, in turn, defines a “fuzzy patch,” the product of fuzzy sets X and Y.²⁹¹ “The wider the fuzzy sets [X and Y], the wider and more uncertain the fuzzy patch.”²⁹² Moreover, the fuzzier the fuzzy set, the more the set resembles its own opposite, and the greater its fuzzy entropy. A set with 0% fuzziness is a black and white set; a set that equals its own opposite is a 100% fuzzy set.²⁹³ For readers who are unfamiliar with the basics of fuzzy logic, please refer to the short introduction in Appendix I.

While most complex systems require precise rules in order to run efficiently and accurately, a fuzzy system does not require a sophisticated understanding of the concepts underlying the system. Fuzzy concepts work just as well. As long as the underlying rules are sensible, the system will work. Moreover, once the rules are in place, it is relatively easy to adjust the boundaries of the fuzzy sets in order

288. *Id.* at 29.

289. *See id.* at 122.

290. *See, e.g.,* Michael Schrage, *Looking Ahead to the Smart House*, BOSTON GLOBE, Nov. 28, 1993, at 84 (reporting that fuzzy logic is used in the computer system of a proposed “smart home”); Michael White, *A Woolly Head for Logic*, TIMES MAGAZINE (London), Jan. 22, 1994, at 26 (discussing the uses of fuzzy logic in consumer appliances like camcorders, microwave ovens, and dishwashers).

291. Kosko & Isaka, *supra* note 5, at 292.

292. *Id.*

293. *See id.* at 291.

to streamline the system. The need for such changes become apparent through trial and error. For example, in a system designed to control vehicle braking, if the vehicle is braking too early, one would change the parameters of the fuzzy sets to allow for a shorter distance to the obstacle before braking.

Most fuzzy reasoning techniques fall into two categories: direct and indirect. Direct methods, like that of the braking example, are the most popular and use inference rules as a basis.²⁹⁴ When multiple premises are used, not just a simple "if X then Y" relationship, the determination of the consequence becomes more complex. The most popular direct method for handling multiple input problems is the Mamdani method. This method is structured around minimum and maximum operations.²⁹⁵

Mamdani's direct method for fuzzy reasoning may be readily applied to the fraud issue that the Court in *BFP* addressed.²⁹⁶ In *BFP*, the Court struggled to resolve the fourth element of the constructive fraud definition in § 548 of the Bankruptcy Code: "that the debtor received less than a reasonably equivalent value in the exchange for such transfer."²⁹⁷ Fuzzy reasoning can help to determine if a constructive or even an actual fraudulent transfer exists in the context of a foreclosure sale. In the example that follows, two variables [A, B] constitute the premise and one variable constitutes the consequence [C]. The two premise variables account for the time between notice and sale [A] and the perceived value received from the sale [B]. This simple two input model does not rely solely on the interpretation of "reasonably equivalent value." Instead, the model incorporates rational economic criteria based on a time-to-market equilibrium concept. Basically, a forced-sale occurs either "quickly" or "slowly." Many variables may enter the determination of what constitutes "quick" or "slow," such as the extent and timing of notice, availability of bidding instructions, and whether the sale is private or public.²⁹⁸ However, for introductory purposes, the following example is limited to the aforementioned two input variables. The fuzzy rules are as follows:

294. See KAZUO TANAKA, AN INTRODUCTION TO FUZZY LOGIC FOR PRACTICAL APPLICATIONS 81 (1997).

295. See *id.* at 82.

296. See *BFP v. Resolution Trust Corp.*, 511 U.S. 531 (1994).

297. *Id.* at 535.

298. See Marion W. Benfield, Jr., *Wasted Days and Wasted Nights: Why the Land Acts Failed*, 20 NOVA L. REV. 1037, 1059 (1996); Ronald Benton Brown et al., *Property Law: 1995 Survey of Florida Law*, 20 NOVA L. REV. 257, 276 (1995).

- Rule 1: IF sale is slow [A1]
AND price is low [B1]
THEN do not suspect fraud [C1] (“low” is correct here)
- Rule 2: IF sale is slow [A1]
AND price is high [B2]
THEN suspect fraud on the buyer [C2] (waiting for the “pigeon”)
- Rule 3: IF sale is fast [A2]
AND price is low [B1]
THEN suspect fraud on the seller [C3] (perhaps limited notice)
- Rule 4: IF sale is fast [A2]
AND price is high [B2]
THEN do not suspect fraud [C1]

Rules 1 through 4 can be represented as a rule table shown in Illustration 1.

Illustration 1: Rule Table for Determination of Fraud

	B1	B2
A1	C1	C2
A2	C3	C1

These “ordinary word” rules must then be translated into fuzzy sets. The fuzzy sets representing these ordinary word rules can be expressed as membership functions as shown in Illustrations 2 through 4.

Illustration 2: Membership Function for Speed of Sale

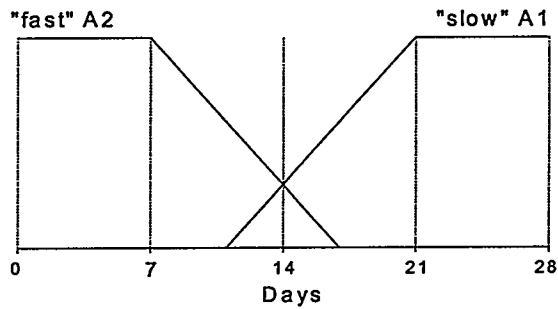

Illustration 3: Membership Function for Perceived Value

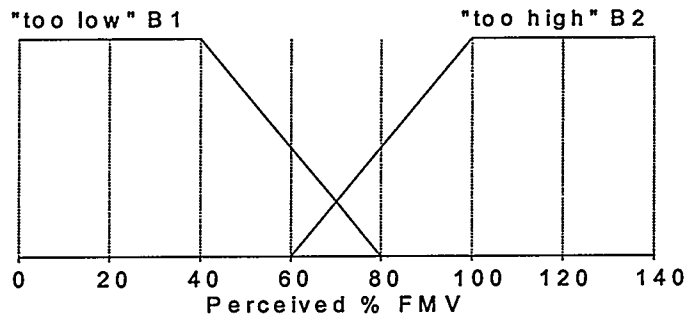
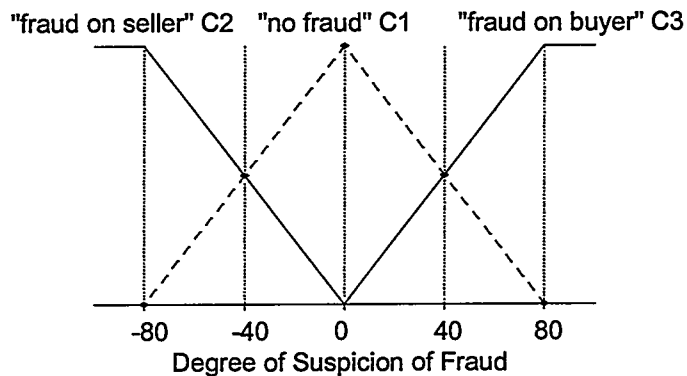

Illustration 4: Membership Function for Suspicion of Fraud



To implement the fuzzy reasoning process, it is necessary to introduce a concept known as rule adaptability.²⁹⁹ To illustrate the adaptability concept, let x represent the fuzzy set A , y represent the

299. See TANAKA, *supra* note 294, at 86.

fuzzy set B, and z represent the fuzzy set C. If x_0 and y_0 are the inputs then,

Adaptability of Rule 1: $w_1 = A_1(x_0) \wedge B_1(y_0)$

Adaptability of Rule 2: $w_2 = A_1(x_0) \wedge B_2(y_0)$

Adaptability of Rule 3: $w_3 = A_2(x_0) \wedge B_1(y_0)$

Adaptability of Rule 4: $w_4 = A_2(x_0) \wedge B_2(y_0)$

where " \wedge ," the logic symbol for "and," is a minimization operation.

Next, the adaptability of each rule is applied to the consequence and a final solution is sought by aggregating the individual conclusions.

Final conclusion $c(z) = c_1(z) \vee c_2(z) \vee c_3(z)$

where " \vee ," the logic symbol for "or," is an aggregation operation.

The reasoning process is illustrated in Illustration 5. To begin the process, input values for x_0 and y_0 are chosen: 12 days and a perceived 65% of fair market value, respectively. Next, these inputs are entered into the rules. Once entered, the adaptability concept is used to determine the output. After the output has been determined for Rules 1 through 4, the consequences are aggregated to yield a final conclusion: slight degree of suspicion of fraud on the seller.

Illustration 5: Reasoning Process

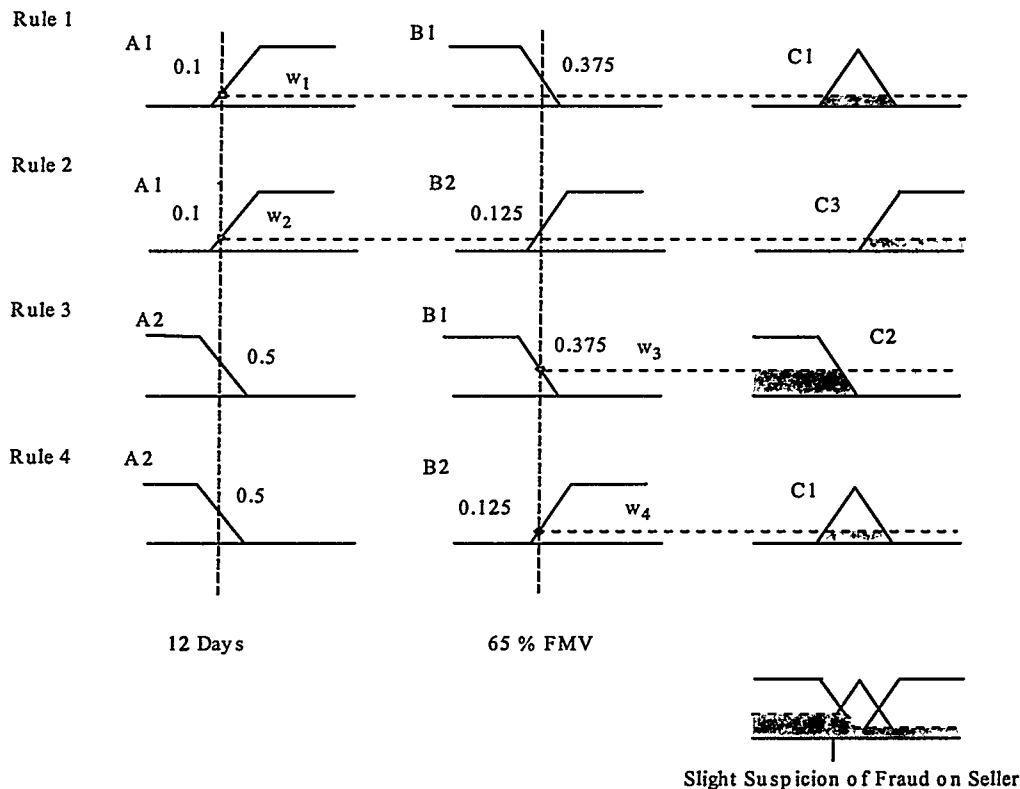

To convert the output to a definite value, a “defuzzification” operation is needed. The “center of gravity” or “centroid averaging” method is used commonly:³⁰⁰

$$z_o = \frac{\int \mu_C(z)zdz}{\int \mu_C(z)dz}$$

In the above example, defuzzification on the suspicion of fraud could yield an output to the degree of fraud suspected on the buyer or the

300. *Id.* at 88.

seller. Of course, other factors may be involved other than the time to sale and the perceived value and such additional inputs could be easily added to the Mamdani direct method model.³⁰¹

2. Fuzzy Cognitive Maps

In a recent article, Rod Taber, a noted expert in the field of fuzzy logic, stated: "A complex society is like a water balloon. Squeeze it here, and the water moves there. Anything that alters one sector will impact another."³⁰² The challenge, therefore, is developing a tool to predict where the water will go *before* the balloon is actually squeezed. This final piece of the puzzle requires us to establish a means by which to symbolize the causal relationships derived from neural networks, a term we will discuss in a moment, and to predict outcomes in a manner easily understood and utilized by the user. Fuzzy cognitive maps ("FCMs") provide such a means.

FCMs are fuzzy graphs which represent causal relationships and enable the user to predict results from extremely complex relationships.³⁰³ By their very nature, FCMs are able to map systems in which both concepts and relationships are fuzzy. Equally important, every FCM is based on a series of mathematical equations, enabling it to be recreated on a computer, greatly simplifying the user's ability to use and modify it.

The primary significance of FCMs lies in their ability to predict the interaction and consequences of multiple complex events. A successful FCM could predict both the short and long term consequences of a judicial decision. Furthermore, unlike typical expert logic trees, which may fail to operate smoothly when joined with one another, combining individual FCMs yields a larger FCM.

Creating a working FCM consists of two steps: (1) concepts and degrees of causality are assigned to a "picture" representing the issue to be mapped by domain experts; and (2) the completed FCM is then transferred into matrix form so that numerical values may be produced via computer to indicate the degrees to which certain concepts affect one another.

301. See sources cited *supra* note 298.

302. Rod Taber, *Fuzzy Cognitive Maps Model Social Systems*, AI EXPERT, July 19, 1994, at 19.

303. Robert Axelrod, a political scientist, first introduced FCMs in the 1970s as a means to graphically represent social science issues. See Bart Kosko, *Fuzzy Cognitive Maps*, 35 INT. J. MAN-MACHINE STUDIES 24, 65 (1986).

The first step in creating an FCM requires singling out the most important "concepts," or topics germane to a particular issue to be utilized in the FCM. Neural nets³⁰⁴ provide such a means. Human experts can provide a means as well. Utilizing these means creates an "expert system"—an attempt to embody the knowledge of a human expert in a computer.³⁰⁵

In the FCM format, concepts are called "nodes." In their simplest form, nodes are fuzzy sets in that they may be activated to some degree from 0% to 100%.³⁰⁶ In the simplest scenario, the nodes are either on or off.³⁰⁷ Unlike most expert systems, which typically employ only one domain expert because of cost considerations, FCMs easily combine multiple experts.³⁰⁸ Thus, in order to minimize the risk of missing crucial concepts and connections, ideally one should use either a neural network or *multiple* domain experts, or even a combination of both. As a rule, each domain expert will create a FCM that differs with regard to concepts and causal strength. The FCMs, however, may be averaged with others into a single FCM, which should reflect areas of agreement and indicate areas of potential conflict.

Nodes are connected to one another by means of numerical values, or "edge weights," which represent "the degrees to which the concepts interact."³⁰⁹ In essence, edge weights are the equivalent of fuzzy rules. They indicate the effect of one concept, or node, on another. Rather than merely indicating the presence of an effect or no effect, edge weights may be represented numerically by any value between 0 and 1, or even -1 and 1.³¹⁰ Thus, nodes may affect one another by degrees, creating a model with fuzzy characteristics.

Two other fuzzy logic experts, Dickerson and Kosko, have used FCMs to create a "virtual world."³¹¹ They defined a virtual world as what changes in a "virtual reality" or "cyberspace."³¹² In a FCM representation of a virtual world, the concept nodes represent events,

304. See *infra* notes 210-232 for a definition and discussion of neural nets.

305. *The Logic That Dares Not Speak Its Name*, *supra* note 4, at 91.

306. See Kosko, *supra* note 303, at 224.

307. See *id.*

308. See Rod Taber, *Knowledge Processing with Fuzzy Cognitive Maps*, 2 EXPERT SYS. WITH APPLICATIONS 83, 85 (1991).

309. *Id.* at 83.

310. See Kosko, *supra* note 303, at 222.

311. Julie A. Dickerson & Bart Kosko, *Virtual Worlds as Fuzzy Dynamical Systems*, in TECHNOLOGY FOR MULTIMEDIA 111-27 (1994).

312. *Id.* at 2.

actions, values, moods, goals, or trends.³¹³ In Dickerson and Kosko's virtual undersea world of dolphins, sharks, and fish, concept nodes model the interactions between predator and prey.³¹⁴ An FCM virtual world acts as a nonlinear dynamical system mapping inputs to output equilibrium states. The output equilibrium states may end in a fixed point, a limit cycle, or an aperiodic or chaotic attractor.³¹⁵

3. Using an FCM to Simulate *Deprizio*

The example that follows develops an FCM virtual world based on the principal question in *Deprizio*: "whether the Trustee may recover from an outside creditor under section 550(a)(1) a transfer more than 90 days before the filing that is avoided under section 547(b) because of a benefit for an inside creditor."³¹⁶ The Augmented *Deprizio* FCM consists of Simple FCMs and Nested FCMs.³¹⁷ Simple FCMs describe the judicial process: the trustee's argument, the creditors' argument, and Judge Easterbrook's reasoning. Nested FCMs describe the degree of risk that the insiders and the creditors bear. Together, these simple FCMs and nested FCMs create a larger augmented FCM that describes the judicial process and the "Real World" of creditor, insider, and firm relationships. The purpose of this section is not to reach a definite conclusion about *Deprizio* but rather to introduce the FCM as a tool for understanding and perhaps predicting how judicial decisions affect business behavior.

The trustee's argument is linear and based on a literal reading of the Bankruptcy Code.³¹⁸ As a simple FCM, eight nodes arranged in four layers can describe the trustee's argument. The first layer contains one node (T1) which simply represents the fact that the trustee has an argument. The second layer consists of facts specific to the case: Guarantor is an officer (T2); Guarantor has a claim (T3); and transfer from Firm to Creditor benefits Creditor (T4). The third layer of the trustee's FCM incorporates Bankruptcy Code provisions to reach intermediate inferences: § 101(30)(B)(ii) transforms node T2 to node T5 (Guarantor is an insider); §§ 101(9) and 101(4)(A) transform

313. *See id.*

314. For example, dolphins swim away as the degree of survival threat increases. *See id.*

315. *See id.* at 3.

316. *Levit v. Ingersoll Rand Fin. Corp. (Deprizio)*, 874 F.2d 1186, 1194 (7th Cir. 1989).

317. *See Dickerson & Kosko, supra* note 311, at 11, 13, 15.

318. As Judge Easterbrook stated, "[t]he trustee's argument for extended recovery from outside creditors flows directly from these interlocked provisions [of the Bankruptcy Code]." *Deprizio*, 874 F.2d at 1190.

node T3 to node T6 (Guarantor is a creditor); and § 547(b)(4) transforms node T4 to T7 (Guarantor's benefit is avoidable). The fourth layer combines the intermediate inferences to reach the final conclusion that the trustee sought: "Lender may have to repay transfers received during the year before filing [for bankruptcy], even though Lender is not an insider."³¹⁹ The trustee's simple FCM is shown in Illustration 6.

Illustration 6

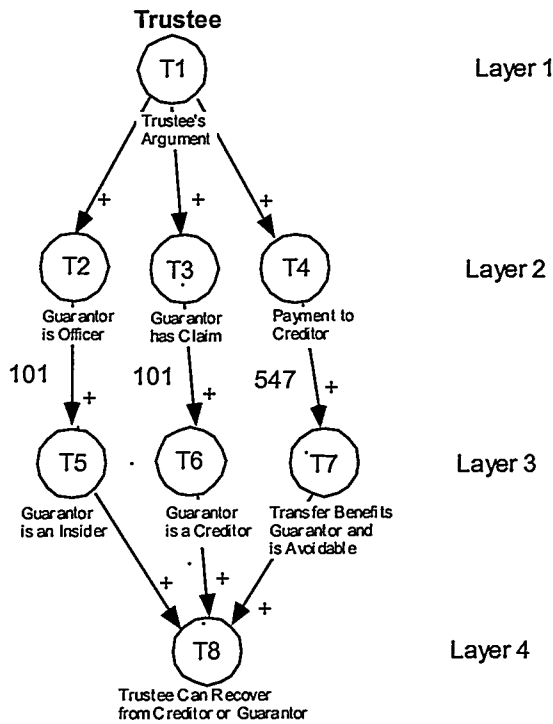

The creditor's argument on the principal question relies on a two-benefit/two-transfer theory.³²⁰ The creditor's FCM, like that of the trustee, has four layers. However, only six nodes are used to model the creditor's argument. The first layer contains one node (C1) which simply represents the fact that the creditor has an argument.

319. *Id.*

320. *See id.* at 1191.

The second layer contains the basic theory: the payment benefits the Lender (C2) and the Guarantor (C3).³²¹ The third layer supposes that a benefit equals a transfer and it uses the Code to determine if the resulting individual transfers are "avoidable." According to § 547(b)(5), a transfer is avoidable only to the extent it gives the creditor more than the creditor would have received in a liquidation under Chapter 7.³²² Using this definition and the fact that the Guarantor's interest is junior to the Lender's, the Creditor's argument produces concept nodes C4 (transfer to Lender is unavoidable) and C5 (transfer to Guarantor is avoidable). Using § 550(a), the Creditor arrives at the fourth layer node C6.³²³ The node C6 represents the proposition that the trustee can recover only from the Guarantor for transfers made less than one year and beyond ninety days from filing.³²⁴ Illustration 7 shows the Creditor's simple FCM.

Illustration 7

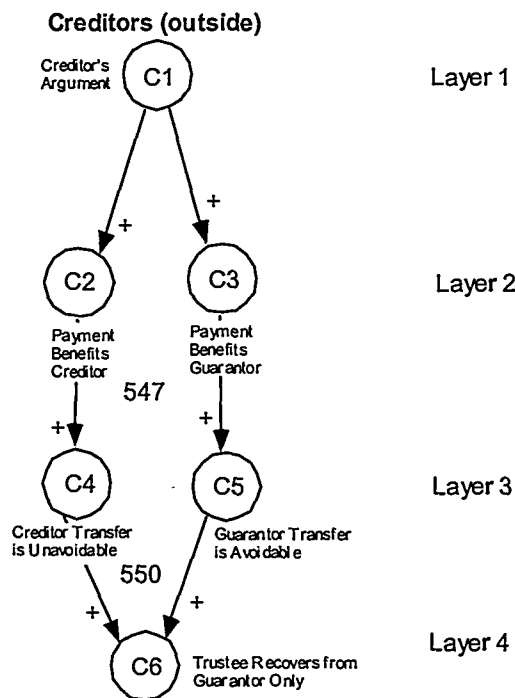

321. *See id.*

322. *See id.* at 1195.

323. *See id.* at 1191; *see also supra* note 56 (defining two-benefit/two-transfer theory).

324. *See Deprizio*, 874 F.2d at 1191.

A three layer simple FCM can likewise model Easterbrook's reasoning on both arguments. Easterbrook approaches the principal question using textualism and economic theory. These are represented in the first layer as nodes E1 (textualism) and E2 (economic theory). The second layer consists of three nodes. Node E3 represents Easterbrook's interpretation of § 101(9): a claim against the firm makes one a creditor.³²⁵ Node E4 represents his textualist reading of §§ 547(b)(1) and 101(50): a payment is a transfer, a benefit is not a transfer.³²⁶ Node E5 contains Easterbrook's notion that the whole of the firm should be preserved.³²⁷ The third layer transforms economic node E5 to node E6 which asserts "all creditors gain from a rule of law that induces each to hold back."³²⁸ Illustration 8 shows Easterbrook's simple FCM.

Illustration 8

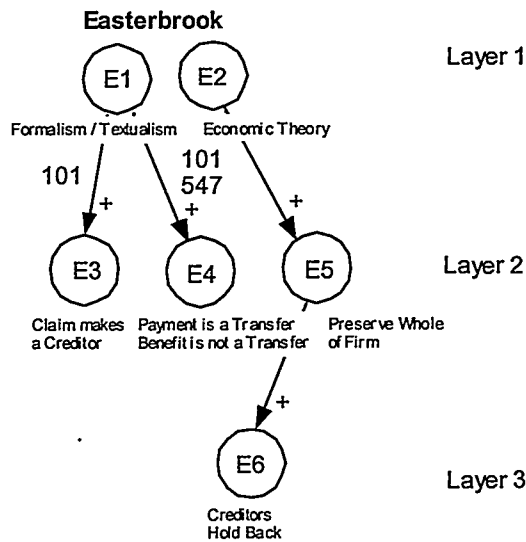

To achieve an augmented FCM representation of the entire case, the three simple FCMs are placed side by side. The next step is

325. *See id.* at 1194.

326. *See id.* at 1195-96.

327. *See id.* at 1194 ("Many a firm is worth more together than in pieces.").

328. *Id.*

to link the FCMs with appropriate edge weights $\{-1,+1\}$. Once linked, the augmented FCM connection matrix can be formed from the individual FCM connection matrices. Converting the FCMs to connection matrix form will become apparent later as it facilitates the programming, or “bookkeeping,” of more complex relationships in larger augmented FCMs. The matrices for our model can be found in Appendix II.

Nested FCMs in the Real World FCM

When a firm borrows money, both the creditor and the firm engage in a transaction that reflects their respective levels of risk. The level of risk depends on many variables, including the prevailing rule of law. *Deprizio* acts to heighten the creditor’s risk level, extending the preference window from 90 to 365 days. The heightened level of risk induces creditors to ask firms to waive claims to their assets in the case of bankruptcy. In turn, the insider who has issued bank guarantees experiences a heightened level of risk.

The insider’s perception of risk will influence the firm’s decisions on borrowing money. On the other hand, if “Barking Dog” prevails, then the creditor’s risk is low and the creditor is unlikely to convince the firm’s insiders to waive their rights to assets.

The creditor risk concept, elaborated as subconcepts of high (N5) and low degrees of risk (N6), when linked to the insider’s waiver of a claim to assets, forms a nested simple FCM. The insider risk concept, also elaborated as subconcepts of high (N1) and low degrees of risk (N2), links to the waiver and the decision for the firm to issue guarantees. The nested FCMs are shown below linked to their common nodes, N3, “Insiders Waive Claim to Firm’s Assets” and N4, “Firm Issues Guarantees.”

Illustration 9

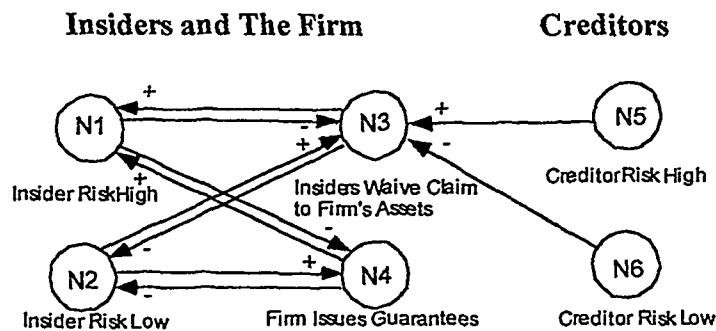

Note that the insider actions affect insider risk. Thus, if the firm issues guarantees or the insiders waive claims to assets, the degree of insider risk rises. Likewise, if these actions do not occur, the degree of insider risk falls.

As shown above, the edge weights are represented as pluses and minuses or $\{-1, +1\}$. However, this need not be the case. Any fuzzy weight can be assigned to the edges, representing the degree to which the risk rises or falls. Fuzzy reasoning models, as presented for the *BFP* case, can be used to determine the weights. In a similar manner, weights can be assigned to the edges affecting the center nodes. Thus, one can investigate the degree to which insiders are willing to issue guarantees or the degree to which the insiders are willing to waive claims to assets. The connection matrix and the mathematical procedure for determining its properties are found in Appendix III.

The simple risk FCM, as with the simple FCMs for the *Deprizio* decision, can also be represented in matrix form. However, to form a more complete model of the real world affected by the *Deprizio* decision, it is helpful to introduce a few more concepts. Preferential transfers to insider-backed creditors lower insider risk levels. The other two important concepts are the rules of law before and immediately after *Deprizio*. Depending on the state of the law, creditor risk either will be high or low and preferential transfers either will occur or will not.

As an augmented FCM, the "Real World" of creditor and firm relations appears in Illustration 10.

Illustration 10

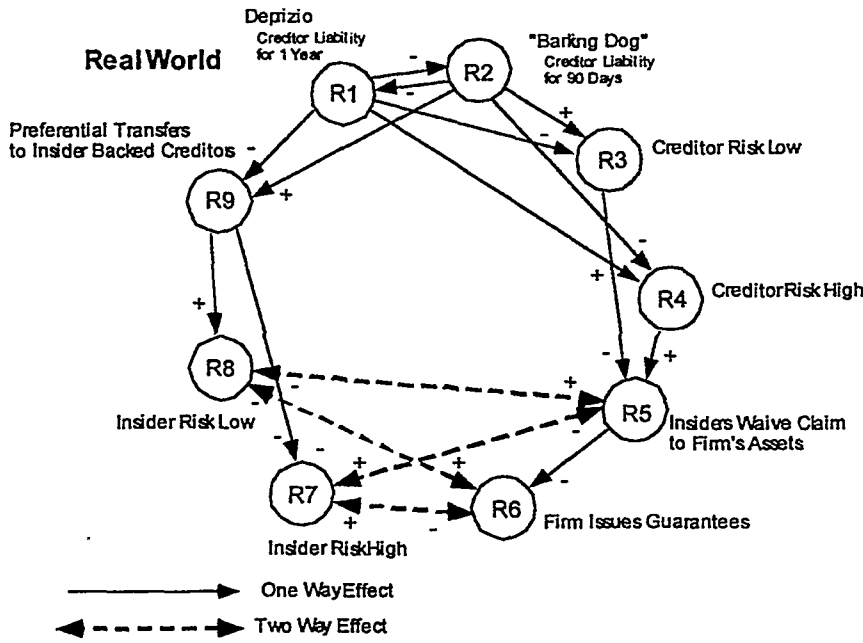

The bridge between the judicial decision FCM and the Real World FCM is traversed by linking nodal concepts in the Trustee's and Creditor's arguments to the Real World. The links are straightforward: T8 → R1, {+1} and C6 → R2, {+1}. However, with Easterbrook's textual and economic theories intervening, only R1 will fire. The corresponding connection matrix for the Real World is shown below complete while the FCM for the judicial decision and the Real World is shown in Illustration 11.

Illustration 11

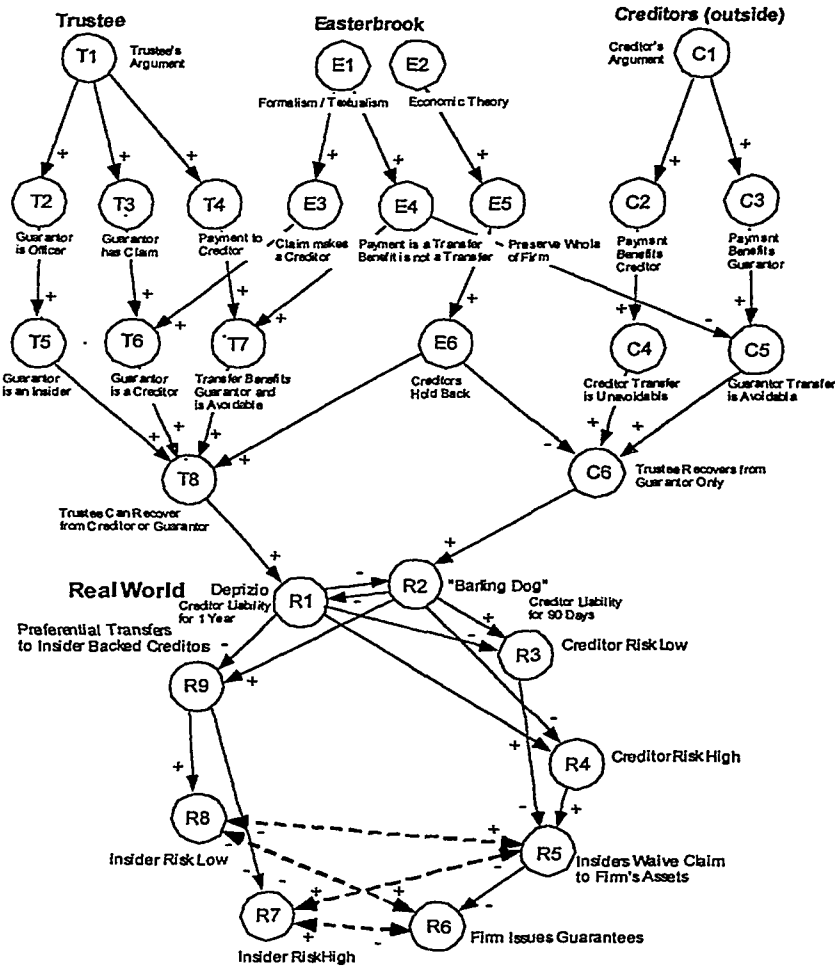

Simulations of the Deprizio FCM and Real World FCM

The complete system, shown in Illustration 11, has been used as the basis for several simulations. The first simulation is for the actual *Deprizio* case and its effect on the Real World. To start, an input vector activates the Trustee's Argument (T1), the Creditor's Argument (C1), and Easterbrook's Textualism (E1) and Economic Theory (E2).

The choice of input vector leads the FCM to a limit cycle.³²⁹ The limit cycle has four steps. It starts with "Creditor Risk is High" (R4), a direct result of the *Deprizio* decision. The high degree of risk experienced by the creditors leads to "Insiders Waive Claim to Assets" (R5) in the second step. In turn, the insiders' behavior increases their degree of risk in the third step, "Insider Risk is High" (R7). In the fourth step, the insiders no longer choose to waive their claim to the firm's assets, although their risk remains high. The return to the first step, the beginning of the limit cycle, occurs next by a moderation of insider risk. In reality, one can imagine that the insiders no longer participate in the credit system. Thus, their degree of risk diminishes. The creditors' risk remains high, however, as long as *Deprizio* is in effect and there is a need to make an acceptable rate of return on their money. At this point, it may be attractive for the insiders to once again participate and to ask again for insiders to waive their claim to the firm's assets. Overall, even as a simple non-adaptive FCM with no time dependent variables, the results are meaningful.

The next simulation examines the effect of the Creditors' Argument unimpeded by the arguments of the Trustees or Easterbrook. The initial input vector is simply "Creditors' Argument" (C1).

The creditors' argument alone produces a different limit cycle.³³⁰ Here, as before, it is a four step limit cycle. The first step is "Creditor Risk is Low" (R3) and "Preferential Transfers to Insider Backed Creditors" (R9). These conditions are a direct result of "Barking Dog."³³¹ In the second step, the behavior of preferential transfers acts to lower the degree of insider risk (R8). In the next step, the low insider risk encourages the firm to start issuing more insider guarantees (R6). The issuance of more insider-backed guarantees, however, acts to increase the degree of insider risk. In this last step, insider risk is not "high," but it is to a sufficient degree not "low."

As with the previous simulation, the results are instructive. Time dependence and variable edge weights could be used to improve the FCM. With variable edge weights, it may be possible to track changes in the degree of insider risk and to predict at which degree their behavior will trigger the firm to issue guarantees.

The next simulation looks at a change in law from "Barking Dog" to *Deprizio*. In this situation, the system adjusts to the *Deprizio*

329. For a list of the input vectors and corresponding codes, see *infra* Appendix IV, Part I.

330. For a list of the input vectors and corresponding codes, see *infra* Appendix IV, Part II.

331. See *supra* note 242.

Limit Cycle in just two iterations.³³² The third input vector is Step III of the *Deprizio* Limit Cycle. The second input vector shows that the firm is still issuing guarantees even though the law has changed and preferential transfers have stopped. As shown in the previous examples, the increase in degree of creditor risk leads to insider waivers and an increase in the degree of insider risk as well.

These three simulations show some of the benefits of virtual world FCM modeling. The three examples are to a large extent focused on the "Real World" FCM. However, the main focus is indeed the "Real World" and how the prevailing law influences the creditor system. Next, it is instructive to take a closer look at the judicial decision FCM to see how a change in Easterbrook's reasoning may influence the "Real World" outcome.

Two different input vectors are examined: Easterbrook Without Textualism and Easterbrook Without Economic Theory.

Easterbrook Without Textualism

First Input Vector:

Trustee's Argument (T1)
Easterbrook's Economics (E2)
Creditor's Argument (C1)

Second Input Vector:

Guarantor is an Officer (T2)
Guarantor has a Claim (T3)
Payment made to Creditor (T4)
Preserve Whole of Firm (E5)
Payment Benefits Creditor (C2)
Payment Benefits Guarantor (C3)

Third Input Vector:

Guarantor is an Insider (T5)
Guarantor is a Creditor (T6)
Avoidable Transfer Benefits Guarantor (T7)
Creditor Hold Back (E6)
Creditor Transfer is not Avoidable (C4)
Guarantor Transfer is Avoidable (C5)

Fourth Input Vector:

Trustee can Recover from Creditor or Guarantor (T8)

332. For a list of the input vectors and corresponding codes, see *infra* Appendix IV, Part III.

Trustee Recovers from Guarantor Only (C6)

Fifth Input Vector:

Deprizio (R1)

Barking Dog (R2)

As can be seen by the results, both arguments go forth when Easterbrook does not use his textualist approach. The "Real World" FCM is impeded since *Deprizio* (R1) and Barking Dog (R2) cancel each other; in other words, they are mutually exclusive. Thus, the FCM predicts that Easterbrook could have not decided the case based on his economic theory alone.

Easterbrook Without Economic Theory

First Input Vector:

Trustee's Argument (T1)

Easterbrook's Textualism (E1)

Creditor's Argument (C1)

Second Input Vector:

Guarantor is an Officer (T2)

Guarantor has a Claim (T3)

Payment made to Creditor (T4)

Claim makes a Creditor (E3)

Payment = Transfer, Benefit \neq Transfer (E4)

Payment Benefits Creditor (C2)

Payment Benefits Guarantor (C3)

Third Input Vector:

Guarantor is an Insider (T5)

Guarantor is a Creditor (T6)

Avoidable Transfer Benefits Guarantor (T7)

Creditor Transfer is not Avoidable (C4)

Fourth Input Vector:

Trustee can Recover from Creditor or Guarantor (T8)

Trustee Recovers from Guarantor Only (C6)

Fifth Input Vector:

Deprizio (R1)

Barking Dog (R2)

As with the previous example's results, both arguments go forth when Easterbrook does not use his economic theory. Again, the "Real World" FCM is impeded since *Deprizio* (R1) and Barking Dog (R2) cancel each other. Thus, the FCM predicts that Easterbrook could have not decided the case based on his textualism alone.

In conclusion, Easterbrook has taken two theories, both weak, and juxtaposed them to arrive at a decision—a decision that could not have been arrived at by the use of formalism alone. Easterbrook could only have reached the decision through the use of a "balancing" of economic theory with textualism—something that looks strikingly similar to practical reasoning. The virtual world FCM shows that either theory by itself is insufficient to reproduce Easterbrook's *Deprizio* decision. Our virtual world FCM does, however, lack time dependency and adaptive weights. To improve upon this example, fuzzy reasoning models may be introduced to modify weights and time dependency to mimic dynamic economic realities. For instance, the length of time that a firm "sits out" may be related to the degree of risk and the rate at which the risk dissipates due to market conditions. The basic principles behind such an adaptive approach follow.

4. Adaptive Fuzzy Systems and Neural Networks

A discussion of fuzzy logic and fuzzy cognitive maps would not be complete without a brief overview of adaptive fuzzy systems and neural nets, including their structure and uses. Perhaps the single most important step in achieving an efficient fuzzy system is developing the appropriate fuzzy rules. Unfortunately, this is often the most difficult process. Indeed, one commentator has stated, "[t]he Achilles' heel of a fuzzy system is its rules."³³³ It may well be that the system to be modeled is so complex that the concepts and relationships underlying the fuzzy rules are not easily discovered. Earlier, this section of the Article suggested that "domain experts" could be used to develop fuzzy rules, but in many cases this may prove too difficult. As an alternative, engineers have developed "adaptive fuzzy systems" that utilize "neural networks" to actually formulate and modify the fuzzy rules.

333. Kosko & Isaka, *supra* note 5, at 80.

An adaptive fuzzy system is a fuzzy system which learns its rules from data using a neural net, rather than a human expert.³³⁴ Data (input) is fed into a computerized neural net which then produces the desired result (output). Adaptive fuzzy systems take the inputs and outputs and express the relationship between the two as fuzzy rules. In this way, the requisite fuzzy rules used to run the system are developed. In a sense, the neural net supplants the human expert. The adaptive fuzzy system is then run using these newly created rules. Significantly, as data changes, so too do the rules. Initially, the fuzzy rules may be very general, but with additional expert information, the rules become more precise.³³⁵

Neural networks can replace human experts, sometimes very effectively. In a general sense, neural networks resemble the human brain, primarily because neural nets are capable of "learning" through experience. Neural nets operate by recognizing patterns in data and associating the patterns. These associations then become the fuzzy rules in an adaptive fuzzy system. Arguably more astute than their human counterparts, neural nets can recognize hidden patterns within vast amounts of information.³³⁶ This is particularly helpful when devising rules for an extremely complex system such as a particularly intricate area of the law.

Neural networks are able to perform complex data association because of their unique structure. A neural network is a collection of "neurons" and "synapses" that change their values in response to inputs from surrounding neurons and synapses.³³⁷ Inputs are mapped to outputs. Neurons add up all incoming signals from other neurons and then produce a value in response.³³⁸ Signals travel via the synapses, which have numerical values that weight the flow of neuronal signals.³³⁹ Neural nets "learn" by increasing the strength of the synapses. Supervised neural nets can "learn" with the assistance of an expert human. The expert can act to correct the net until it responds

334. See Kosko, *supra* note 303, at 287.

335. In 1989, Dr. Bart Kosko developed a fuzzy system that simulated backing a truck and trailer up to a loading dock. He began by using a neural net to ascertain the fuzzy rules. He did this by feeding in hundreds of truck paths. The system developed 105 fuzzy rules to efficiently back the trailer up. As more information was introduced, the rules became more precise. See Kosko, *supra* note 303, at 204-05.

336. Chase Manhattan Bank utilized a neural network to assist in reducing costs resulting from stolen credit cards. Information was introduced into the net and it discovered, among other things, that the most questionable sales were for women's shoes priced between \$40 and \$80. See MCNEILL & FREIBERGER, *supra* note 8, at 229.

337. Kosko & Isaka, *supra* note 5, at 80.

338. See *id.*

339. See *id.*

correctly to every input. Significantly, supervised neural nets can be used to "tune" imprecise fuzzy rules initially devised by human experts. As vast amounts of data are run through the neural net, the rules are refined by allowing the net to vary the fuzzy sets slightly in order to determine the best possible result.

5. Fuzzy Formalism

What does all of this talk of neural nets, FCMs, and so forth, have to do with judges? Ironically, its relevance is probably clearest for formalist judges. The critical point about formalism is that the judge has a finite, pre-defined set of factors that are relevant to the decision. This set probably includes dictionary meaning, linguistic canons, plain statement rules, and *stare decisis*. This Article discussed earlier how experts learn to decode a confused factual situation into a manageable set of familiar factors. Fuzzy logic shows how they can learn to combine these factors into a decision in a workable way. Like neural nets, formalist judges need not learn an explicit set of second-order rules in order to move from their identification of the case's relevant features to a decision about the outcome. They can learn over time how to weigh the factors they consider relevant in order to reach a decision. This analysis reveals how, at the heart of formalism, lies recourse to a process much like what antiformalists call practical reasoning.

While formalism is inherently fuzzy, antiformalist legal analysis is inevitably structured. Clearly, pragmatists believe that they are advocating something more substantial than the use of raw intuition.³⁴⁰ Judge Richard Posner, for example, provides an extensive list of cognitive techniques, including analogy, induction, pattern recognition, tacit knowledge, and reliance on social experience.³⁴¹ Anthony Kronman rejects intuitionism more explicitly. He admits that if good judgment requires more than deduction, it is "tempting to conclude" that good judgment instead must consist of intuition.³⁴² In short,

340. See Phillip P. Frickey, *Congressional Intent, Practical Reasoning, and the Dynamic Nature of Federal Indian Law*, 78 CAL. L. REV. 1137, 1218-19 (1990) (discussing interpretive theories).

341. See POSNER, *supra* note 258, at 86, 91, 105, 108-12.

342. Anthony T. Kronman, *Living in the Law*, 54 U. CHI. L. REV. 835, 848 (1987). Kronman notes that someone who has good judgment "is not someone who from time to time merely makes certain strikingly appropriate oracular pronouncements—that is what prophets and seers do—but who is able, as well, to provide a compelling framework of ideas for the decisions he or she arrives at." *Id.* at 849. These decisions are "not deducible by reason alone, but neither

Kronman says, good judgment “has an argumentative dimension which its equation with intuitive genius obscures.”³⁴³

Moreover, cognitive psychology and fuzzy logic both cast doubt upon the very concept of a purely ad hoc intuitive judgment. Experts develop the capacity to identify recurrent patterns—so that they later “intuitively” classify and interpret data in ways that are not obvious to the novice. It is the novice whose decisions are most ad hoc, because he lacks the experience needed to spot pattern formation. What Llewellyn called “situation sense,”³⁴⁴ and others have derided as nothing more than formless intuition, seems to be the characteristic response of the human mind to repeated problem-solving efforts. Moreover, fuzzy logic shows that what lawyers call “balancing,” and often attack as essentially arbitrary, is in principle reducible to understandable (though non-binary) rules. Even a neural net, which obviously does not actually understand any rules or perceive any patterns, behaves as if it were learning these concepts. It is at least plausible to speculate that even when humans think they are being ad hoc, they are responding, as neural nets do, on the basis of learned patterns and fuzzy rules.

In any event, it is highly doubtful that any antiformalist has ever advocated abolishing all rules, doing away with all precedents, and ignoring statutory language. In reality, there is a great deal of common ground between formalists and antiformalists, which is obscured by the heat of the debate between them. First, formalists, as much as antiformalists, cannot possibly expect to reduce all of legal reasoning to crisp bright-line rules. As we have seen, even if a complete body of such rules could be stated, the formalist would still need to resort to fuzzy logic and practical reasoning in order to apply the rules. Second, formalists and antiformalists alike believe in the usefulness of legal predictability, stability, and, therefore, rules for making decisions.

The debate is really about a matter of degree.³⁴⁵ On the one hand, formalists believe that the legal landscape should be covered as much as possible with a detailed network of explicit rules, in the hope that difficult cases requiring expert judgment can be reduced to the

is their soundness entirely self-evident—something we either see or not depending on our own powers of intuitive comprehension.” *Id.* at 849-50.

343. *Id.* at 850.

344. LLEWELLYN, *supra* note 244, at 403.

345. Consequently, the choice of interpretive methods turns in significant part on empirical questions regarding the behavior of judges and legislators. See generally Cass R. Sunstein, *Formalism and Statutory Interpretation: Must Formalism Be Defended Empirically?*, 66 U. CHI. L. REV. 636 (1999).

minimum. On the other hand, antiformalists are not upset at the idea of large gaps, wherein implicit fuzzy judgments replace explicit rules. This difference in emphasis is not insignificant, but it should not obscure the very real areas of agreement.

Much of the debate over formalism is really a debate about the usefulness of explicit rules versus implicit knowledge. It is tempting to say that one should try to make all rules as explicit as possible, in order to maximize the stability, predictability, and democratic accountability of the legal system. In reality, explicitness is like other human goods: it is valuable, but costly to produce and suffers from diminishing returns.

Demands that the legislature make *all* legal rules explicit rather than relying on the audience to apply implicit rules greatly increase the cost of producing legislation. Indeed, artificial intelligence researchers have found it incredibly difficult to reduce even routine human activities to explicit rules. One of the advantages of fuzzy logic and neural nets is that they model behavior through trial and error without requiring the researcher to work out a set of explicit rules in advance.

On the benefit side, explicit rules also have their limits. Even experts do much of their work without the benefit of explicit rules. Sometimes, an implicit rule may be a much more understandable and predictable guide to behavior than the equivalent set of explicit rules. Consider the directive to drive carefully. Perhaps, with work, one could translate this into a set of explicit rules that state the correct driving action in almost every imaginable scenario (taking into account the speeds and location of all vehicles, the layout of the roadway, weather conditions, etc.). Would the ordinary driver be better served by a multi-volume treatise on driving, or by the directive to "drive carefully, especially when traffic is heavy or the weather is bad"? This directive is very general, but specific enough to remind the audience to employ a huge set of implicit rules they have already mastered. Trying to make the rules explicit would simply cause intolerable confusion. On the other hand, "just do it" is probably a little too open-ended. Thus, the optimum amount of explicitness is a matter of degree, like most of life.³⁴⁶

346. See RICHARD A. POSNER, *ECONOMIC ANALYSIS OF THE LAW* 542-47 (4th ed. 1992).

III. INTERPRETING COMPLEX STATUTES IN A FUZZY WORLD

Much of the scholarship on statutory interpretation focuses on broad theoretical issues, uses only thumbnail sketches of what are actually complicated cases, and ignores the full complexity of most modern statutes. Part of this Article's purpose is to paint a fuller picture of the process of interpretation as it actually takes place in the today's world. Part I examined two well-known bankruptcy cases in great detail. Part II put to the side the debate between formalists and antiformalists, and instead tried to shed light on the kinds of reasoning processes judges must employ regardless of their jurisprudential orientation if they are to do their jobs well. Part II also used cognitive psychology and fuzzy logic to shed light on these cognitive skills. Part III now will consider some of the general lessons of that literature for the question of the circumstances under which judges are likely to perform well at the task of interpreting complex statutes. In particular, this Part will consider whether the appellate courts in *Deprizio* and *BFP* could have improved their performances.

A. Deferring to "Front-line" Interpreters

In Part II, we saw that various kinds of implicit knowledge are critical to forming expert judgments. One type of knowledge is involved in pattern recognition—the knowledge that enables the expert radiologist to interpret what to the novice is only a blurry shadow. Research shows that this type of knowledge is mostly the product of extensive experience.³⁴⁷ Recall that becoming a chess master takes ten or twenty thousand hours of study and playing experience. A novice player, no matter how gifted, lacks the benefit of this experience. The rules of the Bankruptcy Code are much longer and more complex than those of chess. A full-time bankruptcy judge, in the course of several years, spends as much time working with the Code, case law, and procedural rules as a chess master spends on chess. Correspondingly, the specialist judge is expected to have the same advantage over the generalist appellate judge in the "game" of bankruptcy law as the experienced chess master has over the gifted novice. While it is true that some legal skills can be generalized across fields, applying a statute as complicated as the Bankruptcy Code in any particular case involves grasping the interactions of numerous statutory provisions, legal doctrines, and business practices.

347. See *supra* notes 270-73 and accompanying text.

As in chess, mastery of bankruptcy law also involves an appreciation of how the other player (business firms and bankruptcy lawyers) will respond to a given move. Because of the complexity of the Code and the related business and state law issues, this requires developing the equivalent of an extensive FCM showing the interactions involved. Even in the brightest individual, such a complex FCM is likely to develop only after extensive exposure.

Deprizio is a good example of this complexity. Judge Easterbrook makes a formidable effort to examine the interrelationships between the relevant code provisions and to consider the potential responses to his proposed rule. Even so, it is doubtful that he fully appreciated the scope of the complexities. His assessment of the situation emphasized some features while ignoring others.³⁴⁸

As a general matter, federal appellate judges presumably have better credentials, wider legal horizons, and more sophisticated jurisprudential understandings than bankruptcy judges. Thus, their explicit knowledge of law and legal theory is probably stronger, and it is tempting for them to think of bankruptcy judges as merely more limited or less talented versions of themselves. In reality, however, bankruptcy judges accumulate a wealth of implicit knowledge that the generalist judge cannot duplicate. Consequently, appellate judges should defer to the expert judgment of bankruptcy judges to a higher degree than they do today.³⁴⁹

Such deference could take two forms. First, where there is a strong consensus among bankruptcy judges regarding the correct solution to a problem, appellate judges should be reluctant to adopt a different answer except for compelling reasons. Roughly speaking, appellate judges should regard such a strong consensus roughly the way they regard a precedent from their own court. An exception should be recognized where a bankruptcy issue involves policies external to creditor-debtor relations, such as regulatory statutes or labor law. Those policies are likely to fall outside the scope of the bankruptcy judge's expertise.

Congress has already recognized the value of deferring to the expert judgment of bankruptcy judges. The Bankruptcy Reform Act of 1978³⁵⁰ gave the judicial councils of each circuit the discretion to create a bankruptcy appellate panel of three bankruptcy judges to

348. See *supra* Part I.B.1.

349. Thus, judges are in a position similar to that of the "sub domain expert" in Weinstein's study. See Weinstein, *supra* note 259, at 40-42.

350. 11 U.S.C. § 101 *et seq.* (1994).

hear certain appeals in bankruptcy cases.³⁵¹ Congress strengthened the policy in favor of such appellate panels by making them virtually mandatory in the Bankruptcy Reform Act of 1994.³⁵²

Second, even where the bankruptcy judges do not agree on a solution, they may at least agree on the parameters of the problem. For example, they may agree that a problem involves a conflict between the literal meaning of a section and the broad policies of the Code, but disagree about how to resolve the conflict. In this situation, appellate judges cannot defer to a nonexistent consensus. They can, however, defer to the way that the bankruptcy judges have framed the problem, and refrain from the temptation to cleverly mobilize novel attacks on the problem. The odds are all too high that the novel methods either will not work, or will produce subtle and unexpected side-effects, causing more problems than they solve.

B. *Living with Ambiguity*

According to fuzzy logic, most questions do not have black or white answers; the world mostly consists of shades of gray. One flaw in both *Deprizio* and *BFP* is that the judges are convinced that their answer, and only their answer, is the complete truth. Yet, neither case would have been so controversial if the answer had indeed been so clear.

Justice Scalia's opinion in *BFP*, for example, reflects utter confidence that any other analysis of the case would be intellectually bankrupt.³⁵³ Yet Justice Souter does a formidable job of analyzing the same legal materials, using the same formalist methods, to demonstrate the opposite conclusion.³⁵⁴

The fact is that *BFP* was not an easy case. For the reasons explained by Justice Souter, the statutory text taken as a whole seemed to strongly favor the debtor.³⁵⁵ The creditors had two powerful arguments. First, Congress had not very clearly manifested any reason for federal oversight over the traditional state domain of real estate foreclosures.³⁵⁶ Second, Congress clearly did not mean to establish a standard of fair market value, which is the only obvious alter-

351. See 1 COLLIER ON BANKRUPTCY ¶ 5.02[3] (1998).

352. See *id.*; 28 U.S.C. § 158(b) (1994).

353. See discussion *supra* Part I.C.

354. *Id.*

355. *BFP v. Resolution Trust Corp.*, 511 U.S. 531, 549-70 (1994) (Souter, J., dissenting).

356. See *id.* at 564-66.

native to the result of the state foreclosure sale.³⁵⁷ Neither the majority nor the dissent were willing to confront the difficulties—each simply assumed away the other side of the case. In particular, Justice Scalia strove mightily to avoid acknowledging the powerful textual arguments against his position, in the process compromising the integrity of his own textualist philosophy.

A fuller analysis of *BFP* would require a careful consideration of the specific textual provisions at issue. It would also benefit from an analysis of the kind Judge Easterbrook attempted in *Deprizio* of how the general policies of the Bankruptcy Code would be impacted by allowing exceptional treatment for foreclosure proceedings.³⁵⁸ On the other hand, it would also be necessary to give careful attention to the state policies involved and the extent to which they would be disrupted, and to the problem of providing a usable alternative measuring stick for equivalent value. Quite likely, all of these factors would not point in the same direction, and the result would turn on the weight given each factor in the FCM. At least, however, the result would have been a judicial opinion that gave lawyers and judges some guidance about how to approach similar problems in the future. In contrast, the hodgepodge of arguments that the majority dished up in *BFP* promise very little assistance in resolving future bankruptcy problems.

If, as the literature in cognitive psychology suggests, expertise is partly learned from working through specific problems, one function of an appellate opinion should be to serve as a demonstration of successful problem-solving methodologies. *BFP*, unfortunately, has limited value for that purpose.

C. Statutory Cultures

Formalist writers stress that law contains a good many rules, and that in many contexts, the application of those rules requires little more than a grasp of English usage. They recommend a heavier reliance on plain meaning in statutory interpretation for several reasons. First, it would improve democratic legitimacy, since most legislators vote on the language of a bill and “that language is often ordinary language.”³⁵⁹ Second, it would encourage careful drafting

357. *See id.* at 550.

358. *See supra* Part I.B.

359. Robert S. Summers, *Judge Richard Posner's Jurisprudence*, 89 MICH. L. REV. 1302, 1320 (1991) (book review).

and would avoid the need for judges to make complex legislative judgments for which they are ill-suited. More importantly, "judicial adherence to the ordinary meaning of ordinary words in the statute restricts the opportunity for strong-willed judges to substitute their own personal political views for those of the legislature with respect to ends and means."³⁶⁰ Finally, adherence to ordinary meaning provides fairer notice to the public.³⁶¹ In short, these are the virtues of the democratic rule of law.³⁶²

This argument may apply to garden-variety criminal laws, but not to the complex federal statutes that often face federal courts. Most important, federal statutes today are not addressed to the ordinary citizen. Rather, they are addressed to more specialized audiences—sometimes federal agencies (directions to engage in rulemaking), legal specialists (corporate tax revisions), or particular industries (public utility regulation). Less sophisticated individuals often rely on official compliance guides or experts' publications to understand the statute, rather than deciphering the statutory language themselves. The more sophisticated audience approaches the statutes with a rich contextual understanding of previous law, the politics of the enactment, the affected business activity, and the dynamics of legal implementation in the area. If the official interpreters of the statute downplay these factors in favor of dictionary meaning, the most knowledgeable readers of the statute must artificially attempt to put aside their sophistication and seek to understand how a willfully ignorant outsider would read the statute. As with the drafter of the statute, the need to perform these mental gymnastics will make it more difficult for the experts to understand the meaning of the statute.

360. *Id.*

361. *See id.* at 1321.

362. Frederick Schauer, *Statutory Construction and the Coordinating Function of Plain Meaning*, 1990 SUP. CT. REV. 231, 232. Schauer also argues that the Supreme Court has increasingly adopted ordinary language because it allows judges who do not share substantive values to decide cases easily and quickly. *See id.* This assertion seems empirically questionable. If ordinary language were adopted in order to economize on disputes between judges with varying values, it should have been adopted around 1975-1980, when the Court had the greatest range of ideological positions. In the 1989 term, which is Schauer's subject, only a few liberals were left on the Court, so that overall the Court was much more ideologically homogeneous. It is also unclear whether the plain meaning approach actually does create consensus. Consider, for example, *Regan v. Wald*, 468 U.S. 222 (1984), in which a bare majority thought that the outcome was dictated by the plain meaning of the statute, *see id.* at 237, while the dissenters found "nothing in the language of the statute" to support the majority's result, *id.* at 256 (Blackmun, J., dissenting). The court of appeals had found "as a matter of common sense and common English" that the statute meant just the opposite of the interpretation adopted by the majority of the justices. *Wald v. Regan*, 708 F.2d 794, 796 (1st Cir. 1983).

In this respect, the Bankruptcy Code is typical of modern complex statutes. As early as the Chandler Act of 1938,³⁶³ which significantly amended the Bankruptcy Act of 1898,³⁶⁴ specialist organizations³⁶⁵ were heavily involved in the drafting of the statute.³⁶⁶

Similarly, the Bankruptcy Reform Act of 1978³⁶⁷ was the product of eight years of testimony, debate, and lobbying in Congress. Congress delegated the initial task of making findings and recommendations concerning bankruptcy reform to a special Commission to Study the Bankruptcy Law of the United States in 1970.³⁶⁸ The Commission filed its report with Congress on July 30, 1973.³⁶⁹ From that time to the Bankruptcy Reform Act's enactment five years later, Congress "constantly sought and received the counsel and advice of the National Conference of Bankruptcy Judges[,] the National Bankruptcy Conference, [and] the Judicial Conference of the United States."³⁷⁰ The National Bankruptcy Conference was also very involved with the Bankruptcy Reform Act of 1994.³⁷¹ By this Act, Congress also established a National Bankruptcy Review Commission to further study the Bankruptcy Code and submit recommendations for improvements.³⁷²

In this process of lawmaking, the meaning that an ordinary uninformed citizen or legislator might attach to the Code or its amendments is virtually irrelevant. The Code was intended primarily for the use of lawyers, most of them specialists, who share many forms of knowledge, both implicit and explicit. The drafters primarily had to be concerned with how this intended audience would understand and respond to the provisions, for the point of the legislation was to shape the behavior of the specialists and of the businesses that they advised. In a sense, all the key players, from drafters, lobbyists,

363. Pub. L. No. 75-696, 52 Stat. 840 (1938).

364. Ch. 541, 30 Stat. 544 (1898).

365. Examples include the National Bankruptcy Conference, the National Association of Referees in Bankruptcy, the Commercial Law League, the National Association of Credit Men, and the American Bar Association.

366. See 1 COLLIER ON BANKRUPTCY ¶ 101[1][a] (1998).

367. Pub. L. No. 95-598, 92 Stat. 2549 (1978).

368. The commission was created by Pub. L. No. 91-354, 84 Stat. 468 (1970).

369. H.R. DOC. NO. 93-137 (1973).

370. 1 COLLIER ON BANKRUPTCY xxiii (1998) (remarks of Hon. M. Caldwell Butler, United States Representative from Virginia).

371. Pub. L. No. 103-394, 108 Stat. 4106 (1994); see generally THE NATIONAL BANKRUPTCY CONFERENCE, REFORMING THE BANKRUPTCY CODE (Lawrence P. King et al. eds., 1994).

372. Bankruptcy Reform Act of 1994 §§ 601 *et seq.*, Pub. L. No. 103-394, 108 Stat. 4106 (1994).

and staff members to bankruptcy lawyers and bankruptcy judges, shared a common specialized culture—an FCM.

The reaction to *Deprizio*, by bankruptcy lawyers, scholars, and ultimately by Congress, is an example of how resistant this culture can be to a violation of its implicit norms. Judge Easterbrook's opinion probably sparked such a strong reaction for two reasons. First, the opinion's combination of textual literalism and economic analysis to the exclusion of all other factors violated the implicit rhetorical norms of the culture—Easterbrook was not only using different weightings, but operating with a different cognitive map. Second, the result in the case was a sharp deviation from settled expectations among most bankruptcy insiders. In short, the opinion suffered from what one professor once referred to as excessive "brilliance."³⁷³

Recently, Bill Eskridge has written more generally about the reasons for judges to respect existing legal and institutional practices when interpreting statutes, except where there is a strong normative reason for disrupting existing practice.³⁷⁴ But the judge who attempts such a rupture must keep in mind the likelihood that he may only succeed in mobilizing the legal system's immune system, neutralizing his effort at change.

The bankruptcy statute, like the typical federal regulatory statute, has two characteristics that make its culture especially resistant to change. The first characteristic is its complexity. That complexity provides opportunities for insiders to restore the status quo, as creditors' lawyers did by using waivers of reimbursement from the debtor corporation to guarantors. The second characteristic involves a distinction from litigation-oriented statutes such as the antitrust laws. The antitrust laws were subject to a successful effort at rupture by Chicago-style economics in the 1970s. Antitrust litigators, however, are probably less specialized than bankruptcy lawyers. Cases are heard by generalist district judges rather than specialized non-Article III judges. Also, much like the regulatory process, bankruptcy involves much intensive and informal interaction rather than merely discrete adversary trials. Only a small percentage of bankruptcy issues ever reach an Article III court, let alone a court of appeals or the Supreme Court. Thus, bankruptcy law, like complex regulatory

373. Daniel A. Farber, *The Case Against Brilliance*, 70 MINN. L. REV. 917 (1986).

374. See Daniel A. Farber, *Statutory Interpretation and the Idea of Progress*, 94 MICH. L. REV. 1546 (1996) (book review of WILLIAM N. ESKRIDGE, JR., *DYNAMIC STATUTORY INTERPRETATION* (1994)).

statutes, is likely to be quite resistant to efforts by a generalist appellate judge to transform the current cognitive map.

IV. CONCLUSION

This Article began by noting that judges tinker with the legal system all the time. In evaluating their tinkering, scholars and others have written extensively about the precise methodology judges employ in such tinkering. Should judges render a decision based merely on the words of the text before them or should they go one step further and attempt to discern the purpose of the legislation at issue? Is it legitimate for judges to consult current social values? On one side of the debate are formalists, who eschew legislative history and current social values while being suspicious of the concept of statutory purpose. On the other side are antiformalists, who would prefer to downplay textual arguments in favor of these other sources of guidance.

This significant debate has been seriously limited in some respects. First, the debaters have focused on the differences between formalism and antiformalism (or "practical reasoning"), ignoring considerable areas of overlap. Second, much of the discussion has involved stylized examples, often in the context of fairly simple statutes, rather than the complexities presented by actual judicial decisions under complicated modern statutory schemes. Third, neither side has a very clear model of the process that judges actually use to make decisions. This Article sought to move beyond the current debate about formalism by focusing on these issues and by providing insights into rules or useable models of judicial decisionmaking. Normally, formalists and antiformalists alike resort to "hand waving" when seeking to describe the judge's cognitive process. This Article has attempted to provide some substance to our description of this process by referring to work by cognitive psychologists on expert judgments, and to an emerging field known as fuzzy logic.

More specifically, Part I of this Article examined two celebrated recent bankruptcy decisions that utilize different varieties of formalism. After examining these cases, Part II showed how cognitive psychology and fuzzy logic illuminate the reasoning processes used by formalist and antiformalist judges alike. To apply even formalist rules, judges need to recognize the aspects of a case that trigger relevant rules. This type of diagnostic process has been the subject of cognitive psychologists' research on expert reasoning. Once the judge has identified the appropriate rules, she may find that they point in

conflicting directions. Fuzzy logic provided us with a model of how to analyze such conflicts. This Article used that model in the context of *Deprizio*, where we demonstrated that even formalist judges are compelled to make and rely on non-formalist judgments or determinations.

Part III considered how these models of judicial decisionmaking might inform efforts to improve statutory interpretation of complex statutes like the Bankruptcy Code. Specifically, expert decisionmaking builds on pattern recognition skills and fuzzy maps, both of which are the result of intensive repeated experience. Consequently, bankruptcy judges are probably in a better position than generalist appellate judges to maneuver among the complexities of the Code and to accommodate the values and interests at stake. Also, because of the complexity of these statutory schemes, and of the corresponding fuzzy cognitive maps, judges would do well to acknowledge that competing considerations are involved in almost every interesting case. The implicit understandings of bankruptcy "insiders," both in the legislative process and in bankruptcy practice and adjudication, are strongly entrenched and difficult to displace. In short, generalist judges should approach bankruptcy issues with a strong degree of deference to the "local culture" of the field.

Of course, the full subtleties of judicial reasoning will undoubtedly always remain beyond the grasp of psychologists, artificial intelligence or fuzzy logic researchers, or experts. But the results in Part II suggest that fuzzy cognitive maps and neural nets may well illuminate key aspects of judicial reasoning. Indeed, even self-described formalist judges, like Judge Easterbrook, must rely on something other than mere formalist principles in practice. In time, perhaps psychologists and legal scholars actually will be able to build fuzzy models of judicial decisionmaking that judges could conceivably employ to predict the likely societal impact of their decisions.

In the meantime, however, cognitive psychology's theory of fuzzy logic shall at least provide an illuminating approach to understanding legal decision-making. In describing how judges make decisions and how those decisions affect society, we are not doomed to a choice between mechanistic rules or raw intuition. We should therefore resist the false dichotomy between formalism and practical reasoning in statutory interpretation.

APPENDIX I

The operation of fuzzy sets is nicely illustrated in the baseball context. Suppose, for example, we are attempting to determine the batting average of a hitter described by baseball pundits as "good." We might sketch a graph, where the x axis represents the range of batting averages, and the y axis represents whether a particular hitter is good. Illustration 1 graphs in this manner the traditional, bivalent view of a good hitter.

Illustration 1

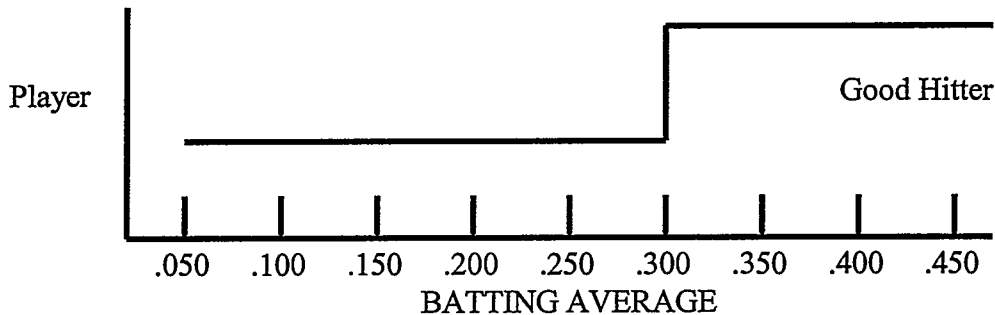
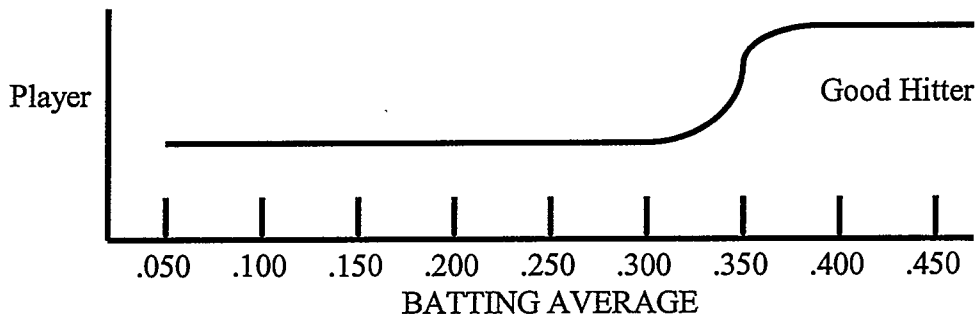

Illustration 2 illustrates the fuzzy view of this same classification problem.

Illustration 2



In Illustration 2, the concept "good" is denoted by a curve of "fit values"—a number between the "bit values" of zero and one—that, for each average, provides the degree of membership in the set of good hitters. Good hitting is a smooth function of average. Every hitter is a good or not-good hitter to some degree. As such, the graph of "not

good” looks like the mirror image of the “good” curve, as seen in Illustration 3.

Illustration 3

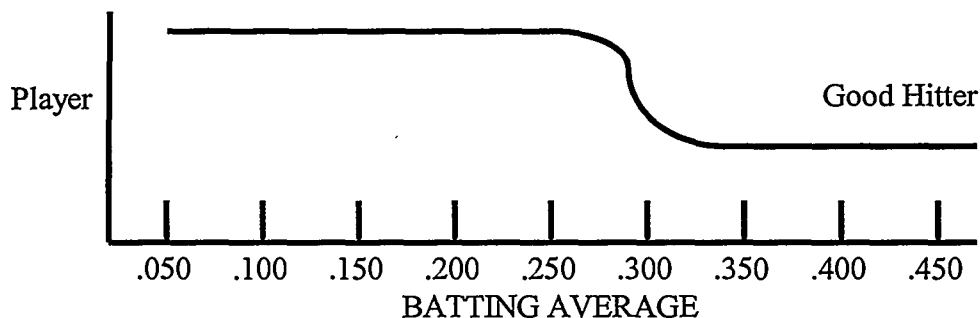

If Illustrations 2 and 3 are placed on top of each other, they intersect at the point where “good” equals “not good,” where fuzziness is most explicit.³⁷⁵

The power of fuzzy sets is evidenced by a comparison with bivalent sets. Bivalent sets are drawn with hard, sharp lines between being a good and a not-good hitter. In bivalent terms, some hitters are good and others are not good, and no one hitter is (at the same time) both. In Illustration 1, we segregate good and not good hitters at a single point—hitters with an average of .300 or higher were considered good, and those with an average below .300 were considered not good. Yet this view does not comport well with reality. Whether a hitter is good, “like most properties of the world, is a matter of degree.”³⁷⁶ Unlike straight lines, curves and fuzzy sets show this smooth change from good to not good. Fuzzy sets tie words to curves, recognizing that all hitters are good or not good to some degree. The .280 hitter is good and not good, and probably more good than not.

Multivalent logic turns out to be conducive to operating a complex system. The principles of fuzzy logic are currently being used to run a subway in Sendai, Japan,³⁷⁷ operate washing machines and camcorders,³⁷⁸ and adjust automatic transmissions in GM Saturn

375. For a similar model, see Kosko, *supra* note 303, at 146-55.

376. *Id.* at 147.

377. Fuzzy logic is used to run the subway system in Sendai, Japan. Each train stops within 7 cm of the correct spot on the platform and uses 10% less energy than if run by human operators. See *The Logic That Dares Not Speak Its Name*, *supra* note 4, at 90.

378. Washing machines built in Japan and Korea are using fuzzy logic to automatically adjust washing strategies based on how dirty the clothes and how difficult it is to remove stains.

automobiles³⁷⁹ but how does this happen? Building a fuzzy system requires three steps: (1) choosing the inputs (X) and the outputs (Y) for the system; (2) choosing the fuzzy sets that comprise X and Y; and (3) picking the fuzzy rules that correspond to the fuzzy subsets.³⁸⁰

An explanation of a fuzzy system may be useful at this point.³⁸¹ Suppose one wishes to create a car that can sense vehicles or obstacles and automatically brake to avoid an accident. The first step in creating the fuzzy system requires the system engineer to identify the fuzzy inputs and outputs. In this case, *distance to obstacle* would be the appropriate input (X), while *degree of braking* would be an appropriate output (Y). Thus, by inputting a particular value representing *distance to obstacle*, we should get a corresponding change in *degree of braking*. If X, then Y.

Next, we need to select the fuzzy sets that comprise *distance to obstacle* (X) and *degree of braking* (Y). We could use FAR, DISTANT, MEDIUM, NEAR and VERY CLOSE as fuzzy sets of X. The sets comprising *distance to obstacle* are then graphically represented in Illustration 4.

Illustration 4

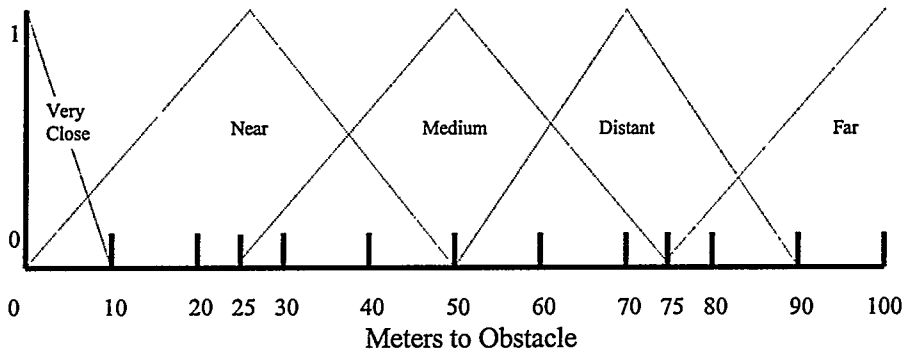

We can then use NO BRAKES, SOFTLY, MEDIUM BRAKE, FIRMLY and HARD as corresponding fuzzy sets for Y. We graphi-

See Kosko & Isaka, *supra* note 5, at 79. This can be achieved by using an optical sensor which measures the murkiness of the wash water. This information is then processed by the controller which estimates how long it will take to clean the clothes. A washing machine might use as few as 10 rules to accomplish this task. Fuzzy logic is also being used to remedy the effects of hand jitters in camcorders. The fuzzy rules anticipate jitters and automatically compensate for them. *See id.*

379. See Long, *supra* note 6, at 104.

380. See Kosko, *supra* note 303, at 161-163.

381. An excellent example of this methodology may be found in Kosko, *supra* note 303, at 161-166.

cally represent the sets comprising *degree of braking* just as we did for *distance to obstacle* in Illustration 5. In our example, we might represent *degrees of braking* by the values 0 to 100.

Illustration 5

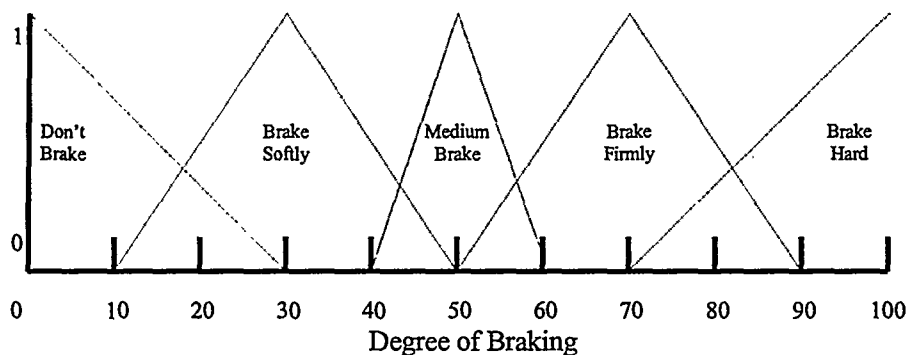

The third step consists of choosing the appropriate fuzzy rules. These rules establish the relationships between the inputs (*distance to obstacle*) and the outputs (*degree of braking*). Thus, if we desire the vehicle to brake hard whenever an obstacle is extremely close, we would create the rule, "If the distance to the obstacle is very close, then brake hard." The following rules would be appropriate for this model:

Illustration 6: Fuzzy Rules

- Rule One:** *If the distance to the obstacle is far, then do not brake.*
Rule Two: *If the distance to the obstacle is distant, then brake softly.*
Rule Three: *If the distance to the obstacle is medium, then brake medium.*
Rule Four: *If the distance to the obstacle is near, then brake firmly.*
Rule Five: *If the distance to the obstacle is very close, then brake hard.*

As seen above in Illustrations 4 and 5, inputs and outputs may be graphically represented, but what about the fuzzy rules which represent the interaction between inputs and outputs? In other words, what does the fuzzy rule "If the distance to the obstacle is far, brake softly" look like? Quite simply, the product of FAR and SOFTLY, or one input triangle multiplied by an output triangle, looks

like a patch.³⁸² Indeed, the products of FAR x DO NOT BRAKE, DISTANT x SOFTLY, MEDIUM DISTANCE x MEDIUM BRAKE, NEAR x FIRMLY and VERY CLOSE x HARD will result in five overlapping patches, as shown in Illustration 7.

Illustration 7: Fuzzy Patches Representing Fuzzy Rules

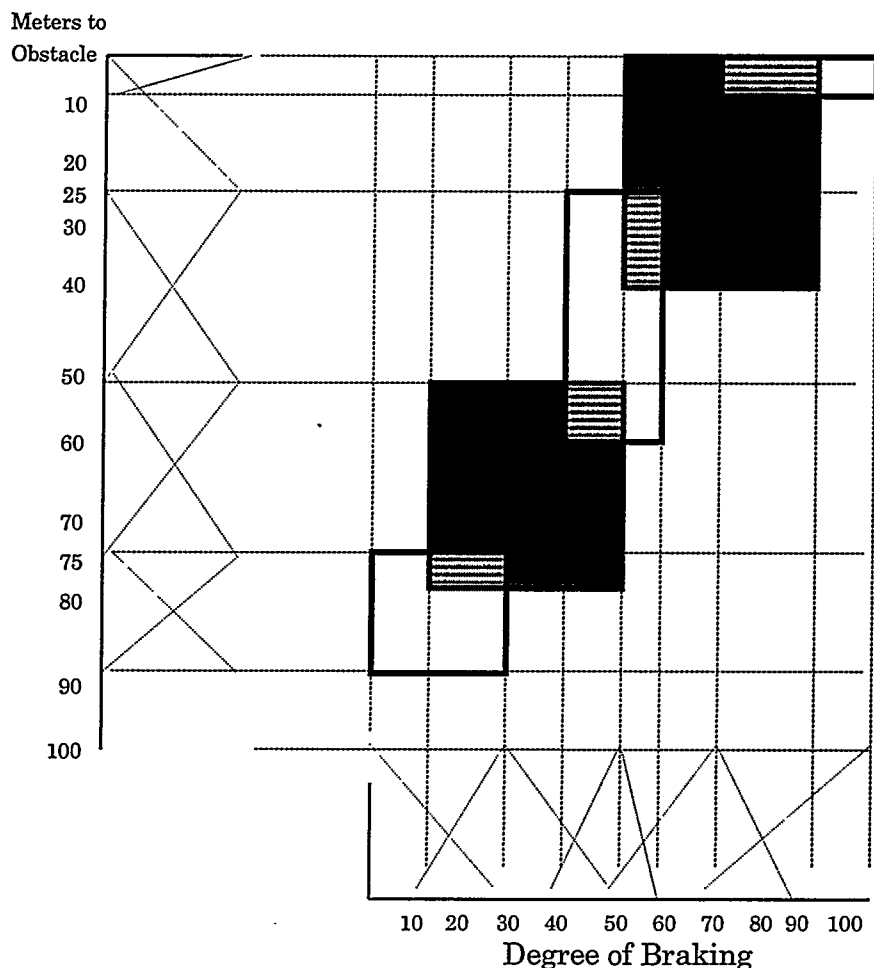

The size of the patch depends necessarily upon the fuzziness of the rule—the more precise the rule, the smaller the patch. General rules create large patches. More specific rules produce smaller patches. In the car braking example, only five rules were used. Indeed, an infinite number of rules could be used and as each rule grew

382. See Kosko, *supra* note 303, at 163-164.

more precise, so too would the corresponding patch. Fuzzy rules become less fuzzy as they become more precise. However, the value of a fuzzy system lies in its inherent ability to utilize fuzzy rules. Otherwise stated, there is no reason to make the rules overly precise—fuzzy systems are designed to use fuzzy rules such as the five above without more. Indeed, it has been argued that creating overly precise rules is counterproductive.³⁸³ The number of rules should be limited and increased only when small changes in input have large and wholesale effects on the output.³⁸⁴ The question, then, is how does the system run when the rules are inherently vague?

Fuzzy systems utilize *associative memory*, which means that all of the fuzzy rules are activated at once, or in *parallel*.³⁸⁵ Thus, when an input (*distance to obstacle*) is introduced into our fuzzy system, all five rules will fire to some degree. “The closer the input matches the if-part of a fuzzy rule, the more the then-part fires.”³⁸⁶ Conversely, the less the input matches the if-part of the fuzzy rule, the less the then-part is triggered. Suppose the input is 50 meters. All five rules trigger to some degree. Once the membership of each output set is calculated (the then-part fuzzy sets), the result is averaged into a single output value. This process is called “defuzzification” or “centroid averaging.”³⁸⁷ Illustration 8 details this process. By this manner, the fuzzy system produces a single value which can then be used by the device, or in our case, the vehicle’s braking system. Fuzzy chips enable this process to occur millions of times per second through *fuzzy logical inferences per second* (FLIPS).³⁸⁸ “Each map from input to output defines one FLIPS.”³⁸⁹ This precision aids the system in avoiding “hinting”—the tendency to overshoot or undershoot based on the lag time between inputs and their resulting outputs.³⁹⁰ Thus, as the vehicle’s distance to the obstacle changes by the second, the braking system can automatically compensate, without any assistance from the driver, based solely on the five rules govern-

383. See *The Logic That Dares Not Speak Its Name*, *supra* note 4, at 91.

384. See *id.*

385. See Kosko, *supra* note 303, at 171.

386. *Id.* at 293.

387. *Id.* at 172.

388. See *id.*

389. *Id.* at 293. The first fuzzy chip was designed by in 1985 and processed 16 rules at a rate of .08 million rules per second. Current technology allows systems to process up to two million rules per second. See Kosko & Isaka, *supra* note 303, at 78.

390. *The Logic That Dares Not Speak Its Name*, *supra* note 4, at 90.

ing it. Bart Kosko calls this entire process *fuzzy associative memory* (FAM).³⁹¹

Illustration 8: FUZZY ASSOCIATIVE MEMORY AT WORK.³⁹²

Rules One through Five

Step 1 If A_1 , then B_1 → B'_1 (DO NOT BRAKE to some degree.)
 If A_2 , then B_2 → B'_2 (BRAKE SOFTLY to some degree.)
 Input $X_1 \rightarrow A \rightarrow$ If A_3 , then $B_3 \rightarrow B'_3$ (BRAKE LESS THAN SOFTLY to some degree.)
 If A_4 , then B_4 → B'_4 (BRAKE FIRMLY to some degree.)
 If A_5 , then B_5 → B'_5 (BRAKE HARD to some degree.)

Step 2 $B'_1 + B'_2 + B'_3 + B'_4 + B'_5 = B$

Step 3 $B \rightarrow$ DEFUZZIFICATION \rightarrow Output "Y₁"

391. See Kosko, *supra* note 303, at 175.

392. A similar representation can be found in Kosko, *supra* note 303, at 175.

APPENDIX II
CONNECTION MATRICES FOR DEPRIZIO

The individual matrices appear below:

<u>Trustee's FCM</u>				<u>Easterbrook's FCM</u>													
		To: T1 T2 T3 T4 T5 T6 T7 T8		To: E1 E2 E3 E4 E5 E6													
From:	T1	0	1	1	1	0	0	0	0	From:	E1	0	0	1	1	0	0
	T2	0	0	0	0	1	0	0	0		E2	0	0	0	0	1	0
	T3	0	0	0	0	0	1	0	0		E3	0	0	0	0	0	0
	T4	0	0	0	0	0	0	1	0		E4	0	0	0	0	0	0
	T5	0	0	0	0	0	0	0	1		E5	0	0	0	0	0	1
	T6	0	0	0	0	0	0	0	1		E6	0	0	0	0	0	0
	T7	0	0	0	0	0	0	0	1								
	T8	0	0	0	0	0	0	0	0								

<u>Creditor's FCM</u>							
To: C1 C2 C3 C4 C5 C6							
From:	C1	0	1	1	0	0	0
	C2	0	0	0	1	0	0
	C3	0	0	0	0	1	0
	C4	0	0	0	0	0	1
	C5	0	0	0	0	0	1
	C6	0	0	0	0	0	0

As an augmented FCM, the matrices must be linked together. To accomplish this task, Easterbrook's nodes E3, E4, and E6, are linked to the Trustee's nodes T6, T7, and T8, respectively, and nodes E4 and E6 are linked to the Creditor's nodes C5 and C6 respectively. Since Easterbrook's textualism and economic theory support the Trustee's arguments, the edge weights are positive: $E3 \rightarrow T6$, $\{+1\}$; $E4 \rightarrow T7$, $\{+1\}$; and $E6 \rightarrow T8$, $\{+1\}$. On the other hand, Easterbrook's textualism and economic theory work against the Creditor's arguments and thus the edge weights are negative: $E3 \rightarrow C5$, $\{-1\}$ and $E6 \rightarrow C6$, $\{-1\}$. These edge weight effects are seen in the full augmented matrix below:

	Trustee							Easterbrook					Creditor						
T r u s t e e	0	1	1	1	0	0	0	0	0	0	0	0	0	0	0	0	0	0	0
	0	0	0	0	1	0	0	0	0	0	0	0	0	0	0	0	0	0	0
	0	0	0	0	0	1	0	0	0	0	0	0	0	0	0	0	0	0	0
	0	0	0	0	0	0	1	0	0	0	0	0	0	0	0	0	0	0	0
	0	0	0	0	0	0	0	1	0	0	0	0	0	0	0	0	0	0	0
	0	0	0	0	0	0	0	0	1	0	0	0	0	0	0	0	0	0	0
	0	0	0	0	0	0	0	0	0	0	0	0	0	0	0	0	0	0	0
E a s t e r b r o o k	0	0	0	0	0	0	0	0	0	1	1	0	0	0	0	0	0	0	0
	0	0	0	0	0	0	0	0	0	0	0	1	0	0	0	0	0	0	0
	0	0	0	0	0	1	0	0	0	0	0	0	0	0	0	0	0	0	0
	0	0	0	0	0	0	1	0	0	0	0	0	0	0	0	0	0	0	-1
	0	0	0	0	0	0	0	0	0	0	0	0	1	0	0	0	0	0	0
	0	0	0	0	0	0	0	1	0	0	0	0	0	0	0	0	0	0	-1
C r e d i t o r	0	0	0	0	0	0	0	0	0	0	0	0	0	0	1	1	0	0	0
	0	0	0	0	0	0	0	0	0	0	0	0	0	0	0	0	1	0	0
	0	0	0	0	0	0	0	0	0	0	0	0	0	0	0	0	0	1	0
	0	0	0	0	0	0	0	0	0	0	0	0	0	0	0	0	0	0	1
	0	0	0	0	0	0	0	0	0	0	0	0	0	0	0	0	0	0	1
	0	0	0	0	0	0	0	0	0	0	0	0	0	0	0	0	0	0	0

Considering the dynamics of this FCM, if the trustee FCM and creditor FCM were allowed to go forth unimpeded, they would both fire and the case would not be resolved. Easterbrook's theories render a linear progression through the individual FCMs. The Creditor's FCM is shut down in the third and fourth layers. Again, an advanced FCM with edge weights different than $\{-1, +1\}$ may yield vastly different results. Here, however, we are only concerned with an introduction to the fuzzy cognitive map as a tool for judicial decision analysis and the present $\{-1, +1\}$ weights suffice.

To create a virtual world FCM of the *Deprizio* judicial decision-making process, the connection matrix is multiplied by an input vector.³⁹³ The input vector represents "active" nodes, e.g., the trustee has an argument. The active nodes trigger subsequent events by either activating or deactivating connected nodes. The output vector contains this information. Thus, behaviors can be determined by examining the output vector. However, to form the next input vector, the output vector needs to be modified. After a brief explanation of the

393. See Dickerson & Kosko, *supra* note 311, at 12, 13.

modification procedure, an example will be given that demonstrates the iterative FCM process.

The input vector needs to be modified where the edge weights add to greater than $\{+1\}$, consider nodes T8 (possibility of $\{+3\}$) and C6 (possibility of $\{+2\}$), or less than $\{0\}$. When these situations occur a binary threshold function adjusts the values to $\{+1\}$ or $\{0\}$. With y as the sum of the edge weights, a sigmoid function,

$$S(y) = \frac{1}{1 + e^{-c(y-T)}}$$

with a large positive value of c , approximates a binary threshold or "step" function.³⁹⁴ Consider the sigmoid function equation when the threshold value, T , is equal to 0.5 and $c = 100$. When y , the sum of the edge weights is greater than $\{+1\}$, take $\{+3\}$ as an example, then

$$S(3) = S(y) = \frac{1}{1 + e^{-100(3-0.5)}} = S(y) = \frac{1}{1 + e^{-250}} \approx 1 \text{ since } e^{-250} \approx 0.$$

On the other hand, when y is $\{-1\}$ or less, take $\{-3\}$ as an example, then

$$S(-3) = S(y) = \frac{1}{1 + e^{-100(-3-0.5)}} = S(y) = \frac{1}{1 + e^{+350}} \approx 0 \text{ since } e^{+350} \rightarrow \infty$$

For the simple FCMs described above, the binary threshold function ensures that each node either does nothing $\{0\}$ or fires with a value of $\{+1\}$. Of course, a more complex threshold function may be modified as desired.

394. *Id.*

APPENDIX III

In connection matrix form, the nested FCM shown in Illustration 9 is as follows:

		To Nodes:					
		N1	N2	N3	N4	N5	N6
<i>F</i> <i>r</i> <i>o</i> <i>m</i> <i>N</i> <i>o</i> <i>d</i> <i>e</i> <i>s</i>	N1	0	0	-1	-1	0	0
	N2	0	0	1	1	0	0
	N3	1	-1	0	0	0	0
	N4	1	-1	0	0	0	0
	N5	0	0	1	0	0	0
	N6	0	0	-1	0	0	0

With weights of $\{-1, +1\}$, the simple FCM for the "Insiders and the Firm" and the "Creditors" settles to different outcomes depending on what actions are triggered. For example, if "Insider Risk is Low" and "Creditor Risk is High" then the following steps occur:

- Step I Insiders Waive Claim to Firm's Assets & The Firm Issues Guarantees
- Step II Insider Risk is High & Insider Risk is NOT Low
- Step III Insiders DO NOT Waive Claim & The Firm DOES NOT Issue Guarantees

The same process can be represented using the above matrix, E , and an input vector I_0 . To start consider the input vector for "Insider Risk is Low" and "Creditor Risk is High,"

$$I_0 = \begin{matrix} & \text{N1} & \text{N2} & \text{N3} & \text{N4} & \text{N5} & \text{N6} \\ \left| \begin{matrix} 0 & 1 & 0 & 0 & 1 & 0 \end{matrix} \right| \end{matrix}$$

To find the output vector, B_0 , multiply I_0 and E . To multiply a row vector and a matrix, the elements of the row vector are multiplied by the column elements of the matrix. For example, the first element of the six element output vector is computed as follows:

$$B_0(1) = [0*0 + 1*0 + 0*1 + 0*1 + 1*0 + 0*0] = 0$$

Continuing this process for elements two through six yields,

$$\begin{array}{cccccc} & N1 & N2 & N3 & N4 & N5 & N6 \\ B_0 = & | & 0 & 0 & 2 & 1 & 0 & 0 & | \end{array}.$$

Going back to the definitions of N3 and N4, we see that at Step I, Insiders Waive Claim to Firm's Assets {+2} and The Firm Issues Guarantees {+1}. The next step applies the binary threshold function to B_0 , which results in the new input vector I_1 , where

$$\begin{array}{cccccc} & N1 & N2 & N3 & N4 & N5 & N6 \\ I_1 = & | & 0 & 0 & 1 & 1 & 0 & 0 & | \end{array}.$$

The new input vector states that N3 and N4 are activated, a result already known from examination of the output vector B_0 . Repeating this procedure using the new input vector I_1 , yields output vector B_1 , where

$$\begin{array}{cccccc} & N1 & N2 & N3 & N4 & N5 & N6 \\ B_1 = & | & 2 & -2 & 0 & 0 & 0 & 0 & | \end{array}.$$

Translating back to the node definitions, the output vector from Step II states that the degree of insider risk is switched to High {+2} and no longer Low {-2}. In essence, this action is a result of nodes N3 and N4. To move onto the next step, we again apply the binary threshold function to arrive at the next input vector I_2 , where

$$\begin{array}{cccccc} & N1 & N2 & N3 & N4 & N5 & N6 \\ I_2 = & | & 1 & 0 & 0 & 0 & 0 & 0 & | \end{array}.$$

As the input vector shows, only N1 is triggered and this will turn off nodes N3 and N4, yielding output vector B_2 where

$$\begin{array}{cccccc} & N1 & N2 & N3 & N4 & N5 & N6 \\ B_2 = & | & 0 & 0 & -1 & -1 & 0 & 0 & | \end{array}.$$

Applying the threshold function yields the next input vector, I_3 , where

$$\begin{array}{cccccc} & N1 & N2 & N3 & N4 & N5 & N6 \\ I_3 = & | & 0 & 0 & 0 & 0 & 0 & 0 & | \end{array}.$$

The FCM has now reached a steady state since I_3 has no non-zero elements. One possible interpretation of this result is that the firms no longer participate in the credit system since their degree of risk is high. However, over time one may expect the degree of risk to diminish as other market forces come into play. This presents a situation that may be better handled by time-variant FCMs.³⁹⁵

		<u>Real World</u>								
To:		R1	R2	R3	R4	R5	R6	R7	R8	R9
	R1	0	-1	-1	1	0	0	0	0	-1
	R2	-1	0	1	-1	0	0	0	0	1
	R3	0	0	0	0	-1	0	0	0	0
	R4	0	0	0	0	1	0	0	0	0
From:	R5	0	0	0	0	0	-1	1	-1	0
	R6	0	0	0	0	0	0	1	-1	0
	R7	0	0	0	0	-1	-1	0	0	0
	R8	0	0	0	0	1	1	0	0	0
	R9	0	0	0	0	0	0	-1	1	0

To complete the entire FCM, this connection matrix is joined with the *Deprizio* judicial decision connection matrix. The resulting matrix (not shown) is 29 rows by 29 columns.

395. See K.S. Park & S.H. Kim, *Fuzzy Cognitive Maps Considering Time Relationships*, 42 INT'L J. HUM.-COMPUTER STUD. 157, 157-68 (1995).

APPENDIX IV

I. First ExampleFirst Input Vector:

Trustee's Argument (T1)
Easterbrook's Textualism (E1)
Easterbrook's Economics (E2)
Creditor's Argument (C1)

Second Input Vector:

Guarantor is an Officer (T2)
Guarantor has a Claim (T3)
Payment made to Creditor (T4)
Claim makes a Creditor (E3)
Payment = Transfer, Benefit is not (E4)
Preserve Whole of Firm (E5)
Payment Benefits Creditor (C2)
Payment Benefits Guarantor (C3)

Third Input Vector:

Guarantor is an Insider (T5)
Guarantor is a Creditor (T6)
Avoidable Transfer Benefits Guarantor (T7)
Creditor Hold Back (E6)
Creditor Transfer is not Avoidable (C4)

Fourth Input Vector:

Trustee can Recover from Creditor or Guarantor (T8)

Fifth Input Vector:

Deprizio (R1)

Sixth Input Vector: Step I of the Limit Cycle

Creditor Risk is High (R4)

Seventh Input Vector: Step II of the Limit Cycle

Creditor Risk is High (R4)
Insiders Waive Claim to Assets (R5)

Eighth Input Vector: Step III of the Limit Cycle

Creditor Risk is High (R4)
Insiders Waive Claim to Assets (R5)
Insider Risk is High (R7)

Ninth Input Vector: Step IV of the Limit Cycle

Creditor Risk is High (R4)
Insider Risk is High (R7)

Tenth Input Vector: Return to Step I of the Limit Cycle

Creditor Risk is High (R4)

II. Second ExampleFirst Input Vector:

Creditors' Argument (C1)

Second Input Vector:

Payment Benefits Creditor (C2)
Payment Benefits Guarantor (C3)

Third Input Vector:

Creditor Transfer is not Avoidable (C4)
Guarantor Transfer is Avoidable (C5)

Fourth Input Vector:

Trustee Recovers from Guarantor Only (C6)

Fifth Input Vector:

Barking Dog (R2)

Sixth Input Vector: Step I of the Limit Cycle

Creditor Risk is Low (R3)
Preferential Transfers to Insider Backed Creditors (R9)

Seventh Input Vector: Step II of the Limit Cycle

Creditor Risk is Low (R3)
Insider Risk is Low (R8)
Preferential Transfers to Insider Backed Creditors (R9)

Eighth Input Vector: Step III of the Limit Cycle

Creditor Risk is Low (R3)
Firm Issues Guarantees (R6)
Insider Risk is Low (R8)
Preferential Transfers to Insider Backed Creditors (R9)

Ninth Input Vector: Step IV of the Limit Cycle

Creditor Risk is Low (R3)
Firm Issues Guarantees (R6)
Preferential Transfers to Insider Backed Creditors (R9)

Tenth Input Vector: Return to Step I of the Limit Cycle

Creditor Risk is Low (R3)
Preferential Transfers to Insider Backed Creditors (R9)

III. Third ExampleFirst Input Vector:

Deprizio (R1)
Creditor Risk is Low (R3)
Firm Issues Guarantees (R6)
Insider Risk is Low (R8)
Preferential Transfers to Insider Backed Creditors (R9)

Second Input Vector:

Creditor Risk is High (R4)
Firm Issues Guarantees (R6)

Third Input Vector: Step III of the Limit Cycle

Creditor Risk is High (R4)
Insiders Waive Claim to Assets (R5)
Insider Risk is High (R7)

Fourth Input Vector: Step IV of the Limit Cycle

Creditor Risk is High (R4)
Insider Risk is High (R7)

Fifth Input Vector: Step I of the Limit Cycle

Creditor Risk is High (R4)

Sixth Input Vector: Step II of the Limit Cycle

Creditor Risk is High (R4)

Insiders Waive Claim to Assets (R5)

Seventh Input Vector: Return to Step III of the Limit Cycle

Creditor Risk is High (R4)

Insiders Waive Claim to Assets (R5)

Insider Risk is High (R7)